

01/08/2024

# Automation 360



# Contents

Release Notes.....	16
Automation 360 Release Notes.....	17
Automation 360 v.31 Release Notes.....	17
Automation 360 v.30 Release Notes.....	43
Automation 360 v.29 Release Notes.....	80
Automation 360 v.28 Release Notes.....	124
Automation 360 v.27 Release Notes.....	182
Automation 360 v.26 Release Notes.....	254
Previous Automation 360 Release Notes.....	297
Community Edition Release Notes.....	749
Automation 360 v.31 Community Edition Release Notes.....	750
Automation 360 v.30 Community Edition Release Notes.....	752
Automation 360 v.29 Community Edition Release Notes.....	756
Automation 360 v.28 Community Edition Release Notes.....	759
Automation 360 v.27 Community Edition Release Notes.....	763
Automation 360 v.26 Community Edition Release Notes.....	770
Previous Community Edition Release Notes.....	776
Sandbox environment.....	833
Package updates overview.....	835
Periodic package updates - summary list.....	836
Periodic package updates - FAQ.....	838
Active Directory package updates.....	840
AI package updates.....	841
Advanced Classifier package updates.....	842
Apigee package updates.....	843
App Integration package updates.....	844
Application package updates.....	846
Boolean package updates.....	847
Bot Migration package updates.....	848
Browser package updates.....	851
Clipboard package updates.....	852
Comment package updates.....	854
Credential package updates.....	855
CSV/TXT package updates.....	856
Data Table package updates.....	858
Database package updates.....	859
Datetime package updates.....	861
Delay package updates.....	862
Dictionary package updates.....	864
DLL package updates.....	865
Document Extraction package updates.....	867
Email package updates.....	873
Email trigger package updates.....	877
Error handler package updates.....	878
Excel advanced package updates.....	879
Excel basic package updates.....	881
File package updates.....	882
Folder package updates.....	884

FTP/SFTP package updates.....	886
Generative AI package updates.....	887
Google Calendar package updates.....	889
Google Drive package updates.....	890
Google Sheets package updates.....	892
Hotkey trigger package updates.....	894
If package updates.....	894
Image Recognition package updates.....	896
Interactive Forms package updates.....	898
Document Classifier package updates.....	899
IQ Bot package updates.....	900
IQ Bot Pre-processor package updates.....	901
JavaScript package updates.....	902
JSON package releases.....	903
Legacy Automation package updates.....	905
List package updates.....	906
Log To File package updates.....	907
Loop package updates.....	908
Message Box package updates.....	910
Microsoft 365 Calendar package updates.....	911
Microsoft 365 Excel package updates.....	913
Microsoft 365 OneDrive package updates.....	915
Microsoft 365 Outlook package updates.....	917
Mouse package updates.....	920
Number package updates.....	921
OCR package updates.....	923
PDF package updates.....	924
PGP package updates.....	925
Ping package updates.....	927
Play Sound package updates.....	928
Printer package updates.....	929
Process Composer package updates.....	930
Prompt package updates.....	931
Python Script package updates.....	932
Record package updates.....	934
Recorder package updates.....	935
Rest Web Services package updates.....	944
Salesforce package updates.....	945
SAP BAPI package updates.....	947
SAP package updates.....	948
Screen package updates.....	949
Service package updates.....	951
ServiceNow package updates.....	952
SharePoint package updates.....	953
Simulate keystrokes package updates.....	955
SNMP package updates.....	957
SOAP Web Services package updates.....	958
String package updates.....	960
System package updates.....	962
Task Bot package updates.....	963
Terminal Emulator package updates.....	964
Text file package updates.....	966
V11 Task Bot package updates.....	968
VBScript package updates.....	969

Wait package updates.....	970
Window package updates.....	971
Workday package updates.....	973
XML package updates.....	974
Previous Package SDK Release Notes.....	975
Process Discovery Release Notes.....	983
Process Discovery version 1.79.0 release notes.....	983
Privacy Enhanced Gateway version 3.3.16 Release Notes.....	984
Discovery Bot release notes.....	985
CoE Manager Release Notes.....	985
Browser extensions for Automation 360.....	985
Browser extensions for web applications.....	987
Previous versions of browser extensions.....	988
Automation 360 feature comparison matrix.....	990
Automation 360 IQ Bot feature comparison matrix.....	1005
Automation 360 IQ Bot version compatibility.....	1010
Automation 360.....	1013
Automation 360 FAQ.....	1018
Automation 360 architecture and resiliency.....	1021
Control Room overview.....	1026
Distributed architecture.....	1027
Security architecture.....	1029
General Data Protection Regulation compliance.....	1054
Automation 360 Cloud for secure access and connectivity.....	1054
Automation 360 Cloud FAQ.....	1058
Automation 360 Cloud Service Status site.....	1066
Automation 360 Cloud updates.....	1072
Subscribing to notifications.....	1076
Automation 360 software lifecycle policy.....	1076
Automation and generative AI.....	1080
Data security for generative AI - FAQ.....	1081
Automation resiliency.....	1084
Manage unexpected pop-ups.....	1085
Feature deprecations affecting Automation Anywhere products.....	1086
Bot Scanner for EOL features.....	1096
Microsoft Internet Explorer EOL overview.....	1097
Deprecation of Basic authentication in Exchange Online.....	1123
Chrome and Edge Manifest V3 extensions.....	1138
Deprecation of Tesseract OCR v3.....	1149
Deprecation of EWS APIs in Exchange Online.....	1152
In-product user assistance.....	1159
Set up Automation 360.....	1163
Get started with Automation 360 Cloud.....	1165
Automation 360 Cloud prerequisites.....	1166
Installing Control Room On-Premises.....	1177
Automation 360 On-Premises prerequisites.....	1180
Installing Control Room using Custom mode.....	1245
Installing Control Room using custom mode for Oracle installation.....	1268
Installing Control Room using Express mode.....	1270
Installing Control Room on Amazon Web Services.....	1272
Installing Control Room on Microsoft Azure.....	1279
Installing Control Room on Google Cloud Platform.....	1288

---

Installing Control Room on Linux.....	1293
Installing Control Room on Microsoft Windows Server using scripts.....	1308
Complete Control Room post-installation configuration.....	1315
Using the Control Room diagnostics utility.....	1324
Uninstalling Automation 360.....	1325
Set up Community Edition.....	1326
Community Edition capabilities.....	1327
Get started with Bot Agent.....	1329
Bot Agent communication with Control Room.....	1331
Bot Agent compatibility.....	1332
Bot Agent device requirements.....	1340
Manage Bot Agent.....	1346
Install Bot Agent and register device.....	1347
Bulk install Bot Agent on devices.....	1354
Update Bot Agent.....	1361
Perform Bot Agent diagnostic checks.....	1364
Uninstall and reinstall Bot Agent.....	1368
Installing Control Room for Cloud-enabled deployment.....	1369
Naming guidelines for Control Room URLs.....	1370
Post-installation user management.....	1371
Configure Control Room as a service provider.....	1372
Configure Control Room authentication options.....	1373
Preparing for users.....	1390
Installed Control Room directories and files.....	1398
Licenses and cloud services.....	1404
Update Automation 360 to latest version.....	1423
Update Automation 360 on Microsoft Windows Server using scripts.....	1424
Install and update Automation 360 IQ Bot.....	1426
IQ Bot installation prerequisites.....	1429
Installing IQ Bot in Express mode.....	1439
Installing IQ Bot in Custom mode.....	1440
Installing IQ Bot in Cluster mode.....	1444
Installing IQ Bot in Cluster mode on Amazon EC2.....	1448
Postinstallation checklist.....	1449
Updating Automation 360 IQ Bot.....	1476
Uninstalling IQ Bot.....	1479
High availability and disaster recovery overview.....	1480
Log in to Automation Anywhere Control Room.....	1488
Create your first bot.....	1489
Run your first bot.....	1493
Moving from Automation 360 On-Premises to Cloud.....	1494
Moving data using Control Room operations.....	1495
Migrate using Control Room APIs.....	1495
Migrate.....	1496
Migration best practices.....	1503
Check migration readiness.....	1505
Prepare new Control Room for migration.....	1546
Migrate and validate bots.....	1586
Migrate Community Edition bots.....	1717
Migrate to Automation 360 IQ Bot.....	1718
Configure Automation 360.....	1737
Users.....	1737
Create a user.....	1739

---

---

Reset user password.....	1747
Roles.....	1748
Create a role.....	1748
Assign a role.....	1767
System roles.....	1768
Export roles.....	1774
Manage Active Directory role mapping.....	1774
Manage licenses.....	1782
View license details.....	1783
Installing additional licenses.....	1786
Create your users and assign their licensed roles.....	1787
Settings.....	1789
Manage device settings.....	1797
Switch device registration between Control Room instances.....	1807
Add access public IP addresses.....	1808
Set callback URLs.....	1809
Two-factor authentication.....	1809
Configure forward proxy settings.....	1812
Configure Credential Vault Connection mode.....	1813
Manage domain.....	1814
Editing SQL user information.....	1814
Syslog server integration.....	1815
Edit email notifications.....	1820
Version control in Automation 360.....	1822
Integrating Control Room with Git repositories.....	1824
Usage statistics.....	1835
Set up instances for Cloud-enabled deployments.....	1836
Generate registration key to install Bot Agent in bulk.....	1836
Configure integration with SIEM.....	1838
Use AuthConfig App to enable OAuth2 services.....	1846
Cloud device management (API Task).....	1856
Audit log settings FAQ.....	1857
Edit My settings.....	1858
Edit profile settings.....	1859
Set up your bot repository.....	1859
Working with repositories, credentials and roles.....	1860
Manage user credentials.....	1861
Credentials and lockers in the Credential Vault.....	1861
Set up lockers and credentials in Credential Vault.....	1862
Set up locker and assign credentials.....	1863
Create credential.....	1864
Create locker.....	1866
Credential Vault email notifications.....	1869
Manage Automation 360.....	1871
Devices.....	1873
About multi-user devices.....	1876
Edit multiple devices simultaneously.....	1880
About device pools.....	1881
Create device pools.....	1883
View device pool details.....	1884
Edit device pools.....	1885
Delete device pools.....	1887
Add queue, Bot Runner, and device pool.....	1888

---

Configure OAuth connections in Control Room.....	1889
Configure enterprise applications.....	1892
Create OAuth connection.....	1893
Use OAuth connection.....	1896
Packages.....	1898
RBAC on packages.....	1899
Updating packages in Control Room.....	1905
Add packages to the Control Room.....	1908
Updating package versions.....	1909
Manage Control Room packages.....	1913
External key vaults for Automation 360.....	1914
Integrating external key vault with Control Room.....	1916
External key vault naming conventions.....	1921
CyberArk Password Vault integration.....	1926
Azure Key Vault integration.....	1947
AWS Secrets Manager integration.....	1963
HashiCorp Vault integration.....	1979
Changing external key vault to another.....	1993
Verify external key vault configuration.....	1994
Troubleshooting external key vaults.....	1994
Workload management.....	1996
Create workload queues.....	1997
Run bot with queue.....	2006
Manage workload queues.....	2010
Manage Work Items.....	2025
Workload guidelines.....	2029
Bot Lifecycle Management.....	2030
Guidelines for exporting and importing bots.....	2033
Export bots.....	2033
Import bots.....	2035
Move bots across environments.....	2037
Recover bots and files.....	2039
Monitor Automation 360.....	2041
Automation Command Center.....	2041
ACC home page for administrators.....	2042
ACC home page for Pro and Citizen Developers.....	2044
Export Automation data.....	2045
Automation program lifecycle with CoE Manager.....	2046
CoE Manager.....	2047
CoE Manager Plus.....	2049
Getting started with CoE Manager.....	2050
Configure CoE Manager for SSO.....	2096
Using CoE Manager.....	2098
CoE Manager FAQ.....	2115
CoE Manager software lifecycle policy.....	2119
Activities.....	2121
Historical activity.....	2123
Scheduled activities.....	2129
Event triggers.....	2139
Audit log.....	2143
Audit events list.....	2144
Export audit data to CSV.....	2176
Code analysis.....	2178

Code analysis policy management.....	2182
Code analysis rules.....	2184
Checking out code analysis results.....	2185
Code analysis reports.....	2189
Code analysis enforcement.....	2189
Configure and assign code analysis policy.....	2191
Run code analysis.....	2192
Upgrade changes in code analysis policy for Automation 360 v.28 or later versions.....	2194
Notifications.....	2194
Getting started with Notifications.....	2196
Administer notifications for Control Room.....	2205
Enable or disable event categories.....	2207
Capabilities supporting notifications.....	2208
Control Room log files.....	2209
Build automations.....	2211
Templates.....	2212
Create template.....	2215
Edit a template.....	2217
Create automation from a template.....	2218
Copy a template.....	2219
Delete a template.....	2220
Check in a template.....	2221
Check out a template.....	2222
View version history of template.....	2225
View template dependencies and references.....	2225
Import templates.....	2226
Export templates.....	2227
Templates - Known behaviors.....	2228
Bot editor for creating bots.....	2228
Using Bot editor.....	2232
Keyboard shortcuts to expand or collapse elements in bot logic.....	2234
Get started with recorders.....	2238
Working with bots.....	2279
Variables overview.....	2326
Debug tool.....	2353
Bot dependencies.....	2359
Actions to build bots.....	2363
Advanced search option in Bot editor.....	2366
Search and replace option in Bot editor.....	2369
Active Directory package.....	2374
AI package.....	2390
Advanced Classifier package.....	2401
Analyze package.....	2412
Apigee action package.....	2413
App Integration package.....	2423
Application package.....	2428
AWS Comprehend NLP package.....	2429
Boolean package.....	2430
Bot migration package.....	2433
Browser package.....	2435
Clipboard package.....	2447
Credential package.....	2448



CSV/TXT package.....	2449
Comment package.....	2452
Data Table package.....	2452
Database package.....	2466
Datetime package.....	2484
Delay package.....	2492
Dictionary package.....	2493
DLL package.....	2498
Document Classifier package.....	2506
Document Extraction package.....	2511
Email package.....	2517
Error handler package.....	2552
Excel basic package.....	2558
Excel advanced package.....	2565
File package.....	2600
Folder package.....	2612
FTP / SFTP package.....	2618
Fuzzy match package.....	2625
Generative AI packages.....	2626
Genesys package.....	2659
Google packages.....	2691
Google Document AI package.....	2720
IBM Watson Authentication package.....	2722
IBM Watson Speech to Text package.....	2723
If package.....	2724
Image Recognition package.....	2731
Interactive forms package.....	2738
IQ Bot Pre-processor package.....	2742
IQ Bot Extraction package.....	2749
IQ Bot package.....	2758
JavaScript package.....	2760
Json package.....	2762
Legacy Automation package.....	2765
List package.....	2774
Log To File package.....	2781
Loop package.....	2784
Message box package.....	2796
Microsoft LUIS NLP package.....	2797
Mouse package.....	2798
Number package.....	2802
OCR package.....	2804
Microsoft 365 Calendar package.....	2811
Microsoft 365 Excel package.....	2821
Microsoft 365 OneDrive package.....	2841
Microsoft 365 Outlook package.....	2851
PDF package.....	2879
PGP package.....	2888
Play Sound package.....	2891
Printer package.....	2891
Process Composer package.....	2893
Process package.....	2904
Prompt package.....	2905
Python Script package.....	2907
Record package.....	2912

Recorder package.....	2916
REST Web Service package.....	2961
Salesforce package.....	2973
SAP package.....	2990
SAP BAPI package.....	3003
Screen package.....	3011
Service package.....	3016
ServiceNow package.....	3018
SharePoint package.....	3034
Simulate keystrokes package.....	3070
SNMP package.....	3072
SOAP Web Service package.....	3084
Step package.....	3085
String package.....	3086
System package.....	3105
Task Bot package.....	3109
Terminal Emulator package.....	3117
Text file package.....	3134
Trigger loop package.....	3136
V11 Task Bot package.....	3149
VBScript package.....	3153
Wait package.....	3155
Workday package.....	3162
Window package.....	3174
Workload package.....	3184
XML package.....	3186
Get started building bots.....	3197
Build a Go be Great bot.....	3198
Build a basic bot that uses a desktop application.....	3199
Example of extracting data from a web table.....	3201
Examples of building bots.....	3202
Common automation tasks and examples.....	3202
Example of entering data into a web form from a spreadsheet.....	3204
Example of passing a value between bots.....	3206
Example of using a conditional statement.....	3208
Example of using Python script to join a list.....	3209
Example of using the DLL package.....	3211
Example of using To string action from Datetime package.....	3213
Example of transferring data from CSV file to Excel worksheet.....	3216
Example of using Find file/folder action from Google Drive package.....	3219
Example of using Create Folder action from Google Drive package.....	3223
Example of using Go to Cell action from Google Sheets package.....	3225
Run TaskBot to merge Excel sheets.....	3229
Example of migrating data from Excel to a database.....	3231
Example of reading data from a spreadsheet.....	3234
Example of using the Run action.....	3238
Example of using the SOAP web service action.....	3240
Example of using Get structure command from SAP BAPI package.....	3244
Example of writing data to SAP using SAP BAPI package.....	3246
Example of using Run standard workflow from SAP BAPI package.....	3248
Example of using the VBScript package in a resilient bot.....	3250
Build a Bot Insight dashboard bot.....	3253
Example of using multiple analyze actions in a task.....	3256
Example of updating default package version across bots.....	3259

Example of using remote function call in SAP.....	3262
Example of using JSON package actions in a bot.....	3267
Example using Email actions in a bot.....	3272
Example using user account actions from Active Directory package.....	3274
Example of using Custom column option in Data Table package.....	3278
Example of using a file variable.....	3280
Example of using Salesforce package and record variable.....	3281
Example of using Custom selection option in Log variables to file action.....	3287
Create dictionary type variables.....	3289
Attended and unattended automation.....	3291
Using interactive forms.....	3292
Add a form to bot.....	3292
Automation Co-Pilot.....	3294
Automation Co-Pilot for Business Users.....	3296
Embed automations in your application using Automation Co-Pilot.....	3298
Using Automation Co-Pilot for Business Users on desktop.....	3360
Automation Co-Pilot for Business Users on the web interface.....	3372
Approvals in Automation Co-Pilot.....	3402
Automation Co-Pilot status and notifications.....	3406
Users and team roles for Automation Co-Pilot.....	3408
Manage roles and teams for Automation Co-Pilot.....	3409
Create users for Automation Co-Pilot.....	3411
Configure scheduler user for Automation Co-Pilot.....	3413
Configure deployment type for bots.....	3417
Automation Co-Pilot for Automators.....	3418
About Process Composer.....	3419
Process Composer roles and permissions.....	3421
Supported behaviors for tasks and elements in Process Composer.....	3422
Supported variable types in Process Composer.....	3433
Create a form.....	3438
Using the Button element.....	3438
Using the Checkbox element.....	3439
Using the Date element.....	3440
Using the Document element.....	3441
Using the Dropdown element.....	3441
Using the Dropdown Multi-Select element.....	3442
Using the Dynamic Area element.....	3442
Using the Hyperlink element.....	3443
Using the Image element.....	3443
Using the Label element.....	3444
Using the Number element.....	3445
Using the Password element.....	3446
Using the Radio Button element.....	3447
Using the Rich Text Editor element.....	3448
Using the Select File element.....	3448
Using the Select Folder element.....	3449
Using the Snapshot element.....	3450
Using the Table element.....	3451
Using the Text Area element.....	3452
Using the Text Box element.....	3453
Using the Time element.....	3453
Create a process automation in Process Composer.....	3454
Add Bot Task to a process automation.....	3456
Add Form Task to a process automation.....	3458

Add input variables to a process automation.....	3460
Add Filter Task to a process automation.....	3462
Add Process Task to a process automation.....	3462
Add Approval Task to a process automation.....	3463
Add Document Validation to a process automation.....	3469
Add End Point to a process automation.....	3470
Example: Upload and view PDF file.....	3471
Example: Use Select File to upload or download a file for web.....	3473
Working with process automations in Process Composer.....	3482
Check in a process automation.....	3483
Check out a process automation.....	3483
Run a process automation.....	3484
Move a process automation between folders.....	3485
Import a process automation.....	3486
Export a process automation.....	3489
Delete a process automation.....	3490
Display child process automation output.....	3490
Process Composer and Co-Pilot for Business Users.....	3491
API Task.....	3491
Invoking API Task in form.....	3494
Invoking API Task in process.....	3504
Preprocessing error messages.....	3508
Build advanced bots and packages.....	3509
Package SDK.....	3509
Using Python to parse JSON response.....	3584
Use JavaScript to build a bot to take user input.....	3595
Bot developer recommendations.....	3596
Bot Store submissions checklist.....	3596
Building reusable bots.....	3596
Building reusable packages.....	3603
Troubleshooting and debugging.....	3606
Troubleshoot bot run issue.....	3606
Bot Agent log files.....	3607
Bot Store.....	3607
Access Bot Store from the Control Room.....	3608
Submit bots or packages to Bot Store.....	3608
Directly import bots and packages from Bot Store to Control Room.....	3610
Download locally and import bots and packages from Bot Store to Control Room.....	3611
Private Bot Store.....	3612
Getting started with Private Bot Store.....	3612
Automation scenarios.....	3617
Scenario: Generating insurance quote with Automation Co-Pilot and Process Composer.....	3617
Architecture and tasks flow.....	3618
Scenario walkthrough.....	3619
Scenario summary and benefits.....	3620
Scenario: Developing and using templates in an automation.....	3621
Marcus creates a template.....	3622
Sue builds automation using the template.....	3622
Summary and benefits.....	3623
Document Processing.....	3624
Document Automation.....	3625

Document Automation architecture.....	3628
Document Automation FAQ.....	3631
Intelligent Document Processing solutions feature comparison matrix.....	3634
Set up your Document Automation environment.....	3636
Create a learning instance in Document Automation.....	3642
Improving extraction accuracy through validation.....	3662
Connect learning instance.....	3668
Integrate third-party parser in learning instance.....	3671
Publish the learning instance to production.....	3680
Using the Automation Co-Pilot Task Manager Validator for Document Automation.....	3688
Export/Import learning instances.....	3691
Create custom models in Document Automation using Standard Forms.....	3693
Document Automation support for Google Custom Document Extractor (CDE)...	3704
Document Automation data extraction using Generative AI.....	3709
Languages supported in Document Automation.....	3719
Document Automation Community Edition.....	3724
Create a learning instance in Community Edition.....	3726
Process documents in Community Edition.....	3728
Automation 360 IQ Bot.....	3730
IQ Bot architecture diagram.....	3732
Using Automation 360 IQ Bot On-Premises.....	3733
Using Automation 360 IQ Bot Cloud.....	3733
IQ Bot user personas and roles.....	3734
Languages supported in Automation 360 IQ Bot.....	3739
About the Classifier.....	3743
Create a learning instance.....	3746
Train a learning instance.....	3756
Manage learning instances.....	3787
Rotate the external key.....	3789
Use the IQ Bot Validator.....	3790
Review the dashboard.....	3793
Custom domains in IQ Bot.....	3796
Using IQ Bot for standard forms.....	3798
Process Discovery.....	3815
Overview of Process Discovery.....	3817
Process Discovery user roles.....	3818
Create Process Discovery users and assign roles.....	3819
Integrate SAML with SSO for Process Discovery.....	3820
Create your event reporting password.....	3822
Create a URL and application list.....	3822
Configure Observer activity.....	3823
Use Process Discovery with Kibana dashboard.....	3825
Access the Kibana dashboard.....	3827
Create a cycle.....	3829
Classify application screens and create web applications.....	3829
Applications with auto-assigned screen signatures.....	3831
Review Events and filter data.....	3832
Mining for processes.....	3836
Create a Mining Run.....	3837
Flow Graph.....	3839
Create a Path-based mining run.....	3843
Create a Butterfly mining run.....	3845

Export Mining Runs.....	3848
Analyze and prioritize processes.....	3848
Creating groups for the process and generate a PDD.....	3850
Getting started with Privacy Enhanced Gateway.....	3851
Install PEG.....	3852
Update PEG.....	3864
Configure PEG image redaction.....	3867
Manage disk space.....	3875
Manage PEG events.....	3876
Using Bulk delete.....	3877
Renew and replace certificates and keys using PEG.....	3878
Process Discovery Sensor application.....	3879
Installing Process Discovery Sensor.....	3879
Uninstalling Process Discovery Sensor.....	3880
Installing Process Discovery Sensor in a VDI environment.....	3880
Verify Process Discovery Sensor Installation.....	3882
Event Recording.....	3883
Enable and disable the users recording.....	3884
Process Discovery FAQ.....	3885
Process discovery by using Discovery Bot.....	3888
Get started with Discovery Bot.....	3889
Discovery Bot users.....	3890
Supported licenses for Discovery Bot.....	3892
Prerequisites for Discovery Bot.....	3896
Upgrade Discovery Bot from Enterprise A2019.15 to later versions.....	3898
Create users for Discovery Bot.....	3898
Create a Discovery Bot process.....	3905
Supported applications and browsers for Discovery Bot.....	3908
Record a Discovery Bot business process.....	3910
Record a Discovery Bot process using Automation Co-Pilot Desktop Assistant.....	3914
Analyzing opportunities for automation.....	3915
Review opportunities, convert to bot, and generate PDD.....	3916
Bot Insight.....	3925
Business analytics through Bot Insight.....	3925
Accessing Bot Insight.....	3926
Access Bot Insight from the Control Room.....	3926
Roles to access Bot Insight.....	3927
Role-based access control in Bot Insight.....	3928
Bot Insight dashboards.....	3929
Using Bot Insight.....	3948
Business analytics.....	3949
Using widgets.....	3950
Adding a dashboard widget.....	3951
Editing a dashboard widget.....	3954
Drilling down information in dashboard widget.....	3955
Renaming a dashboard widget.....	3955
Exporting data from a dashboard widget.....	3956
Data connector for Power BI.....	3956
Deploy Power BI connector.....	3957
Configure Power BI connector.....	3957
Example: Retrieve information in Power BI using business information API.....	3958
Configure Tableau web data connector in Bot Insight.....	3959

API References.....	3961
Control Room APIs.....	3961
v1.....	3963
v2.....	3963
v3.....	3963
v4.....	3963
Filtering, pagination, and sorting.....	3963
API response codes.....	3969
Comparing Automation 360 and Enterprise 11 APIs.....	3970
Configure the Control Room.....	3974
Roles and permissions.....	3975
System-created roles.....	3975
Administration permissions.....	3976
API permissions.....	3978
Audit log permissions.....	3979
Automation Co-Pilot (Previously named AARI) permissions.....	3979
Bot and bot credential permissions.....	3980
Bot Store permissions.....	3982
Dashboard and activity permissions.....	3982
Devices permissions.....	3983
Discovery Bot permissions.....	3984
Event triggers permissions.....	3985
IQ Bot permissions.....	3986
MetaBot permission.....	3988
Package manager permissions.....	3988
Workload permissions.....	3988
How to find a migration journalid.....	3988
Bot Agent API: Auto registration.....	3989
Index.....	3992

## Release Notes

Learn about our releases, as well as the software policies and feature deprecations for Automation Anywhere products.

Learn about what's new, changed, fixed, or the issues (limitations) in Automation 360 releases:

- [Automation 360 Release Notes](#) on page 17
- [Community Edition Release Notes](#) on page 749
- [Previous Package SDK Release Notes](#) on page 975
- [Process Discovery Release Notes](#) on page 983
- [CoE Manager Release Notes](#) on page 985

### Comparison matrices

Compare features between products to review feature parity and understand compatibility in order to update or move to our latest product release.

- [Automation 360 feature comparison matrix](#) on page 990
- [Automation 360 IQ Bot feature comparison matrix](#) on page 1005
- [Automation 360 IQ Bot version compatibility](#) on page 1010

### Software lifecycle policy

The Automation Anywhere software lifecycle policy aims to provide predictability, quality, and importantly nondisruptive access to the latest innovations and enhancements so that you can control when and how you want to adopt these enhancements.

See [Automation 360 software lifecycle policy](#) on page 1076.

### Cloud Service status

Our Automation 360 Cloud Service Status site shows real-time operational status, historical operational status, maintenance information, and incident history for all Automation 360 Cloud services worldwide, across all hosting regions.

See [Automation 360 Cloud Service Status site](#) on page 1066.

### Feature deprecations

Learn about features and capabilities (from Automation Anywhere or third party) that are deprecated or nearing deprecation to understand how they affect your automation and what action is required.

See [Feature deprecations affecting Automation Anywhere products](#) on page 1086.



## Automation 360 Release Notes

Review the new capabilities, changes, fixes (resolved issues), security fixes, deprecated features, and limitations in each release.

### Product name changes

The following products are renamed:

- AARI is called Automation Co-Pilot for Business Users, and RPA Workspace is called Automation Workspace from Automation 360 v.28 release. Although release notes earlier than v.28 will show the new name, the content in these release notes is applicable and relevant to AARI and RPA Workspace.
- Enterprise A2019 is now called Automation 360. Although the release notes for releases earlier than Automation 360 v.21 release reference the old product name, the content in these release notes is applicable and relevant to Automation 360.

Related concepts

[Community Edition Release Notes](#) on page 749

Review the new capabilities in different Automation 360 Community Edition releases.

Related reference

[Automation 360 feature comparison matrix](#) on page 990

Compare Automation 360 features with Enterprise 11.3.x and Enterprise 10 features to understand the benefits to Automation 360. Review advantages of Automation 360 if you are a new user of the product.

[Automation 360 FAQ](#) on page 1018

For details and questions on the latest Automation Anywhere platform, Automation 360, review this FAQ.

## Automation 360 v.31 Release Notes

Release date: 6 December 2023

Review the top 5 features in this release and view other new features and exciting enhancements for Automation 360 v.31 release.

- Build 21023: Automation 360 (Cloud-Sandbox)
- Build 21023: Automation 360 (On-Premises) and IQ Bot (On-Premises)

We have released the updated Cloud-Sandbox Build 21023 (previously Build 20926). For information about the updates, see [Release updates on page 20](#).

### Highlights of this release

Here are the top features in the v.31 release:

Generative AI features

- Automation Co-Pilot for Automators: Empower developers with an on-demand

AI-powered automation assistant, exclusively available for our Cloud customers.

Customers can harness the power of AI to:

- Build automations quickly with natural language processing

Describe your automation goals to Automation Co-Pilot and let it transform your ideas into automations that will speed up the development cycle.

- Auto-complete automations using next actions

Receive AI-driven, real-time suggestions for the next steps in your automation workflow, empowering developers of all levels to create faster and more efficient automations.

---

**Important:** These features will be available with the Cloud rollout for Automation 360 v.31 release.

These features require purchasing an additional license. Contact your Automation Anywhere account representative for more information.

---

See [Automation Co-Pilot for Automators](#) on page 3418.

- Document Automation

As we continue to expand our document automation capabilities with generative AI, customers can now easily extract data from invoices and custom documents. This feature can be used to query and retrieve data from form fields when used with Automation Anywhere as the extraction provider.

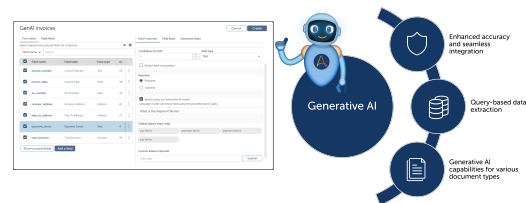

See [Document Automation data extraction using Generative AI](#) on page 3709.

Enterprise Plus: Unlock automation excellence    Enterprise Plus platform, an advanced iteration of our core automation solution, is equipped

with enterprise-grade features for process, API, governance, and security. Modernize automations with API Tasks, and leverage features such as testing your API Tasks for coding best practices, exporting automations dashboard data to analyze, and storing your global cache data for more than 30 days.

See [API Task](#) on page 3491 | [Configure and assign code analysis policy](#) on page 2191 | [Export Automation data](#) on page 2045 | [Configure global cache settings](#) on page 1801.

**Note:** For more information about this platform, contact your Automation Anywhere account representative.

API Tasks: Efficient automation with near real-time responses

Run your automations exclusively in the Cloud, seamlessly integrating with SaaS applications and API endpoints. API Tasks provide near real-time automation responses, minimizing wait times. Save on costs with no on-premises infrastructure expenses for Windows or VMs maintenance. API Tasks are easy to build, can be integrated into processes and forms, and accessed by business users via Automation Co-Pilot in enterprise applications. You can also generate consumption-based reports, alerts, and dashboard widgets for API Tasks, gaining valuable insights and monitoring capabilities.

**Note:** This feature is available only for AWS environments and requires purchasing an additional license. Contact your Automation Anywhere account representative for more information.

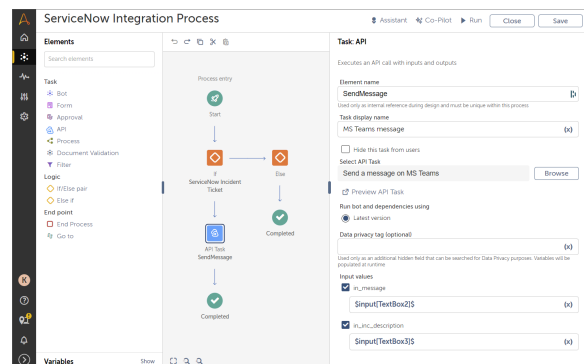

See [API Task](#) on page 3491.

Comprehensive automation coverage for Citrix XenApps

Our Automation Success Platform now supports XenApp-powered virtualization of end-to-end automation infrastructure,

Enhanced security	<p>including virtualization of the Control Room. Customers can now perform reliable object-based automation of business applications running on remote devices even when those are accessed from a virtualized Control Room.</p> <p>See <a href="#">Recorder package</a> on page 2916.</p> <p>Ensure compliance and secure access by using OAuth2 based authentication when granting users access to automate Microsoft 365 and Google Workspace applications. Users can set up an OAuth2 connection in the Control Room and consume the same OAuth2 connection in each of these applications for user authentication.</p> <p>See Using Connect action:</p> <ul style="list-style-type: none"> <li>• <a href="#">Microsoft 365 Outlook package</a></li> <li>• <a href="#">Microsoft 365 Excel package</a></li> <li>• <a href="#">Microsoft 365 Calendar package</a></li> <li>• <a href="#">Microsoft 365 OneDrive package</a></li> <li>• <a href="#">Google packages</a></li> </ul>
-------------------	---

## Release updates

Date	Update
8 January 2024	On-Premises release
4 January 2024	Build 21023 supports API Task. See <a href="#">API Task</a> on page 3491.
6 December 2023	Cloud-Sandbox release

## What's new and changed in each product

Navigate to the following pages for details on all the updates (what's new, changed, fixed, and limitations) in each product:

<a href="#">Automation Co-Pilot for Automators v.31 release</a> on page 21
<a href="#">Automation Workspace v.31 release</a> on page 21
<a href="#">Automation Co-Pilot v.31 release</a> on page 35
<a href="#">Document Automation and IQ Bot v.31 release</a> on page 39
<a href="#">Process Discovery Release Notes</a> on page 983

## Automation Co-Pilot for Automators v.31 release

Review what's new in Automation Co-Pilot for the v.31 release.

---

**Important:** This feature will be available with the Cloud rollout for Automation 360 v.31 release.

---

**Note:** Generative AI models can produce errors and/or misrepresent the information they generate. It is advisable to verify the accuracy, reliability, and completeness of the content generated by the AI model.

---

### What's new

Build automations with natural language Professional developers and Citizen Developers can now use Automation Co-Pilot, powered by generative AI, to create automations with simple text instructions, reducing the time to create and update automations.
Suggest next actions Suggest next actions, a generative AI-based feature provides real-time suggestions on the next possible actions in the context of your automation workflow. This feature allows every developer, from novice to expert, to build automation easily and helps accelerate automation development in an organization to achieve a higher level of productivity.
<a href="#">Automation Co-Pilot for Automators</a> on page 3418

Next topic: [Automation Workspace v.31 release](#) on page 21

## Automation Workspace v.31 release

Review what's new and changed, and the fixes and limitations in Automation Workspace for the v.31 release.

### What's new

<b>Control Room, devices, and Bot Agent</b>
Support for Microsoft Windows Server 2022 Datacenter You can now install the Control Room on Microsoft Windows Server 2022 Datacenter as it is supported for Microsoft Azure virtual machines. <a href="#">Operating system, environment, and platform supported for Control Room</a> on page 1194

Control Room, devices, and Bot Agent
<p>Change global cache expiry period</p> <p>Control Room administrators can now change the default expiry period (30 days) of the global cache.</p> <p><a href="#">Configure global cache settings</a> on page 1801</p> <hr/> <p><b>Note:</b> This feature requires the Enterprise Plus license. Contact your Automation Anywhere account representative for more information about this license.</p> <hr/>
<p>Customize email template (Service Cloud case ID: 01823034)</p> <p>As a Control Room administrator, you can customize email templates to send email report notifications to a user's registered email address. The following capabilities are provided when you customize an email template:</p> <ul style="list-style-type: none"><li>• You can add a logo (image of the company logo) in the email body.</li><li>• Use the option to turn off the email footer with Automation Anywhere social media links.</li></ul> <p>After applying these changes, you can preview the email template updates by sending a test email. Additionally, you can view and edit any email template you have previously customized.</p> <p><a href="#">Manage notification channels</a> on page 2206</p>
<p>Automatically purge historical activities (Service Cloud case ID: 01255033, 01753613, 01764385, 01907781, 01951958, 02004210)</p> <p>Configure your Control Room settings to automatically purge (delete) historical activities that are older than a specified period.</p> <ul style="list-style-type: none"><li>• Cloud: By default, the historical activities are set to be deleted after 90 days and this option is always enabled.</li><li>• On-Premises: By default, this option is set to <b>Do not purge</b> when you update from a previous release to v.31 or later releases or when you directly set up v.31 or later releases. When you set this option to <b>Purge</b>, the historical activities are set to be deleted after 365 days by default.</li></ul> <p><a href="#">Settings</a> on page 1789</p>

**Control Room, devices, and Bot Agent**

Code analysis supported for API Tasks

As an administrator, you can now establish coding best practices by setting a code analysis policy and improve your team's code quality for the new API Tasks. Professional and Citizen Developers can receive feedback on the status of their automations and on what needs to be fixed, thus improving their code quality.

Code analysis supports policies with rules for both Task Bot as well as API Task files and supports integration with policy manager, Bot editor, and Assistant for both file types.

**Note:** This feature requires the Enterprise Plus license. Contact your Automation Anywhere account representative for more information about this license.

[Configure and assign code analysis policy](#) on page 2191

**Packages, actions, and Bot editor**

Improved usability of the Assistant utility

The Bot editor, API editor, and the Template editor are now enhanced to remember the last position of the **Assistant** utility before you exit the editor. This improves the usability of the **Assistant** as you no longer have to move the **Assistant** to the right of the editor to view the Actions panel each time you open the bot within the editor.

[Debugging your automations](#) on page 2353

**Building and running bots**

Export Automations dashboard data

Control Room administrator or user with **View operations data** (Export operations details and View operations details) permissions can use the **Export** option on the **Automations** dashboard to export automation data to analyze and make informed decisions backed by insights. You can export a maximum of 10,000 records in a CSV file.

**Note:** This feature requires the Enterprise Plus license. Contact your Automation Anywhere account representative for more information about this license.

[Export Automation data](#) on page 2045

Enhanced Devices dashboard

We have introduced a new **Device utilization details** widget on the ACC home page to provide information about the utilization of each device registered with the Control Room for the selected date range.

APIs and integrations
<p>Authentication API</p> <p>The <code>v1/authentication</code> and <code>v1/authentication/token</code> APIs are deprecated and are replaced with <code>v2/authentication</code> and <code>v2/authentication/token</code> APIs.</p>
<p>Delete Workitems API</p> <p>The Swagger documentation is corrected to show <code>POST /v3/wlm/queues/{id}/workitems/delete</code> API instead of <code>DELETE v3/wlm/queues/{id}/workitems/delete</code> API.</p>
<p>Migration APIs</p> <ol style="list-style-type: none"> <li>1. The <code>v2/migration</code> APIs are removed.</li> <li>2. The <code>v3/migration</code> APIs are deprecated and are replaced with <code>v4/migration</code> APIs.</li> </ol>
<p>User Management APIs</p> <p>To accommodate a wider range of IDs the User Management endpoints are updated to use <code>int64</code> data types. As a result of this update the <code>v1/usermanagement</code> APIs are deprecated and are replaced with <code>v2/usermanagement</code> APIs.</p>

## What's changed

Control Room, devices, and Bot Agent
<p>Audit log improvement for troubleshooting unsuccessful events (Service Cloud case ID: 01950866)</p> <p>You can now view the <b>Results</b> field for unsuccessful audit log entries on the audit log page. When you export such entries to an Excel sheet, you can view the results in the <b>Results</b> column.</p> <p><a href="#">Audit log</a> on page 2143</p>
<p>The <b>autoregistration.properties</b> file is not auto-deleted (Service Cloud case ID: 01793789)</p> <p>When you update to Automation 360 v.31, the <code>autoregistration.properties</code> file is no longer removed automatically:</p> <ul style="list-style-type: none"> <li>• Even when the <code>AA_DELAY_REGISTRATION_UNTIL_LOGIN</code> parameter is set to <b>True</b> or <b>False</b></li> <li>• When you update Bot Agent to the corresponding version</li> </ul> <p>Note that the <code>autoregistration.properties</code> file is deleted when you uninstall the Bot Agent.</p> <p><a href="#">Bulk install Bot Agent on devices</a> on page 1354</p>



Control Room, devices, and Bot Agent
<p>Enhancement to new user registration link</p> <p>The user registration link provided in the user registration email is now set to expire after 24 hours to enhance the security of the registration process.</p>
<p>Disable email notification for locker consumers</p> <p>You now have the option to disable email notifications when a locker administrator adds or removes consumers from lockers.</p> <p><a href="#">Edit email notifications</a> on page 1820</p>
<p>Enhanced options for editing scheduled activity (Service Cloud case ID: 00803430, 01835976)</p> <p>You can now use the following enhancements to edit a scheduled activity:</p> <ul style="list-style-type: none"> <li>• Move up the <b>Start date</b> and <b>Start time</b>. An alert is displayed if you select a <b>Start date</b> or <b>Start time</b> that is earlier than your device time.</li> <li>• Add or delete device pools.</li> <li>• Change the selected <b>Run-as user</b>.</li> </ul> <p><a href="#">Edit a scheduled activity</a> on page 2135</p>
<p>Changes in the Automation Command Center dashboard</p> <p>When you navigate to the <b>Automation</b> and <b>Devices</b> tab on the Automation Command Center (ACC) homepage, the <b>Date Range</b> menu is now moved to the left side of the page.</p>
<p>Notifications for your Document Automation license consumption</p> <p>If you have enabled notifications, you will receive a notification for your Document Automation license consumption when 80% of your licenses is consumed.</p> <p>You can use this feature to plan for additional licenses.</p> <p><a href="#">Understanding licenses in Document Automation</a> on page 1410</p>
<p>Improved error message for variablized child bot</p> <p>When a parent bot calls a child bot, and if the parent bot sends an input parameter with an incorrect data type, the bot fails with an error, and the following error message is displayed: Could not map the value of parent bot "&lt;bot name&gt;" with variable "&lt;variable-name&gt;" of child bot "&lt;bot name&gt;".</p> <hr/> <p><b>Note:</b> Set Bot compatibility version to 5 to get the advantages of all cumulative features of previous versions.</p>

**Control Room, devices, and Bot Agent**

Identify users who stopped bots (Service Cloud case ID: 01940890, 01952731)

You can now identify users who stopped bots in the audit logs and historical activities.

- Audit log: The **Username** field in the **Run bot stopped** audit log identifies the user who stopped the bot.
- Historical activity: The **Modified by** field on the **Historical activity** page identifies the user who stopped the bot.

[Audit log](#) on page 2143 | [Historical activity](#) on page 2123

**Fixes**

A device deletion job is now completed successfully even if you had created a device pool with a temporary (disconnected) device. Also, the deleted device is no longer displayed in the **Audit log** or on the **Device list** page.

The user now receives email notifications without any issues.

Previously, if the administrator changed the **Secondary email language** to `None` in the **Settings > Notification channels**, an email notification was not sent to users irrespective of the **Primary email language** set as `English`.

The alert summary report now displays the correct start and end date and time.

The total notification count is now displayed correctly in the alert summary report. The total notification count now matches the sum of attention needed and information notification counts.

The total notification count is now displayed correctly in the alert summary report. The total notification count now matches the sum of attention needed and information notification counts.

Fix for login delays during intense repository activity has been implemented.

Previously, intense repository activities could lead to delays or blocks for other users attempting to log in to the Control Room. This fix ensures smooth login experiences even during periods of high repository usage.

When you create a **List** variable with the **File** subtype in a bot, select the value as a Control Room file, and if you use the List package to assign value to the list variable, the bot now runs successfully.

Sensitive data is no longer logged in the Control Room logs.

Service Cloud case ID: 01981351

You no longer observe issues while performing bulk updates for any package.

Previously, an error message was displayed while performing bulk updates for any package.

Service Cloud case ID: 01962784, 01999625, 02003091, 02000434, 02005592, 02081914, 02089595

The **Create User** audit log entry page will no longer display license information. Previously, license information was displayed on such audit log entry page.

Available event triggers are no longer deleted if there are any Control Room connectivity issues. Previously, some of the associated event triggers were deleted.

Service Cloud case ID: 01978574, 01979241, 01979619

The **Debug** tool no longer encounters an issue when you open the bot in **Debug** mode and keep the **Debug** tool inactive for a few minutes.

Service Cloud case ID: 01972733, 02094537, 02095109

You will no longer see duplicate active bot entries for a device on the **In progress activity** page.

Previously, duplicate active bot entries were displayed for a device.

Service Cloud case ID: 02084299

If you search for audit log entries using invalid characters, an appropriate message is now displayed to indicate the valid characters that you can use in your search.

Previously, a generic message was displayed.

Service Cloud case ID: 01977481

You will no longer see multiple **DEFAULT\_DEVICE\_UNSET** event type entries on the **Audit log** page when the following conditions are met:

- A default device is not set in the Control Room.
- The Bot Agent is not installed on your local device.
- The **Clear the user's existing bot running device if the bot agent is not present on the local device** option is not selected in the general devices settings.

Previously, multiple **DEFAULT\_DEVICE\_UNSET** event type entries in such a scenario.

Service Cloud case ID: 01991901

When you run a bot that is using a child bot, the progress bar on the **In progress activity** page now displays the correct line numbers.

Previously, incorrect line numbers were displayed.

Service Cloud case ID: 01994423, 02005566

When a bot run is timed out, the **Started on** and **Ended on** values on the **Historical activity** page now display the correct start and end timestamps.

Previously, the **Started on** and **Ended on** values displayed the same timestamps.

Fixed security vulnerability issues. For more information, click the release download link and view the Security & Compliance reports at [A-People Downloads page \(Login required\)](#).

Service Cloud case ID: 01986857, 01988493, 01986581, 01957781, 01977037

<p>When you update to Automation 360 v.29 or later versions and deploy a queue on an existing device pool, the queue now deploys successfully.</p> <p>Previously, sometimes, the queue had to be deployed on a newly created device pool to run successfully.</p> <p>Service Cloud case ID: 01993651, 01993714, 01994355, 01994555</p>
<p>When you add work items through a CSV with just a header row and no records, you can still delete the queue successfully.</p> <p>Previously, the queue with pending work order and empty work items list could not be deleted.</p> <p>Service Cloud case ID: 01903605</p>
<p>You can now successfully use SSH authentication to configure a remote Git repository integration.</p> <p>Previously, Git integration would fail with an invalid authentication error if SSH authentication was used.</p> <p>Service Cloud case ID: 01973857</p>
<p>You can successfully export your production label bots that contain dependencies like .dll, .xlsx, .txt, and so on without any issues.</p> <p>Previously, export of few production label bots failed with an error due to data migration issues.</p> <p>Service Cloud case ID: 01979699</p>
<p>You can now edit a bot that contain dependencies while the check-in is in progress without any issues.</p> <p>Previously, if the check-in was in progress, the bot would take a long time to open in the Bot editor.</p> <p>Service Cloud case ID: 02095424</p>

## Limitations

<p>On the <b>In progress activity</b> page, the <b>Activity type</b> filter displays the following behaviors:</p> <ul style="list-style-type: none"><li>• The <b>Schedule Bot</b> activity type is not listed in the <b>Activity type</b> drop-down even when there are such entries listed in the table.</li><li>• When you select the <b>Run Bot</b> activity type from the <b>Activity type</b> drop-down, no entries are displayed in the table even when such entries are available.</li></ul> <p>Workaround: Sort the <b>Activity type</b> column in the table to filter and view the <b>Schedule Bot</b> and <b>Run Bot</b> activity types.</p>
--

When you use Command Prompt API to switch device registration from one Control Room to another, the device is de-registered from the first Control Room. However, the device registration will not revert to the first Control Room if it fails after de-registering.

Workaround: Ensure that you use the correct API parameters.

When you create a bot, use a table variable with column type as **Datetime** and no values defined in the Datetime column, the bot fails with an error on execution.

When you update to Automation 360 v.31, if handling unexpected pop-ups feature is enabled in an active WLM automation, and you add work items to an active queue, the flag value to manage unexpected pop-ops is not retained.

Workaround: Pause and resume the queue before adding the add work items to the queue.

When a bot has more than two versions and you assign production label to an earlier version of the bot and export it, the metadata associated with the latest version of the bot is exported instead of the metadata associated with the production version.

## Updating to v.31 release

Review requirements and support information about updating your Control Room and Bot Agent for the v.31 release.

## Bot Agent updates

**Note:** This release includes an optional Bot Agent update. You can continue to run your existing bots without updating the Bot Agent. However, if you want to use the new features in Automation 360 v.31, you must update the Bot Agent available with this release.

While the Bot Agent update is optional in most of the updates rolled out for Automation 360, in environments where auto-update is enabled but auto-deploy is disabled for triggers, you need to log in to the browser session after the update is rolled out to activate the trigger listener.

For more information on updating to this release, see these resources:

- [Automatically update the Bot Agent](#) on page 1361 | [Manually update the Bot Agent](#) on page 1362
- [Compatibility with release builds](#) on page 1333

## Certified Control Room builds for direct update

You can update to the latest version of Automation 360 from the previous three releases (that is, from n-3 releases, where n refers to the latest release).

The following previous releases are certified for update to Automation 360 v.31:

- v.30 (Build 19688, 19678, 19621)
- v.29 (Build 18371, 18381, 18399)
- v.28 (Build 17571, 17566, 17542, 17506)

If you are on one of these previous releases, for information about updating, see [Update Automation 360 to latest version](#) on page 1423. If you are not on an n–3 release, update Automation 360 to one of the n–3 releases before updating to Automation 360 v.31.

## Migration updates for v.31 release

Review the fixes for migrating from Enterprise 11 and 10 versions to Automation 360 v.31.

### Fixes

In Enterprise 11, if a bot was using the PGP package to decrypt an encrypted file and if the public and private keys were in the same file, after migration, you can successfully decrypt the file.

Previously, you encountered an error when you ran such a bot.

Service Cloud case ID: 01985740

After migration, you will no longer encounter an error when you open a bot and mark a message as reviewed (**Mark as reviewed**) in the Bot Assistant.

Previously, you encountered an error in such a scenario.

Service Cloud Case ID: 02086299

In Enterprise 11, if you have configured a default domain, after migration, you will no longer see a blank domain drop-down on the sing-in screen and will be able to select a default domain.

Previously, you were unable to select a default domain.

Service Cloud Case ID: 01968481, 01977352

## Packages updated in v.31

Review updates to the packages in Automation 360 v.31, including the compatible Control Room and Bot Agent versions.

### Packages updated in v.31

The following table lists the updates in the packages for this release:

**Note:** For information about packages related to previous releases, see the PDFs for these releases: [Automation 360 previous release versions](#).

Package name	Version	Bot Agent version	Control Room version
Boolean	<a href="#">2.11.1</a> on page 847	20.11 or later	8750 or later
Bot Migration	<a href="#">10.8.2</a> on page 849	21.220 or later	15224 or later

Package name	Version	Bot Agent version	Control Room version
Browser	<a href="#">3.10.2</a> on page 851	21.210 or later	14140 or later
Clipboard	<a href="#">3.8.0</a> on page 853	20.11 or later	8750 or later
Comment	<a href="#">2.16.0</a> on page 854	20.11 or later	8750 or later
Credentials	<a href="#">1.7.1</a> on page 855	20.11 or later	8750 or later
CSV/TXT	<a href="#">2.13.0</a> on page 857	20.11 or later	8750 or later
Database	<a href="#">5.2.1</a> on page 859	21.88 or later	10204 or later
Datetime	<a href="#">2.14.0</a> on page 862	20.11 or later	8750 or later
Delay	<a href="#">3.9.1</a> on page 863	20.11 or later	8750 or later
Dictionary	<a href="#">3.14.0</a> on page 864	20.11 or later	8750 or later
Document Extraction	<a href="#">3.31.16</a> on page 868	21.252 or later	19223 or later
Email	<a href="#">3.19.2</a> on page 873	21.210 or later	13980 or later
Excel advanced	<a href="#">6.17.0</a> on page 879	21.112 or later	11307 or later
File	<a href="#">6.9.1</a> on page 882	21.98 or later	10789 or later
Folder	<a href="#">6.9.1</a> on page 884	20.11 or later	8750 or later
Google Calendar	<a href="#">2.12.2</a> on page 889	20.11 or later	8750 or later
Google Drive	<a href="#">2.13.2</a> on page 891	20.11 or later	8750 or later
Google Sheets	<a href="#">2.14.1</a> on page 892	20.11 or later	8750 or later
If	<a href="#">3.7.14-20231116</a> on page 895	20.11 or later	8750 or later
Image Recognition	<a href="#">3.17.2</a> on page 896	21.210 or later	14100 or later

Package name	Version	Bot Agent version	Control Room version
IQ Bot Pre-processor	<a href="#">3.31.0</a> on page 901	21.98 or later	10520 or later
IQ Bot	<a href="#">3.31.2</a> on page 900	21.98 or later	10520 or later
JavaScript	<a href="#">2.16.0</a> on page 902	20.11 or later	8750 or later
JSON	<a href="#">1.5.1</a> on page 904	21.98	10520
Legacy Automation	<a href="#">6.4.0</a> on page 905	21.200 or later	13279 or later
List	<a href="#">2.13.0</a> on page 906	20.11 or later	8750 or later
Loop	<a href="#">3.8.1-20231117-205150</a> on page 909	20.11 or later	17208 or later
Message Box	<a href="#">3.7.0</a> on page 910	20.11 or later	8750 or later
Microsoft 365 Calendar	<a href="#">2.15.0</a> on page 911	20.11 or later	8750 or later
Microsoft 365 Excel	<a href="#">2.15.0</a> on page 913	20.11 or later	8750 or later
Microsoft 365 OneDrive	<a href="#">2.15.0</a> on page 915	20.11 or later	8750 or later
Microsoft 365 Outlook	<a href="#">1.3.0</a> on page 918	21.210 or later	13980 or later
Number	<a href="#">3.9.1</a> on page 922	20.18 or later	9130 or later
OCR	<a href="#">2.13.1</a> on page 923	21.118 or later	8750 or later
PDF	<a href="#">3.10.0</a> on page 924	21.31 or later	9300 or later
PGP	<a href="#">3.7.1</a> on page 926	21.88 or later	10195 or later
Ping	<a href="#">3.6.0</a> on page 927	20.11 or later	8750 or later
Printer	<a href="#">2.7.0</a> on page 929	20.11 or later	8750 or later
Prompt	<a href="#">2.8.0</a> on page 931	20.11 or later	8750 or later



Package name	Version	Bot Agent version	Control Room version
Python Script	<a href="#">2.16.0</a> on page 933	20.11 or later	8750 or later
Record	<a href="#">1.10.0</a> on page 934	21.134 or later	17917 or later
Recorder	<a href="#">2.16.0-20231102112105</a> on page 936	21.105 or later	14068 or later
SAP	<a href="#">3.13.0</a> on page 948	21.88 or later	10195 or later
Screen	<a href="#">2.10.0</a> on page 950	20.11 or later	8750 or later
Service	<a href="#">4.9.0</a> on page 951	20.11 or later	8750 or later
SNMP	<a href="#">2.8.0</a> on page 957	20.11 or later	8750 or later
String	<a href="#">5.9.0</a> on page 960	20.18 or later	9130 or later
System	<a href="#">3.14.0</a> on page 962	21.88 or later	10217 or later
Terminal Emulator	<a href="#">4.11.1</a> on page 965	21.93 or later	10353 or later
Text file	<a href="#">1.7.0</a> on page 967	20.11 or later	8750 or later
VBScript	<a href="#">2.20.0</a> on page 969	21.21 or later	14100 or later
Wait	<a href="#">4.10.1</a> on page 970	20.11 or later	8750 or later
Window	<a href="#">5.11.0</a> on page 972	20.11 or later	8750 or later
XML	<a href="#">3.12.0</a> on page 974	20.11 or later	8750 or later

### Packages not updated in v.31

The following table lists packages that have not been updated in the v.31 release but are compatible with this release.

Package name	Version	Bot Agent version	Control Room version
Active Directory	3.9.0	20.11 or later	8750 or later

Package name	Version	Bot Agent version	Control Room version
Advanced Classifier	2.1.1	21.250 or later	17953 or later
Analyze	2.8.0-20230420-11621	21.182 or later	8750 or later
App Integration	4.13.0	21.88 or later	10195 or later
Application	3.8.0	20.11 or later	8750 or later
Boolean	2.9.0	20.11 or later	8750 or later
Data Table	4.8.0	20.11 or later	8750 or later
Error handler	2.11.3-20230316-11621	21.162 or later	8750 or later
Excel basic	6.15.0	21.112 or later	11307 or later
FTP / SFTP	2.11.0	20.11 or later	8750 or later
Google G Suite	2.8.0-20220426-23510	21.104 or later	8750 or later
Hot keys	1.5.0-20230328-05020	21.152 or later	8750 or later
Mouse	2.15.0	21.210 or later	14100 or later
Play Sound	2.6.0-20220420-07131	21.115 or later	8750 or later
Process Composer Process Composer	7.30.2	21.134 or later	12316 or later
SAP BAPI	2.9.0	21.2 or later	9249 or later
Service	4.8.0	20.11 or later	8750 or later
Simulate keystrokes	4.3.0	21.200 or later	13297 or later
Step	2.5.0-20230106-13537	21.153 or later	8750 or later
SOAP Web Service	3.17.0	21.240 or later	17571 or later
SNMP	2.7.1	20.11 or later	8750 or later
Task Bot	2.8.0-20230530-11527	21.152 or later	8750 or later
V11 Task Bot	1.14.0	20.11 or later	8750 or later
Workday	1.2.0	21.231 or later	17076 or later

## Automation Co-Pilot v.31 release

Review what's new and changed in Automation Co-Pilot for the v.31 release.

### What's new

Select a user group in a Process task in Process Composer

As a Bot Creator or Citizen Developer, you can assign a user group based on role or team when creating a new Process task in Process Composer. If you do not designate a user group, the default user group will be used in the Process task.

[Add Process Task to a process automation](#) on page 3462

Move a process automation between folders in Process Composer

As a Bot Creator or Citizen Developer, you can move a new process automation from one folder to another within a private workspace.

[Move a process automation between folders](#) on page 3485

Assign custom roles with more granular permissions in Process Composer and Automation Co-Pilot

As an administrator, you can create custom roles with greater granular permissions to adhere to your organization's security directives and align with principles or least privileges. You are no longer required to use the system-defined roles provided by applications. You can create roles and assign permissions related to tasks, requests, and processes.

[Process Composer roles and permissions](#) on page 3421

Administrators can also customize roles to more specific functionality in Automation Co-Pilot (for example, Teams, extensions, and bots).

[Feature permissions for a role](#) on page 1749

All privileges granted to existing user-created roles persist, as expected. The new permission model continues to be based on product behavior. Permission options are simply offered across a broader scope to include product developments since the previous model.

### What's changed

Improved image file upload

The experience has been improved for selecting and uploading a file to the image element when creating a form. Now the thumbnail of the image element is interactive, and users can click to open the file finder for selection or simply drag the file into the image element on the canvas. This improvement is in addition to the existing method of selecting files in the configuration panel.

Favorite automations are now persisted on the server side

Within Automation Co-Pilot (both Embedded and Assistant), automations selected as favorite will persist across browser sessions, to display as a filtered group for quick access when the user selects the **Show my favorites** check-box. When showing favorites, the automation list will default to display only selected favorites until the user clears the **Show my favorites** check-box. Previously, if cache was cleared or the user used a different browser, all favorite selections would need to be made again.

Upon selecting a default user group (team or role) for a process in Automation Co-Pilot, that default user group will display with a **default** label next to the name to identify the group as further process setup is configured.

## Fixes

When the title is the only edit to an existing process, the save button is enabled. Previously, the **save** button would not enable for this simple edit.

In the Process Composer, element names in a Task, like Form or Bot, will display correctly after the attached process has been imported. Previously, sometimes when nodes were clicked from step to step the element name displayed inaccurately.

Automation Co-Pilot works as expected when clicking an option of a drop-down menu that is blank. Previously, the page would break in this scenario.

Automation Co-Pilot operates as expected when the Control Room is deployed on an Oracle database. Previously, Automation Co-Pilot would display an unknown error when the Control Room was deployed in this scenario. [Database requirements](#) on page 1188

After selecting Open in new window from the embedded widget and submitting a form, the task in the main window updates as expected. Previously after submitting a form in this scenario, the task in the main window would stay in the same initial step.

In Automation Co-Pilot on the document validation page, one status pill displays as expected. Previously, three pills displayed.

When running a bot or process, the Automation Co-Pilot status synchronizes with back-end progress and the page redirects to the list of automations upon completion, as expected. Previously, the status displayed in Automation Co-Pilot intermittently did not synchronize with the back-end progress, causing errors in messaging and task sequence display.

Paths to forms and bots import without error. Previously during the import process, the paths might intermittently break to forms and bots configured in an imported form or bot task.

Service Cloud case ID: 02016727

Automation Co-Pilot displays the list of tasks when selecting Show only tasks assigned to me, as expected. Previously no list was displayed for users with the AAE\_Robotic\_Interface\_Admin role.

The help text has been removed in the dialogue box for the field of a new variable in the **use as input** selection. Previously the help text displayed inaccurately that user-defined variables were accepted.

Editing time values now operates as expected. Previously when running a task and using the backspace key to edit the time value in a form, the PM or AM data switched before continuing to delete values.

## Limitations

Users can experience an error when running a bot within ten minutes of an edit to the scheduler user or device pool, configured to the bot. It is expected behavior for the system to take up to ten minutes to recognize edits made to these configurations.

Workaround: After making changes to the device pool or the scheduler user, select the process in the **Manage** tab and click **Edit > Save** for **global scheduler**. This manual refresh will immediately override the cache with your new changes. [Configure scheduler user for Automation Co-Pilot](#) on page 3413

Service Cloud case ID: 01983535

Disable Chrome storage partitioning for embedded

Users running Automation Co-Pilot through an embedded widget or Chrome extension must disable third-party storage partitioning in Chrome settings. See, [Disable third-party storage partitioning](#) on page 3359

Service Cloud case ID: 02088676, 02089559

## Updates to the interface

The following demonstrates interface changes displaying in v31.

**Automation Co-Pilot**

Move a process automation to another folder directly from the existing location within the private space. [Move a process to another folder](#)

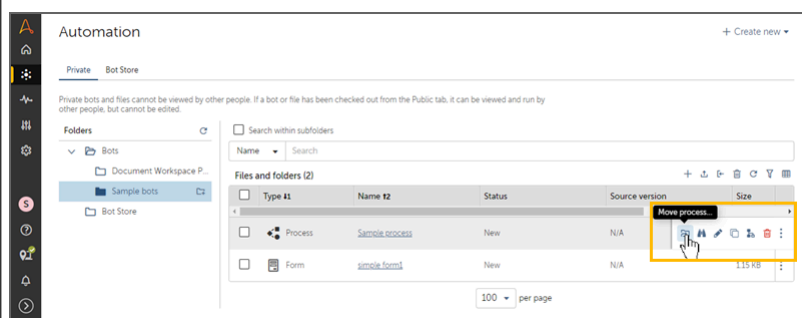

The screenshot shows the Automation Co-Pilot interface with a table of files and folders. The table has columns for Type, Name, Status, Source version, and Size. A yellow box highlights the 'Move process...' option in the context menu for a process named 'sample process'.

Type	Name	Status	Source version	Size
Process	sample process	New	N/A	
Form	sample form	New	N/A	115 KB

### Automation Co-Pilot

You can assign a user group based on role or team when creating a new Process task.  
[Select user group for process task](#)

**Task: Process**

Executes a process 🔗 Preview process

**⚠️ Element name**

ProcessTask  
Used only as internal reference during design and must be unique within this process

Task name (x)

Hide this task from users

Select process

Public folder Private folder

Adding new process task for UI Browse

**Request assigned group**

Role Team Variable

Choose

Data privacy tag (optional) (x)  
Used only as an additional hidden field that can be searched for Data Privacy purposes. Variables will be populated at runtime

Input values

The thumbnail in the canvas of the image element is interactive and can be clicked to open the file finder or receive a file when dropped onto the element in the canvas. [Improved image file upload](#)

sample form
Preview Cancel Save

Form

Layout

- Column
- BlankSpace
- Button
- Checkbox
- Date
- Document
- Dropdown
- Dropdown Multi-Select
- Dynamic Area
- Hyperlink
- Image
- Label
- Number
- Password
- Radio Button
- Rich Text Editor
- Select File
- Select Folder
- Snapshot
- Table
- Text Area
- Text Box
- Time

Form title

Image

Select File

Properties Form rules (0)

**Properties - Image** Reset Delete

**Element settings**

Element ID  
Image0

Element label  
Image

**Formatting**

Height  
64

**Help text option**  
 Hint below field 30 characters max

**Tool tip** 200 characters max

Select image file to upload Select File

This is useful for showing default images when working with web-forms

## Document Automation and IQ Bot v.31 release

Review what's new and changed, and the fixes and limitations in Document Automation and IQ Bot for the v.31 release.

### Document Automation

What's new
<p>Enable or disable external service connection for using generative AI capability in Document Automation Cloud instances based on region of deployment</p> <p>Administrators can now enable the generative AI capability for Document Automation in the Control Room with a cloud license by navigating to <b>Administration &gt; Settings &gt; Document Automation Settings</b>. You have an option to select the region based on your region of deployment and choose between US and EU.</p> <p>When this setting is enabled, Professional Developers can create learning instances and process documents using Google Document AI, Google OCR, and Microsoft OpenAI services.</p> <p><a href="#">How can I enable the generative AI (GenAI) feature in Document Automation on page 3711   Settings on page 1789</a></p>
<p>RegexExtract action in validation rules</p> <p>You can now use the <b>RegexExtract</b> action in validation rules for table and form fields. When a value is extracted from a document, this feature allows users to apply a regular expression (regex) to the extracted value to retrieve a specific substring. It extracts only the first match found in the value based on the regex pattern.</p> <p><a href="#">Validation rules in Document Automation on page 3651   Using regex extract action in validation rule on page 3655</a></p>
<p><b>Advanced training settings</b> option in Document Automation</p> <p>Using <b>Advanced training settings</b> on the validation page you can now:</p> <ul style="list-style-type: none"> <li>• Adjust or re-map the table fields as required.</li> <li>• Set primary column for row identification.</li> <li>• Add an end of table indicator value for the system to stop extraction after the value is reached in a table field.</li> </ul> <p>These updates are saved and applied to each document processed subsequently.</p> <hr/> <p><b>Note:</b> To save these settings, you must submit the document.</p> <hr/> <p><a href="#">Using advanced training settings on page 3665</a></p>

What's changed
<p>Extended language support for Google Custom Document Extractor (CDE)</p> <p>We now support more than 70 languages for document extraction using Google CDE.</p> <p><a href="#">Document Automation support for Google Custom Document Extractor (CDE)</a> on page 3704</p>
<p>Notifications for your Document Automation license consumption</p> <p>If you have enabled notifications, you will receive a notification for your Document Automation license consumption when 80% of your licenses is consumed.</p> <p>You can use this feature to plan for additional licenses.</p> <p><a href="#">Understanding licenses in Document Automation</a> on page 1410</p>

Fixes
<p>When a user clicks on the empty space of the document for normalized value for multiple fields, the field values no longer change.</p> <p>Previously, the value was changed when a user single clicked on the empty space of the document. As a result, the value might be changed accidentally without noticing the behavior.</p>
<p>With improved heuristic feedback model, the extraction now works properly and creates a cluster for certain fields in cases where the previous mappings contain non-English characters, such as Arabic characters or text with single quotes (').</p> <p>Service Cloud case ID: 01981332, 01981088</p>
<p>The message for updating document data in the package is now localized according to the selected language. Additionally, the localized custom message is translated according to the selected language for the Google Document AI provider.</p>
<p>For unstructured documents in validator page, when a user clicks a field, the correct page is now opened in the document with the relevant information for that field or search query.</p>
<p>When you upload a JSON file with incorrect <b>parserFields</b> values when configuring a parser, the upload process no longer fails, and shows an appropriate error message.</p>
<p>During parser configuration, the <b>Configure parser</b> page now displays page content in the selected language.</p>
<p>When a user processes a multi-page document containing headerless tables with Google Document AI as the provider, all the valid data is now extracted from all the pages.</p>
<p>While creating or editing a learning instance, when a user updates any field label value, the system restricts the user from entering a value not more than 200 characters.</p> <p>Previously, in such cases, the system allowed the user to enter a value of more than 200 characters, despite the character limitation. And, when the user tried to save the updates, an error message on the character limit was displayed.</p>
<p>No duplicate data is now extracted with heuristic feedback using Google Vision OCR.</p>
<p>Heuristic feedback is now enabled for the Google Document AI provider in On-Premises deployments.</p>



**Fixes**

When a user selects a language in the Automation Co-Pilot interface, the auto-fill option label now updates per the selected language during validation.

**Limitations**

After adding validation feedback using the **Advanced training settings**, the end of table indicator might not be detected for improved table detection if it is a word within a line.

For example, if **Total Amount USD** is a line segment, selecting the **Total** only for the end of table indicator can cause the indicator not to be detected for future documents.

**Limitations from previous releases**

When a document rule contains different datatypes in **then** condition, you might get the wrong error message.

Workaround: If there are multiple fields in the action with different datatypes, structure the document rule such that there is a separate action for each field.

## IQ Bot

**Fixes**

After validation, document that is marked as invalid is shown in the relevant invalid output folder when project ID is undefined in the API and no longer goes missing from the invalid folder.

Previously, users were not able to find and trace the invalid documents after validation and was impacting the document extraction.

Service Cloud case ID: 01960308, 01998792

## Bot Insight v.31 release

Review what's changed and the fixes and limitations in Bot Insight for the v.31 release.

### What's changed

Share custom published dashboards across users (Service Cloud case ID: 00746222)

You can now share the custom published dashboard across users if you have **AAE\_BI\_Admin** or **AAE\_Bot Insight Expert** role and have folder level permission to access the published dashboards. This helps to re-use the work and effort of a user by other users.

Enhanced security by disabling usage of angular brackets in naming dashboards

Added functionality to prevent usage of angular brackets (< or >) in dashboard or widget names. In **Analyze** package, the session or transaction names also do not allow angular brackets.

## Fixes

When a bot deployment fails, the Bot Insight **Operations** dashboard now shows the bot status as only **RUN\_FAILED**.

Previously, the dashboard showed the bot status as either **FAILED** or **RUN\_FAILED** for the same bot at different times.

Service Cloud case ID: 01974988.

You can now retrieve data using Bot Insight APIs in Power BI.

Previously, due to security reasons, some of the Bot Insight APIs were blocked for external use.

Service Cloud case ID: 00667286.

## Limitations

In the dashboards, when you apply widget level filters, the results on the charts does not render on the interface properly. This occurs because the labels on the chart overlap when there are significant variations in the values, some being very high and others being low (whose values are very near to each other). To overcome this issue, perform the workaround provided below.

Workaround:

1. Add the same widget twice to the dashboard.
2. In the first widget, apply the filter by selecting **Range**.
3. Provide the lower range values and click **Apply**.
4. Save the dashboard.

You will now see all the lower values that were highlighted and the higher values are not seen.

5. In the second widget, apply the filter by selecting **At least** option and provide a value which is higher than all the lower values.
6. Save the dashboard.

You will now see the higher values only.

Service Cloud case ID: 00719935.

## Automation 360 v.30 Release Notes

Release date: 3 October 2023

Review the top 5 features in this release and view other new features and exciting enhancements for Automation 360 v.30 release.

- Build 19688: Automation 360 (Cloud)
- Build 19678: Automation 360 (Cloud-Sandbox)
- Build 19688: Automation 360 (On-Premises) and IQ Bot (On-Premises)

We have released updated builds for fixes after the Automation 360 v.30 builds, which were On-Premises Build 19621 and Cloud-Sandbox Build 19596. For information about the fixes in the updated builds, see [Updated release builds](#) on page 45.

### Highlights of this release

Here are the top 5 features in the v.30 release:

Data extraction using generative AI

Extract data using generative AI's out-of-the-box solution: Generative AI's data extraction provides an easy-to-implement solution that simplifies the process of building custom models. With enhanced accuracy and seamless integration, a Document Automation admin can extract data from a supply chain and free-form text documents to streamline operations and improve efficiency.

See [Document Automation data extraction using Generative AI](#) on page 3709.

Generative AI packages

Use our new Generative AI package containing native integrations with hyperscaler LLMs: With the Generative AI package, developers can easily use large language models (LLMs) within Automation 360 to build out their automations. Supported LLMs include:

- Google Vertex AI
- Azure OpenAI
- OpenAI

See [Generative AI packages](#) on page 2626.

Developer experience enhancements

Use automation templates to quickly build automations: Professional and Citizen developers can quickly and easily build automations by selecting from a list of predefined templates. Additionally, Professional developers can create custom templates to build automations for specific business use cases.

See [Templates](#) on page 2212.

Improve productivity from a simplified and more intuitive recording experience: Professional and Citizen developers can now start a recording directly from the business application. You no longer need to identify the target business application from a list of application titles opened on a local machine. Additionally, you gain enhanced real-time visibility and control of the recording. You can:

- Review recorded actions and images of the recorded UI elements.
- Traverse through those recorded actions.
- Take actions in the midst of the recording.

[Simplified recording experience](#) on page 2951

---

**Important:** The simplified Recorder feature is not available out of the box and can be enabled on an on-demand basis. Contact your Automation Anywhere Account team for assistance.

---

Use the Automation Command Center personalized homepage: Professional and Citizen developers can now use the Automation Command Center (ACC) to quickly access automations from a personalized homepage. Automation information is presented on a concise and easily accessed dashboard, which also includes direct links to the Pathfinder Community and AAU for any additional help.

See [Automation Command Center](#) on page 2041 | [ACC home page for Pro and Citizen Developers](#) on page 2044.

Improve troubleshooting with ability to log user-defined variables: Professional developers can now log user-defined variables to a log file to quickly diagnose and fix any automation issues that might occur.

See [Log variables to file action](#) on page 2783 | [Example of using Custom selection option in Log variables to file action](#) on page 3287.

Multi-user processes with approvals

Automate complex processes with hand-offs and approvals in a single process: Using Process Composer, process builders can easily automate complex processes that span across multiple users and require complex hand-offs (such as group approval) in a single process.

## Enterprise security updates

See [Approvals in Automation Co-Pilot](#) on page 3402.

Customize system roles for increased cybersecurity protection: Based on your organization's requirements, you can now define and configure customized roles with greater granularity to align permissions using the principles of least privileges. You are no longer restricted to using predefined system roles provided by Automation 360.

See [Roles](#) on page 1748.

Configure network proxy for outgoing communication from the Control Room: The Control Room now supports the ability to configure a network proxy. For example, a Control Room admin can configure a network proxy to enable communication between the license module in the Control Room and a Cloud-hosted license server.

See [Configure forward proxy settings](#) on page 1812.

OAuth 2.0 support for SaaS application: With centralized token lifecycle management and OAuth connections, shared or user-specific OAuth tokens are securely stored in credential vaults. These tokens are retrieved during automation runtime when you configure OAuth-based authentication. The Control Room validates the refreshed tokens before the automation runs.

See [Configure OAuth connections in Control Room](#) on page 1889.

OAuth 2.0 support for REST Web Services: The REST Web Services package now supports OAuth 2.0 authentication using a centralized OAuth token from the Control Room. Professional developers can integrate any third-party applications requiring OAuth 2.0 authentication using REST APIs while complying with the organization's security standards and policies.

See [REST Web Service package](#) on page 2961.

## Updated release builds

- We have released an updated Build 19688 (Cloud and On-Premises) which contains the following:
  - Fix for an issue in Document Automation when validation rules failed in related table rows.

- (Service Cloud case ID: 02089847)
- Fix for frequent device connectivity issues when the browser or Bot Runners were not restarted for a long period.  
(Service Cloud case ID: 02086704, 02088839, 02005258, 02087429, 02087145, 02089861, 02087158, 02087877, 02089091, 02091974)
- Fix for IQ Bot security vulnerability issues. For more information, click the release download link and view the Security & Compliance reports at [A-People Downloads page \(Login required\)](#).
- We have released an updated Build 19678 (Cloud and Cloud-Sandbox) that includes a fix for the Apache ActiveMQ remote code execution vulnerability. For more information, see [Apache ActiveMQ Remote Code Execution Vulnerability CVE-2023-46604 \(A-People login required\)](#).
- We have released an updated Build 19678 (On-Premises) which contains the following:
  - Fix for the Apache ActiveMQ remote code execution vulnerability. For more information, see [Apache ActiveMQ Remote Code Execution Vulnerability CVE-2023-46604 \(A-People login required\)](#).
  - Fix for cache-related issues. Ensure that you have initialized the Apache Ignite cache after installing Build 19678.  
To initialize the Apache Ignite cache, restart all your Automation 360 virtual machines and nodes after installing the build.
- Fix for a checkout and export issue after updating bot with more meta data when folder name and bot names are similar.  
(Service Cloud case ID: 02085658, 02086676, 02087581, 02087873, 02087885, 02087706)
- Fix for Automation Co-Pilot issue for not displaying process with external dependencies on bot in the process editor.  
(Service Cloud case ID: 02087219, 02087722, 02087795, 02087354, 02087749, 02087942, 02087591, 02087593, 02088270, 02088622, 02088698)
- Fix for Automation Co-Pilot issue for not displaying process created from the learning instance in the process editor.  
(Service Cloud case ID: 02087749, 02087795)
- Fix for Automation Co-Pilot issue for not being able to submit a request using a form with validation rules built-in.  
(Service Cloud case ID: 02087219, 02087722, 02087795, 02087354, 02087749, 02087942, 02087591, 02087593, 02088270, 02088622, 02088698, 02088396)
- We have released an updated Build 19669 (Cloud and Cloud-Sandbox) which contains the following:
  - Fix for a checkout and export issue after updating bot with more meta data when folder name and bot names are similar.  
(Service Cloud case ID: 02085658, 02086676, 02087581, 02087873, 02087885, 02087706)
  - Fix for Automation Co-Pilot issue for not displaying process with external dependencies on bot in the process editor.  
(Service Cloud case ID: 02087219, 02087722, 02087795, 02087354, 02087749, 02087942, 02087591, 02087593, 02088270, 02088622, 02088698)
  - Fix for Automation Co-Pilot issue for not displaying process created from the learning instance in the process editor.  
(Service Cloud case ID: 02087749, 02087795)

- Fix for Automation Co-Pilot issue for not being able to submit a request using a form with validation rules built-in.

(Service Cloud case ID: 02087219, 02087722, 02087795, 02087354, 02087749, 02087942, 02087591, 02087593, 02088270, 02088622, 02088698, 02088396)

- We have released an updated Build 19650 (Cloud and Cloud-Sandbox) that includes fixes related to caching.
- We have released updated Build 19640 (Cloud) which contains the following:
  - Fix for an issue that caused certain forms, variable mapping and bot paths to break during process import.
  - Fix for an issue where after deleting one of the element in a process will result in deleting the completed element and replacing it with Go to element.

(Service Cloud case ID: 02002808)

- Fix for an issue where API Task runs were not updating their status in the Co-pilot widget.
- Fix for an issue where APIaaS Devices were inadvertently removed when updating the API Device pool due to a stale UI.
- Fix for an issue when (for a few instances) importing bots from one Control Room to another resulted in an error.

(Service Cloud case ID: 02086022)

- Fix for an issue where users with specific roles in existing teams could create requests but were unable to access tasks within those requests.

---

**Note:** For documentation on previous builds of this release, see the PDFs available on this page: [Automation 360 Release Notes \(build versions\)](#).

---

## What's new and changed in each product

Navigate to the following pages for details on all the updates (what's new, changed, fixed, and limitations) in each product:

<p><a href="#">Automation Workspace v.30 release</a> on page 48</p> <ul style="list-style-type: none"> <li>• <a href="#">Updating to v.30 release</a> on page 60</li> <li>• <a href="#">Migration updates for v.30 release</a> on page 61</li> <li>• <a href="#">Remote agent 2.3.3.29 updates</a> on page 62</li> <li>• <a href="#">Updates to the interface</a></li> </ul>
<p><a href="#">CoE Manager v.30 release</a> on page 67</p>
<p><a href="#">Automation Co-Pilot for Business Users v.30 release</a> on page 67</p> <ul style="list-style-type: none"> <li>• <a href="#">Updates to the interface</a> on page 72</li> </ul>
<p><a href="#">Document Automation and IQ Bot v.30 release</a> on page 73</p> <ul style="list-style-type: none"> <li>• <a href="#">Updates to the interface</a> on page 78</li> </ul>
<p><a href="#">Bot Insight v.30 release</a> on page 79</p>

[Package SDK v.30 release](#) on page 80

[Process Discovery Release Notes](#) on page 983

## Automation Workspace v.30 release

Review what's new and changed, and the fixes and limitations in Automation Workspace for the v.30 release.

**Note:** Information about updates (such as what's new, changed, fixes, and limitations) is available on -specific pages. To access these pages, navigate to [Package updates overview](#) on page 835 > <-name> updates.

For a consolidated list of packages updated in this release, see [Packages updated in v.30](#) on page 62.

### What's new

#### Control Room, devices, and Bot Agent

New permissions for roles

The following new roles have been added:

- **Administration**
  - **View Settings:** Allows users to view all the settings in the Control Room. However, users cannot edit the settings.
  - **Manage Settings:** Allows users to edit the settings in the Control Room.
  - **View and manage compliance reports:** You can grant permissions to users to view, create, and download compliance reports for users.
- **OAuth connections**
  - **View connections:** Allows users to view the configured OAuth connections and their attributes.
  - **Manage connections:** Allows users to create, edit, and delete OAuth connections.
- **Global values**
  - **View and manage global values:** Allows users to view, create, edit, and delete global values.
- **Devices**
  - **View all bot runner users:** Allows users to view and add all run-as-users (unattended Bot Runner users) when creating a role, running bots, or scheduling bots.
- **Bots**
  - **Download exported files:** Allows users to download exported bot files.
  - **Restore from git:** Allows users to restore bots and files from Git.

[Feature permissions for a role](#) on page 1749



Control Room, devices, and Bot Agent
<p>Windows Server 2022 is now supported for On-Premises installation</p> <p>You can now successfully install the Windows Server 2022 Datacenter edition (with all the existing functionalities) on the Automation 360 On-Premises Control Room.</p> <p><a href="#">Operating system, environment, and platform supported for Control Room</a> on page 1194   <a href="#">Bot Agent device requirements</a> on page 1340</p>
<p>Integrate CyberArk properties in bot automation (Service Cloud case ID: 01852428)</p> <p>You can enter the property set in credential attributes using the CyberArk properties to integrate the attributes in the bot automation. For example, if you want to use a username in the format <code>domain\username</code> where the domain is stored in the CyberArk property called <b>Address</b> and the username is stored in the CyberArk property called <b>UserName</b>, you can then enter the property set in the format <code>\$\$Address\$\$\\$\$UserName\$\$</code> in the credential attribute and use this attribute in the bot automation. The domain and username values in this property set will be replaced with the corresponding values from the secret response.</p> <p><a href="#">Create locker</a> on page 1866   <a href="#">Create credential</a> on page 1864</p>
<p>Select Control Room services to run at startup in Linux environment</p> <p>You can optimize application process utilization on your device by selecting the Control Room services that you want to run automatically at startup during the On-Premises installation in a Linux environment.</p> <p>Additionally, you can use this option to disable the dependent services. For example, Automation Co-Pilot uses the storage service. By disabling the storage service, you are also effectively disabling Automation Co-Pilot.</p> <p><a href="#">Installing Control Room on Linux</a> on page 1293</p>
<p>Easily reference team or group with User group variable type</p> <p>You can use the new <b>User group</b> variable type to reference a team or a role inside a process and share it across different environments without having to edit the process.</p> <p><a href="#">Global values</a> on page 2350   <a href="#">Create a global value</a> on page 2351</p>
<p>Automatically purge audit log entries on On-Premises deployments</p> <p>Configure your Control Room settings to automatically purge (delete) audit log entries that are older than a specified period. By default, audit logs older than 15 months are automatically deleted for new On-Premises deployments. This feature is disabled when you update from a previous release to v.30 or later releases. For example to save storage space, you can automatically delete audit log entries for a limited period or delete any historical audit log entries.</p> <p><a href="#">Settings</a> on page 1789   <a href="#">Audit events list</a> on page 2144</p>
<p>French language support for notifications</p> <p>As a Control Room administrator, you can now set French as a secondary language for notifications and view information in your local language. With this enhancement, the Control Room sends all notification emails (instant and email reports) in both primary (English) and secondary (French) languages.</p> <p><a href="#">Manage languages for notifications</a></p>

<b>Control Room, devices, and Bot Agent</b>
<p>API key expiry information to manage your automations seamlessly (Service Cloud case ID: 01904811, 01960297)</p> <p>To run your automation seamlessly, you can use the API key expiry information to renew the API key before it expires.</p> <p><a href="#">Create API key generation role</a> on page 1765   <a href="#">Users</a> on page 1737</p>
<p>Notifications for your Document Automation license consumption</p> <p>If you have enabled notifications, you will receive a notification for your Document Automation license consumption when the following criteria are met:</p> <ul style="list-style-type: none"><li>• When 90% of your licenses are consumed</li><li>• When 95% of your licenses are consumed</li><li>• When 99% of your licenses are consumed</li><li>• When 100% of your licenses are consumed</li></ul> <p>You can use this feature to plan for additional licenses.</p> <p><a href="#">Understanding licenses in Document Automation</a> on page 1410</p>
<p>Import intermediate certificates in Control Room installed on Linux</p> <p>You can import intermediate certificates when you install the Control Room on Linux.</p> <p><a href="#">Intermediate certificates</a> on page 1387   <a href="#">Installing Control Room on Linux</a> on page 1293</p>
<p>Audit log events for OAuth connections</p> <p>The following audit log events are logged for OAuth connections:</p> <ul style="list-style-type: none"><li>• Bulk delete OAuth connection</li><li>• Create OAuth connection</li><li>• Delete OAuth connection</li><li>• Update OAuth connection</li></ul> <p><a href="#">Audit events list</a> on page 2144</p>
<p>Automation Command Center for Pro and Citizen Developers</p> <p>Automation Command Center (ACC) is now available for Pro and Citizen Developers. As a key component of automation lifecycle management, Pro and Citizen Developers now have a personalized and centralized view to quickly access their automations. Additionally, help is available with direct links to other developer resources, such as Pathfinder Community and Automation Anywhere University.</p> <p><a href="#">ACC home page for Pro and Citizen Developers</a> on page 2044</p>

**Control Room, devices, and Bot Agent**

## Code analysis visibility enhancements in Bot editor

The following enhancements have been added to code analysis to improve the visibility of code quality in the Bot editor for Pro and Citizen Developers.

- A new indicator for the flow and list canvas views shows which command actions have code analysis violations, enabling Pro and Citizen Developers to quickly see and correct violations in their automations. Code quality is enhanced when developers can easily determine violations and adhere to best practices when they are developing automations.
- A new code analysis policy option on the Bot editor drop-down menu (access from the three vertical ellipses in the upper right of the Bot editor) allows the developer to view the code analysis policy that is applicable to the automation file. This assists the developer because they can see all applicable best practice rules without needing to leave the Bot editor and to view the policy in the Policy Manager page.

[Checking out code analysis results](#) on page 2185 | [Bot editor for creating bots](#) on page 2228

**Packages, actions, and Bot editor**

## Accelerate and simplify the development of automation using templates

Automation 360 provides templates that you can use to build new automations quickly. These templates contain prebuilt automation code structures that you can select based on your business processes. Prebuilt code structures reduce errors and enforce coding best practices. Using predefined templates, Citizen Developers can jumpstart creating automations for their business use cases, and professional developers can develop more complex business cases. Additionally, developers can perform various operations:

- Manage templates (check-in, check-out, save, edit, and delete)
- Review version history, dependencies, and references
- Import and export templates
- Access private and public workspaces in the Control Room

[Templates](#) on page 2212

## Packages displayed in sorted order in Bot editor

When you use the actions menu (vertical ellipsis at the top-right) to select **Packages** in the Bot editor, packages now display in sorted order, making it easier to identify them. Packages are sorted on the **Name** field instead of the **Short name** field.

Packages, actions, and Bot editor
<p>Packages sorted alphabetically within Bot editor (Service Cloud case ID: 01766378)</p> <p>For easier navigation, professional developers can quickly find packages and actions that are now sorted alphabetically at the following places in the Bot editor:</p> <ul style="list-style-type: none"><li>• Actions pane</li><li>• When you use the actions menu (vertical ellipsis at the top-right) to select <b>Packages</b>, the list of used and available packages displays alphabetically.</li><li>• When you use an <b>If</b>, <b>Else if</b>, <b>Loop</b>, or <b>Wait</b> for condition in a bot, the conditions and the iterators display alphabetically.</li></ul>
<p>Use Microsoft 365 Outlook as trigger to start a bot</p> <p>You can use Microsoft 365 Outlook as a trigger to start a bot when you send or receive emails.</p> <p><a href="#">Add Microsoft 365 Outlook trigger</a> on page 2295</p>
<p>Microsoft Exchange Server 2019 supported (Service Cloud Case ID: 01952966)</p> <p>Microsoft Exchange Server 2019 is now supported in email trigger. Therefore, you can select <b>EWS Server &gt; Exchange Server 2013</b> for any of the Exchange Server (2013, 2016 or 2019) versions.</p> <p><a href="#">Using Email Trigger in Trigger loop Handle</a> on page 3138</p>
<p>New Legacy Loop behavior option</p> <p>For bots that were created using the Loop action in Automation 360 v.26 or earlier releases, you can now enable the <b>Legacy Loop behavior</b> option from the <b>Administration &gt; Settings</b> to iterate the loop based on the specified value. When you enable this option and either increment or decrement the variable value in the end condition, loop iterations will not vary dynamically based on the new value generated.</p> <p><a href="#">Settings</a> on page 1789</p>
<p>Debug enhancements</p> <ul style="list-style-type: none"><li>• To follow the standard Debug convention across different integrated development environments, the Debugger tool has been renamed to Debug.</li><li>• When you start debugging, in the Bot editor, you can now see a header bar below the bot name that displays the name of the bot being debugged. The header bar displays <b>Now debugging</b> and the bot name afterward. For example: <b>Now debugging: MSGBot5</b></li><li>• When you start debugging a bot, the <b>Actions</b> panel on the left side of the Bot editor automatically collapses. This helps in providing more horizontal area to view the actions added in the Bot editor while debugging.</li></ul> <hr/> <p><b>Note:</b> Once the debugging stops, the <b>Actions</b> panel expands again.</p> <hr/>

Building and running bots
<p>Auto-purge setting in workload management (Service Cloud case ID: 01978674)</p> <p>You can now delete the completed or successful work items automatically. You can set the number of days of when to automatically delete the processed work items thereby freeing up Control Room space to process more work items (non-completed).</p> <p><a href="#">Purge work items</a>   <a href="#">View queue details</a> on page 2011</p>
<p>Automatically purge exported work items (Service Cloud case ID: 01288234, 01972944, 01755832, 00910693, 00802309, 01948250, 01981477)</p> <p>The Control Room automatically deletes exported zip files which are older than 30 days freeing up valuable Control Room space. When you export a bot or work item, these exported zip files are available on the <b>Historical activity</b> page as download links (which require a lot of Control Room space to store).</p> <p><a href="#">Export bots</a> on page 2033</p>
<p>Change scheduled activity ownership</p> <p>You can change or transfer the ownership of a scheduled activity to any other Control Room user.</p> <p><a href="#">Change ownership of scheduled activity</a> on page 2134</p>
<p>API Tasks for creating automations</p> <p>You can now create API Task automations in Automation 360 Cloud. API Tasks interact with an application directly via API. These API Tasks run on Cloud devices to provide better latency and faster processing time.</p> <p>API Task is a new feature in v.30 and has limited availability in the United States (US East, US West, and US Sandbox) regions. To enable this feature, contact your customer support manager (CSM).</p> <p><a href="#">#unique_158</a></p>
APIs and integrations
<p>Manage activity API</p> <p>Use the new <code>/v3/activity/manage</code> API to stop, pause, or resume an execution by specifying the execution ID.</p> <p><a href="#">Bot Execution Orchestrator API</a></p>

## What's changed

Control Room, devices, and Bot Agent
<p>Administer lockers</p> <p>You can grant permissions to roles to view all lockers and edit some of the locker settings. For example, users can change the owner of a locker.</p> <p><a href="#">Feature permissions for a role</a> on page 1749</p>
<p>Enhancement to system-defined roles</p> <p>You can create your own roles based on your organizational requirements instead of using system-defined roles. You are no longer restricted to using the system-defined roles.</p> <p><a href="#">System roles</a> on page 1768   <a href="#">Feature permissions for a role</a> on page 1749</p>
<p>Enhanced session time-out setting (Service Cloud case ID: 00658277, 00755230, 00658277, 01258466, 01961046, 01964607)</p> <p>You can now set the session time-out value based on your requirements to one of the following values: 10 minutes, 20 minutes, 30 minutes, 40 minutes, 50 minutes, 1 hour, 2 hours, 4 hours, 8 hours, 12 hours, 24 hours, or 7 days. Users are automatically signed out from the Control Room browser session after the specified minutes of inactivity.</p> <p><a href="#">Settings</a> on page 1789</p>
<p>Workload management roles and permissions (Service Cloud case ID: 01945003, 01979884, 02005334)</p> <p>You no longer need to use system-defined administrator roles with Workload management roles and permissions. You can create custom roles with limited or no access to administrative permissions while adhering to your organization's security policies.</p> <p><a href="#">Feature permissions for a role</a> on page 1749   <a href="#">Workload permissions</a> on page 3988</p>
<p>Change in Document Automation license name</p> <p>The <b>Classifier (Number of pages)</b> license is renamed to <b>Document Classifier (Number of pages)</b>.</p> <p><a href="#">Understanding licenses in Document Automation</a> on page 1410   <a href="#">Manage licenses</a> on page 1782</p>
<p>Disabled package alert</p> <p>If you have used an action from a package that is disabled or you no longer have access to, an alert is displayed on the bot editor screen.</p> <p><a href="#">Packages</a> on page 1898</p>
<p>Enhanced device roles and permissions</p> <p>You no longer need to use system-defined administrator roles to manage device pools. You can create custom roles with limited or no access to administrative permissions while adhering to your organization's security policies. Users with the custom role containing the <b>Administer ALL device pools</b> permission can now manage device pools.</p>

**Control Room, devices, and Bot Agent**

Configure **Legal Disclaimer** timeout (Service Cloud case ID: 01968771, 01964881)

Administrators can now configure **Legal Disclaimer** timeout screen. Therefore, RDP-based deployment sessions will now retry device access based on this configured setting.

[Configure RDP-based deployment for multi-user devices](#) on page 1877

**Fixes**

This fix applies to bots and files created in Build 19688. For your existing bots (created in previous builds), perform the workaround provided in [Workaround for checkout and export issue](#).

When a bot or any of its parent directories share the same name, you can now perform the check-in, check-out, bulk check-in, bulk check-out, import, and export operations without any encountering errors.

Previously, some of these operations resulted in errors.

Service Cloud case ID: 02085658, 02086676, 02087581, 02087873, 02087885, 02088908, 02087706

In Build 19596 and later, the scheduler functionality is now optimized to include improved query performance for identifying the next set of schedules and minimizing database deadlocks when the database restarts or the Control Room is updated.

Previously, due to these database deadlocks, the schedules misfired, and the schedule activity page failed to load.

Service Cloud case ID: 01922240, 1972854, 01947419, 01947801, 01948163, 01950059, 01955783, 01970533, 01998902, 01998908, 01998922, 01998932

When you check out a bot with a dependent bot in another folder and you do not have access to that dependent bot folder, an appropriate error message is now displayed for the check-out failure.

Previously, bot check out was not completed, and no success or failure message was displayed.

Service Cloud case ID: 02090103

In a window variable, when you select a browser window with its title as case-insensitive, add the same variable to the watched variables list in the Debugger, and invoke the debugger, the **Case sensitive** option for the browser title remains deselected.

Previously, when the debugger was invoked, the **Case sensitive** option was selected by default.

An expression or property related to a specific type of variable in an action is now displayed in the drop-down list. Previously, the last property or expression in the list was hidden.

When you use two separate loop or If actions, one with a VBScript condition and the other with a JavaScript condition, respectively, and run the bot, the bot now runs successfully.

Service Cloud case ID: 01954473

When you update your Control Room version to Automation 360 v.30 with Bot Agent at v.28 build 21.240.20182, the actions now successfully recognize the window titles even if capital letters were used in window variables with **Case sensitive** option disabled.

Service Cloud case ID: 01994346

A bot no longer encounters an error when you view Dictionary type variables in debug mode.

Service Cloud case ID: 01994177, 01986284, 01986574

Schedules now run correctly during the Daylight Saving Time (DST) time zone.

Previously, weekly schedules ran every minute, resulting in multiple triggers during DST, and in turn impacted the actual schedules.

Service Cloud case ID: 01961418, 1961463, 1961447, 1961464, 1961221, 1961111, 01961464, 01961471, 01961517, 01961418, 01961119, 01961236, 01963106, 01961071

When the number of schedules listed on the **Scheduled activity** page is less (for example, 5 or 6 schedules), the **Scheduled** tab no longer shows a query timeout error message.

Previously, the **Scheduled** tab displayed the following error message: An unexpected problem occurred.

When you disable a package, the **Update -Package Version** page (**Administration > Bot Update > Update Bots > Package version**) no longer shows an error message. Additionally, you can check out the process and process document in private mode.

Previously, when you disabled a package, the **Update -Package Version** page showed an error message during check out.

The issue regarding missing packages in the Control Room is now fixed. For more information, see [A360 | Packages missing from the Control Room](#)

Service Cloud case ID: 01992801

When you configure auto-login settings and select the **Reuse an existing session, if available** option, the bot is now deployed through an existing session, and the connected device is no longer logged off.

You will see correct start and end timestamps for bot failures on the **Historical activity** page.

Previously, the timestamps were displayed incorrectly in such scenarios.

Service Cloud case ID: 01925919



<p>You will no longer view the <b>Unlock locked bots</b> and <b>Set production version of bots</b> permissions in your Control Room instances that are using the Single sign-on (SSO) or Active Directory authentication.</p> <p>Previously, you were able to view these permissions in such Control Room instances.</p> <p>Service Cloud case ID: 01952796</p>
<p>When your server repository path (be it on file system or network drive) is unreachable, the version history remains intact and is no longer deleted.</p> <p>Previously, if the repository path was unreachable, the version history was force deleted.</p> <p>Service Cloud case ID: 01963136, 01991452, 01992999, 01996226</p>
<p>You can now import bots and packages from the Bot Store with the Bot StoreBot Store import feature successfully.</p> <p>Previously, the import failed and remained in the <b>In progress</b> status in the Bot Store downloads page.</p> <p>Service Cloud case ID: 02001442, 02002465, 02000881</p>
<p>For schedules without a device pool, when one or more active run-as user devices are unavailable or disconnected, the bot deployment fails for all the run-as users in the schedule. In such a scenario, you will only see a detailed error message.</p> <p>Previously, you were seeing two error messages: generic and detailed.</p>
<p>When you add a Work Item to the WLM queue which is already in a running state, the Work Item is processed immediately.</p> <p>Previously, the Work Item took longer time (10-15 minutes) to be processed.</p> <p>Service Cloud case ID: 02001406, 02001459</p>
<p>If you have SSO enabled and when you sign out of the Control Room, you will no longer see a message about duplicate sign in.</p> <p>Previously, a message was displayed that a duplicate sign in was detected.</p> <p>Service Cloud case ID: 01954039</p>
<p>The license expiry timestamp shows proper translations for Japanese users.</p> <p>Previously, the timestamp displayed improper translations.</p> <p>Service Cloud case ID: 01963189, 02076565</p>
<p>When you create a Workload management (WLM) automation, the corresponding audit log displays the correct Started On timestamp.</p> <p>Previously, Unix timestamp was displayed.</p> <p>Service Cloud case ID: 01964914</p>
<p>The bots now run successfully and are no longer queued when they are deployed on the default device of an unattended Bot Runner user.</p> <p>Service Cloud Case ID: 01985724, 01985720, 01985778, 01994082, 01994111, 01994155</p>

<p>The <b>Current action</b> status on the <b>In progress activity</b> page displays the correct status after updating to the latest release.</p> <p>Previously, the <b>Current action</b> status displayed incorrect information.</p> <p>Service Cloud case ID: 01996522</p>
<p>You can now create and assign a code analysis policy even it does not contain any rules within it.</p> <p>Previously, policy creation would fail with an error.</p>
<p>When you schedule multiple bots for deployment, bot deploys successfully without any issue.</p> <p>Previously, sometimes bot deployment failed with null pointer exception while retrieving the login settings of the user.</p> <p>Service Cloud case ID: 01975690, 01989463</p>
<p>You can now successfully connect to Oracle Database with SSL certificate in the Linux environment.</p> <p>Previously, connection to Oracle Database with SSL certificate would fail with an error.</p>
<p>You will now be able to add locker managers and participants when creating a locker.</p> <p>Previously, you were unable to add locker managers and participants when creating a locker.</p> <p>Service Cloud case ID: 02004160</p>

## Limitations

<p>In previous Automation 360v.30 builds (earlier than Build 19688), if your bots or any of its parent directories share the same name, you might encounter an error when you perform check-in, check-out, bulk check-in, bulk check-out, import, or export operations.</p> <p>Workaround:</p> <ol style="list-style-type: none"><li>1. Check out the earlier version of the bot. For example, consider the <code>Claims processing</code> bot that has 3 versions. If you encountered error in version 3 of the bot, check out version 2.</li><li>2. Edit the bot for your required changes.</li><li>3. Check in the bot.</li></ol> <p>This workaround is for bots created in Automation 360v.30 previous builds. This issue is fixed for bots created in Build 19688 (see <a href="#">Fix for a check out and export issue</a>).</p>
<p>When you rename a bot in the Bot editor and then start debugging, the updated bot name might not display in the header bar.</p> <p>Workaround: Close the Bot editor and then open it again.</p>

When a user with view and manage settings permissions edits the remote Git repository integration settings, an insufficient privileges error is displayed. However, the user can still edit the remote Git integration settings.

When you use the bulk package update feature to update the package version in bots, you might see errors in some actions used in the bot. However, the bot executes successfully even with these errors when deployed from Control Room or as an attended or unattended Bot Runner.

Workaround: Revert back the package version for the bots which show errors and update the package manually.

Service Cloud case ID: 01984578, 01991720, 01983265, 01994192, 02048170, 01990994, 01992484

The total notification count is displayed incorrectly in the alert summary report, that is the total notification count does not match the sum of attention needed and information notification counts.

The alert summary report displays incorrect start and end date and time.

In an On-Premises Windows environment, when you install the Control Room with any database with SSL certificate, the installation fails with an error if the keytool finds duplicate alias in the cacerts file.

Workaround:

1. List all the aliases using the keytool.
2. Find the duplicate aliases.
3. Delete the duplicate aliases using keytool command.
4. Install the Control Room.

#### Limitations from previous releases

While running a bot in debug mode, the bot will fail if the variable size is greater than 3 MB. An error message appears with the information that a variable has exceeded the 3 MB limit.

## Updates to the interface

See the following video for the updates in the interface for Automation 360 v.30 release:

The **Purge older than 15 months** option is introduced to automatically delete audit log entries that are older than 15 months.

[Automatically purge audit log entries on On-Premises deployments](#)

The **API Key details** field displays the **Expiration information** to indicate the date and time when the API key expires. Use this information to renew the API key so that you can run your automation seamlessly.

[API key expiry information to manage your automations seamlessly](#)

The **FTP/SFTP Session name** field has been renamed to **Create FTP/SFTP session**.

[New capabilities added to FTP/SFTP package](#)

Enable the **Legacy Loop behavior** option from the **Administration > Settings** to iterate the loop based on the specified value.

[Enable legacy loop behavior action](#)

Create an **OAuth connection** and store it in the Control Room. You can use this OAuth connection for the Apigee, Genesys, Rest Web Services, Salesforce, ServiceNow, and SharePoint packages.

[Packages updated in v.30](#) on page 62

Code analysis visibility enhancements in the Bot editor.

[Code analysis visibility enhancements](#)

## Updating to v.30 release

Review requirements and support information about updating your Control Room and Bot Agent for the v.30 release.

## Bot Agent updates

**Note:** This release includes an optional Bot Agent update. You can continue to run your existing bots without updating the Bot Agent. However, if you want to use the new features in Automation 360 v.30, you must update the Bot Agent available with this release.

While the Bot Agent update is optional in most of the updates rolled out for Automation 360, in environments where auto-update is enabled but auto-deploy is disabled for triggers, you need to log in to the browser session after the update is rolled out to activate the trigger listener.

For more information on updating to this release, see these resources:

- [Automatically update the Bot Agent](#) on page 1361 | [Manually update the Bot Agent](#) on page 1362
- [Compatibility with release builds](#) on page 1333

## Certified Control Room builds for direct update

You can update to the latest version of Automation 360 from the previous three releases (that is, from n–3 releases, where n refers to the latest release).

The following previous releases are certified for update to Automation 360 v.30:

- v.29 (Build 18371)
- v.28 (Build 17571, 17566, 17542, 17506)
- v.27 (Build 16685, 16667)

If you are on one of these previous releases, for information about updating, see [Update Automation 360 to latest version](#) on page 1423. If you are not on an n–3 release, update Automation 360 to one of the n–3 releases before updating to Automation 360 v.30.

## Migration updates for v.30 release

Review the fixes for migrating from Enterprise 11 and 10 versions to Automation 360 v.30.

### Fixes

<p>In Enterprise 11, if a bot was using the Send Email command in a loop to send attachments to email address that was using username as a variable, you can migrate such a bot and execute it to send email with the correct attachment.</p> <p>Previously, such a bot was sending additional attachment with each iteration.</p> <p>Service Cloud case ID: 01947234</p>
<p>You can migrate a bot that uses the Database command to read data from excel and execute it successfully.</p> <p>Previously, such a bot was reading data from excel with additional newline characters at the end of the line.</p> <p>Service Cloud case ID: 01953984</p>
<p>When you migrate a bot that uses variables in expressions, the variables are no longer tagged as unused variables.</p> <p>Previously, such variables were tagged as unused variables.</p> <p>Service Cloud case ID: 01972750</p>
<p>In Enterprise 11, if a bot is using the Image Recognition commands along with the <b>If, Else if</b>, and <b>Loop</b> commands, you can migrate the bot using the Bot Migration Wizard without encountering error.</p> <p>Previously, such a bot encountered an error during migration.</p> <p>Service Cloud case ID: 01966636</p>
<p>In Enterprise 11, if a bot is using the String Operation command and includes a backslash (\) in the <b>Replace</b> string, after migration, the bot executes properly.</p> <p>Previously, such a bot encountered an error when a backslash (\) was used in the <b>Replace</b> string.</p>
<p>Using the Bot Migration Wizard, you can now migrate bots to a repository that is hosted on Network-attached storage (NAS).</p> <p>Previously, an error encountered is such a scenario.</p> <p>Service Cloud case ID: 01977429</p>

## Limitations

The Cloud Migration Utility will be unavailable to order or use from October 11, 2023, until the end of December 2023.

Workaround: Perform one of the following actions:

- Move data manually from Automation 360 On-Premises to Cloud.  
See: [Moving from Automation 360 On-Premises to Cloud](#) on page 1494.
- Contact Automation Anywhere support: [Open a support case \(A-People login required\)](#).

## Remote agent 2.3.3.29 updates

**Important:** Starting from this release, we have moved information about updates in the Remote agent (such as what's new, changed, fixes, and limitations) to this page: [Remote agent updates](#) on page 943.

## Packages updated in v.30

Review updates to the packages in Automation 360 v.30, including the compatible Control Room and Bot Agent versions.

### October 2023 package updates

We have updated specific packages in October, after the v.30 release. For a list of these packages, see [October 2023 updates](#).

### September 2023 package updates

We have updated specific packages in September, after the v.30 Sandbox release. For a list of these packages, see [September 2023 updates](#).

## Packages updated in v.30

The following table lists packages updated for this release. Click the package version to view updates (what's new, changed, or fixed) in the package.

Package name	Version	Bot Agent version	Control Room version
Active Directory	<a href="#">3.9.0</a> on page 840	20.11 or later	8750 or later
Apigee	<a href="#">2.0.1</a> on page 843	21.222 or later	15422 or later
App Integration	<a href="#">4.13.0</a> on page 845	21.88 or later	10195 or later

Package name	Version	Bot Agent version	Control Room version
Browser	<a href="#">3.10.1</a> on page 852	21.210 or later	14140 or later
Database	<a href="#">5.1.0</a> on page 859	21.88 or later	10204 or later
DLL	<a href="#">6.10.2</a> on page 865	21.22 or later	15238 or later
Document Classifier	<a href="#">3.30.1</a> on page 899	21.98 or later	10520 or later
Document Extraction	<a href="#">3.30.24</a> on page 870	21.252 or later	19223 or later
Email	<a href="#">3.18.2</a> on page 874	21.210 or later	13980 or later
Excel advanced	<a href="#">6.16.4</a> on page 880	21.112 or later	11307 or later
Folder	<a href="#">6.8.0</a> on page 885	20.11 or later	8750 or later
FTP / SFTP	<a href="#">2.11.0</a> on page 886	20.11 or later	8750 or later
Genesys	<a href="#">2.0.0</a>	21.210 or later	14199 or later
Google Sheets	<a href="#">2.13.0</a> on page 893	20.11 or later	8750 or later
Generative AI	<a href="#">1.1.0</a> on page 888	21.240 or later	17445 or later
Image Recognition	<a href="#">3.16.0</a> on page 897	21.210 or later	14100 or later
Legacy Automation	<a href="#">6.3.2</a> on page 905	21.200 or later	13279 or later
Log To File	<a href="#">3.8.0</a> on page 908	21.134 or later	19321 or later
Mouse	<a href="#">2.15.0</a> on page 920	21.210 or later	14100 or later
Microsoft 365 Calendar	<a href="#">2.13.3</a> on page 912	20.11 or later	8750 or later
Microsoft 365 Excel	<a href="#">2.13.3</a> on page 914	20.11 or later	8750 or later
Microsoft 365 OneDrive	<a href="#">2.13.3</a> on page 916	20.11 or later	8750 or later
Microsoft 365 Outlook	<a href="#">1.1.5</a> on page 918	21.210 or later	13980 or later

Package name	Version	Bot Agent version	Control Room version
Recorder	<a href="#">2.13.6-20230802</a> on page 939	21.214 or later	14068 or later
REST Web Service	<a href="#">3.15.0</a> on page 944	20.11 or later	8750 or later
Salesforce	<a href="#">2.0.1</a> on page 946	21.222 or later	15422 or later
SAP	<a href="#">3.12.1</a> on page 948	21.88 or later	10195 or later
ServiceNow	<a href="#">2.0.1</a> on page 952	21.230 or later	16455 or later
SharePoint	<a href="#">2.1.2</a> on page 954	21.250 or later	18000 or later
Simulate keystrokes	<a href="#">4.3.0</a> on page 956	21.200 or later	13297 or later
SOAP Web Service	<a href="#">3.17.0</a> on page 958	21.240 or later	17571 or later
String	<a href="#">5.8.0</a> on page 960	20.18 or later	9130 or later
Task Bot	<a href="#">2.8.0-20230530</a> on page 963	20.174 or later	8750 or later
XML	<a href="#">3.11.0</a> on page 974	20.11 or later	8750 or later

## Packages not updated in v.30

The following table lists packages that have not been updated in the v.30 release but are compatible with this release.

Package name	Version	Bot Agent version	Control Room version
Advanced Classifier	2.1.1	21.250 or later	17953 or later
Analyze	<a href="#">2.8.0-20230420</a>	20.118 or later	8750 or later
Application	3.8.0	20.11 or later	8750 or later
Boolean	2.9.0	20.11 or later	8750 or later
Bot Migration	10.6.2	21.220 or later	15224 or later
Clipboard	3.7.0	20.11 or later	8750 or later



Package name	Version	Bot Agent version	Control Room version
Comment	2.14.0	20.11 or later	8750 or later
Credential	1.6.0	20.11 or later	8750 or later
CSV/TXT	2.12.0	20.11 or later	8750 or later
Data Table	4.8.0	20.11 or later	8750 or later
Datetime	2.12.1	20.11 or later	8750 or later
Delay	3.8.0	20.11 or later	8750 or later
Dictionary	3.12.0	20.11 or later	8750 or later
Error handler	2.11.3-20230326-1162437	20.11 or later	8750 or later
Excel basic	6.15.0	21.112 or later	11307 or later
File	6.7.0	21.98 or later	10789 or later
Google G Suite	2.8.0-20220426-235104	20.11 or later	8750 or later
Google Calendar	2.11.2	20.11 or later	8750 or later
Google Drive	2.12.2	20.11 or later	8750 or later
Hot keys	1.5.0-20230326-056200	20.11 or later	8750 or later
If	3.6.2-20230326-161713	20.11 or later	8750 or later
IQ Bot Pre-processor	3.30.1	21.98 or later	10520 or later
IQ Bot	3.30.3	21.98 or later	10520 or later
JavaScript	2.15.0	20.11 or later	8750 or later
JSON	1.4.1	21.98 or later	10520 or later
List	2.11.0	20.11 or later	8750 or later
Loop	3.7.5-20230326-15504	20.11 or later	17208 or later
Message Box	3.6.0	20.11 or later	8750 or later
Number	3.8.0	20.18 or later	9130 or later
OCR	2.12.1	21.118 or later	8750 or later
PDF	3.9.0	21.31 or later	9300 or later
PGP	3.6.0	21.88 or later	10195 or later
Ping	3.5.0	20.11 or later	8750 or later
Play Sound	2.6.0-20220426-07615	20.11 or later	8750 or later

Package name	Version	Bot Agent version	Control Room version
Printer	2.6.0	20.11 or later	8750 or later
Prompt	2.7.1	20.11 or later	8750 or later
Python Script	2.15.0	20.11 or later	8750 or later
Record	1.8.2	21.134 or later	17917 or later
SAP BAPI	2.9.0	21.2 or later	9249 or later
Screen	2.9.2	20.11 or later	8750 or later
Service	4.8.0	20.11 or later	8750 or later
Step	2.5.0-20230106-135537	20.11 or later	8750 or later
SNMP	2.7.1	20.11 or later	8750 or later
System	3.12.0	21.88 or later	10217 or later
Terminal Emulator	4.10.0	21.93 or later	10353 or later
Text file	1.6.0	20.11 or later	8750 or later
VBScript	2.19.0	21.210 or later	14100 or later
V11 Task Bot	1.14.0	20.11 or later	8750 or later
Wait	4.9.0	20.11 or later	8750 or later
Window	5.10.0	20.11 or later	8750 or later
Workday	1.2.0	21.231 or later	17076 or later

Related reference

[Periodic package updates - summary list](#) on page 836

We will be updating specific packages in the Control Room to enable you to get early access to critical updates and fixes.

[Package updates overview](#) on page 835

Packages are typically updated in Automation 360 releases as part of new Control Room builds. We also plan to release some updates between these releases for early delivery of critical updates and fixes as package-only updates.

## CoE Manager v.30 release

Review what's new in CoE Manager v.30 release.

### What's new

<p>Change opportunity to a previous or hold status</p> <p>There might be a business requirement to change the status of an opportunity back to a previous state or put an opportunity on hold for a certain period of time. This could be due a change in priorities or requirements or due to scope creep for a project. With this capability, you can move an opportunity forward to its next state, move it back to its previous state, or put the opportunity on hold until it is feasible to move it forward.</p>
<p>Track changes to deployed opportunities with change request</p> <p>You can track changes to deployed opportunities by creating a change request for that opportunity. Using change requests, you can update the automations associated with the opportunity or fix any issues. Additionally, you can view or modify these change requests. You can specify if the change request is an enhancement or an issue, provide a description, and set a priority to address the critical or high priority requests immediately.</p>
<p>Track and report automated application types in an automation program</p> <p>You can track and report on what types of applications are automated within your automation program. To maintain inventory of the applications used in the automations associated with your opportunity, you can add an application with these details: application name, version, owner, automation approach (user interface, API, database), and the automation complexity.</p>

## Automation Co-Pilot for Business Users v.30 release

Review what's new and changed, and the fixes and limitations in Automation Co-Pilot for the v.30 release.

---

**Note:** Information about updates (such as what's new, changed, fixes, and limitations) is available on -specific pages. To access these pages, navigate to [Package updates overview](#) on page 835 > <-name> updates.

For a consolidated list of packages updated in this release, see [Packages updated in v.30](#) on page 62.

---

## What's new

### Approval task element added to Process Composer

The approval task is a new element in the Process Composer that dedicates a step to the process where a selected or default user must review and approve the process before completion. By adding an approval task, a single process can streamline contributions from multiple users and complex hand-offs (such as group approvals).

- You can configure one or multiple users to approve a task. [Add Approval Task to a process automation](#) on page 3463.
- In Automation Co-Pilot, users receive relevant notifications as the status and assignment changes.
- In Automation Co-Pilot, the improved task view displays the status and contributors of tasks to quickly filter and view requested and pending approvals.

[Approvals in Automation Co-Pilot](#) on page 3402

### New User group variable type

You can use the new User group variable type to configure a single role or team into a single global value.

### Ability to start a process using input variables in Process Composer

As a Pro developer, you can create and add input variables to start a process without having to build a form as the point of entry. You define input variables directly within the process itself which is particularly useful if your process requires complex variable types such as a dictionary, table, or list.

[Add input variables to a process automation](#) on page 3460

## What's changed

When local desktop automations are run from Automation Co-Pilot, the progress bar on the activity page now displays an accurate completed percentage for the executing automation. Previously, an indeterminate progress indicator was used.

### Improved form capabilities of the Automation Co-Pilot embedded widget

The Automation Co-Pilot embedded widget has been enhanced to allow data mapping for processes and attended task bots using Javascript PostMessage API to facilitate the communication.

The embedded widget transfers data as expected with the addition of `referrerPolicy="origin"` in the `iFrame` tag. Previously, some HTTP requests were missing `Referer` header data that blocked data mapping.

[Map host data to Automation Co-Pilot forms](#) on page 3317

<p>Reference IDs available for all tasks</p> <p>All tasks now have reference IDs that are visible in the URL which you can use to share the task with another user. The ID also allows users to access a task directly in a request, even if that task is already completed. Previously, only the last pending task of a request was accessible directly.</p>
<p>The Automation Co-Pilot Desktop experience now displays unattended and attended automation in the familiar interface. The style and experience is the same as the Automation Co-Pilot embedded widget, where interactive tasks, forms, and progress can be accessed in the convenient workspace.</p> <p>For various users accessing Automation Co-Pilot Desktop, the following changes occur:</p> <ul style="list-style-type: none"> <li>• If the user has only an AARI license, then processes are visible.</li> <li>• If the user has only an Attended license, then bots are visible.</li> <li>• If the user has both AARI and Attended license, then both processes and bots are visible.</li> <li>• For other users, such as creators and unlicensed, an error will display. Log out and log in as a licensed user.</li> </ul>

Fixes
<p>Build 19659 (Cloud): All dependencies now show in the selected list for the exported process or bot during the Export process.</p> <p>Service Cloud case ID: 02088776</p>
<p>Build 19669 (Cloud and Cloud-Sandbox): This build includes the following fixes (along with fixes from the previous builds):</p>
<p>Processes load in the Process Composer as expected. Previously when operating on Automation 360 version 30, only the load screen would display when opening a process that used a bot, form, or process containing external dependencies (ex. spreadsheet, file, etc.).</p> <p>Service Cloud case ID: 02087219, 02087722, 02087795, 02087354, 02087749, 02087942, 02087591, 02087593, 02088270, 02088622, 02088698</p>
<p>Processes with a learning instance load as expected in the Process Composer. Previously, loading would not complete when trying to open a process with a learning instance.</p> <p>Service Cloud case ID: 02087749, 02087795</p>
<p>Submitting a Form task behaves as expected in Automation Co-Pilot. Previously, some users operating on Automation 360 version 30 were unable to submit a request that included a form configured with validation rules.</p> <p>Service Cloud case ID: 02086037, 02087396</p>

The following are included with v.30.

Upon logging in to Automation Co-Pilot in Microsoft Teams, pop-ups close as expected. This is because of an added parameter in the URL used for setup of the embedded app. Previously, the pop-up would remain open, for some users, even after credentials were entered.

[Integrate Automation Co-Pilot with Microsoft Teams](#) on page 3357

After saving a process in the Process Composer, check box options persist upon a page refresh. Previously upon refreshing, the check box option would not display in the Go To node when setting a check box input in the List of Options setting.

Adding a trigger to a multi-select drop-down element in Automation Co-Pilot on desktop works as expected. Previously, when the trigger was added the bot.execution.error would occur.

In multi-user deployments, trigger listener logs are now created for all bot deployments. Previously, the log was not capturing the multiple users activity.

When you deploy a bot, the initial start date and time of the bot show the correct date and time details. Previously, the correct date and time only displayed when the bot progressed.

Service Cloud case ID: 01982920

When running a process in Automation Co-Pilot the correct time displays in requests and end time. Previously, the time displayed inaccurately.

Service Cloud case ID: 01976950

PDF documents now render properly in forms. Previously in Automation 360 v.28 build 17566, when validating extracted information from Document Automation in Automation Co-Pilot the PDF did not display properly in a form.

Service Cloud case ID: 01981946

The file element is working as expected. Previously when using Automation Co-Pilot desktop, a file that had been uploaded in .xlsb format would be downloaded as a zipped file.

Service Cloud case ID: 01968194

For some processes, during the process editing phase in the **Private** space, the bot or form path breaks sometimes after importing or updating from a previous version. In such situations, we recommend using a workaround to reselect the path in case the path breaks, and save the process editor page before moving on.

## Limitations

When selecting the **Show only tasks assigned to me** option, Automation Co-Pilot does not display a list of tasks. This is currently being fixed.

In Automation Co-Pilot desktop, the expected behavior for bot deployment triggers does not include an unattended user that has selected the setting **Always create a new session** for auto-log in.

After selecting **Open in new window** from the embedded widget and submitting a form, the pop-up window will close and the task in the main window will stay in the same initial step. This is being fixed.

Workaround: manually proceed by clicking on the next step in the task sequence.

Intermittently, the Automation Co-Pilot status does not synchronize with the back-end progress. Although the process moves forward when submit is clicked, the displayed interface stops responding still. If the user clicks **Submit** again, a message is displayed that **The step has already been completed**. Also, the Task Sequence displayed does not update. The user has no path forward but to exit the process and return to it from Activity History. Users can also refresh the page to update the display.

We recommend avoiding multiple browser tabs or windows open to other Automation 360 applications as it decreases the likelihood of this issue.

Badge notifications are not updated until Automation Co-Pilot is refreshed manually. Intermittently, tasks might be assigned, but the total items needing attention will not display accurately in the badge.

Intermittently during the importing of a process, the path of a form or bot breaks (path to forms or bots selected respectively in the imported Form and Bot Task). This issue is currently being fixed.

Upon opening the imported process, simply reselect the form or bot to correct the path.

In the Process Composer, sometimes the element name of a task, like form or bot, will not be correct after an attached process has been imported. In these circumstances, when a node has been clicked from one step to another step the element name displays inaccurately.

Workaround: In cases where element names have changed, exit the process without saving to avoid loss or corruption of data. To minimize this issue frequency, when the imported process opens immediately save before clicking nodes and continuing edits.

When the Control Room is deployed on an Oracle database, Automation Co-Pilot throws an **Unknown error occurred** message.

When validating a document in Automation Co-Pilot, using a display resolution smaller than 1400 x 770, the button to change views is lost.

When making changes to an existing process, the **Save** button does not enable if the title is the only change. This is being fixed.

Workaround: make a minor modification to the process and the **Save** button will enable.

When creating a new variable in the process and selecting **use as input**, the help text displayed in the Default value field is inaccurate: **Only accepts existing variables in the process**.

The input variable can also accept user-defined default values.

While running a task and using the backspace key to edit the time value in a form, the data first switches PM to AM (or AM to PM) then continues deleting. This behavior is being corrected.

<p>The page might break in Automation Co-Pilot when clicking an option of a drop-down menu that is blank, during the task run.</p> <p>Ensure any drop-down menu in a form always has at least a default value and are not set by an empty list variable.</p>
<p>An error occurs when attempting to sort by the User group column on the <b>Requests</b> tab, when logged in using the AARI Admin role in Automation Co-Pilot.</p>
<p>In Automation Co-Pilot on the document validation page, three Status chiclets are displayed when only one should display.</p>
<p>Ensure a compatible version of bot agent is configured with your device. If there are compatibility issues with bot agent service, the Automation Co-Pilot embedded page might not be available.</p>
<p>Users might experience the following: user logs in successfully, window appears for Automation Co-Pilot, though Log In window does not close and Automation Co-Pilot window displays spinner. This is because the embedded iFrame and Chrome extension are unable to communicate with Automation Co-Pilot due to the security token not being stored. Chrome is updating some security features and the admin that sets up the iFrame should be aware of these changes. See, <a href="#">Storage Partitioning - Chrome for Developers</a></p> <p>Workaround: Customers should disable Chrome’s storage partitioning until a long term solution is identified.</p> <p><a href="#">Disable third-party storage partitioning</a> on page 3359</p>
<p>In forms with row selection enabled, the first column is strictly boolean data type values. This is an expected behavior of row selection. Users that are passing data to tables should understand that <code>Co10 = Boolean</code> when row selection is enabled in the table.</p> <p><a href="#">Using the Table element</a> on page 3451</p> <p>Service Cloud case ID: 01957725</p>

## Updates to the interface

See the following video for the updates in the interface for Automation 360 v.30 release:

Automation Co-Pilot
<p>For desktop automations, the progress bar on the activity page now displays an accurate completed percentage for the executing automation. <a href="#">Progress indicator</a></p>
<p>The Task view has been improved to display contributors of approval tasks. <a href="#">Improved Task view</a></p>
<p>A task reference ID is displayed in the URL of each task. <a href="#">Task reference ID</a></p>



## Document Automation and IQ Bot v.30 release

Review what's new and changed, and the fixes in IQ Bot and Document Automation for the v.30 release.

**Note:** Information about updates (such as what's new, changed, fixes, and limitations) is available on -specific pages. To access these pages, navigate to [Package updates overview](#) on page 835 > <-name> updates.

For a consolidated list of packages updated in this release, see [Packages updated in v.30](#) on page 62.

### Document Automation

What's new
<p>Data extraction in Document Automation using Generative AI</p> <p>Create learning instances in Document Automation for Cloud with an integrated Generative AI extraction capability that requires minimal configuration. This feature provides improved document processing of unstructured and semi-structured documents with high accuracy.</p> <p><a href="#">Document Automation data extraction using Generative AI</a> on page 3709</p>
<p>Integration of third-party parser in Document Automation</p> <p>Using Document Automation SDK, you can now create and connect a custom Automation 360 package as a parser and use it to extract documents. After creating and uploading a custom package to Automation 360, configure the parser with a learning instance and process documents with it.</p> <p><a href="#">Integrate third-party parser in learning instance</a> on page 3671</p>
<p>Custom data manipulation and validation through Document Extraction package (01936705)</p> <p>The Document Extraction package now provides the <b>Get Document Data</b> and <b>Update Document Data</b> actions to allow customization of document fields. With the <b>Get Document Data</b> action, you can retrieve extracted data through a dictionary or JSON file, and use all the available packages to read values and customize them. After manipulating the extracted data, you can use the updated dictionary or JSON string (extracted values or coordinates) as input by using the <b>Update Document Data</b> action and update the documents on the server. This feature helps maximize straight-through processing (STP) and reduce manual verification efforts.</p> <p><a href="#">Get document data action</a> on page 2512   <a href="#">Update document data action</a> on page 2513</p>
<p>Copy learning instance option added to Document Automation</p> <p>Copy an existing learning instance to reuse the learning instance fields, parser information, document type, language, and local associations in the learning instance copy. Additionally, you can copy the heuristic feedback training and validation rules, as required.</p> <p><a href="#">Create a learning instance in Document Automation</a> on page 3642</p>

**What's new**

## Notifications for your Document Automation license consumption

If you have enabled notifications, you will receive a notification for your Document Automation license consumption when the following criteria are met:

- When 90% of your licenses are consumed
- When 95% of your licenses are consumed
- When 99% of your licenses are consumed
- When 100% of your licenses are consumed

You can use this feature to plan for additional licenses.

[Understanding licenses in Document Automation](#) on page 1410

**What's changed**

## Create custom roles and permissions in Document Automation

You are not required to use the system-defined administrator roles for Document Automation roles and permissions anymore. You can create custom roles with limited or no access to administrative permissions while adhering to your organization's security policies.

[Document Automation users](#) on page 3638

## Enhanced use of Google Document AI learning instances

Add custom fields for Google Document AI learning instances and use them to extract data similar to other existing pre-trained fields. With this enhancement, you can use pre-trained models from Google with custom fields to extract data from documents.

[Create a learning instance in Document Automation](#) on page 3642, step 9.

## Enhanced language support for Google Custom Document Extractor (CDE)

Use Google CDE for any document type in 20 additional languages. With this enhancement, you can:

- Create learning instances in different languages
- Add field names
- Set up Bring Your Own Key (BYOK) license

[Document Automation support for Google Custom Document Extractor \(CDE\)](#) on page 3704

## Change in Document Automation license name

The **Classifier (Number of pages)** license is renamed to **Document Classifier (Number of pages)**.

[Understanding licenses in Document Automation](#) on page 1410 | [Manage licenses](#) on page 1782

What's changed
<p>Changes in IQ Bot Classifier package (01955258)</p> <p>The IQ Bot Classifier package has been enhanced to improve its usability:</p> <ul style="list-style-type: none"> <li>The package name has been changed to Document Classifier package.</li> <li>You can track consumption on the license administration page for processed documents in the Document Classifier package.</li> </ul> <p><a href="#">Document Classifier package updates</a> on page 899</p>

Build 19688: This build includes the following fixes (along with fixes from the previous builds):

Fixes
<p>If <b>Document rules</b> contain multiple conditions using the <b>AND</b> operator with (or without) a group, an appropriate error message is now displayed. Also, the corresponding action is now applied on the fields.</p>
<p>When the user corrects any one cell value in the row then the entire row error message gets cleared. As a result, users can submit the document after correcting the error message.</p> <p>Service Cloud Case ID: 02089847</p>
<p>The authentication mechanism between Document Automation and Apigee is now improved using the private public key pair.</p> <p>Previously, the static signedTenantID from license server was used as the authentication token to communicate between Apigee and Document Automation Microservice on Cloud. This was causing security risk as the token was static and not expiring.</p>
<p>Fixed security vulnerability issues.</p>

Build 19596: This build includes the following fixes (along with fixes from the previous builds):

Fixes
<p>If you have custom table fields in a learning instance, the table values are now extracted correctly from the specified line item.</p>
<p>If you have used Google CDE for creating a learning instance, the documents are now processed successfully for all the supported languages such as: Albanian, Croatian, Finnish, Icelandic, Slovenian, and Vietnamese.</p>
<p>Document extraction is now successful using proxy in the bring your own key (BYOK) use case.</p>
<p>When you try to create or edit a learning instance, the <b>Create</b> button is no longer disabled if you select the <b>Extract field using pattern</b> check box, and then subsequently clear the check box without entering a value in the <b>Regular Expression</b> field.</p>
<p>When you modify and upload a custom JSON file to the Validator, you can access the file in the Validator without any error messages.</p> <p>Service Cloud Case ID: 01936705</p>

Fixes
Table names in the Microsoft Form Recognizer Studio interface exceeding 99 characters are now handled without any error messages.
While creating a learning instance, the <b>Create Learning instance</b> button is no longer disabled if you clear the values from any other field.
Use the latest version of the Document Automation package on the previous three (n-3) versions of the Control Room to create a learning instance and process documents successfully. For example, if you are using the Control Room from the Automation 360 v27 version, you can use the Document Automation v30 package to create a learning instance and process the documents successfully.
The name of the downloaded file is now retained even if the name of the learning instance that you have used to process the documents has an empty space.
For the new document level rules, the expected outcome is now reflected correctly in the Validator when the condition is based on a <b>Form Field</b> and the resulting action affects a <b>Table Field</b> .
After you import a learning instance, the <b>Import learning instance from</b> field is now cleared and the imported .dw file is no longer displayed in the field.
When you use the <b>does match regex</b> condition and the <b>show error</b> action to create a validation rule, the fields without any extraction no longer display errors.
If a field name in the Validator has more than 100 characters, the scroll bar appears and you can see the value of the form field. Previously, the form field name was not displayed.
When <b>Extract field using pattern</b> is chosen in the learning instance and a document is processed, the field is validated on entering valid data. Here, only the respective field is affected, and its extraction is based on the provided regular expression input.  This was a limitation in builds 18332, 18302, 18277 (Cloud-Sandbox) and build 18324 (On-Premises).
You can now save the documents in French language that are processed through heuristic feedback even when they contain special characters.  Service Cloud Case ID: 01995135

Limitations
During validation, when a user clicks on a field, it should open the page in the document with the relevant information for that field or search query. However, for unstructured documents, clicking on a field to validate the value, opens the wrong page.
When you export a learning instance in Firefox browser, you cannot download the .dw file from the download link notification.  Workaround: Use Google Chrome or Microsoft Edge-based Chromium to download the .dw files. For more details, see <a href="#">Browser requirements for Automation Workspace</a> on page 1210.
The message for updating document data in the package does not localize according to the selected language. Additionally, the localized custom message does not translate according to the selected language for Google Document AI support.

Limitations
The validation user interface shows a stacked view and you are not able to change the view.
When a user configures a parser and selects the <b>Japanese</b> language, the <b>Locale</b> field does not reflect this and continues to show the <b>English (united states)</b> value. The user has to manually select the <b>Japanese</b> locale, if required.
While creating a parser, if a user does not enter the mandatory field values (such as <b>Provider, Document type, and Language</b> ), the system does not display any error message to notify the user. Since entering mandatory field values is required to proceed to the next step, the <b>Next</b> button is not enabled, hence requiring the user to enter all required field values to enable the <b>Next</b> button and create the parser.
While configuring a parser if a user uploads a JSON file with incorrect parser field values, the upload process fails and does not show an error message.
When a user edits a learning instance that is created with a third-party parser, the <b>Custom aliases</b> option should be disabled, which does happen.
When a user clicks the <b>Language</b> field during parser configuration, the languages do not display in the correct order.
During parser configuration, the <b>Configure parser</b> page does not display page content in the selected language.
When a user clicks the <b>Create</b> button while creating a learning instance and adds a field, on entering a field name with the same case, an error message displays.
When a user processes a multi-page document containing header less tables with <b>Google Document AI</b> as the provider, it extracts only the first page from the document.
Sorting does not work when a user clicks the provider name in the <b>Parser Configuration</b> page.
In the validation user interface when a user deletes a table row that lies in-between and tries to re-process the same document, the system removes the last row from the extracted table.
While creating or editing a learning instance, when a user updates any field label value, the system lets the user enter a value of more than 200 characters, in spite of the character limitation. However, on trying to save the updates, the user could see an error message for the character limit.
If <b>Document rules</b> that contain multiple conditions is using the <b>AND</b> operator with (or without) a group, the corresponding action is not applied and an error message is also not displayed.
When a document rule contains different datatypes in <b>then</b> condition, you might get the wrong error message.  Workaround: If there are multiple fields in the action with different datatypes, structure the document rule such that there is a separate action for each field.

Limitations
<p>When a user applies a formula validation across multiple rows to validate a value at form field level (For example, Sub Total) and if the user deletes one or more rows and resets the value of form field to match with the present rows, the validation error still persists. To fix this issue, perform the following workaround:</p> <p>Workaround: Users must add zero (0) to the unwanted cell values (quantity, unit price, and total price) and delete the row. Then, add the correct value to the subtotal to clear the error message.</p>
<p>On the <b>Learning instances</b> page, the Google Document AI provider icon is not visible for Google CDE learning instances.</p>
<p><b>Note:</b> It does not impact the underlying functionality.</p>
<p>When user provides a shared network path as output path for Advanced Classifier package actions, the <code>Directory is invalid or not found - null error</code> message is displayed.</p> <p>Service Cloud Case ID: 02085363</p>

## Updates to the interface

See the following video for the updates in the interface for Automation 360 v.30 release:

Document Automation
<p>Create learning instance with the Generative AI capability to extract data from unstructured and semi-structured documents in Document Automation.</p> <p><a href="#">Data extraction in Document Automation using Generative AI.</a></p>
<p>With the <b>Configure parser</b> option, you can connect a third-party parser with a learning instance in Document Automation.</p> <p><a href="#">Integration of third-party parser in Document Automation</a></p>
<p>The <b>Get document data</b> and <b>Update document data</b> actions are new in the Document Extraction package.</p> <p><a href="#">Custom data manipulation and validation through Document Extraction package</a></p>
<p>The <b>Copy</b> option in a learning instance lets you copy a learning instance to reuse its information in a new learning instance.</p> <p><a href="#">Copy learning instance option added to Document Automation</a></p>
<p>The <b>Add a field</b> option lets you add custom fields for learning instances with Google Document AI.</p> <p><a href="#">Enhanced usage of Google Document AI learning instances</a></p>

Document Automation
The <b>Classifier (Number of pages)</b> license is renamed to <b>Document Classifier (Number of pages)</b> . <a href="#">Change in Document Automation license name</a>
The <b>IQ Bot Classifier</b> name is changed to <b>Document Classifier</b> package. <a href="#">Changes in IQ Bot Classifier package</a>

## IQ Bot

Fixes
Invoices in Japanese language that contain any text in Greek language are now classified correctly by the IDC Classifier and errors are no longer displayed. Service Cloud Case ID: 01967610

## Feature deprecations

Tegaki API OCR engine

From Automation 360v.30, we have deprecated use of Tegaki API OCR engine for data extraction in Automation 360 IQ Bot. We recommend using the [Use Google Vision OCR engine](#) instead. See: [Feature deprecations affecting Automation Anywhere products](#).

---

**Note:** Deprecation note added to: [Use Tegaki API OCR engine](#).

---

Automation 360 IQ Bot Community Edition deprecation

Automation 360 IQ Bot Community Edition will no longer be available from November 28, 2023. Use the Document Automation Community Edition for enhanced intelligent document processing.

Users who have created automations using Automation 360 IQ Bot will need to rewrite them using Document Automation.

Refer to [Document Automation](#) for details.

## Bot Insight v.30 release

Review what's changed and limitations in Bot Insight for the v.30 release.

---

**Note:** Information about updates (such as what's new, changed, fixes, and limitations) is available on -specific pages. To access these pages, navigate to [Package updates overview](#) on page 835 > <-name> updates.

For a consolidated list of packages updated in this release, see [Packages updated in v.30](#) on page 62.

---

## What's changed

### Enhanced Bots dashboard

The **Bots** dashboard is now enhanced such that the **Total Bot Runs** count matches the total count when the **Total Completed (Success)**, **Total in Progress**, and **Total Failed** counts are added together.

## Limitations

For all dashboards, the **Download PDF** function does not work in the Safari browser.

Workaround: To download PDF reports, use other browsers such as Google Chrome, Mozilla Firefox, and Microsoft Edge.

## Package SDK v.30 release

Review what's new in the Automation 360 Package SDK for the v.30 release.

## What's new

SDK download link: [A360-package-sdk-2.9.0.zip](#)

Docs download link: [A360-package-sdk-2.9.0-javadoc.zip](#)

### New NoLoggingAttributes attribute added

A new attribute **NoLoggingAttributes** has been added for `DesktopOperationRequest` used to stop trace logs for mentioned fields.

For example:

```
@Request(NoLoggingAttributes = {"loginUser", "secureText"})  
private DesktopOperationButtonRequest request;
```

### Package SDK built with Gradle version 7.6.2

The current Package SDK is built with Gradle version 7.6.2 because the previous version had vulnerabilities.

## Automation 360 v.29 Release Notes

Release date: 21 June 2023

Review the top 5 features in this release as well as other new features and exciting enhancements for the Automation 360 v.29 release.

- Build 18361: Automation 360 (Cloud and Cloud-Sandbox)



- Build 18399: Automation 360 (On-Premises)
- Build 18371: IQ Bot (On-Premises)

We have released an updated build for a fix after the Automation 360 v.29 builds, which were On-Premises Build 18345 and Cloud-Sandbox Build 18277. For information about the fix in the updated build, see [Updated release builds](#) on page 83.

## Highlights of this release

Here are the top 5 features in the v.29 release:

### Center of Excellence

Accelerate your journey to automation success with CoE Manager Plus Package: Use the CoE Manager Plus Package to track and manage multiple automation programs across multiple vendors, such as Power Automate and ServiceNow, and integrate with other systems, such as Jira. Gain deeper transaction-level ROI metrics as you simultaneously recover lost productivity as stakeholders exert minimal effort to report data through business leadership dashboards and automated report creation.

See [CoE Manager](#) on page 2047.

### Automation lifecycle management

View and scale automation across your organization: The Automation Command Center is a personalized action center and home page where you can quickly gain a clear understanding of automation operations and device dashboards. Easily view operational details and metrics for scheduled automations, automation run statuses, and license and device utilization. With RBAC, admins can create personalized views for different types of users, including developers.

See [Automation Command Center](#) on page 2041.

### Resilient automation

Ensure automation is resistant to pop-ups: To minimize system pop-up interruptions that can occur during a bot run, enable the **Handle unexpected pop-ups** option in the **Run Task Bot** wizard to automatically detect and manage these pop-ups.

---

**Note:** The handle unexpected pop-ups functionality is not available as part of the standard Control Room installation (or update) and must be enabled separately. Contact your

Automation Anywhere Customer Success Manager (CSM) for assistance.

---

See [Automation resiliency](#) on page 1084.

Improve developer productivity: Use the debugger tool to troubleshoot and focus on correcting automation issues. While in debug mode, the automation user can change or edit variable values for basic data types to run the automation successfully.

See [Debugging your automations](#) on page 2353.

Reliably automate your remote applications running on VMware Horizon VDIs: Use our Next-Gen Recorder to easily exchange data between your applications running on local and remote machines. Citizen and professional developers can automate remote applications without making any configuration changes on their local machines.

See [Automate applications running on remote machines](#) on page 2949.

## Business governance

Strengthen governance for automation creation: With code analysis and enforcement, you can ensure your developers are creating reliable, maintainable, and secure automations according to best practices. The platform enables the business to define and enforce coding best practices as developers are creating automations, and enables different code quality thresholds to be enforced across different sets of users.

See [Code analysis enforcement](#) on page 2189.

Simplify automation promotion: Use our new Promotion wizard to avoid the multistep export-import process. Leveraging a single tool, developers can move automations, forms, processes, and their dependencies easily across the Dev-Test-Prod environments.

See [Move bots across environments](#) on page 2037.

## Process visualization and flow

Graphically gain actionable insights quickly: The Process Discovery Flow graph enables you to easily visualize commonalities among variants and loops within your business processes. Provide your business analysts a clear view to identify what processes are the best candidates

for optimization or automation to generate the greatest ROI.

See [Using the Flow Graph to find common steps and loops](#) on page 3842.

## Updated release builds

- Build 18399 (On-Premises) is released which includes a fix for the Apache ActiveMQ remote code execution vulnerability. For more information, see [Apache ActiveMQ Remote Code Execution Vulnerability CVE-2023-46604 \(A-People login required\)](#).
- We have released updated Build 18361 (Cloud and Cloud-Sandbox) and Build 18399 (On-Premises) for the following:

- Fix for an issue that impacts the ability to check-in bots that were cloned by other users in specific cases.

Unable to check-in a bot when you perform the following steps:

1. Clone a bot created by another user.
2. Change the structure of the bot which is different from the cloned bot.
3. Check-in the bot.

(Service Cloud case ID: 01991263, 01991795, 01993056, 01993801, 01993825, 01992732, 01993655, 01994102, 01994336, 01993388, 01994525, 01994710, 01994569, 01994217, 01994263, 01994843, 01995026, 01994542, 01994223, 01994971)

- Fix for an issue when using the Emailpackage that was using credentials stored in a locker whose name started with `oAuth_` (case insensitive).

(Service Cloud case ID: 01993661)

- Fix for an issue where the purchased details for Control Room license is displayed incorrectly on the **Licenses** page when the Citizen Developer feature is not purchased in the file license.

(Service Cloud case ID: 01994512)

- We have released updated Build 18345 (On-Premises and Cloud-Sandbox) for the following:
  - Fix for an issue in Document Automation when table fields are sed in Validator where validation is now performed on individual fields.
  - Fix for an issue in the learning instance that is using the **Extract field using pattern** option which no longer displays the **Value cannot be empty error** when using empty fields.
  - Fix for an issue in the Automation Co-Pilot for MS Teams integration where the Auth pop-up now closes after the correct credentials are entered.
- We have released updated Build 18332 (Cloud-Sandbox) to include a fix for an issue related to recorder session management in the Control Room.

---

**Note:** For documentation on previous builds of this release, see the PDFs available on this page: [Automation 360 Release Notes \(build versions\)](#).

---

## What's new and changed in each product

Navigate to the following pages for details on all the updates (what's new, changed, fixed, and limitations) in each product:

<a href="#">Automation Workspace v.29 release</a> on page 84 <ul style="list-style-type: none"> <li>• <a href="#">Updating to v.29 release</a> on page 101</li> <li>• <a href="#">Migration updates for v.29 release</a> on page 101</li> </ul>
<a href="#">CoE Manager v.29 release</a> on page 108
<a href="#">Automation Co-Pilot for Business Users v.29 release</a> on page 109
<a href="#">Document Automation and IQ Bot v.29 release</a> on page 114
<a href="#">Bot Insight v.29 release</a> on page 120
<a href="#">Package SDK v.29 release</a> on page 121
<a href="#">Process Discovery Release Notes</a> on page 983

## Automation Workspace v.29 release

Review what's new and changed, and the fixes and limitations in Automation Workspace for the v.29 release.

**Important:** Starting from this release, we have moved information about updates in each (such as what's new, changed, fixes, and limitations) to -specific pages. You can access these pages by navigating to [Package updates overview](#) on page 835 > <-name> releases.

For a consolidated list of packages updated in this release, see [Packages updated in v.29](#) on page 104.

## What's new

Control Room, devices, and Bot Agent
<p>Introducing Help Center: In-app help used to search for automation information</p> <p>Help Center is a centralized location that contains all the information developers need to develop automations. When you log in to the Control Room, the Help Center will show suggested topics related to the <b>Home</b> and Bot editor page in the widget. Developers can leverage the suggested topics or search for specific packages, actions, or information they need help with. Additionally, the documentation link from contextual help loads the content directly within the Help Center. This feature eliminates the developer from having to switch back and forth between the Bot editor and the documentation portal providing a distraction-free experience.</p> <p><a href="#">In-product user assistance</a> on page 1159</p>

**Control Room, devices, and Bot Agent**

Enhancement to Bot Agent installer (Service Cloud case ID: 01857405)

We have enhanced the Bot Agent installer by including new .exe files for the **Bot launcher**, **Node manager**, **Triggers**, and **Child session launchers**. When you create and run a bot using actions from the File, Folder, or Excel advanced packages, and if your organization has configured security policies such as Document Security Solution (NASCA) DRM (Digital Rights Management), the files will be encrypted and secured by the security program.

The following changes occur in the installer when you:

- Install the Bot Agent, `java.exe` will be replaced by `NodeManager.exe`.
- Run a bot, `javaw.exe` will be replaced by `BotLauncher.exe`.
- Configure a trigger, the trigger will be activated with `TriggerListener.exe` instead of `javaw.exe`.
- Run a bot with Automation Co-Pilot(integrations) (AARI), `javaw.exe` will be replaced with `ChildSessionLauncher.exe`.

**Note:**

- If your bots or scripts use `java.exe` or `javaw.exe` in the Bot Agent installer folder, we recommend that you modify your bots or scripts using the new .exe files.
- Ensure that the Bot Agent version installed on your system is the version that is released with Automation 360 v.29.

[Install Bot Agent and register device](#) on page 1347

Enhanced operational insights in Automation Command Center

As an administrator, you can have a comprehensive view of the automation landscape in your homepage. The Automation Command Center (ACC) homepage combines all of the different functional areas onto a single page thereby increasing productivity efficiency.

The homepage provides operational insights into automation and device statuses, license utilization, and code analysis policy compliance metrics. You can navigate to automation and device dashboards to review details for automation executions and related key performance indicators, and gain actionable insights for devices. Additionally, you can review total automation run hours, device utilization, and KPIs related to queues and work items. ACC provides the ability to navigate to specific functional areas, such as Policy management.

[ACC home page for administrators](#) on page 2042 | [ACC home page for Pro and Citizen Developers](#) on page 2044 | [Configure and assign code analysis policy](#) on page 2191

Control Room, devices, and Bot Agent
<p>Enforce code analysis for bots check-in</p> <p>As an administrator, you can enforce code analysis during check-in of bots to the public workspace. You can restrict the RPA developers or Citizen Developers from checking in bots that contain code analysis violations. This is based on the permissions assigned to the developer in a custom role.</p> <p>When you create a custom role, you can use the following three new code analysis enforcement permissions:</p> <ul style="list-style-type: none"> <li>• Enable enforcement for bot check-in</li> <li>• Allow check-in with low severity violations</li> <li>• Allow check-in with high severity violations</li> </ul> <p>All system roles only have the permission to check in bots without violations. If you only use system defined roles you must create new roles to assign the permissions to check in with violations.</p> <p><a href="#">Code analysis enforcement</a> on page 2189</p>
<p>View license details (drill down) for users and Control Room instances</p> <p>You can view license allocation details by users and license usage across different Control Room instances. From the <b>Licenses</b> page, you can click a license type to view the <b>License details</b> page that provides the following information:</p> <ul style="list-style-type: none"> <li>• View the license allocation details by users in the Control Room where you are viewing the license information.</li> <li>• View the usage details for the license type across other Control Room instances.</li> </ul> <p><a href="#">Manage licenses</a> on page 1782   <a href="#">View license details</a> on page 1783</p>
<p>Notifications for invalid login attempts</p> <p>As a Control Room user, you are now notified for invalid login attempts. When you exceed the maximum number of allowed invalid login attempts (set by your Control Room administrator), the Control Room sends an instant email notification to your registered email address. With this instant notification, you can trace the Control Room authentication and restrict invalid access by resetting the Control Room password.</p> <p><a href="#">Platform events</a> on page 2203</p>
<p>Time filter for historical activities</p> <p>As a Control Room user with appropriate permissions, you can use the <b>Time filter</b> option to search for and view specific historical activities based on time duration. Additionally, you can customize the date and time to view these activities.</p> <p><a href="#">Time filter</a> on page 2123</p>
<p>Integrate HashiCorp Vault to retrieve credentials (Service Cloud case ID: 00833916, 01275490, 01762964, 01839196)</p> <p>Integrate HashiCorp Vault with the Control Room to retrieve credentials from the HashiCorp Vault. The credentials are securely stored and managed on the HashiCorp Vault.</p> <p><a href="#">HashiCorp Vault integration</a> on page 1979</p>

Control Room, devices, and Bot Agent
<p>Automation capabilities for safe members from multiple CyberArk safes (Service Cloud case ID: 01834131)</p> <p>You can add multiple CyberArk safes on the <b>Auto login settings</b> page to enable safe members to deploy bots for unattended Bot Runners.</p> <p><a href="#">CyberArk credential retrieval use cases</a> on page 1941</p>
<p>Audit log events for Active Directory default and allowed domains</p> <p>The following audit log events are logged for Active Directory:</p> <ul style="list-style-type: none"><li>• When a user or an existing mapping belongs to one or more domains</li><li>• When a user configures a domain as the default domain</li><li>• When a user adds a domain to the allowed domains list</li><li>• When a user deletes a domain from the allowed domains list</li></ul> <p><a href="#">Audit events list</a> on page 2144</p>
<p>Edit multiple devices</p> <p>As a Control Room administrator or a user with <b>View and manage all devices</b> role, you can select and edit multiple devices at the same time. Additionally, Control Room users can change <b>Lifespan</b>, <b>Device type</b>, and <b>Log collection configuration</b> settings across all registered devices at the same time.</p> <p><a href="#">Edit multiple devices simultaneously</a> on page 1880</p>
<p>Run bot in elevated mode</p> <p>After updating to this release, an administrator can use the <code>A360Elevator.exe</code> application to run a bot in an elevated or administrative mode. This enables the Control Room users to run bots that might access any application that requires administrator credentials.</p> <p><a href="#">Run a bot in elevated mode</a> on page 2285</p>

**Control Room, devices, and Bot Agent**

Change variable values while debugging

You can use the **Debugger** tool to edit the values of the following variable types added to the **Watched variables** list when you pause in debug mode during a bot run:

- Number
- String
- Boolean
- Datetime

This enables you to troubleshoot and fix any bot related errors, determine the correct value to use during bot execution, and resolve the issue without stopping the debugger.

**Note:**

- You cannot edit constant variables.
- Ensure that the Bot Agent version installed on your system is the version that was released with Automation 360 v.29.

[Debug tool](#) on page 2353 | [Debugging your automations](#) on page 2353

On-Premises Control Room diagnostic utility

Use the On-Premises Control Room diagnostic utility to collect logs to troubleshoot any Control Room related issues.

[Using the Control Room diagnostics utility](#) on page 1324

**Building and running bots**

Ability to edit workload management automations

You can now edit a workload management (WLM) automation to add more run-as users and switch device pools for faster processing time. You can update the processing time, run-as users, and device pool details for queues that are currently being used.

[Edit workload management automations](#) on page 2020

Move bots across environments

As an administrator or a user with **Import bots**, **Export bots**, and all folder level permissions, you can move bots and files, their dependencies, and packages between Control Room instances in a single flow. The promote bot feature simplifies the process by avoiding the multi-step export and import process when moving bots across different Control Room environments (Dev to UAT).

[Move bots across environments](#) on page 2037



**Building and running bots**

Recover private repository of a deleted user (Service Cloud case ID: 01854109, 01956050)

As an administrator, you can recover the bots and files created in the private repository of a deleted user (Bot Creator or Citizen Developer). You can transfer the recovered bots and files to an existing user (Bot Creator or Citizen Developer). Whenever users leave an organization, any automations they created are not lost and can be used by others in the organization.

[Recover bots and files](#) on page 2039

Improved searchability for bots and files in subfolders (Service Cloud case ID: 01759969, 01838997, 01858215, 01888077)

You can quickly search and locate bots, files, processes, and forms within a folder and its subfolders in public and the private workspaces even if your repository contains multiple folders and subfolders. To enable this enhanced search feature, select the **Include items within sub-folders** check box. A new column, **Folder path**, is displayed which contains the location of the folder and subfolders for the bot.

View references for non-bot file dependencies (Service Cloud case ID: 01793080)

You can view the references (immediate parents) for non-bot file dependencies such as: CSV, PDF, JPG, GIF, XLS, DOC, and PPT in public and private workspaces. You can use this feature to identify the bots, processes, or forms that refer to a non-bot file dependency. When you have many automations dependent on various file dependencies, it is easier to modify or delete the dependencies when you understand the impact of this change on the automations. You can efficiently check the effect of either modifying or deleting the dependency on the automations that refer to it.

**APIs and integrations**

New delete device API (Service Cloud case ID: 01805692, 01822981)

To remove a registered device from your Control Room, use the new `DELETE /v1/devices/id` API. Before deleting a user, you can use this API to remove the device connected to the user, and then re-connect the device to another user.

[Device API](#)

## What's changed

Control Room, devices, and Bot Agent
<p>Permissions for users to view only scheduled activities (Service Cloud case ID: 01885651, 01875383, 00788548, 00823729, 01776437, 01793759)</p> <ul style="list-style-type: none"> <li>You can use the <b>View ALL scheduled activity</b> option to view all the schedules in the system.</li> <li>You can use the <b>View ALL scheduled activity from my Folders</b> option to view all scheduled activities for the bot folders to which users have access.</li> </ul> <p><a href="#">Feature permissions for a role</a> on page 1749</p>
<p>Audit log events for secure recording</p> <p>Audit log entries are logged when you configure the following <b>Secure recording</b> options:</p> <ul style="list-style-type: none"> <li>Enable or disable the option to preview image in the Bot editor.</li> <li>Change the role-based access control (RBAC) configuration on secure recording.</li> </ul> <p><a href="#">Audit events list</a> on page 2144</p>
<p>Enhanced workload management capacity and performance</p> <p>You can process more number of queues and work items in workload management automations than previously. With this enhancement, you can improve your automation goals with optimum utilization of resources.</p> <p><a href="#">Capacity and performance planning</a> on page 1182</p>
<p>Simplified notifications categories</p> <p>The in-app notification panel displays all the notifications as a single list without categorizing them by severity. You can use the <b>Attention needed</b> filter to view the high-risk and cautionary event notifications which require immediate action. Otherwise, all the notifications are visible as a simple list of events.</p> <p><a href="#">Notifications filter</a></p>
<p>Optimized audit log entries for automated code analysis</p> <p>The audit event logs generated for automated background code analysis scanning are optimized to include the following two audit events when code analysis runs automatically:</p> <ul style="list-style-type: none"> <li>Automated code analysis started</li> <li>Automated code analysis completed</li> </ul> <p>The audit log entries contain consolidated information about the code analysis events. The audit entry also contains information for any change made to the existing policy.</p>

Control Room, devices, and Bot Agent
<p>Upload workitems to a queue API (Service Cloud Case ID: 01945087)</p> <p>The <code>/queues/id/workitems/upload</code> API was changed to the <code>/queues/id/file</code> API because the previous version of the API was reporting a status of <b>N/A</b>. You can continue to add workitems to your workload management (WLM) queue using the <code>/queues/id/file</code> API.</p> <p><a href="#">Workload Management API</a></p>
<p>More visibility of variable types</p> <p>Now the <code>currentValue</code> and <code>currentKey</code> variables of all types are displayed in the variable picker. Previously these variables had to be of string type to be visible.</p>
<p>Enhancement to Bot Scanner utility</p> <p>We have enhanced the Bot Scanner utility and it now includes the option to scan bots that contain any of the Email package actions and Triggers that use the EWS option.</p> <hr/> <p><b>Note:</b> Microsoft has deprecated EWS API for Exchange Online and has recommended that users move to Graph API. We recommend that you update the impacted bots by replacing each email-related action with the equivalent new action in the Microsoft 365 Outlook package (based on Graph API).</p> <p><a href="#">Microsoft 365 Outlook package updates</a> on page 917   <a href="#">Microsoft 365 Outlook package</a> on page 2851</p> <hr/> <p><a href="#">Scan bots for Basic authentication</a> on page 1134</p>
<p>Notification on package update in On-Premises Control Room</p> <p>If you have disabled the automatic update option for packages (<b>Administration &gt; Settings &gt; Packages &gt; Package update &gt; Disable</b>), a notification icon is displayed for these packages installed in your Control Room when a more recent version is available.</p> <p><a href="#">Automatic package updates for On-Premises Control Room</a> on page 1906</p>

## Fixes

Build 18361: This build includes the following fixes (along with fixes from the previous builds):

<p>The purchase details for Control Room license is now displayed correctly on the <b>Licenses</b> page when the Citizen Developer feature is not purchased in the file license.</p> <p>Previously, purchase details was incorrectly displayed.</p> <p>Service Cloud case ID: 01994512</p>
<p>In WLM automation, the queue processing times retain the metadata during the entire automation lifecycle.</p> <p>Previously, after the first deployment of the automation, the metadata was lost.</p> <p>Service Cloud case ID: 01995713, 01997546, 01986247, 02004378, 02004171</p>

After you update to Automation 360 v.29, the bot check-in no longer fails when you have cloned bots from other users and add a new directory for the dependency. Additionally, it shows accurate folder structure and dependencies for the cloned bots from its public bots.

Previously, from the older version of Automation 360 v.29, when you checked in a bot with cloned bots from other users and added a new directory for its dependency, it failed with an error message.

Service Cloud case ID: 01991263, 01991795, 01993056, 01993801, 01993825, 01992732, 01993655, 01994102, 01994336, 01993388, 01994525, 01994710, 01994569, 01994217, 01994263, 01994843, 01995026, 01994542, 01994223, 01994971, 01995404, 01995479, 1993255

You can now run the `v1/audit/messages/list` API in Control Room swagger successfully. Previously, when the `v1/audit/messages/list` API was executed in Control Room swagger, the following error message was displayed:

```
Please correct the following validation errors and try again.  
propKeyfilterErrorValue must be a string.  
PropKeypageerrorValue must be a string.
```

Service Cloud case ID: 01988096

Build 18324: This build includes the following fixes:

You no longer see audit log entries for the **Run bot pre processing failed** event type for users and devices that are not active in the Control Room.

Previously, such entries were displayed in the audit logs.

Service Cloud case ID: 01983909

For users (excluding the users who are assigned the AAE\_Admin role) who do not have any license assigned to them (Bot Creator, UnattendedBot Runner, Attended Bot Runner, or Citizen Developer), the **Audit log** page no longer displays unsuccessful entries related to the **Default device set** event for any activity performed by the users on the Control Room.

Previously, multiple unsuccessful entries were displayed for such users.

Service Cloud case ID: 01969726, 01970583, 01970990, 01971435, 01971171, 01970869, 01971854, 01970915, 01970523, 01971411, 01971788, 01971827, 01971482, 01971736, 01970333, 01972128, 01970497, 01972025, 01971459, 01971561, 01971068, 01972148, 01975216, 01975980, 01977479, 02001122

After you update Automation 360 to v.28, the Control Room no longer shows the `Out of Memory` error message and blocks the device connection.

Previously, in such cases, you were not able to access the Control Room and bot deployments were stopped when device was disconnected.

Service Cloud Case ID: 01976841, 01976847

Bot deployments no longer fail or no Control Room slow down issue due to Control Room notifications.

Previously, Control Room performance was impacted due to notifications storage leading to bot deployment issues.

Service Cloud case ID: 01978739, 01978768, 01978794, 01978812, 01978787, 01978826, 01978840, 01978851, 01978849, 01978816, 01978764, 01978782, 01978124, 01978837, 01978833, 01978820, 01978854, 01978780, 01978859, 01978790, 01978679, 01978831, 01978108, 1979121, 1979174, 1979190, 1979191, 1978957, 1977677, 01977677

When you sort the schedules data on the **Scheduled activity** page by the **Next occurrence** column, the schedules are sorted correctly.

Previously, the schedules on each page were sorted individually instead of sorting all the schedules collectively. As a result, schedules were sorted and displayed incorrectly.

Service Cloud case ID: 01936672, 01948336

The BotInsight API- Get Task Log Data will retrieve automation execution information for all automations in public folders, irrespective of whether they pre-existed in a private folder or not. Additionally, the API expected an automation name and returned data only for that automation.

Previously, the GetTaskLogData API retrieved information only for the following:

- If a bot pre-existed in a private folder and will not work for bots directly uploaded to the public folder.
- When the bot name (optional parameter) is specified in the request.

Service Cloud case ID: 01805000, 01965480, 01804312, 01854057, 01861154, 01905063, 01901693, 01932388, 01943438, 01911251, 1946327

You can renew and install licenses using your Control Room GUID without encountering an error.

Previously, an error occurred in such a case.

Service Cloud case ID: 01958580

After you update Windows Server 12 with [Update for Universal C Runtime in Windows](#) patch, the Automation Anywhere Control Room Discovery Bot ML Service no longer fails during Automation 360 installation.

When you uninstall the Bot Agent, it no longer affects the Enterprise 11 Google Chrome plugin.

Previously, in such cases, Google Chrome plugin was uninstalled when you uninstall the Bot Agent. As a result, you had to install the Enterprise 11 Google Chrome plugin again to proceed with Enterprise 11 bot execution.

Service Cloud case ID: 01967916

An active directory user can export roles without encountering failure.

Previously, such a user was unable to export roles.

Service Cloud case ID: 01954961

<p>When you create or edit a locker, you can add multiple roles when updating the <b>Consumers</b> option.</p> <p>Previously, you were unable to add multiple roles.</p> <p>Service Cloud case ID: 01946827</p>
<p>You can use the <b>User authentication</b> setting when enabling SSO authentication without encountering an error.</p> <p>Previously, an error was displayed when you clicked the <b>Edit</b> button for the <b>User authentication</b> settings.</p> <p>Service Cloud case ID: 01946770, 01958619, 01984261, 01977599, 01962097, 01980940, 01964711, 01966644, 01971461</p>
<p>On the <b>In progress activity</b> page, the details page of an activity displays the <b>Last modified</b> date consistently.</p> <p>Previously, this date was displayed inconsistently.</p> <p>Service Cloud case ID: 01943780</p>
<p>In an Oracle Database environment, when you update from Automation 360 v.26 to later versions, the new package versions that are shipped through the installer are now enabled and set as the default version.</p> <p>Previously, you must have enabled each updated or new package manually and set it as default version.</p>
<p>When you run an active bot with queue, the <b>Activity &gt; In progress</b> page shows appropriate behavior for <b>Pause</b>, <b>Stop</b>, and <b>Resume</b> options in the top actions panel.</p> <p>Previously, when an active bot was paused using the <b>Pause</b> option in the top actions panel, the <b>Activity &gt; In progress</b> page displayed an error message and not working properly.</p> <p>Service Cloud case ID: 01941227</p>
<p>With the <b>bot.dependency.timeout = &lt;value in seconds&gt;</b> property, network connections no longer stuck. Also, a scheduled bot no longer remains in the <b>Pending execution</b> status. As a result, Bot Agent can download the dependencies and the bot executes successfully.</p> <p>Previously, during dependency download phase, the downloads were stuck due to unreliable network. As a result, Bot Agent could not download the dependencies and the bot did not execute.</p> <p>Service Cloud case ID: 00951927, 01822836, 01801869, 01874596</p>
<p>You can edit and save device credentials on the <b>My Settings</b> page without encountering errors.</p> <p>Previously, you were unable to save the device credentials.</p> <p>Service Cloud case ID: 01941151, 01943701, 01958822, 01858205, 01867974, 01862001, 01867845, 01921703, 01905028</p>
<p>Audit log details page displays complete text for all fields.</p> <p>Previously, text that was displayed for some of the fields were truncated.</p> <p>Service Cloud case ID: 01908673</p>

On the **Historical** page, the activities details page displays the correct status for bots that are stopped from executing.

Previously, the status for such bots was displayed as failed.

Service Cloud case ID: 01835612, 01962900

When an AAE\_Admin tries to delete a user, a prompt is displayed with the list of resources that the user is associated with. This list includes resources such as licenses, schedules, pools, lockers, queues, and credentials. This information helps the administrator to disassociate the user from the resources before deleting the user.

Previously, a generic message was displayed before a user was deleted.

Service Cloud case ID: 01255043, 01761442, 01764557, 01800227, 01807149, 01927012, 01804960, 01949491, 01970079

Bot Agent can now successfully download the packages to device during bot deployment even if the repository path is a Distributed File System (DFS) path.

Previously, if the repository path was set to a DFS path, Bot Agent was not able to download the packages to device and bot deployment failed.

Service Cloud case ID: 01940976

When Bot validation feature is enabled and if you pass a **File** type variable from the parent to child bot, you no longer encounter the preprocessing error during runtime. As a result, you can run the bot successfully.

Previously, a **File** sub-type was handled incorrectly and validated against string rule during bot validation. As a result, you were unable to run the bot when file variable was used in the Task Bot.

Service Cloud case ID: 01969744

When you update the cloned bots by replacing older dependencies with the new ones and check in these bots to the public workspace, the update is retained when another user checks out this updated bot.

Previously, when another user checked out this updated cloned bot, the older dependency remained along with the new one.

Service Cloud case ID: 01948590

When you restore your bots and their dependent files from Git to your server repository, the version information is retained in the correct order. When the Git restoration process is complete, the bots and files contain the same version as the source.

Previously, version information was not restored in the correct order. The bot restored was not of the same version as its source.

Service Cloud case ID: 01924034

When you update to Automation 360 v.24 or later and the Control Room server repository is on a user network file path, if you import bots that contain a large number of bot or non-bot file dependencies, the bot now imports successfully.

Previously, the bot import failed with an error.

Service Cloud case ID: 01807824, 1815889, 01831729

<p>When a large number of users perform concurrent bot check-in operations and if the bot contains multiple dependencies, the concurrent check-ins are completed without delay.</p> <p>Previously, the check-in operation was slow, affecting other repository actions and the Control Room performance.</p> <p>Service Cloud case ID: 01944887, 01964122</p>
<p>When you update to Automation 360 v.29, code analysis rules are now retained for configured policies.</p> <p>Previously, code analysis rules were not retained in the active policy after the update.</p>
<p>When you update to Automation 360 v.29, you can now seamlessly view and execute bots without encountering any issues.</p> <p>Previously, there was a delay and error in displaying the view and run bot functionality due to an inconsistency in the global database configuration.</p> <p>Service Cloud case ID: 01978351, 01978355, 01978359, 01978371, 01978389, 01978376, 01978393</p>
<p>When you update to Automation 360 v.29, bot check-in works properly without any issue even when Git has an older configuration.</p> <p>Previously, bot check-in failed displaying an error with older version of Git because of the missing <code>auth_type</code> record in the database.</p> <p>Service Cloud case ID: 01983953</p>
<p>On the <b>Audit log</b> page, when you select the source type as <b>Event type</b> or <b>Source</b>, the corresponding drop-down values are sorted in alphabetical order.</p> <p>Previously, the order was random for these source types.</p> <p>Service Cloud case ID: 00805794, 01908670, 01766369</p>
<p>The Automation 360 installer shows an appropriate warning message when Elasticsearch service is not running.</p> <p>Previously, the warning message was not clarifying the issue.</p> <p>Service Cloud case ID: 01967255</p>
<p>On the <b>Create Active Directory role mappings</b> page, the <b>Active Directory domain</b> option lists domain names as NetBIOS names.</p> <p>Previously, domain names were displayed as fully qualified domain names (FQDN).</p>
<p>API Task is designed for Automation 360 cloud deployments only and is not available for On-Premises deployments.</p> <p>Previously, during the beta release, API Task was made available in the On-Premises deployments for a brief period.</p>
<p>You no longer encounter issues when you create a bot and disable any action (the disabled action has no data or contains errors) in the code.</p> <p>Previously when you executed such bots, it failed with an error.</p> <p>Service Cloud case ID: 01952661</p>



<p>If <b>Auto update</b> is enabled for Bot Agent in the Control Room, the registered devices running Windows10 Enterprise no longer restart after the Bot Agent update.</p> <p>Service Cloud Case ID: 01950021</p>
<p>After a successful installation of the Bot Agent on a device, the Bot Agent service is registered correctly and is displayed on the Windows <b>Services</b> page.</p> <p>Service Cloud Case ID: 01797914</p>
<p>After updating to this release, you can delete a registered device from the Control Room without any issues.</p> <p>Service Cloud Case ID: 01903472, 01914698</p>
<p>Security vulnerability issue fixed in the <code>crutils.jar</code> file.</p> <p>Service Cloud case ID: 01955093</p>
<p>Automation Co-Pilot (AARI) end points include the HTTP Strict Transport Security (HSTS) response headers.</p> <p>Previously, the response headers were missing in the Automation Co-Pilot end points.</p> <p>Service Cloud case ID: 01926041</p>
<p>In a form with a text field that has a max character limit, when a value from a previous task is inherited an error will display. This was fixed in Cloud build 17557 and On-Prem build 17571.</p> <p>Service Cloud case ID: 01969999</p>
<p>After you update to Automation 360 v.29, no error messages are shown as separated characters.</p> <p>Previously, when you update to Automation 360 v.29 and system language was set as non-English language, for example Japanese, error messages were shown as separate characters.</p> <p>Service Cloud case ID: 01986699, 01988909</p>
<p>The format of date data passed from bot to form now transfers accurately. Previously, the date format was changed during transfer.</p>
<p>You can now manually enter any time value between 00:00 to 00:45 when entering time (24-hour format) in forms. Previously, the values entered defaulted to the nearest 15-minute interval.</p> <p>Service Cloud case ID: 01963769</p>
<p>In the Bot editor, the <b>Create a request</b> action in the Process Composer package now supports table variables. This allows you to pass the data of a table to the initial form during run time in Automation Co-Pilot.</p>
<p>If an error is present in a mandatory field the submit button is disabled. Previously, when using forms in build 16667 the button remained enabled during first attempts.</p> <p>Service Cloud case ID: 01949368</p>

Check box values render as expected in web forms. Previously, an inconsistency occurred from designing the form, causing the rendered check box value to be inaccurate.

Service Cloud case ID: 01951738

When you navigate through page numbers on the **Average time to spent to create a Task Bot** tab, the dashboard sorts and shows the bots list correctly.

Previously, when you navigate through page numbers, the dashboard showed inconsistent data even if the same page was clicked.

Service Cloud case ID: 01820655

Build 18345: This build includes the following fix.

When a user clicks the cancel button of a form, in a **Cancel Human task** action, the form validation is ignored and the process moves to the endpoint to cancel the task. Previously, when a user clicked the button the form validation was considered and mandatory fields or errors could cause the form to not be submitted.

On On-Premises deployments, the heap size of the Ignite services no longer causes the Control Room to be unresponsive.

Previously, the Control Room used to become unresponsive in such a scenario.

Service Cloud case ID: 02002563

## Limitations

For a queue in draft mode, when you edit the general settings such as **Max auto retry attempt**, you cannot save the changes. Additionally, it generates an error message.

For users with more than 1000 schedules (active or inactive), the **Scheduled activity** page might not load properly. At times, you might encounter an error message while browsing the schedules across pages.

Workaround: To view the list of schedules, you can filter and sort the schedules by status.

Process Discovery (Discovery Bot) has been removed from the Community Edition, but there is a non-functional link to Process Discovery (Discovery Bot) on the home page that needs to be ignored.

Workaround: Ignore the non-functional link in the Community Edition.

There might be a mismatch in the Bot Agent update required data in device dashboard with that of the **Devices** page. This mismatch is because the **Devices** page shows the data about only online devices whereas the device dashboard shows the data about all devices (online and offline).

When you export or promote bots or files that are checked in before January 2021, you might encounter an export or bot promotion error.

Workaround:

1. Check out the bot.
2. Check in the bot without making any changes to it. A new version of the bot is created.
3. Export or promote the bot.

After you update to Automation 360 v.29, the bot check-in fails with an error message.

To fix this issue, perform one of the following steps:

- Delete all the cloned bot copies (if multiple users cloned the bot, delete them from all users) and check in the bot.
- Create the same folder structure under other users who cloned this bot and does not have the new folder structure (that has been modified during the check out).

Trigger listeners is not supported when you use an auto login that is configured from an external key vault.

Importing bots and packages from the Bot Store does not work in Automation 360 v.29 for all users. The Bot Store import action fails, and the import remains either in **IN\_PROGRESS** or in **FAILED** status in the Bot Store downloads page.

Workaround: See [A360.29 | Importing bots and packages from Bot Store does not work \(A-people login required\)](#).

Service Cloud case ID: 02001442, 02002465, 02000881

#### Limitations from previous releases

While running a bot in debug mode, the bot will fail if the variable size gets greater than 3 MB. An error message appears showing that a variable has exceeded the 3 MB limit.

After you update Automation 360 to v.28, when you cancel the update process after removing all the services, the rollback of the services does not happen. As a result, you will encounter an error message, when you attempt Automation 360 update.

Bots that are in the **Queued** status do not appear automatically on the **In progress activity** page.

Workaround: Click the **Refresh table** button on the top-right corner of the activity table to view the queued bots.

## Feature deprecations

Review features and capabilities (from Automation Anywhere or other third-party vendors) that are deprecated or nearing deprecation to understand how they impact your automation.

The user interface for the Automation 360 product will no longer support Italian, Russian, and Simplified Chinese languages. In addition, updated release documentation will no longer be available in these three languages though English documentation will be accessible.

For a complete list of deprecations, see [Feature deprecations affecting Automation Anywhere products](#) on page 1086.

Microsoft has deprecated EWS API for Exchange Online and has recommended that users move to Graph API. See [Upcoming API Deprecations in Exchange Web Services for Exchange Online](#).

**Note:** We recommend that you update the impacted bots by replacing each email-related action with the equivalent new action in the Microsoft 365 Outlook package (based on Graph API).

[Microsoft 365 Outlook package updates](#) on page 917 | [Microsoft 365 Outlook package](#) on page 2851

## Updates to the interface

Review the updates to the interface in this release.

See the following video for the updates in the interface for Automation 360 v.29 release:

The **External Key Vault Integration** page is simplified to easily select and configure key vaults when installing the Control Room.

[Integrate HashiCorp Vault to retrieve credentials](#)

The **Licenses** page is simplified to segregate the licensing information.

[View license drill down for users and Control Rooms](#)

The **Attention needed** filter is added in the notification panel to simplify the notification categories.

[Simplified notifications categories](#)

The **Time filter** field is added to search, view, and customize the historical activities based on the selected time duration.

[Time filter for historical activities](#)

The **Edit** option is added for in-use queues to update the queue details and process queues faster.

[Ability to edit workload management automations](#)

Move bots across environment easily with bot promotion.

[Move bots across environments](#)

The icon for a process has been updated in the Bot editor.

Variables for currentValue and currenKey are now visible in the variable picker, regardless of variable type.

[More visibility for variables](#)

## Updating to v.29 release

Review requirements and support information about updating your Control Room and Bot Agent for the v.29 release.

## Bot Agent updates

**Note:** This release includes an optional Bot Agent update. You can continue to run your existing bots without updating the Bot Agent. However, if you want to use the new features in Automation 360 v.29, you must update the Bot Agent available with this release.

For more information on updating to this release, see these resources:

- [Automatically update the Bot Agent](#) on page 1361 | [Manually update the Bot Agent](#) on page 1362
- [Compatibility with release builds](#) on page 1333

## Certified Control Room builds for direct update

You can update to the latest version of Automation 360 from the previous three releases (that is, from n–3 releases, where n refers to the latest release).

The following previous releases are certified for update to Automation 360 v.29:

- v.28 (Build 17571, 17566, 17542, 17506)
- v.27 (Build 16685, 16667)
- v.26 (Build 15450, 15459, 15439, 15436)

If you are on one of these previous releases, for information about updating, see [Update Automation 360 to latest version](#) on page 1423. If you are not on an n–3 release, update Automation 360 to one of the n–3 releases before updating to Automation 360 v.29.

## Migration updates for v.29 release

Review what's changed and fixed in Automation 360 v.29.

## What's changed

Migrate bots with greater than 10 nested loops

You can successfully migrate bots than contain more than 10 nested loops without any issues. The maximum number of nested loops supported is 97.

Service cloud case ID: 01936674

## Fixes

<p>When you migrate MetaBots that include large content variables using the Bot Migration Wizard, a new text file is generated and the filename for the text file is correctly displayed in the <b>Target Name</b> field on the migration wizard <b>Results</b> page.</p> <p>Previously, the filename was not displayed.</p>
<p>You can successfully migrate an Enterprise 11 bot created using the nested email loop condition (the first loop is not commented, whereas the second loop action is commented or vice versa), having an Email Automation command.</p> <p>Previously, migration of such bots showed nested email loop conditions (first and second loop), as commented.</p>
<p>You no longer encounter issues when you run an Enterprise 11 bot in Automation 360 containing the <b>SAP Standard BAPI</b> command. The scalar parameter now maps to Automation 360 variables even if you have not enabled the <b>Write to CSV</b> check box in the <b>SAP Standard BAPI</b> command.</p>
<p>You can successfully migrate an Enterprise 11 bot when it is using an array variable within a <b>Loop While</b> condition and the index position of the variable is greater than the size of the array.</p> <p>Previously, such a bot encountered an error if the index position of the variable was greater than the size of the array.</p>
<p>After updating to this release, errors are no longer displayed when you select the <b>Excel contains charts</b> check box in the <b>Open</b> action of the Excel advanced package to open an Excel file that contains a graph sheet.</p>
<p>After updating to this release, actions from the <b>App integration</b> package that uses Windows SDK will timeout when the target application stops responding or is in 'Not responding' state.</p>
<p>When you migrate a bot from Enterprise 11 that contains the <b>Run standard workflow</b> action from the <b>SAP BAPI</b> package, the scalar parameters are assigned to the corresponding variables correctly.</p>
<p>When you migrate an Enterprise 11 bot that uses the <b>Loop</b> action with <b>File exists</b> condition and if the variable value inside the condition changes, then the bot picks up the latest value of the variable with every loop iteration.</p>
<p>When you migrate an Enterprise 11 bot that uses the <b>Comment</b> action, the action will always remain in the enabled state even if it consists of variables as the variables will now be represented as \$\$\$. For example, when you add \$vArray\$ variable in the <b>Comment</b> action and migrate the bot, after migration it will be represented as \$\$vArray\$.\$.</p>
<p>You can migrate bots that use the Delay package in a loop where the delay value is set to 0.</p> <p>Previously, such bots encountered an error during bot execution.</p>
<p>When you migrate an Enterprise 11 bot which has Object Cloning command with <b>Image</b> play mode, the migration no longer fails for the currently selected active window. Also, it does not generate any error message.</p> <p>Service Cloud case ID: 01947195</p>

When you use the **String > Before or after** command in Enterprise 11 and if the number specified in the **No. of characters to be extracted** field is greater than the actual number of characters available before or after the specified text, the output shows consistent results. Additionally, it does not generate any error message.

When you migrate a bot that contains disabled if-else commands inside any active if-else block, the entire code in the bot is migrated without any issues.

Previously, when you opened the migrated bot in Automation 360, some lines of code were found missing. This issue occurred because when you migrated the bot, the disabled if-else code in the bot was skipped, and no error or warning was displayed in the migration wizard.

Service Cloud case ID: 01885648

## Remote agent v.2.3.2.24 updates

A new version of the Remote agent is released with Automation 360 v.29. This section includes the fixes for Remote agent version 2.3.2.24.

### Fixes

Automate business applications on remote devices accessed over VMWare VDIs

By installing our native Remote Agent on VMware server, you can now automate your business applications that are running on remote devices and are accessed over VMware VDIs. Our native Remote Agent enables secure communication between VMware server and and provides the object level information for automation creation and play back. This enhances the automation coverage to new use cases while providing a reliable native desktop user experience.

VMware-based automation is supported for all VMware protocols, viz VMware Blast, PCoIP, and Microsoft RDP. This eliminates the requirement for any security exceptions by IT administrators. VMware-based automation is supported for Web applications, Java applications and applications built on Microsoft Active Accessibility or UI Automation technologies.

You can now use the Recorder to capture and automate objects with a specific technology on Citrix XenApp applications. You can capture objects with the following technologies:

- Microsoft Active Accessibility (MSAA)
- UI automation

## Packages updated in v.29

Review updates to packages in Automation 360 v.29 including the compatible Control Room and Bot Agent versions.

### August 2023 package updates

We have updated specific packages in August, after the v.29 release. For a list of these packages, see [August 2023 updates](#).

### July 2023 package updates

We have updated specific packages in July, after the v.29 release. For a list of these packages, see [July 2023 updates](#).

## Packages updated in v.29 release

The following table lists packages updated for this release. Click the package version to view updates (what's new, changed, or fixed) in this package.

Package	Version	Bot Agent version	Control Room version
Active Directory	<a href="#">3.8.0</a> on page 841	20.11 or later	8750 or later
Advanced Classifier	<a href="#">2.0.4</a> on page 842	21.250 or later	17953 or later
Apigee	<a href="#">1.1.1</a> on page 844	21.222 or later	15422 or later
App Integration	<a href="#">4.12.0</a> on page 845	21.88 or later	10195 or later
Application	<a href="#">3.8.0</a> on page 846	20.11 or later	8750 or later
Boolean	<a href="#">2.9.0</a> on page 848	20.11 or later	8750 or later
Bot Migration	<a href="#">10.6.2</a> on page 850	21.220 or later	15224 or later
Browser	<a href="#">3.9.0</a> on page 852	21.210 or later	14140 or later
Clipboard	<a href="#">3.7.0</a> on page 853	20.11 or later	8750 or later
Comment	<a href="#">2.14.0</a> on page 854	20.11 or later	8750 or later
Credential	<a href="#">1.6.0</a> on page 856	20.11 or later	8750 or later
CSV/TXT	<a href="#">2.12.0</a> on page 857	20.11 or later	8750 or later
Data Table	<a href="#">4.8.0</a> on page 858	20.11 or later	8750 or later
Database	<a href="#">4.12.2</a> on page 861	21.88 or later	10204 or later
Datetime	<a href="#">2.12.1</a> on page 862	20.11 or later	8750 or later



Package	Version	Bot Agent version	Control Room version
Delay	<a href="#">3.8.0</a> on page 863	20.11 or later	8750 or later
Dictionary	<a href="#">3.12.0</a> on page 865	20.11 or later	8750 or later
DLL	<a href="#">6.9.0</a> on page 866	21.22 or later	15238 or later
Document Extraction	<a href="#">3.29.14</a> on page 873	21.98 or later	15345 or later
Email	<a href="#">3.17.6</a> on page 875	21.210 or later	13980 or later
Email trigger	<a href="#">2.10.2-20230106-091325</a> on page 877	21.210 or later	13980 or later
Error handler	<a href="#">2.11.3-20230316-162433</a> on page 878	20.11 or later	8750 or later
Excel advanced	<a href="#">6.15.1</a> on page 880	21.112 or later	11307 or later
Excel basic	<a href="#">6.15.0</a> on page 881	21.112 or later	11307 or later
File	<a href="#">6.7.0</a> on page 883	21.98 or later	10789 or later
Folder	<a href="#">6.7.0</a> on page 885	20.11 or later	8750 or later
FTP / SFTP	<a href="#">2.10.1</a> on page 887	20.11 or later	8750 or later
Google Calendar	<a href="#">2.11.2</a> on page 890	20.11 or later	8750 or later
Google Drive	<a href="#">2.12.2</a> on page 891	20.11 or later	8750 or later
Google Sheets	<a href="#">2.12.2</a> on page 893	20.11 or later	8750 or later
Hot key	<a href="#">1.5.0-20230323-050200</a> on page 894	20.11 or later	8750 or later
If	<a href="#">3.6.2-20230316-161323</a> on page 895	20.11 or later	8750 or later
Image Recognition	<a href="#">3.15.2</a> on page 897	21.210 or later	14100 or later
Interactive Forms	<a href="#">2.29.1-20230403-101855</a> on page 899	20.11 or later	8750 or later
IQ Bot	<a href="#">2.4.5</a> on page 901	21.98 or later	10520 or later
Document Classifier	<a href="#">2.5.4</a> on page 900	21.98 or later	10520 or later
IQ Bot Pre-processor	<a href="#">2.4.4</a> on page 902	21.98 or later	10520 or later
JavaScript	<a href="#">2.15.0</a> on page 903	20.11 or later	8750 or later
JSON	<a href="#">1.4.1</a> on page 904	21.98 or later	10520 or later

Package	Version	Bot Agent version	Control Room version
Legacy Automation	<a href="#">6.2.0</a> on page 906	21.200 or later	13279 or later
List	<a href="#">2.11.0</a> on page 907	20.11 or later	8750 or later
Loop	<a href="#">3.7.5-20230316-155504</a> on page 909	20.11 or later	17208 or later
Message Box	<a href="#">3.6.0</a> on page 910	20.11 or later	8750 or later
Mouse	<a href="#">2.14.0</a> on page 921	21.210 or later	14100 or later
Microsoft 365 Calendar	<a href="#">2.12.1</a> on page 912	20.11 or later	8750 or later
Microsoft 365 Excel	<a href="#">2.12.1</a> on page 914	20.11 or later	8750 or later
Microsoft 365 OneDrive	<a href="#">2.12.1</a> on page 916	20.11 or later	8750 or later
Microsoft 365 Outlook (New)	<a href="#">1.0.1</a> on page 919	21.210 or later	13980 or later
Number	<a href="#">3.8.0</a> on page 922	20.18 or later	9130 or later
OCR	<a href="#">2.12.1</a> on page 923	21.118 or later	8750 or later
PDF	<a href="#">3.9.0</a> on page 925	21.31 or later	9300 or later
PGP	<a href="#">3.6.0</a> on page 926	21.88 or later	10195 or later
Ping	<a href="#">3.5.0</a> on page 927	20.11 or later	8750 or later
Play Sound	<a href="#">2.6.0-20220421-071315</a> on page 928	20.11 or later	8750 or later
Process Composer	<a href="#">7.29.0-20230509-185211</a> on page 931	21.134 or later	12316 or later
Prompt	<a href="#">2.7.1</a> on page 932	20.11 or later	8750 or later
Python Script	<a href="#">2.15.0</a> on page 933	20.11 or later	8750 or later
Rest Web Services	<a href="#">3.14.0</a> on page 945	20.11 or later	8750 or later
Record	<a href="#">1.8.2</a> on page 934	21.134 or later	17917 or later
Recorder	<a href="#">2.11.5-20230512-083852</a> on page 941	21.210 or later	14068 or later
SAP	<a href="#">3.10.0</a> on page 949	21.88 or later	10195 or later
SAP BAPI	<a href="#">2.9.0</a>	21.2 or later	9249 or later

Package	Version	Bot Agent version	Control Room version
Salesforce	<a href="#">1.3.2</a> on page 946	21.222 or later	15422 or later
Screen	<a href="#">2.9.2</a> on page 950	20.11 or later	8750 or later
Services	<a href="#">4.8.0</a> on page 951	20.11 or later	8750 or later
ServiceNow	<a href="#">1.1.1</a> on page 953	21.230 or later	16455 or later
SharePoint	<a href="#">1.0.4</a>	21.250 or later	18000 or later
Simulate keystrokes	<a href="#">4.2.0</a> on page 956	21.200 or later	13297 or later
SNMP	<a href="#">2.7.1</a> on page 957	20.11 or later	8750 or later
SOAP Web Service	<a href="#">3.15.0</a> on page 959	21.90 or later	10227 or later
String	<a href="#">5.7.1</a> on page 961	20.18 or later	9130 or later
System	<a href="#">3.12.0</a> on page 962	21.88 or later	10217 or later
Task Bot	<a href="#">2.7.2-20230316-160508</a> on page 964	20.11 or later	8750 or later
Terminal Emulator	<a href="#">4.10.0</a> on page 966	21.93 or later	10353 or later
V11 Task Bot	<a href="#">1.14.0</a> on page 968	20.11 or later	8750 or later
Text file	<a href="#">1.6.0</a> on page 967	20.11 or later	8750 or later
VBScript	<a href="#">2.19.0</a> on page 969	21.210 or later	14100 or later
Wait	<a href="#">4.9.0</a> on page 971	20.11 or later	8750 or later
Window	<a href="#">5.10.0</a> on page 972	20.11 or later	8750 or later
Workday	<a href="#">1.1.4</a> on page 973	21.231 or later	17076 or later
XML	<a href="#">3.10.0</a> on page 975	20.11 or later	8750 or later

## Packages not updated in v.29 release

The following table lists packages that have not been updated in the Automation 360 v.29 release but are compatible with this release.

Package name	Version	Bot Agent version	Control Room version
Analyze	2.8.0-20230427-091823	20.11 or later	8750 or later
File and Folder	1.3.0-20221014-182105	20.11 or later	8750 or later
Google G Suite	2.8.0-20220416-235104	20.11 or later	8750 or later

Package name	Version	Bot Agent version	Control Room version
Legacy AISense	2.1.0-20221219-144922	21.220 or later	15224 or later
Service trigger	1.5.1-20220425-083711	21.112 or later	11314 or later
Step	2.5.0-20230105-135537	20.11 or later	8750 or later
Trigger Loop	0.7.0-20220715-220725	20.11 or later	8750 or later
Window trigger	1.4.0-20220118-154823	20.11 or later	11314 or later

## CoE Manager v.29 release

Review what's new in CoE Manager for the v.29 release.

### What's new

#### Accelerate your automation success with CoE Manager Plus

Get advanced capabilities, customizations, and integrations to optimize your automation program performance with CoE Manager Plus. You can track transaction-level ROI metrics and capture key insights regardless of the platform you use. CoE Manager Plus provides you a holistic view of your ROI across a more complex automation landscape.

[CoE Manager Plus](#)

#### Expand organization hierarchy for focused ROI tracking

You can expand the existing business units in CoE Manager to create multiple sub-level units (geographies, business units, departments, and teams) and link opportunities to these sub-level units. For example, consider the business unit Finance. You can build sub-level units of Accounts Receivable and Accounts Payable under Finance. You can further build sub-levels such as Invoicing, Credit and Collections, Debt Management, and Cash Application under Accounts Receivable. This hierarchy capability provides a clear understanding of how many opportunities were submitted from different areas of the organization, how many were automated, and measures the ROI generated from each area. At every level, the ROI is rolled up from sub-levels to provide a comprehensive view of how each department or business unit is performing.

[Set up organization hierarchy and link opportunities](#) on page 2062

#### Standardize activity types with predefined activities template

Based on their organizational standards, an administrator can define additional activity types to add to the following predefined activity types:

- Business Case
- Requirements
- Design
- Infrastructure Setup
- Build
- Test
- Deploy

To maintain consistency across all opportunities, users can select activities from these predefined templates to build automation projects. Using predefined templates drives standardization and provides better visibility and reporting capabilities.

#### Calculate ROI based on individual transactions

In addition to execution count-based tracking, CoE Manager now facilitates volume or transaction count-based value tracking. You can calculate the return on investment (ROI) based on the number of transactions a bot performs for any given day, week, month, or quarter. Transaction-based ROI provides a more granular level of tracking that you can use to assess cost savings and improvement changes affected by processing multiple transactions.

[#unique\\_248/unique\\_248\\_Connect\\_42\\_roi-tracking](#)

## Automation Co-Pilot for Business Users v.29 release

Review what's new and changed, and the fixes and limitations in Automation Co-Pilot for the v.29 release.

**Important:** Starting from this release, we have moved information about updates in each (such as what's new, changed, fixes, and limitations) to -specific pages. You can access these pages by navigating to [Package updates overview](#) on page 835 > <-name> releases.

For a consolidated list of packages updated in this release, see [Packages updated in v.29](#) on page 104.

## What's new

#### Queue automations

In the Automation Co-Pilot Desktop Assistant, you can view multiple bot deployments in a queue. You can refer to the **Queue** page to view pending bots that are sorted by progress, including bots with trigger events that were initiated. This also grants you more control over each bot instance, with your ability to remove queues individually or bulk, and to start or stop any bot progress.

[Queue automations](#) on page 3365

#### Dropdown Multi-Select form element

In the form composer, you can use the new Dropdown Multi-Select form element to create a drop-down menu with values in your forms. This element will enable you to specify more than one value in a drop-down menu that another user can select in a form.

[Using the Dropdown Multi-Select element](#) on page 3442

#### Map host data with input variables

You can use attended bots with input variables to map data in a host application. When you run your automations in the embedded widget, the values of input variables will be populated based on data of the host application that you configured.

[Map host data using bot inputs](#) on page 3322

#### Set supported language as URL parameters

You can set specific language settings to your URL for host applications using Automation Co-Pilot. This provides you with instant localization for supported languages without the need for you to access language options in a settings menu. For instance, you can add **lang=en\_US** or **lang=fr\_FR** at the end of your URL to localize your contents to a specified language.

[Automation Co-Pilot for Business Users supported features](#) on page 3312

#### View hidden elements in form composer

In form composer, when you define hidden elements, you will be able to view the hidden element as URL parameters in your URL address. For example, if a hidden element is set to a language value, the URL will reflect this and show as **hiddenelement0=EN\_US** in the URL. This gives you a quick reference of your defined hidden elements when you view the URL.

[Automation Co-Pilot for Business Users supported features](#) on page 3312

#### Attention toggle in notifications

The **Need Attention** toggle in the notifications tab enables you the ability to filter between all notifications and notifications that requires action, for your embedded widget. When you select this toggle, only notifications that require your attention is filtered. This helps you focus and prioritize on the important notifications. You can also refresh to load new notifications.

[Automation Co-Pilot for Business Users supported features](#) on page 3312

#### Search and filter in an embedded widget

You can search and filter your automation list in your embedded widget. When you filter, you can use the name toggle to organize by ascending or descending names. You can also search for specific keywords to quickly identify your automation.

#### Assign a process to roles

Processes can now be assigned to roles. Adding a role to a process makes it available to cross-functional team members, regardless of their assigned team. A process can still be added to a team. However, managing a process by role can make common business tasks consistent and accessible for all users with a set role.

[Manage a process in Automation Co-Pilot](#) on page 3378

## What's changed

#### Improvements for running processes

Documentation has improved to provide clarity on running a sub-process containing a form within a parent process.

Service Cloud case ID: 01966950

[Run a process automation](#) on page 3484

#### Delete requests by any status

For easier storage clean up of processes in a private folder, you can now delete requests (by users with permission) regardless of what status the request is in. Previously, you could not delete requests in open status.

Service Cloud case ID: 01959212

## Fixes

Build 18371 (On-Premises): This build includes the following fixes (along with fixes from the previous builds):

After you update to Automation 360 v.29, no error messages are shown as separated characters in the AARI request field.

Previously, when you update to Automation 360 v.29 and system language was set as non-English language, for example Japanese, error messages were shown as separate characters.

Build 18345 (On-Premises): These builds includes the following fix (along with fixes from the previous builds):

When you select a date in the date field after a form is submitted, the date value now accurately shows the correct date and time. Additionally, no error messages will prompt you of the date and time.

Service Cloud case ID: 01978996

When you specify the source date time variable in your bot, to pass to your bot, the time field now correctly displays the time.

Service Cloud case ID: 01980392

When starting the Automation Co-Pilot for Microsoft Teams integration, the Auth pop-up window closes, as intended, after credentials are entered for users with an AARI license.

The **Duplicate Row** option is available when you use the **Table** element.

In a host application, you can deploy your bots and processes in the embedded widget without issues. Previously, the bots and processes would not deploy when host data was unavailable. This has been fixed to allow a bot and process to run regardless if there is no host, with or without listeners, and, with or without data inputs.

The date values in your form will now correctly display the time zone when the data is passed to the bot.

Service Cloud case ID: 01979645, 01978931, 01980392, 01982621, 01986377

In historic activity, when you view bots that have encountered an error, you can view the error message details in the **Error message** section. Previously, error messages would not generate.

Service Cloud case ID: 01850454, 01908923

When you use a date element in your forms, and you generate a date data in the date field and then delete the data, the date data will be removed or updated if you specified a different data.

Service Cloud case ID: 01944363

In Automation Co-Pilot Desktop Assistant, when you use the search and replace feature for form variables, you are now able to search and replace your form variables.

Attended bot runner users that are running Automation 360 v.29 build 18361 should have the permission View Users and Roles basic information assigned in the role settings. An error message might display upon logging in for users without this permission assigned.

Service Cloud case ID: 01997194

## Limitations

When you deploy a bot, the initial start date and time of the bot will show the wrong date and time details. The correct date and time will be updated when the bot is progressed.

Service Cloud case ID: 01982920

When you log in to the Salesforce application, you will be able to run your bots and processes through the your embedded widget without issues. However, if your session expires and you re-authenticate, you will not be able to run your automation.

Workaround: Refresh the current page and it will function normally.



In Automation Co-Pilot Desktop Assistant, when you log in as an attended user, but you do not have access to a child bot, and you attempt to run a parent bot instead, an error message will prompt and notify you that you no longer have permission to access the child bot and will not return to a normal state. This error message still persists when you log in again.

Workaround: You can press the F5 key to refresh the page and it will load to a normal state.

When you use a Table element in your forms, the **Duplicate row** option is not available for you to select. Though there are no workarounds for this limitation, you can continue to add rows to your table, and duplicate rows that were previously created are not effected.

The authentication pop-up window does not close when launching Automation Co-Pilot for Microsoft Teams desktop client for two types of users:

- The first Admin user created after a Control Room installation
- Users with out an AARI license associated

The pop-up window asks for credentials. However, after entering and submitting credentials the window remains open. We are currently working to resolve this issue.

## Updates to the interface

Review the updates made to the interface for Automation Co-Pilot v.29 release.

Requests in a private folder can now be sent to the recycle bin or hard deleted (by users with permission).

[Delete any request](#)

When completing a form, a search field is now available in drop-down menus with ten or more options.

Service Cloud case ID: 01875095

A process can now be added to roles.

[Assign process to role](#)

View the queue of your attended bot automation.

[Queue automations](#)

Use the Dropdown Multi-select Element in form composer.

[Dropdown Multi-Select element](#)

Specify a supported language as a URL parameter.

[Supported language URL parameter](#)

Use the Need attention toggle to filter your notifications that requires attention.

[Need attention toggle](#)

## Document Automation and IQ Bot v.29 release

Review what's new and changed, and the fixes and limitations in IQ Bot and Document Automation for the v.29 release.

**Important:** Starting from this release, we have moved information about updates in each (such as what's new, changed, fixes, and limitations) to -specific pages. You can access these pages by navigating to [Package updates overview](#) on page 835 > <-name> releases.

For a consolidated list of packages updated in this release, see [Packages updated in v.29](#) on page 104.

### Document Automation

What's new
<p>Validate table data quicker using auto fill</p> <p>You can use the <b>Auto fill</b> button in the validation interface to extract hundreds of rows of data from multipage tables. After you manually validate three cells in a column, auto fill extracts the remaining values from that column in the document.</p>
<p>Use Advanced Classifier package in Document Automation</p> <p>You can use the Document Automation Advanced Classifier package to classify documents and pages, and split documents into a folder structure. You can upload documents from the folders to their respective learning instance to extract content in Document Automation. You must set up a Skillja license in a credential vault to run a bot containing actions from this package.</p> <p><a href="#">Advanced Classifier package</a> on page 2401</p>
<p>Document Automation support for Google Custom Document Extractor</p> <p>You can now create a user-trained learning instance in Document Automation and extract it using a Google Custom Document Extractor (CDE) processor. You can use this new capability to train a model using Google CDE for any document type, and it supports 30 languages. After you deploy a model, you can embed the processor URL within the Document Automation extraction process. To use this capability, you must have an Automation Anywhere Document Workspace license and a valid subscription to Google CDE.</p>
<p>Improved heuristic feedback with form and table extraction</p> <p>Document Automation provides an improved extraction through heuristic feedback with a focus on complex scenarios, such as multi-tables. Additionally, there are extraction improvements for both form fields and out-of-the-box performance (specifically for table fields).</p>

What's new
<p>Document-level data validation in Document Automation</p> <p>With document-level data validation, you can create rules to ensure the accuracy of extracted data across multiple fields in your documents. You can define various conditions, such as pattern matching or equality checks. When those conditions are met, you can effortlessly take action to flag errors or warnings, clean up or replace values, or set new values.</p> <p><a href="#">Validation rules in Document Automation</a> on page 3651</p>

What's changed
<p>In Standard Forms, you can create and train new models in Microsoft Form Recognizer v3.0 only. You can use existing models in Microsoft Form Recognizer v2.1, however, you cannot create new models.</p>
<p>Microsoft Form Recognizer Studio integrated with Document Automation is compatible only with v.3.0 model for all future model creations.</p>
<p>As of Automation 360 v.29, Document Automation Standard Forms supports the check box type for forms and table fields. The Standard Forms learning instance has an additional <b>check box</b> field data type and the extraction result can be one of the following:</p> <ul style="list-style-type: none"> <li>• Checked</li> <li>• Unchecked</li> <li>• Not found (if the system is unable to extract the result)</li> </ul> <p>For any Standard Forms learning instance that was created before Automation 360 v.29 and has a check box field, you must update the data type for the check box field at the learning instance level.</p>
<p>Enhancements were made in the Validator to improve the validation process in Document Automation.</p>
<p>For Automation 360 v.29 release and later releases, the learning instance export and import functionality has been enhanced to include the ability to copy heuristic feedback data with the configuration. You can seamlessly move your feedback data from one environment to another without any data loss. As a result, this feature significantly reduces the need for rework, ultimately saving valuable time</p>

Build 18345: This build includes the following fixes (along with fixes from the previous builds):

Fixes
<p>In Validator, if you enter a valid entry or data in the field, and click outside of it, the field is validated.</p> <p>This was a limitation in previous builds 18332, 18302, 18277 (Cloud-Sandbox) and build 18324 (On-Premises).</p>

Fixes
<p>When <b>Extract field using pattern</b> is chosen in the learning instance and the document is processed, the field is validated on entering valid data. Here, only the respective field is affected, and its extraction is based on the provided regular expression input.</p> <p>This was a limitation in previous builds 18332, 18302, 18277 (Cloud-Sandbox) and build 18324 (On-Premises).</p>

Build 18277: This build includes the following fixes:

Fixes
If a table name in the Validator has more than 50 characters, the field name in the table is now displayed when you hover over it. Previously, the table name was not displayed.
If a field name in the Validator has more than 100 characters, the scroll bar appears and you can see the value of the form field. Previously, the form field name was not displayed.
The run analysis result is displayed in Standard Forms when creating a v3.0 model with multiple pages.
You can now use the advanced check-out options for bots that contain actions from the Document Extraction package.
If you upload documents to a custom process instead of a Document Automation auto-created process, the Download bot now successfully downloads the CSV of extracted data and deletes the uploaded files from temporary storage.
The Automation Anywhere Control Room now tracks Document Automation license consumption in newly-installed cluster Linux environments.
Imported learning instances now have pattern-based validation enabled by default.
You can now submit a document that has a pattern validation rule with a regular expression that contains the pipe symbol ( ).
In the Bot Insight, the <b>Unknown</b> option under <b>OCR Engine</b> attribute for Google Document AI provider has been removed from the <b>Document Workspace</b> dashboard. Now the filter displays <b>ABBYY</b> as the OCR engine, ensuring better clarity and accuracy in filtering options.
Extraction is now successful when creating a learning instance in Document Automation using a custom domain. Previously, uploading a document for the learning instance using a custom domain would result in extraction failure, but this issue has been resolved. Service Cloud case ID:01967442
Documents with Windows OS user-names containing more than 17 characters can now be processed successfully in the latest package of Document Automation. Previously, attempting to process such documents would trigger an error message stating, <b>The File cannot be processed, it may be corrupted. Please contact technical support if the file is valid.</b> Service Cloud case ID:01951382, 01950245

Fixes
<p>The Document Extraction package now successfully extracts documents when the option to store the output files on the server is chosen in a stand-alone setup. Previously, selecting the option to upload the output to the server would result in a failure of the <b>Extraction</b> action, accompanied by the error message <code>DW_EXTRACT_FAILURE 500</code>.</p> <p>Service Cloud case ID:01943058, 01972932</p>

Limitations
<p>The check box feature (in preview mode) might result in inconsistent extraction for the check boxes field, which could lead to inconsistent results. In such cases, if the system is unable to accurately extract the check box field value, it will be labeled as <b>Not Found</b>.</p>
<p>If a learning instance name contains a space, then the downloaded file name will have the space replaced with the encoded value <code>%20</code>. For example, if the exported learning instance name is <code>Test 123</code>, then the file name is displayed as <code>Test%20123</code>.</p>
<p>With the implementation of new document level rules, if the condition is based on a <b>Form Field</b> and the resulting action should affect a <b>Table Field</b>, the expected outcome is not reflected in the Validator.</p>
<p>You will not be able to use the <b>Extract field using pattern</b> for a table field with a custom alias.</p> <p>Workaround: On removing the regular expressions (regex), the extraction works as expected with the custom alias.</p>
<p>When the table name in the Microsoft Form Recognizer Studio UI exceeds 99 characters, the UI does not handle it properly.</p>
<p>On creating a validation rule with <b>does match regex</b> condition and <b>show error</b> action, a custom error is shown for a field with no extraction.</p> <p>Workaround: If condition is <b>does match regex</b>, add another <b>AND</b> along with <b>is not empty</b> condition to use the action <b>show error</b>. This will not display any error over fields with no extraction.</p>
<p>While creating or editing a learning instance, if you select the <b>Extract field using pattern</b> check box and then subsequently clear it without entering a value in the regular expression field, the <b>Create</b> button remains disabled even if all other mandatory fields have been entered.</p> <p>Workaround: Enter value in the regular expression field, and then clear the <b>Extract field using pattern</b> check box.</p>
<p>If you select the <b>Chinese</b> language in AARI interface, the auto-fill button label does not update to reflect the selected language during validation.</p>

Limitations
<p>If you process a document with Google Custom Document Extractor, the extraction is failing for the below languages:</p> <ul style="list-style-type: none"> <li>Albanian</li> <li>Croatian</li> <li>Finnish</li> <li>Icelandic</li> <li>Slovenian</li> <li>Vietnamese</li> </ul>
<p>(Service Cloud Case ID: 01981332, 01981088) During extraction, the heuristic feedback does not provide values for certain fields in cases where the previous mappings contain non-English characters, such as Arabic characters or text with single quotes (').</p>
<p>While editing a learning instance, if you use the <b>Up</b> or <b>Down</b> buttons to change the value of the <b>Confidence</b> level and click the <b>Update</b> button, the changes are not retained.</p> <p>Workaround: Ensure that you enter the value that you want to increase or decrease for the <b>Confidence</b> level.</p>
<p>For the Community Edition:</p> <ul style="list-style-type: none"> <li>Google Vision OCR will not be displayed as it is not supported.</li> <li>Document extraction using Google CDE or Google Document AI (User-defined) is not supported.</li> </ul>

## IQ Bot

Fixes
<p>The first time you click a learning instance connected from Automation 360 IQ Bot, you are directed to the details page for that learning instance. Previously, you were redirected to the IQ Bot home page instead.</p>
<p>Automation 360 IQ Bot now shows the correct error message if you upload a corrupted document to a manual group.</p>
<p>You can now use more than 54 categories for the <b>Train</b> and <b>Retrain</b> actions. This allows classification according to the provided training model files. Previously, the Classifier was unable to classify the files into categories if the number exceeded 54 categories.</p>
<p>You can now create and run the Document Classifier package with a variable in the child task bot. Previously, when you ran the task bot command with a variable to call the child task bot, it displayed an error.</p>

Fixes
You can now view the full Python script that is added to the <b>Python Logic</b> tab when you navigate from fullscreen to smallscreen after a test run. All the options such as <b>Test Run</b> , <b>Clear Box, fullscreen</b> , and <b>Save</b> are also visible. Previously, when you navigated from fullscreen to smallscreen, you could not view the Python script and the other options were hidden.
Healthcheck for an IQ Bot instance shows the correct <b>OK</b> status even if the instance is idle or accessed after a day. Previously, healthcheck showed a status of <b>NOT_OK</b> when the IQ Bot instance was idle or accessed after one day.
You can now export, import, upload, and download an IQ Bot archive (IQBA) file with a maximum file size of 5 GB.  Previously, if the IQBA file size was greater than 268 MB, then the file storage did not upload the exported file from the output folder to the desired location.
You can now import an IQBA file successfully into the learning instance. Previously, IQBA import was failing when the exported learning instance had certain training embedded in it with line break characters.

## Updates to the interface

Review the updates to the interface made to the interface in Document Automation for Automation 360 v.29 release.

With document-level data validation, you can create rules to ensure the accuracy of extracted data across multiple fields in your documents.  <a href="#">Document-level rules for improved extraction</a>
You can leverage export and import functionality with the ability to copy heuristic feedback data with the configuration.  <a href="#">Validation feedback in export and import of learning instances</a>
Create a user-trained learning instance in Document Automation and extract it using a Google Custom Document Extractor (CDE) processor.  <a href="#">Support for Google Custom Document Extractor (CDE)</a>
You can create and train new models using Microsoft Form Recognizer v3.0 only.  <a href="#">Standard Forms support for v3.0 model</a>

## Bot Insight v.29 release

Review the fixes in Bot Insight for the v.29 release.

**Important:** Starting from this release, we have moved information about updates in each (such as what's new, changed, fixes, and limitations) to -specific pages. You can access these pages by navigating to [Package updates overview](#) on page 835 > <-name> releases.

For a consolidated list of packages updated in this release, see [Packages updated in v.29](#) on page 104.

### Fixes

Bot Insight dashboards now show complete operational data without an administrator role. With appropriate folder permissions to view and access the bots, you can view the data for the bot in the dashboard.

Previously, you needed an administrator role to access all bots in the Bot Insight dashboard. Thus, the dashboard showed no data or incomplete data for non-administrator roles.

Service Cloud case ID: 00667473, 00687154, 01037867, 01250792, 01753449, 01767903, 01894821, 01969251, 01867608, 01903290, 01923256, 01948171, 01940999, 01970902, 01989660, 01940999.

Bot Insight dashboards now sort all the widgets data and show it in correct sort order (ascending or descending).

Previously, the sort order setting was not working accurately and impacted the widgets data for all the domain dashboards. As a result, it always showed the old datasets only.

Service Cloud case ID: 01942061

When you hover over the charts x-axis, the device utilization widget in the Bot Insight device dashboard now shows the correct tooltip text for the **Device Name** label.

Service Cloud case ID: 01941392

When you use the **Analyze** command in loop to run for higher number of times (For example, 113764), the number of documents pushed into Elasticsearch are matching correctly with the input record count. As a result, the business dashboard shows the correct data.

Previously, the input records count did not match with the number of records count in dashboard and you were not able to view the correct data in the business dashboard.

Service Cloud Case ID: 01959930, 01961929, 01962535



## Package SDK v.29 release

Review what's new in the Automation 360 Package SDK for the v.29 release.

### What's new

SDK download link: [A360-package-sdk-2.8.0.zip](#)

return\_Direct attribute

A new attribute `return_Direct= true` is added at the action level. It will show only a single option to select the Record type variable in the output.

For example:

```
@BotCommand
@CommandPkg (
    return_label = "[[AddColumn.return_label]]",
    node_label = "[[AddColumn.node_label]]",
    label = "[[AddColumn.label]]",
    description = "[[AddColumn.description]]",
    name = "addColumn",
    icon = "record.svg",
    return_type = DataType.RECORD,
    return_Direct = true,
    return_required = true,
    minimum_controlroom_version = "17917",
    minimum_botagent_version = "21.134",
    documentation_url = RECORD_ADD_COLUMN_URL,
    documentation_widget_page = RECORD_ADD_COLUMN_WIDGET,

    allowed_Agent_Targets = AllowedTarget.HEADLESS)
```

OAUTHCONNECTION attribute

A new attribute type, `OAUTHCONNECTION`, is added to get an access token from the Control Room's preconfigured OAuth Connection value.

For example:

```
@Idx(index = "1", type = AttributeType.OAUTHCONNECTION)
@Pkg(label = "[[OAuthConnectionTypeDemo.connection.label]]")
OAuthConnection connection
```

A new rule **VariableMapAllowedDataTypes** is added to the **VARIABLEMAP**

**VariableMapAllowedDataTypes** allows you to filter the UI for a particular variable type. **VariableMap** is a control that allows you to add variable selection for any action (in the bot editor UI). With the **VariableMapAllowedDataTypes** filter, you can restrict the datatype of variables that can be used in an action. For instance, if you set the **VariableMapAllowedDataTypes** to **String**, it will list only string variables within an action.

```
@Idx(index = "4", type = VARIABLEMAP)
  @Pkg(label = "[[LogVariables.selectVariable.label]]")
  @NotEmpty
  @VariableType(DataType.VARIABLEMAP)
  @VariableMapAllowedDataTypes({
    DataType.STRING,
    DataType.NUMBER,
    DataType.BOOLEAN,
    DataType.DATETIME
  })
  Map<String, Value> variables
```

**@DesktopOperationContext** annotation

The new annotation `@DesktopOperationContext` is used to inject the `DesktopOperationContext` in `DesktopOperation`, similar to `GlobalSessionContext`.

This annotation is applied on property with the setter method so that the generated file can set `DesktopOperationContext` to the target file.

By injecting `DesktopOperationContext`, the following property can be accessible in `DesktopOperation` from the `GlobalSessionContext`:

1. `getUserToken`
2. `getCrUrl`
3. `resolveResource`
4. `getExternalEnvironment`
5. `getProxyConfig`
6. `botId`
7. `getResources`

```
@BotCommand(commandType =
    BotCommand.CommandType.DESKTOP_OPERATION_BUTTON)
@CommandPkg(name = "RESTRRecorder", desktop_operation_name =
    "RESTRRecorder")
public class RecorderOperation {

    private static final Logger LOGGER =
    LogManager.getLogger(RecorderOperation.class);

    @Request private DesktopOperationButtonRequest request;

    @DesktopOperationContext private
    com.automationanywhere.toolchain.runtime.operation.context.DesktopOperationCont
    context;

    public void setRequest(DesktopOperationButtonRequest request)
    {
        this.request = request;
    }

    public void setContext(
    com.automationanywhere.toolchain.runtime.operation.context.DesktopOperationCont
    context) {
        this.context = context;
    }
}
```

Related reference

[Previous Package SDK Release Notes](#) on page 975

Review the new, changed, fixed, and deprecated features, and security fixes, known issues, and limitations for the previous Automation 360 (formerly Enterprise A2019) Package SDK.

## Automation 360 v.28 Release Notes

Release date: 5 April 2023

Review the top 5 features in this release as well as other new features and exciting enhancements for Automation 360 v.28 release.

- Build 17566: Automation 360 (Cloud and Cloud Sandbox) and IQ Bot (Cloud)
- Build 17593: Automation 360 (On-Premises)
- Build 17571: IQ Bot (On-Premises)

We have released updated builds for fixes after the Automation 360 v.28 GA builds, which were Cloud Build 17524 and On-Premises Build 17506. For information about the fixes in these updated builds, see [Updated release builds](#) on page 126.

### Highlights of this release

Here are the top 5 features in the v.28 release:

Document Automation and Google Document AI

Validation-based improvement on Google Document AI extractions: Empower your employees to save time and automate more documents using Document Automation and Google Document AI validation feedback, which in turn provides improved extraction accuracy for Document AI learning instances.

Leverage integration update with the latest Google Document AI parsers: Improve extraction accuracy and enable 7 additional languages (including Italian and Portuguese) for Document AI invoices, and Japanese for Document AI expense receipts.

See [Create a learning instance in Document Automation](#) on page 3642.

CoE Manager: Value tracking for On-Premises automations

Calculate ROI for automations running on an On-Premises Control Room by running a bot to push automation-run data to CoE Manager. View your ROI data in real-time dashboards and create a healthy pipeline of automations that will help propel your business forward.

See [CoE Manager - Integrate with On-Premises Control Room](#) on page 2074.

Empower business users with Automation Co-Pilot and Microsoft Teams

Bring automation to your employees in their favorite collaboration tool Microsoft Teams.

Employees can be in a chat or team channel, or open Automation Co-Pilot from the Apps menu to view a list of the Automation Co-Pilot processes and desktop automations they have access to. They can start and monitor these automations, without having to leave Teams.

See [Integrate Automation Co-Pilot with Microsoft Teams](#) on page 3357.

#### Workday package

Easily automate your Workday processes such as reporting, data upload/download, or triggering workflows with our new point-and-click experience. Our new package provides deep API-level integration with Workday that enables you to build automations easily, without having to code.

The following video shows how you can automate processes in ServiceNow and Workday using API integration.

See [Workday package](#) on page 3162.

#### Enhance developer productivity

Next-gen Recorder: Improve automation reliability for web applications when the UI element is not visible on the screen. The Recorder will automatically work around this without any developer intervention.

See [Recorder package](#) on page 2916.

Quickly search and replace any text or variables in the action properties of the bot: Save time and improve developer productivity with an automatic search and replace tool in Bot Assistant. Users can quickly search for any specific text or variable, navigate through the search results, and selectively replace each occurrence of the text or variable in the automation.

See [Search and replace option in Bot editor](#) on page 2369.

Email automation through a shared mailbox: Automate email tasks over a shared mailbox in Microsoft 365 Outlook using IMAP or EWS protocols and Client Credential flow or PKCE flow with Exchange Online. This feature saves you money, time, and effort in maintaining individual personal mailboxes.

See [Email package](#) on page 2517.

Enhancement to bulk package update: As an automation administrator, update multiple

packages in bulk or perform updates to specific bots and view outcomes of these applied updates in a system-generated report.

See [Updating package versions](#) on page 1909 | [Update bots to default package version](#) on page 1910.

Bot runtime alerts: Gain visibility into your automations with notifications on various platform events and take actions based on these notifications. Get notified on events such as automation runtime and device pools from within the application (default) or through email reports based on your preference.

See [Automation events](#) on page 2202 | [Platform events](#) on page 2203

The following video shows the developer enhancements available in this release:

## Updated release builds

- Build 17593 (On-Premises) is released which includes a fix for the Apache ActiveMQ remote code execution vulnerability. For more information, see [Apache ActiveMQ Remote Code Execution Vulnerability CVE-2023-46604 \(A-People login required\)](#).
- We have released the updated Build 17593 (On-Premises) for the following:
  - Fix for users (excluding users assigned the AAE\_Admin role) who do not have a license assigned to them: the **Audit log** page no longer displays unsuccessful entries for any activity performed by these users on the Control Room. (Service Cloud case ID: 01969726, 01970583, 01970990, 01971435, 01971171, 01970869, 01971854, 01970915, 01970523, 01971411, 01971788, 01971827, 01971482, 01971736, 01970333, 01972128, 01970497, 01972025, 01971459, 01971561, 01971068, 01972148, 01975216, 01975980, 01977479)
  - Fix for an issue when multiple users try to check-in bots simultaneously, the Control Room UI might become unresponsive due to a database connection issue. (Service Cloud case ID: 01944887)
  - Fix for an issue when the access lock in Git causes the lock not to be released. (Service Cloud case ID: 01944887)
  - Fix for a critical security vulnerability present in the Credential Vault module of v.28 and earlier releases. The vulnerability allows a user who has permission to modify a locker to access credential attributes in another locker.
  - Fix for an issue where the Automation Co-Pilot (AARI) request page does not load correctly due to AARI form not rendering table data when the data variable assigned to the form has more columns than the columns specified in the table.
  - Fix for an issue in the Automation Co-Pilot form where the form does not display an error when a textbox inherits a value from a previous task and the value exceeds the maximum character limit of the textbox.
- We have released the updated Build 17566 (Cloud) for the following:

- Fix for an issue when multiple users try to check-in bots simultaneously, the Control Room UI might become unresponsive due to a database connection issue. (Service Cloud case ID: 01944887)
- Fix for an issue when the access lock in Git causes the lock not to be released. (Service Cloud case ID: 01944887)
- Fix for a critical security vulnerability present in the Credential Vault module of v.28 and earlier releases. The vulnerability allows a user who has permission to modify a locker to access credential attributes in another locker.
- We have released the updated Build 17557 (Cloud) for the following:
  - Fix for an issue where the Automation Co-Pilot (AARI) request page does not load correctly due to AARI form not rendering table data when the data variable assigned to the form has more columns than the columns specified in the table.
  - Fix for an issue in the AARI form where the form does not display an error when a textbox inherits a value from a previous task and the value exceeds the maximum character limit of the textbox.
- We have released the updated Build 17542 (Cloud and On-Premises) for the following:
  - Fix for an issue when bot preview is unavailable when you check out a bot that is using metadata in actions (for example, Image Recognition, Recorder, and Screen Capture).
  - Fix for an issue where editing a bot from a folder fails when a policy is assigned to the folder and its subfolders and one of the subfolders is deleted.
- We have released the updated Build 17533 (Cloud) to include a fix for an issue found when exporting a bot.

Exporting a bot fails when you perform the following steps:

  1. Log in to the Control Room.
  2. Create a main bot and child bot using the Recorder actions.
  3. Check in the bot.
  4. Check out the bot and delete the Recorder actions from the main bot.
  5. Check in the bot.
  6. Export the bot.

## What's new and changed in each product

Navigate to the following pages for details on all the updates (what's new, changed, fixed, and limitations) in each product:

<a href="#">Automation Workspace v.28 release</a> on page 128
<a href="#">CoE Manager v.28 release</a> on page 170
<a href="#">Automation Co-Pilot for Business Users v.28 release</a> on page 171
<a href="#">IQ Bot and Document Automation v.28 release</a> on page 175
<a href="#">Bot Insight v.28 release</a> on page 180

## Automation Workspace v.28 release

Review what's new and changed, and the fixes and limitations in Automation Workspace for the v.28 release.

### What's new

Control Room, devices, and Bot Agent
<p>Select the Control Room services to run at startup (Service Cloud case ID: 00781074, 00804237, 00799057, 01260425, 01271130, 01793867, 01966120, 0200222)</p> <p>You can optimize application process utilization on your device by selecting the Control Room services that you want to automatically run at startup during the On-Premises installation.</p> <p><a href="#">Select Control Room services to automatically run at startup</a> on page 1253</p>
<p>Improved notifications administration to manage user access</p> <p>A Control Room administrator can manage a user's access to the event categories set in the <b>Administration &gt; Settings &gt; Notification settings</b> section. A Control Room administrator can lock the required preferences and notifications only for those enabled event categories that are sent to the end users.</p> <p><a href="#">Lock event categories</a> on page 2207</p>
<p>Monitor bot runtime, device pool, and license events through notifications</p> <p>Through notifications, you can monitor all:</p> <ul style="list-style-type: none"> <li>• Bot runtime events: Bot runtime event notifications are sent to the respective users based on bot access permissions.</li> <li>• Device pool related events: Device pool-related event notifications are sent to users based on their user role and permission in the Control Room.</li> <li>• License events (such as license over subscription or consumption): Email notifications are sent for license over subscription or consumption events.</li> </ul> <p><a href="#">Automation events</a> on page 2202   <a href="#">Platform events</a> on page 2203</p>
<p>Monitor Automation Co-Pilot events through Control Room notifications</p> <p>With the <b>Process events</b> category, the Control Room notifies you about various Automation Co-Pilot events related to requests and tasks through notifications. The task and request event notifications are sent to the task owner and request creator team, respectively.</p> <p><a href="#">Process events</a> on page 2204</p>
<p>Audit log event when a package is deleted (Service Cloud case ID: 01780700, 01885638)</p> <p>An audit log event is logged when a user deletes a package.</p> <p><a href="#">Audit events list</a> on page 2144</p>



Control Room, devices, and Bot Agent
<p>Import intermediate certificates for secure access to Control Room (Service Cloud case ID: 00673966, 01889608)</p> <p>An intermediate certificate is used to determine if a certificate was issued by a valid and trusted root CA (certificate authority). If the intermediate certificate is not installed on the server where the TLS certificate is installed, applications might not trust the TLS certificate. To have clients trust the TLS certificate, you must make the intermediate certificates available on the server.</p> <p>You can import the intermediate certificates when you install the Control Room or after you install the Control Room using the Windows command prompt.</p> <p><a href="#">Intermediate certificates</a> on page 1387   <a href="#">Configure application Transport Layer Security</a> on page 1249   <a href="#">Import HTTPS, intermediate, and CA certificates</a> on page 1387</p>
<p>Validate remote deployments to avoid unauthorized device access (Service Cloud case ID: 01608589)</p> <p>Prior to assigning a device for bot deployment, you can reset the bot running device for Bot Creator, Citizen Developer, and attended Bot Runner users to prevent unauthorized deployments. This enhancement enables you to clear an existing bot running device when users log into the Control Room and there is no Bot Agent available on the local device.</p> <p><a href="#">Switch device registration between Control Room instances</a> on page 1807</p>
<p>Configure username for different Automation 360 services using the CyberArk secret response (Service Cloud case ID: 01852428, 00675147, 01950039, 00819460, 00830696, 00822765)</p> <p>You can configure usernames for auto-login, Lightweight Directory Access Protocol (LDAP), and service credentials using the CyberArk secret response. Usernames can be a combination of values from the secret response or string literals. The CyberArk secret response contains field values that you must enclose within dollar signs (\$\$) to construct the username. For example, to configure the username in the format <code>domain\username</code>, you must enter: <code>\$\$domain\$\$\\$\$username\$\$</code>. The domain and username values in this expression will be replaced with the corresponding values from the secret response.</p> <p><a href="#">External key vault naming conventions</a> on page 1921   <a href="#">CyberArk credential retrieval use cases</a> on page 1941   <a href="#">On-Premises initial installation using CyberArk Password Vault</a> on page 1936</p>
<p>Customize device registration settings</p> <p>Control Room administrator can customize the device registration settings while adding a device. For example, if there are multiple users who will log into a single device, an administrator can change the <b>Device type</b> to <b>Multiple users</b>.</p> <p><a href="#">Configure device registration</a> on page 1797</p>
<p>Minimize security risk for trigger-based bot deployment</p> <p>Prior to deploying a trigger-based bot, you can select to validate the device credentials for Bot Creator, Citizen Developer, and attended and unattended Bot Runner users. This provides users additional security for trigger-based bot deployment.</p> <p><a href="#">Switch device registration between Control Room instances</a> on page 1807</p>

Control Room, devices, and Bot Agent
<p>Auto-connect to non-UI triggers for unattended users</p> <p>As an unattended user who uses non-UI triggers (such as File/Folder trigger that do not require user session) you can auto-connect to the Automation Workspace when the machine is rebooted. You do not need to log in to ensure the triggers are running.</p> <p>Service Cloud case ID: 00758775, 01754312, 01754887, 01803179, 01844357, 01845563, 01568082, 01866287, 01920491, 01951355, 01951355, 01957771</p>
Packages, actions, and Bot editor
<p>Workday package</p> <p>You can use the new Workday package from Automation 360 to automate your Workday processes such as reporting, data upload/download, or triggering workflows with our new point-and-click experience. The package provides deep API-level integration with Workday that enables you to build automations easily, without having to code.</p> <p><a href="#">Workday package</a> on page 3162</p>
<p>Apigee package</p> <p>You can use the new Disconnect and Resume Integration features in the Apigee package. You can disconnect from your Apigee instance and clear the session using the Apigee Disconnect action. You can resume an integration that is suspended in Apigee using the Apigee Resume Integration action.</p> <p><a href="#">Apigee Disconnect</a> on page 2416   <a href="#">Apigee Resume Integration</a> on page 2421</p>
<p>Goto package</p> <p>You can migrate bots from other vendors into Automation 360.</p> <hr/> <p><b>Important:</b> The <b>Goto</b> package was specifically designed for migrating bots from other vendors into Automation 360 and is only available on request. This package is not available as part of the standard Automation 360 installation as it cannot be used to build any bots.</p> <hr/> <p><a href="#">Goto</a></p>
<p>Salesforce package</p> <p>You can retrieve the entire result set in the response of the Salesforce Execute SOQL actions. In the previous version, the response was limited to retrieve the first 2000 records and this limit has been removed.</p>
<p>View mode supports the ability to copy</p> <p>You can use the <b>Copy to shared clipboard</b> functionality to copy actions, triggers, and metadata from a bot in a private repository that is in <b>View</b> mode. You can then use the <b>Paste from shared clipboard</b> to paste the information to an editable bot.</p> <p><a href="#">Actions to build bots</a> on page 2363</p>
<p>Credential Picker listing enhancement</p> <p>For easier navigation when you pick a credential, the <b>Credential Picket</b> option displays the <b>Locker</b>, <b>Credential</b>, and <b>Attributes</b> items alphabetically across the bot packages.</p>

Packages, actions, and Bot editor
<p>Extended attributes supported in the Terminal Emulator Package (Service Cloud case ID: 01870633, 01928396, 01809815)</p> <p>The TN3270E terminal type supports extended attributes. To enable extended attributes for TN3270E terminals, select the <b>Extended Attribute</b> check box in the <b>Connect</b> action.</p>
<p>Enhanced Packages landing page</p> <p>The Package Manager landing page has been enhanced to provide more clarity with consolidated rows. When all versions of a package are disabled the status displays as <b>Disabled</b>. All related fields, such as recommended Control Room version, Bot Agent version, and Last modified, will show the status as <b>Not Available</b>.</p> <p>The <b>Version</b> column has been renamed to <b>Default version</b>.</p>
<p>Enhanced error messages display errors from the child bots (Service Cloud case ID: 01264352)</p> <p>When you create a bot where the parent bot calls a child bot, and if an error occurs in the child bot, the error message provides the following details:</p> <ul style="list-style-type: none"><li>• Line number of the parent bot which ran the child bot.</li><li>• Line number of the child bot where the error occurred.</li><li>• Error message details, such as what went wrong with that line number and the corresponding corrective action.</li></ul> <p><a href="#">Using Bot editor</a> on page 2232</p>
<p>Timeout option in Database Connect action (Service Cloud case ID: 00753858)</p> <p>We added a timeout option in the <b>Connect</b> action of the Database Package. When you connect with Microsoft SQL Server to automate database-related tasks, and if the database is down or experiences any network issues, the automation will time out and fail if the database connection is not established in the specified time.</p> <p><a href="#">Using Connect action for database</a> on page 2469</p>
<p>Improved readability with new formatting capabilities in XML document (Service Cloud case ID: 01886455, 01925386)</p> <p>When you insert, update, or delete nodes, the XML package does not remove carriage return characters between nodes but does remove all blank text nodes from the XML document. By using <b>Prettyprint</b> to format XML files, developers can easily improve the readability of a document. Developers can save time by using the following new options that have been added to the XML Package:</p> <ul style="list-style-type: none"><li>• <b>Use Prettyprint:</b> The <b>Save session data</b> action supports the Prettyprint format in the XML document. When you select the <b>Use Prettyprint</b> check box and use the <b>Insert node</b>, <b>Update node</b>, or <b>Delete node</b> actions and then save the XML document, the code is formatted with proper indentation as per Prettyprint.</li><li>• <b>Remove text nodes that contain only white space:</b> The <b>Start Session</b> action provides an option to remove blank text nodes when you parse the XML document.</li></ul> <p><a href="#">Save session data action in XML</a> on page 3191   <a href="#">Start session action in XML</a> on page 3191</p>

**Packages, actions, and Bot editor**

New features added to the Email Package (Service Cloud case ID: 01835214, 01846425, 01756713, 01882482)

To support extensive process automation, we added the following action-related features to the Email Package:

- Ability to use the **Reply All** action.
- Enhanced the **Delete all** action to delete all emails from a specific folder. Additionally, you can apply filter parameters to emails such as:
  - All, Read, and Unread
  - Subject
  - From a specific sender
  - Before, on, or after a received date
- The dictionary variable for email properties includes a new variable, `emailNoOfAttachments`, used to retrieve the attachment count.

[Reply All action](#) on page 2533 | [Example using Email actions in a bot](#) on page 3272 | [Delete all action](#) on page 2522

Automate controls using Microsoft UI Automation (COM) technology

You can use the Microsoft UI Automation (COM) technology to automate the following scenarios:

- Capture and automate link controls
- Capture and automate tree controls

[Capture using specific technology](#) on page 2948 | [Actions performed on objects captured with Universal Recorder](#) on page 2923

Insert Custom column in Data Table

A new **Custom column** option has been added to the **Data Table > Insert column** action that enables you to insert a new column at a specified index in a data table. When you read an Excel spreadsheet and assign it to a data table, you can modify the table by adding a new column and entering any required data.

[Insert column action](#) on page 2456

New Label option in Loop package

A new **Label** option has been added to the Loop package that enables you to break or continue a specific loop from the nested loops.

[Loop package](#) on page 2784

Add and configure If action conditions

You can add and configure a maximum of 32 conditions in a single **If** action.

Packages, actions, and Bot editor
<p>Improved automation reliability for web applications</p> <p>When you use the <b>Recorder &gt; Capture</b> action to automate web pages running on Google Chrome and Microsoft Edge browsers, the <b>Recorder &gt; Capture</b> action no longer scrolls down the web page if the target object is visible on the screen. This feature improves the user experience and reliability of automation when there is a fixed top pane on the web page and if some physical actions such as mouse clicks do not work as expected.</p> <hr/> <p><b>Note:</b> Ensure that you install the browser extension (version 3.0.8.0) and use the Recorder package (version 2.10.2) to capture the control.</p> <hr/>
<p>Preferred view retained as default view in the Bot editor</p> <p>As a bot developer, you no longer have to manually select the preferred view when you open the Bot editor. To improve the developer's productivity and user experience, when creating bots in the Bot editor, your preferred view (List, Flow, or Dual) in the Bot editor will persist across user sessions and browsers. When you navigate in the Control Room or after your next log in, the Bot editor will retain your last used or selected view.</p> <p><a href="#">Using Bot editor</a> on page 2232</p>
<p>Line markers for collapsible sections of code in the Bot editor</p> <p>When you create bots using <b>Loop, If/If-else, Step, Trigger-loop, Try, Catch,</b> and <b>Finally</b> statements, the Bot editor clearly shows the collapsible sections. When building automations, developers can use these visual indicator line markers at the beginning and end of the collapsible section to improve their productivity.</p> <hr/> <p><b>Note:</b> The visual indicator line marker for the collapsible section applies only to the <b>List</b> view in the Bot editor.</p> <hr/> <p><a href="#">Using Bot editor</a> on page 2232</p>
<p>Enhanced user experience through refreshed and intuitive icons</p> <p>With the new and intuitive icons for actions in the Bot editor, Citizen Developers and RPA developers can quickly locate the correct action while creating automation for a day-to-day task. These unique and renewed icons are developed according to brand and global standards.</p>
<p>Update to the Capture text of window action</p> <p>The <b>Capture text of window</b> action in the App Integration package can be used to capture a text from a window on two different user sessions.</p> <p><a href="#">Capture text of window action</a> on page 2427</p>
<p>Search and replace in Bot editor (Service Cloud case ID: 00792784, 01943783)</p> <p>Use the <b>Search and replace</b> feature in the Bot editor to search for any text or variables, string within an action and replace it.</p> <p><a href="#">Search and replace option in Bot editor</a> on page 2369</p>

**Packages, actions, and Bot editor**

The experience of building a process has improved.

- Copy, cut, and paste behaviors are the same in Process Composer as in the Bot editor.
  - [Supported behaviors for tasks and elements in Process Composer](#) on page 3422
- You can access hidden variables for all applicable conditions, through the variable picker in the Process Composer.
  - [Create hidden variables in a form](#) on page 3436

The Process Composer supports Global Values. You can enter Global Values as variables and select them from the variable picker.

Upload Storage file action added to Process Composer package

You can use the new **Upload Storage file** action in a task bot to upload data to storage for further consumption in a process. This makes Automation Co-Pilot requests more versatile by enabling bots to process files rather than requiring users to upload at request creation.

[Process Composer package](#) on page 2893

**Building and running bots**

Notification for bot import

You are informed through **Notifications** when you import a bot from the Control Room. However, this notification is sent only to the user who imported the bot.

[Capabilities supporting notifications](#) on page 2208 | [Import bots](#) on page 2035

Bulk update of multiple packages to default version for multiple bots (Service Cloud case ID: 00712719, 00728499, 00737694, 00803673, 01255722, 00838604, 00772147, 01760236, 01762679, 01771416, 01761859, 01782588, 01778220, 01784255, 01789551, 01809167, 01818690, 01831969, 01813413, 01287311, 01923711, 01927867, 01945464, 01946912, 01819540, 01945315)

You can update multiple packages to default version for multiple bots. This feature enables you to update multiple package versions across all available bots with one action thereby increasing the efficiency of a bulk package update. Additionally, you can review the bots and dependencies before a bulk update.

[Updating package versions](#) on page 1909 | [Update bots to default package version](#) on page 1910 | [Example of updating default package version across bots](#) on page 3259

### Building and running bots

Enhancements to code analysis

- You can access the new administration settings tab for policy management. The enable or disable functionality of code analysis has been moved from **Administration > Policies** to **Administration > Settings > Policies**.
- You can define multiple named policies with different rules that have different severity levels.
- You can apply different policies to different folders in the **Automation** page. When you run code analysis on a file, it uses the applicable policy for the folder (assigned or inherited) where the file is located.

[Code analysis policy management](#) on page 2182 | [Configure and assign code analysis policy](#) on page 2191

Notifications integration in embedded automations

Notifications in embedded automations (such as Workday, Salesforce) provide you information about automations initiated from these applications and remote bot executions. It enhances the user experience by notifying you about the remote bot executions in their respective applications, thereby increasing the notifications effectiveness.

[Capabilities supporting notifications](#) on page 2208

Enhanced Automation Command Centre home page

The Automation Command Center (ACC) home page provides comprehensive visibility, actionable insight, and oversight capability into all aspects of your automation domain. The ACC home page provides operational insights such as automation and device status, license utilization information, and code analysis policy compliance metrics.

This enhanced home page provides the following benefits and capabilities:

- Effective monitoring of the automation landscape, leading to:
  - Improved reliability
  - Improved utilization
- Ensures compliance by highlighting results of code analysis
- Helps CoEs scale efficiently and achieve automation success
- Easier navigation to other areas such as Automation Co-Pilot, CoE Manager, and Bot Insight

[Automation Command Center](#) on page 2041

### APIs and integrations

Export repository bots by version or label (Service Cloud case ID: 01805699, 01838251)

Use the new `POST /v2/blm/export/version` API to export repository bots by specifying the label or version of the files. These bots are exported to an archived file.

[BLM API](#)

**APIs and integrations**

## Process composer APIs

Use the **Process Composer** APIs to create a new request from AARI processes. You can also retrieve the initial form and request by specifying the reference ID. You can use the following endpoints in the process composer APIs:

- `/requests/create`: Create a new AARI request.
- `/requests/ref/{refId}`: Retrieve a request.
- `/processes/{id}/form`: Retrieve initial form.

[Process Composer API](#)

**What's changed****Control Room, devices, and Bot Agent**

## Improved secure registration for Community Edition or Automation 360 users

When a user registers for the Community Edition or Automation 360 account, the registration email sent to the user contains a temporary registration link used to create the user credentials. This registration method is more secure than sending the user their password in plain text.

## Licenses page enhancements

To provide easy access to license usage and availability, the **Licenses** page includes information for the following elements:

- License mode
- Control Room expiration date and time
- Date when the **Licenses** page was last updated
- List of products with license availability
- License total details and where used

[Manage licenses](#) on page 1782

## Upgrade changes in code analysis policy from Automation 360 v.28 or later versions

If you have configured a policy for code analysis prior to upgrading to Automation 360 v.28, this policy is migrated to Automation 360 v.28 and is named default policy. This policy is applied to the **Automation** root folder and is applicable for all bots prior to Automation 360 v.28 release.

[Upgrade changes in code analysis policy for Automation 360 v.28 or later versions](#) on page 2194



Control Room, devices, and Bot Agent
<p>Active Directory enhancements for configuring domains (Service Cloud case ID: 00733422, 01853744, 01862164, 01794663)</p> <p>The following enhancements were made for administrators who configure domains for Active Directory (AD):</p> <ul style="list-style-type: none"> <li>• The Control Room login and the <b>Create user</b> pages automatically select the default domain that is configured. You can select a different domain by either entering the letters of the domain or selecting the domain from the drop-down list.</li> <li>• You can configure the domains listed on the Control Room login, the <b>Create user</b>, and the <b>Create an Active Directory role mappings</b> pages to hide domains.</li> </ul> <p><a href="#">Create an Active Directory user</a> on page 1740   <a href="#">Configure Control Room for Active Directory: manual mode</a> on page 1375   <a href="#">Manage domain</a> on page 1814</p>
<p>Support for multiple roles in Active Directory role mappings (Service Cloud case ID: 01133364, 01133364, 01929400, 01776684)</p> <p>When you create multiple Active Directory (AD) role mappings for multiple security groups, the roles used in the mappings are combined for the users who belong to the security groups.</p> <p><a href="#">Manage Active Directory role mapping</a> on page 1774</p>
<p>Users who have an Attended Bot Runner license can no longer add Bot deployments to a queue. However, there are no changes for triggers.</p>
<p>As part of the <b>OpenSearch</b> service adoption, when you upgrade nodes in a stand-alone or cluster setup, you must perform a workaround to fix an installation issue.</p> <hr/> <p><b>Note:</b> This behaviour is applicable to all the customers who are on the Elasticsearch multi-node cluster and are upgrading to the OpenSearch cluster.</p> <hr/> <p><a href="#">Automation 360 On-Premise Edition   A360.28 – Upgrade Considerations   Update nodes in a cluster setup</a> on page 1264</p>
<p>To accommodate multiple package updates, the <code>/v2/repository/files/packageVersionUpdate</code> API name was modified to <code>/v2/repository/files/packagesVersionUpdate</code> from the v.28 version. The change in file name will be reflected in Swagger from the v.29 version. The <code>/v2/repository/files/packageVersionUpdate</code> API will no longer work and will instead show a flag disable message.</p>
<p>Automatically deploy event triggers (Service Cloud case ID: 00758775, 01754312, 01754887, 01803179, 01844357, 01845563, 01568082, 01866287, 01920491, 01951355, 01957771)</p> <p>You can use the <b>Automatically deploy to unattended Bot Runners</b> option when you add an event trigger to automatically deploy triggers. When you reboot your system or Bot Agent, this option will continue the trigger deployment with the current user.</p>

**Packages, actions, and Bot editor**

The name of the AARI Web package has been changed to Process Composer.

**Fixes**

Build 17566: This build includes the following fixes (along with fixes from the previous builds):

When you check-in or check-out a bot, the automation page loads successfully without any delay. Also, there is no impact on the bot create and commit process.

Previously, the automaton page was not loading during bot check-in and check-out due to database connection. This behavior caused poor user experience and impact on the bot create and commit process.

Service Cloud case ID: 01963796, 01959945

Build 17542: This build includes the following fixes (along with fixes from the previous builds):

When you check out a bot that contains metadata in actions (for example, **Image Recognition**, **Recorder**, or **Screen Capture**), you no longer encounter an error and a broken image. As a result, the image preview of bots renders properly.

Previously, in such cases, image preview failed and generated an error. As a result, you were not able to check out, copy, or clone the bot.

Service Cloud case ID: 01971324, 01972601, 01977090, 01976820, 01976757, 01976571, 01976597, 01976629, 01977130, 01976845, 01977497, 01976639, 01977546, 01976736, 01977054, 01977392, 01978707, 01978097, 01969070, 01976549, 01978951, 01978955, 01979180, 01977511, 01979014, 01979687, 01979741, 01975299, 01980410, 01980114

Build 17533: This build includes the following fixes (along with fixes from the previous builds):

Bot export now completes successfully when you export a bot containing actions that store an image, such as actions from **Recorder**, **Image Recognition**, or **Screen** package.

Previously, bot export failed when it contained actions that stored an image, and the export error was displayed in the audit log and the historical activity page.

Control Room now sends email notifications when a scheduled bot fails prior to its execution for example, when the Bot Runner machine is not available.

Service Cloud case ID: 01768120

The **Schedule** column on the **Scheduled activity** page shows the frequency of a scheduled bot in your local language.

Previously, the frequency of a scheduled bot was not translated and not shown in the user's local language, for example, Japanese.

Service Cloud case ID: 01936850

When you restart the Control Room services and execute a bot, the bot deployment no longer fails on the connected devices nor generates an error on the **In progress** and **Audit log** pages.

Previously, the `AtmosphereResource Cancelled` error displayed on the **In progress** page and the error was registered on the **Audit log** page.

Service Cloud case ID: 01937388

You no longer see duplicate deployments (current and previous) for the same device on the In Progress page.

Previously, duplicate deployments were displayed.

Service Cloud case ID: 01954716

On the **In progress activity** page, the **Activity type** column displays the correct bot activity type.

Previously, the column displayed inconsistent activity types.

Service Cloud case ID: 01958801

When you create a locker, the **Create locker** page displays tabs such as **Credentials**, **Owners**, **Managers**, and so on.

Previously, tabs were not displayed.

Service Cloud case ID: 01949499

Attended Bot Runner users can view the **Schedule bot** menu on the following pages:

- **Automation (Run bot > Schedule bot)**
- **In progress activity**
- **Scheduled activity**
- **Devices**
- **Device pools**

Previously, this menu was not displayed on these pages.

Service Cloud case ID: 01085127, 01805063

You can run bots in **Debug** mode even when the data table variables contain a large amount of data (up to 3 MB for a single data table variable that is being watched only). Previously, the browser stopped responding.

Service Cloud case ID: 01949707, 01955034

The query parameters URLs are now parsed even with empty values, resulting in the API server executing them successfully.

Previously, an exception error occurred in such cases.

Service Cloud case ID: 01903082

If you deploy a task with a Bot Runner that has a disconnected default device and no device pool is selected, an error message displays in your local language.

Previously, an error message displayed in English even when the user's local language (for example, Japanese) was selected.

Service Cloud case ID: 01919213

The Bot Runner device will unregister from the Control Room only if there is a valid authentication error.

Previously, during the Bot Runner authentication, the device was unregistered from the Control Room after two unsuccessful authentication attempts. The reason for the error could be due to a valid unsuccessful authentication attempt or any other error.

Service Cloud case ID: 01947943, 01946249, 01956026, 01945438

When a bot is deployed with multiple run-as users and if one or more devices disconnect from the Control Room during the bot execution, reconciliation of reconnecting devices no longer triggers the `NonUniqueResultException` error.

Previously, when you select X number of run-as users (where  $X > 1$ ), the query returned X number of entries from the table, which results in the `NonUniqueResultException` error. As a result, reconciliation failed and also the bot execution was terminated.

You no longer encounter issues when you create a bot using the DLL **Open** and **Close** actions and then use the **If > Dll session exists** condition to check whether a DLL session is closed in a bot.

Previously when you used the **If > Dll session exists** condition, it failed to check a closed DLL session and displayed an error.

Service Cloud case ID: 01868691

When you use the **Get node value** to retrieve the JSON object in the JSON package, it returns the JSON value in the correct format.

Previously, the **Get node value** action displayed the output in the wrong format.

Service Cloud case ID: 01864551

You can use the **Connect** action to establish a connection with the FTP/SFTP server with keyfile authentication and automate a task.

Previously, the bot could not automate the FTP/SFTP operations if the SFTP keyfile server was installed on a Windows machine.

Service Cloud case ID: 01858323

You no longer encounter any errors when you create a bot using the **Create workbook** action from the Google Sheets package.

Service Cloud case ID: 01918952

When you use the **Connect** action in the Active Directory package, you can select objects in the **Object Explorer** window successfully.

Previously, an error was displayed when you selected objects in the **Object Explorer** window.

Service Cloud case ID: 01925109

In the Email package, you can use the **Email > Send** action to send an email without issues.

Previously, when you used Email package version 3.14.3-20220923-220748 or later, an issue occurred when using the **Email > Send** action.

Service Cloud case ID: 01912097, 01931592, 01934137, 01940215, 01932494, 01942202, 01942055, 01946339, 01949164

You can create bots using the **Run stored procedure** action of the Database package even when you include a large amount of data as an **Input** parameter.

When you use the **Connect** action of the Terminal Emulator package with the prompt value and then the **Wait** action, the **Wait** action waits for the prompt value to appear on the terminal screen.

When a new package (first version) is added to the Control Room and you select **Disable** setting for the new version of the package, the package will show the status as **Disabled**.

Previously, it showed the status as **Enabled and set as default**.

In the **Datetime > Add** action, you can now specify a fraction value in the **Time value to add** field to increase the value in the Datetime variable by that specific fraction value.

When you use any browser action to automate a browser window or a tab, and run the bot, the browser action now waits for the time specified in the **Time out after** field to execute action on the browser tab before the bot fails. Previously, the browser action failed after 30 seconds when the bot did not execute successfully, regardless of the wait time set in the **Time out after** field was less than or greater than 30 seconds.

**Note:**

- As a result of this fix, if the **Time out after** field has a value other than 30 seconds, you might have to change the value for your existing bots. This will ensure that your bots continue to run properly with the latest Browser package.
- This fix does not apply for the **Find broken links** action.

Service Cloud case ID: 01880159

When you perform the following sequence of actions and then rename the variable that was used in these actions, the name of the variable will now be updated for the **Group** conditions and the conditions in the **Condition** tab:

- Use the If package
- Add a specific condition with a variable
- Add a specific condition with a variable
- Save the bot.

In the **Datetime > Subtract** action you can now specify a fraction value in the **Time unit to subtract** field to decrease the value in the Datetime variable by a specific time value and unit.

When you use the **Capture** action with the Recorder package (version 2.9.x or earlier) to navigate to another web page in the Google Chrome browser (version 105.0 or later), and then use another **Capture** action to automate objects in the navigated web page, the bot no longer encounters an error.

In any package, when you select the **Add argument** option, select **String** or **Number** as the **Argument type**, and try to insert a value, you can now use the mouse to scroll or click the scroll bar to navigate through the options.

When you use multiple Recorder actions in a bot to automate a specific web page running in Microsoft Edge with IE mode, and then run the bot, the second Recorder action now works properly, and the bot no longer encounters an error.

Service Cloud case ID: 01848824, 01868337

You can now use the **Folder > Unzip** action to extract compressed files and folders from an AES-256 encrypted zip file.

Service Cloud case ID: 01854767

When you try to automate web applications, the **Click** action in the Recorder now works properly with the MV3 extension on Google Chrome and Microsoft Edge browsers. Previously, when the object on a web page contained inline JavaScripts and the document to be automated was secured, the Recorder failed to perform the **Click** action.

Service Cloud case ID: 01927058, 01951022

When you use the **Click** action in the Recorder to automate applications running on Microsoft Edge with IE mode, the bots now time out automatically and no longer freeze when a pop-up appears during bot execution.

Service Cloud case ID: 01790352

When you assign a **Production** label to a Task Bot and deploy it, the bot no longer encounters an error at the **Image Recognition > Find window in window** action and runs successfully.

Service Cloud case ID: 01825541

When you use the Recorder package (version 2.10.2 or later) to capture a control on a web page, select **Currently active** window from the **Application** tab and then run the bot in a loop, the bot now captures the target control accurately and runs through all the loop iterations successfully even if the control appears behind the bot runtime window.

Service Cloud case ID: 01904537

When you use any of the following actions to determine if a window does not exist, select the web page opened in the Google Chrome browser from the list of active tabs in the **Browser** tab, and then run the bot, the following actions now wait for the specified time value to close the browser tabs before the bot fails.

- **Window does not exist** condition in the If and Loop packages
- **Window with same title does not exist** condition in the If and Loop packages
- **Window does not exist** condition in the **Wait > Wait for condition** action
- **Window with same title does not exist** condition in the **Wait > Wait for condition** action
- **Wait > Wait for window** action

**Note:** When you run the bot, the actions might wait for an additional two to three seconds later than the specified time out value to execute actions before the bot fails.

Service Cloud case ID: 00790336, 00822573, 00832864, 01268577, 01586174, 00790336, 01778857, 01804828, 01809565, 01791209, 01848262, 01867832, 01877740, 01959172, 01959278

When you create or delete a folder (or form) that contains . . characters in the folder (or form) name, the folder structure no longer affected.

Previously, when you deleted a folder (or form) that contained . . characters in its name, the parent folder was deleted which caused issues with the folder structure.

Service Cloud case ID: 01886058

The resiliency of the **File/Folder** trigger has been improved to continue listening after a network disruption has occurred. Previously, a network error caused the trigger to lose connection with the Bot Agent.

Service Cloud case ID: 01769532, 01773584, 01834098, 01867418

When you check in a bot that contains the string "bot\_" in its name and some recorder metadata, the metadata is no longer deleted. As a result, you can check out a bot without generating an exception or error message.

Previously, the recorder metadata was deleted and you were blocked from making recorder changes to any of the bots that contain "bot\_" in its name. The bot checkout failed and generated an exception or error message.

Service Cloud case ID: 01915726, 01933409, 01939124, 01944665, 01939124

When you upgrade the Control Room to Automation 360 v.27, the work items are deployed successfully for all scenarios.

Previously, when you upgraded the Control Room to Automation 360 v.27, the work item failed to deploy when queues were paused or stopped.

Service Cloud case ID: 01948038, 01950948

When you run a bot with a queue and select the queue category, the task bot (that contains a TABLE type variable and no row data) no longer fails and shows the `Missing work item template` error message.

Previously, when there was no row content for a TABLE type variable, you could not select the queue category while running a bot with a queue. As a result, the `Missing work item template` error message was shown even if a template was mapped.

Service Cloud case ID: 01922641

When you import a BLM package (zip file) to the Control Room, the Automation Anywhere Control Room Messaging service restarts and you no longer get an error message. Additionally, the bot import and export operations complete successfully.

Previously, when the **ActiveMQ broker** service is stopped, the broker is stopped but the process did not exit due to which the Automation Anywhere Control Room Messaging service was not restarted. As a result, when you import a BLM package, the `JMSException: failover time 5000ms exceeded` error was displayed.

Service Cloud case ID: 01924119

When you compare bot versions from the **View history Task Bot** page in the public workspace, the **Compare versions** displays any modifications made in the latest two versions of your bot without any error.

Previously, an error was displayed if you used the **Compare versions** feature through the **View history Task Bot** page.

Service Cloud case ID: 01949094, 01946533

After you update the Bot Agent to the 21.240.19897 version, you can deploy multiple bots using the API without any failure caused by the `AA-DB` file size.

Previously, when you deployed multiple bots using the API the `AA-DB.mv.db` and `AA-DB.trace.db` file sizes continued to increase and eventually caused the bots to fail. Additionally, the **device configuration refresh initiated** message continuously displayed.

Service Cloud case ID: 01776544

The following issues were fixed on the **In progress activity** page:

- Active bot deployments no longer disappear after a page refresh.
- Duplicate bot entries were removed whose status was displayed as active.

Service Cloud case ID: 01937581

Variables that you configure as input type are encrypted in the log files generated for Control Room.

Previously, input type variables were not encrypted and displayed as plain text in the log files.

Service Cloud case ID: 01768904



<p>Users can only view activities to which they have permission on the <b>Activity &gt; In progress</b> page.</p> <p>Previously, some users were able to view the activities of other users even though they did not have permission.</p> <p>Service Cloud case ID: 01839276, 01919244, 01940793, 01941503</p>
<p>In attended and unattended automation, if a bot fails to run and generates the "Node Manager went Down unexpectedly and could not complete this bot execution." error, the start time on the <b>Historical</b> and <b>Audit log</b> pages display correctly.</p> <p>Previously, the start time was displayed incorrectly.</p> <p>Service Cloud case ID: 01881736</p>
<p>All users can view the scheduled activities on the <b>Scheduled activity</b> page.</p> <p>Previously, some users were unable to view the scheduled activities.</p> <p>Service Cloud case ID: 01885890, 01848429</p>
<p>The Control Room Access URL length is set to a maximum of 4,000 characters.</p> <p>Previously, the URL length was not set.</p> <p>Service Cloud case ID: 01923035</p>
<p>Sorting users using the <b>Last login</b> option on the <b>Users</b> page sorts users correctly.</p> <p>Previously, sorting users by last login was not sorting the users correctly.</p> <p>Service Cloud case ID: 01813134</p>
<p>If you created a bot using the REST API command, the REST GET command is parsed without any errors even when the response body is empty.</p> <p>Service Cloud case ID: 01922332</p>
<p>Japanese characters are supported in the REST API commands with the multipart/form-data option and the output PDF name is rendered correctly.</p> <p>Service Cloud case ID: 01909753</p>
<p>All files in the specified OneDrive location are downloaded successfully when you use the <b>Download file</b> action from the Microsoft 365 OneDrive package.</p> <p>Service Cloud case ID: 01886501</p>
<p>If you selected the <b>Read cell value</b> option in the <b>Read row</b> action of the Excel advanced package, the data from the next sheet of the specified Excel file is extracted correctly using the <b>Switch to sheet</b> action.</p> <p>Service Cloud case ID: 01904504</p>
<p>If a bot contains <b>Get multiple cells</b> or <b>Get single cell</b> action from the Excel advanced package to retrieve the underlying scientific values, the values from the specified Excel file are successfully extracted when you run this bot.</p> <p>Service Cloud case ID: 01882225, 01938812</p>

Exception errors are no longer displayed for the following actions in the Excel advanced package:

- **Get single cell**
- **Get cell color**
- **Get multiple cell**
- **Get number of cells**
- **Get worksheet as data table**
- **Insert/Delete rows/columns**
- **Read cell formula**
- **Read column**
- **Read row**
- **Remove blank row**
- **Rename worksheet**
- **Replace**
- **Select cells/rows/columns**
- **Set call**
- **Switch to sheet**
- **Close**

Service Cloud case ID: 01780178, 01926325

If there are many (more than 500) bots deployed in one of the device when there are multiple devices connected to a Control Room, bot deployments across other devices are no longer blocked.

Service Cloud case ID: 01791784, 01950118, 01904686, 01795862, 01945357, 01941048

If you create a folder with the same name as an existing folder in the private workspace, an error message is now displayed, and the folder is not created.

Previously, a false successful folder creation message was displayed, but the last modified date of that particular folder remained the same as that of the previously existing folder.

When you create, view, or edit roles and then navigate to the **Bots** section, the folder list is sorted alphabetically making it easier to find a specific folder.

Previously, the folders were not sorted alphabetically, and it was difficult to find a particular folder when there were many folders in the repository.

Service Cloud case ID: 01762755, 01843015, 01874823

When you import a bot using the overwrite option and do not have permission to access one or more dependent folders, the import dependency is not broken because of the import failure on the dependent folder.

Previously, importing the bot when you had no permission to access the dependent folder resulted in a break in the dependency if the file or folder was already present.

Service Cloud case ID: 01929592, 01946078

When you import a bot that has more than 2,100 manual dependencies, the import is successful without any issues.

Previously, the bot import failed when the bot contained more than 2,100 manual dependencies. You had to reduce the number of dependencies to import the bot successfully.

Service Cloud case ID: 01913648, 01942373

When you have large number of processed work items, the new work items are processing in expected time without any delay.

Previously, in such cases, new work items were taking long time due to the query time out error. As a result, you were not able to deploy the bot with queue.

Service Cloud case ID: 01846496, 01939581

The group Managed Service Account (gMSA) provides functionalities such as install, update and perform LDAP authentication within a domain, and also extends those functionalities across multiple servers.

When you update Automation 360 to the v.28 release, the Elasticsearch service is replaced with OpenSearch service as the underlying technology for core product capabilities such as audit, Bot Insight, and so on.

Automation 360 for auto-login and RDP-based deployment supports the user name in the User Principal Name (UPN) format (username@domain.com).

Service Cloud Case ID: 01816116, 01906692

An error no longer displays when you click your trigger in the event trigger page.

You no longer encounter random bot deployment issues in the Bot editor.

Previously, during bot deployment, the `LockAcquisitionException` error was observed randomly, and the bot execution status remained as **Pending execution** in the **In progress activity** tab. As a result, the user had to retry deployment for it to succeed.

## Limitations

Bots that are in the **Queued** status do not appear automatically on the **In progress activity** page.

Workaround: Click the **Refresh table** button on the top-right corner of the **Activity** table to view the queued bots.

For users (excluding the users who are assigned the AAE\_Admin role) who do not have any license assigned to them (Bot Creator, UnattendedBot Runner, Attended Bot Runner, or Citizen Developer), the **Audit log** page displays multiple unsuccessful entries related to the **Default device set** event for any activity performed by the users on the Control Room.

Workaround: See [A360.28 On-Prem & Cloud | After upgrading to A360.28, multiple events are getting created in Audit logs 'Default device set Unsuccessful'](#).

Service Cloud case ID: 01969726, 01970583, 01970990, 01971435, 01971171, 01970869, 01971854, 01970915, 01970523, 01971411, 01971788, 01971827, 01971482, 01971736, 01970333, 01972128, 01970497, 01972025, 01971459, 01971561, 01971068, 01972148, 01975216, 01975980, 01977479, 02001122

(Service Cloud case ID: 01833352)

When you want to move emails from one folder to another, and if you apply multiple filters such as **Subject**, **From specific sender**, **When received date is on or after**, or **When received date is before**, you cannot move an email when its sender id is: noreply@\*\*.com.

**Note:** You might observe this issue when you use **Save All attachments**, **Delete All**, **Move All**, and **Loop** actions.

Workaround: Use only the **From specific sender** filter to move emails.

The **Create User** audit log entry page shows a valid device license even when the license allocation for a user had failed.

(Service Cloud Case ID: 01976942)

Duplicate entries of the same activity are listed in the **Activity > In progress** screen for the users who are assigned the same role and permission.

In a clustered environment, when you update bots to the default package versions, the **Bot update list** page shows **Failed** status and bots are auto-checked out even if they are updated with the latest default packages.

In an Oracle environment, the **Bot update list** page shows an Code : `db.connection.exception` error message.

Workaround:

1. Log in as an administrator.
2. Navigate to **Manage > Packages** and set the required package version as the default version.
3. Log in as a Bot Creator, and then check out and edit the bot.
4. In the Bot editor, click the three vertical ellipses at the top right corner.
5. Select required Packages and update the package version manually.

While updating bots to the default package version, when you select the **Production label** bots, the package update is applied for the latest version of bots instead of the **Production label** bots.

When you check out and edit a bot after the bot updates to the default package version, an error is displayed in the System Date for these commands: **SystemsDate**, REST Web Service, and Number.

Workaround:

1. Edit the bot and navigate to **Manage > Packages**.
2. Set the Date and Time for the non-default package, and then set it back to the default Date and Time.

---

**Note:**

- If previous version of the package does not exist, then upload the package and assign the default Date and Time.
  - If previous version of package is available, then edit the bot, assign it to the previous package and save. Then, re-assign the bot to the new default package.
- 

When a user (who created the workload automation) is deleted, work items are not processed even if they are available to process. As a result, you must delete and re-create the automation.

If you select the **Search type** as **Variable name** in the **Search and replace** feature, the content is not replaced when you use a number variable in the expression.

Workaround: To replace a specific variable in a number expression, open that action and change the variable manually.

(Service Cloud Case ID: 01950021)

If **Auto update** is enabled for the Bot Agent in Control Room, registered devices running Windows10 Enterprise might restart intermittently after the Bot Agent update has completed.

Bot deployments might fail if the **Log collector** and **Sync log collector** options are enabled while updating Automation 360 to v.28.

Workaround: Before updating Automation 360 to v.28 from any of the previous versions (such as v.25), ensure that the **Log collector** option within **Administration > Settings > Devices > Advanced options** and **Sync log collector** option within **Administration > Settings > Devices > Log collection configuration** are disabled.

---

**Note:** For information on resolving bot deployment issues caused when the **Log collector** or **Sync log collector** options were enabled while updating Automation 360 to v.28 release, see [.Troubleshoot bot deployment issue caused if Log collector is enabled \(A-People login required\)](#)

---

API Task is a beta feature in the v.28 release and is designed for Automation 360 cloud deployments only.

However, after you upgrade your On-Premises deployment to v.28, users with a Bot Creator license can create an API Task and users with either Device pool owner or Device pool admin permission can create an API Device pool. But you will not be able to execute the API Tasks. In an upcoming update, the API Task feature will be fully turned off on On-Premises deployments and will be available only on the upcoming Automation 360 cloud deployments.

Bot export fails when you export a bot that contains actions that store an image, such as actions from **Recorder**, **Image Recognition**, or **Screen** package. You can view the export error in the audit log and the historical activity page.

Workaround: Contact Automation Anywhere Support.

After you update Automation 360 to v.28, when you cancel the update process after removing all the services, the rollback of the services does not happen. As a result, you will encounter an error message, when you attempt Automation 360 update.

#### Limitations from previous releases

While running a bot in debug mode, the bot will fail if the variable size gets greater than 3 MB. An error message appears showing that a variable has exceeded the 3 MB limit.

When you create a device pool with a temporary (disconnected) device, the device deletion job does not complete successfully. Additionally, the **Audit log** page shows the device is deleted, whereas the **Device list** page shows the deleted device in the list.

## Feature deprecations

Review features and capabilities (from Automation Anywhere or other third-party vendors) that are deprecated or nearing deprecation to understand how they impact your automation.

Deprecated weaker Transport Layer Security protocols: TLS 1.0 and TLS 1.1

Automation Anywhere has deprecated weaker communication protocols TLS 1.0 and TLS 1.1, and their corresponding ciphers (Cryptographic algorithms) in Automation 360 Cloud deployments (AWS and GCP). Automation 360 Cloud deployments support TLS 1.2 and later versions only.

[Feature deprecations affecting Automation Anywhere products](#) on page 1086

### Manifest V2 extensions for Google Chrome and Microsoft Edge

From Automation 360 v.26 and later releases, we have published new Google Chrome and Microsoft Edge Manifest V3 extensions. Starting on October 23, 2023, we will deprecate support for Manifest V2 extensions on Automation 360 v.26 and later releases. After this date, we will not address any issues relating to Manifest v2 extensions. If you are on Automation 360 v.26 or a later release and still using Manifest V2 extensions for Google Chrome and Microsoft Edge, we recommend that you upgrade your Google Chrome and Microsoft Edge browser extensions to Manifest V3 extensions before October 23, 2023.

**Note:** If you are on Automation 360 v.25 or earlier releases, then you will not be impacted.

## Updates to the interface

Review the updates to the interface in this release.

See the following video for the updates made to the interface for Automation 360 v.28 release:

The **Enter property set to your CyberArk username** option is introduced on the **Service Credentials** page to configure usernames using the CyberArk secret response.

[Configure username for different Automation 360 services using the CyberArk secret response](#)

You can import intermediate certificates when installing Control Room On-Premises.

[Import intermediate certificates for secure access to Control Room](#)

The **Control Room Service Startup Options** page is introduced when installing the Automation 360 Control Room to select the services to run at Control Room startup.

[Select the Control Room services to run at startup](#)

The bot updates to default package version functionality is enhanced and moved from **Manage > Packages** to **Administration > Bot update** page.

[Bulk update of multiple packages to default version for multiple bots](#)

The **Allow users to control notifications settings** option is added to control and lock the user preferences for notifications.

[Improved notifications administration to manage user access](#)

The **Process events** notifications category is introduced to monitor Automation Co-Pilot events.

[Monitor Automation Co-Pilot events through Control Room notifications](#)

A check box is added to clear the existing default device for the logged-in Bot Creator, attended Bot Runner, or Citizen Developer/Citizen developer users.

[Validate remote deployments to avoid unauthorized device access](#)

<p>Updated and intuitive icons for all the actions and contextual help for various actions within packages. For example, contextual help is available for all the actions within the Excel advanced package.</p> <p><a href="#">Enhanced user experience through refreshed and intuitive icons</a></p>
<p>The enable or disable functionality of code analysis is moved from <b>Administration &gt; Policies</b> to <b>Administration &gt; Settings &gt; Policies</b>.</p> <p><a href="#">Enhancements to code analysis</a></p>
<p>The visual indicator line marker for the collapsible section helps you see where in the bot you are and editing.</p> <p><a href="#">Line markers for collapsible sections of the code in the Bot editor</a></p>
<p>We provide implicit preference to retain the default view in the Bot editor, and the system will display the same view upon your subsequent login.</p> <p><a href="#">Default view in the Bot editor</a></p>
<p>You can now copy, cut, and paste the entire node in the Process Composer. These actions apply to all properties and attributes of the node, including child and branch elements.</p> <p><a href="#">Copy, cut, and paste actions</a></p>
<p>The Process Composer supports Global Values in variables.</p> <p><a href="#">Global values as variable</a></p>

## Updating to v.28 release

Review requirements and support information about updating your Control Room and Bot Agent for the v.28 release.

## Bot Agent updates

**Note:** This release includes an optional Bot Agent update. You can continue to run your existing bots without updating the Bot Agent. However, if you want to use the new features in Automation 360 v.28, you must update the Bot Agent available with this release.

For more information on updating to this release, see these resources:

- [Automatically update the Bot Agent](#) on page 1361 | [Manually update the Bot Agent](#) on page 1362
- [Compatibility with release builds](#) on page 1333

## Certified Control Room builds for direct update

You can update to the latest version of Automation 360 from the previous three releases (that is, from n–3 releases, where n refers to the latest release).

The following previous releases are certified for update to Automation 360 v.28:



- v.27 (Build 16685, 16667)
- v.26 (Build 15450, 15459, 15439, 15436)
- v.25 (Build 15112, 15118, 15097)

If you are on one of these previous releases, for information about updating, see [Update Automation 360 to latest version](#) on page 1423. If you are not on an n–3 release, update Automation 360 to one of the n–3 releases before updating to Automation 360 v.28.

**Important:** Before you update to Automation 360 v.28 On-Premises from any of the earlier versions, review the following article: [Automation 360 On-Premise Edition | A360.28 – Upgrade Considerations \(A-People login required\)](#). This article is applicable only to On-Premises customers who started using Automation 360 from v.15 or previous versions. To successfully update to Automation 360 v.28, you must perform the pre-upgrade steps in the KB article.

## Packages updated in v.28

Review updates to the packages in Automation 360 v.28, including the compatible Control Room and Bot Agent versions.

The following table lists the updates in the packages for this release:

**Note:** For information about packages related to previous releases, see the PDFs for these releases: [Automation 360 previous release versions](#).

Package name	Version	Package updates	Bot Agent version	Control Room version
Active Directory	3.7.0-20221220-192949	<a href="#">Defect fix</a>	20.11 or later	8750 or later
Analyze	2.7.1-20230119-101334	Fixed the localization changes	20.11 or later	8750 or later
Apigee	1.0.5-20230104-172954	<a href="#">New feature</a>	21.22 or later	15422 or later
App Integration	4.11.1-20230116-050031	<a href="#">Defect fix</a>	21.88 or later	10195 or later
Application	3.7.0-20221226-112745	Contextual help link to documentation added	20.11 or later	8750 or later
Boolean	2.7.0-20230104-120816	Internal renaming of an attribute (no impact to existing#bots#on upgrade)	20.11 or later	8750 or later

Package name	Version	Package updates	Bot Agent version	Control Room version
Bot Migration	10.5.1-20230105-135500	<ul style="list-style-type: none"> <li>• <a href="#">New feature</a></li> <li>• <a href="#">Defect fix 1</a></li> <li>• <a href="#">Defect fix 2</a></li> <li>• <a href="#">Defect fix 3</a></li> <li>• <a href="#">Defect fix 4</a></li> <li>• <a href="#">Defect fix 5</a></li> <li>• <a href="#">Defect fix 6</a></li> <li>• <a href="#">Defect fix 7</a></li> <li>• <a href="#">Defect fix 8</a></li> <li>• <a href="#">Defect fix 9</a></li> <li>• <a href="#">Defect fix 10</a></li> <li>• <a href="#">Defect fix 11</a></li> </ul>	21.220 or later	15224 or later
Browser	3.8.4-20230118-065250	<ul style="list-style-type: none"> <li>• <a href="#">Contextual help link to documentation added</a></li> <li>• <a href="#">Defect fix 1</a></li> </ul>	21.210 or later	14140 or later
Clipboard	3.6.0-20221222-050025	Fixed an issue related to data logging at debug level	20.11 or later	8750 or later
Comment	2.13.2	Added intuitive package icon	20.11 or later	8750 or later

Package name	Version	Package updates	Bot Agent version	Control Room version
Credential	1.5.0-20230104-151556	Fixed an issue related to renaming of an attribute (no impact to existing#bots#on upgrade)	20.11 or later	8750 or later
CSV/TXT	2.11.1-20221229-045349	Added intuitive package icon	20.11 or later	8750 or later
Database	4.11.3-20230104-151847	<ul style="list-style-type: none"> <li>New feature</li> <li>Defect fix</li> <li>Defect fix 1</li> </ul>	21.88 or later	10204 or later
Data Table	4.7.2-20230106-071425	New feature	20.11 or later	8750 or later
Datetime	2.11.1-20230104-114826	<ul style="list-style-type: none"> <li>Defect fix 1</li> <li>Defect fix 2</li> </ul>	20.11 or later	8750 or later
Delay	3.7.0-20230104-151127	Fixed an issue related to renaming of an attribute (no impact to existing#bots#on upgrade)	20.11 or later	8750 or later
Dictionary	3.11.1-20230104-114813	Internal renaming of an attribute (no impact to existing#bots#on upgrade)	20.11 or later	8750 or later

Package name	Version	Package updates	Bot Agent version	Control Room version
DLL	6.8.2-20230103-110720	<ul style="list-style-type: none"> <li>Defect fix 1</li> <li>Defect fix 2</li> </ul>	21.220 or later	15238 or later
Document Extraction	3.28.31	Fixes	21.98 or later	15345 or later
Email	3.16.2-20230106-082520	<ul style="list-style-type: none"> <li>New feature</li> <li>Defect fix</li> </ul>	21.210 or later	13980 or later
Email trigger	2.10.2-20230106-091325	Security updates	21.210 or later	13980 or later
Error handler	2.11.2-20230106-100004	Added intuitive package icon	20.11 or later	8750 or later
Excel advanced	6.14.0-20221221-171419	Defect fix	21.112 or later	11307 or later
Excel basic	6.14.0-20221221-171419	Contextual help link to documentation added	21.112 or later	11307 or later
File	6.6.1-20230105-072958	Contextual help link to documentation added	21.98 or later	10789 or later
File and Folder	1.3.0-20221014-182105	None	20.11 or later	8750 or later
Folder	6.6.0-20221227-142432	Defect fix	20.11 or later	8750 or later
FTP / SFTP	2.9.0-20221223-132614	Defect fix	20.11 or later	8750 or later
Genesys	1.2.2	<ul style="list-style-type: none"> <li>Now available for API as a service</li> <li>Security updates</li> </ul>	21.210 or later	14199 or later

Package name	Version	Package updates	Bot Agent version	Control Room version
Google Calendar	2.10.2-20221230-040445	Security updates	20.11 or later	8750 or later
Google Drive	2.11.2-20221230-041416	Security updates	20.11 or later	8750 or later
Google Document AI	1.2.0-20220616-091307	Fixed the vulnerabilities reported in the security scan	21.98 or later	10520 or later
Google G Suite	2.8.0-20220416-235104	None	20.11 or later	8750 or later
Google Sheets	2.11.2-20221230-041629	Defect fix	20.11 or later	8750 or later
Hot key	1.1.0-20220715-220729	None	NA	NA
If	3.6.1-20230106-055132	New feature	20.11 or later	8750 or later
Image Recognition	3.13.1-20230106-082442	Defect fix	21.210 or later	14100 or later
Interactive forms	2.28.2-20230105-100123	<ul style="list-style-type: none"> <li>Defect fix</li> <li>Fixed parsing issues with binary data</li> <li>Fixed security vulnerability issues</li> </ul>	20.11 or later	8750 or later
Interface trigger	1.6.1-20230106-195659	None	20.11 or later	8750 or later
IQ Bot	2.3.0-20221219-065939	Fixed the vulnerabilities reported in the security scan	21.98 or later	10520 or later

Package name	Version	Package updates	Bot Agent version	Control Room version
IQ Bot Classifier	2.4.5-20221219-065852	Fixed the vulnerabilities reported in the security scan	21.98 or later	10520 or later
IQ Bot Pre-processor	2.3.5-20221219-065610	Fixed the vulnerabilities reported in the security scan	21.98 or above	10520 or later
JavaScript	2.14.1-20221229-051614	Security updates	20.11 or later	8750 or later
JSON	1.4.1	Fixed security vulnerability issues	21.98 or later	10520 or later
Legacy AISense	2.1.0-20221219-144922	Fixed a security vulnerability issue	21.220 or later	15224 or later

Package name	Version	Package updates	Bot Agent version	Control Room version
Legacy Automation	5.7.0-20221223-014734	<ul style="list-style-type: none"> <li>Fixed window titles when migrating bots using the <b>Convert bots built using Internet Explorer to Edge with Internet Explorer mode</b> option.</li> <li>Fixed the <b>Web Control Exists</b> and <b>Web Control Does Not Exist</b> command migration behavior when using the <b>If, Else If, and Loop</b> conditions.</li> </ul>	21.200 or later	13279 or later
List	2.10.3-20230104-171708	Improvements in package logs for GDPR	26.11 or later	8750 or later

Package name	Version	Package updates	Bot Agent version	Control Room version
Log To File	3.6.0-20221223-065420	Added intuitive package icon	20.11 or later	8750 or later
Loop	3.7.4-20230214-021503	New feature	20.11 or later	17208 or later
Message Box	3.5.0-20221223-065722	Added intuitive package icon	20.11 or later	8750 or later
Mouse	2.13.0-20221219-090558	Security fix	21.210 or later	14100 or later
Number	3.7.1-20230105-092807	Fixed an issue related to renaming of an attribute (no impact to existing #bots#on upgrade)	20.18 or later	9130 or later
OCR	2.11.1-20221223-102046	Contextual help link to documentation added <ul style="list-style-type: none"> <li>Added intuitive package icon</li> </ul>	21.118 or later	8750 or later
Microsoft 365 Calendar	2.11.2-20230106-045143	Updated the contextual help description for Office365 Calendar package	20.11 or later	8750 or later
Microsoft 365 Excel	2.11.2-20230106-045143	Security updates	20.11 or later	8750 or later



Package name	Version	Package updates	Bot Agent version	Control Room version
Microsoft 365 OneDrive	2.11.2-20230106-045143	Contextual help link to documentation added	20.11 or later	8750 or later
PDF	3.8.0-20221222-051223	Fixed an issue related to data logging at debug level	21.31 or later	9300 or later
PGP	3.5.1-20221215-094141	Security fix	21.88 or later	10195 or later
Ping	3.4.0-20220416-234250	None	20.11 or later	8750 or later
Play Sound	2.6.0-20220421-071315	None	20.11 or later	8750 or later
Printer	2.4.0-20220118-154256	None	20.11 or later	8750 or later
Process Composer (AARI web)	7.28.1-20230311-062034	<ul style="list-style-type: none"> <li>The package is now supported in API Bots.</li> <li>Name of package changed to Process Composer.</li> <li><a href="#">New Feature</a></li> </ul>	21.134 or later	12316 or later
Process trigger	1.3.0-20220118-154818	None	21.112 or later	11314 or later
Prompt	2.6.0-20220118-154257	None	20.11 or later	8750 or later

Package name	Version	Package updates	Bot Agent version	Control Room version
Python Script	2.14.1-20221229-051316	<ul style="list-style-type: none"> <li>Contextual help link to documentation added</li> <li>Added intuitive package icon</li> </ul>	20.11 or later	8750 or later
Record	1.7.0-20230104-120809	Internal renaming of an attribute (no impact to existing bots on upgrade)	20.11 or later	8750 or later
Recorder	2.10.2-20230104-214915	<ul style="list-style-type: none"> <li>New feature 1</li> <li>New feature 2</li> <li>Defect fix 1</li> <li>Defect fix 2</li> <li>Defect fix 3</li> <li>Defect fix 4</li> <li>Defect fix 5</li> </ul>	21.210 or later	14068 or later
REST Web Service	3.13.3-20230111-084505	<ul style="list-style-type: none"> <li>Defect fix 1</li> <li>Defect fix 2</li> </ul>	20.11 or later	8750 or later

Package name	Version	Package updates	Bot Agent version	Control Room version
Salesforce	1.2.3-20230104-213229	Fixed an issue that prevented to retrieve the entire response of the Salesforce Execute SOQL action.	21.222 or above	15422 or above
SAP	3.9.1-20230106-084803	Contextual help link to documentation added	21.88 or later	10195 or later
SAP BAPI	2.7.0-20220424-053247	None	21.2 or later	9249 or later
Screen	2.8.0-20220426-033758	None	20.11 or later	8750 or later
Service	4.7.0-20230104-104507	Fixed an issue related to renaming of an attribute (no impact to existing #bots#on upgrade)	20.11 or later	8750 or later
Service trigger	1.5.1-20220425-083711	None	21.112 or later	11314 or later
ServiceNow	1.0.4-20230104-180207	Fixed the localization changes	21.230 or later	16455 or later
Simulate keystrokes	4.1.1-20230105-145653	<ul style="list-style-type: none"> <li>Contextual help link to documentation added</li> <li>Added intuitive package icon</li> </ul>	21.200 or later	13297 or later
SNMP	2.5.0-20220419-063009	None	20.11 or later	8750 or later

Package name	Version	Package updates	Bot Agent version	Control Room version
SOAP Web Service	3.14.1-20230106-135700	<ul style="list-style-type: none"> <li>Contextual help link to documentation added</li> <li>Added intuitive package icon</li> </ul>	21.90 or later	10227 or later
Step	2.5.0-20230105-135537	Fixed an issue related to renaming of an attribute (no impact to existing bots on upgrade)	20.11 or later	8750 or later
String	5.7.1	Fixed an issue on incorrect output with regex expression for Replace action	20.18 or later	9130 or later
System	3.11.2-20230106-081933	Security updates	21.88 or later	10217 or later
Task Bot	2.7.1-20230106-103206	<ul style="list-style-type: none"> <li>Contextual help link to documentation added</li> <li>Added intuitive package icon</li> </ul>	20.11 or later	8750 or later
Terminal Emulator	4.9.1-20221228-142629	<ul style="list-style-type: none"> <li>New feature</li> <li>Defect fix</li> </ul>	21.93 or later	10353 or later

Package name	Version	Package updates	Bot Agent version	Control Room version
Text file	1.5.0-20221222-053606	Added intuitive package icon	20.11 or later	8750 or later
Trigger loop	0.7.0-20220715-220725	None	20.11 or later	8750 or later
V11 Task Bot	1.13.0-20221219-121308	Security fix	20.11 or later	8750 or later
VBScript	2.17.0-20221220-040041	Added intuitive package icon	21.210 or later	14100 or later
Wait	4.8.1-20230105-092655	Defect fix	20.11 or later	8750 or later
Window	5.9.0-20221221-162100	Defect fix	20.11 or later	8750 or later
Window trigger	1.4.0-20220118-154823	None	20.11 or later	11314 or later
Workday	1.0.2-20230104-180822	New feature	21.231 or later	17076 or later
Workload	2.11.1-20230111-231550	New feature	20.11 or later	8750 or later
XML	3.9.2-20230106-053150	<ul style="list-style-type: none"> <li>New feature</li> <li>Defect fix</li> </ul>	20.11 or later	8750 or later

## Migration updates for v.28 release

Review what's new, changed, and the fixes and limitations to migrating from Enterprise 11 and 10 versions to Automation 360 v.28.

### What's changed

Migration of new formatting capabilities in the XML package (Service Cloud case ID: 01886455, 01925386)

- When you migrate bots from Enterprise 11 to Automation 360 that are using the **Start session** action, the **Remove text nodes that contain only white space** check box is selected by default.
- When you migrate bots from Enterprise 11 to Automation 360 that are using the **Save session data** action, the **Use Prettyprint** check box is selected by default.

[Start session action in XML](#) on page 3191 | [Save session data action in XML](#) on page 3191

### Fixes

You can migrate bots with filenames that contain up to 160 characters, and might use an action with an encrypted value or Credential Value (CV) type variable.

Previously, these bots failed when migrating to Automation 360.

Service Cloud case ID: 01813733

You can successfully run the migrated bots in the following scenarios:

- If there is more than one xmlns (default XML namespace) defined in the XML document.
- If the root element does not have a namespace and the child element of the XML package has a default namespace.

Service Cloud case ID: 01798339

You can migrate the MetaBots that are using `Microsoft.Exchange.WebServices.dll` as the dependency DLL, use the **Get DLL details** option during bot design, and then execute the **DLL Run function** action without encountering an error.

Previously, an error was encountered when the `Microsoft.Exchange.WebServices.dll` was used as a dependency DLL of a bot.

Service Cloud case ID: 01819485, 01857278

You can migrate MetaBots that are using multiple logics without using the overwrite option even if some of the logics already exist in Automation 360.

Previously, such MetaBots encountered an error during migration.

Service Cloud case ID: 01905986

<p>You can migrate MetaBots which include logic that calls another logic whose file name includes a dollar sign (\$).</p> <p>Previously, such MetaBots were displaying a review message on the migration results page.</p>
<p>If you set the <b>Set production version</b> permission in Enterprise 11, after migration to Automation 360, the <b>Label bots</b> permission is selected and replaces the previous <b>Set production version</b> permission. If you are upgrading from a previous Automation 360 release to v.28 (or later release) and you selected the <b>Set production version</b> permission, then the <b>Label bots</b> permission is selected as the default.</p> <p>Service Cloud case ID: 01868097</p>
<p>In Enterprise 11, if a bot is using the String Operation command and includes a backslash (\) in the <b>Replace</b> string, after migration, the bot executes properly.</p> <p>Previously, such a bot encountered an error when a backslash (\) was used in the <b>Replace</b> string.</p> <hr/> <p><b>Note:</b> This fix is currently not available in Automation 360 v.28 and v.29. The fix is available in the Automation 360 v.30 release. For more information, see <a href="#">Migration updates for v.30 release</a> on page 61.</p>
<p>In Enterprise 11, if a bot was using the <b>Normal, Gray-Scale, or Monochrome</b> comparison mode in the Image Recognition command, after migration, the performance of the bot run is improved.</p> <p>Previously, the performance of such a bot was impacted during a bot run.</p> <p>Service Cloud case ID: 01889347, 01922609, 01920990</p>
<p>In Enterprise 11, if bots are using the recorder commands, some unused hidden properties remain in Enterprise 11 only after you migrate to Automation 360.</p> <p>Previously, some unused hidden properties were migrated.</p> <p>Service Cloud case ID: 01608928</p>
<p>You can migrate a bot that contains a <b>Database</b> with a <b>Loop</b> command and run it successfully in Automation 360.</p> <p>Previously, when you ran the bot in Automation 360 using the <b>Read from</b> action with append and UTF-8 encoding with the loop, after the first iteration, the retrieved data would show a double quote for the first cell value in the CSV file.</p> <p>Service Cloud case ID: 01911654</p>
<p>When you migrate a bot that contains the <b>XML &gt; Get single node</b> command, after migration, when you run the bot in Automation 360, it retrieves the value of a single node and no longer displays an error on execution.</p> <p>Previously, if the XPath started with open brackets, and you ran the bot in Automation 360, the bot encountered the following error: <b>No node found at XPath while executing the Get Single node command.</b></p> <p>Service Cloud case ID: 01854326</p>

You can migrate bots that are using the **If Variable** command with the following conditions:

- Includes multiple **Excel Cell** variables.
- Includes one or more AND or OR operators for comparison.
- The **Excel Cell** variables are compared with array type variables.

Previously, such bots failed to migrate.

Service Cloud case ID: 01856986

You can migrate bots that are using commands that include the **Session Name** field that contains the year (\$year\$) system variable.

Previously, such bots failed to migrate.

Service Cloud case ID: 01867380

When you migrate bots that are using Table type variables and then call those migrated bots from another Task Bot, the input variables are displayed on the **Set input variables** window.

Previously, when migrated bots containing Table type variables were called from another Task Bot, the input variables did not display.

Service Cloud case ID: 01920824, 01931439, 01945917, 01910787, 01930540, 01923133, 01931439, 01923133, 01934727

You can successfully migrate bots when you provide a clipboard value as a parameter to a VBScript file without any issues.

Previously, if you provided a clipboard value as a parameter in a bot, the bot migration failed with an error message indicating there was no proper variable selection for the clipboard.

In Automation 360, when you use the **SOAP Web Service** command in a bot, you can access the specific XML node from the XPath expression which has a namespace declaration from the SOAP response.

Previously, XPath expressions containing a namespace could not be parsed.

Service Cloud case ID: 01907999

When you migrate a bot that uses the **Send Email** command with the **HTML** option and run the migrated bot in Automation 360, the output is displayed in the appropriate format.

Previously, if you had used a variable in the HTML code section of the email body and ran the migrated bot in Automation 360, the code was not converted to HTML format. As a result, the output was displayed in an incorrect format.

Service Cloud case ID: 01908010

The **Review Required** count in the Bot Scanner report and Bot Assistant display consistent information.

Previously, there was inconsistency in the count.

Service Cloud case ID: 01816554, 01856822



## Remote agent v.2.2.0 updates

A new version of the Remote agent is released with Automation 360 v.28. This section includes the fixes for Remote agent version 2.2.0.

### Fixes

<p>Improved automation reliability for web applications</p> <p>When you use the <b>Recorder &gt; Capture</b> action to automate web pages running on Google Chrome and Microsoft Edge browsers, the <b>Recorder &gt; Capture</b> action no longer scrolls down the web page if the target object is visible on the screen. This feature improves the user experience and reliability of automation when there is a fixed top pane on the web page and if some physical actions such as mouse clicks do not work as expected.</p> <hr/> <p><b>Note:</b> Ensure that you install the browser extension (version 3.0.8.0) and use the Recorder package (version 2.10.2) to capture the control.</p> <hr/>
<p>When you use the Recorder package (version 2.10.2 or later) to capture a control on a web page, select <b>Currently active</b> window from the <b>Application</b> tab and then run the bot in a loop, the bot now captures the target control accurately and runs through all the loop iterations successfully even if the control appears behind the bot runtime window.</p> <p>Service Cloud case ID: 01904537</p>
<p>When you use multiple Recorder actions in a bot to automate a specific web page running in Microsoft Edge with IE mode, and then run the bot, the second Recorder action now works properly, and the bot no longer encounters an error.</p> <p>Service Cloud case ID: 01848824, 01868337</p>
<p>When you use the <b>Click</b> action in the Recorder to automate applications running on Microsoft Edge with IE mode, the bots now time out automatically and no longer freeze when a pop-up appears during bot execution.</p> <p>Service Cloud case ID: 01790352</p>
<p>When you use the <b>Capture</b> action with the Recorder package (version 2.9.x or earlier) to navigate to another web page in the Google Chrome browser (version 105.0 or later), and then use another <b>Capture</b> action to automate objects in the navigated web page, the bot no longer encounters an error.</p>

## CoE Manager v.28 release

Review what's new and changed, and the fixes and limitations in CoE Manager for the v.28 release.

### What's new

#### Access CoE Manager from the Control Room

As an administrator, you can enable access to CoE Manager from the Control Room. This enhances the user experience because the user no longer needs to open CoE Manager through a separate browser tab. Once CoE Manager is enabled, users can directly access the CoE Manager login page from the quick link section on the Control Room home page.

[Enable CoE Manager](#) on page 2076

#### Support for ROI tracking in On-Premises Control Room

You can integrate both the Cloud and the On-Premises Control Room with the CoE Manager. This enables you to monitor your automations and analyze the savings achieved. You can connect up to 3 Control Room instances in your CoE Manager.

For the On-Premises Control Room, to upload the bot activity data from the Control Room to the CoE Manager, download and run the CoE Manager bot available in the Bot Store. To run this bot, you must have a valid license such as a Bot Creator, Bot Runner, or a Citizen Developer.

[CoE Manager - Integrate with On-Premises Control Room](#) on page 2074

### What's changed

#### Plan delivery for your opportunities from the pipeline stage

The **Activities** tab is available in the pipeline stage enabling you to start the delivery planning of an opportunity when it moves into the pipeline stage.

Previously, you could plan delivery of an opportunity using the **Activities** tab only after the opportunity had moved into the in-progress stage.

## Automation Co-Pilot for Business Users v.28 release

Review what's new and changed, and the fixes and limitations in Automation Co-Pilot for the v.28 release.

### What's new

#### Enhanced automation experience for Automation Co-Pilot

We have improved the automation experience for your automation activities to run attended bots:

- As a prerequisite, you must have the **Manage my activity** permission to use the bot controls.
- When you run your attended automation, its progress, execution status, and controls for pause, start (resume), and stop, are located on the new progress page inside the Automation Co-Pilot application.
- You can easily switch between the **Automation** tab to execute additional automations and navigate back to the progress view, to monitor the running automations.

[Automation Co-Pilot for Business Users supported features](#) on page 3312

#### Platform alerts and notifications

You will be notified with real-time message alerts based on recent automation events that occurred in Automation Co-Pilot.

- The **Notifications** tab in the Automation Co-Pilot will alert you of your automation outcomes (failed, successful) and provide as detailed information for each bot, such as the start and end times.
- When required, there is a short message describing if any specific issues occurred.
- The **New task assigned** message will notify you if any new tasks were assigned to you, and you can click that alert message to be redirected to the newly assigned tasks.
- Similarly, if you receive multiple new notifications, you can click the Load New Notification message, located at the top of the notification list, to load additional unread notifications.

[Automation Co-Pilot for Business Users supported features](#) on page 3312

#### Stationary action buttons

While completing forms in Automation Co-Pilot, action buttons are positioned in the fixed footer of the form. The footer and its contents are responsive to the size of your window and adjust to fit buttons and minimize the footprint.

[Add Form Task to a process automation](#) on page 3458

## What's changed

<p>Enhancements to tags</p> <p>When you configure a process, tag improvements provide a more accurate tag selection when you look for available tags:</p> <ul style="list-style-type: none"> <li>You can select and manage up to 500 tags at a time, in tag selector.</li> <li>Your search results will vary depending on the number of search terms you use with the most recently created tags always showing at the top.</li> <li>You can use the <b>search all tags</b> option to search for all available tags.</li> </ul> <p><a href="#">Configure a process</a> on page 3398   <a href="#">Automation Co-Pilot for Business Users supported features</a> on page 3312</p>
<p>Process level URL parameters</p> <p>These process level URL improvements make it easier for you to pass URL data to your requests:</p> <ul style="list-style-type: none"> <li>You can pass custom data from applications to requests.</li> <li>Supported data types include: dates, time, number, text box, check box, radio button, text area, and drop-down.</li> <li>Hidden variable types in a form are supported to receive URL data.</li> </ul> <p><a href="#">Automation Co-Pilot for Business Users supported features</a> on page 3312</p>
<p>Improved formatting options for Label element</p> <p>The <b>Label</b> element has been improved with new formatting properties where you can configure the font sizes, colors, and text alignments in a form.</p> <p><a href="#">Using the Label element</a> on page 3444</p>
<p>The name of the Process Editor has been changed to Process Composer to better reflect its comprehensive capabilities.</p>
<p>Forms have improved responsiveness due to this next generation of form rendering technology.</p>
<p>Users receive a notification in the Warning tab when a task is assigned or reassigned to them.</p> <p>Service Cloud case ID: 01869263</p>

## Fixes

Build 17571 (On-Premises) and Build 17557 (Cloud): These builds includes the following fix (along with fixes from the previous builds):

When you open a request, that is in an open status, the request page will now render properly. Previously, when you use a form that contains a table and you pass a data variable to more than the column numbers that was specified, this caused the form to not render properly. This issue has been fixed.

Service Cloud case ID: 01970938, 01970524, 01969797, 01973370

When you use a table element in your form which contains a text area data type, the text area generates data from the database without issues.

Service Cloud case ID: 01905252

In a table cell field, when you enter Chinese, Japanese, and Korean characters, the characters renders correctly.

Service Cloud case ID: 01914818

When you create a form with a column width that is less than 20% in Automation 360 v.26 and you open the form in the current version, the will now render without issues.

Service Cloud case ID: 01944387

In an Automation Co-Pilot process, when you use the **if/else** condition, a process error no longer occurs when you add the **else if** condition after the **if** condition.

Service Cloud case ID: 01949808

In Automation Co-Pilot Web forms, the text area size renders as specified. Previously, the height did not render as designed.

Service Cloud case ID: 01911488, 01910936, 01914476, 01924252, 01929268, 01946479, 01958805, 01961238, 01997996

When filtering Automation Co-Pilot requests by date, the date displays correctly.

Service Cloud case ID: 01915259

Automation Co-Pilot forms works as expected when adding a new rule to an existing form.

Service Cloud case ID: 01925778

When a required field has not been completed, the process prevents users from submitting the task.

Service Cloud case ID: 01932933, 01958556

When a parent process in a private folder references a child process in a public folder the Process Composer alerts the user to the missing dependency with a local error. Previously a process with this dependency would fail when run, throwing a global error.

Service Cloud case ID: 01849502

In Automation Co-Pilot Desktop Assistant, the last runtime information no longer causes performance issues.

## Limitations

When you view your bot details in the **Historical Activity** page, the description for the bot errors are not populated.

Workaround: To access the description of the bot error, you can access the error log from the **Audit Logs** panel.

Service Cloud case ID: 01850454, 01908923

When you use the Search and Replace option to replace a form variable in a bot, the Search and Replace option does not function properly and cannot locate the form variable.

When using a form with an image, users require the View permission to access the image and have it render in forms.

In Automation Co-Pilot Desktop Assistant, when you use the Email Automation command with the email server option and set Google Chrome as the default browser, and you run your bot, the browser does not open to generate email details. This issue does not occur if you select a non-interactive mode of authentication.

## Updates to the interface

Review the updates to the interface in this release. Use the following video to orient yourself to these changes.

While completing forms in Automation Co-Pilot, action buttons are positioned in the fixed footer of the form.

[Stationary action buttons](#)

We have improved the automation experience for your automation activities to run attended bots.

[Enhanced automation activities](#)

You will be notified with real-time message alerts based on recent automation events that occurred Embedded Automation.

[Platform alerts and notifications](#)

The **Label** element has been improved with new formatting properties where you can configure the font sizes, colors, and text alignments in a form.

[Label element](#)

## IQ Bot and Document Automation v.28 release

Review what's new and changed, and the fixes and limitations in IQ Bot and Document Automation for the v.28 release.

### Document Automation

What's new
<p>Standardize the format of extracted numbers and dates</p> <p>You can configure your learning instances to convert extracted dates and numbers to a standard format. This ensures consistency and accuracy in your databases and other systems of record.</p> <p>For example, if you select to standardize dates to MM/DD/YYYY and a processed document contains a date that appears as 12 Feb 2023, the learning instance will reformat the date to 02/12/2023.</p> <p>If you select to standardize numbers to the English (United States) locale and a processed document contains a number that appears as 100,00, the learning instance will reformat the number as 100.00.</p> <p><a href="#">Create a learning instance in Document Automation</a> on page 3642</p>
<p>The new Document Workspace license tracks consumption for customers who brought their own license for Google Document AI or Standard Forms.</p>
<p>New Google Document AI features</p> <ul style="list-style-type: none"> <li>Validation feedback is available for new and existing learning instances that use Google Document AI to extract data.</li> </ul> <p><a href="#">#unique_315/unique_315_Connect_42_sec-validation-feedback</a> on page 3662</p> <hr/> <p><b>Note:</b> You must manually enable validation feedback for existing learning instances</p> <hr/> <ul style="list-style-type: none"> <li>The invoices document type supports these additional languages: Estonian, French, German, Latvian, Lithuanian, Portuguese (Continental), Romanian, Spanish, and Swedish.</li> <li>The receipts document type supports Japanese language documents and can extract two new fields: payment type and last four digits of credit card.</li> </ul>
<p>New features for the Document Workspace dashboard in Bot Insight</p> <ul style="list-style-type: none"> <li>Create custom widgets</li> <li>The <code>validator performance by # of documents validated</code> widget includes invalid documents.</li> </ul> <p><a href="#">Document Workspace dashboard</a> on page 3937</p>

What's changed
<p>Download bots have the highest priority in a queue</p> <p>To optimize system performance, the Control Room prioritizes running the download bot of one process before running the extraction bot for another process. Previously, the system was configured with the extraction bots at equal priority to the download bots, which created a large queue of extracted data waiting to download.</p> <hr/> <p><b>Note:</b> For users with Control Room environments configured prior to v.28: The Control Room admin must edit the <code>aari-document-processor</code> custom role to assign the new <b>Set automation priority to high</b> permission.</p> <p><a href="#">Create a custom role for Document Automation</a> on page 3638</p> <hr/>
<p><b>Important:</b> New Community Edition users will have access to Document Automation but not IQ Bot</p> <p>As of Automation 360 v.27 release and later, only Document Automation will be provisioned to new Community Edition users. New users will not have IQ Bot permissions, however, IQ Bot will be available for existing, registered users.</p> <hr/>

Fixes
<p>When you create a learning instance, the interface allows field names that start with a letter only. Previously, the interface allowed field names to start with a number, which caused processing errors.</p>
<p>The <b>Test regular expression</b> field supports a maximum of 100 characters.</p>
<p>You can create a learning instance with custom fields that do not have a field name and field label, as long as the custom fields are unselected.</p>
<p>Document Automation extracts multiline fields without adding an extra space after each line.</p>
<p>Document Automation supports document processing on devices configured with an authenticated or unauthenticated Proxy Auto-Configuration (PAC) file.</p>
<p>The Document Workspace dashboard shows the correct page consumption metrics for On-Premises Control Room instances.</p>
<p>The "Average validation time" and "Validator performance by number of documents" widgets show the correct values when you mouse over the data points.</p>
<p>In Document Automation, the correct error message is displayed while fetching a Standard Forms model that is missing configuration settings. Previously, an incorrect error message was displayed.</p>
<p>While reconfiguring a table, you can add a table name within the 99 character limit and a table field name within the 154 character limit. Previously, you could add more characters than the default limit of 100 characters and 155 characters, respectively.</p>



Fixes
You can create a new project for Standard Forms in the Linux environment. Previously, the ability to create a project using <b>Create project</b> for Standard Forms was not supported in Linux.
Limitations
Document Automation supports a device username of 17 characters or fewer.
Pattern-based validation is not enabled by default in imported learning instances. You must edit the learning instance and select the <b>Validation</b> option in the Validation rules section.
Bots containing actions from the Document Extraction package do not support the advanced check-out options.
For a public learning instance, if you delete a learning instance and then try to create a new learning instance using that same name, an error is displayed.  Workaround:If you delete a learning instance as well as the learning instance folder, then you can create a new learning instance using the same name.
When you create a learning instance with <b>Google Document AI</b> , an <b>UNKNOWN</b> option is displayed under the <b>OCR Engine</b> filter in the <b>Document Workspace</b> dashboard.
If you apply a filter that includes <b>User Name</b> , <b>Status</b> , or <b>OCR Engine</b> , the <b>Accuracy% by field</b> widget does not show the correct results.
If you submit a document that contains a validation error due to a regular expression, the page keeps loading and you must refresh the page to continue. You cannot submit a document that has a pattern validation rule with a regular expression that contains pipe symbol ( ).  For example, the following expression has ( ) characters and will show an error: (^0[1-9] [12][0-9] 3[01])-(0[1-9] 1[0-2])-(\d{4}\$)  However, you can edit the regular expression in the learning instance and reprocess the document to continue with validation.
As of Automation 360 v.28, document extraction fails via proxy in the bring your own key (BYOK) use case.
If you process a document by uploading it through the default or customized process instead of processing it through Document Automation learning instances, then <b>Download CSV</b> remains in the <b>In progress</b> state during validation.  Workaround:You must update the <b>Download Bot</b> task bot by unchecking <b>Delete files associated to this document from the server after downloading</b> .
For Document Automation, the license consumption is not tracked on a fresh cluster Linux environment.

## IQ Bot

Fixes
<p>If you test an invalid Python script when configuring custom logic, the system displays an error message without any file path. Previously, the error message included the execution file path.</p>
<p>When you upload high-resolution or invalid documents to a custom group, if the document is not processed, it is either moved to the validator folder or the fail folder. You can eventually download the files from the fail or invalid folder.</p> <p>Previously, the validator or the fail folder did not receive the uploaded files. You had to transition the learning instance from production to staging and back again to move the file to the output folder.</p> <p>Service Cloud case ID: 01926196</p>
<p>The ability to create or edit a bot for a manual group has been fixed. You can now create a bot with a manual group that has invalid or corrupted documents. You can also move the created bot from staging to production and back again.</p> <p>Previously, after creating a manual group for a learning instance with an invalid or corrupted document, you were unable to create a bot.</p> <p>Service Cloud case ID: 01878143</p>

Limitations
<p>If the IQ Bot archive (IQBA) file size is above 268 MB, then the file storage does not upload the exported file from the output folder to the desired location. You should restart the <b>Project Services</b> from <b>IQ Bot Services</b> if the system is stuck and you are unable to perform any actions.</p>
<p>If IQ Bot Cloud is configured with a proxy server, learning instances cannot access Google Vision API or Microsoft Azure Computer Vision OCR engine.</p>
<p>The maximum upload file size limit is set to 2 GB when importing and exporting files in the IQ Bot archive (IQBA) file. If the file size is greater than 2 GB, then you must delete unwanted groups to decrease the file size and migrate successfully. Earlier, maximum upload file size limit was 5 GB.</p>
<p>When you change from full screen mode to small screen mode in the <b>Logic</b> window, the Python scripts and these options are hidden: <b>Test Run</b>, <b>Clear Box</b>, <b>Fullscreen</b>, and <b>Save</b>.</p> <p>Workaround:</p> <ol style="list-style-type: none"> <li>1. Click <b>Logic</b> to minimize the window</li> <li>2. Click <b>Logic</b> to expand the window and view the Python scripts.</li> <li>3. Place a cursor inside the Python script screen and click Enter.</li> </ol>
<p>For an existing Community Edition user, the <b>Help</b> icon is not available on IQ Bot interface.</p>

**Limitations**

If you are an Automation Anywhere free trial version user and you upgrade to Automation 360 v.28, the Community Edition logo displays on the homepage. However, the functionality is not impacted.

The size of the toggle icon for **Set to production** is not consistent with all the other icons displayed on the learning instance details page.

## Updates to the interface

Review the updates to the interface made to the interface for Automation 360 v.28 release.

**IQ Bot and Document Automation**

The new Google Document AI features include an improved validation feedback for new and existing learning instances and supports additional languages.

**Create Learning Instance** Cancel Next

Name  
Test

Description (optional)  
Demo test scenario

Document Type  
Invoices

Language  
English

Locale  
English (United States)

Provider  
Google Document AI  
Google Document AI can extract documents in other languages besides the language you selected above.

Improve accuracy using validation  
The system learns from user-provided changes in the Validator.

[Improvements to Google Document AI](#)

### IQ Bot and Document Automation

You can configure your learning instances to convert extracted dates and numbers to a standard format.

Cancel
Update

**Field name**

**Field label**

**Confidence (0-100)**

+ -

**Format Date** ⓘ

Updates the appearance of extracted dates b

**Data type**

▼

Text

Number

Date

Address

**Required**

Required

Optional

**Default aliases (read-only)**

invoice date	invoice date:	inv date
inv date:	inv. date	inv. date:

Standardize the format of extracted numbers and dates

## Bot Insight v.28 release

Review what's new and changed, and the fixes and limitations in Bot Insight for the v.28 release.

### What's new

Enhanced Bot Insight filters and widget setting for Document Workspace dashboard

In a Document Workspace dashboard, you can use the custom dashboard filters to build custom widgets. Additionally, you can edit the widget settings for an effective data visualization.

[Document Workspace dashboard](#) on page 3937 | [Edit widget settings](#) on page 3939

## What's changed

RBAC applied to `/data/api/gettasklogdata` and `/data/api/gettaskvariableprofile` APIs to secure business data (Service Cloud case ID: 01870469)

Role-based access control (RBAC) is applied to the `/data/api/gettasklogdata` and `/data/api/gettaskvariableprofile` APIs to access the Business dashboard data. With this role restriction, you cannot access the business data using the `/data/api/gettasklogdata` and `/data/api/gettaskvariableprofile` APIs when you do not have access to the folders.

## Fixes

For Bot Insight business analytics reporting, you can use the Bot Insight APIs to export all the available data records from the Operations Bots dashboard's **DataTable** widget. Previously, you could export a maximum of 100 records at a time from the Operations Bots dashboard's **DataTable** widget.

Service Cloud case ID: 00760252, 01819244, 01857905, 01945720

Bot Insight Operations dashboard (which includes links to the Audit, Bots, and Device dashboards) now retrieves and shows the complete volume count for a bot run.

Previously, due to a maximum volume count limit in KPI charts, the Bot Insight Operations dashboard could not retrieve the complete volume count. Additionally, a maximum count of 10,000 was shown as the total bot run in the Bots dashboard which led to incorrect results.

Service Cloud case ID: 01825287

A user with the **AAE\_Bot Insight Consumer** role can only view a published analyze dashboard. The **Delete** dashboard action is greyed out and no longer available.

Previously, the **Delete** action was available and when the user tried to delete a dashboard, an error message was displayed preventing the user from deleting the dashboard.

Service Cloud case ID: 01870477

## Limitations

In the Bots dashboard, the **Total Bot Runs** count does not match what the total count should be when the **Total Completed (Success)**, **Total in Progress**, and **Total Failed** counts are added together.

## Automation 360 v.27 Release Notes

Release date: 11 January 2023

Review the top five features in this release and view other new features and exciting enhancements for Automation 360 v.27 release.

- Build 16701: Automation 360 (Cloud and Cloud Sandbox) and IQ Bot (Cloud)
- Build 16685: Automation 360 (On-Premises) and IQ Bot (On-Premises)

We have released updated builds for fixes after the Automation 360 v.27 GA build, which was Build 16667. For information about the fixes in these updated builds, see [Updated release builds](#) on page 183.

### Highlights of this release

Here are the top 5 features in the v.27 release:

Embedded smart forms and dynamic data mapping for embedded widgets

Faster design and use of your embedded automation: You can now design your forms using a responsive and real-time canvas that automatically adjusts to the desired form size. This feature provides a faster way to create embedded interfaces that interact with any web applications. You can also configure these forms in your business applications, such as Workday or ServiceNow, to securely retrieve data when embedded as an iFrame widget.

Eliminate data re-entry and save time: Use our new PostMessage API to map and prepopulate data from business applications in embedded widgets. Dynamic data mapping provides safe and secure communication of data from your business (host) applications to initial process forms in the widget.

See [Smart embedded forms and dynamic data mapping](#) on page 3315.

Enhanced citizen developer experience

Our updated and intuitive icons enable citizen developers to quickly select actions and use the Help for contextual information about actions, providing a more seamless development of automations. We have also enhanced the AISense Recorder user experience so that you can use anchors easily and automate UI objects that are not detected by the recorder automatically.

See [AISense recorder enhancements](#).

Strengthen governance and management

Notifications: Our new notifications capability provides a centralized, consistent, and proactive medium for users to stay informed on their automation estate and to take actions based on the events they are alerted on. Alerts on various platform events, bot events, and other automation lifecycle events are delivered via in-app (default) and email (based on user preference).

See [Notifications](#) on page 2194.

Automatically pick available Bot Runner users: Scale your automations easily by selecting all the Bot Runner users that can run a given automation and the number of Bot Runners to use. This capability ensures that when you run or schedule an automation, the system automatically picks the available run-as users from the specified list.

Standard forms

Standard forms is now integrated in Document Automation with the other document processing capabilities. With enhanced accuracy, this feature enables you to extract data from densely structured forms including those with handwritten input. Use cases for structured documents include tax forms, mortgages, vehicle registration address, and so on.

See [Create custom models in Document Automation using Standard Forms](#) on page 3693.

PEG enhancements

We continue to improve our Privacy Enhanced Gateway (PEG) for sensitive information redaction with a new configuration UI so you can easily change the configurations in the UI instead of the command line. We have also recently released a new PEG serverless architecture for higher-scale data collection use cases.

See [Configure PEG image redaction](#) on page 3867.

## Updated release builds

We have released the following updated builds:

- Build 16701 Service Cloud case ID: 01829572, 01947340, 01949323, 01950696, 01944637, 01951100,01953055, 01950639, 01951722, 01949415, 01949033, 01949372

- Fix for bots that were failing when all of these conditions were met:
  - Bot contained more than 2,000 steps
  - Bot had one or more nested actions (such as IF or loop)
  - At least one of the nested actions contained more than 250 steps
- Fix for inconsistencies that were observed on the **In-progress activity** page.
- Fix for bots that were failing because of file dependency or interactive form that included multibyte characters in file names.
- Changes to Automation Co-Pilot on the desktop Assistant to manage and clear automations with start, stop, and resume actions.
- Build 16685 (for US West, Canada, and Japan regions only) Service Cloud case ID: 01947340  
This updated build includes a fix for this issue: If a bot has a file dependency and the file name contains multibyte characters, then when the Bot Agent downloads the file, the download will fail during run time causing the bot to fail as well.

## What's new and changed in each product

Navigate to the following pages for details on all the updates (what's new, changed, fixed, and limitations) in each product:

[Automation Workspace v.27 release](#) on page 185

- [Updating to v.27 release](#) on page 214
- [Packages updated in v.27](#) on page 215
- [Migration updates for v.27 release](#) on page 227

[Process Discovery v.27 release](#) on page 236

[Automation Co-Pilot for Business Users v.27 release](#) on page 237

[IQ Bot and Document Automation v.27 release](#) on page 246

[Bot Insight v.27 release](#) on page 253

Related reference

[Automation Workspace v.27 release](#) on page 185

Review what's new and changed, and the fixes and limitations in Automation Workspace for the v.27 release.

[Process Discovery v.27 release](#) on page 236

Review what's new in Process Discovery for the v.27 release.

[Automation Co-Pilot for Business Users v.27 release](#) on page 237

Review what's new and changed, and the fixes and limitations in Automation Co-Pilot for the v.27 release.

[IQ Bot and Document Automation v.27 release](#) on page 246

Review what's new and changed, and the fixes and limitations in IQ Bot and Document Automation for the v.27 release.

[Bot Insight v.27 release](#) on page 253



Review the fixes in Bot Insight for the v.27 release.

[Packages updated in v.27](#) on page 215

Review updates to the packages in Automation 360 v.27, including the compatible Control Room and Bot Agent versions.

[Browser extensions for Automation 360](#) on page 985

Create automation from supported browsers by using browser extensions. Extensions are periodically updated to support feature enhancements and fixes. Therefore, ensure that you have the latest versions of extensions for the Google Chrome, Microsoft Edge, and Mozilla Firefox browsers.

## Automation Workspace v.27 release

Review what's new and changed, and the fixes and limitations in Automation Workspace for the v.27 release.

### What's new

Control Room, devices, and Bot Agent
<p>Windows 365 Cloud PC now supported as Bot Runner (Service Cloud case ID: 01792699)</p> <p>We support Windows 365 Cloud PC as a Bot Runner to create and run bots on Windows 365 Cloud PC.</p> <p><a href="#">Bot Runner device requirements</a> on page 1167</p>
<p>Oracle Database is now supported on Linux (Service Cloud case ID: 00726728)</p> <p>We now support Control Room with Oracle Database on Linux, so you can now choose to install the Control Room with Oracle Database on Linux.</p> <p><a href="#">Installing Control Room on Linux</a> on page 1293   <a href="#">Database requirements</a> on page 1188</p>
<p>Microsoft Edge offline extension is supported (Service Cloud case ID: 01829649, 01880289)</p> <p>You can now install the Microsoft Edge offline extension for Microsoft Edge Enterprise browser users even when the device is offline.</p> <p>When the Bot Runner machines do not have Internet connectivity, you can use these features with the Microsoft Edge offline extension:</p> <ul style="list-style-type: none"> <li>• Automation of web apps</li> <li>• User interface triggers</li> <li>• Device registration</li> </ul> <p>The Microsoft Edge offline extension is transparent and works similarly to the Microsoft Edge online extension for users.</p> <p><a href="#">Install Bot Agent and register device</a> on page 1347   <a href="#">Browser extensions for Automation 360</a> on page 985</p>

<b>Control Room, devices, and Bot Agent</b>
<p>Centralized notifications repository for various events and capability updates</p> <p>You can now track all the platform and automation events through a centralized repository. With this feature, you can identify the severity of events, consider possible actions based on the severity of events, and then take appropriate actions. You can also be notified about platform updates, such as bot export and package updates. Thus, it improves platform and user productivity.</p> <p><a href="#">Notifications</a> on page 2194</p>
<p>Automatically select the number of Bot Runners (Service Cloud case ID: 00821020, 00715598, 00723191, 00784822, 01830238, 01870817)</p> <p>You can enable Automation 360 to automatically select the Bot Runner users for specific tasks to:</p> <ul style="list-style-type: none"> <li>• Scale automations easily</li> <li>• Run bots concurrently</li> <li>• Use resources efficiently</li> </ul> <p>This capability ensures that when you run or schedule an automation, the system automatically picks the available run-as users from the specified list.</p> <p><a href="#">Automatically select the number of Bot Runners users</a> on page 2138   <a href="#">Schedule a bot</a> on page 2129</p>
<p>Manage domain accounts using gMSA (Service Cloud case ID: 00731119)</p> <p>You can use a group Managed Service Account (gMSA) to manage and run Control Room and other Automation 360 services.</p> <p><a href="#">Configure service credentials</a> on page 1251</p>
<p>View keyboard shortcuts in Bot editor</p> <p>In Bot editor, you can now open a menu to view the available keyboard shortcuts.</p> <p><a href="#">Keyboard shortcuts list</a> on page 2235</p>
<p>Validate device credentials prior to bot deployment</p> <p>Prior to bot deployment, you can select to validate the device credentials for Bot Creator, attended Bot Runner, Citizen Developer, and unattended Bot Runner users. This provides users additional security for bot deployment.</p> <p><a href="#">Switch device registration between Control Room instances</a> on page 1807</p>
<p>Export roles to view users and their permissions (Service Cloud case ID: 01804955)</p> <p>You can export selected roles and their permissions to CSV files to view the following information:</p> <ul style="list-style-type: none"> <li>• User information</li> <li>• Run-as user information</li> <li>• User permissions</li> <li>• Folder permissions</li> </ul> <p><a href="#">Export roles</a> on page 1774</p>

Control Room, devices, and Bot Agent
<p>TLS 1.3 encryption support for a more secure connection to Control Room services (Service Cloud case ID: 00549240, 00606859, 01925085)</p> <p>Automation 360 On-Premises supports both TLS 1.3 and TLS 1.2 cryptographic protocols for HTTPS and TCP communications between our components.</p> <p><a href="#">Support for secure protocols</a> on page 1045   <a href="#">Configure application Transport Layer Security</a> on page 1249</p>
<p>Enhanced Automation Anywhere Debugger tool</p> <p>The Automation Anywhere Debugger tool is available in the <b>Bot Assistant</b> utility to provide a better user experience. When you invoke the Debugger tool from the Bot editor, you can add, update, or delete actions and variables in a bot.</p> <p>By default, the <b>Watched variables</b> lists is empty. With a single click, you can add all the used variables in a bot. These variables display in a pop-up window where you can select or deselect, one or more variables, from the list.</p> <p><a href="#">Debugger tool</a></p>
<p>Google Chrome and Microsoft Edge certification for operating systems</p> <p>Google Chrome and Microsoft Edge extensions are certified for the following operating systems:</p> <ul style="list-style-type: none"> <li>• Microsoft Windows Server 2012 Standard R2</li> <li>• Microsoft Windows Server 2016</li> <li>• Microsoft Windows Server 2019</li> </ul>
Packages, actions, and Bot editor
<p>Notification for package updates</p> <p>When you add or update a package or upload a custom package to the Control Room, you are now notified about this platform event. This notification is displayed to all the Control Room users through the <b>Notifications</b> repository.</p> <p><a href="#">Capabilities supporting notifications</a> on page 2208   <a href="#">Add packages to the Control Room</a> on page 1908   <a href="#">Add custom package to your Control Room</a> on page 3582   <a href="#">Upload custom package to your Control Room</a> on page 3519</p>
<p>ServiceNow package</p> <p>You can use the ServiceNow package from Automation 360 to authenticate and perform several actions with records and attachments in ServiceNow tables.</p> <p><a href="#">ServiceNow package</a> on page 3018</p>
<p>ServiceNow triggers</p> <p>You can use ServiceNow triggers to call an action when there is a new or updated record.</p> <p><a href="#">ServiceNow New Record trigger</a> on page 2299</p>

Packages, actions, and Bot editor
<p>Cut, copy, paste keyboard shortcuts added for TN3270 and TN5250 Terminal Emulator</p> <p>In the Terminal Emulator package, the following keyboard shortcuts are now available specifically for TN3270 and TN5250:</p> <ul style="list-style-type: none"> <li>• Shift + Control + A = Select all</li> <li>• Shift + Control + C = Copy</li> <li>• Shift + Control + X = Cut</li> <li>• Shift + Control + V = Paste</li> </ul> <p><a href="#">Using Send text action on page 3129</a></p>
<p>Quick assistance at hand for the developers in the Bot editor</p> <p>The accessibility and usability of the Bot editor, actions, and packages have been improved. As a citizen developer or an RPA developer, when you are creating bots, you can quickly look up information about the actions without navigating outside the Bot editor. Under the <b>Actions</b> pane, quick help is enabled with contextual information about actions. Additionally, an icon is configured with a link to the documentation. If you want more information about an action, you can click the link, which redirects you to the relevant page in the documentation portal. This feature is currently available in the following actions and packages.</p> <ul style="list-style-type: none"> <li>• Database</li> <li>• Email</li> </ul>
<p>Enhanced user experience through refreshed and intuitive icons</p> <p>With the new and intuitive icons for actions in the Bot editor, citizen developers and RPA developers can quickly locate the correct action while creating automation for a day-to-day task. These unique and renewed icons are developed according to brand and global standards.</p>
<p>Seamless package updates</p> <p>When a package version is added to the Control Room, either from a Cloud download or Control Room upgrade, as an administrator, you have the flexibility to disable the new version of packages. This feature helps you to restrict users from using the new package version until it is verified.</p> <p><a href="#">Updating packages in Control Room on page 1905</a>   <a href="#">Automatic package updates for On-Premises Control Room on page 1906</a>   <a href="#">Automatic package updates for Cloud Control Room on page 1907</a></p>
<p>New option in Read from action of Database package (Service Cloud case ID: 01263940)</p> <p>A new check box is available when you use the <b>Read from</b> action to retrieve records from the database and save the retrieved data in a CSV file. When you select this check box, no CSV file is created if the executed SQL query does not return any data.</p>
<p>Proxy support for EWS-OAuth2 (Service Cloud case ID: 00771400, 01574715, 01815888)</p> <p>When you create a bot with the Email package that uses EWS OAuth2 for authentication and the Bot Runner machine is configured behind the firewall, then all outbound requests are routed through the proxy server configured on the Bot Runner machine.</p>

**Packages, actions, and Bot editor**

64-bit ODBC driver now supported in Database package (Service Cloud case ID: 01256142, 01829360, 01849908)

We now support connecting to databases by using the 64-bit ODBC driver. This option is available when the connection mode is the default. Organizations transitioning to Microsoft 365 will benefit from leveraging this enhancement and can sustain automation build with 32-bit ODBC drivers.

[Using Connect action for database](#) on page 2469

OAuth 2.0 support in Email and Email trigger packages (Service Cloud case ID: 01798311, 01803702, 01791859, 01828526)

Microsoft is deprecating the ability to use Basic authentication in Exchange Online for these specific protocols:

- IMAP
- POP3
- EWS

We support OAuth 2.0 authentication for these protocols in the Email and Email trigger packages. For enhanced security, you can maintain the business continuity of your email automations by switching the authentication type from Basic to OAuth 2.0, (as recommended by Microsoft).

[Using Connect action in Email package](#) on page 2523

Retry mechanism supported in credential variables (Service Cloud case ID: 01786319, 01887182)

The credential variables support the retry mechanism. When you create a bot that uses credential variables, if the bot fails during run time to retrieve those variables from the Credential Vault because the Control Room is disconnected or the Control Room services stop intermittently, then the bot tries three times to retrieve the credential variables from the Credential Vault.

**Note:** Ensure that the Bot Agent version installed on your system is the version that is released with Automation 360 v.27.

**Packages, actions, and Bot editor**

Support of other domain name in the Active Directory package (Service Cloud case ID: 01807358, 01910765)

We now support Active Directory user operations by logon name with domain and can provide the domain name to extract user details. When you retrieve the user property or perform any user operation based on the logon name (userPrincipalName), and if the user domain name differs from the domain specified in the LDAP path, the user properties are now successfully retrieved with or without a domain name.

For example, LDAP Path: LDAP://ADServer/DC=automation, DC=net

User	Logon name
userPrincipalName: kim@aaengg.net	User can provide logon name as kim@aaengg.net.
userPrincipalName: shaun@aasales.net	User can provide logon name as shaun@aasales.net.
userPrincipalName:sarah@automation.net	user can provide a logon name as either sarah or sarah@automation.net.

The following list of actions supports logon name with domain.

- Update user details
- Rename user
- Delete user
- Enable user account
- Disable user account
- Set user property
- Get user property

[User account operations](#) on page 2384

Shared mailbox support for Email automation (Service Cloud case ID: 00797231, 01816574, 01829499, 01854615, 01871861, 01933058, 01834152, 01829684, 01853949, 01880386, 01869636, 01894591, 01867553, 01911371. 01925438)

The Email package supports the email automation of a shared mailbox in Outlook for Office 365/Microsoft 365 using IMAP/EWS protocols, and OAuth 2.0 authentication using Client Credentials and Authorization Code with PKCE grant flows. You can automate emails retrieved from a shared mailbox and perform all email-related tasks by accessing each folder(s) and its subfolder(s) in the shared mailbox.

Packages, actions, and Bot editor
<p>New action in Text file package</p> <p>You can use the new <b>Read variables</b> action in the Text file package to read the values of variables from the text file.</p> <hr/> <p><b>Note:</b> The <b>Import string from text file</b> action in the String package has been deprecated and will not be available for new bots. We recommend that you use the new <b>Read variables</b> action with enhanced capabilities. This deprecation does not impact any existing bots or bots which were migrated previously and they will continue to run properly. See <a href="#">Support and deprecation policy for packages</a> on page 1079 for package lifecycle and deprecation policy.</p> <hr/> <p><a href="#">Read variables action</a> on page 3135</p>
<p>Call an existing JavaScript function in a webpage</p> <p>You can use the new <b>Call a JavaScript function</b> action in the Browser package to call an existing JavaScript function directly in a webpage or in an iFrame within a webpage in Google Chrome and Chromium-based Microsoft Edge browsers. In the bot, you can also pass one or more input parameters to the JavaScript function and process the return value from the function.</p> <p><a href="#">Call a JavaScript function action</a> on page 2436</p>
<p>Automate controls using Microsoft UI Automation (COM) technology</p> <p>You can use the Microsoft UI Automation (COM) technology to automate the following scenarios:</p> <ul style="list-style-type: none"> <li>• Capture and automate client controls</li> <li>• Capture and automate password text controls</li> <li>• Capture and automate page tab controls</li> </ul> <p><a href="#">Actions performed on objects captured with Universal Recorder</a> on page 2923   <a href="#">Capture using specific technology</a> on page 2948</p>
<p>Capture objects on applications running in administrator mode</p> <p>You can use the Recorder to capture objects on applications running in administrator mode. To capture the object, select the <b>Capture and run with admin privileges</b> option from the Bot editor.</p> <p><a href="#">Recorder package</a> on page 2916</p>
<p>Enhanced bot performance when using global values across bots</p> <p>When you use global values across a parent bot and a child bot, the bot performance is enhanced by reducing the bot execution time. To enable enhanced bot performance, you must set the <b>Bot compatibility version</b> to <b>3</b> in the <b>Advanced settings</b> page of the Bot editor.</p> <hr/> <p><b>Note:</b> Ensure that the Bot Agent version installed on your system is the version that is released with Automation 360 v.27.</p> <hr/> <p><a href="#">Bot compatibility version</a> on page 2322</p>

**Packages, actions, and Bot editor**

Enhanced user interface for Define functionality in AISense Recorder

- We have enhanced the user interface of **Define** window in the AISense Recorder that enables you to use anchors easily and automate UI objects that are not detected by AISense Recorder automatically. To improve functional clarity, the following object types are renamed:
  - **Active text** is renamed to **Link**
  - **Passive text** is renamed to **Text value**
- If you unintentionally click the screen or click before the highlighter appears, the AISense Recorder provides visibility into it. You must confirm to capture the object again or use the **Define** functionality to define the object on the screen.
- In the **Define** window, the AISense Recorder shows embedded help for each of the control types so you can select the correct control types for custom objects.

[Use variable anchor](#) on page 2273 | [Capture Textbox, Radio, Checkbox, and Combobox](#) on page 2268 | [Capture text value through AISense Recorder](#) on page 2267 | [Capture link button through AISense Recorder](#) on page 2266 | [Capture Image button through AISense Recorder](#) on page 2264

New virtual key added to the Simulate keystrokes package

In the **Simulate Keystrokes > Keystrokes** action, a new key named **Return** has been added to the virtual keyboard for Enter functionality and the Enter key in the Number pad has been renamed to **Num Enter**. As a result, the **Return** key is the main Enter key on the keyboard. This enhancement keeps the keyboard in sync with the physical keyboard. The nomenclature has been changed to avoid confusion between the Enter key on the keyboard and the Enter key on the Number pad.

Support for global variable for all Datetime actions

In the Datetime package, you can use the Datetime global variable across all **Datetime** actions. You can select to use either **String** variable or a **Global** variable in the **Source date and time variable** option. This avoids creating multiple local variables and reduces the total number of actions used in a bot.

[Datetime package](#) on page 2484

The resiliency of the File/Folder trigger has been improved to continue listening after a network disruption has occurred. Previously, a network error caused the trigger to lose connection with the Bot Agent.

Service Cloud case ID: 01769532, 01773584, 01834098, 01867418

---

**Important:** For information about the supported packages for this release, see [Packages updated in v.27](#) on page 215.

---



Building and running bots
<p>Notification for bot export</p> <p>When you export a bot in the Control Room, you are now informed through the <b>Notifications</b> repository. This notification is sent only to the user who exported the bot.</p> <p><a href="#">Capabilities supporting notifications</a> on page 2208   <a href="#">Export bots</a> on page 2033</p>
<p>Code analysis runs automatically for all unscanned bots in public workspace</p> <p>Code analysis now runs automatically on all the bots with the <b>Not Scanned</b> status in the public workspace. This ensures visibility on the coding best practices for policies configured in the Control Room and will show the results of code analysis for all the bots in the public workspace without the need to run code analysis on each bot one by one.</p>
<p>Check out multiple bots and files (Service Cloud case ID: 00628344, 00822352)</p> <p>You can now select multiple bots and their dependent files from different folders that belong to the same process and check them out from the public to the private workspace. You can check out a maximum of 10 parent bots, but there is no limitation on the number of dependent child bots.</p> <p><a href="#">Check out multiple bots</a> on page 2306</p>
<p>Choose specific version of non-bot dependency to check out with parent bot</p> <p>When you check out a parent bot, you can now choose the version of a non-bot file dependency to check out. Every version of a parent bot can have different versions of non-bot file dependencies.</p> <p>With this feature, you can roll back the dependencies while rolling back the parent bot. You can make changes to a specific version of the dependent non-bot file.</p> <p><a href="#">Check out non-bot file dependencies</a> on page 2362</p>
<p>Compare bot version in private workspace (Service Cloud case ID: 01761840, 01771389, 01763432, 01904500, 00798356, 01780116)</p> <p>You can now see the changes made to your bot logic in the private workspace before checking in your bot. As a Bot Creator, it was difficult to identify the changes made to the bot logic, input, and output parameters. With this functionality, you can now easily identify where you have made the modifications to the bot logic, variables, triggers, dependencies, and packages compared to the latest version or any other previous version of the bot.</p> <p><a href="#">Compare bot versions</a> on page 2313</p>
<p>Edit non-empty folder description in public workspace (Service Cloud case ID: 01820406)</p> <p>You can edit the description of non-empty folders in the public workspace. Meaningful descriptions provide more insight of the bots contained in that folder. This feature enables an administrator or a user with rename folder permissions to better manage the repository when it contains many folders.</p> <p><a href="#">Create and rename folders</a> on page 2325</p>

**Building and running bots**

Specify queue running times in workload automations (Service Cloud case ID: 01816260, 00331357, 01924895, 01274769)

You can set the specific time period when to run a workload automation. When creating the workload automation, you can set the queue running days and time to ensure that the automation does not run during these scenarios:

- Applications are not available
- During scheduled upgrades
- Non-working days (holidays, weekends)

[Run bot with queue](#) on page 2006

Check for duplicates when adding work items (Service Cloud case ID: 00825850, 01792046, 01806516)

You can check for duplicate work items before adding them to the queue. This feature prevents re-processing the same work items multiple times, thus saving time and resources. You can either move the work items marked as duplicate for re-processing or discard them.

[Insert Work Items](#) on page 2004

Generation of API Key is audited

The generation of the API key is now audited and will display the expiry time of the api-key in the audit logs.

**APIs and integrations**

Workato Integration

You can integrate the Automation 360 platform and Workato by using the Automation Anywhere connector. You can establish a connection with the Automation Anywhere Control Room and perform various operations using the Control Room APIs.

[Workato integration](#)

SnapLogic Integration

You can now integrate the Automation 360 platform and SnapLogic. You can establish a connection with the Automation Anywhere Control Room and perform various operations by using the Control Room APIs.

[Snaplogic integration](#)

**RPA Bots for Salesforce**

Now when creating new connections, you have the option to include an API Gateway certificate.

## What's changed

Control Room, devices, and Bot Agent
<p>Automated reprocessing of failed WLM work items (Service Cloud case ID: 00825872)</p> <p>When you create or edit a queue, you can now use the <b>Max auto retry attempt</b> option to ensure that failed WLM work items are reprocessed automatically. With this option, you can specify the number of times for which the automatic reprocessing of failed work items will be attempted.</p> <p>Automatic reprocessing of failed work items is attempted after all the work items in a queue are processed.</p>
<p>Better device management with improved device permissions (Service Cloud case ID: 01264963, 01871530)</p> <p>You can now view and manage Bot Agent devices even if you have not registered them by using the enhanced <b>Edit the device(s)</b> permission. The <b>Edit the device(s)</b> permission is improved as follows:</p> <ul style="list-style-type: none"> <li>• <b>Device(s) from my device pools:</b> To edit devices from device pools</li> <li>• <b>Run as users default device(s):</b> To edit Run as user(s) default device</li> </ul> <p>The Control Room administrator grants you access to a specific set of devices based on your role. When the <b>Edit the device(s)</b> permission with the <b>Device(s) from my device pools</b> and <b>Run as users default device(s)</b> options is selected, you can view and manage all (registered and non-registered) devices from a specific accessible group.</p>
<p>Enhanced bot Compare versions page</p> <p>The bot <b>Compare versions</b> page shows changes in the dependencies between two versions of the bot. It shows changes for the first level of dependencies only and displays those dependencies sorted in alphabetical order.</p>
<p>Specify time period to put work item on hold (Service Cloud case ID: 00825875)</p> <p>You can put a work item on hold for a specific date and time. This ensures that the work item moves automatically to processing (new state) on the specified date and time and no longer requires you to manually move it for re-processing. A new column in the <b>Edit queue</b> page displays the hold status of the work item, either date and time or indefinite if you do not specify the date and time.</p> <p><a href="#">Edit queues</a> on page 2013</p>
Packages, actions, and Bot editor
<p>Control Room version compatibility check with specific packages</p> <p>When you manually upload a package or a bot in the Control Room, the system now checks if the specific packages used in the bot are compatible with the Control Room version.</p>

**Packages, actions, and Bot editor**

Analyze button renamed in Bot editor

The analyze button of Bot Insight (**Analyze Task Bot**) has been renamed to **Bot Insight "Analyze" dashboard** in the Bot editor page.

**Fixes**

Build 16701: This build includes the following fixes (along with fixes from the previous builds):

Fix for inconsistencies that were observed on the **In-progress activity** page.

Service Cloud case ID: 01949323, 01950696, 01944637, 01951100, 01953055, 01950639, 01951722, 01929156, 01954486, 01954920

Build 16694: This build includes the following fixes (along with fixes from the previous builds):

If the **Manage my activity** feature is enabled for a user role, then the user can view the pause, resume, and stop status on the **In progress activity** page. If this feature is disabled, then the user cannot view these statuses.

Previously, users were able to view these statuses even when the feature was disabled.

Service Cloud case ID: 01937106

Build 16667: This build includes the following fixes:

When synching with the Active Directory (AD), the user mapping no longer overwrites the **Description** field in the Control Room with blanks.

The Automation 360 Control Room no longer generates an error in the User Management log when a mapped security group has no members.

The **In progress activity** page no longer shows bots after they are run.

Previously, the page incorrectly showed bots in the active state even after execution.

Service Cloud case ID:

01914651, 01924866, 01923265, 01928088, 1918956, 01922321, 01931985, 01921849, 01938985, 01939812, 01940084, 01940585, 01940258, 01938868, 01934451, 01940222, 01941187, 01940900, 01941742, 01939639, 01941503, 01941496, 01939639, 01942720, 01942430, 01943379, 01943617, 01938885

When a user is assigned an admin role to create schedules and later the admin access is removed for that user, an audit log will be logged when the schedule is canceled because of the user not having the admin privileges.

Previously, when such schedules were canceled, no audit logs were logged indicating that the schedule was canceled because the user did not have the required privileges.

Service Cloud case ID: 01830359

<p>The <b>Administration &gt; Licenses</b> page and the Control Room banner displayed on the same licenses page now display correct information about license expiry.</p> <p>Previously, the correct information about license expiry was not displayed.</p> <p>Service Cloud case ID: 01807324</p>
<p>When you edit a role, the <b>Edit role</b> audit log page now displays the correct old, new, and run-as user values.</p> <p>Previously, these values were not displayed.</p> <p>Service Cloud case ID: 01759116</p>
<p>When you edit your first or last name on the <b>My profile</b> page, the description and auto login values on the <b>Edit user</b> audit log page will not be updated.</p> <p>Service Cloud case ID: 01846878</p>
<p>You can correctly filter the status for activities on the <b>Activity &gt; Historical</b> page.</p> <p>Previously, some filters were not displaying the correct status for activities.</p> <p>Service Cloud case ID: 01869361, 01875216</p>
<p>Users without permission cannot view the activities of other users on the <b>In progress activity</b> page.</p> <p>Previously, some users were able to view the activities of other users even though they did not have permission.</p> <p>Service Cloud case ID: 01911289, 01910582</p>
<p>If you configured the log collection level as <b>Debug</b>, the logs collected from some packages do not include customer data.</p> <p>Previously, the logs collected from some packages included customer data.</p> <p>Service Cloud case ID: 01862053, 01870001</p>
<p>If the CPU utilization and device memory threshold values are outside the percentage range defined by the Control Room administrator in the <b>Administration &gt; Settings &gt; Devices &gt; Threshold settings for multi-user devices</b>, a clear error message now indicates the device unavailability and provides an appropriate action.</p> <p>Previously, when the CPU utilization and device memory thresholds values exceeded the defined value, bot deployment failed with an unknown error message.</p>
<p>Device shows an accurate status when the Bot Agent is disconnected from the Control Room.</p> <p>Previously, due to the default time (15 minutes) of the WebSocket connection, a device was shown as connected even when the Bot Agent was disconnected from the Control Room.</p> <p>Service Cloud case ID: 01843990</p>
<p>In the Oracle Database environment, a checked-in bot is now automatically refreshed and can be viewed in the <b>Public</b> folder.</p> <p>Previously, to view a checked-in bot in the <b>Public</b> folder, you had to manually refresh the <b>Automation</b> page by using the <b>Refresh</b> button.</p>

<p>When a <b>Stop Task</b> command is used, WLM work items are now marked as completed successfully and show the correct status in the Control Room.</p> <p>Previously, WLM work items were marked as failed even if the bot was executed successfully.</p> <p>Service Cloud case ID: 01841320, 01840748</p>
<p>When you run WLM automations, if the Control Room restarts during deployment, the WLM deployment continues without delay when Control Room services are active.</p> <p>Previously, after the Control Room restarted, there was a delay of 15 minutes before the WLM deployment continued.</p>
<p>When you run a bot by using the Run bot with queue option, the correct value of the work item is now selected, irrespective of the modification source. Previously, when the value of a work item was modified through the API or bot setting, the older value was selected by the bot</p> <p>Service Cloud case ID: 01786785</p>
<p>In an Oracle Database environment, when you select the number format and sort order for the work items in a queue and then run bot by using the <b>Run bot with queue</b> option, the queues are now deployed successfully. Also, the correct log entry is shown in the <b>Audit log</b> or <b>Activity</b> page.</p> <p>Previously, queues were not deployed, and no errors were shown in the <b>Audit log</b> or <b>Activity</b> page.</p>
<p>In a clustered environment, the bot deployment progress is no longer stuck and the Bot Runner device connects to the Control Room successfully.</p> <p>Previously, the bot deployment progress would get stuck sometimes and show an error message <code>Waiting for user: &lt;username&gt; and/or device: &lt;device-name&gt;</code> on the <b>In progress &gt; In progress activity</b> page.</p> <p>Service Cloud case ID: 01830285</p>
<p>When a bot keeps running for a few hours, an error no longer occurs due to high memory usage with the Recorder package version 2.9.2 or later.</p> <p>Previously, an increase in memory usage caused the bot to fail after a few hours with a <code>Java heap space</code> error.</p> <p>Service Cloud case ID: 01911565</p>
<p>When you read emails within a loop using a Microsoft Outlook Client connection with a subject filter, use the <b>Delete</b> action and run the bot, the bot now completes the set iteration and deletes the emails from the specified folder. Additionally, the variable that was used to display the count of total emails versus deleted emails now displays the correct counts in the message box.</p> <p>Service Cloud case ID: 01845642,01857791,01880424</p>

When you establish a connection with the **EWS** server, and emails are read within a loop to filter and move all emails from a subfolder created within the custom folder, the bot now executes without an error.

Previously, an error occurred because the bot could not read the emails from the folders created outside the predefined folder, such as Inbox, Junk, or Draft.

Service Cloud case ID: 01823238

You can now successfully create a bot by using the **Upload file** action from the Microsoft 365 OneDrive package.

Previously, the bot displayed an error when you used the **Upload file** action and if the file name had special characters such as brackets [].

**Note:** Brackets [] are now supported in the file name.

Service Cloud case ID: 01798568

When you choose the variable option to perform a task and during bot creation process you delete the variable you created (Your variables), and when you click the **Add** option in the variable field to insert a variable (such as global variable), the option is now enabled.

Previously, the **Add** option for inserting the variable was disabled.

Service Cloud case ID: 01869139

When you create a bot, you can now use the **Update node** action of the XML package to update the value of a node. Previously, the attributes were removed when you updated the text value of an XML element.

Service Cloud case ID: 01805643

In the Email package, connect to the **EWS** server and use **Loop > For each mail in mail box**. If the source mail is sent on behalf of some other user, for example, user `xyz@aa.com` sent mail on behalf of user `abc@aa.com`, the email dictionary variable `emailFrom` now returns the correct sender ID, which is `abc@aa.com`.

Previously, the email dictionary variable `emailFrom` returned the sender ID as `xyz@aa.com`.

Service Cloud case ID: 01856149

When you run a stored procedure in Oracle and it returns `SYS_REFCURSOR`, the **Run stored procedure** action closes the cursors.

Previously, the **Run stored procedure** action was not closing the cursor after the maximum cursor limit was reached.

Service Cloud case ID: 01842046, 01898572

In the Active Directory package, when you perform a user account operation such as **Add users to group**, **Delete user**, **Disable user account**, or **Rename user**, and if the username has an asterisk (\*), open parenthesis, or close parenthesis, you can now add a user without any error.

Previously, the username did not support the following special characters: asterisk (\*), open parenthesis, and close parentheses.

Service Cloud case ID: 01884962

When you create a folder in Outlook with a percentage (%) in its name (for example, Clients%ClientA), create a bot using the **Connect** action from the Email package and then use the **Folder exists or Folder does not exist** condition, the bot finds the Clients%ClientA and retrieves mail from it.

Previously, the bot was not able to retrieve mails from the folder because percentage (%) was not supported in the folder name.

When you connect to the Microsoft Access Database with JDBC and specify the database path, if you use the following specific aggregation functions in the query, an error is no longer encountered when you run the bot:

```
ASC, ATN, SQR, CBOOL, CCUR, CDATE,
CDBL, CDEC, CDATE, CDBL, CINT, CLONG, CLNG,
CSIGN, CSTR, CVAR, DATEADD, DATEDIFF, DATEPART,
DATESERIAL, DATEVALUE, FORMAT, IIF, INSTR, INSTRREV,
ISDATE, IsNull, ISNUMERIC, LEFT, LEFTS, LEN, MID,
MONTHNAME, DATE, NOW, NZ, SIGN, SPACE, STR, TIME, VAL,
WEEKDAYNAME, WEEKDAY, STRING, TIMESERIAL, CONCAT
```

When using the Task Bot: Run action, you can search dictionary and session variables to use as input parameters. Previously, no results displayed when using this Advanced search feature.

Service Cloud case ID: 01879539

A Task Bot no longer fails when you debug or run it when any **in\_Window** input variable is set.

Previously, in edit mode, when you debugged or ran a Task Bot with an input variable by selecting the **Use as input** check box, the bot failed.

Service Cloud case ID: 01919263

When you use the **Save** action in the Email package, and if the email subject includes a comma (,), the emails are saved successfully.

Previously, if the email subject included a comma (,) and you saved the email, the comma (,) was replaced with an underscore (\_).

Service Cloud case ID: 01786211

When you select the **Package** details page, and select the **Availability** tab, if the package (all users or selected roles) is changed, then the **Package** details page displays the last modified information of the user who made the changes, and the changes made at the access level (all users or selected roles).

You can create bots using the **Download file** action of the Google Drive package.

Previously, when you used the **Download file** action and marked the **Overwrite existing file** option to overwrite the file of the same name, the downloaded file became corrupted. If you then used the **Excel advanced > Open** action to open this file, or manually tried to open the Excel file, an error message displayed indicating that the Excel file was corrupted.

Service Cloud case ID: 01833815



<p>You no longer have an incorrect starting date when you create an event using the Google Calendar package.</p> <p>Previously, when you created an event in Google Calendar and entered the value in the <b>Start Date</b> field with the event type set to <b>All Day</b>, the Google Calendar package decremented the day value by one when you selected the <b>All Day</b> option.</p> <p>Service Cloud case ID: 01815644</p>
<p>When you use the <b>Excel advanced &gt; Open</b> action to open an Excel spreadsheet which did not exist and then run the bot, the bot now displays the correct error message in Japanese.</p> <p>Service Cloud case ID: 01857992, 01925567</p>
<p>You can successfully extract fields from a PDF file when you use the <b>PDF &gt; Extract field</b> or <b>Extract text</b> actions.</p> <p>Service Cloud case ID: 01818304</p>
<p>When you use the 3.6.1-20220428-010115 version of the Simulate keystrokes package to enter keystrokes against specific webpages running in the Microsoft Edge browser with IE mode, the bot processes the keystrokes faster.</p> <p>Service Cloud case ID: 01820418</p>
<p>When you use the <b>PDF &gt; Split document</b> action to split multiple PDFs into various folders and then use the <b>For each file in folder</b> iterator to run the bot in a loop to split each file in the specified folder, the bot no longer encounters an error.</p> <p>Service Cloud case ID: 01803983</p>
<p>When you use the <b>File &gt; Copy Control Room file</b> action and choose the dynamic file path option to select a file from the Control Room repository, the bot no longer encounters an error. Previously, even if the uploaded file was available in the Control Room, the bot failed and displayed this error message: <code>Get Resource failed: Error: Could not find the file at the Control Room path. Check the file path and try again.</code></p> <p>Service Cloud case ID: 01805364</p>
<p>When you use the <b>File &gt; Rename</b> action to rename and overwrite an existing file, the bot no longer shows an incorrect error message. Previously, when you tried to rename an existing file, the bot showed an incorrect file name in the error message.</p> <p>Service Cloud case ID: 01845943, 01858350</p>
<p>You can successfully rename the file and remove an extension from the file name by using the <b>File &gt; Rename</b> action. Previously, when used the <b>Rename</b> action to remove an extension from the file name, the bot trimmed the last character from the file name instead.</p> <p>Service Cloud case ID: 01842995</p>
<p>When you use the Recorder to capture objects on an application that is installed on a virtual machine, finish the recording after the objects are captured, and then relaunch the Recorder, the bot successfully launches the Recorder and no longer inserts any actions that were recorded earlier.</p>

When you use the **Recorder > Capture** action to automate Citrix virtual apps running on Google Chrome and Microsoft Edge browsers, add a delay of 60 seconds and run the bot, then if the object does not exist, the bot waits for the specified time (60 seconds) in the **Keep trying for (seconds)** field before executing the next steps.

When you run the bot using the following sequence of actions, the bot shows accurate data for each loop iteration:

1. Use the **Database > Connect** action to connect to the database
2. Use the **Database > Read** action to read the values from the database
3. Use the **For each row in a SQL query dataset** iterator to run the bot in a loop
4. Use the **Database > Disconnect** action to disconnect from the database and select the **Keep database schema in cache until bot finishes running** option.

Previously, during the second loop iteration, the action picked up data from the previous loop.

Service Cloud case ID: 01817192, 01853717, 01880154, 01940546

An error no longer occurs when you use Recorder package 2.8.6 and later versions to perform a click operation on a link element that opens a pop-up window on a web page running in Microsoft Edge with IE mode.

Service Cloud case ID: 01845776, 01858872, 01923003

When you install the AARemoteAgent\_2.0, the DLL files are now copied to the correct **A360 Remote Agent** folder and the AARemoteAgent\_2.0 runs properly. Previously when you installed the AARemoteAgent\_2.0, the DLL files were copied to an incorrect **A360 Remote Agent\Java** folder.

Service Cloud case ID: 01935630

You can now successfully use the **PDF > Extract field** action to extract values from a PDF that contains a string data type with the dollar sign (\$).

Service Cloud case ID: 01848220

You can now successfully run all migrated web actions of the Legacy Automation package in multiple steps of a bot in Microsoft Edge with IE mode.

Service Cloud case ID: 01853563, 01865846

In the **File > Copy Desktop file** action, when you use a variable that contains a number sign (#) instead of a file path to locate the file that you want to copy, the bot no longer encounters an error.

Service Cloud case ID: 01808009, 01845923

When exporting data to Excel CSV files, Boolean values return accurately. Previously, a bug caused values to return as -1 while using OLE DB Driver for SQL Server (version 18 or later).

Service Cloud case ID: 01826530

Updating the Bot Agent version sometimes failed. However, when you select the **Automatically update all bot agents** option, the Bot Agent updates to the latest version without failures.

<p>Control Room now supports Windows NT in French.</p> <p>Service Cloud case ID: 00682337</p>
<p>All <code>DELETE /v1/configurations</code> endpoints are not accessible anymore.</p> <p>Service Cloud case ID: 01920980</p>
<p>While installing Automation 360 on a three-node cluster, the installer prompts you to enter the <b>Elasticsearch</b> password for the first node only and replicates this data across the other two nodes.</p>
<p>Bots that are running for longer duration display correctly on the <b>In progress activity</b> page. Previously, these bots displayed only after bot updates and were removed after the page refresh.</p> <p>Service Cloud case ID: 01921149</p>
<p>You can now update Internet Explorer bots created in Automation 360 to <b>Microsoft Edge with IE mode</b> using the <b>Update Bot wizard</b> even if these bots (or its dependencies) contain a '.' (dot) character in its name.</p> <p>Service Cloud case ID: 01809003, 01814904, 01822014, 01858820</p>
<p>If you selected the <b>Log off windows session post bot execution</b> option under <b>Auto-login settings</b> in the Control Room, data in the resource folder is cleared after the bot run.</p> <p>Service Cloud case ID: 01795752, 01778828, 01804711,01864871,01923299, 01823515</p>
<p>If you delete a device entry from <b>Manage &gt; Devices</b> in the Control Room, the device registration properties are removed. This enables you to reregister the device.</p> <p>Service Cloud case ID: 01808450</p>
<p>You can successfully log in to Automation 360 using Active Directory credentials when the <b>Auto-login users into Control Room</b> option is enabled, without encountering any issues..</p> <p>Service Cloud case ID: 01808170, 01826805</p>
<p>The generated Control Room operational log files contain readable characters.</p> <p>Service Cloud case ID: 01872473</p>
<p>The Repository Management (<code>/v2/repository/files/&lt;file_id&gt;/content</code>) API now returns file contents only for the files the logged-in user has permission to view. The content of these files cannot be updated using a different API.</p> <p>Previously, this Repository Management API returned file contents for the files that the logged-in user did not have permission to view. And the user could update the content of these files.</p> <p>Service Cloud case ID: 01819101</p>
<p>Bot deployment now resumes and completes without any issue when the <b>Task Bot &gt; Pause</b> action executes before or while the runtime window is loading.</p> <p>Previously, the resume option was not displayed in the runtime window, and the bot deployment was not completed.</p> <p>Service Cloud case ID: 01835794</p>

<p>You can create a folder within the <b>Bots</b> folder in the public workspace.</p> <p>Previously, folder creation failed with an error in the public workspace.</p> <p>Service Cloud case ID: 01257981</p>
<p>You can now successfully compare different versions of your bots and dependencies in both the public and the private workspaces.</p> <p>Previously, comparing the bot versions failed with a timeout error.</p> <p>Service Cloud case ID: 01770115, 01905037</p>
<p>When you export the user data to a CSV file, it now shows the correct user type and device license information for all users.</p> <p>Previously, user data exported to the CSV file showed incorrect information.</p> <p>Service Cloud case ID: 01840507</p>
<p>You can now check in a bot successfully to the public workspace.</p> <p>Previously, the bot check in failed because the audit trial was processed unsuccessfully.</p> <p>Service Cloud case ID: 01860361</p>
<p>The BLM export is an asynchronous call and when used with the existing API endpoint <code>/v2/blm/status/{requestId}</code>, there is a delay associated with the API call. Due to this delay, you cannot retrieve the current status of the export if there is not enough time gap between the export and the status call. To bypass this limitation, a new API endpoint has been added <code>GET /v2/blm/status/{requestId}/timeout/{timeout}</code> which introduces a time delay that waits for the export process to complete and then retrieves the status.</p> <p>Service Cloud case ID: 01806109</p>
<p>Upgraded Swagger UI and Swagger Editor to version 4.15.5 to fix a security vulnerability.</p> <p>Service Cloud case ID: 01843148</p>
<p>When you create bots that use the <b>Excel advanced &gt; Select cells/rows/ column</b> action and set the <b>Cell Range</b> with an expression (such as <code>B1:\$SampleNumber.Number:toString\$</code>), the Bot editor no longer displays an error and the action now works properly.</p> <p>Service Cloud case ID: 01941537</p>
<p>When you use the File trigger to modify a BAT or VBS file, the trigger is generated once.</p> <p>Previously, the trigger would generate twice when you enabled the <b>file modified</b> scenario.</p> <p>Service Cloud case ID: 01816589, 01877498</p>
<p>You no longer encounter issues with bot check-in or cancel check-out after the bulk package update operation. When you try multiple bulk updates of packages, now an appropriate error message indicates to perform bulk updates of one package at a time.</p> <p>Previously, when you performed multiple bulk updates of packages, it resulted in check-in or cancel check-out errors.</p> <p>Service Cloud case ID: 01849828, 01881950</p>

Bots with a large number of automations complete successfully without any pre-processing issues or errors.

Service Cloud case ID: 01949415, 01949372, 01949033

## Security fixes

The version of Springframe Work is updated to 5.3.22 and does not exhibit the security vulnerability.

Service Cloud case ID: 01850811

## Limitations

When you create a device pool with a temporary (disconnected) device, the device deletion job does not complete successfully. Additionally, the **Audit log** page shows the device is deleted, whereas the **Device list** page shows the deleted device in the list.

When you check out bots in bulk, you cannot check out the bots for which you have the required permissions. This is because bots for which you have the required permissions are also excluded along with the bots for which you do not have the required permissions.

The bot checkout fails in the following scenarios:

- If a bot with same name (but different case) exists in your private workspace with the same path.

---

**Note:** In such cases, the bot checkout or overwrite fails even when an overwrite confirmation message displays.

---

- If a folder with the same name exists in your private workspace with the same path.

When you compare bot versions from the **View history** page in a **Public** workspace, the **Compare versions** page shows an error message.

Workaround: To fix this error, perform one of the following actions:

- In a **Public** workspace, click the three dots icon next to the required bot in the **Action** menu and click **Compare versions**.

---

**Note:** You cannot compare the bot versions when only one bot version is available.

---

- If you check out a bot to a **Private** workspace and then modify and save it, click the three dots icon in the **Action** menu and click **Compare versions**.

Service Cloud case ID: 01949094, 01946533

In Windows and Linux operating system, notifications are not working with the Oracle Database.

We use a third-party parser to convert from HTML format to plain text. As a result, when you convert an email from HTML format to plain text, you will see that, sometimes, the text is not converted into plain text and is not displayed in the correct format. For example, you might see that some lines are added or skipped.

Service Cloud case ID: 01822614

In any package, when you select the **Add argument** option, select **String** or **Number** as the **Argument type**, and then try to insert a value, you might not be able to navigate through the options using the scroll functionality.

When you use the **System > Get environment variable** action to select the list of environment variables to return the system parameters of the device, some environment variables might not be visible.

When you use the **Text file > Read variables** option to read the values of variables from the text file, use the **If > String** condition to execute actions based on the value of the specified source string, and run the bot, the bot might fail if the key value added to the mapped variable does not match the value in the text file.

Workaround: To pass null values successfully, perform the following steps:

1. Use **Text file > Read variables** action to add a dictionary variable.
2. Use **Dictionary > Get action** to find and save a specific key value.

---

**Note:** If the key value does not match with the value in the text file, then an empty string is returned to the string variable.

---

Alternatively, use the **If > Dictionary > Check key** condition to validate if the key is present in the text file. You can then assign value to the string variable accordingly.

After you upgrade to Automation 360 v.27, if a new package (first version) is added to the Control Room and in the setting for packages you selected **Disable** for the new version of package, you will see that the package will have status as **Enabled and set as default** instead of **Disable**.

In an Oracle Database environment, when you upgrade to Automation 360 v.27, the new package versions that are shipped through the installer remain in the disabled state and are not set as the default version.

Workaround: You must enable each updated or new package manually and set the package as the default version.

In the **Automation** page, column customizations made on the **Files and folders** are not retained when you navigate away from that page. For example, if you customize the columns in the private workspace, move out, and navigate back to the private workspace, the previous customization is not retained. It returns to the default view.

Similarly, searches and customizations such as filters, sort orders, custom columns, and partially completed edits are not retained when you navigate away from the page.

When you run the `v1/audit/messages/list` API in Control Room swagger, the following error message is displayed:

```
Please correct the following validation errors and try again.
propKeyfilterErrorValue must be a string.
PropKeypageerrorValue must be a string.
```

Workaround: Run the `v1/audit/messages/list` API using Postman application to avoid the error.

Service Cloud case ID: 01988096

you

#### Limitations from previous releases

When you run a bot in the Google Chrome or Microsoft Edge browser, use the If, Loop, or Wait action, select the webpage from the list of active tabs in the **Browser** tab, close the browser window, and then run the bot, the bot might take two minutes to open the webpage in the browser irrespective of the timeout value mentioned.

Workaround: Move the If, Loop, or Wait action inside the **If** block and use the **Application is running** condition with same browser application to check whether the browser is running.

You will encounter an error when you run a standard workflow in the SAP BAPI package.

Workaround: To execute SAP BAPI, use the Run Function call (RFC) with a combination of **Create function**, **Set** or **Get field value**, **Set** or **Get structure**, and **Set** or **Get table** actions.

[A360 : SAP BAPI functions - Run Standard Workflow - Error while selecting BAPI\\_SALESORDER\\_CHANGE \(A-people login required\)](#)

When you migrate a bot that contains **XML command > Get single node**, after migration, the bot encounters the following error: *No node found at XPath while executing the Get Single node command* Workaround: If the XPath expression is not starting with `(/)`, apply XPath starting with `"/"` so that at the time of execution, the modification can be skipped or the XPath expression can be designed to get the desired result.

When you use the **Capture** action with the Recorder package (version 2.9.x or earlier) to navigate to another web page in the Google Chrome browser (version 105.0 or later), and then use another **Capture** action to automate objects in the navigated web page, the bot might encounter an error.

Workaround: Before you use the **Recorder > Capture** action in the bot, maximize the Google Chrome window.

When you use the If package, add a specific condition with a variable, then add specific conditions within a group, save the bot, and if you rename the variable that was used, the name of the variable might not update for the **Group** conditions but is only updated for the conditions in the **Condition** tab.

Command prompt API allows you to switch the device registration even if the **Allow devices (single user) to be switched to another Control Room without reinstalling bot agent** option is disabled.

Limitations from previous releases
<p>When you upgrade from Automation 360 v.25 to a later version, although you enabled code analysis in the Control Room, the rules set in the policy are not retained after the upgrade.</p> <p>Workaround: Before upgrading, we recommend that you keep a note of the rules enabled in Automation 360 v.25 and then re-enable them after upgrading to a later version.</p>
<p>When you uninstall Automation 360 from the Control Panel, the name of the file is displayed incorrectly (for example, 3e592.msi) on the <b>User Account Control</b> window.</p>
<p>While running a bot in debug mode, the bot will fail if the variable size gets greater than 3 MB. An error message appears showing that a variable has exceeded the 3 MB limit.</p>
<p>When you set the default package version using the <b>Update bots to default package version</b> option for bots in the public workspace that are using the <b>Excel Advanced &gt; Open</b> action, the Task Bots do not display the session name and file path values.</p> <p>Workaround: Perform one of the following workarounds:</p> <ul style="list-style-type: none"><li>• Update the <b>Excel Advanced</b> package manually to use the latest version of the package. See <a href="#">Select the package version used in your bot</a> on page 2322</li><li>• Check out the bot and revert to the previous version of the <b>Excel Advanced</b> package. Then, check in the bot to use the latest version of the package. See <a href="#">Update bots to default package version</a> on page 1910</li></ul>

## Updates to the interface



**Automation Workspace**

The **Max auto retry attempt** option is added to reprocess the failed WLM work items automatically.

**Create queue** Cancel Create draft of queue

**General settings**

In this wizard, you will be able to create a queue of work items and assign permissions. You can save a draft at any time and come back later to complete the queue.

Queue name:  Description (optional):

Maximum = 50 characters Maximum = 255 characters

Reactivation Threshold:  work items

Minimum number in queue to resume processing

Time it takes for a person to complete 1 work item (optional):  seconds

**Max auto retry attempt**  times

Number of times the failed work items have to be re-processed

Next >

[Automated reprocessing of failed WLM work items](#)

The drop-down menu in the Bot editor now includes an option to open a menu for keyboard shortcuts.

Assistant | Run | Debug | Close | Save

Assistant | Run | Debugger | Close | Save

**Action details**

- Analyze Task Bot...
- Packages
- Dependencies and references
- Work item template
- Advanced settings
- Properties

**Action details**

- File properties
- Bot Insight "Analyze" dashboard...
- Packages
- Dependencies and references
- Work item template
- Advanced settings
- Keyboard Shortcuts**
- Capture and run with admin privileges

[Keyboard shortcuts](#)

**Automation Workspace**

The **Device(s) from my device pools** and **Run as users default device(s)** options are added in the **Edit the device(s)** permission to manage registered and non-registered devices.

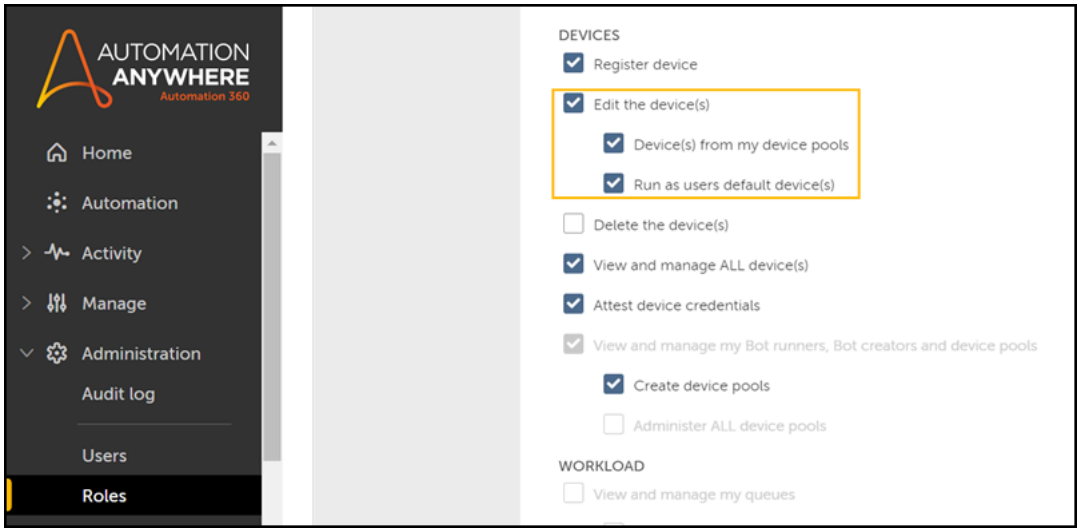

**DEVICES**

- Register device
- Edit the device(s)
  - Device(s) from my device pools
  - Run as users default device(s)
- Delete the device(s)
- View and manage ALL device(s)
- Attest device credentials
- View and manage my Bot runners, Bot creators and device pools
- Create device pools
- Administer ALL device pools

**WORKLOAD**

- View and manage my queues

**Better device management with improved device permissions**

The gMSA option enables you to manage your domain accounts across multiple servers.

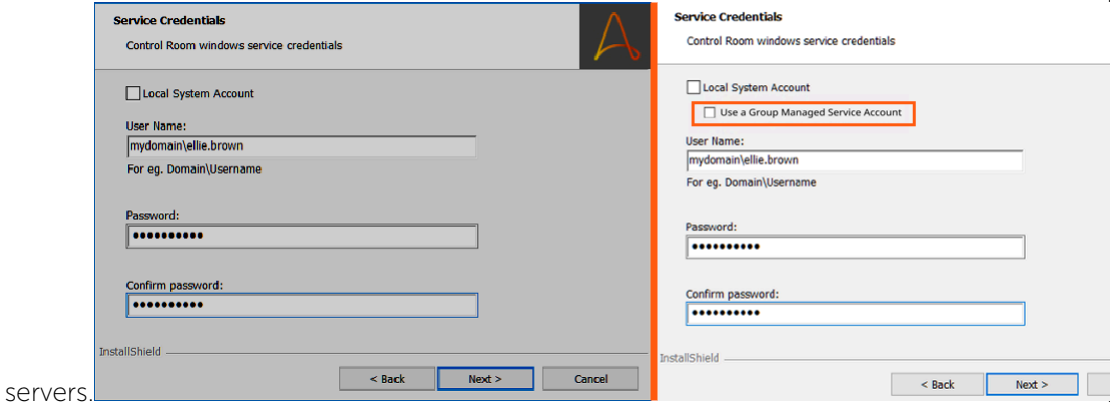

**Service Credentials**  
Control Room windows service credentials

Local System Account

User Name:  
mydomain\ellie.brown  
For eg. Domain\Username

Password:  
[Redacted]

Confirm password:  
[Redacted]

InstallShield

Local System Account

Use a Group Managed Service Account

User Name:  
mydomain\ellie.brown  
For eg. Domain\Username

Password:  
[Redacted]

Confirm password:  
[Redacted]

InstallShield

**Manage domain accounts using gMSA**

**Automation Workspace**

The **Custom number of bot runners** option allows you to choose the number of Bot Runners that you want to use to run

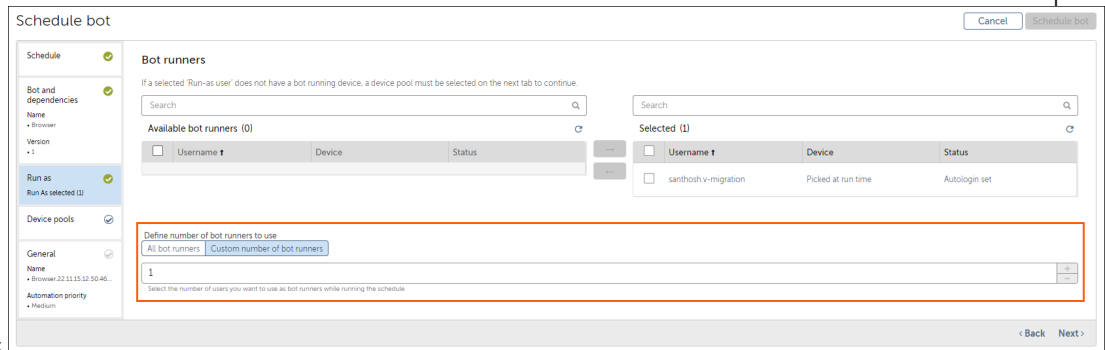

bots

[Customize the number of Bot Runners](#)

The Automation Anywhere **Debugger** tool is now available within the Bot Assistant utility to provide a better user experience.

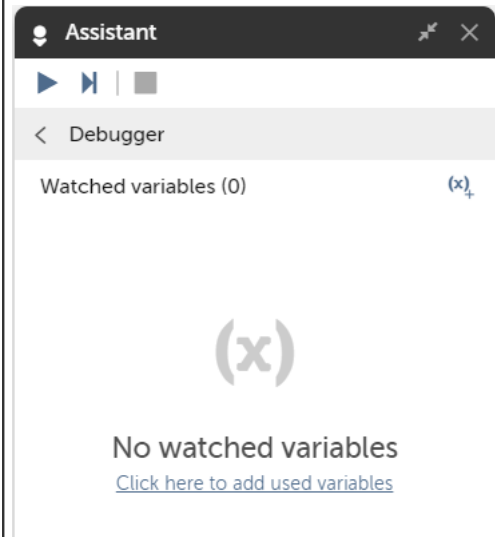

[Enhanced Automation Anywhere Debugger tool](#)

**Automation Workspace**

Updated and intuitive icons for all the actions and contextual help for Database and Email actions.

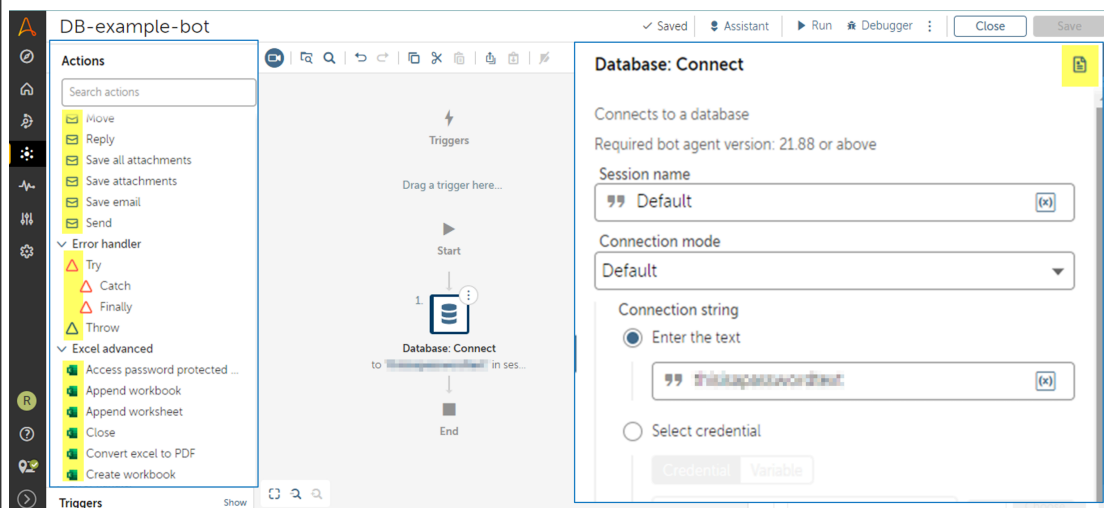

The screenshot displays the Automation Workspace interface for a bot named "DB-example-bot". On the left, there is a sidebar with an "Actions" panel containing a search bar and a list of actions such as "Move", "Reply", "Save all attachments", "Save attachments", "Save email", "Send", "Error handler" (with sub-items: Try, Catch, Finally, Throw), and "Excel advanced" (with sub-items: Access password protected..., Append workbook, Append worksheet, Close, Convert excel to PDF, Create workbook). The main workspace shows a flowchart starting with a "Start" node, followed by a "Database: Connect" action node, and ending with an "End" node. A right-hand pane titled "Database: Connect" provides configuration options: "Connects to a database", "Required bot agent version: 21.88 or above", "Session name" (set to "Default"), "Connection mode" (set to "Default"), and "Connection string" (set to "Enter the text" with a text input field containing a placeholder string). Below the connection string, there are radio buttons for "Enter the text" (selected) and "Select credential", with "Credential" and "Variable" buttons below.

Enhanced user experience through intuitive icons | Quick assistance at hand for the developers in the Bot editor

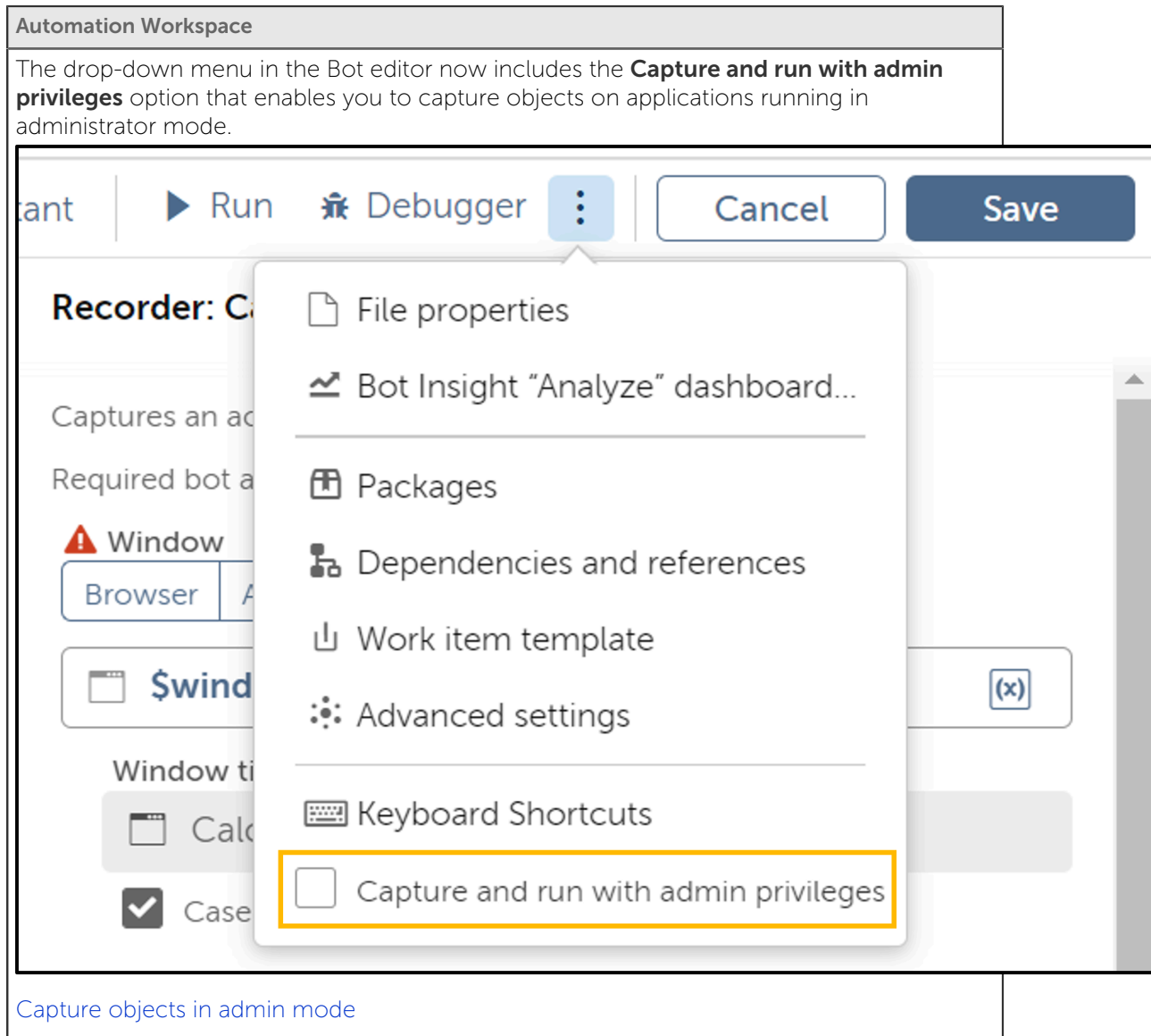

Related reference

[Automation 360 v.27 Release Notes](#) on page 182

[Process Discovery v.27 release](#) on page 236

Review what's new in Process Discovery for the v.27 release.

[Automation Co-Pilot for Business Users v.27 release](#) on page 237

Review what's new and changed, and the fixes and limitations in Automation Co-Pilot for the v.27 release.

[IQ Bot and Document Automation v.27 release](#) on page 246

Review what's new and changed, and the fixes and limitations in IQ Bot and Document Automation for the v.27 release.

[Bot Insight v.27 release](#) on page 253

Review the fixes in Bot Insight for the v.27 release.

[Packages updated in v.27](#) on page 215

Review updates to the packages in Automation 360 v.27, including the compatible Control Room and Bot Agent versions.

[Updating to v.27 release](#) on page 214

Review requirements and support information about updating your Control Room and Bot Agent for the v.27 release.

[Migration updates for v.27 release](#) on page 227

Review what's new, changed, and the fixes and limitations to migrating from Enterprise 11 and 10 versions to Automation 360 v.27.

[Browser extensions for Automation 360](#) on page 985

Create automation from supported browsers by using browser extensions. Extensions are periodically updated to support feature enhancements and fixes. Therefore, ensure that you have the latest versions of extensions for the Google Chrome, Microsoft Edge, and Mozilla Firefox browsers.

## Updating to v.27 release

Review requirements and support information about updating your Control Room and Bot Agent for the v.27 release.

## Bot Agent updates

---

**Note:** This release includes an optional Bot Agent update. You can continue to run your existing bots without updating the Bot Agent. However, if you want to use the new features in Automation 360 v.27, you must update the Bot Agent available with this release.

---

For more information on updating to this release, see these resources:

- [Automatically update the Bot Agent](#) on page 1361 | [Manually update the Bot Agent](#) on page 1362
- [Compatibility with release builds](#) on page 1333

## Certified Control Room builds for direct update

You can update to the latest version of Automation 360 from the previous three releases (that is, from n–3 releases, where n refers to the latest release).

The following previous releases are certified for update to Automation 360 v.27:

- v.26 (Build 15450)
- v.25 (Build 15112)
- v.24R2 (Build 13343) and v.24 (Build 12350)

If you are on one of these previous releases, for information about updating, see [Update Automation 360 to latest version](#) on page 1423. If you are not on an n–3 release, update Automation 360 to one of the n–3 releases before updating to Automation 360 v.27.

For the latest updates to the Automation 360 extensions for Google Chrome, Microsoft Edge, and Mozilla Firefox, see [Browser extensions for Automation 360](#) on page 985.

Related reference

[Automation 360 v.27 Release Notes](#) on page 182

[Automation Workspace v.27 release](#) on page 185

Review what's new and changed, and the fixes and limitations in Automation Workspace for the v.27 release.

[Packages updated in v.27](#) on page 215

Review updates to the packages in Automation 360 v.27, including the compatible Control Room and Bot Agent versions.

## Packages updated in v.27

Review updates to the packages in Automation 360 v.27, including the compatible Control Room and Bot Agent versions.

The following table lists the updates in the packages for this release:

**Note:** For information about packages related to previous releases, see the PDFs for these releases: [Automation 360 previous release versions](#).

Package name	Version	Package updates	Bot Agent version	Control Room version
AARI web	7.27.0-20221026-170018	None	21.134 or later	12316 or later
Active Directory	3.6.2-20221027-064844	<ul style="list-style-type: none"> <li>New feature</li> <li>Defect fix</li> </ul>	20.11 or later	8750 or later
Analyze	2.4.4-20220615-020937	None	20.11 or later	8750 or later
App Integration	4.8.0-20220616-123118	None	21.88 or later	10195 or later
Application	3.6.1-20221014-042725	Localization changes	20.11 or later	8750 or later
Boolean	2.6.4-20220919-050851	Internal renaming of an attribute (no impact to existing bots on upgrade)	20.11 or later	8750 or later

Package name	Version	Package updates	Bot Agent version	Control Room version
Bot Migration	10.3.4-20221020-152650	<ul style="list-style-type: none"> <li>• New feature 1</li> <li>• New feature 2</li> <li>• New feature 3</li> <li>• Defect fix 1</li> <li>• Defect fix 2</li> <li>• Defect fix 3</li> <li>• Defect fix 4</li> <li>• Defect fix 5</li> </ul>	21.220 or later	15224 or later
Browser	3.7.5-20221104-153650	New feature	21.210 or later	14140 or later
Clipboard	3.5.0-20220923-115005	Localization changes	20.11 or later	8750 or later
Comment	2.12.0	Internal renaming of an attribute (no impact to existing bots on upgrade)	20.11 or later	8750 or later
Credential	1.4.0-20220930-120805	Enhancement	20.11 or later	8750 or later
CSV/TXT	2.10.2-20221025-092104	Added intuitive package icon	20.11 or later	8750 or later



Package name	Version	Package updates	Bot Agent version	Control Room version
Database	4.10.5-20221119-112148	<ul style="list-style-type: none"> <li>• <a href="#">New feature 1</a></li> <li>• <a href="#">New feature 2</a></li> <li>• <a href="#">Defect fix 1</a></li> <li>• <a href="#">Defect fix 2</a></li> <li>• <a href="#">Defect fix 3</a></li> </ul>	21.88 or later	10204 or later
Data Table	4.6.0-20220920-155212	Internal renaming of an attribute (no impact to existing bots on upgrade)	20.11 or later	8750 or later
Datetime	2.10.3-20220919-051216	<a href="#">New feature</a>	20.11 or later	8750 or later
Delay	3.6.0-20220926-132853	Internal renaming of an attribute (no impact to existing bots on upgrade)	20.11 or later	8750 or later
Dictionary	3.10.0-20220929-153817	<a href="#">Defect fix</a>	20.11 or later	8750 or later
DLL	6.7.1-20221027-124401	<a href="#">New feature</a>	21.220 or later	15238 or later
Document Extraction	1.0.9-20221223-075522	<a href="#">Fixes</a>	21.98 or later	15345 or later

Package name	Version	Package updates	Bot Agent version	Control Room version
Email	3.15.2-20221006-075826	<ul style="list-style-type: none"> <li>• New feature 1</li> <li>• New feature 2</li> <li>• New feature 3</li> <li>• Defect fix 1</li> <li>• Defect fix 2</li> <li>• Defect fix 3</li> </ul>	21.210 or later	13980 or later
Email trigger	2.9.1-20221006-095506	<ul style="list-style-type: none"> <li>• New feature</li> </ul>	21.210 or later	13980 or later
Error handler	2.10.0-20220929-040758	Internal renaming of an attribute (no impact to existing bots on upgrade)	20.11 or later	8750 or later
Excel advanced	6.11.0-20220919-135308	Defect fix	21.112 or later	11307 or later
Excel basic	6.11.0-20220919-135307	Added intuitive package icon	21.112 or later	11307 or later
File	6.5.0-20221003-160340	<ul style="list-style-type: none"> <li>• Defect fix 1</li> <li>• Defect fix 2</li> <li>• Defect fix 3</li> </ul>	21.98 or later	10789 or later
File and Folder	1.3.0-20221014-182105	Defect fix	20.11 or later	8750 or later

Package name	Version	Package updates	Bot Agent version	Control Room version
Folder	6.5.0-20221003-160340	Added intuitive package icon	20.11 or later	8750 or later
FTP / SFTP	2.8.3-20221006-182804	Localization changes	20.11 or later	8750 or later
Genesys	1.0.4	None	21.210 or later	14199 or later
Google Calendar	2.9.1-20221006-143939	Defect fix	20.11 or later	8750 or later
Google Drive	2.10.1-20221006-142240	Defect fix	20.11 or later	8750 or later
Google Document AI	1.2.0-20220616-091303	Fixed the vulnerabilities reported in the security scan	21.98 or later	10520 or later

Package name	Version	Package updates	Bot Agent version	Control Room version
Google Sheets	2.10.1-20221006-123004	<p>The error is no longer displayed when you:</p> <ul style="list-style-type: none"> <li>• Create a sheet with the existing sheet name.</li> <li>• Use <b>Delete cell &gt; Specific cell</b> and select the delete option as <b>Shift cell left</b>.</li> <li>• Open the spreadsheet with session 2 after disconnecting the session 1.</li> <li>• An appropriate error message displays when you disconnect an previously closed session.</li> </ul>	20.11 or later	8750 or later

Package name	Version	Package updates	Bot Agent version	Control Room version
Google G Suite	2.8.0-20220416-235104	None	20.11 or later	8750 or later
Hot key	1.1.0-20220715-220729	None	None	None
If	3.5.0-20220928-201537	Internal renaming of an attribute (no impact to existing bots on upgrade)	20.11 or later	8750 or later
Image Recognition	3.11.1-20221025-190457	Fixed the vulnerabilities reported in the security scan	21.210 or later	14100 or later
Interactive forms	2.27.3-20221014-074409	<ul style="list-style-type: none"> <li>• <a href="#">New feature 1</a></li> <li>• <a href="#">New feature 2</a></li> <li>• <a href="#">New feature 3</a></li> <li>• <a href="#">New feature 4</a></li> <li>• <a href="#">New feature 5</a></li> </ul>	20.11 or later	8750 or later
Interface trigger	1.5.1-20221122-181213	None.	20.11 or later	8750 or later
IQ Bot	2.2.5-20221107-102303	Fixed the vulnerabilities reported in the security scan	21.98 or later	10520 or later

Package name	Version	Package updates	Bot Agent version	Control Room version
IQ Bot Pre-processor	2.2.5-20221107-101937	Fixed the vulnerabilities reported in the security scan	21.98 or later	10520 or later
JavaScript	2.13.0-20220620-094850	None	20.11 or later	8750 or later
JSON	1.2.0-20221003-172422	Internal renaming of an attribute (no impact to existing bots on upgrade)	21.98 or later	10520 or later
Legacy AI Sense	2.0.1-20221019-100134	<a href="#">Defect fix</a>	21.220 or later	15224 or later
Legacy Automation	5.6.1-20221027-080331	<ul style="list-style-type: none"> <li><a href="#">New feature</a></li> <li><a href="#">Defect fix</a></li> </ul>	21.200 or later	13279 or later
List	2.9.2-20220919-103920	Internal renaming of an attribute (no impact to existing bots on upgrade)	20.11 or later	8750 or later
Log To File	3.5.0-20220416-233918	None	20.11 or later	8750 or later
Loop	3.6.0-20220928-191723	Internal renaming of an attribute (no impact to existing bots on upgrade)	20.11 or later	8750 or later
Message Box	3.4.0-20220416-233919	None	20.11 or later	8750 or later

Package name	Version	Package updates	Bot Agent version	Control Room version
Mouse	2.12.4-20221021-043050	Fixed the vulnerabilities reported in the security scan	21.210 or later	14100 or later
Number	3.6.0-20220928-104414	Added intuitive package icon	20.18 or later	9130 or later
OCR	2.10.0-20220502-204318	None	21.118 or later	8750 or later
Microsoft 365 Calendar	2.10.1-20221006-064900	Added intuitive package icon	20.11 or later	8750 or later
Microsoft 365 Excel	2.10.1-20221006-064900	Added intuitive package icon	20.11 or later	8750 or later
Microsoft 365 OneDrive	2.10.1-20221006-064900	Defect fix	20.11 or later	8750 or later
PDF	3.7.1-20221012-090203	<ul style="list-style-type: none"> <li>Defect fix 1</li> <li>Defect fix 2</li> </ul>	21.31 or later	9300 or later
PGP	3.4.0-20220118-154220	None	21.88 or later	10195 or later
Ping	3.4.0-20220416-234250	None	20.11 or later	8750 or later
Play Sound	2.6.0-20220421-071315	None	20.11 or later	8750 or later
Printer	2.4.0-20220118-154256	None	20.11 or later	8750 or later
Process trigger	1.3.0-20220118-154818	None	21.112 or later	11314 or later
Process Discovery	2.1.14-20221024-185708	None	21.128 or later	12247 or later
Prompt	2.6.0-20220118-154257	None	20.11 or later	8750 or later

Package name	Version	Package updates	Bot Agent version	Control Room version
Python Script	2.13.0-20221101-070548	Fixed the vulnerabilities reported in the security scan	20.11 or later	8750 or later
Record	1.6.3-20220919-051027	Internal renaming of an attribute (no impact to existing bots on upgrade)	20.11 or later	8750 or later
Recorder	2.9.2-20221122-181034	<ul style="list-style-type: none"> <li>• <a href="#">New feature 1</a></li> <li>• <a href="#">New feature 2</a></li> <li>• <a href="#">Defect fix</a></li> </ul>	21.210 or later	14068 or later
REST Web Service	3.12.0-20220926-070217	Fixed an issue where different proxies were configured for a URL using a PAC file.	20.11 or later	8750 or later
Salesforce	1.0.4-20220921-170743	None	21.119 or later	15422 or later
SAP	3.8.1-20221021-121957	Added intuitive package icon	21.88 or later	10195 or later
SAP BAPI	2.7.0-20220424-053247	None	21.2 or later	9249 or later
Screen	2.8.0-20220426-033758	None	20.11 or later	8750 or later
Service	4.6.0-20220930-121118	Localization changes	20.11 or later	8750 or later
Service trigger	1.5.1-20220425-083711	None	21.112 or later	11314 or later



Package name	Version	Package updates	Bot Agent version	Control Room version
ServiceNow	1.0.3-20221010-154249	New feature	21.230 or later	16455 or later
Simulate keystrokes	4.0.1-20221021-090235	<ul style="list-style-type: none"> <li>New feature</li> <li>Defect fix</li> </ul>	21.200 or later	13297 or later
SNMP	2.5.0-20220419-063009	None	20.11 or later	8750 or later
SOAP Web Service	3.13.1-20221025-092212	Label change (Build Soap Request is renamed to Build SOAP request)	21.90 or later	10227 or later
Step	2.4.0-20220929-044740	Internal renaming of an attribute (no impact to existing bots on upgrade)	20.11 or later	8750 or later
String	5.5.2-20221006-094641	New feature	20.18 or later	9130 or later
System	3.10.0-20220921-062556	Internal renaming of an attribute (no impact to existing bots on upgrade)	21.88 or later	10217 or later
Task Bot	2.5.0-20221020-114450	Updated the version for botRunTime and bot API	20.11 or later	8750 or later
Terminal Emulator	4.8.0-20220923-172123	New feature	21.93 or later	10353 or later

Package name	Version	Package updates	Bot Agent version	Control Room version
Text file	1.4.2-20221004-130231	New feature	20.11 or later	8750 or later
Trigger loop	0.7.0-20220715-220725	None	20.11 or later	8750 or later
V11 Task Bot	1.12.1-20220707-062607	Defect fix	20.11 or later	8750 or later
VBScript	2.16.2-20221020-051711	Fixed the vulnerabilities reported in the security scan	21.210 or later	14100 or later
Wait	4.7.0-20221003-160840	Internal renaming of an attribute (no impact to existing bots on upgrade)	20.11 or later	8750 or later
Window	5.8.0-20220923-081314	Added intuitive package icon	20.11 or later	8750 or later
Window trigger	1.4.0-20220118-154823	None	20.11 or later	11314 or later
Workload	2.10.1-20220512-164301	None	20.11 or later	8750 or later
XML	3.8.2-20221025-092212	Defect fix	20.11 or later	8750 or later

\* These fixes are minor, internal updates, so they do not include an update or further details on our documentation site. As these updates relate to improvements in security, resiliency, and efficiency, we recommend that you use the latest package versions to include these updates in your existing bots.

Related reference

[Updating to v.27 release](#) on page 214

Review requirements and support information about updating your Control Room and Bot Agent for the v.27 release.

[Automation Workspace v.27 release](#) on page 185

Review what's new and changed, and the fixes and limitations in Automation Workspace for the v.27 release.

[Automation 360 v.27 Release Notes](#) on page 182

## Migration updates for v.27 release

Review what's new, changed, and the fixes and limitations to migrating from Enterprise 11 and 10 versions to Automation 360 v.27.

### What's new

Enterprise 11 and Enterprise 10
<p>Scan Automation 360 bots that use Basic authentication in Email action</p> <p>This release introduces an option to use the Bot Scanner to scan all Automation 360 bots and identifies those that use Basic authentication in the Email package and Email trigger action so that you do not have to identify them manually.</p> <p>You can use the Bot Scanner report to analyze the impact to the bots due to the Basic authentication and the estimated effort required to switch the authentication mode from Basic to OAuth 2.0.</p> <p>For more information, see <a href="#">Scan bots for Basic authentication</a> on page 1134   <a href="#">Basic authentication scanning messages</a> on page 1137</p>
<p>Variables created automatically after migration</p> <p>In the Bot Scanner utility, bots that contain the following non-referenced system variables are no longer flagged as Action Required or Review Required:</p> <ul style="list-style-type: none"> <li>• \$Excel Column\$</li> <li>• \$Filedata Column\$</li> <li>• \$Dataset Column\$</li> <li>• \$Table Column\$</li> <li>• \$XML Data Node\$</li> <li>• \$PDFTitle\$</li> <li>• \$PDFSubject\$</li> <li>• \$PDFFileName\$</li> <li>• \$PDFAuthor\$</li> </ul> <p>After migration, the system automatically creates these variables based on the Automation 360 naming convention, and the migrated bots run successfully.</p>
<p>Support for SMTP server type with Send Email command</p> <p>When you migrate bots with the Send Email command, you can select the <b>Use outgoing Email server settings</b> option in the Bot Migration Wizard to identify and select the server type for the Enterprise 11 bots. You can configure required server details using a new SMTP server type option.</p> <p>See <a href="#">Migrate Enterprise bots</a> on page 1590.</p>

**Enterprise 11 and Enterprise 10**

Improved automated editing ability for legacy bots

When you migrated legacy bots that contained the Log To File command, the Carriage Return and Line Feed (CRLF) characters were converted to LF characters automatically. In Automation 360, the text is displayed in a single line with no line feed, whereas in Enterprise 11, the CRLF is added at the end of each line as a line feed. As a result, you had to add the **\$String:Newline\$** variable to insert a CRLF in the migrated bot.

The new **Convert \n characters to \r\n Log to File action** option in the Bot Migration Wizard enables you to add a new CRLF automatically to migrated bots and avoid manual edits. Migrated bots that use the Log To File sub-commands to log files can use the CRLF characters in a string.

See [Migrate Enterprise bots](#) on page 1590

**Enterprise 11 only**

Migration enhancement to packages and actions

- When you migrate Enterprise 11 bots with variables whose values are read from a text file, the system adds the **String: Import string from text file** subcommand to import the variables from the text file into a string variable. As a result, extra lines are added in the migrated bots.

The **Read variables** action has been added in the Text filepackage to address the extra lines.

You can use this action to read the values of all variables in a text file as a single line in a migrated bot which simplifies the post-migration efforts and reduces the number of lines added in a migrated bot.

See [Read variables action](#) on page 3135

- Microsoft is removing the capability to use Basic authentication in Exchange Online for the following protocols:
  - RPC
  - MAPI
  - Offline Address Book (OAB)
  - Exchange Web Services (EWS)
  - POP
  - IMAP
  - Exchange ActiveSync (EAS)
  - PowerShell

For those customers running bot for Email automation that connect to Exchange Online using the IMAP, POP3, or EWS protocol with Basic authentication, we have added authentication options to support **OAuth2** authentication.

You can migrate Enterprise 11 bots with the authentication type set to the **OAuth2** option with **Authorization code with PKCE** or **Client credentials**.

- In the **Read from** action of the Database package, the following option is introduced: **Don't create file if no data is found**. This option is selected by default for migrated bots with the Database package, and the migrated bots now follow the same behavior as Enterprise 11. If the executed SQL query does not return any data, the behavior is as follows:
  - If this option is selected, no CSV file is created.
  - If this option is not selected, a 0 KB CSV file is created.

For more information, see [Using the Read from action](#) on page 2475.

- Migrated bots support the newly added **Return** key in the **Simulate Keystrokes > Keystrokes** action. These bots will continue to display the **Enter** key (which has been renamed to **Num Enter**) and the newly added **Return** key.
- Migrated bots support access to the Datetime global variable across all actions in the Datetime commands.

**Enterprise 11 only**

You can successfully migrate Task Bots that contain references to multiple MetaBots which include DLLs with same name. The session name of the first DLL is created using the name of the DLL. When the subsequent DLL with the same name from another MetaBot is migrated, the ID of the folder in which the DLL resides is used as a session name.

For example: `M_DLL_Session-<MetabotFolderId>_<DLLName>`.

**Fixes**

If the Enterprise 11 bots used the Send Email command without configuring authentication, now after migration the **Email server host**, **Email server port**, and **My server requires authentication** values are set to the appropriate values.

Previously, after migration, these values were set to null variables and authentication failed.

Service Cloud case ID: 01849475

After migration, bots that are using Visual Basic script or JavaScript in the Run Script legacy automation action and using multiple parameters that include spaces without quotation marks will now display the correct output after execution.

Previously, such bots were displaying incorrect output.

Service Cloud case ID: 01901882

An error no longer occurs during migration when the Select Query bot runs validation. Previously, the following error randomly occurred with text drivers.

[Microsoft][ODBC Text Driver] Object invalid or no longer set.

After migrating to Automation 360, if the **Application** window does not exist for the bots that use the If, IF/ELSE, or Loop in Windows control, then these bots no longer encounter errors during bot run.

Service Cloud case ID: 01846262

The **Stored Procedure** parameters are set correctly with **Nvarchar** when you migrate bots to Automation 360.

When a bot that contained the **File** and **Folder** loop was migrated to Automation 360, an error was displayed if the corresponding folder did not exist. You can migrate such bots like the corresponding legacy bot as the **If** condition is now added before the **File** and **Folder** loop to check if the folder exists.

You can migrate bots that contain the **Substring** command from the String package to Automation 360, even if the optional **Length** attribute is blank.

When you migrate a bot that has **\$counter** variable within a nested loop to Automation 360, the child loop counter is now set to the parent loop counter and the child loop iteration is processed correctly.

When you run a **Select** query inside a Loop package, and you reiterate its result set further, the resultant Loop now reiterates the latest record as expected.

Service Cloud case ID: 01799961

<p>You can successfully migrate bots that have the <b>Wait for object to exist value</b> option set to <b>0</b> seconds in the Object Cloning command.</p>
<p>When you use the <b>Run Logic</b> command with an IF/ELSE condition that uses a <b>Credential variable</b>, all credential variables migrate successfully.</p>
<p>When you migrate Enterprise 11 bots with string variables that have static values, variable parsing through legacy expressions is no longer performed. This avoids unnecessary parse expressions from being added to the migrated bots.</p> <p>Service Cloud case ID: 01819830</p>
<p>You can successfully run migrated bots that contain multiple Clipboard variables as an output. Automation 360 adds the <b>Clipboard:Copy to</b> action after every variable so that migrated bot is run properly.</p> <p>Service Cloud case ID: 01815938</p>
<p>When you migrate Enterprise 11 bots that use the <b>Connect</b> action with the Terminal Emulator command, and if the <b>Hostname</b> field contains a Credential Variable, then the field is mapped correctly after migration.</p> <p>Service Cloud case ID: 01861600</p>
<p>When you run migrated bots that contain the <b>Legacy Automation &gt; Manage web controls &gt; Select Item by Text</b> action, the list that contains variables is now displayed as expected.</p> <p>Service Cloud case ID: 01782998</p>
<p>You can now change, reallocate, or delete the license of a Bot Runner user in a migrated Automation 360 Control Room, even if the Bot Runner user had logged in to Enterprise 11 Client at least once.</p> <p>Previously, an error was displayed in such cases.</p> <p>Service Cloud case ID: 01829547</p>
<p>You can run migrated bots successfully on SMTP servers when you include the Send Email command inside a Loop, and that loop iterates more than 100 times.</p> <p>Service Cloud case ID: 01792886</p>
<p>Migrated bots do not create duplicate variables when the <code>Error_description</code> variable is case-sensitive.</p> <p>Service Cloud case ID: 01861530</p>
<p>You can now successfully migrate audit logs using the audit log export utility on a multi-node setup from the Enterprise 11 Control Room.</p> <p>Previously, the audit log export utility displayed an exception error in such cases and the audit logs could not be migrated.</p> <p>Service Cloud case ID: 01912835</p>

## Limitations

In Enterprise 11, if bots were using certain keys (such as: Ctrl, Shift, Caps Lock, Num Lock, and so on) in the Insert Keystrokes command, the keys were reset when an error was encountered during the execution of child bots. However; after migration, these keys are not reset when an error is encountered during the execution of child bots. As a result, different output or behavior might occur during the execution of the other subsequent child bots or the main bot.

Service Cloud case ID: 00773679

When you migrate a bot that uses the **Send email** command and run the bot in Automation 360, the predefined placeholders in the email body are not replaced with their actual content.

For example:

```
Task Name: <taskname>
Repeat: <repeat>
Status: <status>
Last Run Time: <lastruntime>
```

Whereas when you run the bot in Enterprise 11 with these placeholders, the following output is generated:

```
Task Name: PLACEHOLDER_SEND.atmx
Repeat: Do not Repeat
Status: Failed
Last Run Time: 11/29/2022 13:04:22
```

Service Cloud case ID: 01908010

When you run a migrated bot with an XML package that contains an **Xpath** expression, the running bot might fail and generate this error message: No node found at XPath

This issue might occur for these specific scenarios:

- If the root element does not have a namespace, and the child element of the XML package has a default namespace.
- If there are more than one xmlns (the default XML namespace) defined in the XML document.

Service Cloud case ID: 01874203, 01798339

See [XML path is not working which works fine in Enterprise 11](#)

## Updates to the interface



**Migration**

The **Bots using Email action with Basic authentication** option is added to the Bot Scanner to scan bots that use basic authentication in the Email package and Email

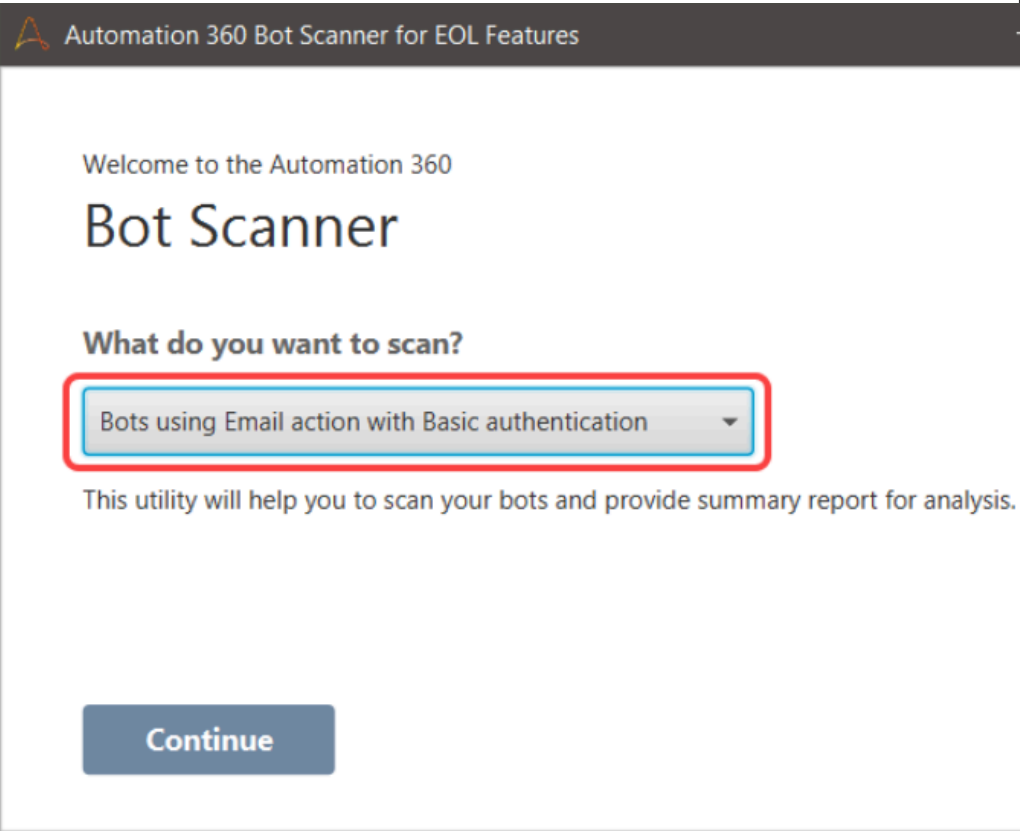

trigger.

[Scan Automation 360 bots that use Basic authentication in Email action](#)

### Migration

The **Use outgoing Email server settings** option is added to the Bot Migration Wizard to specify the type of email server you use.

Migrate bots
Cancel Migrate bots

**Settings** ✔

Name  
Migration.admin.23.01.04...

Description  
...

**Bots** ✔

Bots selected (0)

**Bot Runners** ✔

**Bots and Dependent Bots** ○

**Settings**

Name  Description (optional)

Maximum = 255 characters Maximum = 255 characters

**Bot Migration settings**

Overwrite if a bot with the same name exists

Exclude bot dependencies  
If this option is selected, all the bot dependencies will be excluded while migrating.

**Bot behaviour configuration**

Use 'Excel Cell Row' legacy behavior  
If you are migrating from 11.3.0 and below, we recommend selecting this option.

**Use outgoing Email server settings**  
If this option is selected, settings will be applicable to bots that contain send email action. You may need to update the global value if required.

SMTP email server

Server uses secure connection (SSL/TLS)

Server requires authentication

EWS email server

Include web services settings  
This allows you to migrate along with the web services proxy host and port. If this value is selected, pre-created global values will be available to the bot for connecting with web services proxy.

Convert bots built using Internet Explorer to Edge with Internet Explorer mode  
If you are migrating bots built on Internet Explorer, we recommend selecting this option to convert them to Edge with Internet Explorer mode.

Convert \n characters to \r\n in 'Log to File' action  
This allows you to convert \n characters (LF) into \r\n characters (CRLF), which automatically take new line in bots using Log to File action.

**Bot Insight configuration**

Tag bots and variables for analytics  
This allows you to tag bots and variables for analytics through Bot Insight. If you are not using Bot Insight in legacy bots, we recommend you not to select this option.

Next >

Support for SMTP server type with Send Email command

**Migration**

The **Convert \n characters to \r\n Log to File action** option is added to the Bot Migration Wizard to provide you an option to not have to edit the bots manually and a new line is added automatically in migrated

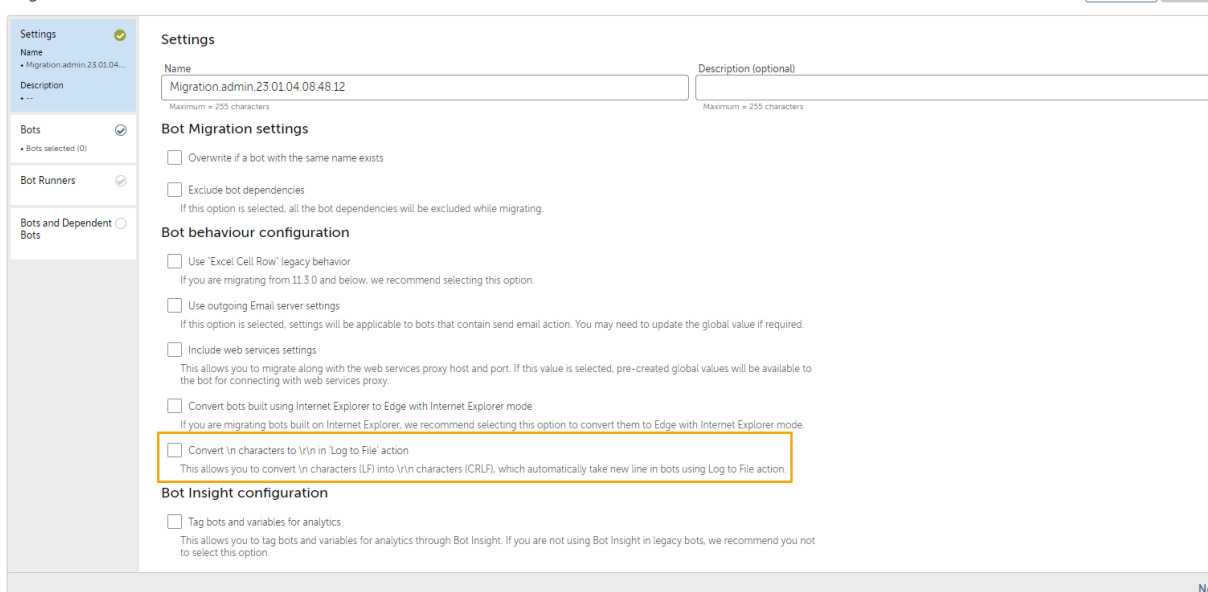

Migrate bots Cancel Migrate

**Settings**

Name: Migration.admin.23.01.04.08.48.12 Description (optional)  
Maximum = 255 characters Maximum = 255 characters

**Bot Migration settings**

Overwrite if a bot with the same name exists

Exclude bot dependencies  
If this option is selected, all the bot dependencies will be excluded while migrating.

**Bot behaviour configuration**

Use "Excel Cell Row" legacy behavior  
If you are migrating from 11.3.0 and below, we recommend selecting this option.

Use outgoing Email server settings  
If this option is selected, settings will be applicable to bots that contain send email action. You may need to update the global value if required.

Include web services settings  
This allows you to migrate along with the web services proxy host and port. If this value is selected, pre-created global values will be available to the bot for connecting with web services proxy.

Convert bots built using Internet Explorer to Edge with Internet Explorer mode  
If you are migrating bots built on Internet Explorer, we recommend selecting this option to convert them to Edge with Internet Explorer mode.

Convert \n characters to \r\n in 'Log to File' action  
This allows you to convert \n characters (LF) into \r\n characters (CRLF), which automatically take new line in bots using Log to File action.

**Bot Insight configuration**

Tag bots and variables for analytics  
This allows you to tag bots and variables for analytics through Bot Insight. If you are not using Bot Insight in legacy bots, we recommend you not to select this option.

bots. Next

[Improved automated editing ability for legacy bots](#)

Related reference

[Automation 360 v.27 Release Notes](#) on page 182

[Automation Workspace v.27 release](#) on page 185

Review what's new and changed, and the fixes and limitations in Automation Workspace for the v.27 release.

[Updating to v.27 release](#) on page 214

Review requirements and support information about updating your Control Room and Bot Agent for the v.27 release.

## Remote agent v.2.1.0 updates

A new version of the Remote agent is released with Automation 360v.27. This section includes the fixes for Remote agent version 2.1.0.

## Fixes

When a bot keeps running for a few hours, an error no longer occurs due to high memory usage with the Recorder package version 2.9.2 or later.

Previously, an increase in memory usage caused the bot to fail after a few hours with a `Java heap space` error.

Service Cloud case ID: 01911565

An error no longer occurs when you use Recorder package 2.8.6 and later versions to perform a click operation on a link element that opens a pop-up window on a web page running in Microsoft Edge with IE mode.

Service Cloud case ID: 01845776, 01858872, 01923003

When you install the AARemoteAgent\_2.0, the DLL files are now copied to the correct **A360 Remote Agent** folder and the AARemoteAgent\_2.0 runs properly. Previously when you installed the AARemoteAgent\_2.0, the DLL files were copied to an incorrect **A360 Remote Agent\Java** folder.

Service Cloud case ID: 01935630

In the Recorder package, you can now use the **Left click**, **Right click**, and **Set Text** with delay actions for cross-domain IFrames to automate web pages on Google Chrome and Microsoft Edge browsers with Manifest V3 extensions. Previously, these actions were not working for cross-domain IFrames with Manifest V3 extensions.

In the Recorder package, you can now use the **Click** action for the Link and Form tag controls that have inline scripting with JavaScript using Manifest V3 extensions.

When you use the **Recorder > Capture** action to automate Citrix virtual apps running on Google Chrome and Microsoft Edge browsers, add a delay of 60 seconds and run the bot, then if the object does not exist, the bot waits for the specified time (60 seconds) in the **Keep trying for (seconds)** field before executing the next steps.

## Process Discovery v.27 release

Review what's new in Process Discovery for the v.27 release.

### What's new

#### PEG Serverless

With support of up to 100 simultaneous sensors, businesses can easily redact sensitive data at scale before the data is sent to the Process Discovery platform. Businesses can run Process Discovery data collection across multiple teams simultaneously, while still providing one interface for IT Admins to manage the configuration, and one interface for the business to review the redactions.

#### PEG Configuration UI

IT Admins can easily manage forwarding configurations, redaction configurations, and export logs from a web UI instead of having to run commands on the command line.

[Configure PEG image redaction](#) on page 3867

## Fixes

Discovery Bot admins can now view all created processes without having the Discovery Bot recorder license.

Previously, if a Discovery Bot admin did not have a Discovery Bot recorder license and was using Automation 360 v.24, v.25, or v.26, all created processes did not display on the Processes page.

Service Cloud case ID: 01859123, 01877311, 01860901

### Related reference

[Automation 360 v.27 Release Notes](#) on page 182

[Automation Workspace v.27 release](#) on page 185

Review what's new and changed, and the fixes and limitations in Automation Workspace for the v.27 release.

[Automation Co-Pilot for Business Users v.27 release](#) on page 237

Review what's new and changed, and the fixes and limitations in Automation Co-Pilot for the v.27 release.

[IQ Bot and Document Automation v.27 release](#) on page 246

Review what's new and changed, and the fixes and limitations in IQ Bot and Document Automation for the v.27 release.

[Bot Insight v.27 release](#) on page 253

Review the fixes in Bot Insight for the v.27 release.

[Packages updated in v.27](#) on page 215

Review updates to the packages in Automation 360 v.27, including the compatible Control Room and Bot Agent versions.

## Automation Co-Pilot for Business Users v.27 release

Review what's new and changed, and the fixes and limitations in Automation Co-Pilot for the v.27 release.

## What's new

Smart embedded forms and dynamic data mapping for embedded widgets

You can now design your forms using a responsive and real-time canvas that can automatically adjust to the desired form size. This enables a faster way for you to create an embedded interface for use in any web application. You can also use these forms in your business applications to securely retrieve data when embedded as an iFrame widget.

To save time and eliminate data re-entry, you can use the postMessage API to map and pre-populate data from business applications in embedded widgets. Dynamic data mapping provides a safe and secure communication from your business (host) applications to the initial process forms in the widget.

[Smart embedded forms and dynamic data mapping](#) on page 3315

<p>Build forms easily by dragging elements to form builder</p> <p>You can now build your forms by just dragging your elements to a blank form builder. As you add elements to the form builder, it automatically adjusts without your input, letting you focus on the form-building experience. You can also re-size the columns of your elements.</p> <p><a href="#">Create a form</a></p>
<p>Map data in host web applications for Automation Co-Pilot (integrations)</p> <p>You can now map your host applications data to your AARI forms so that when you create a request, the initial form field will be automatically populated with the mapped data.</p> <p><a href="#">Map data from HTML to form</a> on page 3317</p>
<p>URL parameters support for iFrame widget</p> <p>You can use URL parameters to pass data types (date, time, number, and text box) through query parameters for your initial forms in the iFrame widget. Because the iFrame URL allows you to modify the URL to add data types, you can now directly populate data from a host application for form elements without having to keep re-entering the data.</p> <p><a href="#">Deploy automations in web application</a> on page 3310   <a href="#">Construct URL parameters for supported elements</a> on page 3426</p>
<p>Virtual window support for iFrame widget</p> <p>You can now run your bots in a virtual window (picture-in-picture view) for Automation Co-Pilot using embedded widget. With this option, you can run an attended bot in a small virtual window on your screen (instead of another desktop page or application) simultaneously while you complete tasks on the same page without obstructing your automation experience.</p> <p><a href="#">Deploy automations in web application</a> on page 3310   <a href="#">Configure a bot</a> on page 3397</p>
<p>Select tags in widget setup</p> <p>When you configure your widget in the <b>Integrations</b> page, the <b>Filter automations</b> option allows for you to select existing tags that can be added to your widget. You can now reference tags with the corresponding widgets in the <b>widgets</b> tab for easier reference in the <b>tags</b> column.</p> <p><a href="#">Setup iFrame widget using Automation Co-Pilot</a> on page 3303</p>
<p>View status and run time details in automation list</p> <p>You can now view the status and run time of your bots and processes in the automation list. The status and run time are based on your bots and processes last activities. You can quickly review whether a bot was completed in x amount of days or time ago, or shows no activity at all.</p> <p><a href="#">Deploy automations in web application</a> on page 3310</p>

#### AARI shortcut link

You can now access Automation Co-Pilot directly from your Automation Workspace. The **Explore AARI** link in the new **AARI** tab from the homepage is a shortcut that redirects you to the Automation Co-Pilot portal. This is an easier way for you to access Automation Co-Pilot if you forget how to access AARI or need to modify the URL to access Automation Co-Pilot.

[Deploy processes](#) on page 3375

#### New actions in the Process Composer

In the Process Composer, you can now use a set of actions when you build out your process. For example, you can double-click a task, such as **Bot Task** and **Human Task**, and the task will be updated in your process flow automatically. With this, you can save time because you do not need to task specific tasks to your process. In addition, you can now copy, cut, and paste using **CTRL + C**, **CTRL + X** and **CTRL + V**, respectively to retain, reuse, or replace data.

[Supported behaviors for tasks and elements in Process Composer](#) on page 3422 | [Create a process automation in Process Composer](#) on page 3454

#### Use a reference ID meta type in Process Composer

You can now use a reference ID with a **Meta** variable type for your variables in the Process Composer. When you set a reference ID as a meta variable type, you can now use your reference ID data when you run your tasks in the web interface. This simplifies your references because you only need to rely on using the reference ID instead of relying on other variable types or references.

[Create a process automation in Process Composer](#) on page 3454

#### Center your forms in preview

You can now preview your forms in the new preview window and get an accurate assessment on how your form will look when it is rendered. You can select the **Make form preview centered** option to enable the preview window. You can also set the appropriate display resolution, x and y coordinates, and even center your form.

[Create a form](#)

#### Upload images directly to the form composer

You can now upload images directly to the form composer by using the **Image** element. This saves you time to view the images in the form without a file reference, rather than in the initial step, where the image requires a file reference to be viewed.

---

**Note:** Image files are limited to 150 kb (like a logo).

---

[Using the Image element](#) on page 3443

#### Change label action for Button element

The change label action in the form rules now applies to the **Button** element. When you use the change label action in form rules and apply it to the buttons in your form, the changes will be automatically applied to the buttons where you set the rules. This keeps the flow consistent with the elements that you are using because all the buttons inherit the same rule.

[Conditional actions, rules, and elements](#) on page 3428

#### Rules editor for Table element

The rules editor is now applicable to the **Table** element. When you use the rules editor for your tables, the rules conditions are applied for each individual columns while any actions that you set are applied for each row in the row level. This makes things consistent for each new or existing row that you use because all the rows inherit the same rule.

[Conditional actions, rules, and elements](#) on page 3428

## What's changed

Build 16701: This build includes the following enhancement:

#### Enhanced automation experience in Automation Co-Pilot Desktop Assistant

We have improved the automation experience for your automation activities in Automation Co-Pilot Desktop Assistant.

- You must have the **Manage my activity** permission as a prerequisite to use the bot controls.
- When you run your automation, the bot, its progress page, controls for pause, start (resume), and stop, are all unified inside Automation Co-Pilot Desktop Assistant. Previously, there was a separate window for the bot run and its controls. (This will still be seen in this version but will be hidden in future releases.)
- You can view the status of your bot progress and its details, and is reflected on the activity page.
- You can view and manage pending automation that have been initiated and users can navigate between bot list view and progress view. If you have multiple Automation Co-Pilot Desktop Assistant instances or disconnect and then reconnect to a different instance, the pending automation will be visible from the progress page for you to control.

Service Cloud case ID: 01793119, 1815462

[Automation Co-Pilot Desktop Assistant automation activities](#) on page 3362

Build 16667: This build includes the following enhancements:



**Define tags in process configuration**

When you edit a process, you can use the **Tags** field to search and specify tags based on keywords, to define your process. You can add tags from new or existing tags and use them to reference specific tags related to your process.

[Configure a process](#) on page 3398

## Fixes

Build 16701: This build includes the following fixes (along with fixes from the previous builds):

In Automation Co-Pilot Desktop Assistant, you can continue your pending automation in different Automation Co-Pilot Desktop Assistant instances. Automations are no longer stuck, and you can run bots as usual.

Service Cloud case ID: 01829572

**Note:** This fix was first included with Build 16694 for Cloud Sandbox and Community Edition. Build 16701 now includes this fix for Cloud, Cloud Sandbox, and Community Edition.

Build 16685: This build includes the following fixes (along with fixes from the previous builds):

When bots have a file dependency or an interactive form that includes any multibyte character in its name, the bots run as expected. Previously, having the multibyte character in a form name caused an error.

Service Cloud case ID: 01947340

Build 16667: This build includes the following fixes:

You can now view signatures when you preview files using the AARI document viewer. Previously, signatures could be viewed only when files were opened in a separate tab.

Service Cloud case ID: 01879533

Bots are no longer triggered when you modify a file in an authenticated network. Previously, bots would trigger when you modified a bot in a network that required authentication.

Service Cloud case ID: 01256344, 01756709, 01854164, 01888188

The resiliency of the **Create > Request** action has improved in the Process package.

Service Cloud case ID: 01886231

You can add, delete, and change values to the column cells when you create forms using the Column Filter function. Previously, an error altered the accuracy of this operation by sometimes changing rows or filtering newly edited values.

Service Cloud case ID: 01854490, 01941416

<p>When scrolling past 100 task bots in Automation Co-Pilot Desktop Assistant page, fresh bots now load to successfully complete the list of bots not yet displayed.</p> <p>Service Cloud case ID: 01804139, 01845208, 01881927</p>
<p>You can select Reference ID as a Meta variable type from the Variable drop-down list.</p> <p>Service Cloud case ID: 01861551</p>
<p>When you enter data in a password field in the initial form, the password field retains your data after you submit the form without requiring you to re-enter the data.</p> <p>Service Cloud case ID: 01846222</p>
<p>When you use a file element to select multiple files, the file element functions properly without having to reset the form.</p> <p>Service Cloud case ID: 01840888</p>
<p>Buttons in forms work as expected. Previously, some users encountered an exception error and were unable to click <b>Confirm</b> to submit their form.</p> <p>Service Cloud case ID: 01846856</p>
<p>When you run a bot in Automation Co-Pilot, you can edit the auto-populated fields after you select an option from the drop-down menu.</p> <p>Service Cloud case ID: 01853623</p>
<p>When you use a number element and enable the <b>Use comma to separate thousands</b> format option, the bot will run without issues. Previously, some users encountered an exception error.</p> <p>Service Cloud case ID: 01869566</p>
<p>When you use the <b>File modified trigger</b> option to modify the contents or files, the trigger works properly.</p> <p>Service Cloud case ID: 01812596</p>
<p>When you use a document element in your form to upload PDF files, the PDF files that are uploaded renders the contents properly.</p> <p>Service Cloud case ID: 01802898, 01833266</p>

## Known Limitations

<p>Image files uploaded to forms for access in the Process Composer are limited to 150 kb.</p> <p><a href="#">Example: Use Select File to upload or download a file for web</a> on page 3473</p> <p>Service Cloud case ID 01922815</p>
--

## Updates to the interface

**Automation Co-Pilot**

The form builder now automatically adjusts the size for each form element you drag into the canvas. The sizes can also be manually adjusted.

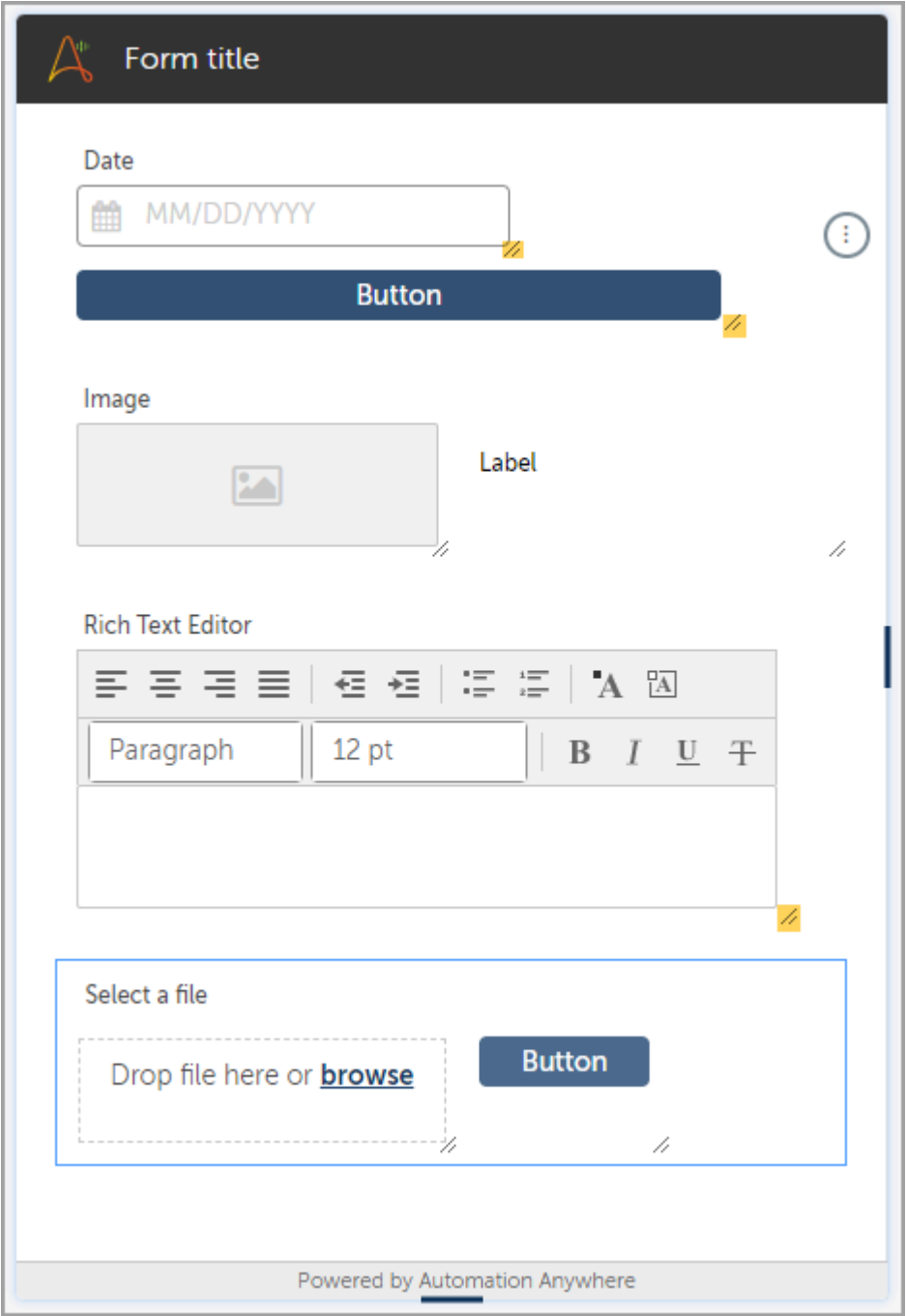

The screenshot displays the Automation Co-Pilot form builder interface. At the top, there is a dark header with the Automation Anywhere logo and the text "Form title". Below the header, the canvas contains several form elements: a "Date" field with a calendar icon and the placeholder "MM/DD/YYYY"; a dark blue "Button"; an "Image" field with a placeholder icon and a "Label" text; a "Rich Text Editor" with a toolbar containing icons for text alignment, indentation, bulleted and numbered lists, bold, italic, underline, and link, along with a "Paragraph" dropdown and a "12 pt" font size field; and a "Select a file" section with a dashed box containing the text "Drop file here or [browse](#)" and a dark blue "Button". Each element has a small yellow icon in its bottom right corner, indicating it can be manually adjusted. A vertical blue bar is visible on the right side of the canvas. At the bottom of the canvas, it says "Powered by Automation Anywhere".

Build forms easily by dragging elements to form builder

Automation Co-Pilot

The **Tags** field in the Edit Process page now has a drop-down menu for you to create new or select from existing tags.

### Edit Process: 35 - Returns

General Teams Deployment

Process name

Returns

Maximum 255 Characters



Description ( Optional )

Maximum 1024 Characters

Process key ⓘ

Enter 1-5 alphabetical characters. Once saved, the Process Key cannot be changed.

Tags

Account × Workspace × | Select tags  

Support

Account

Salesforce

Workspace

by user

by bot

[Define tags in process configuration](#)

**Automation Co-Pilot**

The **Filter automations** field in the Add Widget page has a drop-down menu for you to select existing tags.

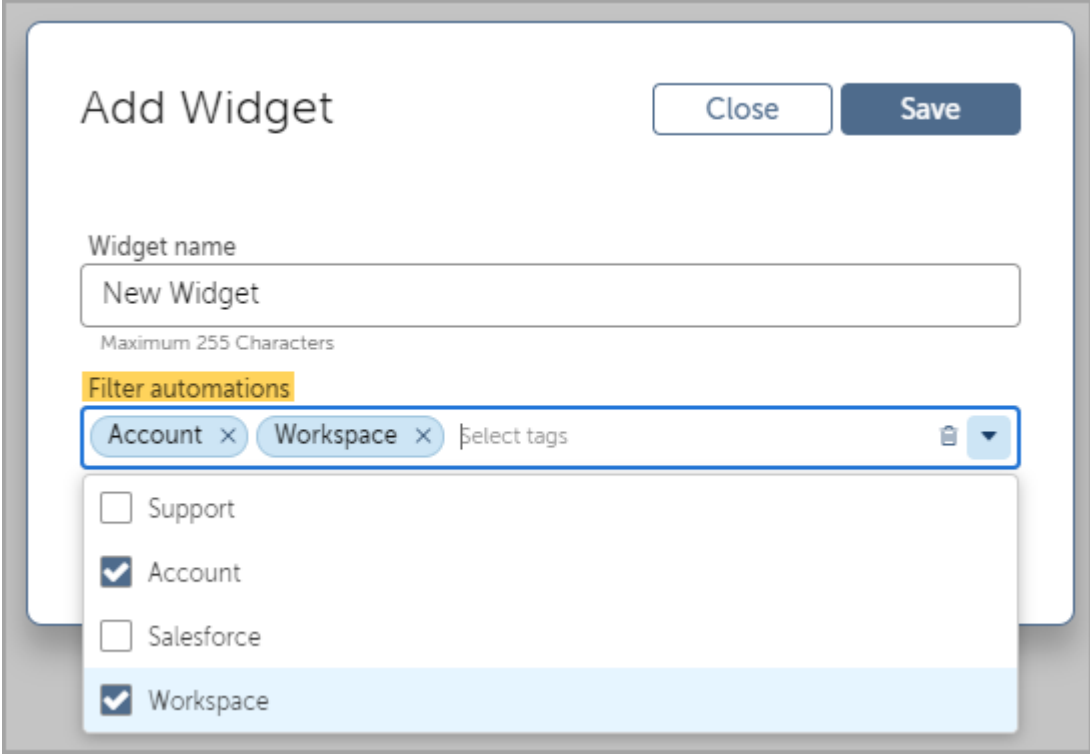

Select tags in widget setup

Related reference

[Automation 360 v.27 Release Notes](#) on page 182

[Automation Workspace v.27 release](#) on page 185

Review what's new and changed, and the fixes and limitations in Automation Workspace for the v.27 release.

[Process Discovery v.27 release](#) on page 236

Review what's new in Process Discovery for the v.27 release.

[IQ Bot and Document Automation v.27 release](#) on page 246

Review what's new and changed, and the fixes and limitations in IQ Bot and Document Automation for the v.27 release.

[Bot Insight v.27 release](#) on page 253

Review the fixes in Bot Insight for the v.27 release.

[Packages updated in v.27](#) on page 215

Review updates to the packages in Automation 360 v.27, including the compatible Control Room and Bot Agent versions.

## IQ Bot and Document Automation v.27 release

Review what's new and changed, and the fixes and limitations in IQ Bot and Document Automation for the v.27 release.

### Document Automation

What's new
<p>Standard forms integrated with Document Automation</p> <p>You can create and manage learning instances entirely within Document Automation. Previously, you had to create standard form learning instances in IQ Bot and then process them through the <b>Connect Learning Instance</b> feature in Document Automation. With standard forms integrated with Document Automation, you benefit by having an entire workflow consolidated into a single system.</p> <p><a href="#">Create custom models in Document Automation using Standard Forms</a> on page 3693.</p>
<p>Support for Microsoft Form Recognizer v3.0 models in Document Automation</p> <p>Microsoft Form Recognizer v3.0 provides additional capabilities to the existing model creation, including options to select <b>Template</b> and <b>Neural</b>. While training a model, you can select either 2.1 or 3.0 version.</p>
<p>New Document Automation product licenses</p> <p>Document Automation now offers the following licenses to enable users to process documents and track metrics for learning instances in production:</p> <ul style="list-style-type: none"> <li>• Document Automation Standard Forms (Number of pages): Required to create a model and process documents in a Standard form in Document Automation.</li> <li>• Document Automation 360 Extraction (Number of pages): Required to process documents in an Automation Anywhere (Pre-trained) model, including the User-defined document type.</li> </ul> <p>Also, there are updates to license consumption tracking.</p> <p><a href="#">License tracking release note</a></p>
<p>Extract data with Google Vision OCR</p> <p>If you are a user with a Cloud Control Room, you can process documents using Google Vision OCR technology by creating or updating a learning instance.</p>

What's new
<p>Improved table extraction in Automation Anywhere models</p> <p>You can use validation feedback to train a learning instance to extract data from a cell that contains more than one field.</p> <p>For example, if a product description column also includes item number, you can outline the item number in the Validation interface. When the learning instance processes subsequent documents, it will extract the item number and ignore the product description.</p> <p><a href="#">Using validation feedback to extract specific values in a table</a> on page 3664</p>
<p>Visualize performance metrics with a new Document Automation widget</p> <p>You can view data visualizations on Validator user performance. This new widget is a horizontal bar chart that shows the weighted average time each Validator user spent performing manual validation per document.</p> <p><a href="#">Document Workspace dashboard</a> on page 3937</p>
<p>Document Automation supports regular expression pattern-based extraction</p> <p>When configuring fields that the learning instance will extract, you can specify a regular expression (regex) pattern to help the extraction engine find the field. After entering the regex pattern you can test the expression using sample content within the <b>Create Learning instance</b> window. You can use regex pattern extraction for values that follow a specific pattern, such as a VAT number or a PO number.</p>
<p>Validation interface support for shortcut keys</p> <p>Zoom in and out on documents in the Validation interface by holding the Alt key and scrolling with your mouse wheel.</p>

What's changed
<p>The following updates impact how the Control Room tracks license consumption:</p> <ul style="list-style-type: none"><li>• The Control Room checks enough product licenses prior to deploying the bot.</li><li>• The IQ Bot Pages license and the Standard Forms Pages license track documents that are processed through learning instances created in Automation 360 IQ Bot. This includes documents processed in the learning instance in Automation 360 IQ Bot and learning instances connected to Document Automation.</li><li>• In the Licenses page, the Document AI license is called the Google Document AI (number of documents)</li><li>• The Control Room also tracks documents processed in Google Document AI for users who brought their own license. Previously, the Control Room only tracked such documents for users who bought their licenses through Automation Anywhere.</li></ul>
<p>You can now configure Oracle Database with on-premises and Linux installations of Document Automation.</p>
<p>When you import a learning instance created in previous versions of Document Automation, the check box to send validation feedback to the system is now not selected by default. You must edit the learning instance to select the check box.</p>

Fixes
Build 16694: This build includes the following fixes (along with fixes from the previous builds):
Now users with either the Standard Forms for Document Automation or the Standard Forms (for IQ Bot) licenses can create a Standard Forms model in Document Automation.
Build 16685: This build includes the following fixes:
The Bot Agent now clears out the resources folder after running actions from the Document Extraction package.
When you import a learning instance created in a previous version of Document Automation, the <b>Improve accuracy using validation</b> check box is now unselected by default.
Document Automation now correctly tracks license consumption in all On-Premises installations, irrespective of the port number.
You can now add formula validation to learning instances with the user-defined document type.
Standard forms in Document Automation is now supported in a fresh installation or upgraded multi-tenant Control Room. Previously, Standard forms in Document Automation was only supported on a fresh installation of a multi-tenant Control Room.
When you refresh the Validator page, the Validator displays the last document you worked on. Previously after a page refresh, the Validator sometimes displayed the first document you had validated.
Bot Runner devices configured with a proxy can successfully run actions from the Document Extraction package.
Service Cloud case ID: 01856276, 01862174, 01911425

Limitations
Standard forms only support unique field extraction for any document. If there are fields with the same name on multiple pages, then the document must be trained with different tag names in the model creation tool. For example, if there is a field named <code>date</code> on two different pages, then you must use <code>date1</code> and <code>date2</code> to make the tag names unique in the model creation tool for training.
You cannot use spaces in model names when you create models for Standard forms v3.0. If the model name contains any spaces, then an <code>InvalidParameter</code> error message is generated.
There is no average accuracy for standard forms v.3.0 from the Microsoft Azure Form Recognizer service. As a result, the standard forms training displays the average accuracy as 0.00% for the v.3.0 service.
When fetching a Standard Forms model, an incorrect error message displays when no configurations are available in Document Automation.



Limitations
The resizing functionality is not working properly for the model list table. As a result, you cannot resize the table header or column in Standard Forms.
The run analysis result does not display in standard forms when creating a v.3.0 model with multipages.
There is a default character limit of 100 characters for the table name, and 155 characters for the field name of the table. However, if you reconfigure the table, you can add more characters than the default limit.
The System-Identified Regions (SIRs) for checkboxes or radio buttons are not generated for the standard forms v.3.0 model.
Standard forms is not supported on Linux.
Any re-mapping or re-drawing in the System-Identified Regions (SIRs) in the Validator results in detection of an incorrect check box. However, you can enter the check box value as <b>checked</b> or <b>unchecked</b> after changing the auto-generated mapping.
When migrating a learning instance from one Control Room to another, the same user must export and import the .dw file.
If the learning instance extracts data from a multi-line field and transfers it to a CSV file, an extra space is added at the end of each line.
When you mouse over data points in the "Average validation time" and "Validator performance by number of documents" widgets, the correct values do not immediately display in the pop-up window.
Document Automation prevents you from creating a learning instance if you create a custom table field without providing a field name and field label, even if you have unselected the field.
If you click <b>Test regular expression</b> and replace the value in the <b>Regular expression</b> field, the field now has a limit of 50 characters.  Workaround: Click <b>Cancel</b> to leave the Test regular expression window and make the revisions in the <b>Regular expression</b> field.
The <b>Table</b> icon is not generated on the Form OCR Testing Tool (FOTT) for the Standard form v3.0 Model.
If a field name contains more than 100 characters, the scroll bar does not appear and you cannot see the value of the form field.
If a table name contains more than 50 characters, you cannot expand the table size. Additionally, the field name in the table does not display when you hover over it.
If you test an invalid Python script when configuring custom logic, the system returns an error message that contains the Python execution path.

Limitations
Sometimes document extraction fails and one of the following error messages appear in the Automation Co-Pilot request status: <b>Extraction bot failed. Please check activity/audit logs for more detail</b> or <b>Download bot failed. Please check activity/audit logs for more detail</b> with this message in the audit log: <b>Existing deployment in progress for this user session.</b> If this happens, restart the Bot Agent on the impacted device.
The Document Workspace dashboard sometimes shows incorrect page consumption metrics if the Control Room is installed On-Premises.
Documents cannot be processed with Google Vision OCR if your proxy is configured with a Proxy Auto-Configuration (PAC) file.
When you create or edit a Learning Instance, if a field name starts with a numerical value, then the formula validation for that field fails. This issue applies to form fields and table fields.
If you import a learning instance with the validation feedback option disabled, the validation feedback option becomes enabled and you must manually edit the learning instance to disable the option.
For Standard Forms, when a document with multiple pages is processed and enters into validation, one page is being duplicated in the Validator even when the System-Identified Regions (SIRs) in the Validator are correct.

## IQ Bot

What's changed
If you are using an older version of Microsoft SQL Server that does not support TLS 1.2, then you must keep an IQ Bot database backup and update to a Microsoft SQL Server version that supports TLS 1.2.
IQ Bot now uses the latest version of Python (3.11.0) for custom logic validation. To use the latest version, you must upgrade from cx_Oracle 8.3 to python-oracledb. See <a href="#">Upgrading from cx_Oracle 8.3 to python-oracledb</a>

Fixes
IQ Bot now performs post-processing on fields with Python custom logic that contain single quotation marks, such as <code>print('Test')</code> .
In IQ Bot, when a document is either corrupted, deleted, or is not loading in Validator or Designer, a placeholder image is displayed. The applications will not be consistent until you upload new documents. Service Cloud case ID: 00792976, 00835371

Fixes
<p>During the production process, you must not move the learning instances or bots from Staging to Production, or vice-versa.</p> <p>Service Cloud case ID: 01808931, 00821541, 01253373, 00836954, 01271722</p>
<p>When you upload any invalid document in manual or custom groups, then the document gets processed. However, the System Identified Region (SIR) will not be generated for the unsupported pages.</p> <p>Previously, when an invalid document was uploaded with a valid document and processed for extraction, the <b>See extraction</b> page kept loading.</p> <p>Service Cloud case ID: 01786098</p>
<p>In Healthcheck API, the output shows the proper branch name convention, for example: RC-A360.27. Previously, improper health information was displayed when the branch name convention was heads/RC-A360.27.</p>
<p>If an error or exception is encountered during document validation, the error or exception is processed, and the files are displayed consistent in the output.</p> <p>Service Cloud case ID: 00827940</p>
<p>In IQ Bot, if the RabbitMQ v3.8.17 and v3.8.18 is not working, then the log directory location can now be changed by updating the system environment variable as RABBITMQ_LOG_BASE. If this variable is provided manually with the required directory location, then the logs are created and updated in a new location. Previously, the configuration given for the log.dir variable in rabbitmq.conf file did not support RabbitMQ v3.8.17 and v3.8.18.</p> <p>Service Cloud case ID: 01844995</p>
<p>The system-identified regions (SIRs) are now generated for manual groups when the PDFBox is enabled. Previously, when the PDFBox was enabled, during Learning Instance creation the SIRs for some vector PDFs were not generated for manual groups.</p> <p>Service Cloud case ID: 01844223, 01849638</p>
<p>You cannot import an IQ Bot archive (IQBA) file when the designer for the same Learning Instance is open in another window. Previously, the import was failing because the LockedTimestamp field in the <b>visiobotDetails</b> table had a value at the time of IQBA export. This caused an error because the LockedTimestamp field was expecting a null value.</p> <p>Service Cloud case ID: 01818474</p>

Limitations
<p>During the express installation upgrade of IQ Bot, an error message is shown in the installation steps. You must click <b>OK</b> to proceed further.</p>
<p>The maximum upload file size limit is set to 5 GB when importing and exporting files in the IQ Bot archive (IQBA) file. If the file size is greater than 5 GB, then you must delete unwanted groups to decrease the file size and migrate successfully.</p>

Limitations
If the IQ Bot archive (IQBA) file size is above 2,147,483,647 bits, then the File Storage does not upload the exported file from output folder to the desired location.
Sometimes, the PDFBox is unable to detect PDF (Portable Document Format) documents accurately. We recommend that you use Adobe Acrobat to convert the documents to PDF before you upload it to IQ Bot.

## Updates to the interface

**IQ Bot and Document Automation**

The Create learning instance window now contains a drop-down menu to select an OCR provider.

[Cancel](#) [Next](#)

### Create Learning Instance

▲ Name

Description (optional)

Document Type

Language

Provider

OCR Provider

The system learns from user-provided changes in the Validator.

[Extract data with Google Vision OCR](#)

Related reference

[Automation 360 v.27 Release Notes](#) on page 182

[Automation Workspace v.27 release](#) on page 185

Review what's new and changed, and the fixes and limitations in Automation Workspace for the v.27 release.

[Process Discovery v.27 release](#) on page 236

Review what's new in Process Discovery for the v.27 release.

[Automation Co-Pilot for Business Users v.27 release](#) on page 237

Review what's new and changed, and the fixes and limitations in Automation Co-Pilot for the v.27 release.

[Bot Insight v.27 release](#) on page 253

Review the fixes in Bot Insight for the v.27 release.

[Packages updated in v.27](#) on page 215

Review updates to the packages in Automation 360 v.27, including the compatible Control Room and Bot Agent versions.

## Bot Insight v.27 release

Review the fixes in Bot Insight for the v.27 release.

### Fixes

In the Bot Insight **Operations > Bots Dashboard**, the bot duration shows the correct data. Previously, there was a mismatch between the bot duration data and the manual calculation of the bot duration from the historical menu because of a start time mismatch.  
Service Cloud case ID: 01796106

When you upgrade to Automation 360 v.27 and launch the Control Room, no kernel bootup failure occurs due to a failed Elasticsearch initialization. Thus, it does not show the **Bad Gateway** error. As a result, the Control Room service is available and you can access the Control Room URL.  
Previously, Elasticsearch initialization failed during startup which was causing the kernel bootup failure. As a result, the Control Room service was showing the **Bad Gateway** error.  
Service Cloud case ID: 01908667, 01919727, 01919309, 01911464, 01921747, 01926887, 01925309, 01924168, 01929814, 01930226, 01931125, 01925270, 01934212, 01938106

You can check out and republish the dashboard with a new name for a specific bot after import it into the public workspace.

---

**Note:** In case of public import, you must run the bot at least one time before you export it.

---

Previously, you could not publish the dashboard for a specific bot even if it was checked in.  
Service Cloud case ID: 01763067

## Updates to the interface

Bot Insight
<p>The Bot Insight user interface is changed as per Common Frontend Component (CFC) standards. Only the look and feel of the components (such as colors, fonts, icons, paddings, borders, buttons, and so on) is changed, while the underlying functionality remains the same. You can view these changes from the following user interface elements:</p> <ul style="list-style-type: none"><li>• All Bot Insight pages</li><li>• Table pagination position at the center of the page</li><li>• The <b>Create widget</b> dialog back drop with the <b>Close</b> button</li><li>• <b>Add Widget</b> title in the <b>Create widget</b> dialog</li><li>• The <b>Switch Widget</b> button position in the <b>Add widget</b> window for all charts</li></ul>

Related reference

[Automation 360 v.27 Release Notes](#) on page 182

[Automation Workspace v.27 release](#) on page 185

Review what's new and changed, and the fixes and limitations in Automation Workspace for the v.27 release.

[Process Discovery v.27 release](#) on page 236

Review what's new in Process Discovery for the v.27 release.

[Automation Co-Pilot for Business Users v.27 release](#) on page 237

Review what's new and changed, and the fixes and limitations in Automation Co-Pilot for the v.27 release.

[IQ Bot and Document Automation v.27 release](#) on page 246

Review what's new and changed, and the fixes and limitations in IQ Bot and Document Automation for the v.27 release.

[Packages updated in v.27](#) on page 215

Review updates to the packages in Automation 360 v.27, including the compatible Control Room and Bot Agent versions.

## Automation 360 v.26 Release Notes

Release date: 6 October 2022

Review the top 5 features as well as other new features, enhancements, fixes, and limitations in the Automation 360 v.26 release. Automation 360 and IQ Bot are on Build 15459 (for On-Premises and Cloud).

We have released updated builds for fixes after the Automation 360 v.26 GA build, which was Build 15436. For information about the fixes in these updated builds, see [Updated release builds](#) on page 257.

---

**Note:** The release builds include Manifest V3 browser extensions for Google Chrome and Microsoft Edge browsers. For more information, see:

- [Chrome and Edge Manifest V3 extensions](#) on page 1138
- [Support for Manifest V3 extensions](#)

- [Browser extensions for Automation 360](#) on page 985

## Highlights of this release

Here are the top 5 features in the v.26 release:

Embedded automation with OAuth 2.0

Business users can directly access authorized automation from within their favorite business applications, without having to open a new interface or learn a new app. OAuth 2.0 enables seamless authentication across systems, reducing complexities of system-specific sign-ins.

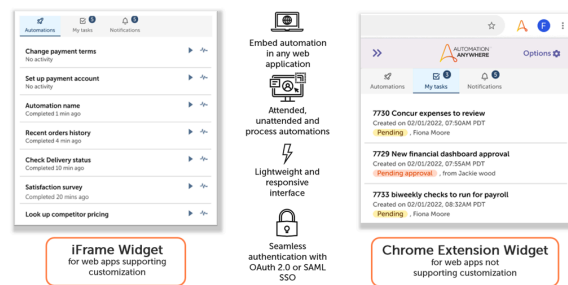

Learn more: [Embed automations in your application using Automation Co-Pilot](#) on page 3298.

Coding standards through code analysis

Administrators can establish coding best practices by setting a code analysis policy and improve their team's code to quickly find and correct rule violations. They can select which rules to check for and enable summary reports for a snapshot of all bots within a project.

Bot builders can quickly check the status of their bots and receive feedback on what to fix, speeding up bot development and deployment and promoting coding best practices.

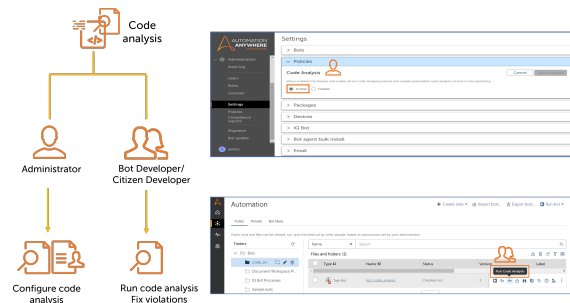

Learn more: [Code analysis](#) on page 2178.

Package role-based access (RBAC)

Administrators can tailor package access to the business needs and expertise of bot developers and enforce access policies for custom groups. They can maintain policy control and ensure confidence and ease-of-use for developers by providing group-based package access with clear policies.

Citizen developers can access simpler packages and build easy-to-complete automation, and professional developers can access a broader set of complex packages.

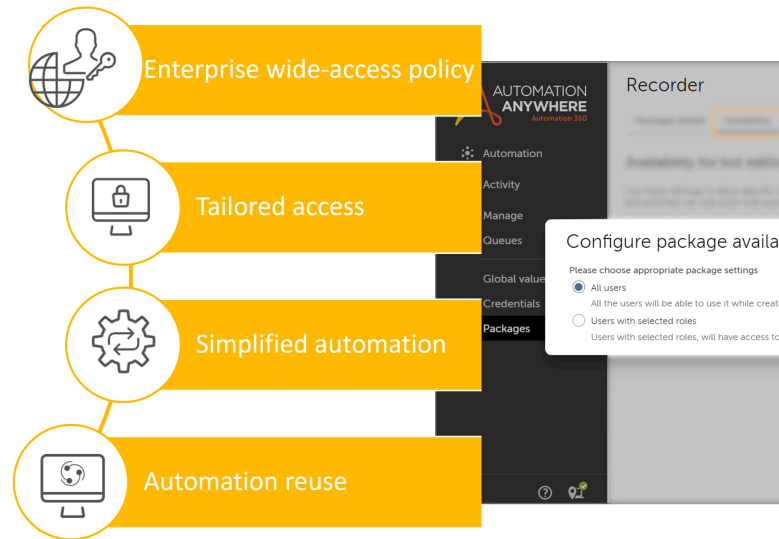

Learn more: [RBAC on packages](#) on page 1899.

Salesforce integration with command package

RPA developers can build robust integrations with Salesforce through direct API interaction. They can automate repetitive processes involving access and updates to Salesforce data, enabling business users to focus on high-value business tasks such as strategic planning and optimization. Commands available include authentication, database querying, record updates, and file processing.

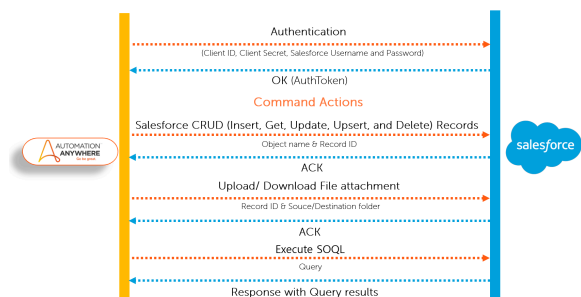



Learn more: [Salesforce package](#) on page 2973.

Automation 360 integration with Google Cloud Apigee

RPA developers can fast-track end-to-end automation development by combining API components from Apigee and RPA bots from Automation 360 to access any data in the enterprise. Our prebuilt integration packages make the integration seamless, enabling you to drive more value from reusing existing assets created by your organization's automation teams.

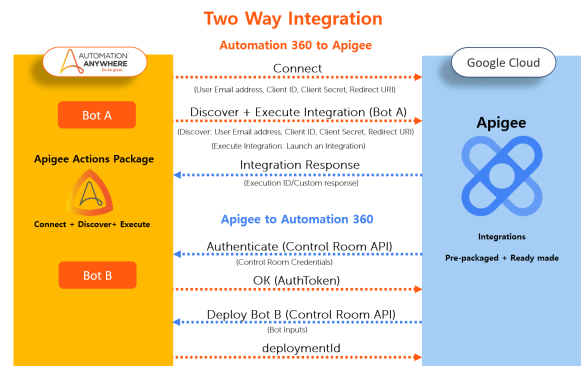

Learn more: [Apigee integration](#).

## Updated release builds

We have released the following updated builds:

- Build 15459 Service Cloud case ID: 01941769, 01945068

This build is updated to include a critical security fix for the issue related to Multi-Factor Authentication (MFA) when used with database authentication. This vulnerability is not applicable when using SAML or AD authentication. For more information on this security fix, see [Unexpected behavior observed with Two Factor Authentication post A360.26 upgrade, where a valid authenticator code alone is sufficient to login to CR, in spite of an incorrect password](#).

**Note:** This issue exists only in Automation 360 v.26 release. For v.26 On-Premises customers using or planning to use MFA with database authentication, we recommend that you install this update at your earliest convenience. No action is required from customers on other Automation 360 releases.

- Build 15450 with fixes for the following issues:
  - When you import a bot or file that is a manual dependency of other bots using the overwrite option, the import process no longer removes the dependencies from the other bots (Service Cloud case ID: 01911410, 01920508).
  - When you have large and complex bots with many dependencies and if the size of the deployment messages that are sent from the Control Room to the Bot Agent is more than 2 MB, the bots run successfully. (Service Cloud case ID: 01882630).
  - The following IQ Bot issues were fixed:

- IQ Bot can now perform post-processing on a field if the custom logic uses Python script containing single quotes, such as `print ('Test')`.
- If your IQ Bot custom logic uses the Pandas library, the script no longer needs to have the `import Pandas` statement.
- IQ Bot can now perform post-processing on a field if the custom logic uses Python script containing characters from non-Latin languages (Unicode characters), such as `äöüñž`.
- Security fixes for Cross-Site Scripting (XSS) vulnerabilities (Service Cloud case ID: 01843148).
- Build 15443 (for US-East and US-West regions only) Service Cloud case ID: 01911410, 01920508

This build is updated to include a fix for the issue related to the manual dependency file that is shared between multiple parent bots upon export and import. If one of the child bot files is exported and imported into the Control Room with overwrite options in the import process, then links to the manual dependency are unlinked from other parent bots. Use Bot Agent version 21.222 for this issue.

- Build 15439 (Japan region only) Service Cloud case ID: 01911093, 01911209, 01911190, 01911116, 01911259

This build is updated to include a fix for the following issue: `Cannot retrieve values assigned to global values having Japanese characters after upgrading Automation 360`. Build 15439 is available for download for On-Premises customers who need this fix.

## What's new and changed in each product

Go to the following pages for details on all the updates (what's new, changed, fixed, and limitations) in each product:

<a href="#">Automation Workspace</a> <ul style="list-style-type: none"> <li>• <a href="#">Updating to this release</a></li> <li>• <a href="#">Migration updates</a></li> </ul>
<a href="#">AARI</a>
<a href="#">IQ Bot and Document Automation</a>
<a href="#">Bot Insight</a>

Related concepts

[Packages available in Automation 360](#) on page 2316

Actions are grouped into version-specific packages. Bot Creators can select which package version to use for a specific bot.

Related reference

[Automation Workspace v.26 release](#) on page 259

Review what's new and changed, fixes and limitations, and the feature deprecations in Automation Workspace for the v.26 release.

[Automation Co-Pilot for Business Users v.26 release](#) on page 286

Review what's new and changed and the fixes in Automation Co-Pilot for the v.26 release.

[IQ Bot and Document Automation v.26 release](#) on page 288

Review what's new and changed, and the fixes and limitations in IQ Bot and Document Automation for the v.26 release.

[Bot Insight v.26 release](#) on page 296

Review what's changed and the limitations in Bot Insight for the v.26 release.

## Automation Workspace v.26 release

Review what's new and changed, fixes and limitations, and the feature deprecations in Automation Workspace for the v.26 release.

### What's new

Control Room, devices and Bot Agent
<p>Microsoft Windows 11 Enterprise now supported (Service Cloud case ID: 01252605, 1252605, 1253745, 01255134, 01379865, 01801610, 01810148)</p> <p>We now support Microsoft Windows 11 Enterprise, so you can now install and update the Bot Agent and run bots on the Windows 11 Enterprise operating system.</p> <p><a href="#">Bot Agent compatibility</a> on page 1332</p>
<p>Support for Manifest V3 extensions</p> <p>Automations that use Google Chrome Manifest V2 based extensions will stop working sometime after June 2023. The deprecation timelines of Manifest V2 based extensions are currently under review and subject to change by Google.</p> <ul style="list-style-type: none"> <li>• For Google Chrome Manifest V2 extensions timelines, see <a href="#">Manifest V2 support timeline</a>.</li> <li>• For Microsoft Edge Manifest V2 extensions timelines, see <a href="#">Overview and timelines for migrating to Manifest V3</a>.</li> </ul> <p>This might impact your existing automations that use Manifest V2 based extensions for Google Chrome and Microsoft Edge browsers. Automation 360 v.26 and later includes Manifest V3 extensions by default to support features that use Google Chrome and Microsoft Edge browsers.</p> <p>You can automatically enable Manifest V3 based extensions for Google Chrome and Microsoft Edge on all the Bot Runner devices by enabling the <b>Browser extensions</b> option from the Control Room. Enabling this option applies the browser extension settings on all the registered Bot Agent devices.</p> <hr/> <p><b>Note:</b> We will continue to support Manifest V2 based extensions for Google Chrome until June 2023. To know about Microsoft Edge Manifest V2 based extensions timelines, see <a href="#">Overview and timelines for migrating to Manifest V3</a>.</p> <hr/> <p><b>Note:</b> Manifest V3 extension is supported on Google Chrome and Microsoft Edge browsers version 91 and later only.</p> <hr/> <p><a href="#">Configure browser extensions</a> on page 1799   <a href="#">Chrome and Edge Manifest V3 extensions</a> on page 1138</p>

**Control Room, devices and Bot Agent**

Bot Agent updates by using installation file from local drive

You can now download the Bot Agent installation file to your local drive as a one-time activity and then update the Bot Agent on several devices by providing the local drive path to the installation file. This way, you can avoid downloading the installation file multiple times from the Control Room for several devices.

**Important:** This functionality is implemented in v.26 and can be used from v.27. That is, after you update your Bot Agent to v.26, future updates can be performed from the local drive.

[Automatically update the Bot Agent](#) on page 1361 | [Update the Bot Agent from a local drive](#) on page 1364

Oracle Database now supported (Service Cloud case ID: 00726728)

We now support Oracle Database, so you can now choose to install the Control Room on Oracle Database.

**Note:** Oracle database for Control Room installation is supported only in Custom mode and not in Express mode. Oracle Database support on the Control Room starts with the v.26 release.

[Installing Control Room using custom mode for Oracle installation](#) on page 1268 | [Configure Oracle database type and server](#) on page 1258 | [Database requirements](#) on page 1188

Active Directory mappings filters stored in the database

When you update to a newer version of the Control Room, you no longer have to define the Active Directory mapping filters again after installation. This is because the Active Directory mapping filters defined in the `um.properties` file are now stored in and can be referenced from the database. However, if you define new filters in the `um.properties` file, the Control Room references the filters defined in the `um.properties` file and overwrites the ones stored in the database.

Packages, actions, and Bot editor
<p>RBAC on packages</p> <p>Based on your business requirements, you can now control the access that Bot Creators have to packages in the Control Room. As an administrator or user with the <b>Manage</b> package permission, you can restrict access to packages to either all the users or users with specific roles.</p> <p>Depending on the access that is configured by the admin, Bot Creators and Citizen Developers can view and use specific packages:</p> <ul style="list-style-type: none"> <li>• Bot Creators can access a broad set of complex packages and create bots, which can be reused.</li> <li>• Citizen Developers can access simpler and easy-to-use packages and build automations quickly.</li> </ul> <p><a href="#">RBAC on packages</a> on page 1899   <a href="#">Configure RBAC for packages</a> on page 1902</p>
<p>Salesforce command package</p> <p>You can now authenticate from Automation 360 to access Salesforce and run several command actions by using the new Salesforce command package.</p> <p><a href="#">Salesforce package</a> on page 2973</p>
<p>SAP GUI 770 version now supported (Service Cloud case ID: 01793132, 01792775, 1776805, 01792623, 787725, 01805482, 01805479, 01792623, 01810356, 01822839, 01851451, 01853577, 01860050)</p> <p>SAP GUI 770 (patch 6) is now certified and supported with Recorder and SAP package.</p> <p><a href="#">Recorder actions supported in various SAP versions</a> on page 2952</p>
<p>Configure and use custom proxy configuration in REST Web Service package (Service Cloud case ID: 01271527, 01765084, 01839282)</p> <p>REST Web Service package is now enhanced to support custom proxy configuration for each <b>Delete</b>, <b>Get</b>, <b>Patch</b>, <b>Post</b>, and <b>Put</b> action. This provides you more flexibility in calling REST APIs with different proxy configuration and allow you to create hybrid API automation.</p> <p><a href="#">REST Web Service package</a> on page 2961</p>
<p>Keyboard shortcuts to reduce scrolling</p> <p>When developing large bots, you can now use keyboard shortcuts to expand and collapse individual or all sections and move through the lines of code quickly instead of scrolling and minimizing sections individually.</p> <p><a href="#">Keyboard shortcuts to expand or collapse elements in bot logic</a> on page 2234</p>
<p>Set value in any editable control field to be blank in SAP application (Service Cloud case ID: 00821861, 01807129)</p> <p>When you use the <b>Set text</b> action of the SAP package, you can now set the value in any editable control field in the SAP application to be blank. For example, you can set the value in the text field or the date field to be blank.</p>

Packages, actions, and Bot editor
<p>Loop through emails and move them one at a time (Service Cloud case ID: 00749763, 01807189, 01840743)</p> <p>You can now loop through all the emails in a mailbox and move one email at a time to a destination folder by using the <b>Move</b> action in the Email package.</p> <p><a href="#">Move action</a> on page 2533</p>
<p>Configure p12 certificate for SOAP-based automations (Service Cloud case ID: 00757213)</p> <p>In the SOAP Web Service action, you can now select the p12 certificate file and provide a password for user authentication. With this enhancement, you can now access web services that use the p12 certificate-based authentication (a more secure type of SSL certificate).</p> <p><a href="#">Example of using the SOAP web service action</a> on page 3240</p>
<p>Improved accessibility, usability of content on Terminal Emulator window (Service Cloud case ID: 01609467)</p> <p>You can now have improved accessibility and usability of the content displayed on the Terminal Emulator window. When you use the enhanced <b>Get text</b> action of the Terminal Emulator package, you can now view and extract all the lines and text present in the Terminal Emulator window and perform an operation based on your requirement.</p> <p><a href="#">Using Get text action for Terminal Emulator</a> on page 3125</p>
<p>Run bots with or without window title matching in letter case</p> <p>You can now run bots even when the title of a captured window does not match the letter case. For a bot to identify a static window or browser titles and titles with a wildcard character, you can opt for a case-sensitive match if you want the letter case to be matched, or a case-insensitive match otherwise, by using the <b>Case sensitive</b> option.</p>
<p>Control image preview and storage in Control Room during secure recording</p> <p>You can now choose whether or not the object images are available for preview and stored in the Control Room during secure recording by enabling the <b>Recorder preview image</b> setting. When you enable the setting, the image is previewed in the Bot editor and stored in the Control Room for 60 minutes. If you choose not to preview, images are not captured.</p> <p><a href="#">Secure recording</a> on page 1042   <a href="#">Secure recording mode</a> on page 2255   <a href="#">Settings</a> on page 1789</p>
<p>Automate Microsoft Excel spreadsheets from SharePoint</p> <p>You can now automate Microsoft Excel spreadsheets that are uploaded and shared on SharePoint. Use <b>Excel advanced &gt; Open</b> action to open the Microsoft Excel spreadsheets from SharePoint location.</p> <p><a href="#">Using the Open action for Excel advanced</a> on page 2571</p>
<p>Automate Citrix Virtual Apps in Edge with IE mode</p> <p>When using the Recorder, you can now automate Citrix Virtual Apps running on Microsoft Edge Chromium with IE mode.</p>

**Packages, actions, and Bot editor**

Automate controls using Microsoft UI Automation (COM) technology

For automation, you can now use the Microsoft UI Automation (COM) technology in the following scenarios:

- Capturing controls with secure recording mode
- Capturing and automating combo box and list view controls
- Using **Object exists** and **Object does not exist** Recorder conditions in If, Loop, and Wait packages

[Capture using specific technology](#) on page 2948 | [Actions performed on objects captured with Universal Recorder](#) on page 2923

Seamless automation of Citrix Virtual Apps and other Citrix applications

With the new Automation 360 remote agent for Citrix, you can now seamlessly automate all types of Citrix Virtual Apps and other Citrix applications that are supported on desktop applications using the Recorder.

The new Automation 360 remote agent for Citrix supports the following browsers and technologies:

- Google Chrome
- Internet Explorer
- Microsoft Edge
- Microsoft Edge with IE mode
- Mozilla Firefox
- Java
- Electron apps
- Microsoft Active Accessibility (MSAA)
- Microsoft UI automation

[Installing Automation Anywhere remote agent on Citrix servers](#) on page 1227 | [Using the Recorder on Citrix Virtual Apps servers](#) on page 1222

**Important:** For information about the supported packages, see [Automation 360 previous release versions](#).

**Building and running bots**

Implement coding standards with code analysis

You can now implement best coding practices by configuring coding rules in the Control Room. This feature helps you prevent potential errors, improve bot reliability, and makes the code more uniform, accessible, reliable, and efficient.

- As an administrator or a user with **View policies** and **Manage policies** permission, you can configure the code analysis policy for all users.
- As a Citizen Developer, you can run code analysis to analyze your bots against readability, maintenance, security, and compliance best practices.

[Code analysis](#) on page 2178

<b>Building and running bots</b>
<p>Choose specific version of child bot to check out with parent bot (Service Cloud case ID: 01771388)</p> <p>When you check out a parent bot, you can now choose the version of the child bot to check out. Every version of a parent bot can have different versions of child bot dependencies. With this feature, you can roll back the dependencies while rolling back the parent bot. You can make changes to a specific version of the dependent bot.</p>
<p>Easily move bots and files between folders in the private workspace (Service Cloud case ID: 00733125)</p> <p>You can now move bots and files effortlessly and without requiring any permissions from one folder to another in the private workspace. With this feature, if a bot is placed in an incorrect folder, you no longer have to clone it in the correct folder and then delete it from the incorrect folder.</p> <p><a href="#">Move a bot</a> on page 2301</p>
<p>Better organization with bulk checkin of related bots and files</p> <p>You can now select multiple bots or dependent files from different folders that belong to the same process and check them in, in bulk, from private to the public workspace with the same check-in message. You can check in a maximum of 10 parent bots, but there is no limitation on the number of dependent child bots.</p>
<p>Email notifications for failed checkins (Service Cloud case ID: 01598642)</p> <p>As an administrator, you can now configure sending email notifications to bot developers whenever their checkins fail. Without such email notifications, bot developers will be unaware of their failed checkins because although the checkin status is always logged in the audit log, they cannot access the audit log access without permission. With email notifications, bot developers can know about their failed checkins and retry immediately.</p>
<p>Export work items for offline records (Service Cloud case ID: 01769378, 01798514)</p> <p>You can now export work items to a CSV file for offline audits and records. With this feature, you can export selected, filtered, or all work items to a CSV file.</p> <p><a href="#">Export work items to CSV file</a> on page 2028</p>
<p>Export and import queues for efficient and flexible usage</p> <p>You can now export and import queues across development, testing, and production environments. This way, you can create a queue in the development environment, test it in the testing environment, and then promote it to the production environment to efficiently execute business process workload. You can also include work items when importing a queue.</p> <p><a href="#">Export queues</a> on page 2022  <a href="#">Import queues</a> on page 2023</p>



APIs and integrations
<p>Connect Bot Agent to Control Room through v1/registration/auto API</p> <p>You can now use the v1/registration/auto API to register and connect your device to a Control Room automatically. You must specify the Control Room URL and the userName properties in the API Request.</p> <p><a href="#">Bot Agent API: Auto registration</a> on page 3989</p>
<p>Fetch execution details for specific execution IDs with new Control Room API</p> <p>You can now fetch the execution details, such as botOutVariables and CallbackInfo, for a specific execution ID by using the new API endpoint, v3/activity/execution/&lt;id&gt; API.</p>
<p>Authorization with bearer token</p> <p>Automation 360 supports the Authorization header with a Bearer token for API requests to the Control Room. This header was previously unsupported and ignored on API requests. Obtain the Bearer token from our OAuth services. All API calls must contain either an authentication token from Authentication API (generates JSON Web token) or a bearer token from OAuth services. You cannot use both together in an API.</p>

## What's changed

Control Room, devices, and Bot Agent
<p>Missed schedules redeployed automatically</p> <p>You can now ensure that schedules missed because of Control Room shut down (Control Room maintenance or upgrade) are automatically redeployed.</p> <p>When you use the <b>Redeploy the schedule again</b> option, an audit log entry identifies the event type as <code>Schedule misfired</code>, and the bot is automatically redeployed after the Control Room is restarted.</p>
<p>Low disk space issues resolved with automatic deletion of temp files</p> <p>Automation 360 now supports automatic clearing of the files in the temp folder, thereby resolving low disk space issues.</p> <p>During bot import operations, temporary files were written to the following path, leading to increased usage of disk space and resultant low disk space issues: <code>C:\Users\&lt;aa cr admin account&gt;\AppData\Local\Temp</code>. As a result, the bots failed, and the temp files had to be cleared manually.</p>
<p>Enhanced Active Directory role mappings page</p> <p>The Active Directory role mappings page no longer has default validation of mappings.</p> <p>Validating all the role mappings can take a longer time on slow networks and with a higher number of mappings because it requires communication between the Control Room database and the Active Directory server. Also, changes in security groups and roles are infrequent and do not require frequent validation on this page. The Active Directory role mappings page now displays only the list of mappings which loads at a faster speed as validation of mappings is not done.</p>

Control Room, devices, and Bot Agent
<p>Enhanced autologin functionality for Bot Agent (Service Cloud case ID: 01788805)</p> <p>Bot Agent autologin now works successfully even if the <b>Interactive logon: Do not require CTRL+ALT+DEL</b> group policy is disabled.</p> <p>Previously, for the Bot Agent to autologin successfully, you had to enable this group policy, which was not possible due to the security policy. As a result, Bot Agent autologin failed.</p>
<p>Improved administration for WLM automations</p> <p>You can now view all the queues with the <b>AAE_Admin</b> role. Also, you can pause, resume, and stop all WLM automations.</p> <hr/> <p><b>Note:</b> If you are not an owner, participant, or consumer of that queue, you can view only queue names and not the queue details.</p> <hr/>

Packages, actions, and Bot editor
<p>Run DLL file without namespace (Service Cloud case ID: 01765712)</p> <p>You can now run a DLL function even if the namespace is not specified because the <b>Enter the namespace</b> field in the <b>Run Function</b> action of the <b>DLL</b> package is now optional.</p> <hr/> <p><b>Note:</b> The package versions are now automatically added when DLL or Excel session variables are created. Previously, an issue in Automation 360 v.25 prevented package versions from being added automatically when DLL or Excel session variables were created.</p> <hr/>
<p>Casing and format changes in Technology and Control types</p> <p>When you use the Recorder to capture objects, you can now read and identify the names of technology types and control types easily because the names of the properties now use a more user-friendly casing and format. For example, MS_ACTIVE_ACCESSIBILITY is renamed Microsoft Active Accessibility.</p>
<p>Loop condition evaluated with every iteration</p> <p>When you run a sequence of actions repeatedly for a specific number of times within a loop, the end condition within the loop is now evaluated in every iteration.</p> <p>For example, when you loop through a Data Table that has 10 columns, enter dynamic values of column count for the end condition in the loop, use the <b>Data Table &gt; Delete column</b> action to delete the column of index 0 inside the loop body, and then run the bot, the bot deletes a column in every iteration. Hence it reduces the iteration count because the loop end condition is evaluated in each iteration.</p>

## Fixes

Build 15459: This build includes the following fixes (along with fixes from the previous builds):

A critical security fix for the issue related to Multi-Factor Authentication (MFA) when used with database authentication. This vulnerability is not applicable when using SAML or AD authentication. For more information on this security fix, see [Unexpected behavior observed with Two Factor Authentication post A360.26 upgrade, where a valid authenticator code alone is sufficient to login to CR, in spite of an incorrect password.](#)

Service Cloud case ID: 01941769, 01945068

Build 15450: This build includes the following fixes (along with fixes from the previous builds):

If you have large and complex bots with many dependencies and if the size of the deployment messages that were sent from the Control Room to the Bot Agent is up to 5 MB, then the bots will run without failure.

Previously, bots were failing to execute when the size of the deployment messages that were sent from the Control Room to the Bot Agent was more than 2 MB.

Service Cloud case ID: 01882630

When you import a bot or file that is a manual dependency of other bots using the overwrite option, the import process no longer removes the dependencies from the other bots.

Previously, manual dependencies were removed for the overwrite option from the other bots during bot import.

Service Cloud case ID: 01911410, 01920508

You can select a path containing a dollar sign (\$) in a folder trigger for a file and folder, and the bot will execute successfully. Previously, the bot failed when you selected a path containing a \$ in a folder trigger for a file and folder.

Service Cloud case ID: 01829534

Build 15443 (for US-East and US-West regions only): This build includes the following fixes (along with fixes from the previous builds):

When you import a bot or file that is a manual dependency of other bots using the overwrite option, the import process no longer removes the dependencies from the other bots.

Previously, manual dependencies were removed for the overwrite option from the other bots during bot import.

Service Cloud case ID: 01911410, 01920508

Build 15439 (Japan region only): This build includes the following fixes (along with fixes from the previous builds):

You can now successfully retrieve values assigned to Global values with Japanese characters after upgrading the Control Room to the Automation 360 v.26 release.

Service Cloud case ID: 01911093, 01911209, 01911190, 01911116, 01911259

Build 15436: This build includes the following fixes:

<p>You can now successfully delete a device from the device pool without any error.</p> <p>Previously, when you deleted a device from the device pool, it was deleted from the Control Room but remained in the DEPLOYMENT_ALLOCATION_QUEUE table. Hence, the device could not be deleted and an error was shown.</p> <p>Service Cloud case ID: 01791502, 1840575</p>
<p>If you run a bot from the Bot editor workspace for debugging using the <b>Run from here</b> option and if the bot contains packages that use the session (<b>Local</b> or <b>Global</b> session), the following compiler error no longer occurs: <code>Unable to find any open session</code></p> <p>Service Cloud case ID: 01080318, 01759454, 01785168, 01790014, 01786670</p>
<p>In a multi-user environment, for simultaneous bot deployments, bot launcher logs are now generated for all the users.</p> <p>Previously, in such cases, bot launcher logs were not generated for all the users.</p> <p>Service Cloud case ID: 01759506</p>
<p>You can now successfully list a scheduled task, and the following error no longer occurs: <code>Unknown timezone ID:US-Pacific-New</code></p> <p>Previously, an unsupported time zone could be selected, which resulted in this error.</p> <p>Service Cloud case ID: 01759074</p>
<p>If a device is shared between a Bot Creator and a Bot Runner, when you try to edit a schedule, the following updated message is now displayed: <code>UNKNOWN: All runAsUser(s) should have default device as no pool is provided. RunAsUser(s): [dprunner] does not have a default device or that device is shared with a bot creator</code></p> <p>Previously, if a device was shared between a Bot Creator and a Bot Runner, when you tried to edit a schedule, the following incorrect message was displayed: <code>Automation failure due to deploy failure</code></p>
<p>When you update the Bot Agent from user level to system level, you can now capture objects using the Recorder actions or from a window list in a Google Chrome browser. You no longer have to manually delete the registry entry in Windows from the current user level (HKEY_CURRENT_USER).</p> <p>Service Cloud case ID: 00731155, 00778022</p>
<p>After connecting to a device, when you set the global cache location to an invalid path, an audit log entry is generated against the device, and the default global cache path is now used.</p> <hr/> <p><b>Note:</b> Depending on the device used and the path you specified on your drive, validation of the default cache path might not be supported.</p> <hr/>
<p>When you want to edit a DataTable variable in debug mode, you can now scroll horizontally to view all the columns in the DataTable variable.</p> <p>Service Cloud case ID: 01818834</p>

In the FTP / SFTP package, you can now create bots using actions such as **Delete files**, **Put files**, and **Get files** even if the file name contains characters such as the comma (,) and the colon (:).

Previously, characters such as the comma (,) and the colon (:) were not supported in file names.

Service Cloud case ID: 01772186

You can now run an Enterprise 11.3.3 bot from Automation 360 in the Enterprise 11 Control Room by using the **Run** action.

Previously, the **Run** action did not work for v.11.3.3 because the device V1 API was not working with an empty filter for release 11.3.3.

Service Cloud case ID: 00825696, 01747999

You can now successfully connect to the Excel or Access (Microsoft Office 2016 or later) engines with ODBC drivers.

Previously, if you tried to connect frequently to the Excel or Access (Microsoft Office 2016 or later) engines with ODBC drivers, bot execution failed intermittently.

Service Cloud case ID: 01762290, 01755335, 01778149, 01778899, 01793064, 01788154, 01810754, 01806851, 01811703, 1815437, 01807133, 01799364, 01755642, 01749480, 01767869, 01807133, 01818989, 01815300, 01826839, 01804882, 01842384, 01846477, 01762300, 01331003

When you send an email with multiple file attachments and if attachment size exceeds 24 MB, the bot now waits for 120 seconds before encountering a timeout error.

Previously, when you sent emails with a large file attachment, bot execution failed after 30 seconds if the attached file exceeded the file size.

Service Cloud case ID: 01763214

When you use the **Connect** action to connect with the **EWS** protocol, the **Send** email action and read email now print the email message body in a new line character in the following scenarios:

- When you create a bot and connect with the **EWS** server, then use the **Loop** action to read email as a plain text messages, and then use the **Log to file** action to log text into a file.
- When you use the **Send** email action and connect with the **EWS** server with **OAuth authentication** to send email.

Service Cloud case ID: 01770645, 01780628

In the Email package, when you use the **Move all** action and establish a connection with the EWS server, if the destination folder contains any of the following special characters in the folder name, then use a backslash (\) as escape character before the special character:

, + , \* , ? , ^ , \$ , ( , ) , [ , ] , { , } , | , \

For example, if the destination folder name is "4) folder name", enter it as "4\ folder name".

Service Cloud case ID: 01803958

If your bot contains an error, **Bot error** now shows the correct line number of the error within the **Finally** block in the following scenario: When you add the **Try/Finally** block around the corresponding action, then insert more actions in the **Finally** block, and then save and run the bot.

You can now successfully upload files whose file names are in the Japanese language by using the **Rest web service** action with multipart form data.

Previously, file upload did not work for files whose file names were in the Japanese language.

Service Cloud case ID: 01801767

You can now use the Terminal Emulator package to perform tasks associated with the terminal without any issues. We now provide support for the Start PC Command (STRPCCMD), so when you run the bot, the terminal now successfully opens the application with the STRPCCMD command.

Previously, when you passed the appropriate key on the Terminal Emulator, the bot did not open the expected application because the STRPCCMD command was not supported in the Terminal Emulator.

Service Cloud case ID: 01816577

In the Terminal Emulator package, you can now use the **Connect** action to connect with a host machine on which you want to automate a task.

Previously, when you used the **Connect** action, a black screen was displayed for a few terminal hosts.

Service Cloud case ID: 01823081, 01841800

After migration, when you open a **Load Add-ins**-enabled Excel file using the **Excel advanced > Open** action and run a bot, the bot now runs successfully without any error.

Previously, the bot failed because some Excel files with the **Load Add-ins** option enabled stopped functioning and the workbook was closed unexpectedly.

Service Cloud case ID: 00950745, 01835066

When you use the **PDF > Merge documents** action and select **All pages** option in the **Pages** field to merge all pages of multiple PDF documents into a single PDF document, the output PDF now retains and merges all the attributes such as bookmarks, links, layers, attachments, and signatures from the individual source documents.

Service Cloud case ID: 01792105

When the Recorder fails on a computer where the operating system language is not English, the error message for the bot runtime failure is now shown in the same language as that of the operating system.

Previously, the error message was shown in English even on computers where the operating system language was not English.

Service Cloud case ID: 01813050

You can now successfully extract text from within the captured area of a window using the App Integration package even if the screen resolution is more than 100 percent.

<p>Automate and capture window authentication dialog boxes in the Google Chrome browser using a specific technology with the Recorder.</p>
<p>Bots are no longer stuck when you work with Microsoft Access database queries.</p> <p>Service Cloud case ID: 01756390</p>
<p>You can now open local files by using the <b>New window</b> option in the <b>Browser &gt; Open</b> action even if Microsoft Edge is your default browser.</p> <p>Service Cloud case ID: 01799784</p>
<p>At bot runtime, when you assign a new window title to a window variable, the window variable now detects the correct window.</p> <p>Service Cloud case ID: 01788466, 01791773</p>
<p>You no longer encounter a compilation error in the UI in the following scenario:</p> <ol style="list-style-type: none"><li>1. Use the Datetime package released with Automation 360 v.23 or earlier to create a bot that uses the <b>Datetime &gt; Assign</b> action.</li><li>2. Then, select the <b>Variable</b> option to add the variable value.</li><li>3. Then run the bot with the package released with Automation 360 v.24 or later.</li></ol>
<p>You can now successfully capture objects from applications that are launched from a Citrix machine.</p> <hr/> <p><b>Note:</b> This fix is available only with the new Automation 360 remote agent, which you can use with the upgraded Recorder package (version 2.8.6-20220823-160834).</p> <hr/>
<p>Service Cloud case ID: 00831939</p>
<p>When you assign a window title to a window variable, if the variable field has an empty regular expression value, the bot no longer passes it without scrutiny. Instead, the following error message is now displayed: <code>Unable to find the window '&lt;window_name&gt;'. The provided regular expression '&lt;regular_expression&gt;' is invalid. Please provide a valid regular expression for the variable '&lt;variable_value&gt;'.</code></p>
<p>When you merge multiple PDF documents by using the <b>PDF &gt; Merge documents</b> action, all the form field attributes in Adobe Acrobat are merged and the output PDF document is now rendered properly.</p> <p>Service Cloud case ID: 01760279, 01792301</p>
<p>When you use the <b>If &gt; Folder does not exist</b> condition to determine whether a folder does not exist, if the specified folder exists, the bot now successfully recognizes the folder and does not attempt to create it again.</p> <p>Previously, because of the presence of leading and trailing spaces in the input folder path, the bot failed to recognize an existing folder and hence attempted to create the folder, leading to an error.</p> <p>Service Cloud case ID: 01466067</p>

If you migrate a bot and select the **HTML Tag**, **HTML InnerText**, and **HTML type** properties and then select HTML-type properties in **Search Criteria**, the bot now successfully locates and identifies the object and performs the selected action.

Service Cloud case ID: 00829817, 01757049, 01761452, 01822711

When you use the Recorder package for the **Get property** action, the correct values are now displayed for the top, left, height, and width properties.

**Note:** The **Get property** action does not display correct values for cross-domain iFrames elements.

Service Cloud case ID: 01251758

The AISense Recorder package now works as expected when you use the Windows 10 operating system in the Japanese language. Because UTF-8 is now enabled, you no longer need to use any workaround.

Service Cloud case ID: 01821267, 01822433

When you use 2.8.0-20220601-034227 and later versions of the Recorder package, the automated bot now returns the correct value for the HTML InnerText property in Google Chrome and Microsoft Edge browsers.

Service Cloud case ID: 01257098 , 01754795, 01791073, 01787461, 01813080, 01846403

For WLM queues, the date is now displayed in the correct format as YYYY-MM-DD.

Previously, this date was shown in the years ago format, which did not match the date format in the CSV file and was confusing.

In a multitenant environment, when you upload a work item file to a queue in one of the tenants, the **In progress** tab now displays the correct file upload status only in the corresponding tenant.

Previously, the **In progress** tab displayed the upload status for all the tenants.

When a WLM automation is in progress, an administrator can no longer delete the user who created that automation.

Previously, the user who created an automation could be deleted, after which that automation could not be paused or resumed by another user.

When you stop a WLM automation, work items are no longer stuck in the ready-to-run state and are now moved to the **New** state.

Previously, when you stopped a WLM automation, a few work items were stuck in the ready-to-run state and could not be deleted.

After you change any configuration field in the **Administration > Settings > Devices > Advanced options** settings in versions prior to v.25, if the Control Room is updated to v.25, the **Global Cache Location** is now set to the default `C:/ProgramData/AutomationAnywhere/GlobalCache` value.

Previously, in such cases, no value was shown for the **Global Cache Location** field, which was confusing.

Service Cloud case ID: 01869048



<p>When you use the <b>Run bot</b> option to run a bot in the <b>Activity &gt; Historical &gt; View</b> page for any activity, the bot now runs successfully.</p> <p>Previously, in such cases, bot execution failed with an error.</p>
<p>When you import a bot that contains manual dependencies, for the overwrite option, the import process now removes the manual dependencies.</p> <p>Previously, during bot import, the manual dependencies were not removed for the overwrite option.</p> <p>Service Cloud case ID: 01813452</p>
<p>When you import a bot into a folder, if a folder with the same name but different letter case already exists in the repository, bot import now fails with an error.</p> <p>Previously, in such cases, bot import was successful, but the imported bot failed at the time of execution because of the wrong folder path.</p> <p>Service Cloud case ID: 01270324, 01816507</p>
<p>You can now successfully access all the folders in the public workspace without any issues.</p> <p>Previously, when you imported and cloned a bot under a folder in the public workspace and then tried to access that folder, sometimes an error occurred, and the folder could not be accessed. This occurred some times when there were more than 2100 folders under the bots directory.</p> <p>Service Cloud case ID: 01852748</p>
<p>When you update from Enterprise 11 to Automation 360 or upgrade from an earlier version of Automation 360 to a later version, the earlier defined group mappings are retained, even when the Distinguished Name (DN) column of the mapping entries are empty in the database.</p> <p>Previously, some of the earlier-defined group mappings were deleted due to the empty value for the DN column.</p>
<p>After you update to Automation 360 v.22 or later, the Repository Management (v2/repository/file/list) API now returns the correct file size as response output.</p> <p>Previously, the Repository Management (v2/repository/file/list) API returned the file size as zero in the response output.</p> <p>Service Cloud case ID: 01151460</p>
<p>The Azul Zulu JDK is now updated to version 11.0.15+10. The previous version, 11.0.14+9, contained some vulnerabilities.</p> <p>Common Vulnerabilities and Exposures (CVEs) for this version are as follows: CVE-2022-34169, CVE-2022-21540, CVE-2022-21541, CVE-2022-21549, and CVE-2022-34169</p> <p>Service Cloud case ID: 01854652, 01868897, 01857973, 01854652, 01887083</p>

## Limitations

When you connect to the Microsoft Access Database with JDBC and specify the database path, and if you use the following specific aggregation functions in the query, an error occurs when you run the bot.

```
ASC, ATN, SQR, CBOOL, CCUR, CDATE,
CDBL, CDEC, CDATE, CDBL, CINT, CLONG, CLNG,
CSIGN, CSTR, CVAR, DATEADD, DATEDIFF, DATEPART,
DATESERIAL, DATEVALUE, FORMAT, IIF, INSTR, INSTRREV,
ISDATE, IsNull, ISNUMERIC, LEFT, LEFTS, LEN, MID,
MONTHNAME, DATE, NOW, NZ, SIGN, SPACE, STR, TIME, VAL,
WEEKDAYNAME, WEEKDAY, STRING, TIMESERIAL, CONCAT
```

Workaround:

1. Go to **Administration > Settings > Devices > Advanced options > Bot launcher JVM options** and set the value as follows: –  
`Dhsqldb.method_class_names=net.ucanaccess.converters*`
2. Restart the Automation Anywhere Bot Agent service.

External key vault integrations are not supported on Oracle Database.

Not all missed recurring schedules are redeployed with the **Redeploy the schedule again** option. Also, only one entry is shown for the missed recurring schedules in the **In progress** tab.

As an IQ Bot user, you can check out only the latest version of a process. You cannot check out previous versions of a process because version check is performed based on the Automation Anywhere file version and not the Git version.

The OAuth2 configuration settings in the Control Room will not enable you to connect to the OAuth2 service at this time. Customers planning an OAuth2 integration with our partner application should expect the service to be available by November.

In the Oracle Database environment, you cannot view a checked-in bot in the **Public** folder because version check is performed based on the Automation Anywhere file version and not the Git version.

Workaround: To view a checked-in bot in the **Public** folder, you must refresh the **Automation** page manually by using the **Refresh** button.

In an Oracle Database environment, when you select the number format and sort order for the work items in a queue, and then run bot using the **Run bot with queue** option, the queues are not deployed. Also, no errors are shown in the **Audit log** or **Activity** page.

For regular or scheduled automations using the unattended Bot Runners, bot deployments remain in the queued state and accumulate on the **In progress** page for these following scenarios:

- If the devices are down or not available.
- If a run-as user is busy executing the bot.

For devices not in the deployment state, if the number of queued bots reaches 500, it blocks the bot deployments for all devices or for all run-as users.

Workaround: To run the blocked deployments, perform one of the following actions:

- Select the queued jobs on the **In progress** page and move it to the **Historical** page
- Reconnect the Bot Runner devices.

When you set the default package version using the **Update bots to default package version** option for bots in the public workspace that are using the **Excel Advanced > Open** action, the Task Bots do not display the session name and file path values.

Workaround: Perform one of the following workarounds:

- Update the **Excel Advanced** package manually to use the latest version of the package. See [Select the package version used in your bot](#) on page 2322
- Check out the bot and revert to the previous version of the **Excel Advanced** package. Then, check in the bot to use the latest version of the package. See [Update bots to default package version](#) on page 1910

Service Cloud case ID: 01905290, 01882083, 00712719, 00728499, 00737694, 00803673, 01255722, 00838604, 00772147, 01760236, 01762679, 01771416, 01761859, 01782588, 01778220, 01784255, 01789551, 01809167, 01818690, 01831969, 01813413, 01287311, 01923711, 01927867

You will encounter an error when you run a standard workflow in the SAP BAPI package

Workaround: To execute SAP BAPI, use the Run Function call (RFC) with a combination of **Create function**, **Set** or **Get field value**, **Set** or **Get structure**, and **Set** or **Get table** actions.

When you use 2.6.1-20220428-010714 or later versions of the Recorder package to automate a web page on Microsoft Edge browser, the Recorder might not be able to perform **Click** or **Left click** actions on the JavaScript alert, prompt, and confirmation pop-up windows.

Workaround: For performing the click actions successfully, downgrade the Recorder package to 2.5.4-20220309-151830 version or earlier.

When you use the **Browser > Close** action to close a tab or a window opened in the Microsoft Edge browser, if only one Microsoft Edge browser window is open, the bot encounters the following error: **Error occurred while closing the tab**

When you run a bot in the Google Chrome or Microsoft Edge browser, use the If, Loop, or Wait action, select the webpage from the list of active tabs in the **Browser** tab, close the browser window, and then run the bot, the bot might take two minutes to open the webpage in the browser irrespective of the timeout value mentioned.

Workaround: Move the If, Loop, or Wait action inside the **If** block and use the **Application is running** condition with same browser application to check whether the browser is running.

When you run a stored procedure in Oracle and it returns SYS\_REFCURSOR, the **Run stored procedure** action is not closing the cursors. As a result, after the maximum cursor limit is reached, this action results in an error.

When you migrate a bot that contains **XML command > Get single node**, after migration, the bot encounters the following error: No node found at XPath while executing the Get Single node command

Workaround: If the XPath expression is not starting with (/) , apply XPath starting with “/” so that at the time of execution, the modification can be skipped or the XPath expression can be designed to get the desired result.

While running a bot in debug mode, the bot will fail if the variable size gets greater than 3 MB. An error message appears showing that a variable has exceeded the 3 MB limit.

When you use the **Browser > Open** action to automate a browser window running on Google Chrome and Microsoft Edge browsers, then from the browser window, select **More tools > Name window** option to update the title of this window during bot run and then when you try to run the bot with the updated window title, the bot might fail.

When you use the actions in the App Integration package to extract text from a window, the bot might not be able to detect the new UI of the Windows 11 operating system and capture the text.

Workaround: Enable the old classical UI in Windows 11 operating system. See [Restore Old Classic Notepad in Windows 11](#)

When you use the `/v2/repository/file/list`, the response lists bots restricted by user role. If you use this API as an AAE\_Admin, you can view bots from the private repository in the response. Whereas if you use this API as a bot creator, you can view system bots (recorder) in the response.

Workaround: Use the `/v2/repository/workspaces/{workspaceType}/files/list`.

Command prompt API allows you to switch the device registration even if the **Allow devices (single user) to be switched to another Control Room without reinstalling bot agent** option is disabled.

When you upgrade from Automation 360 v.25 to a later version, although you enabled code analysis in the Control Room, the rules set in the policy are not retained after the upgrade.

Workaround: Before upgrading, we recommend that you keep a note of the rules enabled in Automation 360 v.25 and then re-enable them after upgrading to a later version.

You will be unable to add locker managers and participants when creating a locker.

Workaround: After creating a locker, edit the locker and then add the locker managers and participants.

Service Cloud case ID: 02004160

## Feature deprecations

Review features and capabilities (from Automation Anywhere or other third-party vendors) that are deprecated or nearing deprecation to understand how they impact your automation.

<p>Automation Anywhere Mobile app deprecated</p> <p>The Automation Anywhere Mobile app is deprecated as of July 2022 and will not be updated to subsequent versions of iOS and Android. The mobile app is no longer available and no further support will be offered. A replacement product is currently not available.</p>
<p>Tesseract OCR v3 deprecated</p> <p>Tesseract OCR version 3 is deprecated as of September 2022. If you have created learning instances using Tesseract OCR version 3, we recommend that you plan to train your learning instances with alternative OCRs (including Tesseract4 OCR) before you update to Automation 360 v.26.</p> <p><a href="#">Deprecation of Tesseract OCR v3</a> on page 1149</p>
<p>Deprecation of IQ Bot Extraction package</p> <p>The IQ Bot Extraction package has been deprecated as of September 2022. As part of Automation 360 v.26, IQ Bot will no longer support pretrained machine learning models for invoice data extraction.</p> <p>To move your bots from the IQ Bot Extraction package to Document Automation, see <a href="#">IQ Bot Extraction package</a> on page 2749.</p>
<p>Automation Anywhere for Excel deprecated</p> <p>Automation Anywhere for Excel has been deprecated as of January 2022. The plug-in is no longer available to download as a product. However, support will be offered to current customers already using the product.</p> <p>A replacement product as a plug-in for Microsoft Excel is not available. In Automation Anywhere for Excel, this action was triggered from within the Excel application. However, as an alternative, new customers can develop bots for Excel within Automation 360 Automation Workspace and use input variables to allow specifying file names, worksheets, and ranges for bots to operate on. In Automation Anywhere for Excel, this action was triggered from within the Excel application, whereas now this action is taken from the Automation Anywhere Control Room.</p>

#### G-Suite Apps package deprecated

The G-Suite Apps package has been deprecated as of September 2022 and it no longer supports using the **Connect** and **Disconnect** actions to establish a connection with the Google server and automate tasks.

Recommended: For specific G-Suite applications, the functionality of the G-Suite Apps package is available in the following G-Suite packages:

- Google Drive
- Google Calendar
- Google Sheets

To automate tasks, in the appropriate G-suite package, use the corresponding **Connect** and **Disconnect** actions.

#### Related concepts

[Packages available in Automation 360](#) on page 2316

Actions are grouped into version-specific packages. Bot Creators can select which package version to use for a specific bot.

#### Related reference

[Automation 360 v.26 Release Notes](#) on page 254

[Updating to v.26 release](#) on page 278

Review requirements and support information about updating your Control Room and Bot Agent for the v.26 release.

[Migration updates for v.26 release](#) on page 280

Review what's new, changed, and the fixes and limitations to migrating from Enterprise 11 and 10 versions to Automation 360 v.26.

[Automation Co-Pilot for Business Users v.26 release](#) on page 286

Review what's new and changed and the fixes in Automation Co-Pilot for the v.26 release.

[IQ Bot and Document Automation v.26 release](#) on page 288

Review what's new and changed, and the fixes and limitations in IQ Bot and Document Automation for the v.26 release.

[Bot Insight v.26 release](#) on page 296

Review what's changed and the limitations in Bot Insight for the v.26 release.

## Updating to v.26 release

Review requirements and support information about updating your Control Room and Bot Agent for the v.26 release.

## Control Room update

If you are updating to this release, ensure that the Server audit is not enabled on SQL Server Database. If the server audit is enabled, use SQL administrator user account to turn off the SQL Server audit before initiating the update.

## Bot Agent updates

---

**Important:** This release includes an optional Bot Agent update. You can continue to run your existing bots without updating the Bot Agent. However, if you want to use the new features in Automation 360 v.26, you must update the Bot Agent available with this release.

---

For more information on updating to this release, see these resources:

- [Automatically update the Bot Agent](#) on page 1361 | [Manually update the Bot Agent](#) on page 1362
- [Compatibility with release builds](#) on page 1333

## Supported Control Room builds for direct update

You can update to the latest version of Automation 360 from the previous three releases (that is, from  $n-3$  releases, where  $n$  refers to the latest release).

The following previous releases are certified for update to Automation 360 v.26:

- v.25 (Build 15112, 15097)
- v.24R2 (Build 13343), and v.24 (Build 12350, 12342)
- v.23 (Build 11513)

If you are on one of these previous releases, for information about updating, see [Update Automation 360 to latest version](#) on page 1423. If you are not on an  $n-3$  release, update Automation 360 to one of the  $n-3$  releases before updating to Automation 360 v.26.

For the latest updates to the Automation 360 extensions for Google Chrome, Microsoft Edge, and Mozilla Firefox, see [Browser extensions for Automation 360](#) on page 985.

Related reference

[Automation Workspace v.26 release](#) on page 259

Review what's new and changed, fixes and limitations, and the feature deprecations in Automation Workspace for the v.26 release.

[Migration updates for v.26 release](#) on page 280

Review what's new, changed, and the fixes and limitations to migrating from Enterprise 11 and 10 versions to Automation 360 v.26.

## Migration updates for v.26 release

Review what's new, changed, and the fixes and limitations to migrating from Enterprise 11 and 10 versions to Automation 360 v.26.

## What's new

Enterprise 11 and Enterprise 10
<p>Migrate parent bots independently, avoiding overwrites and loss of updates (Service Cloud case ID: 01258572, 01778107, 01275417, 01880168)</p> <p>You can now migrate a parent bot independently even if it has associated child bots. You now have a choice to select whether you want to migrate a parent bot independently or along with its dependent child bots.</p> <p>This helps in avoiding overwrites and loss of updates that might happen when child bots that are migrated to Automation 360 are updated after migration.</p> <p><a href="#">Migrate Enterprise bots</a> on page 1590</p>
<p>Migrate more bots with specific features</p> <p>You can now successfully migrate bots in the following cases:</p> <ul style="list-style-type: none"> <li>• Bots that use spreadsheets residing in <b>SharePoint</b> by using the <b>Excel advanced &gt; Open</b> action.</li> <li>• You can now migrate bots with REST commands with custom proxy configuration at the <b>Action</b> level. For custom proxy configuration support, in the <b>Bot Migration Wizard</b>, select the <b>Include web service settings</b> option.</li> </ul> <p>When you select this option, the REST commands are migrated with custom proxy configurations that use the following global variables:</p> <ul style="list-style-type: none"> <li>• <code>AAProxyHost</code> for <b>Hostname</b></li> <li>• <code>AAProxyPort</code> for <b>Port</b></li> </ul> <p><a href="#">Migrate Enterprise bots</a> on page 1590</p> <ul style="list-style-type: none"> <li>• Bots in which the user interface or window extends beyond the screen on the top-left corner (truncated) for the following actions: Object Cloning, If, Loop, Web Recorder, and Manage Web Control.</li> </ul> <p>Now, migrated bots support windows with negative coordinates (truncated windows).</p>



**Enterprise 11 only**

Migrate bots independent of Bot Insight migration

Before migration of legacy bots, you can now declare whether these bots were using the Bot Insight option in Enterprise 11 by selecting the Tag bots and variables for analytics option in the **Bot Migration Wizard**. The Bot Insight **Open** and **Close** actions are created only for such migrated bots where this option is selected.

[Migrate Enterprise bots](#) on page 1590

**What's changed**

Assess migration readiness of processes with Bot Scanner

The Bot Scanner scans your repository for processes that can be migrated to Automation 360 and provides information under the following categories:

**Note:** A process is a bot that is not used in any other bot and can include child bots.

- **All:** List of all the processes.
- **Action required:** List of processes that require action after migration to Automation 360. A process is flagged as **Action Required** even if one of its child bot requires action.
- **Review required:** List of processes that require review after migration to Automation 360. A process is flagged as **Review Required** even if one of its child bot requires review.
- **No review required:** List of processes that can be migrated. All the bots in the process can be migrated.
- **Non Migratable:** List of processes that cannot be migrated. All the bots in the process cannot be migrated.

**Note:** For generating processes summary report, the maximum repository size that is supported is up to 10 GB.

[Analyze Bot Scanner report for migration](#) on page 1534

Direct link to migration resource portal and upgrade launchpad in Bot Scanner

Bot Scanner report now also contains direct links to:

- Enterprise Migration Resources: Use the information on this page to plan for migrating to Automation 360.

[Enterprise Migration Resources | Cloud RPA | Automation Anywhere](#)

- Upgrade Launchpad: Use the information provided on this page for a self-guided experience that is customized for your migration requirements.

Note that we'll be decommissioning the Upgrade Launchpad by August 2023.

[Analyze Bot Scanner report for migration](#) on page 1534

<p>Direct link to corresponding migration messages</p> <p>With a direct link to migration messages in <b>Bot Assistant</b>, you now have quicker access to information about migrated bots that require action or review.</p>
<p>Validate letter case in window titles</p> <p>You can now validate the letter case in window titles in window variables. By using the <b>Case sensitive</b> option, you can now decide whether to match or not match the letter case in window titles that have the same titles but differ in letter case.</p> <p>With this option, you can ensure that the migrated bots produce the same output as that of their corresponding Enterprise 11 bots.</p>
<p>Review bots more efficiently with exact line number in Bot Scanner report</p> <p>The Bot Scanner report now displays the exact line number in the bots that need review or action even in cases where some of the commands used in Enterprise 11 bots are not available in Automation 360.</p>

## Fixes

<p>When you migrate bots with the <b>Select item by index</b> action of the SAP package, the index is now displayed correctly. The migrated bot selects items according to the correct index, and no error is displayed.</p>						
<p>MetaBots that were captured using the following configurations will now be migrated to Legacy AISense in Automation 360:</p> <table border="1"> <thead> <tr> <th>Linked object play mode</th> <th>Main object play mode</th> </tr> </thead> <tbody> <tr> <td>Text</td> <td>Text</td> </tr> <tr> <td>None</td> <td>Text</td> </tr> </tbody> </table> <p>Previously, bots that used such MetaBot configurations failed to migrate. Service Cloud case ID: 01774261</p>	Linked object play mode	Main object play mode	Text	Text	None	Text
Linked object play mode	Main object play mode					
Text	Text					
None	Text					
<p>You can now migrate Task Bots that use MetaBot Logic whose DLL file contains classes without a namespace.</p> <p>Previously, an error occurred when you ran such Task Bots. Service Cloud case ID: 01765712</p>						

When you migrate from Enterprise 11 to Automation 360, capturing MetaBot screen commands is changed as follows:

Enterprise 11	Automation 360
<ul style="list-style-type: none"> <li>Main objects captured with the <b>Object</b> play mode</li> <li>Linked objects captured with the <b>Coordinate</b> play mode</li> </ul>	Record capture actions with the <b>Object</b> play mode

You can now use commas in the filenames of bots that use FTP actions and use colons in the filenames of bots that use Delete files and Delete folder FTP actions.

Previously, such bots encountered an error during bot run.

Service Cloud case ID: 01772186

When you migrate bots that use the same window titles but have different letter case in window variables, the bots now run successfully.

Previously, bots that used the same window titles but had different letter case in window variables failed to run successfully after migration.

Service Cloud case ID: 00825181

You can now successfully run migrated bots that use the Email Received Date variable twice in subactions inside the Email Loop action.

Previously, a parse error occurred in such cases.

Service Cloud case ID: 01275815

In migrated bots, when you use the Recorder package, you can now use the **Click** action on **Client Control** in **HTML technology** without any issues.

Previously, the **Click** action button on **Client Control** did not work as expected.

Service Cloud case ID: 01713357

You can now successfully re-edit a migrated bot with the **Record > Dataset** variable.

Service Cloud case ID: 01807170

When you want to open web pages, in the Browser package, when you use the **New window** option of the **Open** action, you can now specify a URL without the protocol information, such as http, https, or file.

Previously, when protocol information was not provided in the URL, some web pages did not open properly.

You can now successfully migrate Enterprise 11 bots with analytics flags.

Previously, migration failed when variables with analytics flags were checked.

Service Cloud case ID: 01768545

When you click the **Back** button in the migration details page for a migration run, you are now redirected to the **Migration runs** tab.

Previously, when you clicked the **Back** button, you were redirected to the **Overview** tab.

Service Cloud case ID: 01816558

When you migrate a bot that uses the **Manage Window Controls** action, the height value is now set correctly after migration.

Previously, after migration, the last digit of the height value was not available.

Service Cloud case ID: 01756996

When you run a bot to automate spreadsheet data, all the requests are now processed successfully in the following scenario:

When an Excel session is active in SAP and a corresponding Excel process starts in the background, Automation 360 creates a separate Excel process other than the one that SAP started, and the correct window is now activated for all the subsequent requests.

Previously, only the first request was processed successfully because the correct window was not activated for automating the spreadsheet data for the subsequent requests.

Service Cloud case ID: 00815159

When you migrate bots from Enterprise 11, the automation priority of each bot is now adjusted to match its equivalent priority level in Automation 360, as follows:

- In Enterprise 11, if the automation priority for a bot was set to low, after migration, the automation priority for the bot is changed to medium.
- In Enterprise 11, if the automation priority was set to medium, the automation priority in the migrated bot is set to high.

**Note:** There is no change in automation priority when it is set to high.

Previously, the automation priority of migrated bots remained the same as in Enterprise 11.

You can now migrate bots even if the properties value of the Manage Window Controls action is set to 65536 or more.

Previously, when the properties value was set to 65536 or more, the bots encountered an error during bot run.

Service Cloud case ID: 01768555, 01825071

After migration, you can now get all the lines of text from the Terminal Emulator by using the **Get text > All lines** action.

Previously, you could get only 24 lines of text from the Terminal Emulator.

Service Cloud case ID: 01609467

In the Bot migration wizard, the Bot Scanner and the Bot migration report now display the correct status for bots that are flagged for the R134 migration message.

Previously, in the Bot Scanner and the Bot migration report, the status of bots that required review was incorrectly displayed as **No review required**.

You can now successfully migrate bots whose queue category name contains a space.

Previously, migration of such bots failed because Enterprise 11 bots whose queue category name contained a space went into an infinite loop until the loop timed out at 90 minutes.

Service Cloud case ID: 01850864

After you migrate a bot that uses the Terminal Emulator package, when you run the bot, the terminal window is now activated and remains in the front. This is because the **Show terminal window in the front** option in the **Connect** action is now enabled by default.

Previously, when you ran such a bot, the terminal window was not activated and remained minimized because the **Show terminal window in the front** option was not present in the **Connect** action.

When you run a bot with the Database package, the bot no longer becomes stuck at the **Insert** or the **Update** command when run for a long duration.

Previously, in such cases, the bot became stuck intermittently.

Service Cloud case ID: 01836733

## Limitations

In Enterprise 11, if bots were using the **String > Replace** action to find a carriage return line feed (CRLF) character and replace it with another character, after migration, the output might not be the same as the output seen in Enterprise 11.

Workaround: In the **Find string** option, instead of the **Enter** (LF) variable, use the **Newline** (CRLF) variable.

Service Cloud case ID: 01808878

In Enterprise 11, if bots were using the If, IF/ELSE, or Loop While command in Windows Control and if the Application window does not exist, after migration, the bots will encounter an error during bot run.

Service Cloud case ID: 01846262

When the **Select** query is used inside a Loop command and its result set is further iterated, if the query returns no record, the result set Loop reiterates the previous record.

Service Cloud case ID: 01799961

Related reference

[Automation Workspace v.26 release](#) on page 259

Review what's new and changed, fixes and limitations, and the feature deprecations in Automation Workspace for the v.26 release.

[Updating to v.26 release](#) on page 278

Review requirements and support information about updating your Control Room and Bot Agent for the v.26 release.

## Automation Co-Pilot for Business Users v.26 release

Review what's new and changed and the fixes in Automation Co-Pilot for the v.26 release.

### What's new

<p>Embedded automation with OAuth 2.0</p> <p>Embedded automation streamlines access to the automation experience.</p> <p><a href="#">Embed automations in your application using Automation Co-Pilot</a> on page 3298</p> <ul style="list-style-type: none"> <li>Automation Co-Pilot Integrations embeds in web applications as a widget, so if you are an end user, you can access automated processes and bots without leaving your environment.</li> <li>Automation Co-Pilot Extensions offers further adaptability through Chrome browser extensions, enabling automation directly in any web scenario. Business users can now access automations through a widget, available through an extension in their web browser.</li> <li>With an OAuth 2.0 connection, existing access to automations in the Control Room are now shared with the Extensions to offer you a seamless user experience.</li> </ul> <p><a href="#">Embed automations in your application using Automation Co-Pilot</a> on page 3298</p>
<p>Oracle Database support</p> <p>We now support Automation Co-Pilot on Oracle Database. When you install or update to this release, you can now choose Oracle Database to work with Automation Co-Pilot.</p>
<p>Delete files permanently from Automation Co-Pilot cloud storage</p> <p>You can now delete files permanently from Automation Co-Pilot cloud storage. When you delete a request, the associated file is also permanently deleted now and not just sent to the recycle bin.</p> <p><a href="#">Cloud storage usage</a> on page 3481</p>
<p>Append or overwrite operations in your form</p> <p>Append or overwrite operations in your form by using the <b>Assign</b> form rules for the web, with the <b>Checkbox</b> and <b>Radio Button</b> elements, which now support form rules.</p>
<p>Assign dynamic values with support for new elements in your forms</p> <p>When you use the interactive forms package, you can now assign dynamic values with the <b>Assign</b> action, which now supports <b>Checkbox</b> and <b>Radio Button</b> elements in your form.</p> <p>You can also change the label of the selected form elements with the <b>Change label</b> action for the <b>Button</b> element.</p> <p><a href="#">Interactive forms package</a> on page 2738</p>

Run processes more seamlessly by setting expiration time for human tasks (Service Cloud case ID: 00806522)

You can now run your process more seamlessly even when a human task takes longer to run. You can achieve this by setting an expiration time for your tasks in **Human Task** in a process.

When you set an expiration time, if a human task takes longer to address, the task times out and the process moves to the next step to ensure there is no break to the flow.

You can set the expiration time by number of days, hours, and minutes, depending on your requirement.

[Create a process automation in Process Composer](#) on page 3454

## What's changed

Simplify your workflow by grouping multiple conditions in form rules

You can now group multiple conditions for your form rules by using the **And** logic with the **Or** logic. Previously, you could group only the **And** logic or the **Or** logic. This change, which is similar to the **If-Then-Else** logic, facilitates grouping multiple conditions and helps simplify your workflow.

## Fixes

You can now have greater security validation because it is no longer possible to upload files that have double extensions, such as File.PDF.PDF, to your web application.

Previously, uploading files with double extensions was possible, which represented a significant risk to applications.

Service Cloud case ID: 00828289

Clean up operations now include recursive request files to prevent spam in audit logs. Previously, an Unsuccessful Request alert appeared repeatedly in the audit log, from root error:

```
org.hibernate.exception.ConstraintViolationException: could not execute statement
```

Service Cloud case ID: 01816489, 01839604

When you use the **Has Errors** rule to show the number of errors in your form, the error message now shows the correct number of errors.

When you update from Automation 360 v.24R2 to Automation 360 v.25, the bot setup now correctly shows the number of bots and assigned teams.

Related reference

[Automation 360 v.26 Release Notes](#) on page 254

[Automation Workspace v.26 release](#) on page 259

Review what's new and changed, fixes and limitations, and the feature deprecations in Automation Workspace for the v.26 release.

[IQ Bot and Document Automation v.26 release](#) on page 288

Review what's new and changed, and the fixes and limitations in IQ Bot and Document Automation for the v.26 release.

[Bot Insight v.26 release](#) on page 296

Review what's changed and the limitations in Bot Insight for the v.26 release.

## IQ Bot and Document Automation v.26 release

Review what's new and changed, and the fixes and limitations in IQ Bot and Document Automation for the v.26 release.

### Document Automation

What's new
<p>Improve extraction by providing changes to the Validator</p> <p>You can now improve extraction by providing learning instances with validation feedback for Automation Anywhere models. You can achieve this by enabling the <b>Validation feedback</b> option in the <b>Create learning instance</b> and <b>Edit learning instance</b> windows.</p> <p><a href="#">Improving extraction accuracy through validation</a> on page 3662</p>
<p>Search for form or table fields</p> <p>When creating a learning instance, when you are configuring fields, you can now search for fields by field name, field label, or data type.</p>
<p>Process invoice-like documents with user-defined document type</p> <p>You can now process documents that are visually similar to invoices, such as purchase orders and sales orders, which contain key-value pairs and a table structure. You can achieve this by create learning instances with the user-defined document type, using which you can also achieve the following results:</p> <ul style="list-style-type: none"> <li>• Extract from English, Dutch, French, German, Italian, Portuguese (Brazilian), and Spanish language documents.</li> <li>• Define exactly which values to extract from a field, such as when a date of birth field also contains the age.</li> <li>• Use the Address data type for form fields, which identifies and extracts the structure of an address.</li> </ul>
<p>Enhancements to the Validator</p> <ul style="list-style-type: none"> <li>• The Validator now shows the group number for documents processed in a learning instance connected from Automation 360 IQ Bot</li> <li>• You can now configure a list of valid values when creating learning instance.</li> <li>• When you click a field that requires validation, a message now appears with the confidence level determined by the system and the threshold set in the learning instance.</li> </ul>



What's new
<p>Monitor document processing metrics in Bot Insight dashboards</p> <p>You can now visualize data, such as the number of documents uploaded per day, extraction time per document by learning instance, and STP percentage by learning instance, by using the customizable dashboards in the <b>Document Workspace</b> tab.</p> <p><a href="#">Document Workspace dashboard</a> on page 3937</p>
<p>Document Automation now supports the bring your own key (BYOK) use case for the Google Document AI product license</p> <p>Users can now configure their Control Room environment with Google Document AI licenses purchased from Google. This allows the learning instance to send documents to Google Document AI for extraction and for the Control Room to track consumption in the <b>All licenses</b> page.</p> <p><a href="#">Configure key for Google Document AI</a> on page 3640   <a href="#">Automation 360 licenses</a> on page 1407</p>
<p>View Document Automation user activities in the audit log</p> <p>With the <b>AAE_Admin</b> role or a custom role with the <b>View audit log</b> permission, you can now view the status of events related to learning instances, domains, and documents.</p> <p><a href="#">Audit log</a> on page 2143</p>
<p>Create and train standard forms within the Control Room</p> <p>Users with the <b>AAE_IQ Bot Admin</b> or <b>AAE_IQ Bot Services</b> roles can now create new standard forms in Document Automation. It is no longer necessary to leave the Control Room and open a third-party service to create or modify a standard form. The interface to configure the extraction model is launched from the <b>Learning instances</b> page.</p> <hr/> <p><b>Note:</b> To process documents in a learning instance which uses the standard forms model in Document Automation:</p> <ol style="list-style-type: none"><li>1. Create the standard form in Document Automation.</li><li>2. Create and train the learning instance in Automation 360 IQ Bot.</li><li>3. Connect the learning instance to Document Automation.</li></ol> <hr/> <p><a href="#">Create a custom extraction model using Standard Forms</a> on page 3699</p>

What's changed
<p>To connect a learning instance from Automation 360 IQ Bot, you must have one of the following roles:</p> <ul style="list-style-type: none"><li>• <b>AAE_IQ Bot Admin</b></li><li>• <b>AAE_IQ Bot Services</b></li><li>• A custom role with the <b>Connect learning instance</b> permission</li></ul>

What's changed
<p>Uploaded documents and extracted data are now removed after 90 days even if a document has not completed processing, except in the following cases:</p> <ul style="list-style-type: none"> <li>• If data is downloaded and deleted, the source documents are immediately deleted.</li> <li>• If the document is manually validated, the document is stored for 90 days from the date of extraction.</li> </ul>
<p>If a document is renamed to a new file extension and uploaded to a Google Document AI pretrained model, the document will fail processing.</p> <p>Workaround: Rename the document to the correct file extension.</p>

Fixes
<p>Beside the <b>Validate documents</b> link, the value that reflects the number of documents awaiting validation is no longer hidden, and you can now view it without adjusting the width of the Actions column.</p> <p>Previously, you had to adjust the width of the Actions column to see the value.</p>
<p>You can now successfully draw a box, zoom in, fit the box to match the screen size, and then redraw the box without any issue.</p> <p>Previously, when you drew a box, zoomed in, clicked <b>Fit to screen</b>, and then tried to redraw the box, the box appeared at a different location from where you clicked.</p>
<p>In the Validator, you can now adjust the system-identified region (SIR) by dragging the corners of the SIR when you zoom in or zoom out.</p> <p>Previously, you could drag the corners of the SIR but not when you zoomed in or zoomed out.</p>
<p>When you connect to a learning instance from Automation 360 IQ Bot, if the learning instance has an optional field with a set default value and some fields that are unmapped, when you process documents in that learning instance in Document Automation, the default value now appears only in the mapped fields.</p> <p>Previously, the default value appeared incorrectly in the unmapped fields.</p>
<p>In Community Edition, when you try to delete a learning instance, the following, correct message is now displayed and you can successfully delete the learning instance: Community edition users are limited to 5 learning instances</p> <p>Previously, although you could delete the learning instance, the following, incorrect message was displayed: Community edition users are limited to 5 learning instances and will not be able to delete.</p>
<p>Fixed an issue where Document Automation sometimes failed to extract data from tables that span across multiple pages. Document Automation now supports data extraction from tables that span across multiple pages for Automation Anywhere models.</p>

Fixes
<p>You can now use the <b>Document Extraction &gt; Download</b> action in a standalone bot that is not part of an Automation Co-Pilot process.</p> <p>Previously, this action could be used only in the Downloadbot within the Automation Co-Pilot process that was automatically generated when a user created a learning instance.</p>
<p>After the Validator times out because of inactivity, when you refresh it, instead of showing the most recent document that you validated, the Validator shows the first document that you validated.</p>
Limitations
<p>Document Automation does not support Cloud-enabled (SDS) deployment.</p>
<p>Formula validation does not support numbers that contain delimiters. For example, 1,000 and 2.0 are not supported.</p>
<p>In some cases, the Bot Agent does not clear out its resources folder. Until the disk space is freed, the production documents in processing will be affected. This issue occurs intermittently.</p> <p>Workaround: Based on the issue, you must create a task scheduler to clean out the resources folder every day or every week.</p>
<p>There is no notification when the product license is about to expire. When the product license expires, the <b>Learning Instances</b> tab is removed from the Control Room.</p>
<p>Learning instances that use Google Document AI models do not reliably extract all the fields in a table, if the table that spans multiple pages.</p>
<p>In On-Premises installation in Linux environments, document processing sometimes fails because of a storage service error.</p> <p>Workaround: In the command prompt, run the following script:</p> <pre>cd /opt/automationanywhere/automation360/appdata/Server Files/ sudo chown -R crstorage:controlroom storageservice</pre>
<p>Document Automation does not support Oracle Database for On-Premises installations.</p>
<p>Document Automation supports only the following standard ports for On-Premises installations:</p> <ul style="list-style-type: none"> <li>• For HTTP: Port 80</li> <li>• For HTTPS: Port 443</li> </ul>
<p>Sometimes, files uploaded to train a standard form appear corrupted although the data is still usable.</p>
<p>Standard forms in Document Automation is not supported in a multi-tenant Cloud Control Room that was upgraded from v.25. This limitation does not occur on a fresh installation of a multi-tenant Cloud Control Room.</p>
<p>Learning instances with the user-defined document type do not support Dutch language documents.</p>

Limitations
The first time you click a learning instance connected from Automation 360 IQ Bot, you are redirected to the IQ Bot homepage instead of the details page for that learning instance.
Formula validation is not supported for custom fields if the field name contains a space.
When you import a learning instance created in a previous version of Document Automation, the check box to send validation feedback to the system is unselected by default. You must edit the learning instance to select the check box.
Document Automation does not perform post-processing on connected learning instances that contain Python custom logic with either of the following: <ul style="list-style-type: none"> <li>• Single quotes, such as <code>print ('Test')</code>. Ensure the Python script uses only double quotes.</li> <li>• Characters from non-Latin languages (Unicode characters), such as äöüñž.</li> </ul>
Formula validation is not supported in learning instances with the user-defined document type.
When you process documents using the IQ Bot Extraction package, the Python scripts are not applied properly on the form fields for the classic learning instances connected on Document Automation. This results in improper data extraction in the output CSV files and the Validator.
When you click the <b>Table</b> icon on Form OCR Testing Tool (FOTT) editor, the text appearing on the pop-up window is not readable.
If IQ Bot, Control Room, and Bot Agent are installed on the same Windows Server 2012, then data extraction fails for any Classic learning instances connected in Document Automation.

## IQ Bot

What's new
<p>When user logs out, lock released immediately on documents in Validator</p> <p>When a user logs out of IQ Bot, the lock on the documents in validation is now released immediately so that other users can view or validate the documents. Previously, when a document was in the Validator queue, if the logged out, the lock on the document in the validator was not released immediately, as a result of which other users could not view or validate the document.</p> <p><a href="#">Use the IQ Bot Validator</a> on page 3790</p>
<p>IQ Bot Database Migration Assistant Tool now supports Windows Authentication</p> <p>When you migrate from Enterprise 11 to Automation 360 by using the Database Migration Assistant Tool, you can now use Windows Authentication for connecting to the IQ Bot database server.</p>

**What's new**

Choose classification type while creating learning instance

When you create a learning instance, you can now choose which aliases and fields are considered for classification by using the **Disable classification changes on domain modification (fields, alias)** check box.

- When this check box is selected, the classification process uses only the aliases or fields that were present in the domain when the learning instance was created. Aliases and fields added to the domain after the learning instance was created are not considered for classification.
- When this check box is cleared, the classification process uses all the aliases or fields that are part of your domain. Aliases and fields added to the domain after the learning instance was created are also taken into consideration for classification.

This feature classifies the document to the same group even if there are any updates in the domain.

**What's changed**

Upgraded machine learning models

IQ Bot now uses an upgraded machine learning model for detection of check boxes and Advanced tables.

Python libraries upgraded to 64-bit

All the Python libraries provided in IQ Bot by Automation Anywhere for this release are now upgraded to 64-bit from 32-bit. If you are using third-party libraries, ensure that you upgrade to 64-bit libraries. After upgrading the third-party libraries, ensure that these libraries work successfully.

**Fixes**

When you download an unclassified document, click **Delete from the server**, and then toggle the learning instance from production to staging and back, the document no longer appears in the untrained folder. Previously, when you downloaded an unclassified document from the untrained groups, even after you deleted it, the document still reappeared in the folder.

Service Cloud case ID: 01781935

When you upload documents, the Classifier no longer halts or becomes stuck. Documents that are not classified are now cleared from the queue, allowing smoother processing of subsequent documents. If these documents fail to be processed within the timeout limit, they are now categorized as unclassified and you can download these unclassified documents.

Service Cloud case ID: 01762844, 01272642, 01750753

You can now install IQ Bot by using Windows authentication and CyberArk Vault and then rotate the key. Previously, when you tried to rotate the Vault key, the following error message was displayed: **Error occurred while setting up the new key. Please check the logs**

Fixes
<p>You can now select multiple learning instances for backup by using the <b>Search</b> drop-down list. Previously, after you clicked the <b>Create Backup</b> option on the <b>Migration Management</b> page, if you selected a learning instance and then used the <b>Search</b> drop-down list to select another learning instance, the previously selected learning instance became deselected.</p>
<p>The value displayed in the <b>My totals &gt; Accuracy</b> field now matches the value in <b>My learning instances &gt; Field accuracy</b> for the available learning instances.</p>
<p>You can now add documents to manually created groups and upload documents to staging.</p> <p>Previously, when you edited a manually created group or tried to upload a document, you encountered an error and the following error message was displayed: <code>Failed to update manual group: Duplicate label found.</code></p> <p>Service Cloud case ID: 01849616, 01845590</p>
<p>You can now use the migration utility to successfully migrate learning instances created for a custom domain. When you import IQBA files with duplicate fields (even through an API), the following message is displayed alerting you to the existence of duplicate fields: <code>Error: Duplicate field found Invoice number.</code> Previously, the migration utility could not be used to migrate learning instances created for a custom domain.</p> <p>Service Cloud case ID: 00729627</p>
<p>During migration, you can now successfully import and export IQBA files. Previously, the import and export of IQBA files failed because the content classification table contained duplicate training fields.</p> <p>Service Cloud case ID: 00826891</p>
<p>When a document is successfully downloaded, it is now placed in the Success folder. Previously, documents that were successfully processed were sent to the untrained folder, causing inconsistencies in the download process.</p> <p>Service Cloud case ID: 00780227,00842077</p>
<p>When there is an update in the domain, IQ Bot now classifies a document to the same group.</p> <p>Previously, whenever there was any update in the domain, IQ Bot created new groups for the same document.</p> <p>Service Cloud case ID:01622981</p>
<p>If a document without content is uploaded to a learning instance in production, the following message is logged in the bot_launcher.log file: <code>Unable to upload file &lt;filename&gt; to the Learning Instance. No content in file, size 0" whenever there is a 0 KB file is uploaded.</code></p>

Fixes
<p>The security vulnerability related to <b>Unquoted Service Path</b> has been fixed. Previously, the Windows host referred to an installed service that used an unquoted service path containing whitespace Automation Anywhere Cognitive Console: D:\Program Files (x86)\Automation Anywhere IQ Bot\Portal\node_modules\winser\bin\nssm64.exe, which resulted in the vulnerability.</p> <p>Service Cloud case ID:01880370</p>

Limitations
<p>You cannot create a bot in IQ Bot when an invalid document is uploaded to a custom or manual group. Also, when an invalid document is uploaded along with a valid document and processed for extraction, the <b>See extraction</b> page keeps loading.</p>
<p>IQ Bot does not support Oracle Database for on-premises installations.</p>
<p>During production processing, if a learning instance is switched from Production to Staging or the other way around, for any documents processed during this switch, the production document that appears in Validator is blurred and not in human-readable form.</p>
<p>IQ Bot does not perform post-processing on a field if the custom logic uses Python script containing single quotes, such as <code>print('Test')</code>. Ensure the Python script uses only double quotes.</p> <p><a href="#">Custom Logic Python script challenges in A360.26 IQBot (A-people login required)</a></p>
<p>If your IQ Bot custom logic uses the Pandas library, the script must have the <code>import Pandas</code> statement.</p>
<p>IQ Bot does not perform post-processing on a field if the custom logic uses Python script containing characters from non-Latin languages (Unicode characters), such as äöüñž.</p>
<p>In IQ Bot, when you run a script created on versions prior to Automation 360 v.26, you might see a warning. However, this does not impact the script execution and the functionality.</p>

#### Related reference

[Automation 360 v.26 Release Notes](#) on page 254

[Automation Workspace v.26 release](#) on page 259

Review what's new and changed, fixes and limitations, and the feature deprecations in Automation Workspace for the v.26 release.

[Automation Co-Pilot for Business Users v.26 release](#) on page 286

Review what's new and changed and the fixes in Automation Co-Pilot for the v.26 release.

[Bot Insight v.26 release](#) on page 296

Review what's changed and the limitations in Bot Insight for the v.26 release.

## Bot Insight v.26 release

Review what's changed and the limitations in Bot Insight for the v.26 release.

### What's changed

With the expanded user interface, you can now gain more insights into the Document Workspace. A new dashboard is available that delivers insights to Document Automation activity and trends, such as number of uploaded documents, pages and average extraction time. See more information in the following topic.

[Document Workspace dashboard](#) on page 3937

### Limitations

DataTable widgets for Bot Insight dashboards currently show a maximum of 100 records.

Service Cloud case ID: 01820004, 01851999, 00760252, 00806950

To avoid errors from occurring during bot lifecycle management, the private workspace dashboards will be imported only when the bot is imported directly to the private workspace.

Importing a bot to the public workspace and checking the bot out to the private workspace will not import the associated private workspace dashboards.

Service Cloud case ID: 00760022, 01803726, 01794757, 01777561, 01780407, 01842554, 01874606

Connectors for Bot Insight, such as Tableau or Power BI, work only with the following authentication mechanisms:

- Authentication based on Control Room database
- Authentication based on Active directory

Service Cloud case ID: 01863601, 01909212

Related reference

[Automation 360 v.26 Release Notes](#) on page 254

[Automation Workspace v.26 release](#) on page 259

Review what's new and changed, fixes and limitations, and the feature deprecations in Automation Workspace for the v.26 release.

[Automation Co-Pilot for Business Users v.26 release](#) on page 286

Review what's new and changed and the fixes in Automation Co-Pilot for the v.26 release.

[IQ Bot and Document Automation v.26 release](#) on page 288



Review what's new and changed, and the fixes and limitations in IQ Bot and Document Automation for the v.26 release.

## Previous Automation 360 Release Notes

Review the release notes for previous Automation 360 releases.

### Automation 360 v.25 Release Notes

Release date: 28 June 2022

Review what's new and changed, and the fixes and limitations in the Automation 360 v.25 release.

- Control Room: Cloud Build 14304 (replaces Build 14298) and On-Premises Build 15112 (replaces Build 15097)
- IQ Bot: Cloud Build 14304 (replaces Build 14298) and On-Premises Build 15112 (replaces Build 15097)

---

**Important:** Manifest V3 based extensions - Google will deprecate Manifest V2 based extensions for Google Chrome by January 2024. . To know about Microsoft Edge Manifest V2 based extensions timelines, see [Overview and timelines for migrating to Manifest V3](#). The deprecation might impact your existing automation that use current Manifest V2 based extensions in Google Chrome and Microsoft Edge browsers. Use the Automation 360 v.25 Build 15118 and Bot Agent version 21.211 for the latest Manifest V3 based extensions updates to support features that use Google Chrome and Microsoft Edge browsers. This build is available for download in the link provided in the following article: [Everything about the Chrome/Edge Manifest V2 Deprecation](#). See [Chrome and Edge Manifest V3 extensions](#) on page 1138 and [Everything about the Chrome/Edge Manifest V2 Deprecation](#).

If you want to continue using the earlier builds of Automation 360 v.25 (Build 15112 or 15097) but want to upgrade to Manifest V3, you can manually upgrade to Manifest V3. See [Manifest extension manual upgrade](#).

---

**Important:** We have updated the Cloud Build 14304 and On-Premises Build 15112 to include fixes for the following issues. Fixes specific to On-Premises or Cloud builds are indicated.

- When you created or deleted new users, multiple, duplicate audit log entries were generated for a single user (Service Cloud case ID: 01836296).
- When you logged in to the Control Room with bot export permissions, when you exported a task, no corresponding entry was immediately visible in historical activity (Service Cloud case ID: 01834139, 01839933, 01841993, 01839817, 01834108, 01846407, 01845706, 01843349, 01846220, 01846819, 01845547, 01847028, 01847024, 01847094, 01847114, 01847115, 01846998, 01847840, 01846757, 01848123, 01846944, 01848104, 01848294, 01848905, 01846596, 01849748).
- When you updated to Automation 360 v.25 and attempted to use the previous settings with instance names, the previous settings were not allowing an update (Service Cloud case ID: 01838276, 01835897).
- (On-Premises only) When you deployed a task On-Premises without direct Internet access, the compilation slowed down (Service Cloud case ID: 01841448, 1839118, 1844817, 01846153, 01846332, 01839254).

- When the wait for condition package was used with any command package, the set timeout value for the wait was not met (Service Cloud case ID: 01842547, 01846156, 01847338, 01846324, 1842368, 01847054, 01848080, 01848789, 01848151, 01848963, 01847054, 01847121, 01848236, 01848260, 01849016, 01848248, 01848572, 01847828, 01847055, 01848826, 01848191, 01848944, 01851181, 01849792, 01852057, 01846152).
- When you update from any build to Automation 360 v.25, if changes were made to the If/Else logic in nest and saved, a new Go to End point element was added, which created a process error (Service Cloud case ID: 01848192).
- (On-Premises only) When an Automation Co-Pilot process was checked in and then checked out, the mapped variables did not persist and were lost (Service Cloud case ID: 01847675).

---

This page includes the following sections:

- Migration
  - [11.x and 10.x](#)
  - [11.x only](#)
- Automation Workspace
  - [What's new](#) | [What's changed](#) | [Summary of changes in packages on page 309](#)
  - [Fixes](#) | [Limitations \(this release\)](#) | [Limitations \(previous releases\)](#)
- Internet Explorer EOL updates
  - [Features](#)
- Automation Co-Pilot
  - [What's new](#) | [What's changed](#) | [Fixes](#) | [Limitations](#)
- Discovery Bot
  - [Fix](#) | [Limitations \(previous releases\)](#)
- Document Automation
  - [New capability](#) | [Limitations](#)
- IQ Bot
  - [What's new](#) | [What's changed](#) | [Fixes](#) | [Limitations](#)
- Bot Insight
  - [What's changed](#) | [Fixes](#)
- Automation Anywhere for Genesys
  - [What's new](#)
- Feature deprecations
  - [Summary list](#)

## Top 5 developer features in this release

View the following video on the top 5 developer features:

### Updating to this release

If you are on the previous build (Build 15097) of Automation 360 v.25, you must update to the latest Build 15112.

You can update to the latest version of Automation 360 from the previous three releases (that is, from  $n-3$  releases, where  $n$  refers to the latest release).

The following previous releases are certified for update to Automation 360 v.25:

- v.24R2 (Build 13343), and v.24 (Build 12350, 12342)
- v.23 (Build 11513)
- v.22 (Build 10526)

See also [A360 | Upgrading to A360.23, A360.24, A360.25 from A360.22 \(A-People login required\)](#).

When updating from previous releases to v.25 (Build 15097), ensure that you review the information in the following article: [Error parsing the SQL instance name while upgrading to Automation 360 v.25 \(A-People login required\)](#).

If you are on one of these previous releases, for information about updating, see [Update Automation 360 to latest version](#) on page 1423. If you are not on an  $n-3$  release, update Automation 360 to one of the  $n-3$  releases before updating to Automation 360 v.25.

---

**Important:** This release includes an optional Bot Agent update. You can continue to run your existing bots without updating the Bot Agent. However, if you want to use the new features in Automation 360 v.25, you must update the Bot Agent available with this release.

---

For more information, see these resources:

- [Automatically update the Bot Agent](#) on page 1361 | [Manually update the Bot Agent](#) on page 1362
- [Compatibility with release builds](#) on page 1333

For the latest updates to the Automation 360 extensions for Google Chrome, Microsoft Edge, and Mozilla Firefox, see [Browser extensions for Automation 360](#) on page 985.

## Migration

Enterprise 11 and Enterprise 10 features
<p>Migrate Task Bots when the referred MetaBot Logic is renamed</p> <p>You can now successfully migrate Task Bots where referred MetaBot Logic name is renamed or has changed the relative path after mapping.</p> <p>If a MetaBot Logic is renamed or changed the path after being mapped in the Task Bot then the Task Bot is now migrated with the new MetaBot Logic name or path.</p> <p>The command path in the Task Bot is updated with the renamed name or with the updated path.</p> <p>Changing the relative path is applicable in the following scenarios:</p> <ul style="list-style-type: none"><li>• Logic is moved from one folder to another.</li><li>• Logic is moved from a MetaBot root level folder to a sub folder.</li><li>• Logic is moved from a sub folder to a folder at MetaBot root level.</li><li>• The folder that has the Logic is renamed.</li></ul> <p>This enhancement applies to the following commands:</p> <ul style="list-style-type: none"><li>• Run Logic</li><li>• If &gt; Logic Successful</li><li>• If &gt; Logic Unsuccessful</li><li>• Error Handling</li></ul>
<p>Enhanced Bot Scanner output report</p> <p>In the Bot Scanner output report, when you click the name of a bot that requires corrective action, you can now view the <b>Line number</b> of commands instead of the <b>Total message count (frequency)</b>.</p>
<p>Migration support for Send Email action with multiple attachments</p> <p>You can now migrate bots that have the Send Email command with a filepath in a variable for the following scenarios:</p> <ul style="list-style-type: none"><li>• A single file is sent as an attachment.</li><li>• Multiple attachments are sent in a single email.</li><li>• Files are attached from a network drive.</li></ul>

**Enterprise 11 and Enterprise 10 features**

Migration support for Work Item variable (Service Cloud case ID: 01270496)

You can now migrate bots with the Work Item variable for scenarios in which the Work Item variable includes the following:

- A number
- Both number and string, for example, a message box
- A date
- A combination of Datetime and string, for example, a message box

---

**Note:** If the Work Item variable is a Datetime type, the action **Record:Assign** is added automatically, which then gets converted to Datetime type string variable, before applying the Work Item variable.

---

Variables created automatically after migration

In the Bot Scanner utility, bots that contain the following non-referenced variables are no longer flagged as **Action Required** or **Review Required**:

- \$FileName\$
- \$Error Description\$
- \$Error Line Number\$
- \$Extension\$
- \$Folder Name\$

After migration, the system automatically creates these variables according to the Automation 360 naming convention, and the migrated bots run successfully.

Migration enhancement to packages and actions

- If the migrated bots use the **PDF Extract Text > Structured Text** action, the new **Reduce Data Loss** option ensures that characters are retained in the extracted text and the bots run successfully.
- If you have bots with a specific Xpath expression in the SOAP Web Service package, ensure that the SOAP command output for **Selected Response** is returned accordingly by selecting **String Delimited** or **List of Strings**. For migrated bots, the **String delimited by None** option is selected by default.
- If migrated bots use the Terminal Emulator, the **Set cursor position to the beginning** option now enables you to edit the Terminal Emulator screen manually, and the focus is set to the beginning of the editable field. Note that this option is selected by default only when the **Show terminal** option is selected for these bots. (Service Cloud case ID: 00812730, 01252363, 01804623)

**Enterprise 11 and Enterprise 10 features**

## Support for 7-Zip

We have certified 7-Zip, a third-party tool, to handle backing up the Control Room repository with lengthy file names, bot names, and folder names. You can now back up and restore the repository of bots even when the length of the filepath to the repository of bots exceeds 256 characters. You can run either 7z.exe commands using the command line interface or run the 7.Zip as an application.

The 7-Zip tool support is available on the following Automation Anywhere certified Windows operating systems:

- Microsoft Windows Server 2016
- Microsoft Windows Server2019

You can download the 7-Zip tool from [7-zip Download page](#).

New **Update window title** action to update browser name in window title

When you are migrating Enterprise 10 or Enterprise 11 bots that use the Internet Explorer browser, the **Update window title** action now converts the window titles of these bots to Microsoft Edge with IE mode. The window titles are updated based on browser used by the bots. For example, consider bots that use Internet Explorer and have `Internet Explorer` in the window title. After migration, the new action updates the window title to reflect the new browser, Microsoft Edge, and the format of the text as `*Microsoft*Edge`.

[Using legacy Web actions](#) on page 2770

**Enterprise 11 only features**

Automate objects that appear behind bot runtime window (Service Cloud case ID: 00710929)

For the following commands, when you run a bot, you can now automate objects that appear behind the bot runtime window:

- **Image Recognition > Find window in window**
- **If/Else > Image Recognition > Window is found in window or not**
- **Mouse > Click**
- **OCR > Capture area or window**

## Automation Workspace

**What's new**

## Support for Azure Application Gateway

On Microsoft Azure cluster environment for On-premises, Azure Application Gateway is now a supported load balancer..

[Supported data center component versions on Microsoft Azure](#) on page 1281

What's new
<p>Install Bot Agent on devices that have Enterprise 11 Enterprise Client</p> <p>When you are creating a bot in Automation 360, you can now install the Bot Agent on a device with an existing Enterprise 11 Enterprise Client. You can create or run bots from both the Control Room instances.</p> <p><a href="#">Install Bot Agent and register device</a> on page 1347</p>
<p>IE 11 EOL notification banner displayed in Control Room</p> <p>Starting from the Automation 360 v.25 release, if you use the Microsoft Internet Explorer browser to access the Control Room, you will be prompted to use an alternative supported browser, such as Google Chrome or Microsoft Edge (Chromium). When you log in to the Control Room, a notification banner is displayed indicating that support for Internet Explorer 11 is ending.</p> <p><a href="#">Log in to Automation Anywhere Control Room</a> on page 1488</p>
<p>Switch Bot Agent to another Control Room without reinstalling the Bot Agent</p> <p>You can now enable a single-user device to be switched to another Control Room without reinstalling the Bot Agent. Log in as an administrator and select <b>Enabled</b> and the <b>Allow fast switching</b> check box from the device settings.</p> <p><a href="#">Switch device registration between Control Room instances</a> on page 1807</p>
<p>Configure the VM instance to delay Bot Agent registration</p> <p>You can now configure the VM instance (golden image) to delay the Bot Agent registration until the user logs in to the Control Room from that instance. You can also configure up to 20 Control Room URLs so that you can use the same golden image to connect to any Control Room from that list.</p> <p><a href="#">Bulk install Bot Agent on devices</a> on page 1354</p>
<p>Automation 360 support for Amazon Linux 2 on AWS EC2 environment</p> <p>Automation 360 now supports the Amazon Linux 2 operating system for Automation 360 On-Premises Control Room installation on the AWS Elastic Compute Cloud (EC2) environment.</p> <p><a href="#">Amazon Linux 2</a></p>
<p>Out-of-sync licenses and Control Room license expiry</p> <p>When licenses are oversubscribed, the Control Room enters the fail-safe state and continues to operate in fail-safe mode for 30 days, after which the Control Room becomes locked.</p> <p>When a Control Room license is within 30 days of expiration, a warning message is displayed in a banner until the license either expires or is renewed.</p> <p><a href="#">Control Room fail-safe status</a> on page 1400   <a href="#">Control Room license expiry notifications</a> on page 1421</p>

What's new
<p>Support for integration with SIEM</p> <p>The Automation 360 Cloud Control Room now supports integration with security information and event management (SIEM) to forward the audit logs.</p> <p><a href="#">Configure integration with SIEM</a> on page 1838</p>
<p>Enforce coding standards with code analysis</p> <ul style="list-style-type: none"> <li>Code analysis enables you to define and enforce coding standards to improve automation coding practices. You can set different rules that will govern how you code. With code analysis, you can implement coding best practices and make the code more uniform, accessible, reliable, efficient, and secure.</li> <li>Two new permissions, <b>View policies</b> and <b>Manage policies</b>, are introduced in the Control Room for code analysis policy.</li> </ul> <p><a href="#">Code analysis</a> on page 2178</p>
<p>Two-factor authentication for Control Room users</p> <p>If you are a Control Room administrator, you can now enable two-factor authentication (2FA) for users logging in to the Control Room. 2FA provides an additional security layer for all logins to the Control Room, which can be set either for all users or for users with specific roles.</p> <p><a href="#">Two-factor authentication</a> on page 1809</p>
<p>View version history of non-bot file dependencies (Service Cloud case ID: 01615105)</p> <p>You can now view the version history of your non-bot file dependencies. This helps to identify relevant changes made to your file by other users during a specific date and time along with the check-in messages.</p> <p><a href="#">View version history of non-bot file dependencies</a> on page 2363</p>
<p>Edit non-empty folder names in private workspace (Service Cloud case ID: 00535388, 00730075, 00786633, 00791528, 01615295, 01820406)</p> <p>You can now edit your non-empty folder names in the private workspace. With this feature, you can now manage folders more easily. Ensure the following when you rename a folder:</p> <ul style="list-style-type: none"> <li>It does not contain checked-out or cloned bots even at subfolder levels.</li> <li>It does not contain more than 100 items including subfolders and files.</li> </ul> <p><a href="#">Create and rename folders</a> on page 2325</p>
<p>View dependency maps for bots</p> <p>You can now view the dependency map for your bot in both the public and private workspaces. The dependency map shows the immediate parent and child bots for any selected bot. If you are an RPA developer, you can use the dependency map to better understand where a bot is invoked and which child bots are invoked by the bot. With this information, you can gauge the impact of the change in a bot, use the bot effectively, maintain better bot code and reusability, and prevent conflicts.</p> <p><a href="#">View bot dependency map</a> on page 2315</p>



What's new
<p>Support to automate applications supported on Citrix Workspace app (Service Cloud case ID: 01758063)</p> <p>The Citrix Workspace app is now supported on Automation 360. You can now automate applications that are accessed through the Citrix Workspace app by using the <b>Recorder &gt; Capture</b> action or the <b>Start recording</b> option.</p>
<p>AI Sense Recorder: Support for Korean language and complex table operations</p> <ul style="list-style-type: none"><li>You can now use AI Sense Recorder to automate applications that use Korean and a combination of Korean and English interfaces. <a href="#">AI Sense for recording tasks from remote applications</a> on page 2256</li><li>With AI Sense Recorder, you can now extract tabular data from complex tables. You can capture and automate tables with wider columns and tables that have columns with controls such as check boxes and options. You can also capture specific columns from tables.</li></ul> <hr/> <p><b>Note:</b> If the table is not detected automatically, use the <b>Define</b> option to detect the table.</p> <hr/> <p><a href="#">Table data extraction through AI Sense Recorder</a> on page 2270</p>
<p>Enhancements to Recorder</p> <ul style="list-style-type: none"><li>When you run a bot, you can now automate objects that appear behind the bot runtime window by using the <b>Recorder &gt; Capture</b> action. (Service Cloud Case ID: 00684306, 00770636, 01146672)</li><li>You can now use the Recorder to capture and automate objects with a specific technology. The <b>Capture object</b> tab now has the option to select a specific technology and capture using that technology. You can capture objects with the following technologies:<ul style="list-style-type: none"><li>Microsoft Active Accessibility (MSAA)</li><li>UI automation</li><li>Microsoft (MS) COM UI Automation</li></ul> <a href="#">Capture using specific technology</a> on page 2948 (Service Cloud Case ID: 01760871, 01865823)</li><li>You can now use the Recorder to automate third-party plug-in window objects on Google Chrome or Microsoft Edge browsers by using a specific technology.</li></ul>
<p><b>Reduce Data Loss</b> option in PDF package</p> <p>In the <b>PDF &gt; Extract text</b> action, for the <b>Structured text</b> type field, a new <b>Reduce Data Loss</b> option is now available. When you use this option, you can extract the complete text with minimal overlap of characters.</p> <p><a href="#">Using Extract text action from PDF</a> on page 2882</p>

What's new
<p>Enhancement to the String package (Service Cloud case ID: 00770822)</p> <p>In the <b>String &gt; Extract text</b> action, a new <b>When extracting</b> option is now available. You can use this option to specify whether the case of the text in the extracted substring must match that in the source string.</p> <p><a href="#">Using Extract text action of String package</a> on page 3089</p>
<p>Download files from URLs that require NTLM authentication (Service Cloud case ID: 01189873)</p> <p>With the enhanced Browser package, you can now download files from URLs that require NTLM authentication by using the <b>Browser &gt; Download file</b> action.</p>
<p>New option in Connect action of the Terminal Emulator package (Service Cloud case ID: 00812730, 01252363, 01804623)</p> <p>You can now edit the screen of the Terminal Emulator session manually by selecting the <b>Set cursor position to the beginning</b> check box. By selecting this option, you can now set the focus to the first editable field. By default, this option is not selected.</p>
<p>Bulk update to default package version across bots (Service Cloud case ID: 00712719, 00728499, 00737694, 00803673, 01255722, 00838604, 00772147, 01760236, 01762679, 01771416, 01761859, 01782588, 01778220, 01784255, 01789551, 01809167, 01818690)</p> <p>Use <b>Update bots to default package version</b> to update bots to use the default version for any package. User with the <b>View Packages</b> and the permission to edit the bots can now update bots in bulk to use the default package version. This feature provides you with an efficient way to securely update all the bots in the Control Room repository that you have access to with the default package version in a few clicks.</p> <p><a href="#">Update bots to default package version</a> on page 1910   <a href="#">Example of updating default package version across bots</a> on page 3259</p>
<p>Advanced search feature in the Bot editor (Service Cloud case ID: 01615310, 01780115)</p> <p>The <b>Bot Assistant</b> now provides <b>Advanced search</b> capabilities to enhance the overall search experience in the Bot editor. This helps improve the productivity of the Bot Creator. The <b>Advanced search</b> page allows you to enter a search text, select the search filter criteria, and navigate through the search results. You can use the filter criteria to narrow down the search results and quickly locate the search text. When you edit or view a bot, you can use the advanced search feature to find the exact line of action and the corresponding action details where the search text appears, that is, as a string, text value, or a variable name.</p> <hr/> <p><b>Note:</b> <b>Find in this bot</b> is now renamed to <b>Search in this bot</b>.</p> <hr/> <p><a href="#">Advanced search option in Bot editor</a> on page 2366</p>

What's new
<p>Enhancement to multiple attachments option in Send email action (Service Cloud case ID: 00800976, 00817136, 00821405, 00936080, 01256523, 01256320, 01262069, 01259369, 00936080, 01801928)</p> <p>When you send email from bots, you can now send multiple attachments as a list of files or a variable that contains the list of file objects. With this feature, you can attach files such as data files, spreadsheets, and word processor documents to your email. You can attach multiple filepaths from a local drive or a network drive, or you can use a variable that contains a filepath.</p> <p><a href="#">Using Send action</a> on page 2540</p>
<p>Enhancement to SOAP Web Service package</p> <p>When you build a SOAP response for an Xpath expression in the SOAP Web Service package, the result of the Xpath expression can be stored as a list of strings.</p> <p><a href="#">Example of using the SOAP web service action</a> on page 3240</p>
<p>Common table expression supported in Export to data table action (Service Cloud case ID: 00655318)</p> <p>You can now simplify complex joins and subqueries by using common table expressions (CTE) in SQL-compliant databases. Use CTEs in the <b>Export to data table</b> action of the Database package by using the WITH keyword.</p>
<p>Enhancement to OCR package</p> <p>When you use actions from the OCR package, such as <b>Capture area</b> or <b>Capture window</b>, the bot now identifies the controls even if the controls are behind the bot runtime window. It also extracts the text behind the Automation 360 bot runtime window from any application window.</p>
<p>New package SDK version</p> <p>You can now set up the default value for a global session by using <b>default_session_value</b> in <b>CommandPkg</b> in the newly released package SDK version.</p>
<p>Configure packages for On-Premises</p> <p>On-Premises administrators can now disable the latest package version from becoming the default version automatically. Administrators can also enable a feature that fetches and installs new package versions as and when they are released even without a Control Room upgrade.</p> <p><a href="#">Automatic package updates for On-Premises Control Room</a> on page 1906</p>
<p>Workload automations supported on PostgreSQL and Oracle databases</p> <p>Workload automations are now supported on the PostgreSQL and Oracle databases, as well. All the workload automations work well with both the databases.</p> <p><a href="#">Workload management</a> on page 1996</p>

What's new
<p>Trigger API</p> <p>Map triggers to users or roles for an attended Bot Runner user by using the Trigger API. With the Trigger API, you can also create and delete event triggers.</p> <p><a href="#">Trigger API</a></p>
<p>Enhancement to the Authentication using apikey</p> <p>With .24 or previous versions, you must replace any escape character '\' with '\\\' in the API key. With .25 or later versions, the API key will no longer have any escape characters('\').</p>
<p>Newly implemented Activity List API</p> <p>With the newly implemented Activity List API (<code>v3/activity/list</code>) you can return the job executions without call back and bot output information. The old Activity List API (<code>v2/activity/list</code>) is now deprecated.</p> <p><code>v3/activity/list</code> <a href="#">Bot Execution Orchestrator API</a></p> <hr/> <p><b>Definition:</b> Deprecation refers to features or capabilities available in the current (latest) release that will be removed or unsupported from a future release.</p> <p>You can use the specified alternatives or updated versions when they are made available.</p> <hr/>
<p>Migrate from Enterprise 11 Control Room version 11.3.4.7 to Automation 360 On-Premises</p> <p>We now support migrating from Enterprise 11 Control Room version 11.3.4.7 to Automation 360 On-Premises v.25 and later releases.</p> <p><a href="#">Supported Control Room versions for migration</a> on page 1506</p>

What's changed
<p>Enhancement to the String package (Service Cloud case ID: 00770822)</p> <p>After migrating bots, when you are extracting a text string based on a source string, the default option is set to not match the case of the source string. For new bots, the default option is set to match the case of the source string.</p>
<p>Enhancement to the Browser package</p> <p>In Enterprise 11, if a bot is using the Launch Website action to open a URL in Internet Explorer and when migrating the bot to Automation 360, if you select the <b>Convert bots built using Internet Explorer to Edge with Internet Explorer mode</b> option in the <b>Settings</b> panel of the <b>Bot Migration Wizard</b>, the URL is automatically set to open in Microsoft Edge after migration.</p>
<p>Option to change the global cache location (Service Cloud case ID: 00745395, 00781135, 00831182, 01124360, 01764952)</p> <p>As an administrator, you can now change the default location for global cache according to your requirements by going to <b>Administration &gt; Settings &gt; Devices &gt; Advanced options</b>.</p> <p><a href="#">Manage device settings</a> on page 1797</p>

What's changed
<p>Enhancement to database server for Control Room instance</p> <p>To set up the connection and authentication for your database server, use the port number of your database server instance (default port number, 1433) instead of the instance name.</p> <p><a href="#">Configure Microsoft database type and server</a> on page 1254</p>
<p>For user credential changes, add new configuration for LDAP settings without causing in-progress authentication to fail</p> <p>When a user's credential is changed or updated, an LDAP settings page is now provided so that the Control Room administrator can add the new configuration for the LDAP settings without causing the in-progress authentication to fail.</p>
<p>Support for exact match in the subject field for email triggers (Service Cloud case ID: 00953823)</p> <p>When you connect the Control Room to one of the email services on your system and trigger a bot when you receive a new email, the email trigger is now executed depending on the following subject conditions:</p> <ul style="list-style-type: none"> <li>• When the subject line is provided within double quotation marks (""), for example, "ABC spreadsheet", the trigger is executed only when the email subject has an exact match for the string provided within quotation marks.</li> <li>• When multiple subject lines are separated by semicolons, for example, ABC spreadsheet; ABC project logs, the trigger is executed when the email subject matches any of the subject lines mentioned.</li> </ul>
<p>Import Enterprise 11 bots with or without MetaBots (Service Cloud case ID: 01261325)</p> <p>You can now import the Enterprise 11 bots (.aapkg file) with or without the dependent MetaBots into the public workspace. If you are importing the .aapkg file into the private workspace, ensure that the dependent MetaBots are included.</p>

## Summary of changes in packages

The following table summarizes the new and updated features in the Control Room packages:

Name of package or action	New or changed feature	Version number	Bot agent version
AI Sense Recorder	Support for Korean language and complex table operations  <a href="#">Korean language and complex table support</a>	2.7.3-20220527-004608	1.210 or later

Name of package or action	New or changed feature	Version number	Bot agent version
Browser package	Support to download files from URLs that require NTLM authentication <a href="#">NTLM authentication</a>	3.5.1-20220527-172031	21.210 or later
Database package	Support for common table expression in <b>Export to data table</b> action <a href="#">CTE support in Export to data table</a>	4.8.0-20220504-130202	21.88 or later
Email package	Support for sending mail with multiple attachments through bots <a href="#">Send email with multiple attachments</a>	3.12.3-20220516-114852	21.210 or later
OCR package	Support to identify and capture controls behind bot runtime window <a href="#">Support to capture controls that appear behind the runtime window</a>	2.10.0-20220502-204328	21.118 or later
PDF package	Support to extract complete text with minimal overlap of characters <a href="#">Extract text accurately</a>	3.5.2-20220414-101844	21.31 or later

Name of package or action	New or changed feature	Version number	Bot agent version
Recorder	<ul style="list-style-type: none"> <li>Support to automate objects that appear behind bot runtime window <a href="#">Automate objects behind bot runtime window</a></li> <li>Support to automate objects with specific technology <a href="#">Automate objects with a specific technology</a></li> <li>Support to automate applications accessed through Citrix Workspace app <a href="#">Automate applications on Citrix Workspace app</a></li> </ul>	2.7.3-20220527-004608	21.210 or later
SOAP Web Service package	<p>Support to store output of Xpath expression as list of strings <a href="#">Store Xpath expression output as a list of strings</a></p>	3.11.3-20220426-064421	21.90 or later
String package	<p>Support to match case of text in extracted substring to that in source string <a href="#">Match case of substring to that of source string</a></p>	5.4.2-20220412-134724	20.18 or later

**Important:** For information about the packages supported with this release, see also [Packages available in Automation 360](#) on page 2316.

Fixes		
Build	Service Cloud case ID	Description
15112	01838276, 01835897	When you update to Automation 360 v.25, an error no longer occurs when the database server includes the instance name.
Builds 14304 and 15112	01834139, 01839933, 01841993, 01839817, 01834108, 01846407, 01845706, 01843349, 01846220, 01846819, 01845547, 01847028, 01847024, 01847094, 01847114, 01847115, 01846998, 01847840, 01846757, 01848123, 01846944, 01848104, 01848294, 01848905, 01846596, 01849748	When you successfully export a bot, the latest bot export activity is now displayed on the <b>Historical activity</b> page. Previously, the latest export event was not displayed as the <b>Ended on</b> column was displaying the value as N/A.
Builds 14304 and 15112	01836296	When you delete a user or a role, only one entry is now generated for each action in the audit log. Previously, multiple duplicate audit log entries were generated for a single action, affecting the user management workflows.



Fixes		
Build	Service Cloud case ID	Description
Build 14304 and 15112	01842547, 01846156, 01847338, 01846324, 1842368, 01847054, 01848080, 01848789, 01848151, 01848963, 01847054, 01847121, 01848236, 01848260, 01849016, 01848248, 01848572, 01847828, 01847055,01848826, 01848191, 01848944,01851181, 01849792, 01852057	When you use the <b>Wait &gt; Wait for condition</b> action with conditions that have specific timeout values set, the bot now waits only for the specified waiting time then runs the subsequent action. Previously, even when you specified a timeout value, the bot waited indefinitely.
15097	01274643, 01812436	If you have a function in a DLL that uses a credential variable as an input parameter and if the credential variable is not available in Automation 360, you will see the A108 migration message. Previously, you used to see the E153 migration message.  <a href="#">Migration messages</a> on page 1678
15097	--	You can now migrate bots even if the date and month are in single-digit or double-digit format and the year is in single-digit, double-digit, or quadruple-digit format for the <b>Modified before</b> and <b>Modified between</b> dates in the File and Folder action. Previously, you had to specify the dates in the MM/DD/YY format before migrating the bots.
15097	01260742	After migration, when the system passes a <b>Credential Value</b> (CV) type variable from a parent bot to a MetaBot Logic's non-CV variable, the temporary string-type variable that is created to hold the CV now does not exceed 50 characters or include an invalid space character.

Fixes		
Build	Service Cloud case ID	Description
15097	00796546	The Bot Insight pre-migration utility can now resolve corrupted dashboard IDs that are present in the BI tables and generate the dashboards.zip file for the migration. Previously, when corrupted dashboard IDs were detected in the BI tables, the Bot Insight pre-migration utility encountered an error and closed.
15097	01758427, 01805913	<p>In the SAP application, when you use the <b>Click</b> action control, the tabs are now selected precisely.</p> <hr/> <p><b>Note:</b> The <b>Type</b> value in Enterprise 11 is renamed as <b>Role</b> in Automation 360.</p> <hr/> <p>When you migrate from Enterprise 11 to Automation 360, the <b>Role</b> value is automatically set to the value that was the <b>SAP Control Type</b> value under <b>SubType</b> if the <b>Type</b> value in Enterprise 11 was set to <b>GuiShell</b>. For example, in Enterprise 11, if the <b>Type</b> value was set to <b>GuiShell</b> and the <b>SubType</b> value was set to <b>Gridview</b>, in Automation 360, the <b>Role</b> value is automatically set to <b>GridView</b>.</p>
15097	01376353, 01449535, 01713118, 01627144, 01762404	When you update your Control Room from Automation 360 v.21 or v.22 to Automation 360 v.25, the installation now completes successfully without any issues. Previously, the installation failed when users who created migration schedules lost the permissions after migration.
15097	01257547, 01722892, 01291187, 01770716, 01777450	You can now edit or delete a schedule because you can no longer delete an .atmx file that is associated with a schedule from the Automation 360 Control Room. Previously, the .atmx file could be deleted, which resulted in an error that prevented you from editing or deleting a schedule.
15097	01255723, 01252824, 01260677, 01608653	<p>When you migrate Enterprise 11 bots with the Comment command enabled, the command now remains enabled after migration.</p> <hr/> <p><b>Note:</b> If the Comment command contains a variable or a \$ symbol, the command is disabled after migration.</p> <hr/>

Fixes		
Build	Service Cloud case ID	Description
15097	01755175	You can now migrate bots with system variables (such as date, month, or year) as an <b>Export Data to CSV</b> option without encountering an error.  Previously, a preprocessing error was displayed in such cases.
15097	01261863	You can now migrate bots with system variables or expressions that include array variables without an error. Previously, a preprocessing error occurred in such cases.
15097	01758814	You can now migrate bots when the MetaBots Logic call each other and another, third Logic calls one of these in recursion. Previously, in such cases, bot migration failed with an "An unexpected error occurred" message.
15097	01255810	When you perform the <b>Send Text</b> action two times for the same value in the Terminal Emulator and the first field is protected, when the Terminal Emulator screen is loaded for the second time, it now works properly after the migration.  Previously, when the Terminal Emulator screen was loaded for the second time, an incorrect behavior was observed.
15097	01770547	In Automation 360 commands, expressions in which a variable is included within parentheses and is preceded by a \$ character are now migrated properly, with the variable inside parentheses prefixed and suffixed with the \$ character.
15097	01258964	After migration, the <b>Capture</b> action can now identify popup windows that use the same title as that of a main window in the SAP GUI. Previously, the <b>Capture</b> action could not identify popup windows that used the same title as that of a main window.
15097	00745395, 00781135, 00831182, 01124360, 01764952	If the path for global cache exceeds 256 characters, Automation 360 automatically changes the path to the default location although the path in the UI displays the path configured by the user. Previously, when the path for global cache exceeded 256 characters, Automation 360 displayed an error when downloading packages.

Fixes		
Build	Service Cloud case ID	Description
15097	01767018, 01755092, 01765551, 01764245, 01778477, 01782790, 01795043	If a user does not have access permission for a trigger or a folder with trigger under the public tab, no error message is now displayed on the event triggers page. Previously, if a user did not have access permission, the event trigger page for the user displayed an error under the public tab.
15097	01765445,01759831, 01779960, 01799422	When you log in to the Control Room as an administrator, you can no longer delete users that have active schedules.
15097	01255678	In the <b>Manage &gt; Devices</b> page, the <b>Modified by</b> column now correctly displays the username of the latest user to modify the details. For example, if user1 registers a device and later user2 modifies the device details, such as <b>Deployment type</b> , the username of user2, instead of the username of user1, is displayed in the <b>Modified by</b> column.
15097	--	When you are installing the Control Room (On-Premises), even if an external key vault is configured, you can now manually enter the database credentials and configure them for database authentication in the <b>Windows installer Database Server</b> page.
15097	01753671	When you update to this release, in the <b>View history Task Bot</b> page, the <b>Checked In</b> and <b>Checked In By</b> columns now display the correct information.
15097	--	Now when you run bots that have the <b>Get Total Rows</b> command in the SAP GUI, the values are returned as Integer data type. Previously, such commands returned values as a <b>Float</b> string type.
15097	01212822	During workload automation, you can now view and use queues even if the name of a work item template contains leading or trailing spaces. Although the spaces are displayed in the queue name, they are automatically removed when the work item template is created. Also, leading or trailing spaces in queue names are ignored during execution. Previously, queue names and template names with leading or trailing spaces were not displayed and hence were unavailable for selection.

Fixes		
Build	Service Cloud case ID	Description
15097	01772061	When you update to this release, Automation 360 does not allow multiple license-sync jobs to run concurrently. Previously, when multiple license-sync jobs were running, the audit logs displayed <b>Licenses synced</b> errors.
15097	01754415	When you update from Automation 360 v.21 or later, the Bot Agent devices are no longer shown as disconnected in the Control Room <b>Manage &gt; Devices</b> page. When you try to update Bot Agent in versions prior to Automation 360 v.21, a message now indicates that the device is not compatible.
15097	01780460	<p>When you update to this release, the Control Room <b>Advanced</b> options for devices (<b>Administration &gt; Settings &gt; Devices</b>), such as <b>Autologin timeout</b>, <b>Maximum simultaneous downloads</b>, and <b>Bot response wait time</b>, no longer revert to default values.</p> <p>For example, if you set the <b>Autologin timeout</b> to 70, after updating to this release, the value remains at 70 and does not change back to the default value.</p> <p>Previously, when you upgraded the Control Room, for example, from Automation 360 v.22 to Automation 360 v.23, the <b>Advanced</b> options for devices reverted to default values.</p>
15097	01762582, 01808698, 01815446	The Control Room <b>Activity</b> page now displays the total number of scheduled activities correctly. Previously, when you had more than 200 scheduled activities, the Control Room <b>Activity</b> page displayed only 200, and you had to sort by the <b>Activity name</b> , <b>Automation priority</b> , or <b>Modified by</b> columns to view the correct number of scheduled activities.
15097	01764492	When you install Automation 360 Control Room, the installer-generated log file no longer displays the password in clear text.

Fixes		
Build	Service Cloud case ID	Description
15097	--	In the <b>Administration &gt; Settings &gt; Email</b> page, if the <b>Require verification</b> option is not selected, you no longer receive a verification link in the email notification to verify you as a user. You can now log in to the Control Room without verifying the email ID and setting the login credentials. Previously, an email notification with verification link was sent to verify the email address even if you did not select the <b>Require verification</b> option.
15097	01783110	When you launch a bot, if the bot fails during the run, the <b>Activity &gt; Historical</b> page in the Control Room now shows the correct <b>Started on</b> time, that is, the time when the bot started running. Previously, when a bot run failed, the <b>Started on</b> time incorrectly showed the time when the bot failed. As a result, the <b>Started on</b> and <b>Ended on</b> columns displayed the same time, which was incorrect and confusing.
15097	01826944, 01828683	When you log in to the Control Room, the <b>Activity &gt; Historical</b> page now loads without error. For the historical data in the JOBEXECUTION table, a new Cloud data retention policy of 90 days is implemented, whereby the Cloud historical data is deleted along with the rollout of Automation 360 v.25 to the different regions. Previously, when you logged in to the Control Room, the <b>Activity &gt; Historical</b> page did not load because of a large number of records, and the following error message was displayed: <code>An unexpected problem has occurred</code> <ul style="list-style-type: none"> <li>• <a href="#">View completed activity</a> on page 2127</li> <li>• <a href="#">Automation 360 Cloud FAQ</a> on page 1058</li> </ul>
15097	01753337, 01785865	On the <b>Activity &gt; In progress</b> page, when you use the sort function to list the items in the <b>Started on</b> column in ascending or descending order, the items are listed correctly now.

Fixes		
Build	Service Cloud case ID	Description
15097	--	You can now successfully establish a secure SQL connection in the Linux environment by choosing the <b>Enable</b> option in the <b>Database Configuration &gt; Secure Configuration &gt; Secure Connection</b> field. The Linux installer now successfully imports the SSL certificate, and the connection is established. Previously, the Linux installer failed to import the SSL certificate and the connection was not established.
15097	00781974	In the Linux environment, you will no longer encounter issues with services stopping due to disk storage issue. Previously, some of the Control Room log messages were stored in the /var/log/messages file instead of the /var/log/automationanywhere directory, leading to low disk space.
15097	01260701	When you run bots on user devices, bots no longer become stuck in queues. Also, the following messages are no longer displayed: <ul style="list-style-type: none"> <li>• Waiting for user <i>username</i></li> <li>• Picked at runtime</li> </ul>
15097	01760032	Domain names are no longer case-sensitive, and you can now create users by using the Active Directory group mapping and map a role to a user in the Control Room. Previously, because some Active Directory servers were returning domain names in uppercase whereas others were in lowercase, domain names could not be found and there was an issue with the group mapping feature.
15097	00828289	The <b>Global Value</b> fields are now validated and have a maximum length of 4000 characters.
15097	00828289	When you navigate to <b>My settings &gt; My Profile &gt; Edit</b> in the Control Room and provide a link, for example, <code>&lt;a href="www.google.com"&gt;LinkInjection&lt;/a&gt;</code> , the email sent contains a link, and the email text sent is validated against HTML injection and you will no longer see a functional link.

Fixes		
Build	Service Cloud case ID	Description
15097	01754431, 01773662, 01789555, 01791065, 01784255, 01785653, 01780070	<p>When you use the Recorder to capture an object, set the waiting time for detecting the object to fewer than 30 seconds in the <b>Keep trying for (seconds)</b> field, and run the bot, the Recorder now waits for the specified time to detect the object and waits for the page to load completely. Previously, the Recorder waited for a minimum of 30 seconds to detect the object regardless of the time specified.</p> <hr/> <p><b>Note:</b> This fix is applicable only to Google Chrome and Microsoft Edge Chromium browsers.</p> <hr/>
15097	01614810	<p>You can now use a blank space as the delimiter in the <b>Specify delimiter (optional)</b> field. In the <b>Open</b> action of the CSV/TXT package, when you browse the filepath to open a file, add a blank space as the delimiter in the <b>Specify delimiter (optional)</b> field, and run the bot, the blank space is now treated correctly as a delimiter and the bot no longer fails.</p>
15097	01387738	<p>When you use the <b>Browser &gt; Open</b> action to open a new window in Google Chrome, the new window is now activated and displayed in front of the other open windows. Previously, when you ran a bot, the window remained in the minimized state.</p>
15097	01273095	<p>When you enter a decimal value with 16 or more decimal points in a cell of a Microsoft Excel spreadsheet and when you use the <b>Read cell value</b> option in the <b>Excel advanced &gt; Get single cell, Get multiple cells, or Get worksheet as data table</b> actions to retrieve the decimal value from the cell, the format of the cell value no longer changes from <b>General</b> to <b>Scientific</b>.</p>
15097	01144509, 01767881	<p>When you connect to an SAP session, use the <b>If &gt; Object exists</b> Recorder condition to identify and capture objects on the SAP application, disconnect the SAP session, and then run these actions in a loop, the bot now detects the objects correctly in every iteration of the loop. Previously, when the bot was run in a loop, it captured the objects correctly only during the first iteration and failed during subsequent iterations.</p>



Fixes		
Build	Service Cloud case ID	Description
15097	01769573	If you use the <b>App integration &gt; Capture text of window</b> action to capture the text in a command prompt window, when you run the bot, the bot now captures all the characters in each line correctly. Previously, the bot failed to capture the last characters in each line.
15097	01628448, 01766957, 01788709, 01788801, 01789538, 01803156, 01781597, 01810230, 01811694, 01802054, 01815687, 01823526,01814962, 01833962, 01835418, 01835382, 01837832,01830790	The Excel advanced package now works as expected and without any issues. Previously, the package threw a generic exception error intermittently.
15097	00824995, 01451063, 01274854	In the <b>PDF &gt; Extract field</b> action, when you select the <b>Open PDF viewer</b> option, select a PDF file from the Control Room or Desktop, click <b>Load</b> , and open the PDF viewer, you can now view the PDF document. Previously, when you selected the <b>Open PDF viewer</b> option to view the selected PDF document, a blank page was shown, and you could see the value in the PDF document only when you selected a specific rectangular area in the blank field.
15097	00957308	In the <b>File &gt; Copy Desktop file</b> action, when you specify a source filepath where the folder name contains a number sign (#) character or the filename contains a wildcard character, specify a destination filepath to copy the file, and run the bot, the bot now detects the source filepath and copies the file to the specified destination location successfully. Previously, when you ran the bot, the bot failed to detect the source filepath and hence did not copy the file to the destination folder.

Fixes		
Build	Service Cloud case ID	Description
15097	01685239	You can now use the Recorder to capture objects on the Citrix Xenapp application, use the <b>If &gt; Object does not exist</b> condition to verify whether a specific object exists in the application, and successfully run a bot from a parent bot. Previously, when you tried to do this, an error occurred.
15097	01260387	A password-protected Microsoft Excel file is no longer corrupted when you open the file manually after successfully running a bot using the Excel basic package. Previously, when you used the actions in the Excel basic package to open a password-protected Excel file, made some updates to the file, and closed the file by selecting <b>Save changes when closing file</b> in the <b>Excel basic &gt; Close</b> action, the password-protected Excel file became corrupted when you opened it manually from its location.
15097	00920617	When you connect to your mailbox through the IMAP protocol, use <b>For each mail in mail box</b> as email loop iterator to retrieve all email message received before date filter, and run the bot, the bot now retrieves all the email messages received before the specified date, including the email messages received on the specified date before the specified time.
15097	--	In Google Chrome, Microsoft Edge, and Mozilla Firefox browsers, you can now successfully open network URLs that start with two backslash (\) characters by using the <b>Browser &gt; Open</b> action.
15097	01015001	When you specify the total number of packages that you want to view per page under the <b>Manage &gt; Package</b> section in the Control Room, the page now displays the correct number of packages specified. Previously, all the packages were displayed on a single page even if you chose to view only a specific number of packages.
15097	01711629	In the <b>Recorder &gt; Capture</b> action, when you select a specific browser window whose title matches another browser window from the <b>Browser</b> tab and run the bot, the bot now accurately opens the selected browser window. Previously, when the title of two browser windows matched, the bot randomly opened a browser window with a matching title.

Fixes		
Build	Service Cloud case ID	Description
15097	--	You can now use the <b>Browser &gt; Run JavaScript</b> action to successfully run JavaScript on web pages that have iFrames.
15097	01075660, 01273111	The <b>Excel advanced &gt; Open and Create workbook</b> actions now display the <b>Default</b> session value under the <b>Local session</b> field.
15097	01252773, 01278029, 01772301, 01765017	An error no longer occurs when you use the <b>Excel advanced &gt; Open</b> action to open a worksheet that is a type of hidden chart or a macro. You can specify the sheet name to open the worksheet of type macro.  <b>Note:</b> When you open the default sheet, ensure that the active sheet is an Excel Worksheet. If the active sheet is of type chart, the following error message is now displayed: The Excel file does not contain an active sheet to open. Please make sure the Excel file you want to open has at least one active sheet.
15097	--	After migration, when you run the bots that use File and Folder packages, the year under the <b>Date</b> option now accepts the value 00 as input, which is considered as year 2000.
15097	01257829	In the <b>REST Web Services</b> package actions, you can now add a Custom content type, using which you can add content that does not fall under a standard content type.
15097	--	In the <b>REST Web Services</b> package actions, you can now perform <b>Add Substitution</b> , using which you can enter variables in the REST request body.
15097	01784553, 01794924	In the <b>SOAP Web Service</b> package actions, the ampersand character (&) is now automatically escaped. Previously, the ampersand character (&) which is a reserved control character, was not automatically escaped, which resulted in invalid XML files.
15097	01767571	In the <b>REST Web Services</b> package actions, new lines in the request body are no longer altered at runtime. For example, when the request body contains a new line, it is no longer replaced by a space at runtime. Previously, when a request body contained a new line, it was replaced by a space.

Fixes		
Build	Service Cloud case ID	Description
15097	00773353, 00787270	In the <b>REST Web Services</b> package actions, you can now use the user token option to access the Control Room APIs. When you log in to the Control Room, a token is generated, which is used by the bot to access the endpoints of the Control Room API used within the bot.
15097	01372460	You can now run bots by using the <b>RunScript</b> action of the Legacy Automation package. When you pass multiple arguments to replace values from a Microsoft Word document, the bot now runs the function and replaces and displays the text on a new line. Previously, the text was displayed on the same line.
15097	01758458	When you use the <b>Connect</b> action to establish a connection with an email server, use the <b>Disconnect</b> action to close the connection with the same session name. You will then not encounter any issue when you establish a new connection again with the same or different credentials.
15097	01273357	You can create a bot to run a standard workflow in <b>SAP BAPI</b> , and the output is now generated correctly as a .CSV file. Previously, when you ran a standard workflow in <b>SAP BAPI</b> , the generated output was varied.
15097	01342887	When you run a process by using the Terminal Emulator package, the terminal window is now activated and remains in the front. Previously, when you ran a process, the terminal window was not activated and stayed minimized.
15097	01251933	In the Terminal Emulator package, when you use the <b>Connect</b> action to establish a connection with TN3270E, an error no longer occurs. Previously, an error occurred, and the following error message was displayed on the mainframe screen: ISPP904 Panel ISR@PRIM error - x'0E' or x'0F' is invalid as an attribute character
15097	01432885	When you run a bot, the <b>Task bots run</b> metric on the <b>Home</b> dashboard page of the Control Room now displays the correct count. Previously, the metric displayed an incorrect count. For example, on the <b>Home</b> dashboard page, if the <b>Task bots run</b> count showed 39, when you ran the bot, the count displayed was 42 instead of 40.

Fixes		
Build	Service Cloud case ID	Description
15097	00742840	When you use actions such as <b>Open</b> and <b>Run function</b> from the <b>DLL</b> package, you no longer encounter any issues. The bot now opens the DLL file even if the DLL filepath length is fewer than 256 characters.
15097	01261786, 01615115	When you edit a bot and disable any action within it, you can now use the Ctrl+Z keyboard shortcut to undo an action. Previously, the Ctrl+Z keyboard shortcut did not work as expected.
15097	01080067	In the Active Directory package, when you use usernames with special characters, the bot now runs successfully. Previously, when you added a user to a group, if the username had special characters, when you tried to remove the user from the group, the bot failed.
15097	00962414	You no longer encounter an issue when you connect to a puTTY application through Terminal Emulator. Previously, when the terminal was connected to the host, the host prompted for a password. Subsequently, the terminal screen went blank, and the bot displayed the following error: <code>Unable to connect to a terminal. Please check connection details</code>
15097	00829259	In Active Directory, you can now successfully create a user with one of the following options: <b>Require password change at next login</b> or <b>Do not require password change at next login</b> . Previously, when you used the <b>Connect</b> action to establish a connection, if the LDAP connection path contained the oU attribute with a space value such as <code>oU=aa unit</code> , an error occurred when you ran the bot.
15097	00961069	When you are using the <b>Send text</b> action from the Terminal Emulator package, you can now send numeric keyboard minus (-) keys using Simulate keystrokes action [ALT DOWN] - [ALT UP] keys to the mainframe application.  For more information, see <a href="#">A360 : How to send hyphen(-) in Terminal Emulator TN5250E (A-people login required)</a> .

Fixes		
Build	Service Cloud case ID	Description
15097	00825675	When you delete the variables mapping from parent and child bots and then run the parent bot, the bot no longer encounters an error. Previously, when you deleted the variables mapping from parent and child bots and then ran the parent bot, the bot failed.
15097	00798604	When you use the <b>Run Function</b> action from the VBScript package, the bot no longer encounters an error. You can now specify the function name to run and pass arguments that contain brackets ([ ]). Previously, the <b>Run Function</b> action failed to run if an open or close bracket was included in any position in a string parameter.
15097	--	When you use a DLL file that is available in the Control Room, and if the DLL filepath is fewer than 260 characters, the bot now retrieves the DLL file successfully.
15097	01149730	You can now connect to an email server, select the <b>IMAP</b> protocol, use <b>Loop &gt; For each mail in mail box</b> iterator, and successfully download attachments from an email message and save them to a specified folder. Previously, if the attachments had a <code>bin</code> file, the attachments were not downloaded or saved to a folder.
15097	00919896	When you use actions such as <b>Send text</b> or <b>Send key</b> from the Terminal Emulator package, the bot launcher no longer stops working. Previously, bots created using actions from the Terminal Emulator package sometimes stopped working at random when a double-byte character set (DBCS) was enabled and the host screen had a wrapped field.
15097	00950682	You can now use the <b>Open spreadsheet</b> action in the Google Sheets package without any issue, even if you use a Proxy Auto-Configuration (PAC) file or a proxy-enabled environment.
15097	01257464	When you connect to an email server with the <b>IMAP</b> configuration and use the <b>Move all</b> action with a filter for all mail received before a certain date, all email messages that meet the criterion can now be moved from one folder to another without any issue.

Fixes		
Build	Service Cloud case ID	Description
15097	01753270	In the Google Drive package, you can now use the <b>Create file permission</b> action with the <b>File ID</b> option. Previously, when you used <b>Create file permission</b> , if no other Google Drive action was placed before it, an error occurred.
15097	01276141	In the email package, when you use the <b>Move all</b> action or the <b>Loop &gt; For each mail in mail box</b> iterator, you can now add any number of email addresses in the <b>From specific sender</b> field. Previously, the email loop did not work if the <b>From specific sender</b> field had more than two email addresses.
15097	01689348	You can no longer import bots with incomplete package files from one Control Room to another because the system now disallows and rejects the import of incomplete package files.
15097	01763262, 01762153	You can now create a bot and run stored procedures successfully. Previously, if you had two stored procedures in different databases, for example, Database_A.dbo.SP_A and Database_B.dbo.SP_B, in the SQL Server, if you were connected to Database_A and wanted to run the stored procedure in Database_B, the execution failed because the fully qualified stored procedure name was not supported in the <b>Run stored procedure</b> action.
15097	--	You can now successfully download exported bots by navigating to <b>Activity &gt; Historical &gt; Bot Export: Export.&lt;date_name &gt; Download exported zip file</b> .
15097	01762348	Bots that are deployed from the Control Room on user devices are no longer stuck in a queue after the unattended Bot Runners are added from a device pool.
15097	01151181	If you have the required permissions, you can now successfully delete an inactive schedule from the <b>Manage &gt; Scheduled &gt; Scheduled activity</b> page. Previously, even if you had the required schedule permissions, when you tried to delete an inactive schedule, you encountered an error message about permissions.

Fixes		
Build	Service Cloud case ID	Description
15097	00917927, 01255618	The <b>Modified by</b> field in the <b>Manage &gt; Scheduled</b> page now displays the correct username for recurring schedules. Previously, when schedules were imported from one environment to another, the <b>Modified by</b> field showed the username of the original Bot Creator or administrator.
15097	01778350, 01803570	When you create a schedule in the Control Room, the <b>Manage &gt; Scheduled &gt; View activity &gt; Schedule</b> page now displays the correct end time for the <b>End date</b> field. Previously, when an end date was selected for a schedule, the end time shown for the <b>End date</b> field was incorrect.
15097	--	In the Kubernetes environment, when you try to create a queue, you no longer encounter an error.
15097	00716776, 00778659, 01820190, 01856732	If you check out an item at certain time T1 and then cancel the checkout later at time T2, the canceled checkout is not considered as a modification to the item. Also, the last modified time is rolled back to time T1 that is when the bot was checked-out last time from the <b>Public</b> folder. Previously, the canceled checkout at certain time T2 was incorrectly considered as a modification to the item. Also, the last modification time was incorrectly shown as time T2 that is when checkout was canceled. Thus, it was difficult to keep track of actual modification dates of items.
15097	--	In the Kubernetes environment, you can now delete work items even after pausing a queue. Previously, when you paused a queue and tried to delete a work item, an error sometimes prevented you from deleting the work item.
15097	01255617	The WLM filters in the <b>Queue &gt; Work items</b> page now return accurate results. Previously, filters were not working accurately when you combined them.
15097	01806221, 01805371, 01818356, 01828330	After you update to Automation 360 v.24, WLM tasks no longer fail. Previously, after an update, bot execution processes or actual bot execution sometimes failed, resulting in the failure of WLM tasks as well.



Fixes		
Build	Service Cloud case ID	Description
15097	01769740	Bot descriptions are now displayed even after you check in or check out bot. Previously, after you checked in or checked out a bot for the first time, the bot descriptions stopped being displayed.
15097	01764336	An appropriate error message is now displayed when you try to change the work item status from <b>Ready to run</b> to <b>On hold</b> or <b>Complete</b> . The error message now informs you that because the queue is already in use, you must either pause or stop a queue automation to change the status of the work item. Previously, the error message displayed did not help with rectifying the issue.
15097	01273374	The <code>gettasklogdata</code> API now shows real-time data, whereby local time values are converted to UTC values for that API request.

The following table lists the limitations identified in the current release:

Limitations
<p>Bots whose queue category name contains a space (for example, Input – Emails) cannot be migrated because during migration, such bots enter and remain in an infinite loop until the loop times out at 90 minutes. (Service Cloud case ID: 01850864)</p> <p>Workaround: You can migrate to Automation 360 v.26 release where this issue is fixed or remove the space in the queue category name and then migrate the bots.</p>
<p>After you migrate your bots, an error occurs in the following situations:</p> <ul style="list-style-type: none"> <li>When you use FTP actions on bots with commas in filenames</li> <li>When you use the <b>Delete files</b> and <b>Delete folder</b> FTP actions on bots with colons in filenames</li> </ul> <p>Workaround:</p> <ul style="list-style-type: none"> <li>For bots that use FTP actions, ensure that you remove commas from the filenames.</li> <li>For bots that use the <b>Delete files</b> and <b>Delete folder</b> FTP actions, ensure that you remove colons from the filenames.</li> </ul>
<p>When you try to migrate bots in which the If condition is used for more than 95 times in a single line, migration fails with the following error message: <code>Unexpected response status: 500</code> (Service Cloud case ID: 01830793)</p> <p>Workaround: Divide the bot into multiple logical sub-bots.</p>
<p>(Service Cloud case ID: 01773164) If the number of cells in a table object exceeds 300,000, the Control Room might become unresponsive.</p> <p>Workaround: Ensure that the number of cells in a table object does not exceed 300,000.</p>

Limitations
<p>Even if the Control Room path is invalid or does not exist, the invalid path is still displayed instead of the default path: C:\ProgramData\AutomationAnywhere\GlobalCache\</p>
<p>When you run a migrated bot with the Recorder package, the <b>Click Action</b> on <b>Client Control</b> might not work. This issue occurs because some Microsoft Windows operating systems might not be activated properly on a few Windows applications.</p> <p>Workaround: Use the <b>Left Click</b> action.</p>
<p>When you try to re-edit a migrated bot with the <b>Record &gt; Dataset</b> variable, an error occurs, and the following error message is displayed: <i>An unexpected problem occurred. If the problem persists, please contact your system administrator.</i></p> <p>Workaround: Refresh the Bot editor page to reload the details.</p>
<p>A parse error occurs when you run a migrated bot with the <b>Email Received Date</b> variable used twice in subactions inside the Email loop action.</p>
<p>When you create a bot by using the <b>Send email</b> action, if the attachment includes the less-than symbol (&lt;) as a special character in the filepath, the special character will be removed after bot execution. The Windows operating system does not support this special character.</p>
<p>In a bot, when you create a <b>List</b> variable with the <b>File</b> subtype, select the value as a Control Room file, and add the List package, the bot execution fails when you run the bot.</p>
<p>If your bot has an error, you add the <b>Try/Finally</b> block around the corresponding actions, and insert more actions in the <b>Finally</b> block, when you save and run the bot, the <b>Bot error</b> dialog shows the wrong error line number within the <b>Finally</b> block.</p> <p>Workaround: If you are using <b>Try</b> and <b>Finally</b> without using the <b>Catch</b> action, the <b>Bot error</b> dialog does not show the correct line number. Instead, use <b>Try/Catch</b>. The <b>Try</b> action handles the error and sends execution to <b>Catch</b> with line number and description. This gives the correct line number within the <b>Finally</b> block.</p>
<p>When you frequently connect to the Excel or Access (Microsoft Office 2016 or later) engines with ODBC drivers, bot execution fails intermittently.</p>
<p>When you use the <b>Connect</b> action to connect with the <b>EWS</b> protocol, read email skips the newline characters and prints the email message body on a single line. This issue is also observed in the <b>Send email</b> action. Following are the scenarios where these issues are observed:</p> <ul style="list-style-type: none"> <li>• Create a bot and connect with the <b>EWS</b> server. Use the <b>Loop</b> action to read emails as a plain text message and use the Log to file action to log text into a file.</li> <li>• Use the <b>Send email</b> action and connect with the <b>EWS</b> server with OAuth authentication to send the email.</li> </ul>
<p>In a device pool, when you select the <b>Run bot now</b> option for a WLM bot, the WLM bot run is triggered and an error message is also displayed.</p> <p>Workaround: To run a WLM bot in a device pool, ensure that you select the <b>Run bot with queue</b> option.</p>

Limitations
<p>In a multitenant environment, when you upload a work item file to queue in one of the tenants, the <b>In progress</b> tab displays the same work item file for all the other tenants, as well.</p>
<p>In a device pool, when you stop a WLM automation, a few work items are still in the ready-to-run state. As a result, these work items cannot be deleted.</p> <p>Workaround: To delete work items that are in the ready-to-run state, perform one of the following actions:</p> <ul style="list-style-type: none"> <li>• Pause and stop the automation.</li> <li>• Rerun, pause, and then stop the automation.</li> </ul>
<p>After migration, when you use the <b>Excel advanced &gt; Open</b> action to open a file with the <b>Load Add-ins</b> option enabled and the system has COM add-ins enabled, when you run the bot, the bot might fail with an error.</p> <p>Workaround: Disable the <b>Load Add-ins</b> option to run the bots successfully.</p>
<p>When you use the <b>If &gt; Folder does not exist</b> condition to determine that a folder does not exist, even if the folder exists, the bot might fail to identify it due to the leading and trailing spaces in the input folder path. As a result, the bot might throw an error.</p>
<p>When you update the Control Room to the latest version, you might see some packages with two default versions.</p> <p>Recommendation: Sometimes, you might notice the duplicate packages a few weeks after the Control Room is updated. Hence, we recommend that you compress and save the Control Room logs dir that contains all the WebCR*.log files 30 minutes after the Control Room is updated. This way, if you discover the issue later, these logs from the time of update will be available and help in investigating this issue.</p>
<p>In the <b>Data Table &gt; Assign</b> action, when you select the <b>Table with values</b> option, select the <b>Edit table (1 X 1)</b> option to edit a table, enter variables in the rows and columns and then run the bot, the output still shows the input \$variable\$ instead of the evaluated value of the variable.</p>
<p>When you try to upload packages to the Control Room manually, the system does not check for the minimum required version of the Control Room that is compatible with the packages before they are uploaded. It allows the packages to be uploaded in the Control Room even if the version of the packages is not compatible with the currently installed version of the Control Room.</p>
<p>When you use the <b>Run bot</b> option to run a bot in the <b>Activity &gt; Historical &gt; View</b> page for any activity, the bot execution fails with an error.</p>
<p>(Service Cloud case ID: 01784401) To ensure that multiple Git processes are not modifying the same repository at the same time in the Control Room, Git lock is implemented for a short interval. After the lock is released, repository-related operations are resumed without any issues. However, in some instances, the Git lock is not released, and new Git operations cannot be processed. As a result, repository-related operations, such as edit, save, import, and check-in, are delayed and eventually time out.</p> <p>Workaround: Contact Automation Anywhere Support.</p>

Limitations
When you use the If package, add a specific condition with a variable, then add specific conditions within a group, save the bot, and if you rename the variable that was used, the name of the variable might not update for the <b>Group</b> conditions but is only updated for the conditions in the <b>Condition</b> tab.
When you use AISense Recorder to automate applications on a Windows 10 Japanese operating system, the bot might encounter an error. Workaround: Enable UTF-8 encoding and restart the Bot Agent machine.

Limitations from previous releases
When you migrate a bot that was using the Manage Window Controls action, the last digit of the height value is not available after migration. However, the bot will execute successfully. (Service Cloud Case ID: 01756996)
When an Excel session is active in SAP, a corresponding Excel process starts in the background. In such a scenario, Automation 360 uses the same Excel process that SAP started. When you run a bot to automate spreadsheet data, Automation 360 processes the first request successfully. However, during execution, if the Excel is closed and a subsequent request is sent for automating the spreadsheet data, Automation 360 does not process the request because the Excel process is still being accessed by SAP. Therefore, the correct window is not activated for automating the spreadsheet data. (Service Cloud Case ID: 00815159)
<ul style="list-style-type: none"> <li>If you are updating from Automation 360 On-Premises v.21, remove the following Bot Agent files and folders: <ul style="list-style-type: none"> <li>C:\Windows\System32\config\systemprofile\AppData\Local\AutomationAnywhere\AA-DB.mv.db</li> <li>C:\ProgramData\AutomationAnywhere\GlobalCache\embedded-resources</li> </ul> </li> <li>Before you update from Automation 360 On-Premises v.22, refer to the upgrade considerations in <a href="#">Update Automation 360 to latest version</a> on page 1423.</li> </ul>
(Service Cloud case ID: 00837271) If you are migrating from Enterprise 11 with a database that has a large amount of repository data, the installation might fail. This issue occurs because Liquibase update for a few SQL queries is not completed during migration. Workaround: Contact Automation Anywhere Support.
When you try to automate any process in a Java application that uses version 11.0.8 of AdoptOpenJDK, the Recorder might not capture the drop-down elements on the application.
When you use the Recorder to capture an object, select <b>HTML Tag</b> , <b>HTML InnerText</b> , and <b>HTML type</b> properties in <b>Search Criteria</b> , or migrate a bot with similar properties selected in <b>Search Criteria</b> , the bot fails to identify or locate the object and perform the selected action. Workaround: Modify the <b>DomXPath</b> according to the controls you capture, or add more properties in <b>Search Criteria</b> .

**Limitations from previous releases**

When you use the **Browser > Close** action to close a tab or a window opened in the Microsoft Edge browser, if only one Microsoft Edge browser window is open, the bot encounters the following error: `Error occurred while closing the tab`

**Internet Explorer EOL updates**

**Note:** This release (Automation 360 v.25) includes features from Automation 360 v.24R2 (Build 13331). For information about what's available in the v.24R2 release, see [Automation 360 v.24R2 Release Notes for Internet Explorer 11 EOL](#) on page 347.

**Features**

Packages and actions

You can now migrate Internet Explorer bots from Enterprise 11 and Enterprise 10 to Automation 360 and convert the bots to **Microsoft Edge with IE mode** for the following actions and commands in the Web Recorder package:

- **Navigate URL, Go Back, and Search by Caption** actions.
- **Open Browser** and **Close Browser** commands. These commands are mapped to the **Legacy Automation > Open Page** and **Close Page** actions in **Microsoft Edge with IE mode**.

To launch Internet Explorer bots, in the **Legacy Automation** package, select the **Launch Internet Explorer in Edge compatibility mode** option.

To migrate and convert Internet Explorer bots, in the Control Room, from **Administration > Migration > Migrate bots**, select the **Convert bots built using Internet Explorer to Edge with Internet Explorer mode** option.

**Automation Co-Pilot for Business Users**

**Note:** For Automation 360 v.25, Automation Co-Pilot does not support an Oracle Database. You can continue to use Automation Co-Pilot with Microsoft SQL Server.

**What's new**

Use Bot Task labels to identify bot version to run

In **Bot Task**, you can now select the version of a bot for deployment by choosing between the **Latest version** and **Production label** options. When you deploy the bot, the version of the bot that you selected is run.

[Create a process automation in Process Composer](#) on page 3454

What's new
<p>Bot priority reference</p> <p>In <b>Bot Task</b>, you can now refer to the priority level of your bots. For bots that were set to a priority level, the <b>Bot priority</b> section now displays a <b>Low</b>, <b>Medium</b>, or <b>High</b> read-only label.</p> <p><a href="#">Create a process automation in Process Composer</a> on page 3454</p>
<p>Create request in new tab</p> <p>You can now open and run your new requests in a separate tab when you select the <b>Open request in New Tab</b> option in the initial form. With this option, you can create requests concurrently without changing your current page navigation.</p> <p><a href="#">Create a request and complete a task</a> on page 3384</p>
<p>Invalid scheduler</p> <p>An invalid scheduler is when a scheduler user has their role removed or when they cannot access a file because of missing permissions. Users who are notified of the invalid scheduler are the Control Room admin, the Automation Co-Pilot admin, and the Automation Co-Pilot user. Now, the Control Room admin will see an audit log change, the Automation Co-Pilot admin will see an error message to reassign a new scheduler user, and the Automation Co-Pilot user will see an error message in their process.</p> <p><a href="#">Assign a scheduler user to a process</a> on page 3415</p>
<p>Duplicate rows for Table element</p> <p>In the web interface, when you are adding rows to your form by using the <b>Table</b> element, you can now save time by duplicating a row in the table with the new <b>Duplicate row</b> option. The duplicated row will now be placed under the highlighted row that you had selected.</p>
<p>Interface triggers support more technologies</p> <p>You can now use interface triggers with the following technologies:</p> <ul style="list-style-type: none"><li>• Windows native</li><li>• SAP Desktop</li><li>• Google Chrome and Edge Chromium browsers</li></ul> <p><a href="#">Add an interface trigger</a> on page 2294</p>

**What's new**

## Enhancements to form rules

- Use custom formatting

When you are adding a rule, if you use the **If** menu to set the rule conditions on certain elements such as **Text Box** or **Text Area**, you can now select **Is** from the drop-down menu to enable additional options. Select the **Custom** option and click **Add regular expression** to apply custom formatting requirements on the selected element.

Consider a scenario where the user IDs of all your employees have AV as prefix. For example, for an employee whose name is Adam, the user ID is AVAdam. Use the **Add regular expression** option to set the value in the **Regular expression** field as ^AV. If a user enters Adam in the user ID field, an alert is displayed.

- Set custom value or append element value

When you are adding a rule, use the **Then** menu to select a form element. For this form element, you can set one of the corresponding actions using **Set Value** or **Append value**:

- **Value**: Data entered in the **Enter value** field is applied to the selected element.
- **Form element**: Data from the form element selected in the **Select element** drop-down menu is appended.

Consider a scenario where a user registration form has 'First name' and 'Employee ID' fields. You can set one of the following rules for the value in the Employee ID field:

- Select **Value** and enter Emp1013 as preset value.

This value is displayed in the 'Employee ID' field when the bot runs.

- Select **Form element** and set 'First name' element in the **Select element** drop-down menu.

The value from the 'First name' field is appended to the 'Employee ID' field when the bot runs.

You can use elements in the same way that variables are used in the Bot editor. You can enter **\$** to view a list of elements.

[Conditional actions, rules, and elements](#) on page 3428

**What's changed**

## Request reference for AARI web package

The Automation Co-Pilot web package now supports reference IDs. A reference ID is a combination of a prefix and a number that is created from a process key and is incremented every time a request is created. **Request ID** is replaced by **Request Reference**, and **Team ID** is replaced by **Team Reference**.

[Process Composer package](#) on page 2893

What's changed
<p>Process and package version changes in <b>Get Storage file</b> action</p> <p>The <b>Get Storage file</b> action now requires the matching of versions between the version of the process and the version of the package. Processes created before Automation 360 v.25 must be used with package versions from before Automation 360 v.25. Similarly, processes created after Automation 360 v.25 must be used with package versions after Automation 360 v.25.</p> <p><a href="#">Process Composer package</a> on page 2893</p>

Fixes		
Build	Service Cloud case ID	Description
15112	01841448, 1839118, 1844817, 01846153, 01846332, 01839254	When you download a series of packages from the bot compilation, the download is now faster.
15112	01847675	After you update to Automation 360 v.25, when you modify a process in a private workspace, you can now save your changes successfully, without encountering an error. Previously you will get a process error when you attempt to modify and save your process, or when you open the same process again.
15112	01848192	After you update to Automation 360 v.25, you can now insert or modify conditions, such as the <b>If/Else</b> logic, to your process without any issues. Previously when you made changes or add the <b>If/Else</b> element to the process logic, a <b>Go to</b> element would be added to the logic which caused a process error.
15097	01807181, 01809192, 01816444	Cloud users: You can now successfully upload a file for your requests. This applies to some scenarios when you upload a file and the request creation fails.
15097	01771877	In the process editor, at the end of your process, you can now drag <b>Go To</b> and add it to your <b>End Point</b> .
15097	01774331	When you use the <b>Row before scrolling</b> option from the <b>Table</b> element and specify a number of rows, the web interface now renders the correct number of rows that you specified.
15097	--	When you use the <b>Document</b> element and click the <b>Fit</b> option to fit your document in request view, the document is now scaled to fit the frame entirely.



Fixes		
Build	Service Cloud case ID	Description
15097	--	If you design a form with a drop-down rule applied to it, when you view the drop-down in read-only mode in the web interface, you can now view the changed data.
15097	--	After you are disconnected, when you log back in to the web interface, the <b>next=</b> parameter is no longer shown in the URL and you are now redirected to the page that you were on before you were disconnected.
15097	--	For the <b>Text Box</b> element, the <b>Does not contain</b> form rule now works correctly.
15097	--	For the <b>Rich Text Editor</b> element, the <b>Contains</b> form rule is now working correctly.
15097	--	When you create a form with the <b>Document</b> and <b>Dropdown</b> elements, you can now submit your form without issues.
15097	--	You can now use <b>Request Reference</b> as a parameter in the <b>AARI web</b> package.
15097	01803846	You can now use <b>Request Reference</b> in the <b>AARI web</b> package, for example, as an output for the <b>Create a Request</b> action. <b>Request ID</b> is now replaced by <b>Request Reference</b> .
15097	--	You can now successfully submit an initial form that has a table with no content, data, or rows.
15097	01803019	When you open and view a task, the task assignment now correctly shows the user assigned to that task.

Limitations
When you attempt to delete a request that is associated with more than one file, the deletion fails.
After you create a request from a private process, when you attempt to open and run the request in a new tab, a new tab is generated but it fails to run the request and the URL is not correct.

## Discovery Bot

Fix	
Service Cloud case ID	Description
00971940, 01018262, 01255326, 01829662	<p>You can now successfully record a process without encountering an error because when you log in to the Control Room, the proxy settings now support the following scenarios:</p> <ul style="list-style-type: none"> <li>• No proxy is enabled.</li> <li>• Proxy is entered with username and password.</li> <li>• Proxy is entered without username and password.</li> </ul> <p>Previously, when you recorded a process, if there was no proxy and if you entered a username and password with proxy enabled, an error occurred.</p>

Limitations from previous releases
<p>Depending on the memory available in your system, the PDD (in PDF or Microsoft Word format) can support up to 250 recorded steps captured in the document. If a process is recorded with more than 250 steps, the PDD generation periodically stops functioning.</p> <p>Workaround: Regenerate the PDD and click <b>Download</b>.</p>

## Document Automation

New capability: Document Automation is the new Cloud-native intelligent document processing solution that business users can set up to automatically read and process documents quickly using pretrained models and validation feedback.

Document Automation is fully integrated into Automation 360: Document Automation is installed as part of the Control Room. RPA bots are used to extract semi-structured or unstructured data to automate document-centric business processes, and Automation Co-Pilot for Business Users manages the end-to-end extraction process and validation tasks.

[Document Automation](#) on page 3625

Limitations
<p>Although the v.26 Document Extraction package appears in the .v25 On-Premises Control Room, features will not work as expected.</p> <p>Workaround if the package version is auto-synced: Manually change the Document Extraction package version to v.25. See <a href="#">Update bots to default package version</a> on page 1910.</p>
<p>Document Automation does not support SDS deployment.</p>
<p>Google Document AI pretrained models are available only for Cloud customers who purchased licenses through Automation Anywhere.</p>

Limitations
Customers who install Document Automation on Linux must separately download the Document Extraction package.
Document Automation supports a device username of 21 characters or fewer.
The value beside the <b>Validate documents</b> link, which indicates the number of documents awaiting validation for a learning instance, sometimes does not appear.
Learning instances that use Google Document AI models do not reliably extract tables that span multiple pages.
When you are validating a document in public mode, if you zoom in or out, you cannot drag the corners of the system-identified region (SIR) selection.
When you are validating a document, if you draw a box, zoom in, and then click <b>Fit to screen</b> , the box appears at a different location from where you clicked.
If you connect to a learning instance from Automation 360 IQ Bot with an optional field that has a set default value and some fields that are unmapped, when you process documents in that learning instance in Document Automation, the default value appears in the unmapped fields.
There is no notification if the product license is about to expire. When the product license expires, the <b>Learning Instances</b> tab is removed from the Control Room.
You might encounter extraction issues when you process documents with tables that span multiple pages.  Workaround: Contact your Customer Success Manager to download a patch for the Document Extraction package.
When a bot runs an action from the Document Extraction package, the <b>Activity &gt; In progress</b> page shows the item name as IQBotAutoExtract.
The Bot Agent does not verify whether the Document Extraction package version is compatible with the Control Room version prior to running a bot.
Document Automation cannot process documents in Automation Anywhere pretrained models if the Bot Agent runs through a proxy.  Workaround: <ul style="list-style-type: none"> <li>• With authentication: Create a Windows environment variable HTTP_PROXY with a value of <code>http://&lt;username&gt;:&lt;password&gt;@&lt;proxyhost&gt;:&lt;proxyport&gt;</code>.</li> <li>• Without authentication: Create a Windows environment variable HTTP_PROXY with a value of <code>http://&lt;proxyhost&gt;:&lt;proxyport&gt;</code>.</li> </ul>
If a document is renamed to a new file extension and uploaded to a Google Document AI pretrained model, the document will fail processing.  Workaround: Rename the document to the correct file extension.
Bots containing actions from the Document Extraction package must be deployed as part of an Automation Co-Pilot process. Standalone bots are not supported.

**Limitations**

In some cases, the Bot Agent does not clear out its resources folder. Until the disk space is freed, the production documents in processing will be affected. This issue occurs intermittently.

Workaround: Based on the issue, you must create a task scheduler to clean out the resources folder every day or every week.

**IQ Bot**

**Note:** For Automation 360 v.25, IQ Bot does not support an Oracle Database. You can continue to use IQ Bot with Microsoft SQL Server.

**What's new**

Migrate the roles associated with a learning instance

You can now retrieve a list of custom roles with access to a learning instance in a source environment and grant users in a destination environment access to the learning instance by using the Roles migration API.

[IQ Bot roles migration APIs \(A-People login required\)](#)

Track the number of pages processed in standard forms separately from IQ Bot

The Control Room Licenses page now shows the number of pages processed in standard forms, the Classifier, and through IQ Bot. If the licenses are added to the Control Room from the Cloud, the Licenses page also shows the number of pages processed in other Control Room instances.

[Automation 360 licenses](#) on page 1407

**What's changed**

Reinstall IQ Bot services using a new script

You can now reinstall all the IQ Bot services together in a batch or choose to reinstall them individually by using the reinstall-allservices.bat script.

[Postinstallation checklist](#) on page 1449

**Fixes**

Service Cloud case ID	Description
00780662	A round-off error no longer causes documents to fail formula validation. Previously, these documents were manually validated.
01763658	For the <b>Concatenate Images</b> action in the IQ Bot Pre-processor package, if a filename does not exceed 256 characters, the output is now successfully generated.

Fixes	
Service Cloud case ID	Description
01795651	When you export the IQBA file from a learning instance of a custom domain type with manual groups to another learning instance, the manual <b>Group Label</b> is now exported successfully. Previously, without a manual <b>Group Label</b> , it was difficult to distinguish between system-generated groups and manual groups for new learning instances.
00780712	When you import IQBA files using VisionBot data, among the learning instances, you can now see new groups created. Previously, new groups were not created when documents were uploaded.
--	An error message is no longer displayed when you change the display language of any learning instance that has a document in Validator. Previously, even if the selected display language was applied successfully to a learning instance, the system showed an error.
--	When you use the <b>Overwrite</b> option to import a learning instance, the <b>Default validations group</b> is now successfully overwritten. Previously, the <b>Default validations group</b> was not overwritten, and you needed to manually edit the learning instance after importing the IQBA file and then change the default group.
--	When you use the IQ Bot Extraction package, you can now view your document count on the <b>Details</b> page of the learning instance. Previously, if you processed documents that did not belong to any created groups, they were not displayed on the <b>Details</b> page of the learning instance.
--	You can now sort the <b>PagesUpload</b> column in the <b>Learning instance &gt; Document Group</b> tab. Previously, the following error message was displayed: <i>System error, please try again after some time</i>
--	On the Designer, when you resize the system identified region (SIR) of an automapped field, the values from the resized selection are now captured accurately in the corresponding value field.
--	Database Migration Assistant Tool now notifies with an error if there are any environmental issues (such as missing DLL). Previously, the tools and logs indicated that migration was complete, even if a unified database was not created.
--	When a non-English filename is uploaded using the Invoice domain and processed using the AutoExtract command, system identified regions are now generated. Previously, to process the documents successfully, you had to convert the non-English filename to English characters.

Fixes	
Service Cloud case ID	Description
--	If you import a learning instance with a set default validation group to an environment where the learning instance was previously deleted, the default validation group setting stays intact. Previously, the imported learning instance appeared without the default validation group.
--	The column header name for the <b>Default validations group</b> now appears in the <code>Projectdetails.csv</code> file obtained from exporting a learning instance.
--	For a standard forms learning instance, if you try to process a large number of documents (more than 10,000) by using the <b>Process documents</b> action from the IQ Bot Extraction package, some of the documents might not be processed.
--	During IQ Bot Extraction package updates, even when you use the Tesseract4 OCR, there is no delay in the document processing time and throughput results.
--	In standard forms learning instances, you can now set a default value for optional fields. If extraction fails for an optional field, the system uses the default value you set.
--	You can now access standard forms learning instances created in earlier IQ Bot versions that were installed with the CyberArk vault key.

Limitations
<p>IQ Bot Cloud: If you do not access IQ Bot within the configured <b>Ideal time out</b> value set on the IQ Bot server, the following things happen:</p> <ul style="list-style-type: none"> <li>• A message to restart IQ Bot is displayed.</li> <li>• Bots that use IQ Bot APIs fail when the server is restarted.</li> </ul> <p>Refresh the IQ Bot web page after some time (more than 5 minutes) to log in to IQ Bot.</p>
<p>On the Validator screen, if incorrect values are used to update a field on which you have applied validations, an alert is not displayed when the focus is lost from that field.</p>
<p>If you use the <b>Process documents</b> action from the IQ Bot Extraction package to extract content from a large number of documents (more than 1 million), an error message is displayed and IQ Bot might stop responding.</p>

Limitations
<p>When you access the IQ Bot application on Internet Explorer11, the following functions do not work as expected:</p> <ul style="list-style-type: none"> <li>• <b>Export</b> option on the dashboard</li> <li>• Icons in the menu list</li> <li>• <b>Actions list</b> on the <b>Bots</b> page</li> <li>• <b>Action</b> icon for learning instance</li> <li>• Validator functionality, such as the following: <ul style="list-style-type: none"> <li>• Add rows</li> <li>• Delete rows</li> <li>• Search functionality</li> <li>• Hide icon</li> <li>• Data type for form fields</li> </ul> </li> </ul>
<p>In the IQ Bot Community Edition, when you use a Cloud OCR to create a learning instance, if you use the IQ Bot <b>Process document</b> action from the IQ Bot Extraction package, the values from the uploaded invoices or documents are not processed successfully.</p> <p>Workaround: If you use the Cloud OCR to create a learning instance, use the IQ Bot <b>Upload Document</b> action from the IQ Bot package.</p>
<p>When you click the <b>Create Backup</b> option on the <b>Migration Management</b> page and select the learning instances to be backed up by using the <b>Search</b> drop-down list, the learning instances selected become deselected. As a result, you cannot take a backup of the learning instances.</p> <p>Workaround: Instead of using the <b>Search</b> drop-down list, select learning instances from the list on the <b>Backup Learning Instance</b> page.</p>
<p>In a Native Validator learning instance, when you try to enter data into or modify the data in a child table that does not exist in the parent table, no error is prompted, which leads to documents being saved with incorrect values.</p>
<p>When you use the IQ Bot Extraction package along with other OCR-based commands (such as IQ Bot Pre-processor, Document Classifier, AISense Recorder, and OCR) in a single bot, the bot fails.</p> <p>Workaround: Ensure that you create separate bots for IQ Bot Extraction, and do not run IQ Bot Extraction in conjunction with other packages that include the 12.2 Abbyy OCR.</p>
<p>When you install IQ Bot with Windows authentication and CyberArk Vault, it is not possible to rotate the key, and the following error message is displayed: <code>Error occurred while setting up the new key. Please check the logs</code></p>
<p>In some cases, the Bot Agent does not clear out its resources folder. Until the disk space is freed, the production documents in processing will be affected. This issue occurs intermittently.</p> <p>Workaround: Based on the issue, you must create a task scheduler to clean out the resources folder every day or every week.</p>

Limitations
If you have a document with more than 100 pages, an error message is displayed intermittently when you click <b>See extraction results</b> for an existing learning instance.
If you use the ABBYY FineReader Engine version 12.4 instead of version 12.2, the MICR feature does not support data extraction from documents in Japanese language.
When you download an unclassified document, click <b>Delete from the server</b> , and then toggle the learning instance from production to staging, and vice versa, as a consequence, the same document starts reappearing in the untrained output folder, and when you download the document from untrained groups, the same document reappears even though it has been deleted.
<p>When you upload documents to production using <b>IQ Bot Upload &gt; Run the command</b>, toggle the learning instance from production to staging, and then toggle back to production, all unprocessed documents appear blurred.</p> <p>Workaround: Upload documents to Staging using an API. <a href="#">Upload document to Staging API (A-People login required)</a></p>
<p>As a result of upgrading Control Room and IQ Bot from A360.21 to A360.25, you are unable to edit groups in the learning instances, and move groups from Staging to Production.</p> <p>Workaround:</p> <ol style="list-style-type: none"> <li>1. Restore the latest IQ Bot database backup.</li> <li>2. Run the delete query.</li> <li>3. Delete from EncryptionKey.</li> <li>4. Run the following query: <code>INSERT INTO EncryptionKey ([Key], [Type]) VALUES ('xDxQoAhIc/R0nF+bFXHuo6/UGnm6Hqs/uBVxYpz1IdU6UAEUUVYf5vnFJU6qkBcnCAvdQOUjdwrJWwWW4LdKA=','data')</code></li> <li>5. Start the A360.25 installer.Post upgrade checklist:</li> <li>6. Ensure that following logs details are not available in installion-helper.log file: [ INFO]: main/com.automationanywhere.cognitive.installationhelper.infrastructure.datarotation.DataRotationServiceImp - Rotation starts.</li> <li>7. Run the API, and ensure that the filename has proper value (it should not be "fileName" : "THIS STRING IS NOT ENCRYPTED",). <a href="http://localhost:9996/organizations/1/projects/%7BLearningInstanceID%7D/categories/%7BgroupNumber%7D/files">http://localhost:9996/organizations/1/projects/%7BLearningInstanceID%7D/categories/%7BgroupNumber%7D/files</a></li> </ol> <hr/> <p><b>Note:</b> Replace the value of {LearningInstanceID} and {groupNumber} properly. Also, GroupNumber should belong to same learning instance.</p> <hr/>
There is no notification if the product license is about to expire. When the product license expires, the <b>Learning Instances</b> tab is removed from the Control Room.



## Bot Insight

What's changed
<p>Dashboards now require the use of the Analyze package version 2.3.0-20210922-121532 or later. This version of the package is available from Automation 360 v.23.</p> <p><a href="#">Bot Insight dashboards</a> on page 3929</p>

Fixes	
Service Cloud case ID	Description
01755186	When you use a filter on an individual widget, the filter is now correctly applied only to that filter, as expected. Previously, a filter meant for a specific widget was sometimes applied to other widgets, as well.

## Automation Anywhere for Genesys

What's new
<p>Automate tasks for Genesys platform with Genesys package for Automation 360</p> <p>Use the actions in this package for onboarding and updating records in the repository. Each action palette offers single and bulk record creation and delete/remove actions for records. You can list or search records for referencing the IDs required for updating other records. You can also organize the records for communication purposes and contextual insight. The action palettes in this package include the following:</p> <ul style="list-style-type: none"> <li>Record creation: User, Division, Phone, External contacts</li> <li>Organize records: Group, Queue, External organization</li> <li>Record attributes: Language, Role, Skill</li> </ul> <p><a href="#">Genesys package</a> on page 2659</p>

## Feature deprecations

Review features and capabilities (from Automation Anywhere or other third-party vendors) that are deprecated or nearing deprecation to understand how they impact your automation. For more information, see also this page: [Feature deprecations affecting Automation Anywhere products](#) on page 1086.

#### Human-Bot Collaboration 11.3.x deprecated

The Human-Bot Collaboration (HBC) 11.3.x was deprecated from August 2020 with the release of Enterprise A2019.15, after which the product has not been actively developed or maintained. Customers that are using HBC 11.3.x are required to migrate to the Automation 360 platform to use Automation Co-Pilot for Business Users (Automation Co-Pilot), Web or Desktop. For this migration, there is no automated migration path because of an absence of parity between the two products (including sets of features). Any path that you take to migrate from HBC 11.3.x to the Automation 360 platform will involve significant manual steps to convert and map bots and other assets (such as forms, teams, and tasks) to Automation Co-Pilot assets (such as bots, forms, processes, teams).

[Feature deprecations affecting Automation Anywhere products](#) on page 1086

#### Basic authentication in Exchange online

Microsoft has announced that starting October 1, 2022 Basic authentication will be permanently disabled in Exchange Online. This change will impact bots used for email automation that connect to Exchange Online with Basic authentication using IMAP, POP3, or EWS protocols. Hence, Microsoft recommends customers to switch from Basic authentication to OAuth 2.0.

To maintain business continuity of the impacted bots, Automation 360 customers and partners can leverage the OAuth 2.0 feature support in Email package and Email trigger that will be delivered in the week of Aug 29th, 2022.

[Deprecation of Basic authentication in Exchange Online](#) on page 1123 | [Everything about Basic Authentication deprecation in Microsoft Exchange online \(A-People login required\)](#)

#### Manifest V2 extensions for Google Chrome and Microsoft Edge

As Google will deprecate Manifest V2 extensions by June 2023, this might impact your existing automations that use our current MV2 extensions in Google Chrome and Microsoft Edge browsers. You can choose to use the enterprise group policy to continue to use Manifest V2 extensions until June 2023([Manifest V3 transition timeline](#)). However, post this date, you have to switch to Manifest V3 extensions for your automations to work.

We plan to provide Manifest V3 extensions for Google Chrome and Microsoft Edge with our next release Automation 360 v.26. We recommend that you now start planning to switch to Manifest V3 extensions.

[Chrome and Edge Manifest V3 extensions](#) on page 1138

**Tesseract v3 OCR planned change from October 2022**

Tesseract is an open source OCR engine leveraged by Automation 360 IQ Bot as part of document processing and extraction. Tesseract v3 has not been updated since 2018, and it will no longer be packaged with Automation 360 IQ Bot from the next release v.26 (planned for October 2022).

Tesseract 3 OCR was removed as an option from the IQ Bot learning instance creation user interface about 2 years back (in our v.13 release). However, we continued to package this older OCR version, which ensured that learning instances previously created on Tesseract 3 can function.

Starting from our next release Automation 360 v.26, Automation 360 IQ Bot will no longer package Tesseract 3. From v.26 release, document processing against learning instances with Tesseract 3 will result in an error, indicating that this OCR version is not available. However, the learning instances will remain in the system, allowing customers to view their details and train with alternative OCR options (including Tesseract v4 OCR).

For all existing learning instances trained using Tesseract v3 OCR, we recommend that you plan to train them with alternative OCRs (including Tesseract v4), before you update to v.26. Note that Automation 360 IQ Bot Cloud customers will receive v.26 release by default from October.

**IQ Bot Extraction package deprecation from October 2022**

As part of Automation 360 v.25, IQ Bot Extraction package will no longer support pre-trained machine learning model for invoice data extraction, but will continue to support learning instance group based-training extraction.

We have released a new set of capabilities on pre-trained models with Document Automation as part of v.25 release, including a new command package called Document Extraction. IQ Bot Extraction package will be deprecated starting from the next release Automation 360 v.26, so we recommend our customers to start leveraging this new Document Extraction package.

For more information about Document Extraction package and instructions on how to move learning instances to Document Automation, see [Move from IQ Bot Extraction package to Document Automation](#) on page 2752.

## Automation 360 v.24R2 Release Notes for Internet Explorer 11 EOL

Release date: 17 May 2022

This release notes applies to the Automation 360 v.24R2 patch release for Cloud, On-Premises, Sandbox, and Community Edition users impacted by the Internet Explorer end-of-life (IE EOL) and who have therefore chosen to convert IE bots.

Cloud, On-Premises, IQ Bot, Sandbox, and Community Edition are on Build 13343.

---

**Note:** The IQ Bot build does not include any specific updates and is available to match the Control Room build.

---

## Why this release

Microsoft has announced end-of-life (EOL) for Internet Explorer beginning June 2022 and recommends Microsoft Edge or Microsoft Edge in IE mode. This release contains packages certified on Edge in IE mode and an IE Update Bot wizard to help you update bots in bulk to work with Edge in IE mode. The upcoming IE EOL might affect your deployments based on the operating system you are currently using where the bots are run.

See the following table for details:

Microsoft operating system	Automation 360 bots
Windows 10 Semi-Annual Channel	Upgrade the bots to use a compatible browser.  For a list of supported browsers, see <a href="#">Browser requirements for Automation Workspace</a> on page 1210.
All other supported operating systems	No immediate impact

Starting from the upcoming Automation 360 v.25 release, you will be prompted to access the Control Room through an alternative supported browser, such as Google Chrome or Microsoft Edge (Chromium) instead of Internet Explorer. Your Control Room will no longer be accessible on Internet Explorer. By aligning with Microsoft's strategy for browser support, we can provide you with enhanced functionality that latest browsers such as Google Chrome and Microsoft Edge make technologically possible.

## Updating to this release

You can update to Automation 360 v.24R2 On-Premises from the following previous releases that are certified for update:

- v.24 (Build 12350)
- v.23 (Build 11513)
- v.22 (Build 10526)
- v.21 (Build 9664, 9642, 9595)

As Community Edition and Sandbox are Cloud deployments, no manual upgrade is required. These environments are automatically updated to Automation 360 v.24R2 Build 13343.

If you are not on any of the above certified releases, update Automation 360 to one of the certified releases (listed previously) before updating to this release.

For information on updating to this release, see these resources:

- [Update Automation 360 to latest version](#) on page 1423
- [Automatically update the Bot Agent](#) on page 1361 | [Manually update the Bot Agent](#) on page 1362
- [Compatibility with release builds](#) on page 1333

For the latest updates to the Automation 360 extensions for Google Chrome, Microsoft Edge, and Mozilla Firefox, see [Browser extensions for Automation 360](#) on page 985.

## Bot Agent updates

This release includes an optional Bot Agent update. To use the features in Automation 360 v.24R2 patch, update the Bot Agent available with the following builds:

- Bot Agent version 21.200 for Build 13343
- Bot Agent version 21.1000.14009 for Build 13331 (On-Premises pre-GA)

Note that if you want to run your existing bots, you do not have to update your Bot Agent to this release.

If you have installed the Automation 360 v.24R2 pre-GA patch (Build 13331) with Bot Agent version 21.1000.14009, perform the following steps.

1. Uninstall the pre-GA Bot Agent version 21.1000.14009.
2. Install Bot Agent version 21.200 for Automation 360 v.24R2 (Build 13343).

---

**Important:** If you have moved your bots from the user acceptance testing (UAT) environment and deployed them in a production (PROD) environment with Bot Agent version 21.1000.14009, you must update the packages with the latest Bot Agent version 21.200.

---

## Community Edition features

Packages
<p>Microsoft Edge browser support for Browser package and window variables</p> <ul style="list-style-type: none"> <li>• The following actions of the Browser package now support Chromium-based Microsoft Edge browser: <ul style="list-style-type: none"> <li>• Close</li> <li>• Get source code</li> <li>• Go back</li> <li>• Open</li> <li>• Run JavaScript</li> </ul> </li> <li>• In the <b>Browser</b> option, you can now select the Microsoft Edge tabs from the list of active tabs.</li> </ul>
<p>Support for last used browser tab in <b>Browser &gt; Open</b> action for Microsoft Edge and Google Chrome</p> <p>You can now open a web page on a new tab or an existing tab using the <b>Last used browser tab</b> preset in the following browsers:</p> <ul style="list-style-type: none"> <li>• Microsoft Edge</li> <li>• Microsoft Edge with IE mode</li> <li>• Google Chrome</li> </ul>

Packages
<p>Automate Java web applications</p> <p>You can now automate Java web applications that run on Microsoft Edge Chromium with IE mode by using the <b>Recorder &gt; Capture</b> or the <b>Start recording</b> option.</p>
<p>Default wait time for loading page in Microsoft Edge browser with IE mode</p> <p>When you automate any web applications in Microsoft Edge browser with IE mode, the Recorder now waits for 30 seconds by default to allow the web page to load completely before recording any objects on the page, thereby making object detection more reliable.</p>

## Cloud, On-Premises, and Sandbox features

Control Room and Packages
<p>New <b>Update Bot wizard</b> for Internet Explorer</p> <ul style="list-style-type: none"> <li>Use the new <b>Update Bot wizard</b> in the Control Room to convert your existing Internet Explorer bots to Microsoft Edge with IE mode to ensure that these converted bots continue to run after IE EOL. <ul style="list-style-type: none"> <li><a href="#">Update Bot wizard for converting IE bots</a> on page 1118</li> </ul> </li> <li>As an administrator, you can enable a user to use the <b>Update Bot wizard</b> by assigning the new Bot update feature permissions to access and convert a bot from Internet Explorer to Microsoft Edge with IE mode. <ul style="list-style-type: none"> <li><a href="#">Feature permissions for a role</a> on page 1749</li> </ul> </li> <li>Use the <b>View Bot update</b> action in a bot conversion instance to view the summary and status of each bot conversion. You can review action details at the individual line numbers and take action if required for the bots that are in failed status, or in completed with action or review required status. <ul style="list-style-type: none"> <li><a href="#">View conversion details for IE bots</a></li> </ul> </li> </ul>
<p>Automate Java web applications</p> <p>You can now automate Java web applications that run on Microsoft Edge Chromium with IE mode by using the <b>Recorder &gt; Capture</b> or the <b>Start recording</b> option.</p>

**Control Room and Packages**

Convert Automation 360 bots with browser-specific packages using Internet Explorer to Microsoft Edge with IE mode

You can convert bots that use Internet Explorer to Microsoft Edge Chromium with IE mode for the following packages:

- Recorder
- Browser
- Application
- Simulate keystrokes
- Screen
- Mouse
- Window
- OCR
- App Integration
- Image Recognition
- If
- Loop
- Wait

To convert these bots, use the Update Bot wizard in the **Administration > Bot update** tab in the Control Room.

[Update Bot wizard for converting IE bots](#) on page 1118

The following properties of browser-based packages and actions are updated from Internet Explorer to Microsoft Edge browser with IE mode:

- Bots created using the browser or application-based window, window title, and application path
- Window variable's default value, window title, and window application path
- Browser variables and browser title

Microsoft Edge browser support for Browser package and window variables

- The following actions of the Browser package now support Chromium-based Microsoft Edge browser:
  - Close
  - Get source code
  - Go back
  - Open
  - Run JavaScript
- In the **Browser** option, you can now select the Microsoft Edge tabs from the list of active tabs.

**Control Room and Packages**

Support for last used browser tab in **Browser > Open** action for Microsoft Edge and Google Chrome

You can now open a web page on a new tab or an existing tab using the **Last used browser tab** preset in the following browsers:

- Microsoft Edge
- Microsoft Edge with IE mode
- Google Chrome

Default wait time for loading page in Microsoft Edge browser with IE mode

When you automate any web applications in Microsoft Edge browser with IE mode, the Recorder now waits for 30 seconds by default to allow the web page to load completely before recording any objects on the page, thereby making object detection more reliable.

**Migration features**

Scan bots that use Microsoft Internet Explorer

You can now use the Bot Scanner to scan and identify Internet Explorer bots. You can also analyze the report generated by the Bot Scanner to get usage statistics about Internet Explorer used in your bots.

[Bot Scanner for EOL features](#) on page 1531 | [Analyze report for Internet Explorer bots](#) on page 1115 | [Internet Explorer conversion or scanning messages](#) on page 1715



### Migration features

#### Packages and actions

You can now migrate and convert Internet Explorer bots from Enterprise 11 or Enterprise 10 to Automation 360 with Microsoft Edge with IE mode for the following packages and actions:

- App Integration
- Delay
- IF/ELSE and Loop
- Image Recognition
- Launch Website
- Manage Window Controls
- MetaBot Screen
- Mouse
- Object Cloning

**Image Play** mode and **Coordinates Play** mode are supported. **Coordinates Play** mode supports the mouse click action with keystrokes after it.

- OCR
- Open Program/File
- Screen
- Simulate keystrokes
- Wait

Support for **Wait for condition**, **Wait for screen change**, and **Wait for window** actions

- Web Recorder
- Windows Actions

For more information, see [Package mapping for migration](#) on page 1620.

To migrate and convert bots, go to **Administration > Migration > Migrate bots** and select the **Convert bots built using Internet Explorer to Edge with Internet Explorer mode** option in the Control Room.

The following properties of browser-based commands and actions are updated from Internet Explorer to Microsoft Edge with IE mode:

- Bots created using the browser or application-based window, window title, and application path
- Window variable's default value, window title, and window application path

---

**Note:** Bots that use value type variables are not updated to Microsoft Edge. You must first enable the configure settings in the Legacy Automation package to open bots built using Internet Explorer to Microsoft Edge compatibility mode.

---

- Browser variables and browser title

Migration features
<p>Convert IE bots to Microsoft Edge with IE mode</p> <p>When you migrate your bots from Enterprise 10 or Enterprise 11, you can use the new <b>Convert bots built using Internet Explorer to Edge with Internet Explorer mode</b> option in the Bot Migration Wizard to convert your bots from Internet Explorer to Microsoft Edge with IE mode.</p> <p><a href="#">Migrate Enterprise bots</a> on page 1590</p>
<p>History and version updated for migrated bots</p> <p>In the Bot Migration Wizard, when you migrate your Enterprise 10 or Enterprise 11 bots, the version history is now updated to show that it is a migrated bot (the check-in comment shows that the bot is migrated from Enterprise 10 or Enterprise 11 version). You can use this check-in comment to identify which version of the bot is migrated.</p> <p><a href="#">Bot Migration Wizard</a> on page 1587</p>

## Fixes

The following fixes are available for Cloud , On-Premises , and Sandbox:

Service Cloud case ID	Description
01784593	You can now run migrated bots successfully even when a \$ (dollar sign) is present as a value in the <b>User Variables</b> field. The Bot Scanner no longer displays a preprocessing error.
--	When you automate web applications running on Microsoft Edge Chromium with IE mode or Internet Explorer, the Recorder now captures the object from the currently selected browser tab. Previously, the Recorder captured the object from the last used tab.
01189873	<p>After migration, when you use the <b>Browser &gt; Open</b> action to open a URL that has a space character, use the <b>Browser &gt; Download files</b> action to download the file from the specified URL, and then run the bot, the bot now opens the URL in a single tab and downloads the file from the specified URL.</p> <p>Previously, when the specified URL had a space character, the bot split the URL and opened it in two separate tabs.</p>

## Known behavior and limitations

The following limitations apply to Cloud , On-Premises , and Sandbox:

- When you execute a stored procedure with name parameter arguments that resides in another database in the SQL Server, the bot displays an error because of the JDBC driver issue with

executing a stored procedures with name parameters of another database in the same SQL instance.

Workaround: When you add parameters to provide an input parameter or configure an output parameter, ensure you do not enter any value in the **Parameter name** field. The bot will not encounter any error when executing the stored procedure because the Database package considers blank values as indexing.

- Note that even when the number of schedules listed on the Control Room **Schedules** page is less (for example, five or six schedules), you might see the following error because of a query timeout: `An unexpected problem occurred`. This is an existing Control Room database performance related issue.
- There are other limitations and behavior that apply to bots migrated from Enterprise 11 to Automation 360 and to Automation 360 bots that run on Internet Explorer and are converted to Microsoft Edge with IE mode. For more information, see [Known behavior and limitations](#) on page 1108.
- When you use the **Browser > Close** action to close a tab or a window opened in the Microsoft Edge browser, if only one Microsoft Edge browser window is open, the bot encounters the following error: `Error occurred while closing the tab`
- When you use the **Browser > Open** action to open network URLs that start with two backslash (\\) characters in the Google Chrome, Microsoft Edge, or Mozilla Firefox browser, the URLs might not open properly.

Workaround: Replace the two backslash (\\) characters with file:// protocol.

- When you use the **Browser > Open** action, select **New tab** or **Existing tab** option to open a specific webpage in Microsoft Edge with IE mode, the bot might throw an error after opening the webpage.

Workaround: Use any of the following workarounds based on specific scenarios:

- Option 1: Add **Try/Catch** block around the **Open** action and ignore the exception as the website opens.
- Option 2: In the **Browser > Open** action, select the **New window** option instead for such websites.
- When you use the **New window** option in the **Browser > Open** action with the 3.4.x version of the Browser package to open a URL with arguments, the bot might not perform the specific action as the 3.4.x version of the Browser package does not support argument flags.

Workaround: Use any version other than the 3.4.x version of the Browser package to automate.

See also these resources:

- [Microsoft Internet Explorer EOL overview](#) on page 1097
- [Microsoft Internet Explorer 11 EOL FAQ](#) on page 1100

Related concepts

[Microsoft Internet Explorer 11 EOL FAQ](#) on page 1100

Microsoft has announced end-of-life (EOL) for Internet Explorer beginning June 2022 and recommends using Microsoft Edge or Microsoft Edge in Internet Explorer (IE) mode. This will impact automations (bots) based on the operating system currently in use where the bots are run.

[Microsoft Internet Explorer EOL overview](#) on page 1097

Microsoft has announced retiring Internet Explorer (IE) for certain versions of Windows operating systems and recommends impacted users to move their apps or websites running on IE to Microsoft Edge with IE mode.

Related information

[Enterprise 11 and upcoming Internet Explorer 11 EOL FAQ](#)

## Automation 360 v.24 Release Notes

Release date: 08 April 2022

Review what's new and changed, and the fixes and limitations in the Automation 360 v.24 (Build 12350) release.

---

**Important:** We have updated the Automation 360 v.24 (Build 12350) to include fixes for the following issues:

- After migration, when you ran the migrated bots, they displayed an error for variables within double quotation marks (" ") (Service Cloud case ID: 01802575, 01803323, 01803800, 01804121, 01804820).
- When you clicked the Automation Co-Pilot icon, the Control Room was displayed instead of the Automation Co-Pilot Desktop Assistant sign-in screen (Service Cloud case ID: 01803979).

- 
- Migration
    - [11.x and 10.x](#) | [11.x only](#) | [10.x only](#)
  - Automation Workspace
    - [What's new](#) | [What's changed](#) | [Fixes](#) | [Limitations](#)
  - Automation Co-Pilot
    - [What's new](#) | [What's changed](#) | [Fixes](#) | [Limitations](#)
  - Discovery Bot
    - [What's new](#) | [Fixes](#) | [Limitations](#) | [Feature Deprecation](#)
  - IQ Bot
    - [What's new](#) | [Fixes](#) | [Limitations](#)
  - Bot Insight
    - [What's changed](#) | [Fixes](#) | [Limitations](#)

## Updating to this release

You can update to Automation 360 v.24 from the previous three releases (that is, from n–3 releases, where n refers to the latest release). The following previous releases are certified for update to this release:

- v.23 (Build 11513)
- v.22 (Build 10526)
- v.21 (Builds 9664, 9642, 9595)

You can directly update to v.24 from any of these builds (see [Update Automation 360 to latest version](#) on page 1423). If you are not on an n-3 release, update Automation 360 to one of the three certified releases (listed previously) before updating to this release.

- If you are directly updating to this release from Automation 360 On-Premises v.21, remove the following Bot Agent files and folders:
  - C:\Windows\System32\config\systemprofile\AppData\Local\AutomationAnywhere\AA-DB.mv.db
  - C:\ProgramData\AutomationAnywhere\GlobalCache\embedded-resources
- Before you update to this release from Automation 360 On-Premises v.22, refer to the upgrade considerations in [Update Automation 360 to latest version](#) on page 1423.

---

**Important:** This release includes an optional Bot Agent update. To use the new features in v.24 (including updates to Bot Migration, Browser, DLL, Process Discovery, and Recorder packages), update the Bot Agent available with this release. However, note that if you want to run your existing bots, you do not have to update your Bot Agent to this release.

---

For information on updating to this release, see these resources:

- [Automatically update the Bot Agent](#) on page 1361 | [Manually update the Bot Agent](#) on page 1362
- [Compatibility with release builds](#) on page 1333

For the latest updates to the Automation 360 extensions for Google Chrome, Microsoft Edge, and Mozilla Firefox, see [Browser extensions for Automation 360](#) on page 985.

---

**Important:** This release includes new command packages in which the Apache log4j2 library is no longer bundled. However, older command packages, from Automation 360 v.23 and earlier, might continue to have the log4j2 library bundled within. If you want to use command packages without the log4j2 bundled within, we recommend that you use the newer Automation 360 v.24 packages in your tasks.

---

## Migration

Enterprise 11 and Enterprise 10 features
<p>Self-service Control Room migration</p> <p>You can now manage the migration provisioning process with self migration capabilities. You can also choose between manual and automated migration.</p> <p><a href="#">Self-service Control Room Migration</a> on page 1418</p>
<p>Enhancement to migration of Credential Vault variables</p> <p>Migration is now supported when Credential Vault variables are passed from one MetaBot Logic to another MetaBot Logic for the following commands:</p> <ul style="list-style-type: none"> <li>• <b>IF &gt; Logic Successful</b></li> <li>• <b>IF &gt; Logic Unsuccessful</b></li> <li>• <b>Begin Error Handling &gt; Run Logic</b></li> </ul>

Enterprise 11 and Enterprise 10 features
<p>You can now successfully migrate Enterprise 11 bots that use the 32-bit <code>wscript.exe</code> to the 64-bit architecture, without exception errors. This enhancement helps you to successfully execute VBScript.</p>
<p>Migrate MetaBot with parent and child Logic with renamed Logic</p> <p>You can now migrate a MetaBot with a Logic (parent) that includes a renamed Logic (child). If a child Logic is renamed after it is mapped to the parent Logic, this parent Logic mapping is now migrated with the new name.</p> <p>This enhancement applies to the following commands:</p> <ul style="list-style-type: none"><li>• <b>IF &gt; Logic Successful</b></li><li>• <b>IF &gt; Logic Unsuccessful</b></li><li>• <b>Else If &gt; Logic Successful</b></li><li>• <b>Else If &gt; Logic Unsuccessful</b></li><li>• <b>Error Handling &gt; Run Logic</b></li><li>• <b>Run Logic</b></li></ul>
<p>Migrate when MetaBot and Logic have the same name</p> <p>You can now successfully migrate your Enterprise 11 bots when the name of the MetaBot and the assets folder or the Logic name inside that MetaBot are the same. The Logic name is suffixed with <code>-bot</code>. The name is appended only when the Logic or the folder is on the same hierarchy as the MetaBot.</p> <ul style="list-style-type: none"><li>• If an existing bot has the renamed Logic or assets folder, the Logic is then renamed with the next available number. For example, <code>-botn</code>, where <code>n</code> indicates the next available number. Additionally, an action required message is displayed.</li><li>• If a MetaBot or a Logic calls a renamed Logic or Task Bots, the command path is updated to include the new name.</li><li>• If a Logic, MetaBot, or a folder name exists with a new name, the existing bot is overwritten.</li></ul> <p><a href="#">Migration messages</a> on page 1678</p>
<p>Consolidated view of migrated bots and their status</p> <p>Use the <b>Overview</b> tab in the Control Room to get a consolidated view of the status of the migrated bots. View the overall status of bot migration for all the bots that are successfully migrated, those that failed to migrate, and those that require review or action. You also have the option to rerun migration on selected bots and view the history of each bot that has gone through multiple migrations.</p> <p><a href="#">Bot Migration Wizard</a> on page 1587</p>

**Enterprise 11 only features**

Update to AAApplicationPath, CurrentDirectory, and AAInstallationPath variables

If your migrated bot contains \$AAApplicationPath\$, \$CurrentDirectory\$, or \$AAInstallationPath\$ variables in any file or folder path, a validation check for the absolute path is no longer performed during migration. Also, a temporary variable (\$m-string-start-in-path\$) is not created and assigned to the migrated bot for validation. As a result, the size of a migrated bot is now reduced and the bot performance is enhanced.

Enhancement to migrate bots with Email Connect command

When you migrate Enterprise 11 bots that contain the **Email > Connect** and **Email > Send** commands configured for EWS server, the **Azure Cloud** field is set to **Azure Global** and the **Authentication type** is set to **OAuth2-Silent** which was previously called OAuth2.

Note that **OAuth2** now supports two modes: **Silent** and **Interactive**.

[Using Connect action in Email package](#) on page 2523

Migrate bots with timeout configured to send REST and SOAP request

The timeout value configured in Enterprise 11 to send REST and SOAP requests is now migrated to Automation 360 as part of the global values (AARestTimeOut and AASoapTimeOut). The default timeout value is set as 60000 ms in Automation 360. You can update this value if the REST Web Service takes more time to receive a response.

[REST Web Service package](#) on page 2961 | [Example of using the SOAP web service action](#) on page 3240

**Enterprise 10 only features**

Migrate new or modified Enterprise 10 bots to Automation 360 (Service Cloud case ID 00719524)

You can now migrate new or modified Enterprise 10 bots to Automation 360 after an earlier migration. A new export utility is now available that enables you to export such new and modified bots from the Enterprise 10 Control Room repository. You can then import the exported bots later to Automation 360 using Bot Lifecycle Management (BLM) and then finally migrate them using the Bot Migration Wizard.

[Migrate new or updated Enterprise 10 bots to Automation 360](#) on page 1584

## Automation Workspace

What's new
<p><b>Bot Agent updates and early availability of packages</b></p> <p>Starting from this release, you can choose or skip some Bot Agent updates and start using packages as soon as new package versions become generally available regardless of your region.</p> <p>Bot Agent updates that support new packages or updates to packages will be made available quarterly, with updates alternating between mandatory and optional.</p> <p>Previously, Bot Agent updates were available automatically across user device pools without affecting bot execution. In some large and complex deployment scenarios, these updates were cumbersome but could not be skipped. (Examples include deployments where the device pools were deployed using standard device Amazon Machine Image (AMI) on separate schedules requiring greater coordination, change management processes, and approvals in the user environment for the Bot Agent update.) Now, you can skip an optional update and update to the next mandatory Bot Agent update as Automation 360 will start providing reverse compatibility with Bot Agent for a release every six months.</p> <p>Also, with every release, you can start using the latest packages as soon as new package versions are released. For Automation 360 Cloud users, package updates are now available asynchronously across all regions, so you can start using the latest packages on the current Control Room version even before the Control Room update is made available for your region.</p> <p><a href="#">Compatibility with release builds</a> on page 1333</p>
<p><b>Create multi-login users</b></p> <p>You can now create a multi-login user. A multi-login user is allowed multiple sessions to the Control Room through the API.</p> <p><a href="#">Multi-login user</a> on page 1746  </p>
<p><b>Do more with Microsoft Edge Chromium</b></p> <p>You can now use the Microsoft Edge Chromium browser extension for the following:</p> <ul style="list-style-type: none"><li>• Bot Agent proxy configuration</li><li>• Automatic population of device credentials</li></ul> <p><a href="#">Browser requirements for Automation Workspace</a> on page 1210</p>
<p><b>Reduce turnaround time</b></p> <p>You can now reduce the turnaround time for collecting information on issues by capturing log files from the Bot Runner device. You can save the log files by using the new <code>-collectlogs</code> command with the Bot Agent diagnostic utility.</p> <p><a href="#">Perform Bot Agent diagnostic checks</a> on page 1364</p>



What's new
<p><b>Google Chrome policy change impact on Bot Agent</b></p> <p>From Google Chrome version 101, Google Chrome is deprecating direct access to private network endpoints from public websites as part of the Private Network Access (PNA) specification for URLs using <code>https</code>. To mitigate its impact, starting from this release, response headers are added to the Bot Agent that enable the Bot Agent to communicate with Control Room on Google Chrome browsers. This will ensure that operations such as device registration, bot recording, playback, and deployment are not adversely affected because of this change.</p>
<p><b>Enhancement to AISense Recorder</b></p> <p>You can now use AISense Recorder to automate applications that use Japanese and a combination of Japanese and English interfaces.</p> <p><a href="#">AISense for recording tasks from remote applications</a> on page 2256</p>
<p><b>Wait time option in SOAP Web Service and REST Web Service packages (Service Cloud case ID: 00756730, 00792793, 01255869, 01753287)</b></p> <p>When you create a bot, you can now set a time-out value for actions in REST and SOAP requests. To indicate how long a bot should wait for a response from the server before timing out, you can set a wait time (in milliseconds) in the <b>Wait for actions to complete</b> field. You can enter a number or a variable or provide a global value.</p>
<p><b>Format text with new HTML editor in Email package</b></p> <p>In the Email package, when you use the <b>Send</b>, <b>Reply</b>, and <b>Forward</b> actions, you can now create and customize your email layout and body by using the new <b>HTML</b> design editor. Use the editor toolbar to make various changes to your text, such as applying bold, italic, and other formatting effects, inserting links, and changing the font and size of the text. You can copy the content from the design editor and paste it to other windows.</p>
<p><b>Task Bot package now supports passing Window variable to child bot (Service Cloud case ID: 00691890, 00804359, 01258948, 01764292)</b></p> <p>In the <b>Run</b> action of the Task Bot package, when you select <b>Input values</b> fields and enter the values or variables to pass to the child bot, you can now choose the <code>Window</code> type variable and pass it from parent bot to child bot.</p>
<p><b>New option in Content type field of REST Web Service package (Service Cloud case ID: 00666852, 00789910, 00771194, 00785116, 00825945, 01762199)</b></p> <p>You can now use the <b>multipart/form-data</b> option to upload files and data through REST Web Service. The content type <code>multipart/form-data</code> can be used to submit form elements containing files, non-ASCII data, and binary data. This option is available for actions such as <b>POST</b>, <b>PUT</b>, and <b>PATCH</b>.</p>
<p><b>Custom delimiter option in SOAP Web Service package</b></p> <p>For responses specific to XPath, you can now use the custom delimiter option to delimit the return content from the SOAP response. In the <b>Custom Delimiter</b> field, you can provide a character or a variable, and the output of the delimited response will be a complete string.</p>

What's new
<p>New option in Run function action of DLL package (Service Cloud case ID: 00830568, 01063654, 01259336, 01767965)</p> <p>In the <b>Run function</b> action of the DLL package, when the C# DLL interacts with the Windows API to perform system-related operations, such as keystroke, mouse click, or window switching, an intermediate window (AAZeroSizeForm) is displayed occasionally and interrupts the user's operation when the bot is running. In some cases, the DLL function does not interact with the Windows API to perform actions, such as keystroke, mouse click, or window switching, on the operating system UI through the DLL function. In such cases, you can now select the <b>Run function in background</b> check box to bypass the intermediate window (AAZeroSizeForm) and run the C# DLL in the console application without the form. This feature also helps to improve the performance of the DLL execution if the <b>Run function in background</b> check box is selected.</p>
<p>Autoscroll supported in Bot editor (Service Cloud case ID: 00730747)</p> <p>When you are creating or editing bots with a large number of lines of code and when you drag actions up or down the page, the page now automatically scrolls up or down accordingly. This feature is supported in both <b>Flow</b> and <b>List</b> views.</p>
<p>Configure session timeout in Control Room settings (Service Cloud case ID: 00765320)</p> <p>You can now ensure that your web session does not time out, such as when you are creating a bot, by configuring a suitable session timeout duration in the Control Room settings. Depending on the timeout duration configured, you will be timed out only after the specified number of minutes of inactivity, which prevents loss of work due to early timeout.</p>
<p>New JSON package</p> <p>Use the JSON package to automate JSON data. You can now extract the required information from JSON text or file and directly use the values in the bot.</p> <p><a href="#">Json package</a> on page 2762</p>
<p>New option in Catch action of Error handler package (Service Cloud case ID: 00766117)</p> <p>In the Error handler package, you can now ignore errors from actions inside the <b>Catch</b> block by using the <b>Catch &gt; On error, continue with next action</b> option. When you select the <b>On error, continue with next action</b> check box, even if there is an error from an action in the <b>Catch</b> block, no exception is thrown and the bot ignores the error and continues to the next action.</p> <hr/> <p><b>Note:</b> This enhancement applies to all nested actions in the <b>Catch</b> block. For example, if you have a <b>Try/Catch</b> action inside a main <b>Catch</b> action, if the check box is selected on the main <b>Catch</b> action, any error from actions within the nested block will also be ignored.</p> <hr/>
<p>Enhancements to the <b>Connect</b> action of the Email package (Service Cloud case ID: 00830611, 01264796, 00788467)</p> <ul style="list-style-type: none"><li>• You can now connect to an EWS server hosted on Azure US GCC high cloud.</li><li>• The action now enables Federated Azure users to connect to an EWS server in Attended Automation mode.</li></ul> <p><a href="#">Using Connect action in Email package</a> on page 2523</p>

What's new
<p>Enhancement to String package</p> <p>In the <b>Extract text</b> action of the String package, when you use the <b>After</b> or <b>Before and/or after</b> option, you can now extract a substring from a specified source string that occurs in the range of 1 through 999999 times in a file.</p>
<p>Search for files by specific date</p> <p>You can now search for files created or modified on a specific date by using the new <b>On a date</b> option available in the <b>File Date</b> condition of various packages.</p> <p>You can use this feature with the following packages and actions:</p> <ul style="list-style-type: none"><li>• File package<ul style="list-style-type: none"><li>• <b>Copy Desktop files</b> action</li><li>• <b>Delete</b> action</li><li>• <b>Print</b> action</li><li>• <b>Print multiple files</b> action</li><li>• <b>Rename</b> action</li></ul></li><li>• Folder package<ul style="list-style-type: none"><li>• <b>Copy</b> action</li><li>• <b>Delete</b> action</li><li>• <b>Rename</b> action</li></ul></li><li>• If &gt; File date condition</li><li>• Loop &gt; While &gt; File date condition</li></ul>
<p>New action in Excel advanced package (Service Cloud Case ID: 01263892, 01782290)</p> <p>When you perform actions in a Microsoft Excel worksheet, you can now disable or enable real-time screen update by using the new <b>Disable or enable real-time screen update</b> action of the Excel advanced package. This action is useful to improve the performance of Excel-based automations at run time when dealing with large data sets.</p> <p><a href="#">Worksheet operations in Excel advanced</a> on page 2574</p>
<p>Support for copying metadata from one bot to another</p> <p>You can now copy image and metadata files from one bot to another by using the <b>Copy to shared clipboard</b> option.</p>
<p>Add document extraction capabilities to bots</p> <p>You can now make bots connect to your Google Cloud service account, send documents to a specific processor, and retrieve the extracted data in JSON format by using the actions in the Google Document AI package.</p> <p><a href="#">Google Document AI package</a> on page 2720</p>

What's new
<p>Use Recorder conditions in Chromium-based Microsoft Edge with Internet Explorer (IE) mode</p> <p>You can now use the <b>Object exists</b> and <b>Object does not exist</b> Recorder conditions in Chromium-based Microsoft Edge with IE mode for the following packages:</p> <ul style="list-style-type: none"><li>• Loop &gt; While condition</li><li>• Wait &gt; Wait for condition</li><li>• If package</li></ul>
<p>Use custom datetime formats</p> <p>Use the following conventions to specify custom datetime formats and convert a datetime value:</p> <ul style="list-style-type: none"><li>• D: Specify a day in a year as D or DD.</li><li>• a: Specify an AM/PM marker for the 12-hour time format.</li></ul> <p><a href="#">Datetime formats</a> on page 2489</p>
<p>Internet Explorer browser support for Browser package and window variables</p> <ul style="list-style-type: none"><li>• The following actions of the Browser package now support the Internet Explorer browser:<ul style="list-style-type: none"><li>• Open</li><li>• Close</li><li>• Go back</li><li>• Get source code</li></ul></li><li>• In the <b>Browser</b> option, you can now select the Internet Explorer tabs from the list of active tabs.</li></ul> <p><a href="#">Browser package</a> on page 2435</p>
<p>Enhancement to Datetime package</p> <p>The <b>Variable</b> option in the <b>Datetime &gt; Assign</b> action is now enhanced and divided into two options:</p> <ul style="list-style-type: none"><li>• <b>Datetime</b>: Enables you to select the date and time along with the time zone manually and assign it to a Datetime variable.</li><li>• <b>Variable</b>: Enables you to select the Datetime variable or other variables that can have Datetime as a subtype, such as the Dictionary, Record, and list variables.</li></ul> <p><a href="#">Using the Assign action</a> on page 2486</p>

What's new
<p>Enhancement to Recorder package</p> <p>You can now capture and automate objects inside a cross-domain IFrame that has multiple IFrames with the same frame source and IFrames that are loaded at run time in Google Chrome and Microsoft Edge Chromium browsers. You can do this by using the <b>Recorder &gt; Capture</b> or the <b>Start recording</b> option. This support is also available for offline Google Chrome extensions.</p> <p><a href="#">Recorder package</a> on page 2916</p>
<p>Support for pop-up windows and dialog boxes in Google Chrome, Microsoft Edge Chromium, and Mozilla Firefox browsers (Service Cloud Case ID: 00762207, 00769773, 00781196, 00786646, 00777907, 00795677, 00785995,00808600, 00811044, 00767486, 01282172, 01286665, 01256750, 01762040)</p> <p>When you are automating a web page on the supported browsers, you can now capture the pop-up windows, alert dialog boxes, confirmation dialog boxes, and prompt dialog boxes that appear. You can do this by using the <b>Recorder &gt; Capture</b> or <b>Start recording</b> option.</p> <p><a href="#">Recorder package</a> on page 2916</p>
<p>Retrieve source code of an iFrame in Google Chrome browser</p> <p>You can now retrieve the source code of an iFrame in the Google Chrome browser by using the <b>Browser &gt; Get source code</b> action. You can use the new <b>Capture object</b> option to capture these iFrames.</p> <hr/> <p><b>Note:</b> The <b>Capture object</b> feature is optional and is only used to retrieve the source code of an iFrame.</p> <hr/>
<p>Run JavaScript inside an iFrame in Google Chrome browser</p> <p>You can now run JavaScript in a page that contains iFrames in the Google Chrome browser by using the <b>Browser &gt; Run JavaScript</b> action. You can use the new <b>Capture object</b> option to capture iFrames on which you want to run JavaScript.</p> <hr/> <p><b>Note:</b> The <b>Capture object</b> feature is optional and is only used to run JavaScript inside an iFrame.</p> <hr/>
<p>Global session support for Excel basic package</p> <ul style="list-style-type: none"><li>• The Global session option is now supported for the Excel basic package. Use the Global session option to share a Microsoft Excel session across multiple bots so that you can use the same Excel worksheet across these bots.</li><li>• The <b>Session name</b> field is now renamed <b>Create Excel session</b>.</li></ul> <p><a href="#">Using the Open action for Excel basic</a> on page 2563</p>

What's new
<p>Default variable to hold number type data</p> <p>When you are building or testing a bot, you can now use the default number variable <code>SampleNumber</code>, which is included in the Variables palette.</p> <hr/> <p><b>Note:</b> The default number variable is only available in new bots.</p> <hr/>
<p>Export and import password-protected files</p> <p>To improve security by providing protection against unauthorized access and malicious editing and also to protect privacy, the export and import features are now enhanced to include the password option. With this feature you can now perform the following:</p> <ul style="list-style-type: none"> <li>• Set a password for the files that you want to export from your Control Room.</li> <li>• Import the password-protected exported file into your Control Room.</li> </ul> <p><a href="#">Export bots</a> on page 2033   <a href="#">Import bots</a> on page 2035</p>
<p>New options in Git configuration (Service Cloud case ID: 00782957, 00837059, 00687394, 00783715, 00714059, 00659476, 00749755, 00786233, 00748166, 00776417)</p> <p>You can now perform the following actions for Git configuration:</p> <ul style="list-style-type: none"> <li>• Choose either the HTTPS or SSH authentication method to set up the Git configuration. The SSH authentication method is more secure as the authentication is based on a public and private key pair.</li> <li>• Specify the branch to which you want to push your Git commits. This helps with team coordination and workflow management.</li> <li>• Connect to your Git repository by using a proxy server.</li> </ul> <p><a href="#">Configure a remote Git repository in Control Room</a> on page 1824   <a href="#">Restore bots from Git repository</a> on page 1832</p>
<p>Force push now a configuration setting for Git Integration in the Control Room (Service Cloud case ID: 00683762)</p> <p>You can now configure the Git push to be with or without the force push flag. Previously, updating a remote Git from the Control Room exclusively functioned as a force push. This force push is the recommended and optimal setting.</p>
<p>Support for Azure DevOps (On-Premises or Cloud) Git for SSH authentication (Service Cloud case ID: 00652012, 00690526)</p> <p>You can now use either the SSH or the HTTPS authentication method to connect to Azure DevOps (On-Premises or Cloud) Git through the Control Room to check in a bot and its dependent files to the remote Azure DevOps Git repository.</p> <p><a href="#">Connect to Azure DevOps Git from Control Room</a> on page 1828</p>
<p>Spring core vulnerability - CVE-2022-22965 (01793279, 01793398, 01793497, 01793679, 01794189)</p> <p>Updated to the Spring Framework which has the patch for <a href="#">CVE - CVE-2022-22965</a> vulnerability.</p>

What's changed
<p>Migration validation checks for default device settings</p> <p>The prerequisites validation for migration now validates whether Bot Runners selected for bot migration have the default device set. If the default device is not set, then bot migration cannot proceed and the validation report lists a validation error. The report also shows the specific Bot Runner devices that do not have a default device.</p> <p>Note that bot migration cannot use devices that are selected at runtime.</p>
<p>Bot migration report shows migrated bot with action and review required</p> <p>The bot migration report now separately lists bots that might require an action or review after migration. This feature enables you to view the list of bots that will require action or review and to plan post-migration steps accordingly.</p>
<p>Migrate 11.x bots with forward slash in file and folder path (Service Cloud case ID 00808534)</p> <p>You can now migrate Enterprise 11 bots that include a forward slash in the path used within the <b>File and folder</b> action. Previously, only the backslash was supported in the path and so the user could not create a folder on SharePoint.</p>
<p>You can now manually migrate Enterprise 11 bots even when the My MetaBots folder is not present in the Control Room because this folder is no longer validated during migration.</p>
<p>Enhanced user management</p> <p>You can now view the activity of bots started by other users from the folders for which you have run and scheduling permissions.</p>
<p>Enhancement to API key validity setting (Service Cloud case ID: 00543590, 00719480, 01373359)</p> <p>You can now increase the duration of validity for API keys to 9999 days from the Control Room settings for authentication. Previously, the duration of validity for API keys was 45 days. With this enhancement, a Control Room admin need not regenerate the API key every 45 days to authenticate Automation 360 APIs.</p>
<p>Enhanced security in Image Recognition package</p> <p>You now have enhanced security when you use any of the Image Recognition actions from the Image Recognition package. Image logging is now disabled to ensure that if a bot fails while running one of the Image Recognition actions, the captured source and target images are no longer stored in the log folder.</p>
<p>Enhancement to subject filter in Email package (Service Cloud case ID: 00776374, 00953823, 975605)</p> <p>When you connect to an Exchange Web Services (EWS) server, to repeat a set of actions on all the email messages that meet a set of criteria, use the <b>Move all</b> action from the Email package or use <b>Loop &gt; Iterator &gt; For each mail in mailbox</b>. The <b>When subject contains</b> field is now case sensitive. When you enter text inside a pair of double quotation marks (") in the <b>When subject contains</b> field, the bot retrieves all the email messages whose subject exactly matches the text and the case that you entered inside a pair of double quotation marks.</p>

What's changed
<p>Change to default variable name</p> <p>The name of the default string-type variable is now changed from <code>prompt-assignment</code> to <code>SampleString</code>.</p> <hr/> <p><b>Note:</b> This change only impacts new bots.</p> <hr/>
<p>Change in activity information on Historical page</p> <p>The information about bot execution activity is retrieved for 90 days in the Control Room <b>Historical</b> activity page. Information older than 90 days can be viewed in the audit logs.</p> <p><a href="#">View completed activity</a> on page 2127</p>
<p>Enhanced Secure Recording mode control</p> <p>If you are an administrator, you can now enable or disable the Secure Recording mode based on assigned user roles (permissions) for more granular control of the Control Room.</p> <p><a href="#">Secure recording</a> on page 1042</p>

The following table lists fixes alongside the build in which each issue was fixed. Build 12350 is the latest build and includes fixes from the previous builds.

Fixes		
Build	Service Cloud case ID	Description
12350	01768021, 01803781	After the upgrade, the Control Room is no longer unresponsive and behaves normally. Previously, the Control Room was unresponsive after the upgrade due to Java deadlocks.
12350	01802575, 01803323, 01803800, 01804121, 01804820	<p>After you update from a previous release to this release, when you run the bots, the migrated bots no longer show an error for variables within double quotation marks (" "). You do not have to remove the double quotation marks as a workaround to run the bots.</p> <p>For example, after you update from Automation 360 v.23, you can run a bot with the Excel advanced package that contains the following variable: "\$HeaderCounter\$"</p>
12342	00827504, 00788652, 00827730, 01259452	With the required permissions, you can now view the correct information in the <b>Historical Activity</b> page. Previously, a "Do not have sufficient permissions" error sometimes prevented even users with administrative permissions from viewing some of the entries in the <b>Historical Activity</b> page.



Fixes		
Build	Service Cloud case ID	Description
12342	00823799, 01623586	<p>When you migrate Enterprise 11 MetaBots with Input, Output, and None variable parameter types, these are now correctly mapped to the respective parameter type in Automation 360 after migration.</p> <p>Previously, the Enterprise 11 Input, Output, or None variable types were mapped to Input/Output type after migration.</p>
12342	00819756	<p>After migration, when you run a bot that contains <b>Switch to sheet</b> action and the action is performed, the worksheet is now visible and is activated for further operations.</p>
12342	01773270, 01781001	<p>The <b>Cloud Migration Utility</b> can now connect successfully to the database even when the database credentials contain the following special characters:</p> <p>⌘ # @ % \$</p>
12342	00988580, 01200161	<p>After you migrate from Enterprise 11 to Automation 360, you can now <b>Check out</b> bots and dependent files to the Control Room <b>Public</b> workspace.</p> <p>Previously, the dependent files were not available for <b>Check out</b> in the Control Room <b>Public</b> workspace. The parent bots had to be checked out first so that the dependent files could be automatically cloned and available for <b>Check out</b>.</p>
12342	00788046	<p>When you run a bot with the <b>Wait, File, Folder</b> as <b>Actions</b> or <b>If/Loop</b> as <b>Conditions</b> and if the <b>Start Date</b> and <b>End Date</b> options are set to the same date, these bots now execute the respective action or conditions based on the end date that is set.</p>
12342	01598462	<p>The <b>Run Logic</b> command now works correctly when MetaBots contain Logic with different parameters assigned to each Logic. If you disable one Logic in a MetaBot, the other Logic and its command will work correctly.</p> <p>Previously, if one Logic in a MetaBot was disabled, commands related to another Logic were disabled.</p>

Fixes		
Build	Service Cloud case ID	Description
12342	01251985, 01264753, 01272804	In the SAP BAPI package, the <b>Get Table</b> command for the <b>Table</b> subtype now successfully retrieves results for the <b>Import</b> , <b>Export</b> and <b>Table</b> parameters.  Previously, if you ran the <b>Get Table</b> command for the <b>Table</b> subtype for <b>Import</b> or <b>Export</b> parameters, the command failed.
12342	01262390	When you migrate Enterprise 11 bots that use the <b>IF &gt; File exists</b> condition with a wildcard in the file name, they now run successfully irrespective of whether the parent folder is available in the path.  Previously, if the parent folder was not present in the condition path, the bot stopped running and encountered an error.  If you are on this release or an earlier one, you can use <b>IF &gt; File exists</b> condition with the parent folder, along with current <b>IF &gt; File exists</b> condition with wildcard.
12342	--	A migrated that includes the <b>File and folder</b> command has the <b>Include start and end dates</b> check box enabled by default. As a result, Enterprise 11 bots no longer fail in Automation 360 when the file rename operation is performed, even if the start and end dates specified are the same for comparison using the <b>Is between</b> condition.
12342	01751462	When the Run Task command with a variable path is disabled and the variable used in the path is deleted, the Task Bot can now be migrated, without any error. Previously, migration failed and a preprocessing error was displayed.
12342	00824337	The migration result no longer shows an error message when you migrate a bot with the credential name in Japanese.
12342	00783883	The HTML technology-based action (for example, <b>GetProperty</b> ) now supports the retry mechanism, which enables you to migrate bots that include the recorder command with an inner text.
12342	--	You can now successfully migrate Enterprise 11 bots that have negative values for x and y coordinates for top and left fields.

Fixes		
Build	Service Cloud case ID	Description
12342	00827997	Bot Scanner now allows the migration of bots with multiple expression conditions that include a disabled line of code and no longer shows an error.
12342	00834597	Bot Scanner now successfully analyzes a MetaBot screen and no longer shows an error for the preprocessing of the source file.
12342	01213241	All plug-ins now successfully load when you open an Excel sheet using the <b>Excel &gt; Open</b> action.
12342	01504682	Bot Scanner no longer shows an internal error even if a bot contains any of these special characters: &#26.
12342	--	<p>You can now successfully migrate Enterprise 10 bots that have roles with folder permissions. Previously, such permissions were not migrated.</p> <hr/> <p><b>Note:</b> The Run and Schedule role is not migrated.</p> <hr/>
12342	01632298	You can now successfully migrate bots with the <b>Analytics</b> variable through the Bot Migration Wizard, and after migration the status is displayed as successful. Previously, these bots were stuck in the <b>In Progress</b> state and therefore the bots did not run.
12342	00828781, 01258567, 01273170, 01469879	Bots now complete their execution faster than previously when a proxy is enabled through a PAC file in Cloud deployments.
12342	01385567, 01749465	The Control Room now correctly shows the information for <b>Display intranet sites in Compatibility View</b> in <b>Compatibility View Settings</b> . Previously, in Automation 360 v.23, a blank page was displayed because of an internal issue.
12342	00807226, 01148097	<p>If an IP subnet address contains the numeral 80 (for example, 192 . 30 . 80 . 25), you can now configure the Control Room port to 80 in the installer.</p> <p>Previously, if the subnet address contained the numeral 80, the Control Room port could not be configured to 80. A different port number that did not contain 80 had to be configured for the IP.</p>

Fixes		
Build	Service Cloud case ID	Description
12342	00836549	When you copy a role by using <b>Create Role</b> within a Control Room, user and bot permissions are now correctly retained. Previously, editing the associated role caused all associated bot permissions to be lost.
12342	01434341, 01755003, 01755713, 01756244, 01757083, 01756871, 01758346	You can now successfully search for Japanese characters within bots by using the Find in this bot search box. Previously, the Japanese characters typed through the keyboard were not entered correctly and you had to use a workaround to search for Japanese characters.  <a href="#">Japanese language search support</a>
12342	--	If you <b>Check in</b> a bot to the Control Room <b>Public</b> workspace after filtering any dependency data, when you export the bot, only the filtered data is displayed now. Previously, even after filtering the dependency data, all data was displayed.
12342	00819477	You can now view dependent files when you open a bot in the bot editor. Previously, the dependent files were listed only in view mode.
12342	--	When a device pool name includes the underscore character (_), the MSI Installer now completes autoregistration of device pool properties, resulting in device pool names with underscores to populate. Previously, the MSI Installer did not complete autoregistration of a device if the device pool included an underscore character.
12342	01758029, 017596611	You can now use Azure AD authentication to connect to Azure database server when you install the Control Room using Windows installer and installation script. Previously, if Azure AD authentication was selected on the Database server window, Control Room installation failed.
12342	--	After you install or upgrade Automation 360 from a previous release, the Control Room <b>Installation summary</b> page now displays the correct version number. Previously, the page displayed an incorrect version number.

Fixes		
Build	Service Cloud case ID	Description
12342	00796190, 00827493, 01251725	When you deploy a bot, the run-time window now displays the correct line number and package name for the <b>capture desktop</b> action of the Error Handling package. You can find the exact line number that caused the error by using a variable in the <b>Error handler: Catch &gt; Assign line number to</b> option.
12342	00800990	<p>You can now rename a bot by changing the text from uppercase to lowercase or from half-width to full-width characters. For example, you can rename a bot from Automate to automate.</p> <p>Previously, the text in the bot name could not be changed. When the text was changed, the following error message was displayed:</p> <pre>Unable to create a file with the name &lt;filename&gt;. That name is already in use. To continue, please rename your file. Code: repository.exception.file.exists</pre>
12342	01258242	When you run a bot that contains multiple conditions and a missing operator in one of the conditions through the Bot editor, an error message is now displayed about the missing operator. When you update an action and save the changes and if there is a missing operator, an <b>AND</b> operator is now added by default. Previously, bots with multiple conditions failed intermittently with a preprocessor error.
12342	00805738	An error message is now displayed and you can no longer check in or check out files whose filepaths are identical except for differences in case. Previously, when the filepath had different cases and was checked in or checked out, there were issues during bot deployment.
12342	01753711	You no longer encounter any issue when you check out a folder that contains tasks with dependencies. Previously, casing-related issues occurred in string comparison operations, which caused errors in check-in and check-out operations.
12342	01271474, 01761856	When you assign a production label to a child bot that has more than one version, the production version is now displayed during bot operations. Previously, instead of the production version, the latest version of the child bot was displayed.

Fixes		
Build	Service Cloud case ID	Description
12342	01270601, 01260628, 01255632, 01758499, 01775489,01773778	When you connect with <b>Microsoft Outlook, IMAP, or POP3</b> , you can now create a bot and save all emails to a folder even if the email subject line contains slash (/) or backslash (\) characters. When you save the emails, the slash (/) and backslash (\) characters in the subject line are now replaced by an underscore (_) character.
12342	01755993, 01782945, 01775161, 01792954	In the Email package when you connect to Microsoft <b>Outlook</b> to automate an email-related task, you can now use the <b>Move all</b> action followed by <b>Loop</b> action to move unread emails from one folder to another folder. Previously, when you ran the bot, the bot failed to move the unread emails because of an error.
12342	01264563	You can now create a bot using the <b>Global session</b> option in the <b>Open</b> action of the DLL package and choose <b>DLL session does not exist</b> for the <b>If</b> condition. Previously, an error was encountered when the <b>Open</b> action of the DLL package and the <b>If (DLL session does not exist)</b> condition were called multiple times in a sequence.
12342	01258059	In the XML package, when you create a bot to retrieve the data by using the <b>Get single node</b> action and if the XML file has some lines that are commented out, the output no longer shows those lines. Previously, the output displayed the lines that were commented out.
12342	--	In SOAP Web Service, when you select <b>Raw data parameter</b> and use the <b>Build Xpath</b> option, you can now successfully extract values from the SOAP response and store the XML output in a variable. Previously, you could not extract values from the SOAP response because the <b>Build Xpath</b> option did not work as expected.
12342	01071731, 01762875	When you open a CSV or TXT file, read data from that file, and write data from a Table type variable to the file, the bot no longer fails if the CSV or TXT file contains large data sets. The bot now runs successfully even when the <b>Create folders/files if it doesn't exist</b> and <b>Override existing file</b> check boxes are selected in the <b>Write to file</b> action.

Fixes		
Build	Service Cloud case ID	Description
12342	00968574	An error no longer occurs when you create a bot by using the <b>Open</b> action of the VBScript package and select a <code>vBScript</code> file from the desktop with the file extension in uppercase. Previously, if the file extension was in uppercase, the bot failed because the file was considered an invalid script file.
12342	00831463	Using the Email package, you can now send emails with the email subject containing a combination of Japanese half-width characters and katakana characters. Previously, if email subject contained a combination of Japanese half-width characters and katakana characters, the output displayed was garbled in the mail received.
12342	00822222	When you connect to the <b>EWS</b> server to automate an email-related task, you can now send multiple emails without providing any value in the subject field when you use the <b>Send email</b> action in a loop. Previously, when there was an empty value in the subject field, the bot failed to read such mails.
12342	00823283	In the FTP / SFTP package, you no longer encounter an error when you provide the folder name as a dot (.) in the <b>Get folders</b> action. When you run the bot, it downloads all the folders from the current directory to the local folder path provided in the action.
12342	00824379	In the Google Sheets package, when you open a spreadsheet and use the <b>Go to cell</b> with the cell option as <b>Specific cell</b> and if the spreadsheet has more than 40000 rows and you select the <b>One cell below</b> option, the bot now executes successfully. Previously, an error occurred on bot execution.
12342	00788970	The bot name is now translated correctly in Chinese (Simple Chinese) in the <b>Bot running</b> window. Previously, the bot name was displayed as garbled in the <b>Bot running</b> window.
12342	01270344, 01767148	When you use the Google Sheets package and open a Google spreadsheet, you can now use the <b>Get all sheet names</b> action to successfully retrieve the names of all the sheets. Previously, if the Google spreadsheet had more than five sheets in it, the bot encountered an error.

Fixes		
Build	Service Cloud case ID	Description
12342	01709026, 01755897, 01768689, 01761434, 01554474	An error no longer occurs when you establish a connection by using the ODBC driver in the Database package. For Microsoft SQL Server, the blank value is now inserted as 0 in the database table for the <code>int</code> column.
12342	01602081	When you use actions from the REST Web Service package to send requests and receive responses from a REST API and to store the response status of the API in a dictionary variable, REST now returns headers and empty body content in response even if the API does not have response body.
12342	01758733	When you migrate from Enterprise 11 to Automation 360, after you edit or add some actions to a bot that does not exist in a parent bot, when you save the bot, it is now saved without any delay. Previously, it took some time to save the bot.
12342	01254323	An error no longer occurs when you use the <b>Create workbook</b> action of the Excel advanced package to create a workbook inside a folder in a network drive path.
12342	01036851	When you open a file with <code>.xlsx</code> extension by using the <b>Open</b> action of the Excel advanced package, the bot no longer fails even if an intermediate parent folder does not have access privileges. For example, the <b>Open</b> action can open the file from <code>\\share\a\b\c\file.xlsx</code> if the <code>\\share\a\b\c</code> folder has access privileges even if the <code>\\share\a</code> or <code>\\share\a\b</code> folder does not have access privileges.
12342	00827204	On computers that use the Japanese and Chinese versions of operating systems, an error no longer occurs when you try to return a tab to the first web page it opened by using the <b>Go back</b> action of the Browser package and deselect the <b>Throw an error if step exceeds history</b> option.
12342	00777283, 00829912	When you use the <b>Open</b> action of the Excel advanced package to open a Microsoft Excel worksheet, use the <b>Replace</b> action of the Excel advanced package to replace a string in the worksheet, and then run the bot, the bot now runs as expected and is not stuck even if the string to be replaced is not present in the Excel worksheet.



Fixes		
Build	Service Cloud case ID	Description
12342	00835312	An error no longer occurs when you create a shortcut to a folder by using the <b>Open program/file</b> action of the Application package to open a file and then using the <b>Create shortcut</b> action of the Folder package.
12342	00757943, 00787404, 00788421, 00807528, 00822941, 01018972	You can now use the AI Sense action in a parent bot and the OCR action in a child bot, or both actions together, to successfully run your bot. Previously, this caused an ABBYY FineReader Engine 12 error.
12342	01212753, 01470071	When the current session of an application on Citrix is closed and the application is restarted, the Recorder now identifies the object and successfully performs the correct action. Previously, the Recorder failed to identify the object.
12342	00742936, 00808117	You can now convert a datetime value by specifying custom datetime formats (for example, hh:mm:ss). Previously, an error occurred when you used the hh convention to specify a custom datetime format.
12342	01266752	When you use the 6.2.0-20210903-141520 version of the Excel advanced package to run a macro on a Microsoft Excel worksheet, the values in the referenced cells in the Excel worksheet are now updated correctly.
12342	01755439	An error no longer occurs when you use the 2.5.3-20220304-010651 version of the Recorder package to capture an object. Previously, when you used the 2.4.0-20211118-080716 version of the Recorder package, the bot failed with the following error message: <b>The bot could not be executed due to an error in setting up the execution environment</b>
12342	01276429	After migration, you can now call a reusable bot with the new package version from the same parent bot with which it shared a session. You can do this by inserting a session variable initialized with a value to a key in the dictionary with the <b>Dictionary &gt; Put</b> action.
12342	00805417, 00815023, 01049408	You can now use the Recorder to successfully run keystrokes and capture objects on a new tab opened in the Google Chrome browser.

Fixes		
Build	Service Cloud case ID	Description
12342	--	In the <b>Browser &gt; Open</b> action, when you select the <b>Last used browser tab</b> preset for the Internet Explorer window under the <b>Existing tab</b> option, the corresponding tab and window are now activated.
12342	01755590	In Automation Workspace, when you navigate to <b>Automation &gt; Bot Store</b> and log in, you can now access the Bot Store without issues.
12342	--	When you add or remove a consumer role from the locker, role values are no longer changed when you sort the table. Previously, the values in the Modified By and Last Modified columns were inadvertently modified.
12342	01272058, 01752731	You can now pause or stop your in-progress workload automations and the <b>Internal server error</b> no longer occurs.  Previously, the workload automation could not be paused or stopped after the user who created the automation was deleted from the Control Room.
12342	01181402, 01260706	When you run your workload automations, you no longer have to pause and then resume to run the queued bots that are stuck in the <b>In progress</b> state.
12342	00790086	The incorrect Japanese translation for schedule description of the daily and monthly frequency fields for the <b>Run repeatedly</b> option ( <b>Manage &gt; Schedules &gt; Schedule a bot</b> ) is now fixed. The correct Japanese description is now available on the <b>Schedule a bot</b> page.
12342	00852637	When you edit a bot schedule in the Control Room, the schedule column on the <b>Scheduled</b> page now displays the correct schedule date instead of the previous day. Previously, for example, if a bot was scheduled for 01-Oct-2021, the <b>Scheduled</b> page displayed the schedule date incorrectly as 30-Sep-2021.
12342	00821057, 01188160	If a file is exported after the bot name and folder path are changed, the bot name now reflects the new name. Previously, the bot was exported with the old name.
12342	01252294	You can now successfully import the zip files in the <b>Zip64</b> format from the development environment to the production environment.

Fixes		
Build	Service Cloud case ID	Description
12342	--	You can now run multiple queues without any delay in between queues. Previously, when you ran multiple queues, a delay of 5 to 15 minutes sometimes occurred between queues.
12342	00800831, 00815411, 00826054, 00826058	When you use the <b>Export checked items to csv</b> option, the schedule data in a .csv file is now saved correctly. Previously, when you exported the schedule data to a csv file from the Control Room <b>Scheduled activity</b> page, the file data was saved incorrectly. For example, the schedule type was saved as <b>Recurring</b> in the csv file instead of <b>One time</b> .
12342	01754721, 01753460, 01767806 01759361, 01763327, 01764201, 01767827, 1770574	If the system locale setting is changed, the weekly scheduled bots now run as scheduled from the Control Room. Previously, when the system locale setting was changed, the bots did not run according to schedule.
12342	00714546, 00759029, 01257992	The Control Room can now integrate a Git repository that rejects force push. Previously, some security protocols rejected all force push updates making the git integration incompatible without a configuration for the force push flag. You can now change the configuration of the Git push from the Control Room to disable the force push flag.

The following table lists the limitations identified in the current release:

Limitations
<p>(Service Cloud case ID: 01765712) If a MetaBot Logic was using a DLL file that used classes without namespaces, after migration, any Task Bot that uses the MetaBot Logic does not work.</p> <p>Workaround: Manually update the DLL file to include namespaces for classes.</p>
<p>If you created the <b>Active Directory</b> role mapping in previous releases, when you update to Automation 360 v.24, some previously defined group mappings are deleted because the Distinguished Name (DN) column of the mapping entries in the database contains empty rows, with no values. Before you update to Automation 360 v.24, run a script to populate the DN column. (Service Cloud case ID: 00751756)</p> <p>For support on this issue, contact the support team: <a href="#">Open a support case (A-People login required)</a></p>

Limitations
<p>The Bot Insight premigration utility encounters an error and closes when it detects corrupted dashboard IDs in BI tables. (Service Cloud case ID: 00796546)</p> <p>Workaround: Download and install the latest Bot Insight premigration utility from the Automation Anywhere Support site.</p>
<p>When you build bots by using drag actions from the <b>Actions palette</b>, the bot workflow shifts to the right side in the <b>Flow</b> view.</p> <p>Workaround:</p> <ul style="list-style-type: none"> <li>When you create or edit a bot in the Bot editor, add new actions from the <b>Actions palette</b> by double-clicking the action that you want to use.</li> </ul> <p>For example, if you are editing a bot and you want to add an action after line 7, place the insertion point after line 7, and then, from the <b>Actions palette</b>, double-click the action that you want to add.</p> <ul style="list-style-type: none"> <li>If you want to use the drag option, ensure that when you drag the actions, you move them a little faster on the canvas.</li> </ul>
<p>(Service Cloud case ID: 01798098) When you update Automation 360 from a previous release to this release on a Windows machine, you might see the following error message about an invalid digital signature:</p> <pre>Error 1330: A file that is required cannot be installed because the cabinet file       E:\AA\....\Data1.cab has an invalid digital signature.</pre> <p>Workaround: <a href="#">A360.24 Installation Failure "Error 1330 Invalid Digital Signature" (A-People login required)</a></p>
<p>If the <b>Automatically update all bot agents</b> option is selected and if you update to this release, some Bot Agent might fail to automatically update to the latest version.</p> <p>Workaround:</p> <ol style="list-style-type: none"> <li>Manually uninstall the existing version of the Bot Agent.</li> <li>Install the latest version of the Bot Agent.</li> </ol>
<p>When you migrate Enterprise 11 bots with the Comment command enabled, the command is disabled after migration. (Service Cloud case ID 01255723, 01252824, 01260677, 01608653)</p>
<p>When you log in as an administrator after migration and then start a bot migration, the <b>Audit Logs</b> pane intermittently displays an unsuccessful message with a Bot Launcher has crashed error.</p>
<p>When you migrate bots with system variables (such as date, month, or year) as an <b>Export Data to CSV</b> option, a preprocessing error is displayed. (Service Cloud case ID 01755175)</p>
<p>When you update your Control Room from Automation 360 v.21 or v.22 to Automation 360 v.23 or v.24, the installation might fail because of schedule migration issues. (Service Cloud case ID: 01376353, 01449535, 01713118, 01627144, 01762404)</p> <p>Workaround: <a href="#">Open a support case (A-People login required)</a>.</p>

Limitations
<p>Administrators can export data, up to 100,000 entries, to a CSV file. Downloaded audit .csv files are stored in the C:\Windows\TEMP\ folder in the On-Premises environment temporarily. Files in this folder with names starting with cr-audit should not be deleted for at least 90 days and can be downloaded from the Control Room.</p> <p>See <a href="#">.Export audit data to CSV</a> on page 2176</p>
<p>When you autoupdate the Bot Agent simultaneously on 500 to 1000 devices in the Control Room (On-Premises), the autoupdate fails.</p> <p>Workaround: Manually update the Bot Agent on a few devices at a time from the Control Room <b>Devices</b> page.</p>
<p>In browsers such as Microsoft Edge (Chromium) and Mozilla Firefox, when the Bot Agent installer file is downloaded, the download information is shown at the top-right corner although the download arrow points to the bottom-left corner of the browser's taskbar.</p> <p>The download arrow points to the correct direction only for the Google Chrome browser, in which the download information is shown at the bottom-left corner of the browser's taskbar.</p>
<p>For a Control Room installed on Linux operating system, the AutomationAnywhereBotAgent.msi file is not available for download with the <b>Download installer</b> option from the <b>Control Room &gt; Administration &gt; Settings</b> page.</p> <p>Workaround: To install the Bot Agent, use the AutomationAnywhereBotAgent.msi file from the &lt;application filepath&gt;\crui\asset folder of a Control Room (On-Premises) installed on Windows operating system. For more information, see <a href="#">Sample steps to create Bot Agent golden image (A-People login required)</a>.</p>
<p>In the Email package, when you use the <b>HTML design</b> option to create and customize your email layout and body and then paste content copied from another source, such as Outlook or Notepad++, the font style, size, and color are currently not retained for the following actions:</p> <ul style="list-style-type: none"><li>• Send</li><li>• Reply</li><li>• Forward</li></ul>
<p>When you create a bot using actions such as <b>Send</b>, <b>Reply</b>, or <b>Forward</b> from the Email package, choose an option from <b>Plain text</b>, <b>HTML design</b>, or <b>HTML code</b> to format your email body. When you switch between these tabs (<b>Plain text</b>, <b>HTML design</b>, or <b>HTML code</b>), the previously set value in the message body is not retained, and the message body is blank.</p>

Limitations
<ul style="list-style-type: none"> <li>Nested IFrames are not supported in the Google Chrome and Microsoft Edge Chromium browsers.</li> <li>Support to capture window authentication pop-ups is not available when automating Google Chrome browser.</li> <li>After performing an action in an application or page, if a frame is added at run time to the application or page, and if any pop-up windows, alert dialog boxes, confirmation dialog boxes, or prompt dialog boxes appear on that frame, then the pop-up windows and dialog boxes are not captured.</li> </ul> <p>Workaround: Use the actions in the Image recognition package or the <b>Mouse &gt; Click</b> action instead to run the bot.</p>
<p>On computers where SystemLocale is set to a non-English language, when you open multiple tabs in a browser, try to execute any action on a new tab that is currently inactive, and run the bot, the inactive new tab does not become activated.</p>
<p>In Internet Explorer, to activate one among multiple web pages with no titles, only the fully qualified domain names (FQDN) are compared. If pages that have no titles but have the same FQDN are opened in Internet Explorer, any tab that matches the FQDN is activated.</p>
<p>In Internet Explorer, when you use the <b>Close</b> action to close a tab or a window, it is closed only if it does not have an alert dialog box.</p>
<p><b>Note:</b> An Internet Explorer tab or window with an alert dialog box is closed only when the alert dialog box is closed manually.</p>
<p>When you use the <b>Open</b> action of the Excel advanced package to open files with <code>.x1sm</code> extension that have charts, the bot fails with an error.</p> <p>Workaround: Provide the Excel sheet name in the <b>Specific sheet name</b> field and then run the bot. If there are any hidden sheets, unhide the specific sheet and make it as the active sheet.</p>
<p>When you automate web applications running on Microsoft Edge Chromium with IE mode or Internet Explorer, the Recorder sometimes fails to capture the object from the currently selected browser tab and captures from the last used tab instead.</p> <p>Workaround: Refresh the Bot editor and then start recording again.</p>
<p>When you use the Recorder to capture an object, select <b>HTML Tag</b>, <b>HTML InnerText</b>, and <b>HTML type</b> properties in <b>Search Criteria</b>, or migrate a bot with similar properties selected in <b>Search Criteria</b>, the bot might fail to identify or locate the object and perform the selected action.</p> <p>Workaround: Modify the <b>DomXpath</b> according to the controls you capture or add more properties in <b>Search Criteria</b>.</p>
<p>When you use the Datetime package released with Automation 360 v.23 or earlier to create a bot that uses the <b>Datetime Assign</b> action, then select the variable option to add the variable value and try to run the bot with package released with Automation 360 v.24 or later, the UI shows a compilation error, and the user must select the variable value again.</p>

Limitations
In the Recorder package, the <b>Run in background</b> option that enables an automation to run in the background is not supported for applications running on Google Chrome, Microsoft Edge, and Mozilla Firefox browsers for any of the Recorder actions.

The following table lists limitations from previous releases that are also applicable to this release:

Limitations from previous releases
When you migrate a bot that was using the Manage Window Controls action, the last digit of the height value is not available after migration. However, the bot will execute successfully. (Service Cloud Case ID: 01756996)
When an Excel session is active in SAP, a corresponding Excel process starts in the background. In such a scenario, Automation 360 uses the same Excel process that SAP started. When you run a bot to automate spreadsheet data, Automation 360 processes the first request successfully. However, during execution, if the Excel is closed and a subsequent request is sent for automating the spreadsheet data, Automation 360 does not process the request because the Excel process is still being accessed by SAP. Therefore, the correct window is not activated for automating the spreadsheet data. (Service Cloud Case ID: 00815159)
<p>If you are directly updating from Automation 360 On-Premises v.21 to this release, you might face issues updating your Bot Agent on some Bot Runner machines in the following scenarios:</p> <ul style="list-style-type: none"> <li>• After a Control Room update, the device status keeps changing and the Bot Agent fails to update automatically.</li> <li>• If the <code>embedded_resources</code> file is missing, the Recorder does not recognize the user interface elements or does not capture a single object in the Google Chrome browser.</li> </ul> <p>Workaround: Before updating to this release, remove the following Bot Agent files and folders:</p> <ul style="list-style-type: none"> <li>• <code>C:\Windows\System32\config\systemprofile\AppData\Local\AutomationAnywhere\AA-DB.mv.db</code></li> <li>• <code>C:\ProgramData\AutomationAnywhere\GlobalCache\embedded-resources</code></li> </ul> <p>For more information, see <a href="#">Bot agent auto update fails post the Control Room Upgrade with 'device.connection.lost' (A-People login required)   The recorder is not able to recognize the GUI elements in Google Chrome browser (A-People login required)</a></p>
<p>When you use the Terminal Emulator command with the <b>Send Text</b> action that contains the LF key (Enter), the command might fail if the LF key is not supported by the Terminal Emulator.</p> <p>Workaround: Ensure that you replace the LF key with supported characters such as the space character.</p>
After migration, a user is able to delete an <code>.atmx</code> file even when the file is associated with a schedule from the Automation 360 Control Room.

Limitations from previous releases
<p>If you configure an external key vault in <b>External Key Vault Integration</b> and select the <b>SQL authentication</b> mode for database authentication in the Windows installer <b>Database Server</b> page to install Control Room (On-Premises), the installation fails, and the following error message is shown: <code>Control Room database tables fail to create</code>.</p> <p>Workaround: Add the database credentials in the external key vault and use those credentials for database configuration.</p>
<p>Newly created Control Room users on Windows for On-Premises Google Cloud Platform VMs cannot change their password. The security questions option is not available on the <b>Change password</b> screen and as a result the Control Room displays an error when they try to save the password.</p> <p>Workaround: Refresh the page and change the password again.</p>
<p>(Service Cloud case ID: 01768545) Update status stuck as <b>IN_PROGRESS</b> during migration from Enterprise 11 to Automation 360</p> <p>When you migrate from Enterprise 11 to Automation 360, even if bot migration is successful, Bot Insight does not update the status to the Control Room. Until version 11.3.2, the analytical flag was historically enabled by default, so all created bots are identified as analytical bots. Some bots identified as analytical bots have no processed data available to the Bot Insight dashboard. As a result, the migration status becomes stuck as <b>IN_PROGRESS</b> even if bot migration is successful.</p>
<p>When you try to automate any process in a Java application that uses version 11.0.8 of AdoptOpenJDK, the Recorder sometimes does not capture the drop-down elements on the application.</p>

## Automation Co-Pilot for Business Users (Automation Co-Pilot)

What's new
<p>Microsoft Edge Chromium and Safari supported for Automation Co-Pilot</p> <p>You can now create forms and processes in the Automation Workspace and run your requests, tasks, and bots in the web interface on Microsoft Edge Chromium and Safari browsers.</p> <p><a href="#">Browser requirements for Automation Workspace</a> on page 1210</p>
<p>Create password fields and hide sensitive information (Service Cloud case ID: 00714159, 01063512)</p> <p>In the Automation Workspace, you can now create password fields by using the <b>Password</b> element in your form builder. You can use the <b>Password</b> element in the web interface to add masked text to your password fields in the initial forms to hide sensitive information.</p> <p><a href="#">About Process Composer</a> on page 3419   <a href="#">Password element behavior</a> on page 3427</p>



What's new
<p>Configure a scheduler user for each team</p> <p>You can now access the <b>Process</b> page in the web interface to edit a process and assign a scheduler user for each team. This ensures that the bots in the process are deployed on the devices assigned to a team and that these devices are not used by another team. The <b>Team</b> scheduler user is set by default, but if a scheduler user is undefined, then the <b>Process</b> scheduler user is selected. The <b>Global</b> scheduler user will be selected only if the <b>Team</b> or <b>Process</b> scheduler users are not selected.</p> <p><a href="#">Assign a scheduler user to a process</a> on page 3415</p>
<p>Configure scheduler deployment type (Service Cloud case ID: 00814885, 01276257)</p> <p>You can now configure the scheduler deployment type for bot tasks in your process setup and determine how the bots in the process will be deployed. You can define the mapping between run-as user and the device that helps take care of constraints, such as credential constraints that require one-to-one mapping between the run-as user and the device.</p> <p><a href="#">Configure deployment type for bots</a> on page 3417</p>
<p>Reference ID enhancement to requests</p> <p>You can now view the reference ID associated with your process in the <b>Reference</b> column of the <b>Requests</b> page. The reference ID is a combination of a prefix and a number that is created from a <b>Process Key</b> that you can enter when you edit your process for the first time. This reference ID is incremented whenever a request is created from the corresponding process.</p> <p><a href="#">Reference ID properties</a> on page 3380   <a href="#">Configure a process</a> on page 3398</p>
<p>Request retention settings</p> <p>When you edit a process, you now have the option to set when your completed requests are moved from the <b>Requests</b> page to the <b>Recycle bin</b>. With this feature, you can avoid manually moving completed requests individually to the <b>Recycle bin</b>. You can choose to disable the settings to move completed requests to the <b>Recycle bin</b>. You can also set the number of days after which requests are deleted from the <b>Recycle bin</b>.</p> <p><a href="#">Configure a process</a> on page 3398</p>
<p>Default team assigned to process</p> <p>You can now edit a process to display the default team that the process is assigned to in the <b>Default team</b> field. The first team that a process is assigned to is automatically set as the default team. With this feature, you can view the default team that a process is assigned to without viewing each individual team.</p> <p><a href="#">Configure a process</a> on page 3398</p>
<p>View status of queued bots</p> <p>You can now view the status of your bots that are queued and are not actively running. The request view page now shows the <b>In Queued</b> label next to your queued bots that are not active.</p>

What's new
<p>Cancelled status for tasks</p> <p>You can now filter tasks by the <b>Cancelled</b> status in the <b>Tasks</b> page. This status will show a <b>Cancelled</b> label next to the filtered results to inform you of the tasks that were cancelled by a user. You can filter by this status from the drop-down menu in the status bar.</p> <p><a href="#">Filter and search for a task</a> on page 3393</p>
<p>Fill initial form elements by URL parameters</p> <p>When you create a request, you can now fill initial form elements by creating query scripts that enter specific parameters in the initial form URL. These parameters are applicable only for <b>Date</b>, <b>Number</b>, <b>Text Box</b>, and <b>Time</b> elements.</p> <p><a href="#">Construct URL parameters for supported elements</a> on page 3426</p>
<p>Storage service enhancement (Service Cloud case ID: 00768394)</p> <p>As a tenant admin, you can now set a configuration option to block upload of executable files to prevent a security breach. You can block the upload of files with the following extensions: .acm, .ax, .cpl, .dll, .drv, .efi, .exe, .mui, .ocx, .scr, .sys, and .tsp.</p>
<p>Run virtual window in bot configuration</p> <p>If you are an Automation Co-Pilot Admin, you can configure bots in the <b>Bots</b> page and enable the <b>Run your bot in virtual window</b> option. With this option, an attended user in Automation Co-Pilot Desktop Assistant can run bots in a virtual window without losing their user experience.</p> <p><a href="#">Configure a bot</a> on page 3397</p>
<p>Add rules to Button element</p> <p>You can now add rules to the <b>Button</b> element.</p> <p><a href="#">Using the Button element</a> on page 3438</p>
<p>Customize text in forms using updates to Label element</p> <p>You can now customize the text in your forms in various ways, such as applying bold, italic, underline, and other formatting effects, changing the font size and color, and so on, by using the <b>Label</b> element. With these options, you can highlight specific messages or texts, such as next steps, warnings, or errors, when they are rendered in the initial form in the web interface.</p> <p>The <b>Label</b> element now provides the following formatting options:</p> <ul style="list-style-type: none"><li>• <b>Emphasis</b></li><li>• <b>Font color</b></li><li>• <b>Font size</b></li><li>• <b>Text alignment</b></li></ul> <p><a href="#">Using the Label element</a> on page 3444</p>

What's new
<p>Search and filter columns in a table</p> <p>On the form builder screen, if you select the <b>Enable column filtering</b> check box for the <b>Table</b> element, users can search and filter the content for all the available columns when the bot is running.</p> <p>When you use the <b>Table</b> element to render a table in your initial forms, you now have the enhanced ability to search each column of your table by value.</p> <p><a href="#">Using the Table element</a> on page 3451</p>
<p>Additional options for rules</p> <p>With additional options included for rules in the form builder, you can now perform the following:</p> <ul style="list-style-type: none"><li>• Find a rule but using the search bar. In the search bar, enter the name of the rule or the element label that is associated with any condition or action in the rule.</li><li>• Create a copy of a rule by using the <b>Duplicate rule</b> option.</li><li>• For multiple rules, you can use the following options to rearrange the order in which these rules are executed at bot run time:<ul style="list-style-type: none"><li>• <b>Move up</b></li><li>• <b>Move down</b></li><li>• <b>Move to top</b></li><li>• <b>Move to bottom</b></li></ul></li></ul> <p><a href="#">Conditional actions, rules, and elements</a> on page 3428</p>
<p>Apply an action to multiple elements</p> <p>If you are adding or editing a rule, when you are adding an action, you can now apply an action to more than one element by selecting multiple elements in the <b>Then</b> menu.</p>
<p>Additional If conditions for some elements</p> <p>When you are creating or editing a rule, you can now select additional <b>If</b> conditions for the following elements:</p> <ul style="list-style-type: none"><li>• <b>Dropdown</b></li><li>• <b>Checkbox</b></li><li>• <b>Radio Button</b></li><li>• <b>Date</b></li><li>• <b>Time</b></li><li>• <b>Hyperlink</b></li></ul>
<p>Use Assign for updating the value of the Dropdown element</p> <p>When you are adding a rule, if you select the <b>Dropdown</b> element as an action item from the <b>Then</b> menu, you can now use the <b>Assign</b> drop-down menu to append or overwrite values when the bot is running.</p> <p><a href="#">Conditional actions, rules, and elements</a> on page 3428</p>

**What's new**

Elements in If condition are available in Then action

All the elements that are used as part of the **If** condition are now available as part of **Then** action.

Multiple lines supported for Text Area and Rich Text Editor

Text across multiple lines is now supported for **Text Area** and **Rich Text Editor** elements within **If** and **Then** options.

[Conditional actions, rules, and elements](#) on page 3428

**What's changed**

Enhancements to importing process to public folder

When you import your process to a public folder, the process is now automatically published in Automation Co-Pilot. Previously, you were required to check in the imported processes in the private repository and then check in the process again for it to be published in Automation Co-Pilot.

[Import a process automation](#) on page 3486 | [Import process automation dependencies](#) on page 3487

Process page layout updated

The layout of the **Process** page has now been updated to be consistent with the **Bot** and **Team** pages. The changes include columns for reference ID, key, name, description, tags, and teams. You can now filter your results in the search bar for faster sort and quickly reference the current global scheduler user on the page.

Active bot status

In the request view page, you can now view the exact status of your bots by referring to the **In Progress** label next to your active bots that are currently running. Previously, the **In Progress** label showed both active bots and queued bots that were not running.

What's changed
<p>Reference to replace Request ID in Automation Co-Pilot on the web</p> <ul style="list-style-type: none"> <li>You can now filter or query your requests in the <b>Requests</b> and <b>Recycle bin</b> tabs and tasks in the <b>Tasks</b> tab (<b>Table View</b> and <b>Detail View</b>) using the new <b>Reference</b> instead of the <b>Request ID</b>.</li> <li>The <b>Requests</b>, <b>Team</b>, <b>Process</b>, and <b>Bots</b> URL is now changed to <code>entity/ref/:ref</code> from <code>entity/:id</code>. If you open any request using <b>Request ID</b>, the URL now redirects using <b>Reference</b>. For example, consider the <b>Request ID</b> as 896 and <b>Reference</b> as 2-34 for a request. If you view the request using the <b>Request ID</b> (<code>/aari/#/requests/all#/requests/896</code>), the URL will redirect using the <b>Reference</b> (<code>/aari/#/requests/all#/requests/ref/2-34</code>).</li> </ul> <p>Reference is a unique key that helps you identify your related processes and requests in the <b>Requests</b>, <b>Team</b>, <b>Process</b>, and <b>Bot</b> pages. Reference is easier to use and more meaningful than Request ID as it provides a logical sequence of referential number incremented per tenant. Reference is unique within a tenant, but it can be the same for two tenants.</p> <p><a href="#">Reference ID properties</a> on page 3380</p>

The following table lists fixes alongside the build in which each issue was fixed. Build 12350 is the latest build and includes fixes from the previous builds.

Fixes		
Build	Service Cloud case ID	Description
12350	01788376	You can now launch AARI using the Bot Agent (version 21.133) connection without errors.
12350	01803979	If you have Control Room configured with SAML and you click the <b>AARI</b> icon on the Windows Desktop, you are now redirected to the Automation Co-Pilot Desktop Assistant web page instead of the Control Room home page.
12342	01759135	When you use the <b>Date</b> element and select the <b>Use the local system date when this form is loaded</b> option, the date is now correctly displayed, with the local system date.
12342	01766579	If you are a Bot Creator, after creating a request using your Automation Co-Pilot process, you can now submit the initial form and complete tasks without being stuck on the request view page.
12342	--	For Automation Workspace with SDS setup, when you enter data or upload files in your initial forms after selecting a process to run the request, you no longer encounter an exception error message.

Fixes		
Build	Service Cloud case ID	Description
12342	--	When you use the <b>Checkbox</b> element to create a <b>CheckBoxGroup</b> in your form and set form rules and conditions for each box in this group (C1, C2, C3, and so on), the selections now function properly in the initial form as defined your form rules.
12342	--	If you are a Bot Creator and an Automation Co-Pilot manager, you no longer encounter an error when you run a bot by using the <b>Team Members</b> action from the <b>AARI Web</b> package to access teams.
12342	--	If you are a member of a team by role (that is, if you were first added to a role in the Control Room and the role was then synced to a team), you will now be able to view updated information for your requests and tasks. The page now automatically refreshes the latest request and task details.
12342	--	In the web interface, when tasks are completed in the request view, and you confirm by clicking <b>Finish</b> , <b>Cancel</b> , or any other primary or secondary option, these types of events are now captured in the <b>Audit log</b> history in Automation Workspace, as an Automation Co-Pilot Human Task type of event.
12342	--	In Linux environment, you can now use the file upload functionality of Automation Co-Pilot on the web without any issues. Previously, the file upload functionality failed with an access denied error because the <code>filestorage</code> directory was not automatically created to store the files.
12342	--	The <b>Edit</b> button no longer appears enabled for processes that are checked in, checked out, or cloned. Previously, you could edit the names of processes that were checked in, checked out, or cloned although the changes were not saved.
12342	--	For any element in a form, if you use the <b>Mark field uneditable</b> option on the form builder or disable it when you run the associated bot, form validations applied to that element are overruled.

Limitations
<p>In some scenarios, when you launch a bot that was configured to run in a virtual window, the virtual window starts and you are prompted to log into the window with your credentials.</p> <p>Workaround: Reboot your system and launch the bot again.</p>
<p>When you design a form, you can create references for hidden elements by using the Hidden elements option from the form properties. However, after you have designed the form, you cannot view or change the variables among hidden elements.</p>
<p>After you design a form with a drop-down rule assigned to your form, if you view the drop-down in read-only mode, you will not be able to view the changed data in read-only mode.</p>
<p>If you have <b>Select file</b> element in the form, then you cannot upload a file that has special characters (such as , ( ) &amp; ; - =) in the filename when you run the bot.</p>
<p>In the web interface, when you are on a page other than the main page and your login session disconnects and returns you to the login page again, the <b>next=</b> parameter is shown in the URL indefinitely. This can be an issue as the <b>next=</b> parameter is used to redirect the URL to a previous page but is currently not supported.</p>
<p>For the <b>Text Box</b> element, the <b>Does not contain</b> form rule is not working.</p>
<p>For the <b>Rich Text Editor</b> element, the <b>Contains</b> form rule is not working.</p>
<p>For the <b>Table</b> element, the <b>Rows before scrolling</b> option can support only up to four rows. If you specify five or more rows, this option is not supported and you must scroll instead.</p>
<p>If you create a form with the <b>Document</b> and <b>Dropdown</b> elements, when you attempt to submit this form, an error occurs. This error is due to the dynamic form schema, such as a drop-down field filled by a process that is present in the form with the document field and causes an error.</p>

## Discovery Bot

What's new
<p>Save the recording with a name</p> <p>After recording a process, you can now save the recording with a name. The name of the recording is displayed on the <b>Recordings</b> page for that process.</p> <p><a href="#">Record a Discovery Bot business process</a> on page 3910</p>
<p>Share a description of the recording</p> <p>You can now provide a description for a recording of a process by using the <b>Recordings</b> page for that process. In the <b>Recordings</b> page, use the <b>Description</b> field to share the context and the purpose of the recording with the analyst. The description provided is also displayed in the PDD.</p> <p><a href="#">Record a Discovery Bot business process</a> on page 3910</p>

What's new
<p>Delete a recording</p> <p>After you record a process, if you do not want to submit the recording data to an analyst for review, you can delete the recording by using the <b>Recordings</b> page for that process. In the <b>Recordings</b> page, use the <b>Delete</b> option to delete the recording.</p> <p><a href="#">Record a Discovery Bot business process</a> on page 3910</p>
<p>Record business processes using Automation Co-Pilot Desktop Assistant</p> <p>You can now use Automation Co-Pilot Desktop Assistant to record business processes without signing in to the Control Room. To record a business process, start Automation Co-Pilot Desktop Assistant by double-clicking the Automation Co-Pilot icon on your desktop.</p> <p><a href="#">Record a Discovery Bot process using Automation Co-Pilot Desktop Assistant</a> on page 3914</p>
<p>Enhancements to custom opportunities</p> <p>You can now update the potential cost and savings for custom opportunities and save your changes to the process diagram. The potential cost and potential savings can be updated at any time as you review the steps from various recordings and make changes within the process diagram.</p> <p><a href="#">Review opportunities, convert to bot, and generate PDD</a> on page 3916</p>
<p>Enhancement to PDD</p> <p>You can now view the entire process diagram from within Discovery Bot by clicking the URL link provided in the PDD. The PDD does not display the process diagram if more than 100 steps are selected.</p> <p><a href="#">Review opportunities, convert to bot, and generate PDD</a> on page 3916</p>

What's changed
<p>The process discovery document (PDD) now displays Chinese Unicode characters in both Word format and PDF.</p>

Fixes	
Service Cloud case ID	Description
--	Cloud users: When you capture more than 250 steps, you can now create a customized opportunity for automation and generate a PDD.
--	You can now download a PDD for custom opportunities and recordings without any issue. Previously, an error occurred intermittently and the following error message was displayed: <code>Error generating PDD</code>



Fixes	
Service Cloud case ID	Description
--	An error message is now displayed when you cannot connect to the Control Room. For example, this occurs when a signed or wildcard certificate is used for the Control Room setup for On-Premises deployments and you have not pre-installed the certificate. The <b>Processes</b> page fails to load. Follow the instructions in the message to connect to the Control Room.
00829246	Cloud users: You can now download a PDD for an automation opportunity with 200 or more steps. Previously, when you created an opportunity with 200 or more steps, clicking <b>Download PDD</b> returned an error.
--	For autogenerated and custom opportunities, the <b>Recordings</b> table now works as expected. Previously, it encountered an error intermittently.
00827381	When you search for the Recorder package in the Japanese UI, you can now view the correct package name for the Recorder.

The following table lists the limitations identified in the current release:

Limitations
In rare situations when a device CPU is busy, the recording screenshot might not be captured from the <b>Recordings</b> page for a process. However, user actions, such as text selection, are displayed on the <b>Recordings</b> page.

The following table lists limitations from previous releases that are also applicable to this release:

Limitations from previous releases
When you add branches to the left and right sides of a main branch, the Recording flow chart section of the PDD might not capture the entire process workflow, including all the branches.
Depending on the memory available in your system, the PDD (in PDF or Microsoft Word format) can support up to 250 recorded steps captured in the document. If a process is recorded with more than 250 steps, the PDD generation periodically stops functioning. Workaround: Regenerate the PDD and click <b>Download</b> .

## Feature deprecation for Discovery Bot

Review the deprecated feature to understand how it can impact your automation.

### Discovery Bot red highlight

In the recording session, the red outline that highlights when you move the mouse over the area to capture the action has been deprecated as of June 2021. The red outline is displayed in the screenshot images when you review your captured steps from the Recordings page.

## IQ Bot

### What's new

#### Document Automation limited availability release

A select group of early adopters can now use Document Automation to automate processing business documents in the new Automation Anywhere Cloud-native intelligent document processing solution.

Document Automation is integrated into the Control Room. When you create a learning instance, IQ Bot automatically creates RPA bots to extract and download the data and an Automation Co-Pilot process to manage the entire process. Learning instances do not require training. Instead, Document Automation uses pre-trained models to process invoices and receipts.

[Document Automation](#) on page 3625 | [Intelligent Document Processing solutions feature comparison matrix](#) on page 3634

#### Total number of pages uploaded for Process Documents action

In Automation 360 IQ Bot, when you use the **Process documents** action from the IQ Bot Extraction package to process documents, you can now view the total number of pages uploaded displayed under **Dashboards > My totals**

[Using IQ Bot Process documents action](#) on page 2757

#### Role-based access control (RBAC) available

Automation 360 IQ Bot now offers role-based access control (RBAC). You can use RBAC to handle the following user permissions:

- Edit learning instance
- Delete learning instance
- Send learning instance to production
- Import domain

[Defining a custom role for IQ Bot](#) on page 3736

#### Rotate encryption key as **AAE\_IQ Bot Admin**

With the **AAE\_IQ Bot Admin** role, you can now rotate the encryption key by changing the object name in the new **Administration > Key rotation** page.

[Rotate the external key](#) on page 3789

What's new
<p>New model for Cognitive MLWeb Service</p> <p>In On-Premises installations of Automation 360 IQ Bot, you can now achieve improved check box and table detection when you use the new model of the Cognitive MLWeb Service.</p>

What's changed
<p>For on-premises installations of IQ Bot, the MLScheduler Service in the Microsoft Windows services window is now disabled, by default, to free up system resources.</p>

Fixes	
Service Cloud case ID	Description
00764550, 00765854	When you migrate from Enterprise 11 to Automation 360, any learning instance with custom domain that has Chinese language fields is now displayed correctly. Previously, these fields were populated with incorrect values in place of Chinese characters.
00758208, 00632965, 00727063, 00715124, 00828988, 01251514	The <b>MLScheduler</b> service is now disabled on IQ Bot On-Premises, and the system no longer slows down or stops responding. Previously, the autocorrection and autosuggestion features, which are part of the <b>MLScheduler</b> service, used system resources extensively and caused the system to slow down or stop responding.
01757917	Documents are now successfully classified using Microsoft Azure 3.2 OCR. Previously, due to deprecation of the Microsoft Azure preview OCR v3.2-preview.2, the documents remained unclassified.
--	Documents extracted using the Auto Extract command are now successfully processed. Previously, when documents were extracted using the Auto Extract command, validations from the default validation group were not applied to them.
01261531	When you create a learning instance and use the IQ Bot upload command, the display is now stable, without any issues. Previously, this caused resizing and toggling between larger and smaller fonts, making the display flicker.
--	To manually create a group, you require only the IQBot_admin role now. Previously, to manually create a group, you required both the aae_basic and IQBot_admin roles.
--	In the IQ Bot UI, for groups that were created manually, you can now see the <b>Group label</b> in its entirety. Previously, you could see only a part of the <b>Group label</b> .

Fixes	
Service Cloud case ID	Description
--	Documents whose file names begin with a special character, such as a hyphen (-), are now properly classified and processed. Previously, such documents were held up in the classification queue or remained unprocessed.
01063054	You can now import a learning instance that has a lengthy name, with more than 50 characters, without any errors because the <b>Label</b> field now supports more than 50 characters.
--	For a standard forms learning instance, if you upload a document that contains a table with an empty cell, the document is now sent to IQ Bot Validator. Previously, documents with empty table cells were sent to the <b>Failed</b> folder.
--	An error no longer occurs when you run a bot that contains actions from IQ Bot Pre-processor, Document Classifier and OCR packages. Previously, in such cases, an 'Assertion failed' error occurred.
01777853	You can now create standard forms learning instances using pretrained models that have long field names (up to 250 characters). Previously, pretrained models that had lengthy field names caused an error.

Limitations
When you upload vector PDF documents to a new learning instance, a few documents are identified as unclassified. Alternatively, if you convert the documents from PDF to TIFF and upload them, the documents are processed successfully.
When you are running IQ Bot using service account credentials, if the password contains a space, IQ Bot logs will not be updated.
In some cases, even if the correct number or amount is accurately reflected, some documents still fail the validation rule because of a round-off error and are sent for manual validation.
In formulas, if you use delimiters, such as commas or periods as thousand separators, formula validation fails.  Workaround <ul style="list-style-type: none"> <li>For English language: Remove all delimiters, such as commas used as thousand separator.</li> <li>For other European languages: Remove all delimiters, such as periods used as thousand separator. Use the English number convention for formula validations.</li> </ul>
If you use the ABBYY FineReader Engine version 12.4 instead of version 12.2, the MICR feature does not support data extraction from documents in Japanese language.

Limitations
<p>After you back up the databases and run the DB Migration Assistant tool, the tool and the logs indicate that migration is successfully completed even if the unified database is not created.</p> <p>Workaround: Ensure that you install both the x86 and x64 versions of the Microsoft Visual C++ 2015-2019 Redistributable package.</p>

## Bot Insight

What's changed
<p>startTime data now in standard format</p> <p>When you export data to Microsoft Excel, the date format will be exported based on the date format of the widget.</p>

Fixes	
Service Cloud case ID	Description
--	Now when you are using a proxy network, when you click <b>Analyze</b> , the network dashboard generates an analysis. Previously, this dashboard did not generate an analysis.
--	When you run a bot that was checked in to a public folder and then checked out into a private folder, the last refreshed date is now displayed accurately. Previously, the last refreshed date was displayed as invalid.
01252869, 01259449	The Business Dashboard is now visible to users assigned the BI Admin Role and BI User License. Previously, users with this role and license were not able to access this dashboard.

Limitations
<p>Cannot drill down for data used in group by duration</p> <p>When <b>Group By</b> is selected as <b>duration (time/date)</b> in the widget, the drill down is applicable only to a single level. If you try to drill down for data at the second level or further, you might encounter the following error: No data found.</p>

**Limitations**

(Service Cloud case ID: 00777595) When you attempt to refresh the data in a Microsoft Excel worksheet, an authentication error can occur from multiple simultaneous attempts through open windows and tabs.

Workaround

1. In the Power BI desktop application, navigate to **File > Options and settings > Options**.
2. From the **Current File** section, select **Data Load**.

---

**Note:** Do not select **Data Load** from the Global section.

---

3. Disable the check box **Enable parallel loading of tables**.

## Automation 360 v.23 Release Notes

Release date: 30 December 2021

Review what's new and changed, and the fixes and limitations in the Automation 360 v.23 (Build 11513) release. Build 11513 replaces Builds 11499 and 11486.

### Important:

- This build includes the Apache Log4j2 library version 2.17.1 to address the exposure to CVE-2021-44832, CVE-2021-45105, CVE-2021-44228, and CVE-2021-45046 vulnerabilities.

Though the command packages are not upgraded to Apache Log4j2 library version 2.17.1, the Bot Agent is upgraded to Apache Log4j2 library version 2.17.1. At runtime, the packages will use Apache Log4j2 library version 2.17.1 through the Bot Agent and hence will not be exposed. As an additional security measure, the Automation 360 v.23 Bot Agent installer also disables the Apache Log4j2 library look-up feature by default.

Third-party security scans might find traces of earlier versions of the Apache Log4j2 library. However, with the upgrade to Automation 360 v.23 and the mitigation in place, there will be no exposure to vulnerabilities. For more information, see [FAQs related to Automation Anywhere Releases regarding zero-day vulnerabilities \(CVE-2021-44228, CVE-2021-45046\) \(A-People login required\)](#).

- This build also includes fixes for the following issues:
  - When you update from Automation 360 v.22 to v.23, background jobs related to cloud license server sync-ups were deleted because of incorrect license job name.
  - When you install or update to Automation 360 v.23 for On-Premises deployments, log files were not updated for a few additional services.
  - If you did not have the **View Package** permission, bot deployments failed when you scheduled or ran a bot.

- 
- Migration
    - [11.x and 10.x | 11.x only](#)
  - Automation Workspace

- [What's new](#) | [What's changed](#) | [Fixes](#) | [Security fixes](#) | [Limitations](#)
- Automation Co-Pilot
- [What's new](#) | [What's changed](#) | [Fixes](#) | [Limitations](#)
- Discovery Bot
- [What's new](#) | [Fixes](#) | [Limitations](#) | [Feature Deprecation](#)
- IQ Bot
- [What's new](#) | [What's changed](#) | [Fixes](#) | [Limitations](#)
- Bot Insight
- [What's changed](#) | [Fixes](#) | [Limitations](#)

## Updating to this release

The updated Build 11513 for Automation 360 v.23 includes Log4j2 library version 2.17.1 and fixes. If you are on the previous v.23 Build 11499 (with Log4j2 library version 2.17.0) or Build 11486 (with Log4j2 library version 2.16.0), update to Build 11513 for the updated Log4j2 library version and the fixes.

You can also update to Automation 360 v.23 from the previous three releases (that is, from n–3 releases, where n refers to the latest release). The following previous releases are certified for update to this release:

- v.22 (Build 10526)
- v.21 (Builds 9664, 9642, 9595)
- v.20 (Build 8815)

You can directly update to v.23 from any of these builds (see [Update Automation 360 to latest version](#) on page 1423). If you are not on an n–3 release, update Automation 360 to one of the three certified releases (listed previously) before updating to this release.

If you are directly updating to this release from Automation 360 On-Premises v.20 or v.21, remove the following Bot Agent files and folders:

- C:\Windows\System32\config\systemprofile\AppData\Local\AutomationAnywhere\AA-DB.mv.db
- C:\ProgramData\AutomationAnywhere\GlobalCache\embedded-resources

---

**Important:** To use the new features in v.23 (including updates to Recorder packages) and for the Log4j2 vulnerability fix, update the Bot Agent for this release. Note that the Bot Agent update from the previous release is not required if you want to run your existing bots as Bot Runners.

---

For information on updating to this release, see these resources:

- [Automatically update the Bot Agent](#) on page 1361 | [Manually update the Bot Agent](#) on page 1362
- [Compatibility with release builds](#) on page 1333

For the latest updates to the Automation 360 extensions for Google Chrome, Microsoft Edge, and Mozilla Firefox, see [Browser extensions for Automation 360](#) on page 985.

## Migration features

Enterprise 11 and Enterprise 10 features
<p>MetaBots containing linked objects</p> <p>Migrate MetaBots that contain a text play type linked object that is linked with the object play mode object, an image play type linked object linked with the image play type object, and a coordinate play type linked object linked with the coordinate play type object.</p>
<p>Migrate bots with the following attributes:</p> <ul style="list-style-type: none"> <li>• Bots with variables that contain data larger than 64 KB ( Service Cloud case ID: 00716311,00756449,00819149)</li> </ul> <p>The migration process stores the data in a text file. The text file is uploaded to the Cloud Control Room and is used in the migrated bot.</p> <ul style="list-style-type: none"> <li>• MetaBots with DLLs that return list and array type values with any delimiters combination and store these values in the clipboard</li> <li>• You can now migrate MetaBots with <b>image play</b> mode that use the action <b>GetVisibility</b></li> <li>• You can now migrate bots with the <b>GetSelectedIndex</b> and <b>GetSelectedText</b> actions for the UI Automation technology used in the <b>Object Cloning</b> command and MetaBot screens.</li> <li>• You can now migrate bots which automate applications with Java technology <b>Type</b> using the <b>Object Cloning</b> command with the action <b>GetDataofAllchildren</b>.</li> </ul>
<p>Bots with different variable casing</p> <p>When you migrate a bot that has passed a variable from a Task Bot to a MetaBot Logic or from a MetaBot Logic to a Task Bot and if the casing of the variable name is modified in the MetaBot Logic, the migration process updates the variable name with the same casing as that of the bot corresponding to the migrated MetaBot Logic in the parent Task Bot.</p>
<p>Migrate bots with locator image (Service Cloud case ID: 00754508, 00776192)</p> <p>You can now migrate bots that contain images that are captured using the Object Cloning command.</p>
<p>MetaBots as dependencies are not downloaded</p> <p>The migration process does not download MetaBots that are available as dependencies. This restriction is to avoid downloading MetaBots and creating multiple copies of the same MetaBots because they are already available in the Control Room repository.</p>
<p>New action in Legacy Automation package for migration (Service Cloud case ID: 00797140, 00849161)</p> <p>Use the <b>Get keystrokes delay</b> action to match the duration of delay defined in Enterprise 11 bots for the <b>Insert keystrokes</b> command and simulate the same value in Automation 360 for the <b>Simulate keystrokes</b> action.</p>
<p>Notification about bots with issues in Bot Scanner report</p> <p>The Bot Scanner report now flags Enterprise 11 or Enterprise 10 bots that have issues and therefore require action or review. For example, bots that have security issues or bots that refer to non-existent variables are flagged with an icon in the action or review message.</p>



**Enterprise 11 and Enterprise 10 features**

Improved validation of migrated bots

- Additional compile time validations are now available to validate a bot at run-time. For example, if a parent bot calls a child bot and the child bot has compilation errors, these errors are displayed when you try to run the parent bot. This ensures that an error does not occur in the middle of an automation or make it an incomplete automation.

This feature enables you to proactively identify all migrated bots that have compilation errors. Migrated bots with compilation errors are shown in **Successful with Review** section of the **Migration Report** and ensures that you can get a list of bots that require your attention.

To enable the bot validation feature, navigate to **Administration > Settings > Bots > Bot validation** and set it to **On**. See [Settings](#) on page 1789.

- The Bot Migration Wizard now displays validation error details for each bot in the bot migration results. Details about the errors help you to review and take action on the migrated bots, thereby saving time.

[Migrate Enterprise bots](#) on page 1590

Enhanced bot migration assistant

The migration assistant is now merged with the error assistant to provide a comprehensive view of all the lines in a bot that require review or action by you, or which have errors in these and therefore require you to address them. This feature helps you to quickly identify the areas of bots that require your attention.

Support for 32-bit driver to connect database (Service Cloud case ID: 00757466)

To enable migration of Enterprise 11 bots with VBScript, 32-bit drivers are now supported in Automation 360 to connect the database.

**Enterprise 11 only features**

Migrate bots with the following attributes:

- Bots that include images that are captured using the **Object Cloning** command, **OCR > Capture area** command, **App Integration > Capture area** command, and **Mouse click** action.
- Bots that contain an HTML email body with local image references if the referenced images are available on the Bot Runner machine (Service cloud case ID: 00780065, 00790657, 00827527, 00822092, 00928116, 01181845)
- Bots that contain Microsoft Excel commands with file extensions such as **.ods**, **.htm**, **.html**, **.mht**, **.mhtml**, **.slk**, and **.pdf** to open an Excel file (Service Cloud case ID: 00799071)
- MetaBots that use the credential variable of non-string type to pass a numeric value as an input to a DLL function

## Automation Workspace

What's new
<p>Enhanced administrator capabilities Properly licensed Automation Anywhere Control Room administrators can now create valid RPA users based on authentication with username and password and select not to require live authentication via email response. This feature enables administrators to resend "Welcome" authentication emails without having to reset the credentials assigned to RPA users.</p>
<p>Microsoft Edge (Chromium) supported for Control Room and Bot Agent You can now perform Control Room operations, and install and register your Bot Agent device using the Microsoft Edge based on Chromium browser. <a href="#">Browser requirements for Automation Workspace</a> on page 1210</p>
<p>Support for Azure Key Vault Automation 360 now supports Azure Key Vault, and you can now retrieve the following from the external key vault:</p> <ul style="list-style-type: none"> <li>• Active Directory (AD), services account, and SMTP credentials</li> <li>• Auto-login credentials</li> <li>• Credentials by automations</li> </ul>
<p>Bot Validation Bot validation check happens for new bots and when you run a bot. Control Room administrators can now turn the Bot Validation feature on or off. By default, this feature is turned off for every Control Room. <a href="#">Migrate Enterprise bots</a> on page 1590</p>
<p>Credential Vault variable supported in <b>Run function</b> action of the DLL package As a Bot Creator, you can now use the Credential Vault variable or credential type variable for the <code>Number</code> data type and pass it as an input parameter in the DLL function. <a href="#">Using the Run function action</a> on page 2505</p>
<p>File ID supported in Check permission action of Google Drive package (Service Cloud case ID: 00777716) The <b>Check permission</b> action of the Google Drive package now supports the <b>File ID</b> option to refer to files available in the <code>Shared with me</code> folder of Google Drive. By providing the <b>File ID</b>, you can now verify the <b>Read</b>, <b>Write</b>, or <b>Delete</b> access granted to you in the <code>Shared with me</code> folder of the Google Drive files. <a href="#">Google Drive package</a> on page 2694</p>
<p>New Credential package You can now use the <b>Assign</b> action in the Credential package to assign an insecure string or a variable directly to the credential variable. <a href="#">Credential package</a> on page 2448</p>

What's new
<p>Web Services security supported in SOAP Web Service package (Service Cloud case ID: 00481836)</p> <p>As a Bot Creator, you can now provide credential variables in the raw data of the <b>SOAP Web service</b> action. You can create a credential variable, map the credential with a reference name in the credential mapper, and use the reference name in the raw data. Because this ensures that all security-related data can be defined in the Credential Vault and the credentials can be used in bots, you can safely deploy tasks without compromising security.</p> <p><a href="#">Example of using the SOAP web service action</a> on page 3240</p>
<p>New option in SOAP Web Service package</p> <p>Use the <b>Build Xpath</b> option in the SOAP Web Service package to extract values from the SOAP response. You can now specify the Xpath expression or select the appropriate node from the response body and store the output in a variable.</p>
<p>Outlook server supported in Change status, Save email, and Delete actions (Service Cloud case ID: 00544534, 00557623, 00642506, 00659724, 00763565, 00680801, 00803975, 00818304, 00819362)</p> <p>In the Email package, to automate a task you can now establish a connection with the <b>Outlook</b> server for the <b>Change status</b>, <b>Save email</b>, and <b>Delete</b> actions.</p>
<p>Read email from shared mailbox in Microsoft Outlook (Service Cloud case ID: 00728579, 00831622)</p> <p>To automate email-related tasks, you can now select a shared account in Microsoft Outlook so that email messages can be read from the shared mailbox.</p>
<p>New encoding types supported in the Write to file action of Data Table package (Service Cloud case ID: 00767158)</p> <p>When you use the <b>Write to file</b> action to write data from a Table type variable to a CSV or TXT file, you can now use the following encoding types from the encoding list:</p> <ul style="list-style-type: none"><li>• UTF-8: Works as UTF-8 without BOM</li><li>• UTF-8 with BOM (called UTF-8 previously)</li><li>• UTF-16LE</li><li>• Shift-JIS (Japanese encoding)</li></ul>

**What's new**

## Auto-save functionality in Bot editor

In the Bot editor, when you use actions to build an automation, when a bot is not manually saved, an auto-save is performed and the bot now automatically saves the changes for specific events.

**Note:** The auto-save functionality is currently available only for specific events.

Some of the events that support auto-save functionality are as follows:

- Recorder: When you create a bot with certain actions and click **Recorder**, the event is saved, and when the recording is complete, the event is automatically saved.
- Variable manager: When you create or edit a variable to insert it in an action, the changes are saved.

**Note:** The auto-save functionality is not supported when you delete a variable or insert it by pressing F2 to open the variable list.

- Actions menu (vertical ellipsis): When you select any action from this menu, for example **Packages**, the event is saved automatically. When you make any change to the **Packages** page and return to the Bot editor, the event is saved.
- Find a file: When you click the **Find a file** icon, the bot is saved if it is not manually saved. Also, after you click the **Add** option, the bot is automatically saved.
- Dialog boxes: When a dialog box is opened, it is automatically saved if any changes are made.

**Note:** Auto-save is triggered only for top-level dialog boxes and not for nested dialog boxes.

- Deleting variables: When you delete unused variables, the event is saved.
- Bot name change: If you edit the name of a bot, the event is saved.

## New option in FTP / SFTP package (Service Cloud case ID: 00792346)

Use the **Credential** option when you connect with the **Secure FTP** server type to automate a task. You can now use username and password for authentication.

[Connect action](#) on page 2620

## Enhancement to AISense Recorder

AISense Recorder now supports automation of applications that use Brazilian-Portuguese and a combination of Brazilian-Portuguese and English interfaces.

[AISense for recording tasks from remote applications](#) on page 2256

## Support for Capture anchor in AISense Recorder

The AISense Recorder now supports the **Capture Anchor** option. When you run a bot to search for an object in an application in which the anchor changes frequently, you can use **Capture anchor** to override the default anchor and manually select an anchor to detect the object.

[Edit a task recorded using AISense](#) on page 2259

**What's new**

Enhanced support when selecting Object property in Recorder package

After you capture an object using the **Recorder > Capture** action, you can now select a particular object property name from the list of available properties in order to retrieve the value of the object property using the **Get property** action. The list includes suggested property names from the search criteria in the **Object Properties** table.

[Recorder package](#) on page 2916

Enhancements to Number package

- In the **Random** action of the Number package, you can now specify and limit the number of decimal digits required in the random number generated in the output.
- The existing **Save the outcome to a number variable** field is now renamed as **Save the outcome to a variable**.

[Number package](#) on page 2802

Enhancements to Wait package

Use the new **Capture region** feature in the **Wait for screen change** action of the Wait package to capture a specific region on an application by drawing a rectangle around it so that the bot automatically captures the coordinates of this region. You can perform the following actions:

- Capture a specific region on a Windows application.
- Preview the captured image in the **Preview** window.
- Recapture a region if the image in the **Preview** window is not per user requirement.

The coordinates are renamed as follows:

- **Left** is now **X**
- **Top** is now **Y**
- **Right** is now **Width**
- **Bottom** is now **Height**

[Using Wait for screen change action](#) on page 3157

Enhancement to String package

In the **Extract text** action of the String package, you can now extract a substring from a specified source string that occurs more than 1000 times in a file and up to a maximum limit of 999999.

Enhancement to File conditions in If package

You can now use the new **File extension** condition from the **Condition** list in the **If** package to check the extensions of files and then execute actions based on the results.

What's new
<p>Support for cross-domain IFrames in Google Chrome and Microsoft Edge Chromium browsers (Service Cloud case ID: 00825656)</p> <p>You can now capture and automate objects inside a cross-domain IFrame in Google Chrome and Microsoft Edge Chromium browsers by using <b>Recorder &gt; Capture</b> or the <b>Start recording</b> option. After you capture an object inside a cross-domain IFrame, the path to the frame is stored in the <b>FrameDOMXPath</b> property, by default.</p> <p>The new <b>FrameDOMXPath</b> property identifies the path to the frame in which the object is located. You must select this property to run the bot successfully to capture objects on a cross-domain IFrame.</p> <hr/> <p><b>Note:</b> This feature is available for the bots you create using the 2.4.0-20211016-070100 version of the Recorder package starting from this release.</p> <hr/> <p><a href="#">Recorder package</a> on page 2916</p>
<p>Support to automate Microsoft Edge Chromium with Internet Explorer compatibility mode (Service Cloud case ID: 00767502, 00787186)</p> <p>You can now automate web applications running on Microsoft Edge Chromium, by enabling the Internet Explorer compatibility mode, using the Universal Recorder where the objects are captured using HTML technology.</p> <p><a href="#">Record a task with the Universal Recorder</a> on page 2240</p>
<p>Global session support for loop iterator based on Excel advanced</p> <p>You can now use the <b>Global session</b> option when you loop through each row in an Excel advanced worksheet. Use the <b>Global session</b> option to share a Microsoft Excel session across multiple bots so that you can use the same Excel worksheet across these bots.</p> <p><a href="#">Using the Open action for Excel advanced</a> on page 2571</p>
<p>Enhancement to Excel advanced package (Service Cloud case ID: 00799071)</p> <p>Use the <b>Open</b> action of the Excel advanced package to open files with <code>.ods</code>, <code>.htm</code>, <code>.html</code>, <code>.mht</code>, <code>.mhtml</code>, <code>.slk</code>, and <code>.pdf</code> extensions.</p> <p><a href="#">Excel advanced package</a> on page 2565</p>
<p>Check out a specific version of a bot</p> <p>To edit a bot in the Control Room <b>Automation</b> page, when you check out a bot from the <b>Public</b> to a <b>Private</b> workspace, you can now choose a specific version of the bot along with its dependencies by using the new <b>Advanced options</b>.</p> <p><a href="#">Check out a single bot</a> on page 2305</p>
<p>New APIs for devices</p> <p>You can now allocate default devices by using the new APIs introduced in the <code>v1/Devices</code> section. Choose to set or not set a specific device as the default deployment device for a specified user by using the following APIs respectively:</p> <ul style="list-style-type: none"> <li>• <code>/runasusers/default</code></li> <li>• <code>/runasusers/default/unset</code></li> </ul>

What's new
<p>Configurable API-key validity (Service Cloud case ID: 00763420)</p> <p>You can now configure the validity of the API-key using the <b>API-Key Duration</b> feature available in the <b>Administration &gt; Setting &gt; Security Configuration</b> in Automation 360. You can set validity minimum of 1 minute or maximum of 45 days.</p>
<p>Bot version comparison</p> <p>You can now compare various versions of the bots in your public workspace. You can use the <b>Compare versions</b> option to select two versions of a bot and compare them for differences, and any modifications in your work flow are highlighted for your reference. You can also view the differences in the actions, packages, triggers, and variables between the versions.</p> <p><a href="#">Compare bot versions</a> on page 2313</p>
<p>Production label support in bot development work flow</p> <p>You can now assign a <b>Production label</b> to a particular version of a bot. After you assign a label, you can run or export bots with a bot version of your choice. You can select the version associated with a production label to schedule, run, queue, and trigger bot development work flows.</p> <p><a href="#">Assign label to a bot</a> on page 2312</p>
<p>Access to Automation Anywhere RPA Training &amp; Certification</p> <p>A direct link to Automation Anywhere RPA Training &amp; Certification is now added in the Automation 360 Help Center.</p> <p><a href="#">Automation Anywhere University: RPA Training and Certification (A-People login required)</a></p>

What's changed
<p>Bot Scanner recommendation</p> <p>The Bot Scanner now recommends to proceed with migration (with or without review or action) when 95% or more than 95% of your bots can be migrated.</p>
<p>Assign credential variable to non-credential type variables for migrated bots</p> <p>For migrated bots, Automation 360 no longer restricts you from assigning the credential variable to a non-credential type variable in an insecure (non-secure) way. So you can now successfully run migrated bots that use the <b>Run Logic</b> command to pass the credential variable to a non-credential type variable in an insecure manner.</p>

**What's changed**

## Enhancement to Recorder package

The search algorithm for the Recorder package is now enhanced so that when you run a bot an object is captured only if its properties match the exact search criterion that you selected in the **Object properties** table. If the properties of the object do not match the search criterion exactly, then the bot fails with an error message. However, if the search criterion includes a wildcard character, then the bot captures the first object that matches the criterion.

For example, to capture a text box from an application that has three text boxes named **firstname1**, **firstname2**, and **firstname3**, if you select **HTML name** as the search criterion, enter the value `firstname` in the HTML name field, and run the bot, then the bot fails with an error message because a text box with the HTML name `firstname` does not exist. However, in the **HTML name** field, if you enter `firstname*`, and run the bot, then the bot captures the first text box that matches the criterion.

Previously, if there were no objects whose properties matched the search criterion exactly, instead of failing, the bot captured the first object whose properties matched the search criterion partially. For instance, in the previous example, if you selected **HTML name** as the search criterion, entered the value `firstname` in the **HTML name** field, and ran the bot, then instead of failing, the bot captured the first text box that matched the criterion partially.

---

**Note:** This enhancement is available for the bots you create using the 2.4.0-20211016-070100 version of the Recorder package starting from this release. To use this functionality in the bots created using a previous version of the package, you must recapture the objects.

---



**What's changed**

Enhancement to File package (Service Cloud case ID: 00755631, 00780237)

- In the **Copy Control Room file** action of the File package, the new **Dynamic file path** option in the **Control Room file** field now enables you to use variables in the file path to copy a file from the Control Room repository where the file path is dynamic.
- Some actions and properties in the File package are now updated, as follows:
  - The **Copy** action is now renamed **Copy Desktop file**.
  - The **Download CR file** action is now renamed **Copy Control Room file**.
  - In the **Copy Control Room file** action, the following fields are renamed:
    - The **Select a Control Room file** field is now renamed **Control Room file**.
    - The **Save CR file to location** field is now renamed **Target file path**.
  - In the **Copy Control Room file** action, the **Control Room file** field now has two new options: **Static file path** and **Dynamic file path**.

The **Static file path** option is an existing feature in the **Control Room file** field that enables you to browse the Control Room repository and select the file. When you browse the repository using **Static file path**, files with **.bot** extension are no longer displayed.

---

**Note:** The renaming of actions within the File package does not impact existing bots that use these actions.

---

[File package](#) on page 2600

Changes to Connect action in FTP / SFTP package (Service Cloud Case ID: 00792346)

The following changes are made to the **Connect** action:

- **SSH FTP** server type is now renamed **Secure FTP**.
- When you select the server type **FTP Secure**, the **User credentials** authentication type is now renamed **Username & Password**.

---

**Note:** From this release, if you use the Secure FTP credentials in FTP Secure, the bot will fail. Instead, we recommend you to use the **Credential** option available in **Secure FTP** to connect with the Secure FTP server.

---

- Change in **Connect** action: If you created bots using the **Connect** action using Automation 360 v.22 and earlier releases and you update to v.23, the bots display some of the **Connect** action settings as deprecated due to changes in the interface. However, your existing bots will continue to run successfully. For new bots, we recommend that you create them using the **Connect** action available from this release.

Support for copying one or more variables (Service Cloud case ID: 00549368, 00751052, 01260498)

You can now copy one or more variables from one bot and then paste them in another bot. Previously, the copy operation also copied the actions along with the variables.

What's changed
<p>Support for reserved characters in Distinguished Names (DN) for Active Directory Control Room (Service Cloud case ID: 01133364, 00952301)</p> <p>You can now use reserved characters, such as the comma (,), in the DN or the username of a Control Room configured for Active Directory users.</p>

The following table lists the fixes and the builds in which they were fixed. Build 11513 is the latest build and includes fixes from the previous builds.

Fixes		
Build	Service Cloud case ID	Description
11513	00797196, 00818347	<p>Updates to the Private workspace API ( /v2/repository/workspaces/{workspaceType}/files/list):</p> <ul style="list-style-type: none"> <li>• Only private workspace authorized users can list the bots from the private workspace.</li> <li>• Admin cannot list the private workspace bots.</li> <li>• Only public workspace authorized users cannot list the private bots.</li> <li>• One private workspace authorized user cannot list another user private workspace files.</li> </ul>
11513	00808478, 00814198, 01260666	<p>If you are a Control Room administrator, when you change the viewing permissions of some bot folders so that they can be viewed only by specific users, the change is now correctly applied. Previously, changes made to the viewing permissions of bot folders were not applied correctly.</p>
11513		<p>When you update from Automation 360 v.22 to v.23, background jobs related to cloud license server sync-ups are no longer deleted because of incorrect license job name.</p>
11513	01753484, 01754939	<p>You can now deploy (both schedule and run) bots from the Control Room without any issue if you have the <b>View Package</b> permission.</p> <hr/> <p><b>Note:</b> The <b>View Package</b> permission is required to deploy (both schedule and run) bots from the Control Room.</p> <hr/>

Fixes		
Build	Service Cloud case ID	Description
11513	--	When you install or update to Automation 360 v.23 for On-Premises deployments, the log files are now updated for all the services without any issue. Previously, the log files for a few additional services were not updated with any information or time stamp of the activities.
11486	00793800	When you migrate to this release, issues related to JRE while installing the Control Room on machines using Microsoft Hyper-V servers are now fixed. The following error no longer occurs: <b>Unknown Failure</b> . Please check the database login credentials and check if this machine has a network connection to the database server.
11486	00815340	User folder names given similar leading portions or naming conventions no longer display folders that share naming conventions but not the assigned or specific user permissions.
11486	00836898, 01259938	The Cloud Migration Utility now includes enhanced logic to enable you to successfully upload data even when the network is connected through a proxy server.
11486	00817173	You can now perform a Run DLL function when both the input and output parameters are set to a String value, and the Date and Time value is now passed as a String parameter successfully. Previously, the Date and Time value was converted and not displayed as expected.
11486	00754305, 00769128	The configuration tagging works properly now, based on the settings configured in the nodemanager-logging.xml file. Previously, the node manager and bot launcher logs were purged either after two days or if the log count was increased by specific amounts due to tagging issues with tags such as the following: "IfLastModified age" and "DirectWriteRolloverStrategy"
11486		When you decide to select or deselect all the bots and dependencies, you can now select or clear the <b>Select All</b> check box without any issues. Previously, after selecting the <b>Select All</b> check box, when you cleared the check box, it did not work as expected, and you had to deselect the bots and dependencies individually.

Fixes		
Build	Service Cloud case ID	Description
11486	00798037, 00814184	The <b>Manage</b> and <b>Administration</b> labels in the navigation pane are now updated to ensure that roles and permissions are distinct in the following languages: Simplified Chinese, Traditional Chinese, Japanese, and Korean.
11486	01218053	You can now import parent and child bots with dependencies even if you do not have permissions to all folders.  Previously, if a user with no folder permissions imported parent and child bots with dependencies, the dependency between them was lost.
11486	01046249	When you migrate from Enterprise 11 to Automation 360, duplicate entries are no longer created for any of the existing commands.
11486	--	You can now migrate an Enterprise 11 bot that uses the <b>Run Task</b> command successfully even if the <b>Upon error, continue with next repeat</b> option is not selected.  Previously, the parent bot stopped running if the child bot encountered an error. Now, when this option is not selected, an error handler ensures migration is successful even if the child bot encounters an error.
11486	--	If you used the <b>Go to cell</b> action from the Excel advanced package in an Enterprise 11 bot, the setting is now retained when you migrate it to Automation 360.
11486	00779016	You can now use the XML package to open any <code>xml</code> files without any issue after migrating to Automation 360.
11486	00794202	You can now migrate Enterprise 11 bots with If command to Automation 360 without any issues.
11486	00790245	You can now use the SOAP Web Service action of the SOAP Web Service package without any issues after migrating to Automation 360.
11486	00795518, 00832462	If you used the <b>Delete cells</b> action from the Excel advanced package in an Enterprise 11 bot, correct cell addresses are now displayed when you migrate it to Automation 360.

Fixes		
Build	Service Cloud case ID	Description
11486	00808601	Migrated bots that include Extract and Substring actions of the String Operation no longer encounter an error if the input string is empty.
11486	00807945, 01258127	When you migrate Enterprise 11 bots using the Error Handling command, an error no longer occurs if the file path value in the variable is missing the file extension from the <b>Snapshot</b> and the <b>Log to file</b> . After migration, the Snapshot file now saves files with <b>.png</b> extension and <b>Log to file</b> with <b>.txt</b> extension.
11486	00777395, 00807705, 00814087	The migration process now adds the <b>Window &gt; Set title</b> action for all the <b>Elself-window exists</b> conditions. This setting enables you to make the window title dynamic, eliminating the need for you to recapture the window title when it changes.
11486	00820094, 01019195	After you migrate to Automation 360 from Enterprise 11 or Enterprise 10, the <b>Error Handler</b> snapshot error is now logged to the <b>Snapshot</b> image path. If the snapshot image path is provided as a variable, then the snapshot error is logged to the default application path.
11486	00810389	You can now migrate bots with variables whose names start with or contain <code>arrayRows</code> . You no longer encounter a stack overflow error and the bots are successfully migrated.
11486	00795347	The <b>DLL Run</b> action now successfully copies your data from one Excel sheet to another even if the .Net DLL uses the OLE mechanism (for example, clipboard) to copy data. Previously, when data was copied from one Excel sheet to another, a threading-related exception occurred.
11486	00787562	After migration to Automation 360, an Enterprise 11 large bot (with 2000 or more commands) no longer encounters the <code>Code too Large for try statement preprocessing</code> error when the bot is used in Automation 360. However, if the migrated bot includes a <b>Loop</b> or <b>Trigger Loop</b> command with <b>Continue</b> or <b>Break</b> as a child command, a preprocessing error might still occur when the bot is run.

Fixes		
Build	Service Cloud case ID	Description
11486	00782594, 00786968	When you migrate to Automation 360, an Enterprise 11 bot with large array sizes no longer encounters Java heap errors. If the total size of the arrays in one bot exceeds the threshold value of the array size, then the arrays variables are migrated as is till it breaches the threshold value. However, the remaining array variables are migrated as table variables with no default value using the <b>Database &gt; table</b> action.
11486	00792346	If your Enterprise 11 bot was configured with <b>Secure FTP</b> without <b>Key File Authentication</b> , the migration process now appropriately configures the bot with the <b>Secure FTP</b> server type in Automation 360. Previously, the migration process incorrectly configured the bot with the <b>FTP secure</b> server type.
11486	--	Users with the <b>AAE_Bot Migration Admin</b> role no longer encounter an issue when they migrate bots using the Bot Migration Wizard.
11486	--	The Bot Migration Wizard now displays the correct number of MetaBots on the <b>Select bots to migrate</b> screen.
11486	--	Enterprise 11 bots that are migrated no longer encounter an error when a variable that is mapped between the parent bot and a child bot is not available in either of the bots.
11486	00729719, 00959356	You can now add or update SAP automation using the <b>Capture</b> action of the Recorder package when the SAP scripting is disabled in the Enterprise 11 bot.
11486	00639940, 00770561	If the migration process fails, the <b>All migration</b> screen now shows the status as <b>unsuccessful</b> . Previously, when the migration process failed because of invalid device credentials, the screen showed that the migration process is in progress but the <b>Audit log</b> displayed the correct status.
11486	00840456	The migration process no longer encounters an error when you migrate a MetaBot that contains a logic that has an extra space character at the end of its name.
11486	00786646, 00808600, 00822029	Migrated bot no longer encounter an error when they contain commands that perform an action on a pop-up window of a browser.

Fixes		
Build	Service Cloud case ID	Description
11486	00777467	Migrated bots no longer encounter an error when they are checked out in Automation 360 and they contain an invalid expression that is added by the migration process.
11486	00786002	You can now delete <code>.atmx</code> and <code>.mbot</code> files from the Control Room if you have all the required permissions.
11486	00796725	The Bot Scanner no longer encounters an error when it scans a bot in which the window title is specified using a variable within brackets.
11486	00790861, 00836849	Migrated Enterprise 11 or Enterprise 10 bots no longer encounter an error when they use the <b>Run Logic</b> command to run a MetaBot logic and the location of the logic is specified up to the folder that contains that logic. For example, consider that you have a MetaBot named <code>Finance1</code> and you want to run <code>Logic1</code> that is available in the MetaBot at the <code>Metabots\Logics\Finance</code> location. Previously if you specified only <code>Metabots\Logics\Finance</code> instead of the complete path ( <code>Metabots\Logics\Finance\Logic1</code> ) of the logic, an error occurred.
11486	00804550	You can now import bots from an Enterprise 11 production environment to an Automation 360 development environment even if these bots include the user ID of the user who had checked out the bot in Enterprise 11.
11486	--	When you search for bots with the following characters, the bots are now displayed in the search results:  <code>r\${@1&amp;#klu%}({,!'~`\$^&amp;()_ - += []</code>
11486	00729393	After you migrate from Enterprise 11 to this release, you can now view the bot subfolders in your Control Room <b>Public</b> workspace on the <b>Automation</b> page.
11486	--	After you migrate from Enterprise 11 to this release, you can now check in bots to the Control Room Public workspace from a folder for which you have the <b>Check in</b> permission using the Repository Manager API. The API response code no longer shows the following:  <code>"upload": false.</code>

Fixes		
Build	Service Cloud case ID	Description
11486	01032367, 01066099	An issue with the bot deployment progress window is now fixed. Previously, even after the bot completed the run, the window was displayed for a long time (for example, for more than 10 seconds in some cases).
11486	00826923, 01081380, 01259907	After you migrate from Enterprise 11 to this release, you can now add work items to queues using the Workload API through AWS Lambda. A StackOverflow error no longer occurs in the Control Room logs.
11486	00801810	When you update Automation 360 On-Premises to this release, Bot Agent devices now remain in connected state. WebSocket errors are no longer generated in the C:\ProgramData\AutomationAnywhere\BotRunner\Logs\node_manager.log file.  Previously, when you updated from Automation 360 v.19 (Build 8147) to Automation 360 v.21 (Build 9664), some issues were reported where the Bot Agent devices remained in disconnected state and WebSocket errors were generated even without any proxy configuration changes.
11486	00831028, 00830336, 00827031, 00832413, 00833089, 00833436, 00832850, 00839997, 00849904, 00857296, 00831062, 00833436, 01140913, 01145306, 01252819, 01127960, 01256324, 01257414, 01258281, 01263606	When you update your Control Room that is configured with Active Directory to this release, you can now use the log in with Windows option and the following error no longer occurs: <code>java.lang.NoSuchMethodError</code> .



Fixes		
Build	Service Cloud case ID	Description
11486	00719407	For On-Premises deployments, when you configure multiple IP addresses for Control Room nodes in a cluster, the primary IP address is now automatically configured. You no longer have to manually configure the primary IP addresses in the <code>cluster.properties</code> file.
11486		<p>When you are installing the Bot Agent, if you run out of disk space and click <b>OK</b> on the <b>Out of disk space</b> window, the wizard returns you to the previous <b>Setup type</b> window so that you can cancel the Bot Agent installation.</p> <p>Previously, when you clicked <b>OK</b> on the <b>Out of disk space</b> window, the wizard displayed multiple windows.</p>
11486	--	When the Bot Agent is updated automatically from a previous release to this release, you can perform various operations simultaneously, such as running bots, configuring device settings in the Control Room, and updating the Control Room. You no longer have to restart the Bot Agent service from the Task Manager.
11486	00781135	After you install the Bot Agent on a user device, when you restart the Bot Agent, the global cache folder ( <code>C:\ProgramData\AutomationAnywhere\GlobalCache\</code> ) is no longer deleted.
11486	00709309, 00766163	You can now upgrade the Control Room installed on Linux to this release and the Elasticsearch service now starts successfully. Previously, the upgrade failed because the service did not start and the following message was displayed: <code>Elasticsearch service fail to start during certificate retrieval process.</code>
11486	00742074	License allocation for users configured to use multi-user devices is now honored for concurrent bot deployments on unattended Bot Runners.
11486	00822176	On multi-user devices, you can now create an RDP session that uses a custom port. Previously, if you configured a multi-user device to use a custom port for RDP-based deployments, the deployments failed.

Fixes		
Build	Service Cloud case ID	Description
11486	00806583, 00805381	When you perform RDP-based deployments on a device, FreeRDP no longer fails when connecting to a Windows server for per-device RDS licensing.
11486	--	If you deploy bots using event triggers and install the Bot Agent on a device as a non-admin user for yourself or a local admin user, the Bot Agent is now updated automatically. The device is no longer shown as disconnected in the Control Room.
11486	00803434	Issues with the change in Jetty HTTP client behavior on load balancers with custom rule for host headers to route a request are now resolved. Device registration now does not fail and the port numbers are added to the host when default ports are used.
11486	00815334	Performance issues related to logging in to the Control Room and editing and running bots in the Cloud Control Room are now fixed.
11486	00543141, 00674098, 00714238, 00744991, 00750325	With Splunk integration and enhancements to syslog, you can now forward audit logs to remote Splunk servers and view audit logs on Splunk dashboards.
11486	00776569	When a bot you run encounters an error, an appropriate preprocessing or runtime error message is now shown. Previously, a preprocessing or runtime error message was shown even if the bot did not contain an error or if the bot was empty.
11486	00781638, 00805371, 00804784	Issues with a checked-out bot and its clone are now resolved. When one user checks out a bot, makes changes to it, and checks in the bot, the clone of the bot in another user's <b>Private</b> workspace is now updated with the changes.
11486	00784252	If you do not have Control Room admin privileges and you check in bots to the Cloud Control Room <b>Public</b> workspace in subfolders, the bot folders no longer take time to load in the Control Room.

Fixes		
Build	Service Cloud case ID	Description
11486	00786716, 00801631, 01189873	An error no longer occurs when you use the <b>Download</b> action in the Browser package to download a file from a web URL. Previously, if a web URL had a backslash at the end or space characters at the beginning or end, the bot failed to download the file.
11486	00783197, 00818698, 00820666	When you use the <b>Assign</b> action of the Number package to assign decimals to an existing number variable, an error no longer occurs irrespective of the device locale settings on the machine.
11486	00778496	You can now successfully import the bot archive into the public workspace even if the archive creates a folder named <b>System</b> in the <b>Bots</b> folder.
11486	00774026	You no longer encounter an issue when you use the <b>CSV/TXT &gt; Open</b> action and the <b>Task Bot &gt; Run</b> action to search for a file or a bot with a name that contains Japanese characters.
11486	00761035, 00786113	You can now use the <b>Recorder &gt; Capture</b> action to capture an object on a window that has a tree view and also retrieve the <b>Item name</b> property of that object by using the <b>Get property</b> action. Previously, when you ran a bot, the recorder captured the object on the window successfully but failed to retrieve the item name of that object in the output.
11486	00763925	An error no longer occurs when you use the <b>Split</b> action of the String package to split a source string that has any combination of Unicode characters.
11486	00767074	In Internet Explorer, when you use the <b>Browser &gt; Open</b> action to open a new window or tab, the new window or tab is now displayed in front of the other, non-admin open windows.
11486	00819664	You can now create bots using the SOAP Web Service action. XML calls no longer return corrupted data when the SOAP response has an XML document as an inner element.

Fixes		
Build	Service Cloud case ID	Description
11486	00748494, 00829735, 01018622	You no longer encounter any issues when you deploy a bot containing email triggers. Now, each time an email message is sent, the bot is triggered and runs successfully. Previously, the email trigger worked only for the first time an email message was sent, and for subsequent email messages, the bot was not triggered and did not run.
11486	--	The <b>Task bots runs</b> metric on the <b>Home</b> dashboard page of the Control Room now displays the correct count. Previously, the <b>Task bots runs</b> metric displayed the count as zero even if you have run bots from the same Control Room.
11486	00824309	In the <b>Run stored procedure</b> action of the Database package, when you click <b>Add parameter</b> to provide an input or output parameter, the label for the parameter type field now displays as <b>Parameter type</b> . Previously, the label for the parameter type field was not displayed correctly.
11486	00810212	When you use the <b>Run</b> action of the Task Bot package and select the <b>Multiple variables</b> option in the <b>Save outcome to a variable</b> field, the variable name is now displayed in the correct case. Previously, the variable name was displayed in lowercase even if the variable name was created using uppercase.
11486	00796913, 00836389	You can now use the <b>Move all</b> action from the Email package to move multiple email messages from Inbox to another folder. Previously, the <b>Move all</b> action was not able to process a large number of email messages because disk storage ran out of space.
11486	00798673, 00815700	An error no longer occurs when you use the Database <b>Connect</b> action, enter the connection string that uses Windows authentication, and run the <b>Run stored procedure</b> action that has an input parameter value of more than 36 characters. Previously, an error was displayed when the length of the input parameter value exceeded 36 characters.

Fixes		
Build	Service Cloud case ID	Description
11486	00799450	When an excel spreadsheet is opened in the <b>SAP</b> editor and simultaneously you use <b>Open</b> action of the Excel advanced package to open an excel file, any error no longer occurs when the bot is run and the Excel file is opened successfully. Previously, an Excel file opened in the <b>SAP</b> editor was considered the default window and therefore when you ran the bot, an error was displayed stating that the Excel file could not be opened.
11486	00794102	In the REST Web Service package, the description below the <b>Assign the output to a variable</b> field is now translated correctly for the following languages. <ul style="list-style-type: none"> <li>• Japanese</li> <li>• French</li> <li>• Italian</li> <li>• Portuguese (Brazil)</li> <li>• Simplified Chinese</li> </ul> <p>Previously, the description was not correctly translated for these languages.</p>
11486	00788920, 00796452	In the Email package, when you use <b>Connect</b> action to connect to the <b>Outlook</b> or <b>IMAP</b> server, you can now successfully download the email attachment in .eml file format. Previously, if you had email attachments in .xlsx and .eml file formats, only .xlsx files were downloaded.
11486	--	If you create a Dictionary variable with the Any subtype and select <b>Datetime</b> as the default value, when you click the time icon, you can now see the time values displayed in the drop-down list. Previously, when you clicked the time icon to select the time from the drop-down list, the values were not displayed.
11486	00746630	You can now create a new task using Excel advanced with <b>Loop</b> and you select the <b>For each row in worksheet (Office 365 Excel)</b> option from the <b>Iterator</b> list, create a <b>Record</b> type variable, and run the bot. An error no longer occurs when you edit the same bot and select the <b>For each row in worksheet (Excel basic or Excel advanced)</b> option from the <b>Iterator</b> list. Previously, a preprocessing error was displayed on bot execution.

Fixes		
Build	Service Cloud case ID	Description
11486	00762978	If you use the <b>Windows &gt; Close</b> action and select <b>Currently active</b> as the window title to close active windows, when you run the bot, the <b>Shut Down Windows</b> pop-up is no longer activated even if there are no active windows on the machine.
11486	00805654	The <b>Split</b> action of the String package now allows you to select the <b>Any</b> variable type to hold the output values. Previously, you could select only the <b>list</b> variable.
11486	00761189, 00764563, 00785751, 00794273, 00835194	Performance issues related to the <b>Run macro</b> action in the Excel advanced package are now fixed.
11486	00796120	When you use the <b>Data table &gt; Sort</b> action to sort a column, if the column does not contain any value, the bot now runs as expected and does not get stuck. Previously, you had to stop the bot manually.
11486	00830011	In the Excel advanced package, when you perform the <b>Go to next empty cell</b> action on an Excel sheet, the system no longer runs out of memory.
11486	00765210, 00790641	An error no longer occurs when you use the <b>Excel advanced &gt; Open</b> action to open an Excel file that contains a pivot table.
11486	00776021	When you use the Open action of the Excel advanced package to open an Excel workbook, even if the workbook has invalid links, the bots now run as expected.
11486	00692220, 00785965, 00798035	Performance issues related to the <b>Write from data table</b> action of the Excel advanced package are now fixed, and the action now performs better on Excel sheets with large amounts of data.

Fixes		
Build	Service Cloud case ID	Description
11486	00808137	<p>The format of <b>Start date</b> and <b>End date</b> under the <b>Date</b> condition is now updated to <b>MM/dd/YY</b> for the following actions of the File and Folder packages, where <b>dd</b> now correctly shows the date:</p> <ul style="list-style-type: none"> <li>• File package <ul style="list-style-type: none"> <li>• <b>Copy Desktop files</b> action</li> <li>• <b>Delete</b> action</li> <li>• <b>Print</b> action</li> <li>• <b>Print multiple files</b> action</li> <li>• <b>Rename</b> action</li> </ul> </li> <li>• Folder package <ul style="list-style-type: none"> <li>• <b>Copy</b> action</li> <li>• <b>Delete</b> action</li> <li>• <b>Rename</b> action</li> </ul> </li> </ul> <p>Previously, the format of <b>Start date</b> and <b>End date</b> was <b>MM/DD/YY</b>, where <b>DD</b> gave the day count of the year instead of date.</p>
11486	--	<p>When you run a bot with the following sequence of actions, the file is now successfully deleted at the end of the sequence:</p> <ol style="list-style-type: none"> <li><b>1. CSV/TXT &gt; Open</b> action to open a .csv file</li> <li><b>2.</b> A loop action within another loop action to retrieve values from the .csv file</li> <li><b>3. CSV/TXT &gt; Close</b> action to close the file Here, all the actions are using the same, default session.</li> <li><b>4. File &gt; Delete</b> action to delete the file</li> </ol> <p>Previously, the file was not deleted because the bot failed to close the default session.</p>

Fixes		
Build	Service Cloud case ID	Description
11486	01164436, 01209626, 00975390, 01080879, 01254846, 01256132, 01255004, 01263774,01253240	An error no longer occurs when you use the 2.4.0-20211118-080716 version of the Recorder package to capture a control using HTML technology in the Google Chrome or Microsoft Edge Chromium browser and run the bot. Previously, when you used the 2.3.0-20210806-215200 version of the Recorder package, the bot failed with the following error message:Unable to find control. Search Criteria did not match
11486	00818990	The capture anchor option in the Recorder package is now supported for the Citrix XenApp application. You can now select an anchor to search for an object in a user interface during bot run and execute actions based on it.
11486	00782962	An error no longer occurs when you loop through multiple Excel sheets and use keystrokes inside the loop to copy and paste the retrieved values into another Excel sheet. Previously, when you opened and closed multiple Excel sheets within a loop, the bot did not identify the correct Excel sheet for performing the keystroke action.
11486	--	You can now use the <b>String &gt; Import string from text file</b> action to read values from a text file when a bot runs if the text file encoding was set to any of the following encodings: <ul style="list-style-type: none"> <li>• UTF-16BE</li> <li>• UTF-8</li> <li>• ANSI</li> <li>• Window-1251</li> <li>• UTF-16LE</li> <li>• Shift-JIS</li> </ul>
11486	--	When you update the Control Room on Linux from any earlier version to Automation 360 v.21, the Control Room now displays the updated interface. Previously, when you updated to Automation 360 v.21, the Control Room continued to display the old interface from the previous version.



Fixes		
Build	Service Cloud case ID	Description
11486	00816941	You can now run bots with a queue based on the sorting order that was selected for the work item column in the work item template. Previously, the bots were deployed based on the sequence in which work items were inserted into the queue.
11486	00804330, 00822092	After a bot is deployed on a user device, the <b>Run History</b> page ( <b>Manage &gt; Scheduled</b> ) now shows the correct details about the run history of the bot.
11486	--	When you pause and resume a workload automation after using the run bot with queue in the Control Room, the audit entries are now captured on the <b>Audit logs</b> page.
11486	00803717	In the Control Room <b>Historical activity</b> page, the <b>Modified by</b> column now shows the name of the user (Bot Creator or Bot Runner) who scheduled a bot on a user device. Previously, the column displayed the username of the latest bot user.
11486	--	When you deploy workload bots from the Control Room, you can now run workload automation with elevated privileges by using the <b>Run as administrator</b> option.
11486	00780635, 00791587, 00795559, 00795632, 00797130, 00797113, 00791783, 00765770, 00826805, 01859661	When you update from a previous release, schedules no longer disappear from a Control Room configured on a single-node or multi-node environment. Also, previously deactivated schedules no longer disappear and become reactivated automatically after the update.
11486	00974353	You can now deploy workload bots on Bot Runner devices because the bots associated with a queue cannot be deleted. Previously, user had permission to delete the workload bots while running with queue.
11486	00830546, 01181402	When work items are inserted for workload automations, an Apache Ignite StackOverflow error no longer occurs, and the Control Room server no longer stops running.

Fixes		
Build	Service Cloud case ID	Description
11486	01021889	When you schedule or deploy a bot from the Control Room, if a bot fails to run, an email notification is now sent. Previously, even if the Control Room administrator enabled the <b>A Task Bot stops running because it is unsuccessful</b> setting in the Control Room, an email notification was not sent.
11486	00949288	Scheduled bots are no longer stuck in the pending execution status intermittently on the <b>Activity</b> page, and subsequent bots scheduled for execution are not stuck in queue.
11486	01253045, 01256337	Each scheduled bot is now deployed on Bot Runner device one time in a day. Previously, some scheduled bots were deployed twice on Bot Runner device.
11486	00750399	You can now capture objects from Microsoft Internet Explorer running as XenApp on a Citrix Server that has multiple Citrix applications installed.

The following table lists the limitations identified in the current release:

Limitations in this release
<p>In Enterprise 11, if bots were using windows variable where the window title value did not use the exact case as that of the application window title, after migration, the bots will fail to execute.</p> <p>Workaround: You can migrate to Automation 360 v.26 release where this issue is fixed or ensure that you change the case of the window titles in windows variables to match the case of the window titles and then migrate the bots.</p>
<p>When you migrate a bot that was using the Manage Window Controls action, the last digit of the height value is not available after migration. However, the bot will execute successfully. (Service Cloud Case ID: 01756996)</p>
<p>When an Excel session is active in SAP, a corresponding Excel process starts in the background. In such a scenario, Automation 360 uses the same Excel process that SAP started. When you run a bot to automate spreadsheet data, Automation 360 processes the first request successfully. However, during execution, if the Excel is closed and a subsequent request is sent for automating the spreadsheet data, Automation 360 does not process the request because the Excel process is still being accessed by SAP. Therefore, the correct window is not activated for automating the spreadsheet data. (Service Cloud Case ID: 00815159)</p>
<p>When you run the bot, the <b>Task bots run</b> metric on the <b>Home dashboard</b> page of the Control Room does not display the correct count. For example, the task bot run count shows 39 on the <b>Home dashboard</b> page, but when you run the bot, the count is displayed as 42 instead of 40.</p>

Limitations in this release
(Service Cloud case ID: 01753337 ) In the "In progress" table, the column sort function cannot be used to list items in ascending or descending order.
After migration, when you run a parent-child bot that share a session and use different DLL package versions, the bot fails with a run-time error message.
<ul style="list-style-type: none"> <li>• Nested IFrames are not supported in Google Chrome and Microsoft Edge Chromium browsers.</li> <li>• After performing an action in an application or page, if a frame is added during run time to the application or page, and the frame is populated and page is not refreshed or reloaded, elements in the application frame or page cannot be captured or played until you manually refresh that page.</li> </ul>
<p>(Service Cloud case ID: 00988580, 01200161) After you migrate from Enterprise 11 to Automation 360, you might not be able to <b>Check out</b> some bots and dependencies to the Control Room <b>Public</b> workspace.</p> <p>Workaround: Check out the parent bots to the Control Room <b>Public</b> workspace. The dependencies are then automatically cloned.</p> <p>For more information, see <a href="#">Cannot Check Out With Child Dependencies Due To No Versions (A-People login required)</a>.</p>
<p>If you are directly updating from Automation 360 On-Premises v.20 or v.21 to this release, you might face issues updating your Bot Agent on some Bot Runner machines in the following scenarios:</p> <ul style="list-style-type: none"> <li>• After a Control Room update, the device status keeps changing and the Bot Agent fails to update automatically.</li> <li>• If the <code>embedded_resources</code> file is missing, the Recorder does not recognize the user interface elements or does not capture a single object in the Google Chrome browser.</li> </ul> <p>Workaround: Before updating to this release, remove the following Bot Agent files and folders:</p> <ul style="list-style-type: none"> <li>• <code>C:\Windows\System32\config\systemprofile\AppData\Local\AutomationAnywhere\AA-DB.mv.db</code></li> <li>• <code>C:\ProgramData\AutomationAnywhere\GlobalCache\embedded-resources</code></li> </ul> <p>For more information, see <a href="#">Bot agent auto update fails post the Control Room Upgrade with 'device.connection.lost' (A-People login required)   The recorder is not able to recognize the GUI elements in Google Chrome browser (A-People login required)</a></p>
In some cases, if you <b>Check in</b> a bot to the Control Room <b>Public</b> workspace after filtering any dependency, when you export the bot, all the dependencies are displayed instead of the filtered data.
<p>(Service Cloud case ID: 00773700) The migration process fails to migrate bots that contain more than 96 conditions in a single If command.</p> <p>Workaround: Split the If command into two If commands in Enterprise 11 and then migrate the updated bot.</p>

Limitations in this release
<p>If you create a bot that has invalid JSON tags with an Error Handling action (Try/Catch) in it, and if the <b>Bot validation service</b> is enabled (ON) in the <b>Settings &gt; Bots</b> page, when you run the bot, the bot fails because of a preprocessing error.</p> <p>Workaround: In the Bot editor, open the bot that displays the error. Select and click any line of code, edit it, and save it. For example, if you have created a bot using the <b>Comment</b> action, select and click the <b>Comment</b> action, edit it by entering a space in the comment box, and then click <b>Save</b>. When you run the bot now, it no longer displays a preprocessing error.</p>
<p>In SOAP Web Service, selecting the <b>Raw data</b> parameter and using the <b>Build Xpath</b> option to extract values from SOAP response to store the XML output in a variable does not work.</p> <p>Workaround: Enter the Xpath expression manually instead of using the <b>Build Xpath</b> option in the selected response.</p>
<p>When you try to establish a secure SQL connection in the Linux environment by choosing the <b>Enable</b> option in the <b>Database Configuration &gt; Secure Connection</b> field, the Linux installer fails to import the SSL certificate, and the connection fails.</p> <p>Workaround: Select the <b>Disable</b> option in the <b>Database Configuration &gt; Secure Connection</b> field. The Linux installer successfully establishes a secure SQL database connection.</p>
<p>In Linux environment, the file upload functionality of Automation Co-Pilot on the web fails with an access denied error. This error occurs because the <code>filestorage</code> directory is not automatically created to store the files.</p> <p>Workaround: Create the filestorage directory in the Automation 360 repository path and assign the appropriate permissions as outlined in the following steps:</p> <ol style="list-style-type: none"><li>1. Navigate to the Automation 360 repository path: <code>/opt/automationanywhere/automation360/appdata/Server Files</code></li><li>2. Enter the following commands in the Linux console:<ol style="list-style-type: none"><li>a) <code>sudo mkdir storageservice</code></li><li>b) <code>sudo chown -R crkernel:controlroom storageservice</code></li><li>c) <code>sudo chmod -R 775 storageservice</code></li></ol></li></ol>
<p>When you upgrade the Control Room from the previous version, the <b>Task bots runs</b> metric on the <b>Home</b> dashboard page does not display the historical count of tasks bot that ran in the earlier version. It shows only the count of task bot runs from the upgraded Control Room.</p>

Limitations in this release
<p>When you use the Recorder to capture objects on applications running on Microsoft Edge Chromium with Internet Explorer mode, use Recorder conditions in the bot to check whether the element exists in the application, try to capture UI elements in the application based on the result of the condition, and run the bot, then the bot always goes to the next action because the Recorder condition is unable to locate the UI element in the application.</p> <p>Workaround: Use the Image Recognition condition instead to locate a UI element in an application.</p>
<p>Copying Form variables across bots by using the <b>Copy to shared clipboard</b> option is not supported.</p>

The following table lists limitations from previous releases that are also applicable to this release:

Limitations from previous releases
<p>If you configure an external key vault in <b>External Key Vault Integration</b> and select the <b>SQL authentication</b> mode for database authentication in the Windows installer <b>Database Server</b> page to install Control Room (On-Premises), the installation fails, and following error message is shown: <code>Control Room database tables fail to create</code>.</p> <p>Workaround: Add the database credentials in the external key vault and use those credentials for database configuration.</p>
<p>Newly created Control Room users on Windows for On-Premises Google Cloud Platform VMs cannot change their password. The security questions option is not available on the <b>Change password</b> screen and as a result the Control Room displays an error when they try to save the password.</p> <p>Workaround: Refresh the page and change the password again.</p>
<p>(Service Cloud case ID: 00837271) If you are migrating from Enterprise 11 with a database that has a large amount of repository data, the installation might fail. This issue occurs because Liquibase update for a few SQL queries is not completed during migration.</p> <p>Workaround: Contact Automation Anywhere Support.</p>

Security fixes	
Service Cloud case ID	Description
00836486, 00942844, 01264029	Disabled the module for caching that was using credential authentication.

## Automation Co-Pilot (Automation Co-Pilot for Business Users)

What's new
<p>New query filter in Query Requests and Query Tasks actions</p> <p>Use the new filter now available in the <b>Query Requests</b> and <b>Query Tasks</b> actions of the <b>AARI Web</b> package to filter query requests and tasks by team name in the Automation Co-Pilot web interface.</p>
<p>Team name filter</p> <p>You can filter your tasks and requests by team name in the <b>Task</b> and <b>Request</b> pages in the web interface, respectively. Select the <b>Team</b> label from the filter and search by team name to view the teams assigned to a task or request.</p> <p><a href="#">Filter and search for a request</a> on page 3391   <a href="#">Filter and search for a task</a> on page 3393</p>
<p>Support for audit logs (Service Cloud case ID: 00801166)</p> <p>You can now view the audit logs and refer to events relating to requests, teams, scheduler, process setups, bot setups, human tasks, and bot tasks that you have created, deleted, updated, submitted, or recovered.</p> <p><a href="#">Audit log</a> on page 2143</p>
<p>Enhancement to user task assignment in Human Task</p> <p>In the process editor, the <b>Auto-assign this task</b> option in <b>Human Task</b> provides the following alternatives:</p> <ul style="list-style-type: none"><li>• <b>The user who created the request:</b> The task is automatically assigned to the user creating the request in the web interface.</li><li>• <b>The user who opens this task:</b> The task is automatically assigned to the user who opens the task in the web interface.</li></ul> <p>This feature helps to reduce conflicts in assigning a task to oneself, particularly in case of specialized users such as Validator for whom the action of opening a task is equivalent to assigning the task to oneself.</p>

**What's new**

## Enhancement to team setup

You can now simultaneously add multiple users with similar roles (custom role) to the Automation Co-Pilot team in the web interface. The custom role in the Control Room is now aligned with a team in the Automation Co-Pilot web interface, and the enhanced team setup works as follows:

- The users added with the role are assigned a **Member** role in the team. The role cannot be changed to **Owner** or **Admin**.
- You cannot view these users in the **Users** tab of the **Team** page.
- If a user is both part of a role and added manually to the team, their role in the team will be the same as the role assigned to them manually. For example, if a user is a member, they will continue to have the **Member** role whereas if the user is an owner, they will be assigned the **Owner** role in the team.
- If the user is no longer part of a role, the user will also not be a part of the team.

Also, the **Team** page is now enhanced with navigation options at the top so that you can navigate through the various tabs (**General**, **Users**, **Roles**, **Processes**, and **Bots**). Use the **General**, **Users**, and **Roles** tabs to create teams and add users to them. The **Processes** and **Bots** tabs display the processes and bots assigned to teams, respectively.

[Team management](#) on page 3377 | [Create a team and assign roles to team members](#) on page 3387

## Bot setup support

The Automation Co-Pilot Admin can use the **Bot Setup** page to view the bots that are assigned to a team, assign teams to a bot, and edit bots to remove or reassign teams. Attended Bot Runners who can view all the bots that are checked in to the **Public** workspace can now view the bots that are assigned to teams in Automation Co-Pilot Desktop Assistant.

[Bot setup for Bot Runner users](#) on page 3390

## Enhancement to the form logo

You can now use the **Logos in footer** field to select up to two separate logos that are displayed in the footer of the form during bot runtime.

**What's new**

Add rules to various form elements

When you are creating or editing a form in the form builder, you can now add rules to the following form elements by using the **Form rules** tab:

- **Checkbox**
- **Date**
- **Document**
- **Dropdown**
- **Label**
- **Number**
- **Password**
- **Radio Button**
- **Rich Text Editor**
- **Text Area**
- **Text Box**
- **Time**

For the **Checkbox** and **Radio Button** elements, the rules are triggered only if the corresponding presets are selected. For example, if a form has two mutually exclusive options, such as **Yes** and **No**, the rules associated with these options are triggered only when you select one of the two options.

[Conditional actions, rules, and elements](#) on page 3428



**What's new**

Updates to triggers

The following triggers are now available to run a bot:

- **Process trigger:** Starts a bot when the status of the specified process in Microsoft Windows meets one of the following preset conditions:

- **Starts**
- **Stops**

[Add a process trigger](#) on page 2296

- **Service trigger:** Starts a bot when the status of the specified service in Microsoft Windows meets one of the following preset conditions:

- **Starts**
- **Stops**
- **Resumes**
- **Pauses**
- **Is running**
- **Has stopped**
- **Is paused**

[Add a service trigger](#) on page 2297

- **Window trigger:** Starts a bot when the specified application window meets one of the following preset conditions:

- **Opens**
- **Closes**

[Add a window trigger](#) on page 2298

**What's changed**

Enhancement to Create a Request package

In the **Create a Request** package, you can now browse and choose the public process for which you want to create a request. With this enhancement, you can choose the public process without having to contact the Automation Co-Pilot admin for the URI of the public process and enter the URI manually. This feature also simplifies mapping process inputs for initial form fields.

[Process Composer package](#) on page 2893

**Fixes**

Service Cloud case ID	Description
00800192	You can now use an email trigger to start a bot without any issues, even when the email server is POP3.
00801428	You can now add an email trigger to a Gmail account to start a bot for new email messages.

Fixes	
Service Cloud case ID	Description
00736309, 00765069, 00784362	For documents that are in the .csv, .xlsx, or .xls format, you can now use a file trigger to start a bot when a document is modified.
00796697	When you check in a bot, the associated private event trigger is now retained.
00802427	With the Bot Creator license, you can now view all the requests and tasks regardless of your role or other licenses assigned to you.
00829282	When you create a request in the web interface, your bot now runs properly and does not encounter any processing issues, such as an idle status that prevents progress on your bot.
--	When more than four text box elements of a form are populated in a process, the document is now displayed correctly on the document viewer irrespective of the state of the text box elements. Previously, the document was not displayed.
--	When you delete a request from the <b>Request</b> tab and it is sent to the recycle bin, the related task from the <b>Task</b> tab is now removed.
--	When you use the <b>Date</b> and <b>Boolean</b> type <b>If/Else</b> conditions, there is now parity in validating conditions between a bot and a process. Also, the <b>String</b> type <b>If/Else</b> condition now allows the target values to be empty. Previously, validation for <b>Date</b> and <b>Boolean</b> type conditions were not supported when used in a process and the target values could not be empty.
--	Issues with the <b>Hyperlink</b> element in the <b>Human Task</b> are now fixed. The <b>Hyperlink</b> element now works correctly with the following behaviors: <ul style="list-style-type: none"> <li>• If the hyperlink URL is empty, either at design time or when passed from the process, the hyperlink is now unavailable. Previously, the hyperlink was set to the Control Room domain.</li> <li>• If the <b>Hyperlink</b> element is used in a <b>Human Task</b> that is read-only, data is now passed from the process editor to the form. Previously, the data from the process editor was ignored.</li> </ul>
--	For <b>Time</b> element in forms, when the <b>Use the local time when form is first displayed</b> and <b>Make field required</b> options are selected, the time element now treats the system time as the default value and can be modified in the initial form.

The following table lists the limitations identified in the current release:

Limitations in this release
The web interface lacks the <b>Set Warning</b> action and the <b>Set Error</b> action for the <b>Checkbox, Dropdown, Radio Button, and Rich Text Editor</b> elements.
For the <b>Date</b> and <b>Time</b> elements, when the date and time are included in a rule, changes made to the rule format are not reflected in the rules section. As a result, when you try to process a rule that contains that date and time, bot execution fails.  Workaround: Open the rules editor, expand the corresponding rules, and select a respective data value from the calendar before saving. Do not change the format after the date and time element are included as part of any rule. You can also delete older date and time elements.
When you use the <b>Select File</b> element in your forms and select the <b>Make field uneditable</b> option, the element can still be edited.
When you run a bot using the <b>Team Members</b> command from the <b>AARI Web</b> package, you will be prompted with an exception error.
In Automation Co-Pilot on the web interface, if you create a variable by using the <b>Form</b> type in a bot, you cannot copy that variable to another bot even when you select the <b>Keep</b> or <b>Overwrite</b> option.
When a user is a member of a team by role (the user was added to a role in the Control Room then the role was synced to the team), the user will not be able to view updated information on the user interface of the request or task details. This is due to the <b>Request</b> page not automatically refreshing.  Workaround: Refresh the <b>Request</b> page to view the updated request or task details.

The following table lists limitations from previous releases that are also applicable to this release:

Limitations from previous releases
In an SDS setup, when you create a request to upload a file, the upload fails and a <code>SecurityTokenInvalidException</code> error message is displayed.

## Discovery Bot

What's new
Install Bot Agent seamlessly  If you have not already installed the Bot Agent, you are now prompted to install the Bot Agent from the <b>Processes</b> tab. Follow the screen instructions to install the Bot Agent. After the installation, you are prompted to enable a Chrome plug-in in order to proceed with your recording tasks.  <a href="#">Prerequisites for Discovery Bot</a> on page 3896

What's new	
<p>Enhancement to auto-generated opportunities</p> <p>You can now begin reviewing an auto-generated opportunity from the <b>Opportunities</b> tab when at least one process recording is submitted for review. Review the auto-generated opportunity and choose to create a custom opportunity from an auto-generated opportunity, as required.</p> <p><a href="#">Review opportunities, convert to bot, and generate PDD</a> on page 3916</p>	
<p>New recordings for review for custom opportunity</p> <p>You can now review new recordings submitted by a Discovery Bot user for a custom opportunity. You can choose to accept or dismiss the recording updates as part of the custom opportunity work flow. This option allows you to quickly and easily review new recordings in real time as the recordings are submitted by the user for that process.</p> <p><a href="#">Review opportunities, convert to bot, and generate PDD</a> on page 3916</p>	
<p>Enhancements to Opportunities page</p> <p>The opportunities page is now updated to include an opportunities evolution map, along with other graphs, to help you review and analyze data for a potential opportunity for automation. Use the opportunities evolution map to help guide you on which opportunities to automate first.</p> <p><a href="#">Analyzing opportunities for automation</a> on page 3915</p>	
<p>Download PDD document from the Recordings page</p> <p>You can now download and export a PDD document from the <b>Recordings</b> page. After you submit a recording for an analyst to review, the PDD begins processing in the background automatically. When the PDD is generated, the field changes from Processing PDD to <b>Download</b>. You can now choose to download the document in Word format, PDF, or both. An email notification to the business user is also sent to the email address on file. The Download PDD for Word or PDF document is also available for a custom opportunity from the Opportunities list table.</p> <p><a href="#">Review opportunities, convert to bot, and generate PDD</a> on page 3916</p>	

Fixes	
Service Cloud case ID	Description
--	You will now receive one email notification for a PDD generated in Automation 360 v.21. Previously, when you upgraded to Automation 360 v.22, you might have received multiple email notifications about the PDD generated in Automation 360 v.21.

The following table lists the limitations identified in the current release:

Limitations in this release
<p>During upgrade the PDD documents are not getting generated intermittently, for both recordings and opportunities.</p> <p>Workaround: Edit the flowchart for the custom opportunity that displayed an error, and save. Or alternatively, create a new opportunity from the existing opportunity.</p>
<p>Depending on the memory available in your system, the PDD (in PDF or Microsoft Word format) can support up to 250 recorded steps captured in the document. If a process is recorded with more than 250 steps, the PDD generation periodically stops functioning.</p> <p>Workaround: Regenerate the PDD and click <b>Download</b>.</p>
<p>The PDD PDF document for business users and analysts does not display Unicode characters when entered in the opportunity name and step description fields.</p>
<p>Cloud users: For an auto-generated or custom opportunity, an error is displayed from the <b>Recordings</b> table intermittently.</p> <p>Workaround: Refresh the page to update the <b>Recordings</b> table.</p>
<p>After you save your changes, if you update a process workflow by adding or removing steps, the values from the <b>Overview</b> pane might not be updated to include the recent changes.</p> <p>Workaround: Refresh the page to update and include the recent changes made to the opportunity values in the <b>Overview</b> pane.</p>
<p>Cloud users: Creating a custom opportunity with more than 250 steps is not supported.</p>
<p>Linux users: The recording flowchart section is not displayed in the PDD.</p>
<p>For On-Premises deployments, when a self-signed or wildcard certificate is used for the Control Room setup, the <b>Processes</b> page fails to load.</p> <p>Workaround: Update or add the Control Room certificate to the Java Credential Store on all your Bot Runner machines for the <b>Processes</b> page to load.</p> <p><a href="#">Add Control Room certificate to Windows certificate stores</a> on page 1389</p>
<p>For custom opportunities and recordings, there is an intermittent issue and error generating PDD message. You will not be able to access and download a PDD and instead see an <b>Error generating PDD</b> error message.</p> <p>Workaround: Only for custom opportunities, you can either create a new opportunity in your workflow using the <b>Save As</b> option OR edit the your workflow chart with any small change and save it. After doing this, the PDD generation will work properly.</p>
<p>Discovery Bot supports bot conversion to template only. To generate the automation task, you must manually update or enhance the template generated by Discovery Bot in the RPA workspace. (Service Cloud case ID: 01840856, 01822803, 01860950)</p>

## Feature deprecation for Discovery Bot

Review the deprecated feature to understand how it can impact your automation.

### Discovery Bot Aggregated and Comparison options

The Discovery Bot Aggregated and Comparison tabs from the Processes page has been deprecated as of June 2021. You can use the Opportunities tab to view processes in an aggregated workflow.

## IQ Bot

### What's new

#### Document Automation released in Community Edition

Community Edition now offers limited features from the Document Automation version. This version is integrated with the Community Control Room. When you create a learning instance, IQ Bot automatically creates RPA bots to extract and download the data and an Automation Co-Pilot process to manage the end-to-end process. Validation now takes place in Automation Co-Pilot tasks.

Use IQ Bot Community Edition to extract data from invoices in English.

[Document Automation Community Edition](#) on page 3724

#### IQ Bot standard forms enhancements

IQ Bot now provides the following enhancements related to standard forms:

- You can now extract data from tables.
- You can now use container deployment.

[Using IQ Bot for standard forms](#) on page 3798

#### CyberArk support

The On-Premises installation process now enables users to connect to CyberArk to store their custom keys for encrypting and decrypting IQ Bot data.

**Note:** This feature is only available for new installations.

[Installing IQ Bot in Custom mode](#) on page 1440

#### Classifier enhancements

You can now create custom document groups in a learning instance. This reduces the possibility of an OCR failing to detect fields in a document, which will cause the Classifier to create a document group unnecessarily or send the document to a wrong group.

[About the Classifier](#) on page 3743

What's new
<p>View the number of pages purchased and uploaded</p> <p>The IQ Bot dashboard now shows the number of pages purchased and uploaded in the current license period.</p> <p><a href="#">Review the dashboard</a> on page 3793</p>

What's changed
(Service Cloud case ID: 00656822) Credential Vault integration is now available for passwords in IQ Bot.

Fixes	
Service Cloud case ID	Description
00727633	When you import or export learning instances, duplicate classification entries no longer occur.
00768600, 00783773, 00815546, 00795424 , 00788180	When you import an existing IQ Bot archive (IQBA) file, you can now use the <b>Overwrite</b> option without any issues.
00786305	When you import an IQ Bot instance and select the <b>Remove All Existing Instances</b> option, a warning message now appears to confirm deletion of all learning instances. Previously, in such case, no confirmation message was shown and it might led to data loss.
00770638, 00746545, 00827208, 00746545, 00827208	When you import the IQ Bot archive (IQBA) file, you will no longer see duplicate group entries.
00773631	(On-Premises) After you install, restart the IQ Bot services using a different Windows user. Prior to this release, IQ Bot services could not be run with a different account post-installation, resulting in an incompatible FilePath for Liquibase changesets.
--	You can now access <b>IQ Bot &gt; Explore IQ Bot</b> with a refined user experience. Previously, a user could not navigate back to the Control Room landing page. Users can now access the landing page by clicking the back button.
00766454	The <b>Manage your IQ Bots</b> no longer displays the incorrect UI for trained bots currently in production. Previously, it displayed a link to create a bot.
00804476	When you update the classification report, you can now successfully classify the documents in IQ Bot. Previously, because the classification report field name was longer than 75 characters, document classification failed.
--	On the <b>Learning Instance</b> summary page, the number of unclassified documents and the number of documents uploaded are now accurately displayed.

Fixes	
Service Cloud case ID	Description
00695159	An internal exception in the RemoveLines module that caused documents to remain unprocessed has now been fixed, and documents no longer remain unprocessed due to this error.
00806557	You can now successfully assign a group to a bot, and move the bot to production. Previously, in a few instances, the IQBA contained multiple bots for the same group, making the state of the bot inconsistent.
-	You can now download output files without any issues even if API requests are sent frequently to the database during download for any standard forms learning instance.
-	You can now use the IQ Bot Extraction action without any issues even if you selected the <b>Only for me</b> option when you installed the Bot Agent.
--	For bots associated with standard forms learning instances, you can now successfully upload a large number of documents.
00776423, 00829915, 00949561	You can now use a custom port (apart from port 1433) to run the Migration Assistant tool on the database server.
--	When documents with lengthy non-English (for example, Japanese) file names fail, the issue is now logged in the bot_launcher.log file.
00814577, 00812300, 00823120	An unexpected error that occurred due to large unnamed RabbitMQ message queues has been fixed and the user can now navigate to the <b>Learning instances</b> page.
--	The <b>MLScheduler</b> service is now disabled on IQ Bot Cloud, and the system no longer slows down or stops responding. Previously, the auto-correction and auto-suggestion features, which are part of the <b>MLScheduler</b> service, used extensive system resources and caused the system to slow down or stop responding.
--	The <b>Process Document</b> action in IQ Bot Extraction package now fetches the ABBYY pre-processing settings from the IQ Bot server and applies these settings to the classic side of processing during bot runtime.

The following table lists the limitations identified in the current release:

Limitations in this release
<p>When a bot is moved to production, documents become unavailable in the validator output folder or the following error is displayed: <code>Project not found/No documents found.</code></p> <p>Workaround: Ensure that the length of the filename does not exceed 100 characters.</p>



Limitations in this release
<p>In a cluster setup, sometimes, a specific document in production becomes unavailable. Also, an incorrect learning instance summary is displayed.</p> <p>Workaround: Upload again and reprocess documents that are not successfully processed.</p>
<p>In the <b>Designer</b>, some documents for the user-created group and their extraction results do not load.</p> <p>Workaround:</p> <ol style="list-style-type: none"> <li>1. Reload the <b>Designer</b>.</li> <li>2. To obtain extraction details on On-Premises, go to the <code>Settings.txt</code> file and increase the value for <b>See extraction timeout</b>.</li> </ol>
<p>On the learning instance details page, because of the 150-character limit, the group labels for user-created groups are not displayed completely.</p>
<p>When you create an IQ Bot administrator user, if you do not include the <b>AAE_Basic</b> role along with the <b>AAE_IQ Bot Admin</b> role, that administrator user cannot add a new group to a learning instance.</p> <p>Workaround: Ensure that you include the <b>AAE_Basic</b> role along with <b>AAE_IQ Bot Admin</b> role in the Control Room.</p>
<p>For a standard forms learning instance, if you upload a document that contains a table with an invalid field, that document is sent to the <b>Failed</b> folder.</p>
<p>For the <b>Concatenate Images</b> action in the IQ Bot Pre-processor package, no output is generated if a filename contains more than 256 characters.</p> <p>Workaround: Use English language characters and number convention.</p>
<p>When you use the IQ Bot Extraction package along with other OCR-based commands (such as IQ Bot Pre-processor, Document Classifier, AISense Recorder, and OCR) in a single bot, the bot fails.</p> <p>Workaround: Ensure that you create separate bots for IQ Bot Extraction, and do not run IQ Bot Extraction in conjunction with other packages that include the 12.2 Abbyy OCR.</p>
<p>From a learning instance of custom domain type with manual groups, when you export the IQBA file to another instance, the manual <b>Group Label</b> is not exported. Without a manual group label, it is difficult to differentiate between system-generated groups and manual groups in new learning instances.</p>

The following table lists limitations from previous releases that are also applicable to this release:

Limitations from the previous releases
<p>If you have a document with a large number of pages (&gt; 100), an error message is displayed intermittently when you click <b>See extraction results</b> for an existing learning instance.</p>

## Bot Insight

What's changed
To change the language in Bot Insight, you must apply the language settings from either your browser or operating system that is configured to the language of your choice. <a href="#">Internationalization, localization, and language support</a> on page 1214

Fixes	
Service Cloud case ID	Description
00799262, 00826862	An error no longer occurs when you run a bot that includes special characters in the name and the analyze command. Previously, bots with an ampersand (&) in the name and the analyze command included encountered an error.
	The calculation in the device dashboard is now corrected to show an accurate maximum of 100 percent for daily utilization. Previously, a calculation error caused the device dashboard to display over 100 percent.

The following table lists the limitations identified in the current release:

Limitations in this release
Bot Insight is not compatible with Microsoft Internet Explorer 11. For a list of alternative browsers, see <a href="#">Browser requirements for Automation Workspace</a> on page 1210.

**Important:** For information about the packages supported with this release, see [Packages available in Automation 360](#) on page 2316.

## Automation 360 v.22 Release Notes

Release date: 21 September 2021

Review what's new and changed, and the fixes and limitations in the Automation 360 v.22 release. Build 10535 is for Cloud and Build 10526 is for On-Premises. For Automation 360 IQ Bot, Cloud is on Build 10535 and On-Premises is on Build 10520.

**Important:** We have updated the Automation 360 Cloud build to include additional fixes for the Apache Log4j2 component vulnerability. The build includes the new Log4j2 library version 2.16.0.

- Migration  
[11.x and 10.x | 11.x only](#)
- Automation Workspace  
[What's new](#) | [What's changed](#) | [Fixes](#) | [Limitations](#)
- Automation Co-Pilot

[What's new](#) | [What's changed](#) | [Fixes](#) | [Limitations](#)

- Discovery Bot

[What's new](#) | [Fixes](#) | [Limitations](#)

- IQ Bot

[What's new](#) | [What's changed](#) | [What's deprecated](#) | [Fixes](#) | [Limitations](#)

- Bot Insight

[Fixes](#) | [Limitations](#)

## Updating to this release

You can update the Automation 360 v.22 release from the previous three releases (that is, from n–3 releases, where n refers to the latest release).

The following previous releases are certified for update to this release:

- v.21 (Builds 9664, 9642, 9595)
- v.20 (Build 8815)
- v.19 (Builds 8147, 8145, 8122, 8098)

You can directly update to v.22 from any of these builds. For details on how to update, see [Update Automation 360 to latest version](#) on page 1423.

---

**Recommendation:** If you are not on an n–3 release, update Automation 360 to one of the three certified releases before updating to this release.

---

**Important:** This release includes a required update to your . Ensure that you complete the update to continue with your automation activities when upgrading from a previous release to this release.

[Automatically update the Bot Agent](#) on page 1361 | [Manually update the Bot Agent](#) on page 1362

---

To verify which version is compatible with this release, see [Compatibility with release builds](#) on page 1333.

For information about the latest updates to the Automation 360 extensions for Google Chrome, Microsoft Edge, and Mozilla Firefox, see [Browser extensions for Automation 360](#) on page 985.

## Migration features

### Enterprise 11 and Enterprise 10 features

Migrate bots that use Credential variables (Service Cloud case ID: 00705937, 00761271, 00776189)

You can now migrate bots that use Credential variables that are not available in the Cloud Control Room. However, you must create the required credentials after migration in the Credential Vault and use them in the migrated bots to run these bots successfully.

**Enterprise 11 and Enterprise 10 features**

Migration support for Browser, Java, and Java Applet applications for App Integration command

You can now migrate bots that contain the App Integration command with application types such as Browser, Java Applet, and Java applications.

New Action Required tab in Bot Scanner report

In the Bot Scanner report, we have introduced the **Action Required** tab within the **Bots that can be migrated now** section to provide advance notification about bots that require manual intervention after migration so that they can run successfully in Automation 360. View messages associated with the bot that requires action to understand the cause and the specific action you must perform in Automation 360.

[Analyze Bot Scanner report for migration](#) on page 1534

Action required, Review required, and Error messages for migration

Migration messages are now classified into the following categories: Action required, Review required, and Error messages:

- Action required and Review required messages are displayed for bots that contain unsupported commands but which you can still migrate and run after migration by performing specific actions. The messages provide specific actions you have to perform or information that you have to review to ensure that these bots run successfully after migration to Automation 360.
- Error messages are displayed when a specific bot is not migrated successfully. The messages also include the cause for the failure.

[Migration messages](#) on page 1678

**Enterprise 11 only features**

Migrate bots with the following attributes:

- Bots with timeout specified in their property
- Bots that contain the **GUI Automation** command with the **Restore Window** or the **Execute Script** option selected
- Bots that open a session for Terminal Emulator and Microsoft Excel in the parent bot and close that session in the child bot
- Bots that automate email-related tasks on Microsoft Exchange 2013
- Bots that use SAP BAPI standard and custom workflows to automate tasks on SAP applications
- Bots that contain the Window command with the **Close All Open Windows** selected to close all multiple active windows (Service cloud case ID: 00773227)

## Automation Workspace

What's new
<p>Save bandwidth on devices through preloaded offline bot packages</p> <p>Customized or most commonly used bot packages in a bot are now saved offline on a user device to the following new folder: <code>AAPreloadedPackages</code>. When a bot is deployed on a user's device, the packages are used from this <code>AAPreloadedPackages</code> folder instead of downloading them from the Control Room.</p> <p>When a specific version of the package is available, you can download it from the Control Room repository to save the time required to download the package during bot execution.</p> <p><a href="#">Preload packages</a> on page 2310   <a href="#">Devices</a> on page 1873</p>
<p>Introducing Text file package</p> <p>A new Text file package is now available and includes the <b>Get text</b> action. Use this action to extract text from files that have Japanese characters with Shift-JIS encoding and then save the content in the files to a string variable.</p> <p><a href="#">Text file package</a> on page 3134</p>
<p>New actions in Window package</p> <ul style="list-style-type: none"> <li>Use the <b>Close all</b> action to close all windows or programs running on the system, except the windows added in the <b>Add window</b> field.</li> <li>Use the <b>Restore</b> action to restore the size of a maximized or a minimized window or application running on the system.</li> </ul> <p><a href="#">Window package</a> on page 3174</p>
<p>Share session across bots</p> <p>Share a DLL, Excel, and Terminal Emulator session across multiple bots using the <b>Global session</b> option. You can also share a session with specific child bots using the <b>Variable</b> option and share a session with only the current bot using the <b>Local session</b> option.</p> <p><a href="#">Sharing sessions across bots</a> on page 2503</p>
<p>Enhancements to Excel advanced package</p> <ul style="list-style-type: none"> <li>Open files with <code>.xml</code> and <code>.txt</code> extensions using the <b>Open</b> action.</li> <li>Use the wildcard character (*) in the <b>Open</b> action for file names to search based on the wildcard pattern.</li> <li>When you use the <b>Run macro</b> action and specify an argument that has a blank value, this blank value can now be passed to the macro.</li> </ul>
<p>New option in Database: Disconnect action</p> <p>In the <b>Database: Disconnect</b> action, you can now use the <b>Keep database schema in cache until bot finishes running</b> option to enable the <b>Loop</b> action to iterate the dataset by using cached schema after disconnecting from the database.</p>

What's new
<p>TNS name supported for Oracle Database connection</p> <p>TNS (Transparent Network Substrate) name is now supported in the Oracle Database. You can connect to the Oracle Database by specifying the TNS name and path of the <code>tnsnames.ora</code> configuration file.</p>
<p>New Exchange version supported in Email package</p> <p>In the Email package, when you choose an <b>EWS</b> server to establish a connection, you can now use the <b>Exchange2013</b> option in the <b>Exchange Version</b> field.</p>
<p>Enhancement to AISense Recorder</p> <p>AISense Recorder now enables automation of applications that use Russian and a combination of Russian and English interfaces.</p> <p><a href="#">AISense for recording tasks from remote applications</a> on page 2256</p>
<p>Enhancements to recorder conditions for packages</p> <ul style="list-style-type: none"><li>• Use the new <b>Object does not exist</b> condition from the Condition list of any package to verify whether a specific object in a window exists and then execute actions based on the result. This condition works with SAP technology as well.</li><li>• The existing <b>Object</b> condition is now renamed as <b>Object exists</b>.</li></ul> <p><a href="#">Loop package</a> on page 2784</p>
<p>Enhanced support for SOAP Web Service URI (Service Cloud case ID: 00759811)</p> <p>In the SOAP Web Service package, if the input to the <b>Address location</b> field is empty, the bot now retrieves the address location from the WSDL file.</p>
<p>New option in SOAP Web Service package</p> <p>Use the <b>Build SOAP request</b> option in the SOAP Web Service package to retrieve SOAP request details from the SOAP URI or the WSDL file. You can now select any operations from the list of services and ports available in the SOAP Request to automatically populate data in the fields of the SOAP Web Service action.</p> <p><a href="#">Example of using the SOAP web service action</a> on page 3240</p>
<p>New option in REST Web Service (Service Cloud case ID: 00764198, 00800287)</p> <p>In the REST Web Service package, you can now use the <b>Allow insecure connection when using https</b> option to skip SSL certificate validation and to allow non-secure connections.</p>

What's new
<p>Relative click and occurrence supported in packages (Service Cloud case ID: 0055643,00754173)</p> <p>When you capture a target image using the Image Recognition package, you can now use the <b>Preview</b> option to select a specific captured occurrence and position your click location relative to the image.</p> <p>The feature is supported in the following packages and actions:</p> <ul style="list-style-type: none"><li>• Image Recognition &gt; Find image in window</li><li>• Image Recognition &gt; Find window in window</li><li>• If &gt; Image Recognition condition</li><li>• Loop &gt; While &gt; Image Recognition condition</li><li>• Wait for condition action &gt; Image Recognition condition</li></ul> <p><a href="#">Using Find image in window action</a> on page 2732 <a href="#">Using the Find window in window action</a> on page 2735</p>
<p>Wait time option in Google Sheets package (Service Cloud case ID: 00738249, 00817449, 00814775)</p> <p>When you use the <b>Connect</b> in the action in the Google Sheets package to establish a connection with the Google server, you can now set a wait time in the <b>Wait for actions to complete</b> field when performing actions such as <b>Get</b>, <b>Set</b>, or <b>Delete</b>. For example, if you have a large file that takes a long time to open, you can now set the wait time for the file to open before the system executes the next set of actions.</p>
<p>New option for Put action in Dictionary package</p> <p>You can now assign a static value to a key for a dictionary variable by using the <b>Static value</b> option in the <b>Put</b> action in the Dictionary package.</p> <p><a href="#">Dictionary package</a> on page 2493</p>
<p>Java applications supported in App integration package</p> <p>The App integration package now supports Java applications that are based on the Standard Widget Toolkit and Abstract Window Toolkit, which can draw text using Windows text-drawing APIs.</p>
<p>Use regular expressions in File &gt; Open action (Service Cloud case ID: 00737614)</p> <p>Use regular expressions (regex) in the <b>Open</b> action of the File package to support pattern-based search.</p>
<p>Specify timeout for bots (Service Cloud case ID: 00667049, 00690892, 00699158, 00706491, 00739420, 00739415, 00741590, 00769795)</p> <p>You can now specify the amount of time by which the execution of a bot must be completed. The system stops the bot execution if it is not completed within the time you specified.</p> <p><a href="#">Configure timeout for bot execution</a> on page 2324</p>

What's new
<p>New option to search text within bot content in Bot editor (Service Cloud case ID: 00735685, 00736201, 00739122, 00740481, 00733885, 00748970, 00746459, 00738181,00756441,00759037,00761453,00764478)</p> <p>In the Bot editor, use the search box in the Flow, List, or Dual view to search for text, variables, or actions in the entire bot content such as package name, action name, string name, or variable name. This feature helps you to view or edit a bot with long code lines to determine where the searched text, such as variables, strings, or actions, is used and in which line.</p> <p><a href="#">Actions to build bots</a> on page 2363</p>
<p>Enhancements to the bot structure</p> <p>We have enhanced the overall readability of the bot structure and updated the node labels of the bot to show selected properties and parameters of each action in detail in the Flow, List, and Dual views. You no longer have to expand each action to view these details.</p> <p>The Flow, List, and Dual views display the following properties of actions:</p> <ul style="list-style-type: none"><li>• The value you enter for actions such as <b>Set text</b> for all supported technologies</li><li>• Names of objects on which actions such as <b>Set text</b>, <b>Click</b>, <b>Left click</b>, <b>Get property</b>, and <b>Select item by index</b> are performed</li><li>• Name of the object property mentioned in the action</li><li>• Name of the return variable if some value is assigned to a variable</li><li>• List of properties for the <b>Get property</b> action</li></ul>
<p>Enhanced network security control</p> <p>As a Control Room administrator, you can now configure and audit specific, permitted URLs for more granular control of the network access points.</p> <p><a href="#">Set callback URLs</a> on page 1809</p>
<p>Enhanced proxy support</p> <p>Connections to the internet are often run through proxy servers. Automation 360 provides enhanced support for proxy configuration for packages, such as REST and SOAP packages, for building and running bots.</p> <p><a href="#">Connect Bot Agent to a device with a proxy</a> on page 1351</p>
<p>Connect to Azure DevOps (Cloud) Git from Control Room</p> <p>You can now connect to Azure DevOps (Cloud) Git through the Control Room to check in a bot and its dependent files to the remote Azure DevOps (Cloud) Git repository.</p> <p><a href="#">Connect to Azure DevOps Git from Control Room</a> on page 1828</p>
<p>Work item ID and time filters for workload automations</p> <p>Combine the work item ID and start time of a queue to search for specific work items and monitor the progress of these work items. The start time filters the list of all work items that start between specified start date and start time.</p> <p><a href="#">Actions allowed on view queue page</a> on page 2016</p>



What's new
<p>Enhancements to execution type key in AATaskExecutor variable</p> <ul style="list-style-type: none"><li>When you schedule a bot to run, the <code>Execution_Type</code> key in the <code>AATaskExecutor</code> variable now returns information about the execution type with schedule type (frequency) such as <code>Run as schedule Daily</code>, <code>Run as schedule Weekly</code>, or <code>Run as schedule Monthly</code>.</li><li>When you use a trigger in a bot, the <code>Execution_Type</code> key can be accessed through the trigger data. The <code>Execution_Type</code> key returns the <code>Run through Trigger</code> as a string for triggers.</li></ul>
<p>Language support for variable names</p> <p>Variable names now support Greek and Japanese languages. You can now create variable names using the following characters:</p> <ul style="list-style-type: none"><li>Greek uppercase and lowercase characters</li><li>Japanese Katakana full-width and half-width characters.</li></ul>
<p>ML services support in Linux package installer</p> <p>The python package in the Linux installer package is now updated to support ML services. When you download and install Control Room on Linux, ML services are up and running as part of the installation process.</p> <p><a href="#">Installing Control Room on Linux</a> on page 1293   <a href="#">Stop and start Control Room services on Linux</a> on page 1306</p>
<p>Direct download support in Bot Store</p> <p>Users who cannot connect their Control Room to the internet can now directly download Automation 360 bots and packages locally from Bot Store and then import them to their Control Room.</p> <p><a href="#">Download locally and import bots and packages from Bot Store to Control Room</a> on page 3611</p>
<p>MS-SQL database management enhancement</p> <p>Administrators are no longer required to re-install Automation 360 to have the ability to change MS-SQL configuration related settings. The editable settings include username, password, database server name, database server IP and port numbers.</p>
What's changed
<p>Changes to Runtime Window</p> <p>The title on the <b>Runtime Window</b> is now changed to <b>Bot running</b> from the previous <b>Automation Anywhere</b>.</p> <p>If any issue occurs in your automation due to this title change, see this article on how to resolve it: <a href="#">A360.22   Runtime Window: Minimize Command Fails Due to Title Change (A-People login required)</a></p>

What's changed
<p>Changes to Run DLL package</p> <ul style="list-style-type: none"> <li>The <b>Run function (Legacy)</b> action is no longer available in the Run DLL package. We recommend that you use the <b>Run Function</b> action from the Run DLL package because this action is an improved version of the <b>Run function (Legacy)</b> action.</li> </ul> <p>Note that existing bots that use the <b>Run function (Legacy)</b> will continue to run successfully without any issues.</p> <ul style="list-style-type: none"> <li>The <b>Set session variable</b> action is no longer available in the Run DLL package. Instead, we recommend that you create a new DLL session using the <b>Variable</b> option in the <b>Open</b> action of the Run DLL package.</li> </ul> <p>Note that existing bots that use the <b>Set session variable</b> action will continue to run successfully without any issues.</p>
<p>Messages for migrated bots for which referenced MetaBot logic is not available</p> <p>Bot Scanner and Migration Assistant now display action required messages for Enterprise 11 or Enterprise 10 bots for which the referenced MetaBot logic is not available.</p>
<p>Migration of bots with missing variable is blocked</p> <p>The migration process does not migrate Enterprise 11 bots that use a variable which is no longer available and that variable is used in the If, Loop, Variable Operation, or Clipboard command. Previously, these bots were successfully migrated but an error occurred when the bots were run.</p>
<p>Update to MetaBots that use same DLL in multiple logic (Service Cloud case ID: 00684185, 00730248, 00742840, 00742840, 00779629, 00779788, 00727977, 00743986, 00764872)</p> <p>Migrated bots that use the same DLL in multiple MetaBot logic now work as expected without any modification. Previously, you had to update the migrated bots to run them successfully.</p>
<p>Migrated bots run successfully when mapped variables are not available (Service Cloud case ID: 00746651, 00785703)</p> <p>Migrated bots now run successfully when mapped variables are not available in the child bot or the parent bot.</p>
<p>Enhancements to Bot Agent device settings</p> <p>To easily access local and remote devices, a user can now change the Bot Agent device settings from the <b>My Settings</b> page in the Control Room pane below your username. You can perform the following actions:</p> <ul style="list-style-type: none"> <li>Update device credentials</li> <li>Change the default Bot Runner device</li> <li>View local device name, status, and Bot Agent version</li> </ul> <p><a href="#">Set user device credentials</a> on page 1353   <a href="#">View and update Bot Agent device settings</a> on page 1354</p>

What's changed
<p>Enhancement to auto discovery for multiple domains</p> <p>You can now configure the maximum number of sites that can be discovered across the domain in the <code>um.properties</code> file for a Control Room set up for auto discovery across multiple domains in different locations.</p> <p><a href="#">Configure Control Room for Active Directory: auto mode</a> on page 1378</p>
<p>Enhancement to OpenDistro for Elasticsearch</p> <p>As part of enhanced security, OpenDistro (cron-utils) is now upgraded to v.1.13.2 for Elasticsearch v.7.10.2</p>
<p>Update to Printer package</p> <p>In the <b>Remove</b> and <b>Set default</b> actions of the Printer package, you can now select a specific printer from the list of available printers.</p> <p><a href="#">Printer package</a> on page 2891</p>
<p>Insert recorded actions in the middle of a bot</p> <p>You can now insert any recorded actions that are newly captured at a specified location in an existing bot. Previously, recorded actions were added to the existing bot at the end by default and users had to drag the action to the specified location.</p> <p><a href="#">Universal Recorder for object-based automation</a> on page 2239</p>
<p>Migration: system variable behavior outside a loop (Service Cloud case ID: 00761281)</p> <p>When you migrate bots that use system variables outside a Loop package, the variables are now converted to record type or string type user-defined variables as applicable and assigned to a record action. As a result, when bots that contain these variables are run, data from the last row is displayed. Previously, an empty value was displayed after migration.</p> <p>The following system variables are converted to record type variables:</p> <ul style="list-style-type: none"><li>• \$Filedata Column\$</li><li>• \$Excel Column\$</li><li>• \$Dataset Column\$</li><li>• \$Table Column\$</li></ul> <p>The system variable \$XML Data Node\$ is converted to a string type variable.</p> <p><a href="#">Variable mapping for migration</a> on page 1655</p>
<p>Support removed for Redirect URI attribute in Google Sheets package (Service Cloud case ID: 00777287)</p> <p>The <b>Redirect URI</b> attribute in the <b>Connect</b> action of the Google Sheets package is now removed. After updating to this release from previous Automation 360 releases, you can continue to successfully execute your bots by entering the fixed redirect URL in Google Cloud Platform: <code>http://localhost:8888/Callback</code></p>

What's changed
<p>Updates to device credentials recorded in audit log (Service Cloud case ID: 00691511)</p> <p>You can now view audit log entries if your device credential is updated either manually through the Bot Agent device or through the Control Room API. Activity details such as the user name updating the device credentials and the time of the update are logged.</p>
<p>Enhancement to Image Recognition package</p> <p>When secure recording is enabled, the target image that is captured using the actions in the Image Recognition package is now hidden after the initial capture to enhance security. Previously, the user was able to view the target image even when secure recording was enabled.</p> <p><a href="#">Image Recognition package</a> on page 2731</p>
<p>Enhancement to File and Folder package</p> <p>Users with a valid role permission can now create a shortcut to a selected source file at a specified location using the <b>Create shortcut</b> action in the File and Folder package.</p>
<p>Support for HTTP method HEAD (Service Cloud case ID: 00754096)</p> <p>The HTTP method HEAD is now supported as an API call to connect to the load balancer of a Control Room configured for high availability.</p>
<p>Update to Linux installation and log path</p> <ul style="list-style-type: none"><li>• Installation files<ul style="list-style-type: none"><li>• If you are on a version earlier than Automation 360 v.22 or if you have updated from an earlier version to v.22, the installation files are now stored in this path <code>/opt/automationanywhere/enterprise</code></li><li>• If you perform a new installation of v.22, the files are stored in this path: <code>/opt/automationanywhere/automation360</code></li></ul></li><li>• Log files<ul style="list-style-type: none"><li>• If you are on a version earlier to v.22 or if have updated to v.22 from an earlier version, the log files are stored in this path: <code>/var/log/automationanywhere/enterprise</code></li><li>• If you perform a new installation of v.22, the log files are stored in this path: <code>/var/log/automationanywhere/automation360</code></li></ul></li></ul>
<p>Check out a Task Bot with specific version</p> <p>If a bot has multiple versions, you can now select and check out the specific version of the bot. As a Bot Creator, this enables you to roll back to an earlier version of the bot.</p>

What's changed
<p>Signed DLLs for bots and packages</p> <p>Automation 360 now signs all DLLs, including third-party DLLs, for bots and packages.</p> <p>The following are exceptions:</p> <ul style="list-style-type: none"> <li>• The IQ Bot Pre-processor package does not have a new version in this Automation 360 v.22 release. The v.21 package version is copied to v.22 without modification, including a few unsigned DLLs.</li> <li>• The Process Discovery package in this v.22 release does not have the signing applied.</li> <li>• Automation Anywhere</li> <li>• Azul Systems (Java JRE in Bot Agent)</li> <li>• TeamDev Ltd. (third-party library)</li> </ul>

Fixes	
Service Cloud case ID	Description
00712808, 00765752	In previous releases, Automation Anywhere related files were sometimes generated in C:\Windows\Temp. This issue is now fixed.
00800392	An error no longer occurs when you migrate from a Enterprise 11 version where a database is stored on Google Cloud Platform.
00811887	The Cloud Migration Utility no longer encounters an error when you use a custom port number to connect to the Enterprise 11 database.
00815097	Enterprise 11 bots that are checked out by a user are now successfully migrated to Automation 360 Cloud.
00802360	You can now update the value of Enterprise 11 credential attributes after they are migrated to Automation 360 Cloud. Previously, the system encountered an error when you updated the value of a credential attribute that was added or updated by a user in Enterprise 11 and that user was no longer available when Enterprise 11 data was migrated to Automation 360 Cloud.
--	When you migrate from Enterprise 11 to Automation 360 Cloud, an error no longer occurs when a locker is deleted in Enterprise 11 but its related permissions are still used in other entities.
--	An error no longer occurs when you update from Version 11.3.5.2 to any Enterprise 11 version and then migrate from that Enterprise 11 version to Automation 360 Cloud.
--	The <b>Refresh</b> and <b>Back</b> options are now available on the <b>Summary</b> screen of the Cloud Migration Utility when enough disk space is not available to store the backup of Enterprise 11 Control Room data.
00787240, 00781349	Migrated bots no longer encounter an error when a parent bot and its child bot are opened through Internet Explorer and the child bot extracts a table from Internet Explorer.

Fixes	
Service Cloud case ID	Description
--	There is no limitation now on the number of ActiveMQ connections that are allowed when running an automation that is looped 5 times, with each loop running over 20 bots. In previous releases, the automation sometimes failed after the fourth loop.
0074312	You can now successfully migrate bots that contain <b>Trim</b> operation of the <b>String</b> and the output is assigned to an <b>Array</b> variable.
00760963	Migrated bots that contain the <b>Go To Cell</b> command now work properly in Automation 360 after migration.
--	Bot Scanner now loads the modified <code>cache.properties</code> file from the <code>conf</code> folder. Previously, you had to place the modified <code>cache.properties</code> file in the executable file location of the Bot Scanner for the file to be loaded.
00754003	Bots that contain the SOAP Web Service command now successfully run after migration without encountering any error. Previously, an unexpected error occurred when the SOAP Web Service with WSDLs defined with external dependencies were not invoked.
00790360	In the <b>Terminal Emulator</b> package, when you send any key to the terminal with the <b>Send text</b> or <b>Send key</b> action, if the terminal is in a busy state or the keyboard is in a locked state, these actions now wait for 5 seconds for the terminal to return to a normal state. After 5 seconds, the system moves to execute the next action without any exception.
00742000	Migrated bots that contain the <b>Prompt &gt; For value</b> command with the <b>Don't write in any windows</b> option selected now work as expected in Automation 360 after migration and no text is written in the file if any window is open. Previously, even if this option was selected, if any text file window was open, the text was written in the file.
00781072	When bots are migrated using the Bot Migration Wizard, migration no longer fails if the bot name includes a special character. Previously, an internal error occurred when the bot name included an apostrophe (') character.
00780713, 00778164	A migrated bot is no longer unresponsive when that bot uses the App Integration package to capture text from a target application and the target application becomes unresponsive.
--	Migrated Enterprise 11 bots that use the Terminal Emulator command to clear the terminal screen of the VT and ANSI type terminals no longer encounter an error when they are executed.

Fixes	
Service Cloud case ID	Description
00748647	Migrated Enterprise 11 bots that use two-dimensional array and the Variable Operation command no longer encounter an error. Previously, the migration process used to set the number of rows and columns for the two-dimensional array to 1x1 irrespective of the values set in Enterprise 11.
--	The migration process continues to migrate bots if the connection between the Control Room and the Bot Agent is lost and then reestablished. Previously, the migration process failed when the connection between the Control Room and the Bot Agent was lost.
00764441	In the <b>Excel: Get single cell</b> action of the <b>Excel advanced</b> package, you can now access the value of a specific cell defined in the cell address. Previously, migrated bots encountered a <b>Must match pattern</b> error when a Japanese character was entered in the <b>Cell address</b> field.
00757713, 00764985, 00820376	The <b>Excel advanced</b> package now enables you to read from a protected sheet. Previously, migrated bots encountered an error when you retrieved a cell from a protected sheet using the <b>Excel advanced: Open</b> action.
00761911	You can now migrate bots using the <b>Excel column</b> system variable where the key is the <b>column name</b> ; an error is no longer encountered.
00769321	Migrated bots no longer encounter an error when the <b>Run Excel Macro</b> command is included in the bots. Migrated bots now run properly using the <b>Run macro</b> action of the <b>Excel advanced</b> package.
00790858	You can now migrate a bot when there is a variable mismatch and the respective command is disabled. Previously, when the bot was assigned a certain variable type and the <b>Variable Operation</b> command in that variable was disabled, Bot Scanner displayed an error for the variable when the type was later changed.
00744318, 00744326, 00745318	You can now download an exported bot file with Japanese characters in the filename through email. Previously, when an exported file with a Japanese name was downloaded using the email link, an error occurred or the characters in the exported zip filename were garbled and <b>.zip</b> was appended to the filename.
00762975	After you migrate Enterprise 11 bots that use the <b>Error handling</b> command with the <b>Send email</b> function and the <b>Attach variable and Attach snapshot</b> option, the bots now correctly send error emails with attachments containing a snapshot or variable text file.

Fixes	
Service Cloud case ID	Description
00731577, 00746226, 00760649, 00759973, 00767618, 00789545, 00821824	The <code>includePackages</code> parameter of the Export API now works as expected. If you set the value of the parameter as <b>True</b> the packages are included in the exported file, and if the value is set to <b>False</b> the packages are not included in the exported file.
--	You can now migrate bots with variable names that include full-width and lowercase characters. Previously, migration of bots with a variable name that included full-width and uppercase characters was not supported because the variable was mistakenly converted to a half-width character.
00759189	Migrated bots now use the date format specified in the <code>AADefaultDateFormat</code> global value for email-related automation. You must create the <code>AADefaultDateFormat</code> global value before migrating the bots and specify the date format you want to use in the migrated bots.  Recommended: Specify the same date format in the <code>AADefaultDateFormat</code> global value that is used in Enterprise 11.
00784001	Enterprise 11 bots that are migrated now contain all the properties of an object captured from a SAP application.
00786362, 00802274	Enterprise 11 bots that are migrated no longer encounter an error when the child bot and parent bot use different versions of the If package.
00807986	Enterprise 11 bots that are migrated no longer encounter an error when a variable that is mapped between a child bot and the parent bot is not available in the child bot.
00808026	Enterprise 11 bots that are migrated no longer encounter an error when they use a shared session for Terminal Emulator related tasks when a session is shared between nested child bots and an intermediate child bot does not contain any Terminal Emulator actions.  For example, consider that you have three bots: Bot1, Bot2, and Bot3, where Bot1 calls Bot2 and Bot2 calls Bot3. Bot1 and Bot3 share a session for Terminal Emulator related tasks; however, Bot2 does not contain any actions from the Terminal Emulator package. When you share a session between Bot1 and Bot3, an error is no longer encountered.
00762368	Previously, when bots were migrated using Oracle database processes with passwords containing the symbol, an issue occurred. The issue is now fixed and passwords using the "@" symbol are now supported.
00768466, 00769099	An error no longer occurs when you migrate MetaBots that contain logic that are available within a folder.
00772885	The system now retrieves all rows in a table in a SAP application when the last page of the table contains a single row.



Fixes	
Service Cloud case ID	Description
00801733	An increase in CPU usage no longer occurs when the Control Room is in an idle state.
00774821	An error no longer occurs when you run migrated bots that contain a Loop action within another Loop action.
00786732	For Enterprise 11 bots that use the <b>Extract Table</b> command along with other commands within the Error Handling command and only the <b>Extract Table</b> command is disabled, only the equivalent action for the <b>Extract Table</b> command is disabled after migration. Previously, all the actions within the Error Handling action were disabled in the migrated bot.
00743892	An error no longer occurs when you run migrated bots that use DLLs that return a value of user-defined type. Such values are converted to the string type in the migrated bots.
--	Enterprise 11 bots that use variable operations to re-initialize an array type variable to contain more than 160,000 cells (for example, 400 rows and 400 columns, or 800 rows and 200 columns) no longer encounter an error when they are executed after migration.
00737025	Enterprise 11 bots that pass system variables such as Month, Year, and Day as an input variable to a MetaBot no longer encounter an issue after they are migrated.
00773407	Previously, historical activity reports exported to CSV did not display the <b>Last Modified</b> information correctly because some of the <b>Modified On</b> and <b>Modified By</b> information was not accurately processed. The error is now fixed and historical activity reports can now be correctly exported to CSV files.
00767597	The <b>Last Modified</b> (date) value displayed in the historical activity and bot page reporting was previously not translated correctly when the Control Room language was changed from English to non-English, and then back to English. This error is now fixed, and the data is preserved when the language is changed in the Control Room.
00762975	Japanese language text is now updated in the interface for recent user experience (UX) changes. Previously, there were some errors in the translated text in the interface, which are now fixed.
00763228, 00776154	Database constraints, such as foreign key constraint violations, previously prevented users from deleting bots after migration. This limitation is now fixed and users can delete migrated bots (.atmx files) without any issue.
00749375,00763262	After migration, if text file encoding was set to <b>UNICODE</b> or <b>UTF8</b> , you can now use the <b>String: Import string from text file</b> key to read values from the text file during bot runtime.

Fixes	
Service Cloud case ID	Description
00739268	You can now migrate bots that have large html data associated with the Object Cloning command without any issues.
00674147, 00682390	The <b>Stop service</b> action of the <b>Service</b> package now enables you to stop all child and dependent services of a selected window or application. Previously, the dependent service did not stop automatically when a user tried to stop any window or application service.
00754835	Temporary devices are now automatically deleted if the auto-delete option is enabled for device settings in the Control Room.
00751058, 00761099	When you use the Database Connect action for workload automation, work items from the second iteration are now executed for automation. Previously, only the first work item in the workload automation was executed.
00771098	After you edit a schedule from the <b>Scheduled activity</b> page and save the schedule, the correct page ( <b>Scheduled activity</b> ) is now opened instead of the <b>In progress activity</b> page.
00733614, 00741358	You can now use the <b>Extract image</b> action of the PDF package to convert a PDF file that contains JPX images to any other image format. Previously, the action failed to extract image from the PDF file because the JPX image reader was not supported.
00765851	Recorder actions now work properly and do not cause any delay when the <b>Set text</b> value contains brackets or [] (which enables you to run a migrated bot without delay). Previously, it took a longer time to run the bot when <b>Set text</b> contained [] (brackets).
00771197	In the <b>Open</b> action of the Browser package, the description below the <b>Time out after (seconds) (optional)</b> field is now translated correctly as <b>Min= 9 seconds</b> in the Japanese language. Previously, the description was translated as <b>Max= 9 seconds</b> .
00761395	In the Database package, when you connect with the Oracle Database and use the <b>Read from action</b> option in a loop to retrieve records from the database, the bot is now executed successfully. Previously, bot execution failed with an error.
00727530	The <b>Move all</b> action in the Email package now works properly and does not encounter any issue.
00739978	An error no longer occurs when you choose the <b>Manual input</b> option to open a VB Script file.
00728180	The issue with event triggers when creating folders in bulk is now resolved. If you configure an event trigger to start a bot whenever a folder is created and then create folders in bulk, the bot is now deployed for every folder that you create. Previously, the bot was not deployed for all the folders created.

Fixes	
Service Cloud case ID	Description
00711134, 00750164, 00847916	If you configure multiple triggers to start bots based on file events and if all the files reside in the same folder, the bots associated with all the triggers are now deployed. Previously, only some bots were deployed.
00719612	When you log in to the Control Room as an unattended Bot Runner, you can now execute bots using the <b>Run as self</b> option. Previously, an unattended Bot Runner could not run the bot with the <b>Run as self</b> option even when the device was set as the default device.
00745095	In the Database package, when you connect to the Microsoft Access database using the JDBC connection, the select query now extracts the file name for the Attachment data type. Previously, an error was displayed.
00772194	Data from any database type is now exported correctly in CSV format. Previously, if the data had special characters such as double quotation marks, the output was displayed in a new line.
00773961	When you create a new worksheet by name in the Google Sheets package, an error no longer occurs when you execute the bot.
00762029	An error no longer occurs when you execute a bot using the Google Calendar package. Previously, when the <b>Disconnect</b> action was used to terminate the connection, the email address attribute was stored in the session name instead of the user session name attribute. As a result, bot execution failed with an error.
00758333	If all versions of a particular package are disabled, then the package is no longer listed in the Actions palette of the Bot editor.  Previously, when a package was disabled, the Bot Creator still displayed it in the Actions palette and users were able to use the package when creating a bot. However, these bots failed on execution because the package was disabled.
00780221	A bot created using the <b>Run function</b> action in the Run DLL package now executes without any issues. Previously, an error was displayed on bot execution due to the unavailability of some embedded resources such as satellite assembly.
--	An error no longer occurs when you create a bot using the <b>Send text</b> action of the Terminal Emulator package and pass a variable with an empty value. Previously, the bot failed to execute when any variable options (Credential, Variable, Insecure String) that had no value was selected.

Fixes	
Service Cloud case ID	Description
00776430	When you connect to the Terminal type <b>TN3270E</b> in the Terminal Emulator package, select any of the <b>Terminal model</b> options from the list, and execute the bot, the correct screen resolution is now displayed. Previously, a wrong value was sent for each Terminal model and a screen with incorrect resolution was displayed.
00773415, 00781487	When you open a spreadsheet in the Google Sheets package and select the <b>Beginning of the row</b> option in the <b>Go to cell</b> action, the output is now displayed correctly. Previously, the output was displayed at the column level.
00773415, 00781493	An error no longer occurs when you open a new or blank spreadsheet in the Google Sheets package and you select an action such as <b>Go to cell</b> or <b>Set cell</b> to perform an operation. Previously, bot execution failed with an error.
00779561	In the System package, when you use the <b>Get environment variable</b> action in view mode, the environment variables are now always displayed in the list. Use the refresh option to retrieve all the environment variables in the list. Previously, the environment variables were sometimes not displayed in the list.
00775073	In the Excel advanced package <b>Get worksheet as data table &gt; Read</b> option, the description for the <b>Read cell value</b> option now reads correctly as 50% will be read as 50 when it is translated to the Japanese language. Previously, the description was translated as 50% will be read as 50%.
00767246	The SOAP Web Service package now works for URIs, where the service endpoint can be passed as a URI parameter. Previously, an error was displayed for such requests.
00734463, 00754570, 00766456	When the <b>Connect</b> action of the Database package is used to establish a connection with the Microsoft SQL Server using Windows authentication, the bot now executes successfully even when the parent and child bots use different versions of the Database package.  Previously, the bot failed if the parent and child bots used different versions of the Database package.
00780921	An error no longer occurs when you use the <b>PDF extract text</b> action to extract text from a PDF file. Previously, when structured text was extracted from a PDF file, an error was displayed because the index exceeded the 1000 range.
--	In the Excel advanced package, when you use the same session name to open multiple Excel spreadsheets, the bot now displays an error on execution. Previously, if the same session name was used in multiple spreadsheets, the bot overwrote the existing open session when the second <b>Open</b> action was executed.

Fixes	
Service Cloud case ID	Description
00785198	<p>In the Data Table package, when you now use the <b>Write to file</b> action to extract data from a table with large records, 1000 rows of data are read in batches and written to a CSV file.</p> <p>Previously, a Java heap space error was displayed because the configured Java heap memory ran out of space. As a result, data could not be retrieved from a table with large data and written to a CSV file.</p>
00757593	<p>In a Cloud deployment, child bots can now be migrated using the Migrate Bot action from the Bot Migration package. Previously, child bots were not migrated but a migration successful message was displayed.</p>
00731012, 00747385, 00746320	<p>If you install the Control Room in the default location in C : \ and configure the logs directory in another location (for example, E : \), WebCrx logs are now generated dynamically in the custom location.</p>
00768318, 00760835	<p>An error no longer occurs when you try to capture objects using AISense Recorder on any version of Windows that does not have the default media feature pack. Previously, the AISense Recorder did not highlight the objects on a page.</p>
00737710	<p>In the <b>Capture</b> action of the Recorder package, when you select the <b>Set Text</b> action and enter a string variable with a delay set for each keystroke, the output is now displayed correctly on a new line for all Microsoft applications. Previously, on bot execution, the output was shown on one line when a delay was set in the <b>Keystroke</b>.</p>
--	<p>If you deploy bots using event triggers and you install the Bot Agent on a device as a non-admin user for self or a local admin user, the Bot Agent is now updated automatically. The device is no longer shown as disconnected in the Control Room.</p>
00782596	<p>You can now migrate workload automation bots from Enterprise 11 to this release. A client protocol exception message is no longer displayed.</p>
00743810, 00785703	<p>You can now map variables with different letter cases between parent and child bots when you run bots after migrating them from Enterprise 11 to this release. For example, if the variable name in Enterprise 11 is var1 and the variable name is changed to var1 after migration, you can map the variables and continue to run the bots.</p>
--	<p>Bot deployments on Bot Agent devices no longer fail when you close a terminal window using the close Window action from the Window package or manually close the Terminal Emulator window.</p>

Fixes	
Service Cloud case ID	Description
00767587	You can now run bots from the <b>In progress activity</b> page. Previously, bots were stuck in the <b>Pending execution</b> state and as a result other bots did not run. You had to manually move the bots stuck in this state to the <b>Historical activity</b> page to run the other queued bots.
00789682, 00798933	You can now delete, reset, or place on hold workload automations because work items are no longer stuck in the ready to run status. Also, the following message is no longer displayed: <i>Work item cannot be deleted in this state.</i>
00720471	An error no longer occurs when you use the Recorder package to capture an object and perform the click action on the capture coordinates. Previously, when you captured the object properties and if the download bar in Google Chrome was open, object properties in the browser could not be captured.
00754651	In the <b>If</b> action of the If package, when you select any condition from the <b>Condition</b> list, and drag any other action inside the If action, the condition is no longer deleted from the <b>Condition</b> list and the action no longer disappears from the <b>List</b> and <b>Flow</b> view.
00768354	An error no longer occurs when you use the AISense Recorder in child bots when running them in a loop. Previously, when the AISense Recorder was used in a child bot and the bot was executed, external processes were not terminated, causing the system to run out of memory.
--	Previously, when bot migration was performed, the process sent various, occasionally multiple, email notifications to all existing Control Room users, even if the administrator had disabled email notifications. An option is now added to enable the administrator to disable email notifications when Credential Vault data is created during bot migration.
00762368	Previously, when bots were migrated using Oracle Database processes with passwords containing the "@" symbol, an issue occurred. The issue is now fixed and passwords using the "@" symbol are now supported.
--	Previously, during migration, a parent bot was successfully processed even if associated child bots did not exist. This created errors during runtime. In this release, if associated child bots do not exist for the parent bot, a message notifies the user of the required action before migration can continue.
00762975	Bots that used the Error Handling action to capture screenshots were incorrectly modified and appended as .PNG files. Migrated bots are no longer modified and appended in this manner.
00751496	Attended Bot Runner devices now show an improved time performance when running bots on Microsoft Edge browser.

Fixes	
Service Cloud case ID	Description
00753673	When you run a migrated bot that contains the <b>Excel Advanced &gt; Delete cell &gt; Specific cell</b> option with comma-separated input cell values such as <b>A1, B1</b> , the migrated bot now runs successfully and displays the output correctly.
00736473	Fixed an issue where a migrated bot containing the <b>Excel Advanced &gt; Open</b> action did not load the Excel add-ins even when the <b>Load Add-ins</b> check box was selected. Now, the Excel add-ins are loaded successfully.
00767917	You can now run bots with a queue on single user devices that were previously configured for multiple users.
00712719	An error no longer occurs when you run bots that contain actions from the Terminal Emulator package on your device. Previously, bots could not be run due to a synchronization issue with the terminal.
00753121	An error no longer occurs when you use the <b>Convert excel to PDF</b> action of the Excel advanced package to save a converted PDF to a shared network drive.
00763746, 00773924	When you select the <b>Keystrokes</b> action in the Simulate keystrokes package and enter a variable or static text containing half-width Japanese characters, the output now displays the correct Japanese characters. Previously, on bot execution, the output displayed incorrect characters.
00774872, 00807106, 00824486	When you use the <b>Close</b> action of the Browser package to close the last Chrome browser window, the last tab of a Chrome browser window, or all Chrome browsers, the bot no longer encounters an error. Previously, when the <b>Close</b> action was used to close the last Chrome browser window, the last tab of a Chrome browser window, or all Chrome browsers, bot execution failed because the Chrome communication channel was shut down.
00762178	When you deploy bots using RDP on unattended user devices configured for multiple users, a black screenshot is no longer captured.
00800573, 00796393, 00804854	When you select a run-as user to deploy a bot, you can add a Bot Runner user back from the list of Selected Bot Runners to the list of available Bot Runners on the <b>Run bot now</b> page.
00744929	When incorrect Git credentials are entered, the credentials are now hidden and not recorded in the <code>WebCR_Commons.log</code> file. Previously, incorrect Git login credentials were recorded and not hidden in the log file.
00751304	The error model in Swagger docs is now updated to display all the fields appearing in the API response body. Previously, there was a mismatch between the fields displayed in the API response body and the error model in Swagger docs.

Fixes	
Service Cloud case ID	Description
00763398	An error no longer occurs when multiple Excel files are opened and you use the <b>Run macro</b> action in the Excel advanced package. Previously, an error was displayed when a macro was run with multiple sessions.
00759183	The <b>Open</b> action of the File package now opens any file using the default application set by the user. For example, if Microsoft Paint is set as the default application for all .jpg files, the action now opens these files without any error. Previously, bot execution failed with an error.
00750185	An error no longer occurs when you run a migrated Enterprise 11 bot containing the Object Cloning command even if it contains some Unicode 8964 characters in some of its properties. The bot now captures objects after migration without any error. Previously, the bot failed to capture objects after migration if it contained Unicode characters in its properties.
00774091	All object properties of the Object Cloning command are now migrated without any errors. Previously, bot execution failed with an error because the HTML ID and HTML name properties were changed after migration.
00796322, 00823082	When you insert a variable as a parameter in any action of a package, add additional text to this variable, save the bot, and then edit the name of the variable from the variable list, the additional characters added to the variable are no longer deleted.
00731066	The <b>Capture</b> action in the Recorder package now works properly, and you no longer encounter any delay when creating and running new bots to extract any data from a DataGridView control in certain UI automation applications.
00784177	A bot deployment error is no longer displayed when you edit and run a bot using <b>Run bot now</b> from the Bot editor of a Cloud Control Room.
00782307, 00787807, 00811404, 00788178	Bot deployments are no longer stuck in a queue and now display the error <code>Picked at runtime</code> after Automation 360 On-Premises is updated from the previous release to this release.
00786786, 00806775	You can now capture a single object using a recorder from Google Chrome browser, and the following message is no longer displayed: <code>Error performing single capture</code> .
00780202, 00798826, 00808779	When you deploy bots using RDP on unattended user devices configured for multiple users and you set the RDP screen resolution to 1366x768, the resolution no longer changes to 1368x768 during bot execution.



Fixes	
Service Cloud case ID	Description
00769647, 00767674, 00773115, 00777239, 00778972, 00777752, 00792839, 00804603, 00806606, 00815687, 00829496	The <b>View historical activity</b> page now shows the correct run details of start date and time for bots that fail during execution.

Limitations	
<p>If you configure an external key vault in <b>External Key Vault Integration</b> and select the <b>SQL authentication</b> mode for database authentication in the Windows installer <b>Database Server</b> page to install Control Room (On-Premises), the installation fails, and the following error message is shown: <code>Control Room database tables fail to create</code>.</p> <p>Workaround: Add the database credentials in the external key vault and use those credentials for database configuration.</p>	
<p>The <b>Task bots runs</b> metric on the <b>Home</b> dashboard page of the Control Room displays the count as zero even if you have run bots from the same Control Room.</p>	
<p>(Service Cloud case ID: 00837271) If you are migrating from Enterprise 11 with a database that has a large amount of repository data, the installation might fail. This issue occurs because Liquibase update for a few SQL queries is not completed during migration.</p> <p>Workaround: Contact Automation Anywhere Support.</p>	
<p>When you are installing the Bot Agent, if you run out of disk space and click <b>OK</b> on the <b>Out of disk space</b> window, the Bot Agent installation wizard might display the previous installer windows.</p> <p>Workaround: In the <b>Setup type</b> window, click <b>Cancel</b> and relaunch the Bot Agent installation wizard.</p>	
<p>(Service Cloud Case ID: 01021889) In this release, when you schedule or deploy a bot from the Control Room, you will not receive an email notification if the bot fails to run.</p>	
<p>(Service Cloud Case ID: 00780635, 00791587, 00795559, 00795632, 00797130, 00797113, 00791783, 00765770, 00826805, 01859661) When you update from the previous release, schedules disappear from Control Room instances configured on a single-node or multi-node environment. In some cases, after the update, previously deactivated schedules disappear and are reactivated automatically.</p> <p>Workaround: Divide large schedules into smaller schedules or reduce the schedule frequency.</p> <ul style="list-style-type: none"> <li>• Divide large scheduled automations into smaller schedules of two hours each. For example, divide an automation schedule that runs for a 12-hour period, such as 9 AM to 9 PM daily, into two-hour intervals, such as 9 AM to 10:59 AM, 11:00 AM to 12:59 PM, and 1:00 PM to 2:59 PM.</li> <li>• Reduce the schedule frequency to 10 minutes.</li> </ul>	

Limitations
<p>Migration of Enterprise 10 MetaBots with the password type variable with null value is not yet supported. To migrate successfully, provide a default value to the password variable when creating MetaBots in Enterprise 10.</p>
<p>When you attempt to log in to the Control Room configured with Active Directory, using the <b>Log in with Windows</b> option is not currently supported in this release. Selecting this option can generate a <code>java.lang.NoSuchMethodError</code> error.</p> <p>Recommended: Enter the domain credentials directly.</p>
<p>(Service Cloud case ID: 00831886) As a Bot Creator, you cannot run bot tasks through the Automation Co-Pilot process. Although human tasks appear fine, the <b>Activity</b> page displays the <b>In Progress</b> state and seems stuck on the <b>Waiting for user and/or device</b> action.</p> <p>Workaround: Remove the <b>process discovery license - recorder</b> from the Automation Co-Pilot Bot Creator user. Please refer to <a href="#">AARI process discovery license assignment</a> for more information.</p>
<p>You cannot use the <b>Global session</b> option to share a Microsoft Excel session using the Excel advanced package with the Loop package.</p> <p>Alternate solution: Use the <b>Get multiple cells</b> action and save the data into a datatable variable. Then, use the Loop package with the <b>Data Table</b> option selected.</p>
<p>The migration process successfully migrates bots that contain brackets or [] but the process fails when you migrate the same bots again to migrate the delta changes even when the overwrite option is selected.</p> <p>Workaround: Delete existing bots from Automation 360 that contain brackets or [] before migrating them again.</p>
<p>Users with the <b>AAE_Bot Migration Admin</b> role are not able to run migrated bots because the <b>Run my bots</b> and <b>Create folders</b> permissions are not available in this role. As a result, these users can start the migration process, convert the bots but cannot run the migrated bots.</p> <p>Workaround: Create a custom role with the <b>Run my bots</b> and <b>Create folders</b> permissions and assign this role to the users with the <b>AAE_Bot Migration Admin</b> role.</p>
<p>When Enterprise 11 MetaBots that use a DLL that returns a two-dimensional array of type single as output and stores the value to a file using the Log To File command are migrated as Task Bots to Automation 360, these Task Bots encounter an error when they are executed.</p>
<p>Migrated bots that are used to automate tasks using RDP encounter an error when the DPI of the remote device is different from the current device.</p>
<p>Newly created Control Room users on Windows for On-Premises Google Cloud Platform VMs cannot change their password. The security questions option is not available on the <b>Change password</b> screen and as a result the Control Room displays an error when they try to save the password.</p> <p>Workaround: Refresh the page and change the password again.</p>

Limitations
<p>(Service Cloud case ID: 00770816) When you connect to an Exchange Web Services server, multi-factor authentication (MFA) must be disabled, including in all organizational level security policies where multi-factor authentication might be enabled. If multi-factor authentication is not disabled completely, users might encounter connection and or authorization errors.</p>
<p>Automation 360 does not support the Kibana version in Elasticsearch for which a privilege escalation error is shown in the Black Duck report.</p>
<p>The Bot Agent is not updated automatically from a previous release to this release when you perform different operations simultaneously such as running bots, configuring device settings in the Control Room, and updating the Control Room.</p> <p>Workaround: Restart the Bot Agent from the Task Manager.</p>
<p>A file is not deleted when you execute the bot with the following sequence of actions:</p> <ol style="list-style-type: none"> <li>1. You use the <b>CSV/TXT &gt; Open</b> action to open a <code>.csv</code> file.</li> <li>2. You use a loop action within another loop action to retrieve values from the <code>.csv</code> file.</li> <li>3. You use the <b>CSV/TXT &gt; Close</b> action to close the file. Here, all the actions are using the same Default session.</li> <li>4. You use the <b>File &gt; Delete</b> action to delete the file.</li> </ol> <p>The issue (file is not deleted) occurs because the bot fails to close the Default session.</p>
<p>Bot execution can fail with an error when you execute the bot with the following sequence of actions inside a loop:</p> <ol style="list-style-type: none"> <li>1. You use the <b>Browser &gt; Open</b> action to open a window.</li> <li>2. You use the <b>Recorder &gt; Capture</b> action to capture required objects on the window.</li> <li>3. You use the <b>Browser &gt; Close</b> action to close the window.</li> </ol> <p>Workaround: Use the <b>Window &gt; Close</b> action to close the window instead.</p>
<p>If you update the device information from the <b>Administration &gt; Settings &gt; Devices</b> page, only the first update is captured in the <b>Audit Log</b> page. Subsequent updates to the device are not captured.</p>
<p>When you register a new Bot Agent user device from the bot editor after creating and running a bot, the following message is intermittently displayed: <code>Device is either disconnected or it needs to be upgraded.</code></p> <p>Workaround: Click <b>Run</b> to deploy the bot on the new Bot Agent user device.</p>
<p>When you use the Universal Recorder to record multiple tabs in a SAP application, the <b>Set text</b> action in the Client control of SAP does not work because it is currently not supported.</p>
<p>When multiple users check in their bots simultaneously, some of the check-ins fail although Git is not corrupted and no data is lost.</p>

Limitations
<p>When you use the 2.3.0-20210806-215200 version of the Recorder package to capture any control using HTML technology in Google Chrome or Microsoft Edge Chromium browser and run the bot, the bot might fail with the following error message: <code>Unable to find control. Search Criteria did not match</code></p> <p>Workaround: Use the 2.2.0-20210722-211132 version of the Recorder package instead.</p>
<p>When you try to automate any process in a Java application that is using version 11.0.8 of AdoptOpenJDK, the Recorder might not be able to capture the drop-down elements on the application.</p>

## Automation Co-Pilot (Automation Co-Pilot for Business Users)

What's new
<p>Output variables support in Process Editor</p> <p>The <b>Output variables</b> section in the process editor enables you to create a user-defined variable that can be set as an output to any process. This helps you pass the output from the child (sub) process, which was called in the <b>Process Task</b>, to the parent (main) process.</p> <p><a href="#">Display child process automation output</a> on page 3490</p>
<p>Select File element input supported for Create a Request action</p> <p>The <b>Create a Request</b> action in the AARI Web package now supports passing input in the request creation forms for the <b>Select File</b> element. You can now use bots to create a request and upload or download files as input with the <b>Select File</b> element. These input files are uploaded to the storage service to be available for further processing in the request.</p>
<p>Detail view in Tasks page</p> <p>The new <b>Detail view</b> option in the <b>Tasks</b> page provides better insight into individual tasks for better task management. The detail view previews each task in its respective request view page without opening another page, which helps organize and correspond your tasks with the available requests. Users can interact with their tasks as well.</p>
<p>Additional support for interface triggers on Google Chrome</p> <p>You can use the following additional actions for interface triggers on the Google Chrome browser during bot runtime:</p> <ul style="list-style-type: none"> <li>• <b>Hyperlink</b> element: Click, <b>Set focus</b>, or <b>Lost focus</b> actions</li> <li>• <b>Checkbox</b> element: Select, cleared, <b>Set focus</b>, <b>Lost focus</b>, or <b>Selection changed</b> actions</li> <li>• <b>Radio Button</b> element: Select, deselect, <b>Set focus</b>, <b>Lost focus</b>, or <b>Selection changed</b> actions</li> </ul> <p><a href="#">Add an interface trigger</a> on page 2294</p>

What's changed
<p>Font size retained during bot runtime</p> <p>When you create a form, the font size that you selected in the <b>Formatting &gt; Font size</b> drop-down menu is retained on the form during bot runtime.</p>
<p>Cancel option in the process and team setup page</p> <p>When a user edits a process or team in the <b>Process setup</b> and <b>Process setup</b> pages, the <b>Cancel</b> option replaces the previous <b>X</b> option to provide better clarity for the user to cancel the current page.</p>

Fixes	
Service Cloud case ID	Description
00781358	You can now add bots with table variables that do not have a default value to a process without encountering any errors.
00791703	When you the use the desktop tray icon to open Automation Co-Pilot Desktop Assistant, dependent files are no longer displayed along with the application.
--	In the process editor, the <b>Go To</b> option now shows the <b>Filter Task</b> and <b>Process Task</b> options.
--	When you enter data in a form of your process that contains a hyperlink, the process data is no longer ignored and now works correctly.
--	When you use <b>Process Task</b> in the process editor, you can now use the <b>Public folder</b> option in the <b>Select process file</b> field.
--	In <b>Bot Task</b> and <b>Human Task</b> , when you select a box, the input is now accurately selected.
--	The <b>Requests</b> page is now correctly updated with the latest request events (such as completion of tasks) for users with an Attended license.
--	When you update to this release, a built-in scheduler now periodically checks for any disconnected or temporary devices and clears these entries.
--	When you open a form in the public folder, it cannot now be edited by changing the term View to Edit in the URL.
--	When a user logs in to Automation Co-Pilot Desktop Assistant, all the triggers associated with that user name are now available.

Limitations
<p>Users cannot edit a form or process in a public workspace, they must check out a form or process in order to edit in a private workspace. However, when users attempt to edit a form or process in a private workspace, they receive an <b>Access denied</b> error message due to the cache not being refreshed.</p> <p>Workaround: Navigate to the your private workspace, refresh the page to clear the cache, then edit your form or process.</p>
<p>An Automation Co-Pilot user with the <b>AAE_Robotic Interface User</b> license who is not apart of an assigned team can view all requests and tasks from other teams in the web interface. However, when the user attempts to access a request or task, they are prompted with an error message.</p>
<p>When a form is opened during bot runtime, the automated focus on the first form element is lost. For example, consider that Form A has various elements, and a <b>Text Box</b> element called Name is the first one. When Form A is opened during bot runtime, the focus is lost from the Name element and you cannot enter any values.</p> <p>Workaround: When a form is opened during bot runtime, click the form element to enter or change the value.</p>
<p>When you log in to the web interface as an administrator, for certain languages, the translated text on the left navigation pane is truncated (not displayed completely).</p> <p>Workaround: Hover over the menu item to view the tooltip, which displays the completely translated text.</p>
<p>In the Google Cloud Platform instance of the Automation Co-Pilot on the web interface, when you open a request that contains previously uploaded files, you might intermittently experience an error while downloading the files.</p> <p>Workaround: Retry downloading the file.</p>
<p>If a form has a table element and you use the <b>Set</b> action from the Interactive forms package during bot runtime, values are not applied to the table element.</p>
<p>If you selected the action trigger as <b>Changed value</b> for a <b>Dropdown</b> element within a trigger loop, any associated event is triggered during bot runtime even when there is a <b>Reset</b> action.</p>
<p>In an SDS setup, when you create a request to upload a file, the upload fails and a <code>SecurityTokenInvalidException</code> error message is displayed.</p>
<p>The <b>Override output variable</b> option in the <b>End Process</b> endpoint is not currently functional for users to override a variable definition.</p>

## Discovery Bot

What's new
<p><b>View Groups of steps</b></p> <p>When reviewing a process view, you can now use the group option or icon to display groups of steps that belong to the primary level action and secondary level action (and subgroup level actions) used during the recording session.</p> <p>Use the group icon to help you decide what groups of steps to select for a task you want to automate. For example, a primary level action displays Microsoft Outlook, a secondary level action displays Outlook mail notification, and subgroup level actions display terms such as Email -Add To, Email – Add Subject.</p> <p><a href="#">Create a process view with branches and opportunities</a></p>
<p><b>Use Dynamic option for system-generated views</b></p> <p>You can now use the <b>Dynamic</b> option from the Model options to view recordings where groups of steps display a set of repeating patterns that belong to the same application or same primary level action used during the recording session.</p> <p>Use this option to decide the context of the process or the task you want to automate. Groups of steps that are labeled belong to supported applications such as Microsoft (Excel, Outlook, and Notepad), Notepad++, text editors, most windows use cases, and Chrome browser functionality.</p> <p><a href="#">Create a process view with branches and opportunities</a></p>
<p><b>Enhancements to PDD Word document</b></p> <p>The PDD Word document now includes a process recording flow chart and the time on each individual step in hours, minutes, and seconds.</p> <p><a href="#">Review opportunities and convert to</a></p>

Fixes	
Service Cloud case ID	Description
--	The Control Room installer for Red Hat Enterprise Linux (version 7.7 or 7.9) now includes the Discovery Bot package. Previously, you had to log in to the Control Room as admin, select <b>Manage &gt; Package &gt; Upload</b> , and upload the Discovery Bot package.

Limitations
<p>In a Linux environment, when you record a process using the Discovery Bot recorder, the recorder window opens for 4 seconds and then disappears. The error occurs because the <code>ProcessDiscovery</code> folder is missing in the following directory: <code>/var/automationanywhere/enterprise/appdata/Server Files/</code>.</p> <p>Workaround: Perform the following steps to create an empty <code>ProcessDiscovery</code> folder manually and provide write access to the folder:</p> <ol style="list-style-type: none"> <li>1. Navigate to the following path in the Control Room directory: <ol style="list-style-type: none"> <li>a) If you have updated from an earlier version to v.22, navigate to <code>/opt/automationanywhere/enterprise/appdata/Server Files</code></li> <li>b) If you perform a new installation of v.22, navigate to <code>/opt/automationanywhere/automation360/appdata/Server Files</code></li> </ol> </li> <li>2. Run the <code>sudo mkdir ProcessDiscovery</code> command to create an empty folder for <code>ProcessDiscovery</code> in the specified Control Room directory.</li> <li>3. Run the following command to provide the required read and write permission for the newly created <code>ProcessDiscovery</code> folder: <ol style="list-style-type: none"> <li>a) <code>sudo chown -R crkernel:controlroom ProcessDiscovery/</code></li> <li>b) <code>sudo chmod -R 775 ProcessDiscovery/</code></li> </ol> </li> </ol>
<p>When you upgrade to A360 v.22, you might receive multiple email notifications about the PDD generated in A360 v.21.</p>
<p>When you add branches to the left and right sides of the main branch, the Recording flow chart section of the PDD might not capture the entire process work flow, including all the branches.</p>

## IQ Bot

What's new
<p>IQ Bot standard forms integration with IQ Bot Extraction</p> <p>You can now use the IQ Bot Extraction package for data extraction from standard forms documents.</p> <p><a href="#">Using IQ Bot Process documents action</a> on page 2757</p>
<p>Confidence threshold applicable on standard forms learning instance</p> <p>For a standard forms learning instance, if the <b>Confidence threshold</b> value that you have set does not match any field, the document is moved to the <b>Validator</b> and a notification icon is displayed. This update now enables you to validate the document for the learning instance and also save the document.</p>



What's new
<p>Additional OCR engines for IQ Bot Extraction package</p> <p>In addition to the existing OCR engines, IQ Bot Extraction package now supports the following OCR engines:</p> <ul style="list-style-type: none"><li>• Microsoft Azure 2.0</li><li>• Google Vision API</li></ul> <p><a href="#">IQ Bot Extraction package</a> on page 2749</p>
<p>Export IQ Bot dashboard data</p> <p>A user with the <b>AAE_IQ Bot Admin</b> role can now export the following data from the dashboard to a CSV file using the <b>Export</b> icon:</p> <ul style="list-style-type: none"><li>• Documents processed</li><li>• Pages uploaded</li><li>• Straight-Through Processing</li><li>• Accuracy</li></ul> <p>The CSV file is saved to the local Downloads folder.</p>
<p>IQ Bot support for self-signed certificates</p> <p>You can create a self-signed certificate with Subject Alternative Name (SAN) to use an SSL certificate for multiple domains.</p> <p><a href="#">Creating a self-signed certificate with Subject Alternative Name</a> on page 1453</p>
What's changed
<p>IQ Bot package supports external proxy server settings (Service Cloud case ID: 00727414, 00725235, 00757568, 00753560, 00753560, 00786609)</p> <p>The <b>Download all documents</b> and <b>Upload Document</b> actions in the IQ Bot package now support external proxy server settings.</p>
<p>IQ Bot Python library upgrade (Service Cloud case ID: 00756943, 00791511)</p> <p>IQ Bot now uses Python version 3.9.5 for data extraction.</p>

What's deprecated
<p>IQ Bot [Local Device] package</p> <p>The IQ Bot [Local Device] package is deprecated from this Automation 360 v.22 (Build 10526). Instead, use the IQ Bot Extraction package, which provides the same capabilities as the IQ Bot [Local Device] package, along with additional improvements.</p> <p><a href="#">IQ Bot [Local Device] package replaced by IQ Bot Extraction package (A-People login required)</a></p> <hr/> <p><b>Note:</b> Before using the IQ Bot Extraction package, update the bots associated with the IQ Bot [Local Device] package and restructure the output folders.</p> <hr/> <p><a href="#">IQ Bot Extraction package</a> on page 2749</p>

Fixes	
Service Cloud case ID	Description
--	If you delete a .csv file from the Success folder, you can now download the remaining files from that folder.
--	When you use the IQ Bot Extraction package for processing a large set of documents, you no longer encounter any document processing issues with Bot Agent.
--	If an incorrect value was used in the <code>providerVersion</code> field when you uploaded standard forms configurations to IQ Bot, an error notification is now displayed when you select this configuration when creating a standard forms learning instance.
00806805	You can now import a learning instance using the Migration Utility feature as the <code>Invalid Group</code> error message is now resolved.
--	When you creating a learning instance using standard forms, all the available pre-trained models are now listed in the <b>Select Model</b> drop-down menu.
00703856	IQ Bot now correctly extracts table rows with numeric values even when they are within parenthesis.
--	The File Download API now returns a correctly formatted JSON response with a colon (:) separating the key-value pairs.
00694656	IQ Bot now successfully extracts values from the documents that have new table fields added after training.
00636887	<p>An error notification is now displayed if you upload documents with file names longer than 150 Asian language characters in the staging environment.</p> <hr/> <p><b>Note:</b> This is not applicable to a production environment.</p> <hr/>
--	IQ Bot cloud data query is now optimized to prevent overloading of the Amazon Relational Database Service.

Fixes	
Service Cloud case ID	Description
00782994	When you use the Migration Utility to move a learning instance between environments, unclassified data is no longer exported.
00747137	You can now import learning instances using the Migration Utility feature without any issues.

Limitations
The value displayed in the <b>My totals &gt; Accuracy</b> field sometimes does not match the value in the <b>My learning instances &gt; Field accuracy</b> for the available learning instances.
If you try to import a learning instance into an IQ Bot environment that has a deleted learning instance with the same name, the following message is displayed even though the learning instance is not imported: <code>Import process initiated</code>
If you access IQ Bot without the correct permissions, they are redirected to an <b>Access denied</b> page, where the back button does not work.  Workaround: Close the current tab and open the Control Room.
When you select <b>Other domain</b> in the learning instance creation page, the tooltips for the table and form fields state that these fields are optional. However, these fields are required to create a learning instance.
IQ Bot installation sometimes fails and the following message is displayed: <code>Failed to upgrade the DB: -1</code> . When this issue occurs, retry the installation.
(Service Cloud case ID: 01016516, 00757943, 00787404, 00788421, 00807528, 00822941, 01018972) If you add multiple ABBY OCR based commands (such as IQ Bot Pre-processor, Document Classifier, AISense Recorder, OCR) in a single bot, an error message is displayed when you run the bot.  Workaround: Ensure that you do not add multiple commands in a single bot.
(Service Cloud case ID: 01063054) You cannot import a learning instance with a long name (>50 characters) because IQ Bot only supports up to 50 characters in the <b>Label</b> field.
If you use the <b>Process documents</b> action from IQ Bot Extraction package to upload documents, the validation rules from the default the validation group that you set are not applied. As a result, the failed documents are not classified into any of the existing groups and are moved to Validator.
In the IQ Bot Community Edition, when you use a Cloud OCR to create a learning instance, if you use the IQ Bot <b>Process document</b> action from the IQ Bot Extraction package, the values from the uploaded invoices or documents are not processed successfully.  Workaround: If you use the Cloud OCR to create a learning instance, use the IQ Bot <b>Upload Document</b> action from the IQ Bot package.

Limitations
<p>After you train a bot and click <b>Save and go to next group</b>, the system fails to load the next group. Instead, it reloads the same group.</p> <p>Workaround: Perform the following steps:</p> <ol style="list-style-type: none"> <li>1. Refresh the page.</li> <li>2. Navigate to <b>Learning Instances</b> and click <b>Bots</b> to edit the <b>Learning Instances</b>.</li> </ol>
<p>System identified regions are not generated when a non-English filename is uploaded using the Invoice domain and processed with the AutoExtract command.</p> <p>Workaround: To process the document, convert the non-English filename to English characters.</p>

## Bot Insight

Fixes	
Service Cloud case ID	Description
00788583	In the <b>Profile</b> tab, when you edit, save and generate a business dashboard and the dashboard is not saved, the error message description is now translated correctly in the Chinese language. Previously, if an error occurred when you saved the edits in the <b>Profile</b> tab of the <b>Business</b> dashboard, the error message description displayed garbled text.
00729920	When you migrate a task from a source (UAT) to a target (production) environment, a <b>Published</b> dashboard copy is no longer deleted from the source environment.
00742260	You can now export data from operational or custom dashboards after applying a non-metric variable in the filter. Previously, the data was not exported when you toggled between different chart types.
00738228	Multiple dashboards are no longer created for a Task Bot when you update and execute a bot that is checked out from the public workspace. Previously, when a bot was executed after an update, multiple dashboards were created.
00757992	A user with the Bot Creator license can now access all the Bot Insight dashboards (Operations and Business tabs) irrespective of their assigned role. Previously, if the user had the Bot Creator license with the <b>AARI Admin</b> role, they were not able to access these dashboards.

**Limitations**

(Service Cloud case ID: 00733555, 01912503) In a dashboard, the data labels in the pie chart overlap if it contains many slices. As a result, the labels in pie chart are not clear and shown only when you hover over the slices.

Workaround: To view the data labels in a pie chart in clear and readable format, export the dashboard data to Excel file.

**Note:** Due to a limitation within the third-party recharts library, you might observe labels overlapping issue with data in downloaded PDF as well.

**Important:** For information about the packages supported with this release, see [Packages available in Automation 360](#) on page 2316.

## Automation 360 v.21 Release Notes

Release date: 09 June 2021

Review what's new and changed, and the fixes and limitations in the Automation 360 v.21 release. Automation 360 (Cloud and On-Premises) is on Build 9664. Automation 360 IQ Bot Cloud is on Build 9664 and On-Premises is on Build 9642.

### Patch release updates

We have updated Automation 360 Build 9664 (Cloud and On-Premises) for the following fixes:

- Process deployments containing forms with empty table, check box, or text box are failing after the Automation Co-Pilot Cloud build is updated from the previous release to this current release (Service Cloud case ID 00788255).
- The layout of the request view page changes when another language other than English is selected (Service Cloud case ID 00772925).
- Warning messages in the process editors render garbled characters due to missing UTF-8 encoding (Service Cloud case ID 00781891, 00784947).
- Users (with the attended license) are not redirected to the Automation Co-Pilot Desktop Assistant application due to users (without the attended license) trying to connect to the Automation Co-Pilot Desktop Assistant application beforehand on the same device.
- Not able to capture keystroke actions on an application using the Universal recorder (Service Cloud case ID 00785310).
- Files were missing from the embedded resource folder, causing issues in using the Recorder package (Service Cloud case ID 00767315, 00777786, 00775209, 00788523, 00797261, 00795511, 00785246).
- Bot deployments are getting stuck in a queue after Automation 360 Cloud is updated from the previous release to this release (Service Cloud case ID 00784333, 00784890, 00784382, 00784338).
- Cloned bots are losing their dependency when they are checked-in (Service Cloud case ID 00780756).

- The recording duration was not updated correctly under **Process Cycle** on the process card, and the recorded steps were not captured by the recorder (Service Cloud case ID 00790884, 00781022).
- Migration
  - [11.x and 10.x](#) | [11.x only](#) | [10.x only](#)
- Automation Workspace
  - [What's new](#) | [What's changed](#) | [Fixes](#) | [Limitations](#)
- Automation Co-Pilot
  - [What's new](#) | [What's changed](#) | [Fixes](#) | [Limitations](#)
- Discovery Bot
  - [What's new](#) | [Fixes](#) | [Limitations](#)
- IQ Bot
  - [What's new](#) | [What's changed](#) | [Fixes](#) | [Limitations](#)

## Updating to this release

You can update the Automation 360 v.21 release from the previous three releases (that is, from n – 3 releases, where n refers to the latest release). The following previous releases are certified for update to this release:

- v.20 (Build 8815)
- v.19 (Builds 8147, 8145, 8122, 8098)
- v.18 (Build 7560)

You can directly update to v.21 from any of these builds. For details on how to update, see [Update Automation 360 to latest version](#) on page 1423.

---

**Note:** If you are not on an n–3 release, update Automation 360 to one of the three certified releases before updating to this release.

---

**Important:** This release includes a required update to your . Ensure that you complete the update to continue with your automation activities when upgrading from a previous release to this release.

[Automatically update the Bot Agent](#) on page 1361 | [Manually update the Bot Agent](#) on page 1362

---

To verify which version is compatible with this release, see [Compatibility with release builds](#) on page 1333.

Enhancements to browser extensions: The Automation 360 extensions for Google Chrome (version 1.2.0.0), Microsoft Edge (version 1.2.0.0), and Mozilla Firefox (version 1.2.0.2) now include the following enhancements:

- Support for HTML buttons and text actions in Interface trigger
- Enhancements to the default search criteria for text boxes and check boxes using Recorder package.
- Fixes for capturing objects with characters not valid in XML using the Recorder package.

- Fixes to the Discovery Bot recorder with default browser (Google Chrome) search page.

## Migration features

Enterprise 11 and Enterprise 10 features
<p>New system role to perform migration</p> <p>Assign the <b>AAE_Bot Migration Admin</b> system role to the user who will perform migration. This role contains all the permissions required to view and manage the bot migration process. Using this role eliminates the manual effort of creating custom roles, selecting the required permissions, and assigning them to the users who perform the migration.</p>
<p>Enhanced bot runtime window</p> <p>When you migrate bots using the Bot Migration Wizard, the bot runtime window now shows the name of the Enterprise 11 or Enterprise 10 bot file that is currently migrated.</p>
<p>You can now migrate bots with the <b>Open webpage in a new window</b> and <b>Open a webpage in an existing window</b> settings.</p>
<p>You can now migrate Enterprise 11 and Enterprise 10 bots with multiple versions of a DLL.</p>

Enterprise 11 only features
<p>MetaBot screens: Custom objects and play mode enhancements</p> <ul style="list-style-type: none"> <li>• Custom objects within the Image play mode are now fully supported.</li> <li>• Linked objects are now captured.</li> </ul>
<p>Enhanced Hide/Show option in Control Room</p> <p>For bots available in the Control Room (the <code>My bots</code> folder), a filter is available to hide or show older <code>.mbot</code> and <code>.atmx</code> files displayed in the window.</p>
<p>Global values for SAP</p> <p>The migration process creates the <code>JcoDllPath</code> and <code>JcoJarPath</code> global values of type string to support migration of SAP BAPI.</p>
<p>Enhanced Database action functionality</p> <p>The Database action now supports connecting to Oracle databases using <code>SID</code> and or <code>Service_name</code>. In previous releases, only connecting with <code>SID</code> was supported.</p>
<p>New email variable strings</p> <p>New email sent and received string variables are available for the Loop, Import DataSet, and Export Dataset actions to insert sent values for date and time.</p>
<p>Enhanced Microsoft Exchange Web Services support</p> <p>The Send function in the Email package supports EWS OAuth2.0, improving backward-compatibility.</p>

**Enterprise 11 only features**

Manually migrate from Enterprise 11 to Cloud-enabled environment

You can now manually migrate from Enterprise 11 to a Cloud-enabled environment. In this migration, you must create all the entities such as users, roles, and credentials manually, except bots. All Enterprise 11 versions are supported for this migration.

[Prepare for Enterprise 11 to Automation 360 Cloud-enabled migration](#) on page 1574

**Enterprise 10 only features**

Migrate MetaBots screen with Password type variable

You can now migrate Enterprise 10 bots based on the MetaBot screen, which uses the **Password** type variable. During the migration, the logic (.logic file) in the .mbot file is migrated as a new Task Bot within the MetaBot folder. Also, the **Password** type variable is migrated as a credential variable and is assigned to a predefined locker.

Migrate Task Bots based on MetaBot Screen and DLL assets without using Logic

You can now migrate a Task Bot that references the Run MetaBot action for the MetaBot Screen and DLL assets directly, without using the MetaBot Logic. So you can migrate a Task Bot that contains MetaBot Screen and DLL assets.

## Automation Workspace

**What's new**

Automation 360 navigation enhancements

We have enhanced the overall readability and accessibility of the Automation 360 interface. To make navigation easier, menus and views are organized based on frequently used features and related tasks.

The interface includes the following updates:

- The Device, Profile, and Help icons are now located at the bottom of the navigation menu, consolidating all controls on the left for easy access.

When you click these icons, flyout panels of content and actions are shown.

- The side navigation menu can be collapsed to a slim bar to maximize the main workspace area.

You can continue to use the side navigation in collapsed mode, with flyouts for each section.

[Automation 360 navigation updates](#)



What's new
<p>Authenticate database connection with Microsoft Azure Active Directory credentials (Service Cloud case ID 00676448)</p> <p>You can now authenticate the Control Room database connection using Microsoft Azure Active Directory credentials when you install the Control Room on Microsoft Azure.</p> <p><a href="#">Configure Microsoft database type and server</a> on page 1254</p>
<p>External Key Vault enhancements</p> <p>External Key Vault support for AWS Secrets Manager and CyberArk for Auto-login and Automation credentials has been added to Automation 360. Auto-login credentials and Automation credentials (credentials used by bots) can now be retrieved from the configured external key vault.</p> <p><a href="#">Integrate external key vaults</a> on page 1249</p>
<p>Deploy workload automation on a multi-user Windows terminal server</p> <p>To optimize workload automation and multi-user devices, you can deploy workload automations on a multi-user Windows terminal server so that a single device can process multiple work items concurrently.</p> <p><a href="#">About multi-user devices</a> on page 1876   <a href="#">About device pools</a> on page 1881</p>
<p>Control Room and Bot Agent compatibility checks for automation</p> <p>To manage the lifecycle of your automation, you can view dependency information about minimum compatible Control Room and Bot Agent versions when you create and deploy automations. You can then update your automation and reduce runtime errors caused by an incompatible Control Room or Bot Agent version.</p> <p><a href="#">Actions to build bots</a> on page 2363</p>
<p>New actions in the SAP BAPI package</p> <p>Use the following new actions:</p> <ul style="list-style-type: none"><li>• <b>Run standard workflow:</b> Runs a standard workflow in SAP BAPI.</li><li>• <b>Run custom workflow:</b> Runs a custom workflow in SAP BAPI.</li></ul> <p><a href="#">SAP BAPI package</a> on page 3003</p>
<p>New actions in File package</p> <p>Use the following new actions:</p> <ul style="list-style-type: none"><li>• <b>Get name:</b> Reads a file name and stores it to a string.</li><li>• <b>Get path:</b> Reads the path of the file and stores it to a string.</li></ul> <p><a href="#">File package</a> on page 2600</p>
<p>Common table expression supported in Database package</p> <p>You can now use common table expression (CTE) in the <b>Read from</b> action using the <code>WITH</code> keyword in SQL-compliant databases such as Oracle and MySQL. Use CTE statements within a SQL query to simplify complex joins and subqueries.</p> <p><a href="#">Using the Read from action</a> on page 2475</p>

What's new
<p>Support for large numbers in Number package (Service Cloud case ID:00557619)</p> <p>You can now perform mathematical operations for large numbers with more precision in the Number package.</p> <p><a href="#">Number package</a> on page 2802</p>
<p>Snowflake database support using ODBC driver (Service Cloud case ID:00761695)</p> <p>Snowflake ODBC driver is now supported in the Database package. You can connect to the Snowflake database using ODBC-based client applications.</p> <p>The following actions support this feature:</p> <ul style="list-style-type: none"> <li>• Connect</li> <li>• Disconnect</li> <li>• Read from</li> <li>• Export to data table</li> <li>• Insert/Update/Delete</li> </ul>
<p>Variables: new features and enhancements (Service Cloud Case ID:00740585)</p> <ul style="list-style-type: none"> <li>• Edit the variable name after the variable is created.</li> <li>• Delete all or a specific selection of unused variables from a bot.</li> </ul>
<p>Universal Recorder new features and enhancements</p> <ul style="list-style-type: none"> <li>• Record object interactions in applications built on the Electron framework.</li> <li>• Perform double-click in all supported applications and browsers.</li> </ul>
<p>Limit credential attribute use to password fields only (Service Cloud Case ID:00740585)</p> <p>When you create or edit a credential attribute, ensure that bots input the attribute value only in fields that are identified as password fields by selecting the <b>Set this attribute as a password</b> option.</p>
<p>Organize device pools to check for available devices in a preferred order</p> <p>If you select multiple device pools (either in the <b>Run now</b> or <b>Schedule</b> window), you can now arrange the device pools in the order of preference. When a bot is deployed, the Control Room selects the first available device based on the order in which you organized the device pools. If none of the devices are available at the time of deployment, the bot is queued.</p>
<p>Default names for output variables</p> <p>When you configure an output variable for the actions in the Error handler and Python Script packages, the Control Room automatically generates a descriptive default variable name. If you create more than one output variable for an action, the subsequent variable names are appended with a -1, -2, -3, and so on to avoid a variable name conflict.</p>

What's new
<p>New string action to support nested variables</p> <p>Use the <b>String &gt; Evaluate value</b> action to compare a user-specified string variable with the string variables in the bot. If a match is found, the action returns the value of the matching variable.</p> <p><a href="#">String package</a> on page 3086</p>
<p>Delete Global values</p> <p>A user with the <b>AAE_Admin</b> role can delete a global value from the <b>All global values</b> page.</p> <p><a href="#">Global values</a> on page 2350</p>
<p>High availability support</p> <p>For Cloud-enabled users, high availability is supported through three-node deployments.</p>
<p>String package enhancement</p> <p>A new option to support local numbering styles is now available in the String package. You can now select your local format, represented by ISO-3166.</p>
<p>Dependent files and package information in Export package audit details</p> <p>In the Audit details of an exported package, you can now view the list of dependent files and packages associated with the exported package. This feature enables you to analyze what the exported package contains and identify any discrepancies. If you chose to include packages during an export, then only the package information is included in the audit details.</p>
<p>ODBC driver support for all connection strings (Service Cloud Case ID: 00748887, 00777676)</p> <p>An Open Database Connectivity (ODBC) driver is now available to support all the ODBC connection strings in the same way it was used in the Enterprise 11 version. Using SQL as a standard for accessing and managing data, you can connect to MySQL, Google BigQuery, Snowflake, and other databases using the ODBC driver.</p>
<p>Share a DLL session</p> <p>You can now share a DLL session between bots.</p>
<p>New CredentialAllowPassword annotation</p> <p>Use the new <b>CredentialAllowPassword</b> annotation in the package SDK to allow the selection of a credential attribute marked as a password. You can use this annotation when creating a new SDK package or when modifying an existing one.</p> <p><a href="#">Configure and use credential allow password annotation</a> on page 3568</p>

**What's new**

Enhancements to check-in, check-out, and cloning permissions (Service Cloud Case ID: 00645904, 00720237, 00752197, 00760306, 00764684)

- When performing a check-in, you can now choose the dependencies to check in along with the bot. Directly referenced dependencies will be automatically checked in with the bot.
- When a bot is checked in along with a cloned bot and there are no other bots dependent on the clone, the cloned bot is now deleted.
- When performing a check-out, you can now choose the dependencies you want to check out with the bot. The dependencies that are not selected during the check-out are now cloned.
- During check-out, you can now overwrite or replace a cloned bot.

Bot Agent installer includes shortcut for Automation Co-Pilot Desktop Assistant

A shortcut to access Automation Co-Pilot Desktop Assistant easily is added on the desktop and Windows menu when you install a Bot Agent.

[Install Bot Agent and register device](#) on page 1347

**What's changed**

Bot Scanner shows invalid bots in "cannot be migrated" list

The Bot Scanner is updated to show invalid bots as blocked from migration because these invalid bots were failing before and after migration. For example, Enterprise 11 or Enterprise 10 bots that referenced non-existent variables failed. So some bots will no longer be shown in the can be migrated list of bots but will instead be shown in the cannot be migrated list in the output report. This can decrease the number of bots that can be migrated to Automation 360.

Change in names of file locations and folders

File locations and folder names are now updated for the change in product name (from Enterprise A2019 to Automation 360). For example, the file location for the default installation path is changed from C:\Program Files\Automation Anywhere\Enterprise\ to C:\Program Files\Automation Anywhere\Automation360. We will be updating these locations and names on our documentation pages soon.

Source string is optional in Split action (Service Cloud case ID: 000687257, 00702258)

In bots (including bots migrated from Enterprise 11), when you use the **Split** action in the String package, the **Source string** field is now optional. You can run the bot without providing a source string value. Migrated bots that contain empty input strings now execute successfully.

What's changed
<p><b>Mandatory prerequisites validation before migrating bot</b></p> <p>When you migrate bots using the <b>Migrate bots</b> option in the Bot Migration Wizard, a prerequisite validation message appears with a checklist of all the validation items. The system now validates these prerequisites automatically to ensure that all prerequisites are met before you start the bot migration. Previously, validating prerequisites was optional.</p> <p>If the prerequisite validations are completed with a failure, a validation report appears with the list of items for which validation failed. If the prerequisite validations are completed without any failure, the bot migration is started.</p>
<p><b>Change in default Control Room database name</b></p> <p>The default Control Room database name is now changed from AAE-Database to Automation360-Database.</p> <p>If you are updating from an earlier release to this release, enter your existing Control Room database name to preserve your data.</p>
<p><b>Microsoft SQL Server clustering for high availability</b></p> <p>You can now use Microsoft SQL Server clustering for automatic and graceful failover of high availability deployments in Control Room clusters.</p> <p><a href="#">Database requirements</a> on page 1188</p>
<p><b>Bot Agent nickname is hidden</b></p> <p>The nickname of a Bot Agent (added during installation) is now hidden when you switch the registration of a user device from one Control Room instance to another.</p>
<p><b>User interface change in the Open action of Excel packages</b></p> <p>In the Excel basic and Excel advanced packages, the <b>Sheet contains header</b> check box now appears below the <b>Select file</b> field.</p>
<p><b>User interface change in the Variables palette</b></p> <ul style="list-style-type: none"> <li>• The <b>User-defined</b> variables list is now named <b>Your variables</b></li> <li>• System, String, and Clipboard variables are organized within <b>Predefined variables</b></li> </ul>
<p><b>Digits with comma considered a valid number (Service Cloud case ID: 00623458)</b></p> <p>In migrated bots, a set of digits that uses a comma is now considered a valid number. This change enables you to successfully verify mathematical operations and If, Elseif, and Loop variable conditions containing various operators.</p>
<p><b>Date comparison works with dates in different formats (Service Cloud case ID: 00723479)</b></p> <p>Date condition actions are now successfully migrated to the equivalent date conditions in On-Premises. The date condition now works with multiple subformats of the main format (MM/dd/yyyy). Therefore, you do not have to manually change the date format per the source format of the migrated bots that contain date strings.</p>
<p><b>Use string value with numeric operators</b></p> <p>Migrated bots that contain If or While actions that use string values or a variable containing a string value with &lt;, &lt;=, &gt;, and &gt;= numeric operators now run successfully.</p>

What's changed
<p>Enhancement to Extract field action in PDF package</p> <p>Use the <b>PDF viewer</b> in the <b>Extract field</b> action to extract all the form field data and selected text, and store the form data to variables.</p> <p><a href="#">Using the Extract field action</a> on page 2881</p>
<p>Connect automatically to SQL server for Windows authentication (Service Cloud case ID: 00691554)</p> <p>When you update the Bot Agent, you no longer have to add d11 files manually to connect to the Microsoft SQL Server using Windows authentication.</p> <p>Previously, users had to manually add d11 files to configure devices and use the Connect action from the Database package to connect to the Microsoft SQL Server with Windows NT authentication.</p>
<p>Enhancement to Active Directory mapping</p> <p>You can now create AD groups using commas in the naming on the AD server side and the Control Room side. Previously, this caused an error.</p>
<p>Enhancement to the Split action of String package</p> <p>Migrated bots now run successfully when the <b>Split</b> action is used to split a string available in an input variable and that variable is empty.</p>

The following table lists the fixes and the builds in which they were fixed. Build 9664 is the latest build for Cloud and includes fixes from the previous builds. On-Premises is on Build 9664.

Fixes		
Build	Service Cloud case ID	Description
9664	00803314	<p>The following issues are fixed in the latest version of the Cloud Migration Utility:</p> <ul style="list-style-type: none"> <li>The utility checks the current version of your Enterprise 11 Control Room and proceeds only if that version is supported for migration to Automation 360.</li> <li>The utility displays the target tenant information on the successful validation screen when you navigate to the migration code screen.</li> <li>An error is no longer encountered when access is provided to: <code>https://aws.amazon.com</code> and <code>https://aa-provsvc.globalservices.automationanywhere.</code></li> <li>The utility uploads all the required data to Automation 360 Cloud.</li> </ul>

Fixes		
Build	Service Cloud case ID	Description
9664	00790884, 00781022	The recording duration for a process is now correctly displayed under <b>Process Cycle</b> on the process card. Previously, you were not able to view the recording duration because of a delay in the network connectivity. You can now view all recorded steps captured by the recorder from the <b>Recordings</b> page.
9664	00785310	You no longer encounter any issue when you use Universal Recorder to record keyboard actions on an application. The Universal Recorder now captures the value of keystrokes properly. Previously, the Universal Recorder captured only the first value of the keystroke.
9664	00767315, 00777786, 00775209, 00787736, 00797261, 00795511, 00796245, 007956217, 00798533, 00795084	<p>You no longer face issues because of global cache expiry and partially deleted files in the embedded-resources folder (C:\ProgramData\AutomationAnywhere\GlobalCache\embedded-resources) when you install a Bot Agent for this release and capture objects in Google Chrome using the Recorder package.</p> <p>Note that, if the Bot Agent device has embedded resources folder partially deleted, you must first delete the global cache and update the Bot Agent.</p>
9664	00796598	When you run workload bots with queue on Bot Runner devices, the bots do not fail intermittently after Automation 360 Cloud is updated from the previous release to this release.
9642	--	Control Room instances configured with Active Directory for authentication with the retrieval of credentials from an external key vault were unsuccessful due to incorrectly prepending domain names in object names (CyberArk) and secret names (AWS) and caused authentication to fail. This issue is now fixed and object names (CyberArk) and secret names (AWS) are now properly formatted.

Fixes		
Build	Service Cloud case ID	Description
9637	00784333, 00784890, 00784382, 00784338, 00780635, 00791587, 00795559, 00795632, 00797130, 00797113, 00791783	Bot deployments are no longer stuck in a queue after Automation 360 Cloud is updated from the previous release to this release.
9637	00780756	You can now check in bots that have a shared dependency with other bots successfully. Previously, check-in failed because of an issue with the cloned bots losing the dependency during check-in, irrespective of their existing parent bots.
9595	00733638, 00756399	Bots that use a variable to specify the child bot to run no longer encounter an error because the variablized path contains a backslash.
9595	00711390	The retry mechanism now enables you to migrate large .atmx files. Previously, when a large .atmx file was migrated, the connection with the Control Room became stale or unauthenticated, resulting in a <code>NoHttpResponseException</code> error. With the retry mechanism, the Migration utility attempts to build a connection with the Control Room 5 times until the connection is successfully rebuilt.
9595	00730369, 00747866	Recorder actions now work properly, which enable you to run the migrated bot without any delay. Previously, it took a longer time to run the bot due to a long delay.
9595	00733383, 00754559	The Loop counter variable now works properly for migrated bots. The variable is now migrated as part of the <b>XML</b> and the <b>Data Table</b> commands.
9595	--	When updating the SQL queries on a migrated bot using the <b>Read from</b> and the <b>Insert/Update/Delete</b> actions of the Database package, the existing format of the query is no longer automatically modified. Previously, when editing the SQL queries on a migrated bot, the characters were being misplaced.



Fixes		
Build	Service Cloud case ID	Description
9595	00721238	You can now use the <b>Browser</b> action to access a URL with parameters using the Microsoft Edge browser. Previously, when a URL with parameters through the <b>Browser</b> action was accessed using Microsoft Edge, the URL parameters were truncated from the & (ampersand) character after the bot was run.
9595	00721488	Enterprise 11 bots that use the <b>Get multiple nodes</b> command no longer provide a different output after migration. Previously, the migrated bot returned output per the structure of the XML file, while the Enterprise 11 bot provided output in a single line.
9595	--	You no longer encounter an issue when you run bots migrated from Enterprise 11 that use identical names for variables differentiated by a hyphen or an underscore (for example, L-Lower and L_Lower). The variable name that contains a hyphen is now appended with some keywords (for example, variable Arr-val is updated to Arr-val-MIG-SPL-25). Previously, bots failed to execute after migration.
9595	00729931	After migration, when the bot file is generated, the correct DOMXPath is now migrated. Previously, an incorrect DOMXPath was migrated.
9595	00738643	The If and Loop conditions when used in a combination of multiple <b>AND</b> or <b>OR</b> conditions now works properly. Previously, using the If and the Loop conditions with multiple conditions resulted in a bot logic error.
9595	00743808, 00754554	Migrated bots that use the If command with a variable in the HH:MM format now work properly and no longer encounter any issue.

Fixes		
Build	Service Cloud case ID	Description
9595	00678059	You can now download exported packages if the bot name contains Japanese characters and an underscore (_). Previously, if the name contained such characters, an unexpected error occurred that restricted the user from downloading the package.
9595	--	When you run a migrated bot that contains the <b>Excel Advanced &gt; Find</b> action, the found cell is now active and subsequent actions can perform operations on that active cell.
9595	00731512	You can no longer edit a bot and change the bot repository file path from the public to private folder by updating the Control Room URL and repository path in the browser.
9595	00734059	INFO type messages are no longer duplicated in the Control Room <b>WebCR.1og</b> file.
9595	--	When you install a Bot Agent at the user level, the user device is now registered as admin.
9595	00744663, 00747831, 00737488, 00752613	You can now successfully export a bot that contains the Recorder package.
9595	00726433	Fixed an issue with Microsoft Graph APIs that caused errors when a bot downloaded files from OneDrive. Bots can now successfully run the <b>Office 365 OneDrive &gt; Download file</b> action.
9595	00703553	When a new user is created, the Audit API now returns the correct values for the eventDescription and userName parameters.
9595	00729563	The <b>atmx</b> file extension is no longer case-sensitive. You can now migrate tasks that include uppercase or lowercase letters in their file extensions. Previously, tasks with uppercase letters in their file extensions were not migrated by the Bot Migration Wizard.

Fixes		
Build	Service Cloud case ID	Description
9595	00740548	Bot status is now correctly displayed after a process is executed. Previously, scheduled bots were occasionally mislabeled as <code>In progress activity</code> even though the bot had completed the process.
9595	00731508	You can now enter Nordic characters in the credential attribute and credential variable values.
9595	00695176, 00692676	Newly copied bots containing an event trigger now run when the triggering event occurs.
9595	00759742	When you insert a variable in a text string, the variable is now inserted at the cursor position. Previously, the variable was inserted at the end of the string and not at the cursor position.
9595	--	You can now successfully deploy bots from the Bot editor. Previously, when the Bot Creator or Bot Runner (attended or unattended) user logged in to the Control Room and if the package download option was enabled, the package download took priority and bot deployment had to wait until the package download was completed.
9595	00730211	When you use the Recorder package > <b>Get property</b> action to extract the path property of the object, the recorder now retrieves the value of the height and path attributes of the captured object. Previously, the height and path attributes of the recorded object were not retrieved by the bot.
9595	00716793	An issue is no longer encountered when you execute a bot using the SOAP Web Service package with unformatted input parameters. Previously, bot execution failed with an error because the unformatted input parameters were not formatted in XML format by the bot.

Fixes		
Build	Service Cloud case ID	Description
9595	00706709	In the Email package, when you use the Outlook connection to retrieve emails with the date filter, all emails are now retrieved correctly. Previously, all the emails were not retrieved from the application when the date filter was applied.
9595	00714292	To support double backslashes (\\) in the file location for actions that use file input, you must now set the <b>Bot compatibility version</b> as 2 in the <b>Advanced settings</b> page of the Bot editor. Previously, the bot execution failed because the double backslash (\\) in the file location was replaced with a forward slash when you select a network path using <b>Browse</b> option.
9595	00697460	When you select the recorder in the If condition, the recorder now locates the object in the Oracle EBS application and captures the correct object properties without any error. Previously, the recorder failed to find the object when captured in the If condition.
9595	--	In Microsoft Edge or Firefox, when a bot opens a website inside a loop, the Recorder <b>Capture</b> action now works properly after the launch website operation is executed. Previously, the action failed after launch website was executed.
9595	00710257	In the Recorder package, the <b>Capture</b> action now works without encountering any issues. Previously, the Recorder failed with a timeout error because the network proxy details were not retrieved.
9595	00735480	A Task Bot now performs better when you use the <b>Loop</b> action to execute a bot. Previously, the Task Bot took a long time to complete execution.

Fixes		
Build	Service Cloud case ID	Description
9595	00559868	When you use Datetime package > <b>Assign</b> action to convert a DateTime variable using the custom format dd-MMM-yyyy, the bot now executes without any errors. Previously, the bot execution failed due to case-sensitive characters in the DateTime format.
9595	--	Migration of PaaS database (Azure SQL) connection strings by using an ODBC driver is now supported.
9595	00733651	You can now view the average time spent to create a Task Bot metric in the Control Room on different pages when you click a page number.
9595	00742305	When you turn off one node on a three-node cluster and log in to the Control Room, the following error is no longer displayed: <code>Cluster group is empty</code> .
9595	00712190, 00698197, 00700574	When you deploy a bot with string values that exceed the allowed limit of 2 - 4 MB, the Control Room recognizes it as an exception and now shows the following error message: <code>400 Bad Request</code> .
9595	00754585, 00755448	When you run a bot, dependencies including the child bots are now downloaded. The bot no longer shows an unknown status and session as expired.
9595	--	When you now migrate the Database command, no additional configuration is required.
9595	00745046	You can now check in your bots without encountering any issues. Previously, bot check-in failed because the Git repository was corrupted intermittently.
9595	00677638	When you add a user device as the default device in the Control Room, the <b>Devices</b> page now automatically displays it as the default device. You no longer have to re-log in to the Control Room or refresh the Control Room page.

Fixes		
Build	Service Cloud case ID	Description
9595	00733370	Users signed in to temporary (non-persistent) shared devices can now sign in to the Control Room after a previous session on the temporary device is deleted by the Control Room administrator.
9595	00736950	MetaBots using Japanese characters (double-byte string) as the output variable can now be successfully saved and executed after the MetaBots are migrated to On-Premises using the migration wizard.
9595	00723924	The Terminal Emulator type ANSI now accepts a password that contains braces or {}. Previously, when braces were used in the password, an invalid username and password error message was shown in the terminal screen.

Limitations
<p>(Service Cloud Case ID: 00797199) If multiple instances of Bot Agent in Google Chrome browser are displayed and multiple Google profiles (accounts) are open in the browsers, you might not be able to use the <b>Recorder &gt; Capture</b> command. You might see an error message that informs you that the Google Chrome plug-in not installed.</p> <p>Workaround: Automation 360 supports only a single profile for automation. Therefore, we recommend that you either configure a single Google profile in Google Chrome or, if you are using multiple profiles simultaneously in Google Chrome and want to automate one profile, enable the <a href="#">Automation 360 extension for Chrome</a> on only one of the Google profiles.</p>
<p>(Service Cloud Case ID: 01071731) When you open a CSV or TXT file, read data from that file, and write the data from a Table type variable to the file, the bot fails with an error if the CSV or TXT file contains large data sets. Also, <b>Create folders/files if it doesn't exist</b> and <b>Override existing file</b> check boxes are selected in the <b>Write to file</b> action.</p> <p>Workaround: Perform one of the following:</p> <ul style="list-style-type: none"> <li>• In the task, when you use the <b>Open</b> action for a CSV or TXT file, select the <b>Contains header</b> check box to prevent your bot from failing.</li> <li>• Use the Excel advanced <b>Open</b> action to open a CSV file and then use the <b>Write from data table</b> action to write data into the file.</li> </ul>

Limitations
<p>(Service Cloud case ID: 00793818) If you edit a large number of schedules simultaneously (for example, more than 40) in the Control Room from the <b>Scheduled activity</b> page, the schedules will not be activated.</p> <p>Recommendation: Use the edit option for each schedule to avoid overwhelming the scheduler.</p>
<p>(Service Cloud case ID: 00805571) When the Bot Agent is automatically updated for Cloud deployments, the status of the Bot Agent flickers (changes) between <b>Connected</b> and <b>Updating</b> on the <b>Devices</b> page. The Bot Agent logs indicate that the auto-update process is initiated, but the device does not connect to the WebSocket server.</p> <p>Workaround: Delete the local database file <code>AA-DB.mv.db</code> from <code>C:\Windows\System32\config\systemprofile\AppData\Local\AutomationAnywhere</code> and restart the Bot Agent service. If auto-update is enabled in the Control Room settings, the Bot Agent will be updated automatically. Note that if the setting is disabled, you have to update the Bot Agent manually.</p>
<p>If a device or Bot Agent service restarts when you are running bots, the bots are shown as <b>Active</b> in the <b>Activity</b> page instead of <b>Failed</b> because of response schema changes in the product.</p> <p>Workaround: Delete the <code>AA-DB.mv.db</code> file from <code>C:\Windows\System32\config\systemprofile\AppData\Local\AutomationAnywhere</code> and restart the Bot Agent service. The deployments stuck in <b>Active</b> state will be moved to the <b>Historical</b> page and will be marked as <b>Failed</b> so that subsequent deployments can continue to run.</p>
<p>Intermittent issues occur with the execution of scheduled bots where some existing schedules behave inconsistently or some newly created schedules disappear. The new feature to set the priority to <b>High</b> has been reverted to address this occurrence. For users who have used this feature in Build 9637 or earlier and have updated to Build 9664, the schedules work without the relevance of the priority setting.</p> <p>Workaround: If you encounter these issues, split large scheduled automation to smaller schedules of 2 hours each to run throughout the day. For example, reconfigure an automation that is scheduled for a 12-hour period such as 9 AM to 9 PM daily to two-hour intervals such as 9 AM to 10:59 AM, 11:00 AM to 12:59 PM, and 1:00 PM to 2:59 PM. We strongly recommend that you use 2-hour intervals in such deployments. Further recommendations for schedules and time intervals: any schedules with a lower time frequency (&lt; 10 minutes) should be spaced out to at least 10 minutes (Service Cloud case ID 00792385, 00785679, 00795915, 00793147, 00794555).</p>
<p>Known behavior for configured ports on multiple instances</p> <p>When you install the Control Room and configure the database, the ports for multiple instances should match the TCP ports configured in TCP/IP properties. For example, for the first instance if the configured TCP port is 1434 and for the second instance the configured TCP port is 1435, ensure you add 1434 as the port for the first instance and 1435 as the port for the second instance during Control Room installation.</p>

Limitations
<p>The Universal Recorder has the following limitations when capturing objects in Electron apps:</p> <ul style="list-style-type: none"> <li>The <b>Check</b> action in a check box is not currently supported. Workaround: Use <b>Toggle</b>, <b>Click</b>, or <b>Left click</b> instead.</li> <li>The Universal Recorder cannot capture tabular data. Workaround: When the Universal Recorder captures an object control of <code>Client</code>, select the <b>GetAllChildrenNames</b> action and store the data to a list variable.</li> <li>The Universal Recorder might capture the window containing Microsoft Teams as a Client technology, instead of the intended object. Workaround: Close and reopen Microsoft Teams.</li> <li>The Universal Recorder only supports object capture from Electron apps in a computer that has the display scale configured to 100% or has a DPI awareness setting.</li> </ul>
<p>If the maximum number of allowed activeMQ connections is exceeded, an AMQ failure can occur when running a RunTask automation that is looped 5 times, with each loop running 20+ bots after the fourth loop.</p>
<p>External key vault</p> <p>The Create/Edit User configure options still include the field permitting the administrator to enter the device credentials for the user. When auto-login is configured for the external key vault, these fields are still viewable and appear editable; however, the credentials added have no effect on the auto-login credential retrieval from the external vault.</p>
<p>You might observe an increase in CPU usage by about 10 percentage when the Control Room is in an idle state (Service Cloud case ID 00801733).</p>
<p>When you update the Control Room on Linux from Automation 360 v.19 or v.20 to Automation 360 v.21, the Control Room continues to display the interface from the previous version.</p> <p>Workaround: Refresh the browser to load the user interface in the new version.</p>

## Automation Co-Pilot for Business Users (Automation Co-Pilot)

What's new
<p>Automation Co-Pilot Desktop Assistant for attended Bot Runners</p> <p>The Automation Co-Pilot Desktop Assistant application enables users with the attended Bot Runner license to access their bots without logging in to the Control Room. Automation Co-Pilot web users can use the Automation Co-Pilot Desktop Assistant when the attended Bot Runner license is enabled along with their Automation Co-Pilot User license without impacting their existing functionality.</p> <p><a href="#">Automation Co-Pilot Desktop Assistant</a> on page 3361</p>



What's new
<p>Download, delete, or view files in browser in initial forms or tasks</p> <p>Users can now use the <b>Select File</b> element to download files that are uploaded to the initial forms or tasks, and they can also delete files or access the hyperlink file to view the file in within the browser. The uploaded file can be accessed as a hyperlink, and new icons are available for download and delete.</p>
<p>Enhancement to team roles</p> <p>The Automation Co-Pilot team consists of three roles:</p> <ul style="list-style-type: none"> <li>• Member: Can create, view, and delete their own requests. All the tasks are automatically assigned to the member when they create the request in a private team. In a shared team, the member can assign tasks to other members.</li> <li>• Owner: Can create, view, delete, and assign all the requests from the members in the team.</li> <li>• Admin: Can create, view delete, and assign all the requests from the members in the team. The admin can also modify the team.</li> </ul> <p>An Automation Co-Pilot admin or manager can edit their teams and update their team members' roles. They also have the option to add or remove team members. The Automation Co-Pilot manager is the team admin by default when they create a team.</p>
<p>Enhancement to creating requests</p> <p>A request can now be created either by a user or by a bot in the <b>Edit Process</b> page.</p> <ul style="list-style-type: none"> <li>• Choose the <b>by user</b> option to view the process in the <b>Processes</b> page.</li> <li>• Choose the <b>by bot</b> option so that the request is created either by a bot or by another process using the <b>Process Task</b>.</li> </ul> <p>You cannot view the process or create a request with this option. Because the request is created from within a team, specify the default team in the <b>Default team to take the bot created request</b> field in the <b>Edit Process</b> page.</p> <p><a href="#">Assign a team to a process</a> on page 3389</p>
<p>Assign to me feature in tasks</p> <p>When a task is unassigned and users access the tasks, use the <b>Assign to me</b> option to allow the tasks to be assigned to the current user so that they can immediately access the form.</p> <p><a href="#">Assign or unassign a task</a> on page 3390</p>
<p>New Bot page</p> <p>When Automation Co-Pilot team members with attended Bot Runner licenses access the web interface, they are automatically redirected to Automation Co-Pilot Desktop Assistant. Users can view all the bots created by them on this page. They can also pin, search, and sort their assigned bots.</p>
<p>New team reference in Request and Process pages</p> <p>The user can now reference the team from which a request is created by referring to the new <b>Team</b> column in the <b>Request</b> page or the team name added in the process tile in the <b>Process</b> page, to help guide their team assignment.</p>

What's new
<p>New Request Visibility field (Service Cloud case ID: 00718119)</p> <p>Request visibility enables users to allow or restrict access to a request they created to other team members. When the <b>Request Visibility</b> field is set to <b>Shared</b>, all the requests are accessible by all members, owners, and team admins. If the field is set to <b>Private</b>, the requests are available only to the user who has created the request, owner, and the team admin.</p>
<p>Enhancement to the Processes page</p> <p>The following enhancements are available on the <b>Processes</b> page:</p> <ul style="list-style-type: none"> <li>• Sort the processes by name, in ascending or descending order.</li> <li>• Toggle the pinning of a process.</li> <li>• Use the responsive view to adjust the display to the screen size.</li> </ul>
<p>Cloud storage usage</p> <p>Based on the maximum file and storage sizes, users who upload files can use cloud storage. The quota for storage is as follows:</p> <ul style="list-style-type: none"> <li>• The size of the file uploaded using the <b>Select File</b> element cannot exceed 25 MB.</li> <li>• By default, the storage can store a maximum of 100 MB of data.</li> <li>• It is extended to an additional 1 GB for every Automation Co-Pilot user license allocated.</li> </ul>
<p>Copy process to URI feature</p> <p>The Automation Co-Pilot admin can use the new <b>Copy process to uri to clipboard</b> feature in the <b>Process setup</b> page to obtain the URI data and share with team members as reference when they enter the URI data to the <b>Create a Request</b> action.</p> <p><a href="#">Process Composer package</a> on page 2893</p>
<p>Add rows from header row context menu</p> <p>Only the header row is displayed when a form that has a table is launched during bot runtime. Use one of the following methods to add new rows to the table:</p> <ul style="list-style-type: none"> <li>• Header row context menu of the table <a href="#">Using the Table element</a> on page 3451</li> <li>• The <b>Set</b> action in a bot <a href="#">Set action</a> on page 3079</li> </ul>
<p>Support for interface triggers on Google Chrome</p> <p>Interface triggers are now supported on the Google Chrome browser for the following actions during bot runtime:</p> <ul style="list-style-type: none"> <li>• When you click a button element in a form</li> <li>• For <b>Got focus</b> and <b>Lost focus</b> actions in a text box</li> <li>• When a preconfigured hot key is used with the <b>Got focus</b> action in a text box</li> </ul> <p><a href="#">Add an interface trigger</a> on page 2294</p>

What's changed
<p>Changes to teams and processes</p> <p>For users who had access to processes, when they update to the latest Automation 360 version, their existing teams remain the same but is now set to a <b>shared</b> team type, regardless of their existing team assignment. Automation Co-Pilot users and managers are now converted to <b>member</b> and <b>admin</b> team roles, respectively. While any existing processes assigned to your team are shown as <b>Team Migrated for Process</b> after the update.</p> <p>For Automation Co-Pilot managers (process manager) who could create requests without assigning process to teams. After the update, the Automation Co-Pilot managers must create teams, ask the Automation Co-Pilot admin to assign teams to a process in order to create new requests.</p> <p>Processes have the <b>by user</b> option set by default for teams to view a process. You must choose the <b>by bot</b> option to have request be created by bots or another process.</p> <p><a href="#">Automation Co-Pilot for Business Users on the web interface</a> on page 3372   <a href="#">Assign a team to a process</a> on page 3389</p>
<p>Update to Auto Assign feature</p> <ul style="list-style-type: none"> <li>In the <b>Human Task</b>, you can no longer use the auto-assign feature to assign the task automatically to the manager. You can auto-assign the task to the user who created the request.</li> <li>The option to assign the target task to the manager is now removed from the <b>Go to</b> element.</li> </ul> <p>You can now override the previous auto-assign setting by selecting the <b>Override task assignment setting</b> option in the <b>Go to</b> panel by either unassigning the task or assigning the task to the user who created the request.</p>

The following table lists the fixes and the builds in which they were fixed. Build 9664 is the latest build for Cloud and includes fixes from the previous builds (including Build 9604). On-Premises is on Build 9664.

Fixes		
Build	Service Cloud case ID	Description
9664	00788255	After updating from v.19 to this release version, processes containing forms with the <b>Table</b> , <b>Checkbox</b> , or <b>Text Box</b> element now execute successfully. Previously, if the process contained a form with an empty table, check box, or text box, it failed during execution if no changes were made in the form.
9664	00772925	The layout of the request view page no longer changes when the user selects a language other than English.
9664	00781891, 00784947	Warning texts in the process editor now render correctly with UTF-8 encoding.

Fixes		
Build	Service Cloud case ID	Description
9664	--	Users with the attended license are now correctly redirected to the Automation Co-Pilot Desktop Assistant application when they log in from the same device where a user without the attended licenses tried to access the application beforehand.
9604	00765406	When you enter more than four number values with a comma in a <b>Number</b> element field in the initial forms or tasks, the field can now accept the large number value without issues.
9595	00719862	In the <b>Team Setup</b> page, you can now view the members of your team and check if the member count is consistent with the number of team members.
9595	00738934	Users can now view, upload, download, or delete their files when they add the <b>Select File</b> element to forms to complete tasks in the web interface.
9595	00767008	When you upload a file with the <b>Select File</b> element in your tasks, the bot now downloads your file through the <b>Get Storage file</b> action without issues.
9595	--	Long text for the label name of <b>Radio button</b> and <b>Checkbox</b> elements in a form is now displayed completely.

Limitations
<p>(Service Cloud case ID: 00831376) When you use the storage service to upload or download files from the web interface, the download is redirected to an AWS and GCP presigned URL. You will not be able to download files unless you add the AWS and GCP URLs to the trusted list.</p> <p>Workaround: You must add the following URLs to the trusted list in order to download:</p> <ul style="list-style-type: none"> <li>• AWS: <code>https://&lt;bucket-name&gt;.s3.&lt;region&gt;.amazonaws.com/</code></li> <li>• GCP: <code>https://storage.googleapis.com/&lt;bucket-name&gt;/</code></li> </ul>
<p>(Service Cloud case ID 00789181) When a bot is deployed in Automation Co-Pilot and the deployment is not completed even after an hour, the bot fails and the status changes to <b>failed</b> in Automation Co-Pilot. However the same bot still executes in the Control Room.</p> <p>Workaround:</p> <p>Choose one or both of the following options:</p> <ul style="list-style-type: none"> <li>• Define an adequate duration for your bot execution.</li> <li>• Increase the size of your device pool.</li> </ul>

Limitations
<p>For On-Premises, when you log in to Automation Co-Pilot Desktop Assistant application as a non-attended user, it shows an error as expected. However if you use that same credentials, or credentials from another non-attended user, and log in again to the application, it takes you to the web interface page.</p> <p>Workaround:</p> <ol style="list-style-type: none"> <li>1. Log in to the Automation Co-Pilot Desktop Assistant application as an attended user.</li> <li>2. First, log in to the web interface (aari/#/assistant URL) then log out without changing anything in the browser. Second, navigate to the Automation Co-Pilot Desktop Assistant application on your desktop and log in as an attended user.</li> </ol>
<p>The <b>Teams</b> column in the <b>Process setup</b> page is not automatically updated when the Automation Co-Pilot admin adds or removes their team in a process.</p> <p>Workarounds: Use the following options on the <b>Process setup</b> page:</p> <ul style="list-style-type: none"> <li>• Click the <b>Refresh the list</b> option.</li> <li>• Click the browser's refresh option to reload the page.</li> <li>• Navigate to another tab then return to this page.</li> </ul>
<p>When you use the <b>Process Task</b> in the process editor, you cannot use the <b>Public folder</b> option in the <b>Select process file</b> field because adding a public process as a dependency to the private process is not supported.</p>
<p>When users use the <b>Image</b> element to render images, the images does not render external images in the request view when users run their tasks.</p>

## Discovery Bot

What's new
<p>Sort for a process tile from the Processes page</p> <p>You can now use the sort field to help you locate a process tile quickly. From the <b>Processes</b> page, use the drop-down menu to sort on a process tile based on the process name in alphabetical order. Alternatively, you can sort in the order of the newest process created to the oldest process and vice versa.</p> <p><a href="#">Create a Discovery Bot process</a> on page 3905</p>

What's new
<p>Enhancements to opportunities</p> <p>You can now review and analyze automatically generated (or system-generated) opportunities immediately from the <b>Opportunities</b> page. Auto-generated opportunities are created when at least two recordings are approved by the user. You can create a custom opportunity from an auto-generated opportunity and apply the <b>Model</b> and <b>Filter</b> options to target a specific opportunity for automation.</p> <p>You can now prioritize opportunities based on a simple formula for all recordings in a process. From the Opportunities table, you can view the cost without automation and savings for an opportunity. The system automatically calculates the cost and potential savings for each opportunity generated. You can customize these metrics based on your organization's model for cost and savings.</p> <p><a href="#">Review opportunities and convert to</a></p>
<p>Generated PDD files are available on your local server</p> <p>The generated PDD file for an opportunity is now stored locally on your server for On-Premises deployments. The existing PDD files are automatically moved to the new location and are not deleted when a re-installation or update is performed in the Control Room.</p> <p><a href="#">Prerequisites for Discovery Bot</a> on page 3896</p>

Fixes	
Service Cloud case ID	Description
--	Double-click, drag-drop, click and hold, and text select are now supported when you are recording a business process.
--	When you record a process with more than 1000 steps, the <b>Recordings</b> page now displays the process without any delay. Previously, the <b>Recordings</b> page took some time to load.

Limitations
<p>The Control Room installer for Red Hat Enterprise Linux (version 7.7 or 7.9) does not include the Discovery Bot package.</p> <p>Workaround: Log in to the Control Room as an admin, select <b>Manage &gt; Package &gt; Upload</b> and upload the Discovery Bot package. The package is included in the list of default packages.</p>
<ul style="list-style-type: none"> <li>• Cloud users: When an opportunity is created with 50 steps, the <b>Download PDD</b> option is disabled and the PDD is not available for download.</li> <li>• On-Premises users: When an opportunity is created with 100 steps, the <b>Download PDD</b> option is disabled and the PDD is not available for download.</li> </ul>

## IQ Bot

What's new
<p>IQ Bot standard forms</p> <p>Create learning instances using the standard forms, which use an existing pretrained model and classification for extracting a large number of data fields from structured documents that typically have less or no variations in the layout.</p> <hr/> <p><b>Note:</b> Standard forms are currently available only as a beta feature.</p> <hr/> <p><a href="#">Using IQ Bot for standard forms</a> on page 3798</p>
<p>Additional learning instances for IQ Bot Process documents action</p> <p>Use the new <b>Azure 3.2</b> and <b>japanese_Tegaki</b> learning instances for the IQ Bot <b>Process documents</b> action in the IQ Bot Extraction package.</p> <p><a href="#">Using IQ Bot Process documents action</a> on page 2757</p>
What's changed
<p>IQ Bot file paths</p> <p>File locations and folder names are updated to use the new product name. For example:</p> <ul style="list-style-type: none"> <li>The default installation path is changed from C:\Program Files (x86)\Automation Anywhere IQ Bot A2019\ to C:\Program Files (x86)\Automation 360 IQ Bot\.</li> <li>The default log path is changed from C:\Users\Public\Documents\Automation Anywhere IQ Bot A2019 to C:\Users\Public\Documents\Automation 360 IQBot Platform.</li> </ul>
<p>Provider column on Learning Instances page updated</p> <p>The <b>Provider</b> column in the <b>Learning Instances &gt; My learning instances</b> page is now updated to display a list of all available OCR engines associated with the corresponding learning instance.</p>
<p>Enhancements to IQ Bot Extraction package</p> <p>IQ Bot Extraction package now supports the following OCR engines:</p> <ul style="list-style-type: none"> <li>Microsoft Azure Computer Vision OCR engine 3.2 This significantly improves the OCR extraction from Chinese language documents.</li> <li>Tegaki API OCR engine</li> </ul> <p><a href="#">IQ Bot Extraction package</a> on page 2749</p>

What's changed
<p>Enhancement to IQ Bot security (Service Cloud Case ID: 00677507)</p> <p>You can now further improve security in IQ Bot by configuring RabbitMQ v3.8.18 communication through a secure SSL/TLS channel. Set <code>secureRabbitMQCommunication = true</code> in the <code>system.properties</code> file and then restart all IQ Bot services, including RabbitMQ v3.8.18. By default, this flag is set to <code>false</code>.</p> <p>This enhancement also fixes an issue that caused a RabbitMQ v3.8.18 security vulnerability.</p>
<p>Reuse the name of a deleted learning instance   Automation 360 IQ Bot On-Premises</p> <p>While creating or editing a new learning instance, you can now reuse the name of a learning instance that was deleted. Ensure you backup the documents in your <b>Output</b> folder before deleting a learning instance. You can then clear the documents of the <b>Output</b> folder before creating or editing a new learning instance with the same name.</p> <p>If you have not cleared the documents from the <b>Output</b> folder for the deleted learning instance, you cannot download the contents. However, you can download only the documents processed by the new learning instance.</p>
<p>Support for Microsoft Azure SMB</p> <p>IQ Bot now supports Microsoft Azure files storage system using the SMB (Server Message Block) protocol. You can now also install IQ Bot using the shared folder configured with SMB and access the output files from the same directory.</p>
<p>Switch between databases without re-installing IQ Bot</p> <p>You can now switch between configured databases without re-installing IQ Bot using the <code>SwitchDBServer.bat</code> utility.</p> <p>To use this utility, perform the following steps:</p> <ol style="list-style-type: none"> <li>1. Download and extract the <code>SwitchDBServer.bat</code> utility from the <code>&lt;IQBot installation Dir&gt;\Configurations</code> folder, and then open the command prompt in this directory.</li> <li>2. Run the batch (.bat) file with an IP address or hostname of the destination DB server. Example: <code>SwitchDBServer 171.xx.xx.11</code></li> </ol>

The following table lists the fixes and the builds in which they were fixed. Build 9642 is the latest build for On-Premises and includes fixes from the previous build.

Fixes		
Build	Service Cloud case ID	Description
9596	00777932, 00766332	While you update to this IQ Bot release, the output path from the previous version is now retained during installation.



Fixes		
Build	Service Cloud case ID	Description
9595	00686444	When exporting learning instances from one environment to another, IQ Bot now updates the <code>visionBotId</code> in the exported data. So you can now edit bots in the destination environment without any errors.
9595	--	Duplicate table row entries in the Validator are now significantly reduced due to the improved table extraction logic.
9595	00651057	IQ Bot can now connect to Control Room Ignite cache without any errors. This fixes an issue where all learning instances were not displayed.
9595	00616038	When you update or restart Control Room, error messages are no longer displayed when you use the link or click <b>Explore IQ Bot</b> to open IQ Bot.
9595	00668412, 00644948, 00717414	When you now upload a document in production, deadlocks no longer occur in the system and documents are correctly sent to the Validator.
9595	00651572, 00650959	If no files are available in the <code>Output \Successful</code> folder and you click the <b>Download all documents</b> action, IQ Bot now displays the correct error message.
9595	--	Documents in Chinese (Simplified) language are now processed successfully without any issues.
9595	--	If you add a blocked library to a custom Python logic and click <b>Test Run</b> for any field, an error message is no longer displayed on the Designer page.
9595	--	The Enterprise 11 IQ Bot command can now be migrated to the <b>Upload Documents</b> action in Automation 360 IQ Bot. Therefore, you no longer have to manually create bots when you migrate the learning instances.

Limitations
<p>IQ Bot Cloud: If you do not access IQ Bot within the configured <b>Ideal time out</b> value set on the IQ Bot server:</p> <ul style="list-style-type: none"> <li>• A message to restart IQ Bot is displayed.</li> <li>• Bots using IQ Bot APIs fail when the server is restarted.</li> </ul> <p>Refresh the IQ Bot web page after some time (more than 5 minutes) to log in to IQ Bot.</p>
<p>When you create a learning instance, if the PDF that you upload contains small fonts, the document is classified as an image. If you use the PDFBox OCR to create a learning instance for a multipage document, the segments are not displayed.</p> <p>Workaround: Turn off the PDFBox OCR.</p>
<p>For a standard forms learning instance, when you try to download output files and at the same time send frequent API requests to that database, the system might stop responding.</p> <p>Recommended: When using the standard forms learning instance, wait for the files to be downloaded. After the download, ensure you allow some time (&gt; 60 seconds) between the API requests.</p>
<p>If an incorrect configuration is used to create the <code>providerVersion</code> file of a standard forms learning instance, an error message is displayed when you move this learning instance to production.</p> <hr/> <p><b>Note:</b> Ensure you use valid configurations.</p> <hr/>
<p>If you use a bot associated with a standard forms learning instance to upload a large number of documents, some of the documents are not processed.</p> <p>Workaround: Because this issue might be caused due to a timeout, try to upload the documents after some time.</p>
<p>If you have used an earlier version of IQ Bot (11.x) to move documents to the <b>Validator</b>, you cannot download these documents when you migrate to this Automation 360 IQ Bot version.</p> <p>Workaround: If you are migrate to this version, ensure you clear all the documents in Validator.</p>
<p>When you use the <b>Download all documents</b> or <b>Upload Document</b> actions from the IQ Bot package, the upload and download can fail as the proxy settings specified in the Control Room are not used.</p>
<p>If you manually delete any <code>.csv</code> file from the <code>Success</code> folder, other files in the folder might not be downloaded when you use the <b>Download</b> option.</p> <p>Ensure you do not manually delete any files from the <code>Success</code> folder.</p>
<p>Only SQL authentication is supported when you use the Migration Assistant tool to migrate from IQ Bot 11.x to Automation 360 IQ Bot.</p>
<p>If you have a document with a large number of pages (&gt; 100), an error message is displayed intermittently when you click <b>See extraction results</b> for an existing learning instance.</p>

Limitations
The unclassified documents count in <b>Staging results</b> and <b>Production results</b> in the <b>Summary</b> tab of a learning instance might be displayed incorrectly.
On the Validator screen, if incorrect values are used to update a field on which you have applied validations, an alert is not displayed when the focus is lost from that field.
If any of the available number fields include parenthesis or (), the selected system identified region (SIR) on the document panel changes to a hyphen (-) when you click the extracted value.
<p>If you use the name of a deleted learning instance when creating a new learning instance, both the instances are listed in the <b>Learning instance name</b> drop-down menu of the <b>Upload document</b> action when a bot is created.</p> <p>Workaround: Click the new learning instance to remove the old learning instance from the list.</p>
If you use the Tesseract4 OCR during IQ Bot Extraction package updates, there is a delay in the document processing time and throughput results.
<p>For a learning instance created with standard forms, if the extraction is not successful for the <b>Field options</b> &gt; <b>Optional</b> field, the value set in <b>Default value</b> is not assigned to that form field.</p> <p>Workaround: Use Python script from the <b>Logic</b> tab to set the value that must be assigned as the <b>Default field</b>.</p>
(Service Cloud case ID: 00601790) For documents processed using the IQ Bot Extraction package, document details such as <b>Documents processed</b> and <b>Pages uploaded</b> are not displayed correctly in the <b>Dashboard</b> page.
<p>As the Preview2 version of the Microsoft Azure 3.2 is deprecated, if you have used the Microsoft Azure 3.2-Preview2 OCR engine to create a learning instance, the documents will be unclassified.</p> <p>Workaround: Ensure that you replace all occurrences of Microsoft Azure 3.2-Preview2 with Microsoft Azure 3.2:</p> <ul style="list-style-type: none"> <li>• In <code>Azure3OCREngineSettings.json</code> file, change <b>Version: v3.2-preview.2</b> to <b>Version: v3.2</b>. You can then update the OCR engine version by uploading this file to database using API <a href="#">How to change OCR Settings in IQ Bot (A-People login required)</a></li> <li>• In the IQ Bot <b>Installation</b> &gt; <b>Configurations</b> folder, update <code>Azure3ContainerOCREngineSettings</code> with Microsoft Azure 3.2. This is for the containerized deployment of Microsoft Azure 3.2 OCR engine.</li> </ul>

**Limitations**

(Service Cloud case ID: 00799842) When you process vector-based PDF documents in IQ Bot, the OCR results are sometimes inaccurate. For instance, in some cases, spaces between words are missed in the extracted data. This might happen because of reasons related to the document that you uploaded or the tool that you used to generate the PDF file.

Workaround: To process your vector-based PDF document successfully, perform either of the following steps:

1. Convert your vector-based PDF document again to a vector-based PDF document by using a tool such as Adobe Acrobat.
2. Convert your vector-based PDF documents to a raster file format, such as TIFF.

**Important:** For information about the packages supported with this release, see [Packages available in Automation 360](#) on page 2316.

## Enterprise A2019.20 Release Notes

Release date: 20 April 2021

Review what's new and changed, and the fixes and limitations in the Enterprise A2019.20 release. Build 8846 is for Cloud and Build 8815 is for On-Premises. IQ Bot A2019 is on Build 8815.

**Important:** We have updated the Cloud build to include the following fixes:

- Migrated bots failing to execute due to preprocessing error (Service Cloud case ID 00760877, 00761211)
- Unable to deploy bots because the resource path exceeds the maximum length supported by Microsoft (Service Cloud case ID 00764731, 00763373, 00765172, 763334)

- Migration
  - [11.x and 10.x | 11.x only](#)
- Enterprise A2019
  - [What's new](#) | [What's changed](#) | [Fixes](#) | [Limitations](#)
- Automation Co-Pilot
  - [What's new](#) | [What's changed](#) | [Fixes](#) | [Limitations](#)
- Discovery Bot
  - [What's new](#) | [What's changed](#) | [Fixes](#) | [Limitations](#)
- IQ Bot
  - [What's new](#) | [What's changed](#) | [Fixes](#) | [Limitations](#)
- Bot Insight
  - [What's new](#)

## Updating to this release

You can update to this release from the previous three releases (that is, from  $n-3$  releases, where  $n$  refers to the latest release). The following builds are certified for update to this release:

- Build 8147 (v.19)
- Build 7560 (v.18)
- Build 7103 (v.17)

For details on how to update, see [Update Automation 360 to latest version](#) on page 1423.

**Recommendation:** If you are not on an  $n-3$  release, update to one of the three certified releases before updating to this release.

**Important:** This release includes a required update to your . Ensure that you complete the update to continue with your automation activities when upgrading from a previous release to this release.

[Automatically update the Bot Agent](#) on page 1361 | [Manually update the Bot Agent](#) on page 1362

To verify which version is compatible with this release, see [Compatibility with release builds](#) on page 1333.

## Migration features

Enterprise 11 and Enterprise 10 features
<p>Select folders for migration (Service Cloud case ID: 00689307)</p> <p>In the Bot Migration Wizard, you can now select folders that contain bots (Task Bots and MetaBots) that you want to migrate to Enterprise A2019. As a result, you no longer have to migrate individual bots from that folder.</p>
<p>Migrate MetaBots with screens</p> <p>Migrate MetaBots that contain screens as assets. You can migrate screens based on HTML, MSAA, Java, .Net technologies and use credential variables.</p>
<p>Migrate bots with the following attributes</p> <ul style="list-style-type: none"> <li>• Bots that contain the <b>IF &gt; Logic successful</b> or <b>IF &gt; Logic unsuccessful</b> command and these commands return a variable as output</li> <li>• Bots that contain the Run Task command with the <b>Repeat until I stop it</b> option to the <b>Run</b> action in the Task Bot package</li> <li>• Bots that use the \$Clipboard\$ system variable as input and output variables to pass the value to the MetaBot logic</li> </ul>

Enterprise 11 only features
<p>Migrate bots that use SAP BAPI to automate SAP-related tasks</p> <p>Migrate bots that use SAP BAPI to automate the SAP-related tasks. The SAP commands are migrated to equivalent actions of the SAP BAPI package, and the username, password, and hostname attributes used to connect to the SAP server in the Enterprise 11 bots are migrated as credential variables in Enterprise A2019.</p>
<p>Retain legacy behavior of \$Excel Cell Row\$ system variable</p> <p>Use the <b>Use "Excel Cell Row" legacy behavior</b> option in the Bot Migration Wizard to retain the legacy behavior of the \$Excel Cell Row\$ system variable used in bots created in versions earlier than Version 11.3.1 after they are migrated to Enterprise A2019.</p>
<p>Migrate bots with the following attributes:</p> <ul style="list-style-type: none"> <li>• Bots that use the <b>Delete</b> or <b>Get All Messages</b> command to delete or download attachment from all emails that use Exchange Web Services (EWS) using OAuth authentication.</li> <li>• Bots that contain objects captured using the Object Cloning command that are based on Firefox and Silverlight technologies</li> <li>• Bots that use the <b>Modify user</b> command with the <b>Update Account Options</b> and the <b>Change Password</b> option in the Active Directory command</li> <li>• Bots that use the <b>Create user</b> option in the Active Directory command</li> <li>• Bots that use the Variable Operation command and the <b>Decimal configuration</b> option is selected</li> <li>• Bots that use the \$AATaskExecutor\$ system variable</li> <li>• Bots from Version 11.3.5 or later that use the <b>Get Single Cell</b> command with the <b>Specific cell</b> and <b>Get Cell Value</b> options selected to retrieve value from a cell in a Microsoft Excel file.</li> </ul>

## Enterprise A2019

What's new
<p>Support for IPv6 addresses</p> <p>You can install Enterprise A2019 in distributed load balancer cluster mode in an IPv6 network to comply with your organization's infrastructure and information security requirements.</p> <p>The following are not supported:</p> <ul style="list-style-type: none"> <li>• Geo location is not available for IPv6 addresses.</li> <li>• Link-local addresses for IPv6 addresses are removed from the Enterprise A2019 installer's IPv6 list.</li> </ul> <p><a href="#">Configure IP cluster</a> on page 1261</p>

What's new
<p>Switch device registration between Control Room instances</p> <p>You can now switch your device registration between multiple instances of the Control Room without reinstalling the Bot Agent. This setting is applicable to single user devices installed at the system or user level.</p> <p><a href="#">Switch device registration between Control Room instances</a> on page 1807   <a href="#">Switch Bot Agent to a different Control Room</a> on page 1350</p>
<p>New permission to attest device user name (Service Cloud case ID: 00576058)</p> <p>Use the new permission to assign a default device to a user name to bypass credential validation when you deploy a bot on unattended Bot Runners. The permission is applicable to default device users with an unlocked and active user session.</p> <p><a href="#">Feature permissions for a role</a> on page 1749</p>
<p>Resource threshold settings to optimize bot deployments</p> <p>Configure resource threshold settings in the Control Room so that the system deploys the next bot only when the system resources on the device are within the specified thresholds. Specify the settings at the Control Room level for all devices, and customize these settings at each device level.</p> <p><a href="#">Manage device settings</a> on page 1797</p>
<p>Reduce bot startup time</p> <p>You can now reduce the bot startup time using settings in the Control Room to preload the most frequently used packages in the automation on all user devices when they connect to the Control Room.</p> <p><a href="#">Automatic package updates for Cloud Control Room</a> on page 1907</p>
<p>Express queue in workload automation</p> <p>You can now quickly create workload automation queues with default parameters in the Control Room by using the <b>Create express queue</b> option in the <b>Queues</b> page.</p> <p><a href="#">Create express queues</a> on page 1999</p>
<p>Group filters for Active Directory users</p> <p>You can provide additional filters for the <code>Users</code> directory as part of the <code>um.properties</code> file. As a result, you can filter the security groups that are in the <code>Users</code> directory for role mapping in the Control Room.</p> <p><a href="#">Manage Active Directory role mapping</a> on page 1774</p>
<p>Automate SAP-related tasks using SAP BAPI</p> <p>Use the actions available in the SAP BAPI package to automate SAP-related tasks using SAP BAPI.</p> <p><a href="#">SAP BAPI package</a> on page 3003</p>

What's new
<p>Default names for output variables</p> <p>When you configure an output variable for the following packages, the Control Room shows a descriptive default variable name. If you create several output variables, subsequent variable names are appended with a -1, -2, -3, and so on to avoid duplication.</p> <ul style="list-style-type: none"><li>• Browser</li><li>• CSV/TXT</li><li>• Email</li><li>• Excel advanced</li><li>• JavaScript</li><li>• Loop</li><li>• Recorder</li><li>• VBScript</li><li>• Window</li></ul>
<p>PDF split with blank pages supports scanned image documents (Service Cloud case ID: 00683923)</p> <p>Use the PDF <b>Split</b> action to separate a blank page from pages with scanned images. With pixel-based split, you can now use <b>Split document</b> to split a PDF with blank page separators for scanned (image-based) documents.</p>
<p>SMTP port range expanded to include ports 1 through 65535</p> <p>The Email package now supports ports in the range of 1 through 65535 for the SMTP server. You can use the <b>Send</b> email action by configuring the SMTP port in this range.</p>
<p>New actions in the Active Directory package</p> <ul style="list-style-type: none"><li>• <b>Update account options:</b> Sets account attributes for the user.</li><li>• <b>Change user password:</b> Use this option to change a user's password.</li></ul> <p><a href="#">User account operations</a> on page 2384</p>
<p>Enhancement to Create user action in Active Directory package</p> <p>You can now use the <b>Create user</b> action to create an Active Directory user with password.</p> <p><a href="#">Using the Create user action</a> on page 2386</p>
<p>Universal Recorder expanded support and new features</p> <p>Use the Universal Recorder to perform the following:</p> <ul style="list-style-type: none"><li>• Automate clicks and data retrieval in drop-down lists and combo boxes in Oracle EBS applications such as Compass.</li><li>• Link an object that the bot cannot reliably identify to a nearby object (such as a link or button) that is easier for the bot to find. Use this feature in MSAA, UI Automation, or Java applications.</li></ul>



What's new
<p>Support for new languages in variable names</p> <p>You can now use Czech, Danish, Dutch, Finnish, French, German, Hungarian, Italian, Norwegian, Polish, Portuguese, Romanian, Spanish, and Swedish characters in variable names.</p> <p><a href="#">Unicode range supported in variables</a> on page 2341</p>
<p>Search and add child bot in the parent bot</p> <p>Search for a child bot in the public and private workspaces so that you can add it in the parent bot. You can search for the child bot from the Bot editor and the <b>Run</b> action of the Task Bot package.</p> <p><a href="#">Using the Run action</a> on page 3111   <a href="#">Bot editor for creating bots</a> on page 2228</p>
<p>Obtain information about user that deployed the bot</p> <p>Use the AATaskInvoker system variable to return the username, first name, last name, and email of the user that ran or scheduled the bot. If the bot is deployed to an attended Bot Runner, this variable returns information about the logged-in user. If the bot is deployed by a trigger, this variable returns information about the user who set the trigger.</p> <p><a href="#">System settings and parameters</a> on page 2329</p>
<p>Git restoration enhancements</p> <ul style="list-style-type: none"><li>• If your database is deleted or corrupted, as an administrator you can now restore files from the Git repository to a repository that is not fully empty.</li><li>• You can also overwrite or skip the files if you have duplicate files in the Git repository.</li><li>• If you are restoring files in an empty repository, you can choose to use either your existing credentials (configured with Control Room) or the credentials of any other repository.</li></ul> <p><a href="#">Restore bots from Git repository</a> on page 1832</p>
<p>View version history of Task Bots</p> <p>You can now view the version history of your Task Bots to identify relevant changes performed by other users to your Task Bots during a specific date and time along with the check-in messages.</p> <p><a href="#">View Task Bot version history</a> on page 2312</p>
<p>External key vault support</p> <p>Use external key vaults to securely store and retrieve credentials using a third-party key manager such as CyberArk and AWS Secrets Manager. External Key Vault support for AWS Secrets Manager and CyberArk for Bootstrap (database credentials,) and System (Service account credentials, Active Directory service account credentials, and SMTP credentials).</p> <p><a href="#">Integrate external key vaults</a> on page 1249</p>

What's new
<p>New condition in If package (Service Cloud case ID: 00536088, 00690073,00717514, 00737243, 00702383)</p> <p>Use the new <b>Window with same title does not exist</b> or <b>Window with same title exist</b> condition available in the If package to verify whether a window with the same title exists or whether the window title has changed.</p> <p><a href="#">If package</a> on page 2724</p>
<p>Google packages are now generally available</p> <p>Google Calendar, Google Drive, and Google Sheets packages are now generally available in Enterprise A2019, with a major change to the authentication method:</p> <ul style="list-style-type: none"><li>• Each Google package contains a <b>Connect</b> action to authenticate your account before adding other actions from that package to your automation. This action replaces the deprecated <b>OAuth</b> action from the G-Apps package.</li><li>• Each Google package contains a <b>Disconnect</b> action to terminate the connection.</li></ul> <p><a href="#">Connect action for Google packages</a> on page 2717</p>

What's changed
<p>Bots wait for Internet Explorer to fully render in Mouse package</p> <p>Bots (including bots migrated from Enterprise 11) that use the Mouse package now wait for the Internet Explorer to finish loading the page before executing the <b>Click</b> action. This prevents the bots from failing while the page is loading.</p>
<p>Interface change in the Edit variable window</p> <p>When editing a variable, if you deselect the <b>Use as input</b>, <b>Use as output</b>, or <b>Constant (read-only)</b> check box, a message now informs you of the impact of this change and requests you to confirm this update.</p>
<p>Enhancement to audit log entries (Service Cloud case ID: 00656155)</p> <p>The audit log entries are now enhanced to display the <b>Item Name</b> and <b>Event Type</b> for import, export, check-in, and check-out requests.</p>
<p>The .atmx file not downloaded during migration</p> <p>The migration process does not download the <code>.atmx</code> file if the associated bot is used as a child bot in the parent bot. The <b>Download CR file</b> action from the File package is no longer added in the migrated bot to download the depended bot (<code>.atmx</code>) file during migration.</p>

What's changed
<p>Option to either upgrade Recorder package version or downgrade to older Google Chrome extension</p> <p>Bots that use the Recorder package version 2.0.5 or older to automate in the Google Chrome browser, now need to be updated to use a Recorder package version that is newer than 2.0.5. This is only necessary for Bot Runner devices that have the new Google Chrome extension (ID:kammdlphdfejlpoonbapgbgkimokm) installed, and have not previously run bots that use the Recorder package version 2.0.5 or older.</p> <p>If you do not want to upgrade the Recorder package, you can manually install the old Google Chrome extension. See <a href="#">Google Chrome extension troubleshooting</a> on page 2251.</p>

The following tables lists the fixes and the builds in which they were fixed. Build 8846 is the latest build for Cloud and includes fixes from the previous builds. On-Premises is on Build 8815.

Build 8846	
Service Cloud case ID	Description
00764731, 00763373, 00765172, 763334	You can now deploy bots and dependent files stored in a repository with a file path that exceeds the maximum supported character length (256 characters) for your Windows operating system.
00714248	Only those Bot Runners and Bot Creators expressly configured as credential vault consumers for a given bot can use that bot.
00751728	When you migrate Enterprise 11 bots that use the String Operation command with the space character as a delimiter, the extracted value now retains the space and works properly. Previously, after migration, the space from the String Operation command was removed.
00760877, 00761211	Bots that are migrated, modified, and scheduled now successfully deploy without a preprocessing error. Previously, migrated bots failed to execute due to the following preprocessing error: <code>Attribute type ANY is not supported.</code>

Build 8840	
Service Cloud case ID	Description
00747869, 00750571, 0744918	When you create a bot using a loop with the Recorder Capture action to perform operations on the Chrome browser, the bot now executes without any disruption. Previously, the bot failed to run and displayed an error.

Build 8840	
Service Cloud case ID	Description
00733635, 00743082, 00750865	When you run a bot that contains the Excel Advanced > Find action, the found cell is now active and subsequent actions can perform operations on that active cell.
00723075, 00717920	When a bot encounters a workbook that contains links to cells in other workbooks, the system suppresses the Excel pop-up message so that the bot can run without interruption.
00746651, 00757879	After migrating bots, you can successfully run the bots without any preprocessing error. Previously, using variables inside brackets failed to process the task.
00742159, 00743092	The Excel Advanced Set cell and Delete cell actions now select the correct cells when the cell address column name contains more than one letter.
00743636	The Excel Advanced Set cell, Delete cell, and Go to cell actions now support all ranges. Previously, the actions encountered errors with ranges greater than AB1 : AB100.
00726030	Bots can now use the Recorder to capture objects that contain characters that are not valid in XML.

Build 8815	
Service Cloud case ID	Description
00750668	A workload bot is no longer stuck in a queue, and the device does not display a Pick up at run time status.
00733227	Control Room database tables are now created when you use the restored 11.x database while installing Enterprise A2019.
00733720	Bot Migration Wizard no longer encounters an error when processing a large bot for migration. Previously, this issue was encountered when a large bot was downloaded to the Bot Runner device for migration from the Control Room and the connection between the Bot Runner device and Control Room was reset.

Build 8815	
Service Cloud case ID	Description
--	Bot Scanner is now updated to include scenarios that were previously failing after migration. As a result, some bots might be moved from the list of bots that can be migrated to the list of bots that cannot be migrated in the output report. This can decrease the number of bots that can be migrated to Enterprise A2019.
00703679, 00711398, 00729399	Enterprise 11 or Enterprise 10 bots that use the string variable or an object captured from Internet Explorer whose property is null or empty no longer encounters an error after these bots are migrated.
00667326	Bot Scanner no longer becomes unresponsive when scanning bots for any of the following reasons: <ul style="list-style-type: none"> <li>Scanning a corrupted .atmx file of a bot</li> <li>Bots that contains the If, IF/ELSE, or Loop command and that command is commented out</li> <li>Bot that contains an object that is captured using the Object Cloning command using the <b>Coordinate</b> play mode and the <b>Click</b> action is performed on that object</li> </ul>
00731068, 00737025	An error is no longer encountered when you run a bot that contains multiple variables that return a number value in the same command after that bot is migrated.
00720261	An error is no longer encountered when you run a migrated bot that contains a special character.
00713303	In a migrated bot that uses the Run Task command, when you run a subtask within the main task and the subtask name contains Unicode characters, the bot now executes successfully without any error. Previously, the bot failed and displayed an error message.
00691133	You can now successfully delete migrated bots in your private workspace without encountering any issue. Previously, an error message was displayed when a migrated bot was deleted in the private workspace.
00736166	Previously, when the migration process was initiated, the process sometimes remained in the <b>In progress</b> status in the Bot Migration Wizard. Now the process starts running.

Build 8815	
Service Cloud case ID	Description
00730131	Bots that use the Run Script command with the \$Clipboard\$ system variable as an input or output variable no longer encounter errors when you run these bots after they are migrated to Enterprise A2019.
00726833	Enterprise 11 Work Items and queues that are associated with bots that use the Variable Operation command no longer encounter an error after the first item in the queue is processed successfully after migration to Enterprise A2019.
--	Bot Scanner no longer encounters an error when scanning MetaBots that contain the Object Cloning command that is commented out and the MetaBot is trying to find the play mode from those commented out commands.
00716557	An error is no longer encountered when you run a MetaBot in Enterprise A2019 that was created in Enterprise 10, migrated to Enterprise 11, and then migrated to Enterprise A2019.
00710569	When you migrate a MetaBot that contains screens as assets from Enterprise 11 to Enterprise A2019, Japanese characters in the object properties are now displayed correctly in the migrated bots. Previously, the Japanese characters in the object properties were garbled in the migrated bots.
00702262	The <b>Historical activity</b> page now shows a detailed error message that specifies the cause of the error and the line where the error is encountered for bots that are migrated from Enterprise 11 and use the Error Handling command.
00703513, 00708988	Parent bots that use the <b>Run</b> action of the Task Bot package with the <b>Upon error, start next repetition</b> option selected no longer encounter an error if their child bots encounter an error at runtime and do not return the output variable to the parent bot. Previously, parent bots encountered an error if the child bots did not return the output variable to the parent bots because the child bots encountered an error during runtime.

Build 8815	
Service Cloud case ID	Description
00702601	A bot that uses an array variable that contains a system variable and which returns an integer no longer encounters an error after that bot is migrated.
00707801	You can now migrate an Enterprise 11 bot that contains Mouse <b>Click</b> to capture the coordinates of a maximized window. Previously, the bot with a Mouse <b>Click</b> encountered an issue during migration because the window left and top parameters were set to negative values for maximized windows.
00710315, 00728228, 00729082, 00744242	Migrated bots that use the Object Cloning command with legacy technology to capture objects with multiple lines of text now work properly, without any issues.
00716650	When you migrate an Enterprise 11 bot that contains an Excel command with two Excel sessions in it, the <b>Get column name</b> or <b>Get row number</b> actions now displays the correct values in the output. Previously, the actions set the wrong session values in the migrated bot if it contained two Excel sessions.
00711148	Enterprise A2019 installation no longer fails if there is a space in the data and log path (for example, D:\Automation Anywhere \ProgramData). And, the following error message is no longer displayed: Control Room database tables fail to create.
00708902	You can now use the Google Drive package to upload files in the Google Shared Drive. Use only the <b>Folder ID</b> option to upload files to a shared folder in the drive and enter the ID of the shared folder. Previously, an error occurred when a user tried to upload a file in the shared folder in the Google Drive.
00735479	When you create a bot that has a dependency with a long repository path that exceeds the maximum limit of 256 characters and when you run the bot on the Bot Runner machine, the bot now displays a message, prompting you to reduce the length of the file path. Previously, the bot execution failed without any message providing the reason for the failure.

Build 8815	
Service Cloud case ID	Description
00727406	You can now successfully send an email in HTML format with an HTML attachment using the <b>Email server</b> . Previously, when an email was sent in HTML format along with an attached HTML file, the email body content and the content of the attached file were merged. As a result, only the attachment was seen in the mail without the body content.
00707734	In the App Integration package, when you use the <b>Capture text of window</b> action in a Japanese browser, the window title now displays properly for Japanese language. Previously, the output was not displayed correctly in the Japanese text format.
00699149,00707670	You can now use the <b>Unzip</b> action of the Folder package and execute your bots on a Windows 10 server. Now, if two Windows users with different device credentials try to deploy a bot on the same machine, the deployment does not fail. Previously, if a user deployed the bot on the same machine with a different user profile, the bot failed to execute.
00695224, 00730472, 00739431	When you use the <b>Find Image in a Window</b> action in the Image Recognition package, image files are now deleted from the <b>Temp</b> location and storage space is freed after bot execution. Previously, the image files were not deleted from the <b>Temp</b> location and as a result disk storage ran out of space.
00709162	The CSV/TXT <b>Open</b> action now works without encountering any issue even if there are blank values in the last row of the <b>.txt</b> file. Previously, if there were blank values in the last row of the file, the bot encountered an issue.
00711124	In the Email package, when you use the <b>Connect</b> action, add a loop, and select <b>For each in mail box to read emails</b> as the <b>Iterator</b> option, a new line is no longer deleted and correctly displays the email content. Previously, the new lines were deleted when the mail was sent and received in plain text format.



Build 8815	
Service Cloud case ID	Description
00673049	In the SAP package, if an error is encountered when the <b>Connect</b> action is used to connect with a SAP system, the error is now captured in the <b>Try</b> and <b>Catch</b> blocks. Previously, the connection issue was not captured in the <b>Try</b> and <b>Catch</b> blocks in the action.
00697215	A bot now executes successfully when you use the <b>Throw</b> action with an expression. Previously, when an expression such as <code>\$number.ToString\$</code> was used in the <b>Exception message</b> field of the <b>Throw</b> action, the bot encountered a preprocessing error.
00714260	Runtime errors are no longer displayed when you use the following: <ul style="list-style-type: none"> <li>• A MetaBot with run DLL migration function that takes more than one parameter type as Array or any type other than String</li> <li>• A Task Bot with run logic calling a child bot that takes more than one input parameter of type Array, which is mapped to a List variable in the parent bot run logic migration function</li> </ul>
00704547	The <b>Pause</b> action of the Task Bot package now works properly when you use it as the last task in the bot. Previously, the bot did not wait for the task to complete if the <b>Pause</b> action was used as last task in the bot.
00675344	A Task Bot now performs better when you use the Terminal Emulator <b>Send text</b> and <b>Send key</b> actions to execute a bot. Previously, the Task Bot took a long time to complete the execution.
00699650,00716648	When you use Image Recognition actions to execute a bot and if the bot fails during execution, the captured source and target images are stored in <code>C:\ProgramData\AutomationAnywhere\BotRunner\Logs\IR</code> with a maximum of 10 source and target image pairs. Now, when the maximum limit is reached, the oldest image pairs are overwritten with new images. Previously, the image logs were not overwritten.
00716817	A bot now executes successfully when you use the PDF <b>Extract text</b> action to extract structured text from PDF files. Previously, bot execution failed to extract structured text if it contained Thai characters.

Build 8815	
Service Cloud case ID	Description
00717204	You can now use a credential from the Credential Vault in the <b>URI</b> field of the REST Web Service actions.
00682726, 00678580, 00695359, 00684985	You can now use the Universal Recorder to automate in Oracle Fusion Middleware applications. Previously, an issue with the Java API caused the Recorder to select the entire window instead of the specific object.
00693770	Fixed an issue where numbers extracted from an SQL database to a data table variable were automatically converted to scientific notation.
00669959	You can now select the same start date and end date when you schedule bots with the <b>Run repeatedly</b> option ( <b>Activity &gt; Scheduled &gt; Schedule bot</b> ) in the Control Room.
00702841, 00700915	Disconnected devices are now displayed in the Control Room ( <b>Devices &gt; My Devices</b> ) when you filter the devices list by <b>Status</b> as <b>Disconnected</b> .
00707318, 00711529	Work items in an active queue are now processed and you no longer have to delete the active queue and create another queue after you upgrade from a previous release to this release.
00705046	Bots that include embedded dependent files instead of a zipped folder are no longer queued intermittently for deployment on Bot Runner devices.
--	Disabled tenant IDs or removed tenants that are later reused on the same deployment with a different tenant might produce a licensing error. This conflict is now removed and deboarded tenants in later reuse no longer generate the error.
00685926	When you import an exported bot into the private workspace and check in the imported bot, the bot is now checked in successfully without any issues. Previously, the check-in failed due to a metadata validation error.
00682025	When a bot or a file is modified in the public workspace, the cloned dependent file in the private workspace now reflects the changes and the bot executes successfully. Previously, the cloned dependent file did not reflect the changes and the bot execution failed.

Build 8815	
Service Cloud case ID	Description
00726018	The Google Drive <b>Upload file</b> action now uploads files to subfolders.
00715080, 00731152	You can now perform concurrent unattended bot deployment on a multi-user device with multiple user sessions running simultaneously.
--	A non-admin Bot Agent user now remains connected to the Control Room and is not disconnected frequently.
00709737	Actions in the Google Sheets package now support worksheets that contain empty cells.
00710354	A hibernate exception error is no longer displayed when you log in to the Control Room as an admin user.
00732178	<p>You can now check out bots from folders with similar names but in different letter cases and edit the bots in your private workspace in the Control Room.</p> <p>For example, if there is a folder named <code>Automation1</code> in the public workspace and a folder named <code>automation1</code> folder in the private workspace, you can now check out bots from the <code>Automation1</code> folder in the public workspace.</p>
--	Bots are now deployed on a multi-user device in a non-admin user session when another admin user session is also active on the device if auto-login setting in the Control Room is set to lock the session after the bot finishes executing from an existing unlocked session.
00719407	During a cluster installation of Enterprise A2019 on Red Hat Enterprise Linux, the installer now uses the same user ID across all cluster nodes.
00703325	The log file permission for an Control Room installed on Linux now maps to the <code>crkernel</code> user. Previously, it was mapped to the <code>root</code> user.
--	When you access the Control Room with the <b>Login with Windows</b> option selected, you must now enter the FQDN to log in successfully.
00732141, 00722919,00743006	When you preload a package, after the download is complete, the completion status updates in the <b>Activity &gt; Historical activity</b> page and the pending record is no longer displayed in the <b>Activity &gt; In progress</b> page.

Build 8815	
Service Cloud case ID	Description
00731376	When you migrate MetaBot logic, if there is case mismatch in the variable name and the mapping variable, variables are no longer created twice. As a result, a preprocessing error does not appear when you execute the task.
	Now, the migration of run logic with CV variables is supported.
	Now, when using the <b>Date</b> system variable in the <b>File</b> folders command, a migrated bot is no longer failing.
	When migrating bots (v11.x to A2019) with OC properties more than 64KB, such properties will be truncated and the bot will be migrated.

The following table lists the fixes and the builds in which they were fixed. Build 8846 is the latest build for Cloud and includes fixes from the previous builds. On-Premises is on Build 8815.

Fixes		
Build	Service Cloud case ID	Description
8846	00764731, 00763373, 00765172, 763334	You can now deploy bots and dependent files stored in a repository with a file path that exceeds the maximum supported character length (256 characters) for your Windows operating system.
8846	00714248	Only those Bot Runners and Bot Creators expressly configured as credential vault consumers for a given bot can use that bot.
8846	00751728	When you migrate Enterprise 11 bots that use the String Operation command with the space character as a delimiter, the extracted value now retains the space and works properly. Previously, after migration, the space from the String Operation command was removed.
8846	00760877, 00761211	Bots that are migrated, modified, and scheduled now successfully deploy without a preprocessing error. Previously, migrated bots failed to execute due to the following preprocessing error: <code>Attribute type ANY is not supported.</code>
8840	00747869, 00750571, 0744918	When you create a bot using a loop with the Recorder Capture action to perform operations on the Chrome browser, the bot now executes without any disruption. Previously, the bot failed to run and displayed an error.
8840	00733635, 00743082, 00750865	When you run a bot that contains the Excel Advanced > Find action, the found cell is now active and subsequent actions can perform operations on that active cell.

Fixes		
Build	Service Cloud case ID	Description
8840	00723075, 00717920	When a bot encounters a workbook that contains links to cells in other workbooks, the system suppresses the Excel pop-up message so that the bot can run without interruption.
8840	00746651, 00757879	After migrating bots, you can successfully run the bots without any preprocessing error. Previously, using variables inside brackets failed to process the task.
8840	00742159, 00743092	The Excel Advanced Set cell and Delete cell actions now select the correct cells when the cell address column name contains more than one letter.
8840	00743636	The Excel Advanced Set cell, Delete cell, and Go to cell actions now support all ranges. Previously, the actions encountered errors with ranges greater than AB1 : AB100.
8815	00750668	A workload bot is no longer stuck in a queue, and the device does not display a <b>Pick up at run time</b> status.
8815	00733227	Control Room database tables are now created when you use the restored 11.x database while installing Enterprise A2019.
8815	00733720	Bot Migration Wizard no longer encounters an error when processing a large bot for migration. Previously, this issue was encountered when a large bot was downloaded to the Bot Runner device for migration from the Control Room and the connection between the Bot Runner device and Control Room was reset.
8815	--	Bot Scanner is now updated to include scenarios that were previously failing after migration. As a result, some bots might be moved from the list of bots that can be migrated to the list of bots that cannot be migrated in the output report. This can decrease the number of bots that can be migrated to Enterprise A2019.
8815	00703679, 00711398, 00729399	Enterprise 11 or Enterprise 10 bots that use the string variable or an object captured from Internet Explorer whose property is null or empty no longer encounters an error after these bots are migrated.
8815	00667326	Bot Scanner no longer becomes unresponsive when scanning bots for any of the following reasons: <ul style="list-style-type: none"> <li>Scanning a corrupted <b>.atmx</b> file of a bot</li> <li>Bots that contains the <b>If, IF/ELSE, or Loop</b> command and that command is commented out</li> <li>Bot that contains an object that is captured using the <b>Object Cloning</b> command using the <b>Coordinate</b> play mode and the <b>Click</b> action is performed on that object</li> </ul>

Fixes		
Build	Service Cloud case ID	Description
8815	00731068, 00737025	An error is no longer encountered when you run a bot that contains multiple variables that return a number value in the same command after that bot is migrated.
8815	00720261	An error is no longer encountered when you run a migrated bot that contains a special character.
8815	00713303	In a migrated bot that uses the Run Task command, when you run a subtask within the main task and the subtask name contains Unicode characters, the bot now executes successfully without any error. Previously, the bot failed and displayed an error message.
8815	00691133	You can now successfully delete migrated bots in your private workspace without encountering any issue. Previously, an error message was displayed when a migrated bot was deleted in the private workspace.
8815	00736166	Previously, when the migration process was initiated, the process sometimes remained in the In progress status in the Bot Migration Wizard. Now the process starts running.
8815	00730131	Bots that use the Run Script command with the \$Clipboard \$ system variable as an input or output variable no longer encounter errors when you run these bots after they are migrated to Enterprise A2019.
8815	00726833	Enterprise 11 Work Items and queues that are associated with bots that use the Variable Operation command no longer encounter an error after the first item in the queue is processed successfully after migration to Enterprise A2019.
8815	--	Bot Scanner no longer encounters an error when scanning MetaBots that contain the Object Cloning command that is commented out and the MetaBot is trying to find the play mode from those commented out commands.
8815	00716557	An error is no longer encountered when you run a MetaBot in Enterprise A2019 that was created in Enterprise 10, migrated to Enterprise 11, and then migrated to Enterprise A2019.
8815	00710569	When you migrate a MetaBot that contains screens as assets from Enterprise 11 to Enterprise A2019, Japanese characters in the object properties are now displayed correctly in the migrated bots. Previously, the Japanese characters in the object properties were garbled in the migrated bots.
8815	00702262	The <b>Historical activity</b> page now shows a detailed error message that specifies the cause of the error and the line where the error is encountered for bots that are migrated from Enterprise 11 and use the Error Handling command.

Fixes		
Build	Service Cloud case ID	Description
8815	00703513, 00708988	Parent bots that use the <b>Run</b> action of the Task Bot package with the <b>Upon error, start next repetition</b> option selected no longer encounter an error if their child bots encounter an error at runtime and do not return the output variable to the parent bot. Previously, parent bots encountered an error if the child bots did not return the output variable to the parent bots because the child bots encountered an error during runtime.
8815	00702601	A bot that uses an array variable that contains a system variable and which returns an integer no longer encounters an error after that bot is migrated.
8815	00707801	You can now migrate an Enterprise 11 bot that contains Mouse <b>Click</b> to capture the coordinates of a maximized window. Previously, the bot with a Mouse <b>Click</b> encountered an issue during migration because the window left and top parameters were set to negative values for maximized windows.
8815	00710315, 00728228, 00729082, 00744242	Migrated bots that use the Object Cloning command with legacy technology to capture objects with multiple lines of text now work properly, without any issues.
8815	00716650	When you migrate an Enterprise 11 bot that contains an Excel command with two Excel sessions in it, the <b>Get column name</b> or <b>Get row number</b> actions now displays the correct values in the output. Previously, the actions set the wrong session values in the migrated bot if it contained two Excel sessions.
8815	00711148	Enterprise A2019 installation no longer fails if there is a space in the data and log path (for example, D:\Automation Anywhere\ProgramData). And, the following error message is no longer displayed: Control Room database tables fail to create.
8815	00708902	You can now use the Google Drive package to upload files in the Google Shared Drive. Use only the <b>Folder ID</b> option to upload files to a shared folder in the drive and enter the ID of the shared folder. Previously, an error occurred when a user tried to upload a file in the shared folder in the Google Drive.
8815	00735479	When you create a bot that has a dependency with a long repository path that exceeds the maximum limit of 256 characters and when you run the bot on the Bot Runner machine, the bot now displays a message, prompting you to reduce the length of the file path. Previously, the bot execution failed without any message providing the reason for the failure.

Fixes		
Build	Service Cloud case ID	Description
8815	00727406	You can now successfully send an email in HTML format with an HTML attachment using the <b>Email server</b> . Previously, when an email was sent in HTML format along with an attached HTML file, the email body content and the content of the attached file were merged. As a result, only the attachment was seen in the mail without the body content.
8815	00707734	In the App Integration package, when you use the <b>Capture text of window</b> action in a Japanese browser, the window title now displays properly for Japanese language. Previously, the output was not displayed correctly in the Japanese text format.
8815	00699149,00707670	You can now use the <b>Unzip</b> action of the Folder package and execute your bots on a Windows 10 server. Now, if two Windows users with different device credentials try to deploy a bot on the same machine, the deployment does not fail. Previously, if a user deployed the bot on the same machine with a different user profile, the bot failed to execute.
8815	00695224, 00730472, 00739431	When you use the <b>Find Image in a Window</b> action in the Image Recognition package, image files are now deleted from the Temp location and storage space is freed after bot execution. Previously, the image files were not deleted from the Temp location and as a result disk storage ran out of space.
8815	00709162	The CSV/TXT <b>Open</b> action now works without encountering any issue even if there are blank values in the last row of the .txt file. Previously, if there were blank values in the last row of the file, the bot encountered an issue.
8815	00711124	In the Email package, when you use the <b>Connect</b> action, add a loop, and select <b>For each in mail box to read emails</b> as the <b>Iterator</b> option, a new line is no longer deleted and correctly displays the email content. Previously, the new lines were deleted when the mail was sent and received in plain text format.
8815	00673049	In the SAP package, if an error is encountered when the <b>Connect</b> action is used to connect with a SAP system, the error is now captured in the <b>Try</b> and <b>Catch</b> blocks. Previously, the connection issue was not captured in the <b>Try</b> and <b>Catch</b> blocks in the action.



Fixes		
Build	Service Cloud case ID	Description
8815	00697215	A bot now executes successfully when you use the <b>Throw</b> action with an expression. Previously, when an expression such as <code>\$number.ToString\$</code> was used in the <b>Exception message</b> field of the <b>Throw</b> action, the bot encountered a preprocessing error.
8815	00714260	Runtime errors are no longer displayed when you use the following: <ul style="list-style-type: none"> <li>• A MetaBot with run DLL migration function that takes more than one parameter type as Array or any type other than String</li> <li>• A Task Bot with run logic calling a child bot that takes more than one input parameter of type Array, which is mapped to a List variable in the parent bot run logic migration function</li> </ul>
8815	00704547	The <b>Pause</b> action of the Task Bot package now works properly when you use it as the last task in the bot. Previously, the bot did not wait for the task to complete if the <b>Pause</b> action was used as last task in the bot.
8815	00675344	A Task Bot now performs better when you use the Terminal Emulator <b>Send text</b> and <b>Send key</b> actions to execute a bot. Previously, the Task Bot took a long time to complete the execution.
8815	00699650,00716648	When you use Image Recognition actions to execute a bot and if the bot fails during execution, the captured source and target images are stored in <code>C:\ProgramData\AutomationAnywhere\BotRunner\Logs\IR</code> with a maximum of 10 source and target image pairs. Now, when the maximum limit is reached, the oldest image pairs are overwritten with new images. Previously, the image logs were not overwritten.
8815	00716817	A bot now executes successfully when you use the PDF <b>Extract text</b> action to extract structured text from PDF files. Previously, bot execution failed to extract structured text if it contained Thai characters.
8815	00717204	You can now use a credential from the Credential Vault in the <b>URI</b> field of the REST Web Service actions.
8815	00682726, 00678580, 00695359, 00684985	You can now use the Universal Recorder to automate in Oracle Fusion Middleware applications. Previously, an issue with the Java API caused the Recorder to select the entire window instead of the specific object.
8815	00693770	Fixed an issue where numbers extracted from an SQL database to a data table variable were automatically converted to scientific notation.

Fixes		
Build	Service Cloud case ID	Description
8815	00669959	You can now select the same start date and end date when you schedule bots with the <b>Run repeatedly</b> option ( <b>Activity &gt; Scheduled &gt; Schedule bot</b> ) in the Control Room.
8815	00702841, 00700915	Disconnected devices are now displayed in the Control Room ( <b>Devices &gt; My Devices</b> ) when you filter the devices list by <b>Status</b> as <b>Disconnected</b> .
8815	00707318, 00711529	Work items in an active queue are now processed and you no longer have to delete the active queue and create another queue after you upgrade from a previous release to this release.
8815	00705046	Bots that include embedded dependent files instead of a zipped folder are no longer queued intermittently for deployment on Bot Runner devices.
8815	--	Disabled tenant IDs or removed tenants that are later reused on the same deployment with a different tenant might produce a licensing error. This conflict is now removed and deboarded tenants in later reuse no longer generate the error.
8815	00685926	When you import an exported bot into the private workspace and check in the imported bot, the bot is now checked in successfully without any issues. Previously, the check-in failed due to a metadata validation error.
8815	00682025	When a bot or a file is modified in the public workspace, the cloned dependent file in the private workspace now reflects the changes and the bot executes successfully. Previously, the cloned dependent file did not reflect the changes and the bot execution failed.
8815	00726018	The Google Drive <b>Upload file</b> action now uploads files to subfolders.
8815	00715080, 00731152	You can now perform concurrent unattended bot deployment on a multi-user device with multiple user sessions running simultaneously.
8815	--	A non-admin Bot Agent user now remains connected to the Control Room and is not disconnected frequently.
8815	00709737	Actions in the Google Sheets package now support worksheets that contain empty cells.
8815	00710354	A hibernate exception error is no longer displayed when you log in to the Control Room as an admin user.

Fixes		
Build	Service Cloud case ID	Description
8815	00732178	<p>You can now check out bots from folders with similar names but in different letter cases and edit the bots in your private workspace in the Control Room.</p> <p>For example, if there is a folder named <code>Automation1</code> in the public workspace and a folder named <code>automation1</code> folder in the private workspace, you can now check out bots from the <code>Automation1</code> folder in the public workspace.</p>
8815	--	Bots are now deployed on a multi-user device in a non-admin user session when another admin user session is also active on the device if auto-login setting in the Control Room is set to lock the session after the bot finishes executing from an existing unlocked session.
8815	00719407	During a cluster installation of Enterprise A2019 on Red Hat Enterprise Linux, the installer now uses the same user ID across all cluster nodes.
8815	00703325	The log file permission for an Control Room installed on Linux now maps to the <code>crkernel</code> user. Previously, it was mapped to the <code>root</code> user.
8815	--	When you access the Control Room with the <b>Login with Windows</b> option selected, you must now enter the FQDN to log in successfully.
8815	00732141, 00722919, 00743006	When you preload a package, after the download is complete, the completion status updates in the <b>Activity &gt; Historical activity</b> page and the pending record is no longer displayed in the <b>Activity &gt; In progress</b> page.
8815	00731376	When you migrate MetaBot logic, if there is case mismatch in the variable name and the mapping variable, variables are no longer created twice. As a result, a preprocessing error does not appear when you execute the task.
8815		Now, the migration of run logic with CV variables is supported.
8815		Now, when using the <b>Date</b> system variable in the <b>File</b> folders command, a migrated bot is no longer failing.
8815		When migrating bots (v11.x to A2019) with OC properties more than 64KB, such properties will be truncated and the bot will be migrated.

Limitations
<p>(Service Cloud case ID: 00822176) When you create an RDP session on multi-user devices and enter a custom port, RDP-based deployments will fail.</p> <p>Recommended: Use the default port 3389 for RDP sessions.</p>
<p>When you create a bot with <b>Open</b> and <b>Close</b> browser actions in a loop and select the <b>Window</b> option to close the selected tab, an error might occur when you execute the bot.</p> <p>Workaround: Use the <b>Close</b> action of the Window package instead of the <b>Close</b> action in the Browser package to close the window.</p>
<p>If you deploy bots using event triggers, and you install the Bot Agent on a device as a non-admin user for self or a local admin user, the Bot Agent will not be updated automatically. The device is will be shown as disconnected in the Control Room.</p> <p>Workaround:</p> <ol style="list-style-type: none"> <li>1. End the trigger listener Java process (javaw.exe) from the Task Manager.</li> <li>2. Re-install the Bot Agent to reconnect the user device in the Control Room.</li> </ol>
<p>Configuring multiple IP addresses for Control Room nodes in a cluster is not supported during installation in On-Premises deployments. You must manually configure the primary IP address in the <code>cluster.properties</code> file.</p> <p><a href="#">Add primary IP address for cluster</a> on page 1320   <a href="#">Configure additional IP address for a new cluster node</a> on page 1321</p>
<p>Bot deployment on multi-user sessions is not supported for workload automation.</p>
<p>Using an Enterprise A2019.20 SDS On-Premises Control Room with an Enterprise A2019.19 SDS Cloud Control Room is not supported.</p>
<p>When you run a bot containing a <b>Capture</b> action that uses the anchor object feature, your device DPI settings must match the settings at which you configured the anchor object.</p>
<p>The Control Room does not allow hyphens and underscores to be used interchangeably when creating and calling global value names.</p>
<p>When you migrate an Enterprise 11 bot that uses Object Cloning command with Silverlight technology and execute that bot in Enterprise A2019, the bot might fail with an error due to a play reliability issue. The same play reliability is also seen in Enterprise 11 when you use Object Cloning command with Silverlight plugins.</p>
<p>For actions that use file input, when you select a network path using <b>Browse</b>, bot execution fails because the double backslash (\\) in the file location is replaced with a forward slash.</p> <p>Workaround: Do not use the <b>Browse</b> option to select the file location. Instead, manually enter the complete file path.</p>
<p>When a Bot Creator, attended Bot Runner or unattended Bot Runner user logs in to the Control Room from their Bot Agent machine and if the package download option is enabled, the package download takes priority, and bot deployment waits until the package download is complete. This occurs only when the package is downloaded for the first time.</p>

Limitations
When a bot runs an automation in the Microsoft Internet Explorer browser, the Microsoft API responsible for the browser delay might encounter an exception, causing the bot to fail and a Chrome-related error message to appear in the Control Room.
(Service Cloud case ID: 00712808) Automation Anywhere related files are sometimes generated in C:\Windows\Temp. These files can be safely deleted.
For Enterprise 11 bots that contain an object that is captured using the Object Cloning command using the <b>Image</b> or the <b>Coordinate</b> play mode, the <b>Set Text</b> is performed on that object and the credential variable is used to set text for the object. The credential variable for these bots is not migrated when the bots are migrated to Enterprise A2019.
<p>If you use the <b>Set text</b> action in the <b>Recorder &gt; Capture</b> action to enter data into a text box, when you run the bot, the data appears over the old data in the text box and is not entered. The old data is not cleared from the text box because the application requires a physical event to clear the old data.</p> <p>Workaround: To ensure that the data is entered into the text box, along with the <b>Set text</b> action, add a value greater than 0 in the <b>Time between keystrokes</b> field.</p>
When you use the Recorder to capture an object, set the waiting time for detecting the object to less than 30 seconds in the <b>Keep trying for (seconds)</b> field, and run the bot, the Recorder waits for a minimum of 30 seconds by default to detect the object.
<p>When you use the Recorder to capture objects on an application that is installed on a virtual machine, finish the recording after the objects are captured, and relaunch the Recorder, the bot inserts the actions recorded earlier instead of launching the Recorder.</p> <p>Workaround: Refresh the Bot editor or run the bot to launch a new session to start recording again.</p>

## Automation Co-Pilot for Business Users (Automation Co-Pilot)

What's new
<p>Get Storage file action</p> <p>The new <b>Get Storage file</b> action in the Automation Co-Pilot Web package enables you to download storage files to a bot device.</p> <p><a href="#">Process Composer package</a> on page 2893</p>
<p>Upload files in initial forms or tasks</p> <p>Add the <b>Select File</b> element to forms to enable users to select and upload files in the initial forms or tasks in the web interface. Users can browse to upload a new file or replace an existing file. The uploaded file is shown as a hyperlink and redirects users to a new tab when opened.</p> <p><a href="#">About Process Composer</a> on page 3419</p>

What's new
<p>Hyperlinks support for initial forms or tasks</p> <p>Use the new <b>Hyperlink</b> element to add links to forms and access them in initial forms and tasks.</p> <p><a href="#">About Process Composer</a> on page 3419</p>
<p>Configure a scheduler user for each process (Service Cloud case ID: 00713786)</p> <p>As an Automation Co-Pilot administrator, you can now configure a scheduler user for each process to allocate the Control Room resources (devices and unattended Bot Runners) on the web interface. By default, the <b>Global scheduler</b> user is selected if a scheduler user is not configured for individual processes.</p> <p><a href="#">Configure scheduler user for Automation Co-Pilot</a> on page 3413</p>
<p>Update to properties panel for human task (Service Cloud case ID: 00718109)</p> <p>As a Bot Creator, you can choose to not configure any actions in the human task by selecting the <b>Make the form read-only</b> check box in the <b>Properties</b> panel. The human task does not require any input and it is executed automatically to the next task.</p>
<p>Bookmark any page as landing page for Automation Co-Pilot on the web</p> <p>The web interface is now enhanced to a new multiple page system so that you can directly bookmark any page (<b>Requests</b>, <b>Tasks</b>, or <b>Recycle Bin</b>) as your landing page. Also, the tabs in the web interface have been removed so that the requests are opened one at a time and not simultaneously. To perform multiple tasks, you can open the requests pages in different browser tabs.</p>
<p>Navigation enhancement in Automation Co-Pilot on the web</p> <p>The web interface is now enhanced with a side navigation pane so that you can easily navigate to various pages (<b>Processes</b>, <b>Requests</b>, <b>Recycle Bin</b>, and <b>Tasks</b>).</p>
<p>New processes page (Service Cloud case ID: 00694786)</p> <p>As an Automation Co-Pilot user, navigate to your assigned processes and create new requests by using the new <b>Processes</b> page in the web interface. Use the navigation bar to quickly access the page.</p>
<p>Enhancements to the Button element</p> <ul style="list-style-type: none"> <li>• Use the <b>Disallow button click when this form is first loaded</b> option to disable the <b>Button</b> element in a form when it is displayed for the first time during bot runtime.</li> <li>• Use the <b>Subtle</b> option in the <b>Button type</b> drop-down menu if you want the button element to appear as a link during bot runtime.</li> </ul> <p><a href="#">Using the Button element</a> on page 3438</p>
<p>Enhancement to the form logo</p> <p>You can now use the <b>Logos in footer</b> field option to select up to two separate logos that are displayed in the footer of the form during bot runtime.</p> <p><a href="#">Create a form</a></p>

What's changed	
<p>Enhancement to the delete process</p> <p>An Automation Co-Pilot administrator or a user with the <b>Delete from Public</b> permission can now delete a process in the public workspace. When the process is deleted from the public workspace, it is removed from the process management page in the web interface. Additionally, if the process is already assigned to any Automation Co-Pilot user or team, access is removed after the process is deleted.</p> <p><a href="#">Delete a process automation</a> on page 3490</p>	
<p>Variable selector window update</p> <p>The variable selector is now organized by <b>Variable Source</b>, <b>Variable Type</b>, and <b>Variable</b> sections. The variable source contains a request or task. The variable type is now an interface option for you to select an input, output, or meta types. The variable option specifies the variable names and type.</p>	
<p>Request variable source</p> <p>The variable selector now enables users to select a <b>Request</b> variable source with an <b>Input</b> (previously <b>InitialData</b>) and <b>Meta</b> variable types.</p> <p><a href="#">Create a process automation in Process Composer</a> on page 3454   <a href="#">Supported variable types in Process Composer</a> on page 3433</p>	
<p>Insert variables to existing text</p> <p>You can use the variable selector in the process editor to insert or add variables without replacing the existing texts.</p> <p><a href="#">Create a process automation in Process Composer</a> on page 3454</p>	
<p>Filter update</p> <p>In the web interface, when you filter or search for keywords, the filter user interface now updates and reflect the filter criteria accordingly. For example, if you search for the ending status of requests, the filter shows <code>Status: Pending</code>.</p>	

Fixes	
Service Cloud case ID	Description
00702607	If you have a <b>Message box</b> action within a trigger loop, you can now use the <b>Run from here</b> option to run the bot without any error messages.
00725237	Error messages are no longer displayed when the <b>Dropdown</b> element in the form is populated with dynamic values during bot runtime.
00733978	Forms with read-only elements can now be submitted successfully without any issues when the value of the form field exceeds 100.

Fixes	
Service Cloud case ID	Description
-	If you select any of the <b>Advance behavior</b> options in the <b>Dropdown</b> element, error messages are no longer displayed during bot runtime.
--	A <b>Bot Task</b> can now pass data to the next task ( <b>Human Task</b> or <b>Bot Task</b> ) if it contains Japanese characters in its output variable name. Previously, English characters had to be used for the variable name in the <b>Bot Task</b> .
--	In a cloud environment, the Automation Co-Pilot web interface now displays the correct screen for the selected locale. Previously, the screen was not displayed correctly for the selected locale.

Limitations
<p>In the process editor, the <b>If/Else</b> condition of string type does not allow the source and target values to be empty. As a result, you cannot validate if a string variable is empty.</p> <p>Workaround: Create an empty string output variable for the bot. Use this variable as the target value to compare with a form or bot source variable so that the validation in the <b>If/Else</b> condition does not fail.</p>
<p>When you enter data in a form of your process that contains a hyperlink, the data is ignored when you try to submit the form. The hyperlink instead displays the following behaviors:</p> <ul style="list-style-type: none"> <li>• When the hyperlink URL is configured at a designed time (the process of designing the interface or setting properties), the URL remains unchanged by the process.</li> <li>• When the hyperlink URL is not configured at a designed time, then the URL is set to the Control Room domain.</li> </ul>

## Discovery Bot

What's new
<p>Search for a business process from the Processes page</p> <p>You can now use the search field to help you locate a specific process by name. The field is not case-sensitive. The search field is available from the <b>Processes</b> page.</p> <p><a href="#">Create a Discovery Bot process</a> on page 3905</p>



What's new
<p>View all captured images from the screenshot modal window</p> <p>You can now navigate across all captured screenshots when you click an image in full size from the modal window. Click the pagination located below the image to select a step number or use the right or left arrows to quickly display all captured images.</p> <p><a href="#">Record a Discovery Bot business process</a> on page 3910</p>
<p>Process Discovery package is included in default packages</p> <p>The Process Discovery package is now included in the default packages. You can preload the default package when you connect to your device. Preloading the package helps to speed the start time of the recorder the first time you begin recording a process</p> <p><a href="#">Prerequisites for Discovery Bot</a> on page 3896</p>
<p>Recorder enhancements</p> <p>You can now perform actions such as double-click, drag-drop, click and hold, and text select when recording a business process. Actions performed using keyboard strokes are displayed in the <b>Data</b> field. Double-click is captured by the recorder and displayed in the screenshot from the <b>Recordings</b> page.</p> <hr/> <p><b>Note:</b> The Discovery Bot recorder does not capture the drag-drop and click and hold actions from the <b>Recordings</b> page. To include these actions performed during the recording, you can document the individual steps in the <b>Step description</b> text field for the analyst.</p> <hr/> <p><a href="#">Record a Discovery Bot business process</a> on page 3910</p>
<p>Support for IPv6 addresses</p> <p>IPv6 addresses are now supported for Discovery Bot.</p>
<p>Linux support</p> <p>Discovery Bot is now supported on Red Hat Enterprise Linux and Linux CentOS platforms.</p> <p><a href="#">Installing Control Room on Linux</a> on page 1293</p>
<p>Support for high availability</p> <p>Discovery Bot now supports high availability deployment.</p> <p><a href="#">High availability deployment</a> on page 1235</p>

What's changed
<p>Changing default repository path for custom installation</p> <p>For custom installation, you can now change the default repository path location to a new location on your server after installation.</p> <p><a href="#">Prerequisites for Discovery Bot</a> on page 3896</p>

Fixes	
Service Cloud case ID	Description
--	You can now export a PDD for an opportunity with 2000 steps by using the <b>Download PDD</b> option from the <b>Opportunities</b> page.

Limitations
When <b>Tab</b> is used to move across fields to a password-type field, the entered data is displayed as clear text, for example, when you move from the <b>Username</b> to <b>Password</b> field. Review the text in the <b>Data</b> field for confidential information before you submit the process.
Some actions might not be supported during a recording session, for example, when you click through the Network tab in Inspect mode using Chrome. For such unsupported actions, pause the recorder, complete the action, and then resume the recording.
When you record a process with 1000+ steps, the <b>Recordings</b> page takes some time to load.  Workaround: Depending on your environment, you can perform one of the following actions: <ul style="list-style-type: none"> <li>• Split the recording into multiple recording sessions. For example, you can divide 1000 steps into 10 separate recordings.</li> <li>• Wait for all the steps to load on the page before submitting the process for review.</li> </ul>

## IQ Bot

What's new
Enhancement to the Document Classifier package  The <b>Train Classifier</b> action now provides an option to retrain the documents using an existing model file.  <a href="#">Using Train Classifier action</a> on page 2510

What's changed
IQ Bot Pre-processor actions renamed  The names of all the available actions in the IQ Bot Pre-processor package are now changed. For example, the <b>Get barcodes</b> action is now renamed as <b>GetBarCodes</b> .  <a href="#">IQ Bot Pre-processor package</a> on page 2742

What's changed
<p>Download all processed documents without any timeout (Service Cloud case ID: 00587817)</p> <p>You can now download all your processed files from the Amazon S3 server to your local machine without causing any timeout, irrespective of the number of files. Even when you choose the <b>Delete files from the server after downloading</b> option and if your download fails, a compressed .zip file containing the failed documents is available for downloading again.</p> <p><a href="#">Download all documents action</a> on page 2758</p>
<p>Enhancements to IQ Bot APIs (Service Cloud case ID: 00688683, 00688678, 00688675)</p> <ul style="list-style-type: none"> <li>• <code>File upload</code> API now returns the file ID of the uploaded file.</li> <li>• <code>File status</code> API now accepts a file ID and returns its status as a status code.</li> <li>• <code>File download</code> API now returns the extracted data in JSON format for a successfully uploaded file.</li> </ul> <p><a href="#">APIs to upload files, check file status, and downloading CSV file (A-People login required)</a></p>
<p>IQ Bot license renamed</p> <p>The license required to run IQ Bot is now renamed to <b>IQBot Platform</b> from the previous <b>Cognitive Platform</b>.</p> <p><a href="#">Licenses overview</a></p>

Fixes	
Service Cloud case ID	Description
00708806	You can now save documents of up to 20 MB after validating, without any issues.
00662968	Fixed an issue that caused the gateway service to become unresponsive.
00644948	When you now upload a document in production, deadlocks no longer occur in the system and documents are correctly sent to the Validator.
00707965	When you now migrate from IQ Bot Enterprise 11 to A2019 using the Migration Assistant tool, all database tables are correctly migrated, without any errors.
00715124	IQ Bot now deletes temporary files downloaded from Amazon S3 server in the <code>C:\windows\temp\</code> folder when they are no longer required. As a result, storage is no longer consumed by these temporary files.

Fixes	
Service Cloud case ID	Description
--	Logs are now available for the IQ Bot node servers in the C:\Users\Public\Documents\Automation Anywhere IQBot Platform\Logs\ folder.
--	IQ Bot now displays the correct error message when you refresh the extraction results page for a learning instance when its associated bot is moved to production.
--	When creating a table on the Designer page, if you click <b>See Extraction results</b> without completing the table creation, the correct error message is now displayed.  Previously, the following incorrect message was displayed: <i>Preview will be opened in a new tab.</i>
--	When a bot is deleted and you click the <b>Test bot</b> option on the Bots listing page, the following correct error message is now displayed: <i>Bot not found.</i>
--	Python logic is now correctly applied on all the tables. Previously, IQ Bot failed to execute Python logic for tables other than the default one.
--	You can view more granular logs for troubleshooting RabbitMQ v3.8.18 issues. These logs are now stored in the C:\Users\Public\Documents\Automation Anywhere IQBot Platform\Logs\RabbitMQ folder, depending on the log level, log size, and the rotation limit.  If any error occurs in the RabbitMQ v3.8.18 connection, those crash logs are stored in C:\Users\Public\Documents\Automation Anywhere IQBot Platform\Logs\RabbitMQ\log folder.
--	When you now create a user role with 2-byte non-English characters, services no longer fail to execute.
--	If there is an existing database, IQ Bot installer now does not check for the db_creator role for that user.

Fixes	
Service Cloud case ID	Description
--	A user with <code>AAE_IQ_Bot_Validator</code> role and <code>AAE_Basic</code> role can now successfully launch and validate documents in the IQ Bot Validator.

Limitations	
IPv6 addresses are not supported for IQ Bot, so ensure that you use IPv4 addresses only.	
If you try to apply Python logic to a linked column between two tables, an error message is displayed for the linked column in the second table and the applied logic fails.	
If you add a blocked library to a custom Python logic and click <b>Test Run</b> for any field, an error message is displayed on the designer page. Workaround: Remove the blocked library from the Python logic.	
If you use the <b>Overwrite</b> option to import a learning instance, all the available bots and groups are imported.	
When you use the <b>Process documents</b> action from the IQ Bot Extraction package to run a bot through workload management, the <b>Current Action</b> tab displays <code>Downloading additional resources</code> along with your command instead of <code>IQ Bot extraction</code> in the <b>In progress activity</b> page.	
Average processing time increases when you use the IQ Bot Extraction package on a document with more than 30 pages.	
Running existing bots that use the IQ Bot Pre-processor package might fail after you upgrade to this release. Workaround: Because the names of the available actions in the IQ Bot Pre-processor package have changed, delete the existing actions in the bots and update them with the new names before running the bot.	
(Service Cloud case ID: 00601790) You cannot register IQ Bot when the Control Room is installed on a Linux machine.	
When you run a bot that has the IQ Bot Extraction package, the activity information under <b>In progress &gt; Current Action</b> does not display the details correctly.	
If you use the File Download API option, the <code>json</code> response you receive does not have a valid format. Workaround: This issue occurs because the <code>:</code> (colon) is replaced by <code>=</code> (equal sign) in the <code>json</code> key value. After you receive the <code>json</code> response, use these options: <ul style="list-style-type: none"> <li>• Replace <code>=</code> with <code>:</code></li> <li>• Add <code>"</code> (double quotation marks) in each text</li> </ul>	
When you try to sort the <b>PagesUpload</b> column in the <b>Learning instance &gt; Document Group</b> tab, an error message is displayed.	

**Limitations**

On the Designer, if you resize the system identified region (SIR) of an auto-mapped field, the values from the resized selection are not captured in the corresponding value field.

Workaround: To update the content of an auto-mapped field:

1. Select the entire SIR region.
2. Draw a bigger bounding box around the region.

**Bot Insight****What's new**

AAE\_Admin role access to operations API from Power BI connector

The Power BI connector now provides the **AAE\_Admin** user role access to the botrundata operational API. With this role, you can connect to the botrundata API and extract operational metrics to be analyzed and visualized within Power BI.

Enhancements to the publish (production) dashboard

Users with the **AAE\_Bot Insight Admin** and **AAE\_Bot Insight Expert** role can now edit the published dashboard. You can use the save as option to save the production dashboard as a custom production dashboard and add widgets to your custom dashboard. You can also delete a default production dashboard and a custom production dashboard.

[Save a published dashboard](#) on page 3947 | [Delete a published dashboard](#) on page 3947

**Important:** The supported packages information is moved to this topic: [Packages available in Automation 360](#) on page 2316.

**Enterprise A2019.19 Release Notes**

Release date: 11 February 2021

Review the new features, changed features, fixed features, security fixes, deprecated features, and known limitations in the Enterprise A2019.19 release. Enterprise A2019.19 Build 8147 is available for On-Premises and Build 8145 is available for Cloud. IQ Bot is on Build 8098.

**Important:** We have updated the Enterprise A2019.19 builds to include fixes for the following issues:

- System variables that are displaying blank in the action field (Service Cloud case ID 00737695, 00737698)
- Editing the table size when creating a new table variable in On-Premises (Service Cloud case ID 00725978, 00727695, 00736105)
- Issues editing a bot in the Bot editor and opening the packages listing page that includes special characters (Service Cloud case ID 00733529, 00739634)
- Assigning a bot from the private workspace to a file variable (Service Cloud case ID 00727695)

- Actions in the Image Recognition package not allowing the use of files with .PNG extension and files with uppercase letters in the extension (Service Cloud case ID 00734972, 00734266)
- Variable names in uppercase changing to lowercase, hyphen changing to underscore, and variable not being displayed if it contained an uppercase character (Service Cloud case ID 00734784, 00734842, 00734999)
- Bots not getting deployed on a multi-user device when the user session is signed out and no active session existed (Service Cloud case ID 00727228, 00722888, 00732830, 00732835, 00733877, 00733362, 00726489, 00733070, 732959, 733160, 733269,733321, 733391, 733435, 733438, 733451, 733680, 733765, 733770, 733790, 733940, 00734067)
- Child bots encountering an error if they contained the **Find window in window** action of the Image Recognition package (Service Cloud case ID 00727031, 00730358, 00733607, 00733544, 0073464)
- Use of variables with camel case names in the Data Table, List, and Loop packages (Service Cloud case ID 00733263,00733459, 00733007, 00733988, 00734168, 00733141, 00733074, 00733087, 00733001,00734019)

For more information, see the Fixed features sections for Enterprise A2019 and Automation Co-Pilot.

- [Migration features](#) on page 543
- [Enterprise A2019](#) on page 545
- [AARI](#)
- [Discovery Bot](#) on page 561
- [IQ Bot](#) on page 562
- [Bot Insight](#) on page 566

## Migration features

Enterprise 11 and Enterprise 10 features
<p>Review messages in Migration Assistant</p> <p>The Migration Assistant displays review messages for migrated bots. Open the migration assistant for a bot to review messages for that bot.</p> <p><a href="#">View changes to migrated bots using Bot Assistant</a> on page 1677</p>
<p>Migrate MetaBots with screens</p> <p>Migrate MetaBots that contain screens as assets. You can migrate screens based on UI Automation technology and captured using the <b>Object</b> play mode.</p> <p><a href="#">How MetaBots are migrated</a> on page 1596</p>
<p>Review messages in Bot Scanner report</p> <p>The Bot Scanner report shows review messages about the behavior change in commands that are used in bots that can be migrated to Enterprise A2019.</p> <p><a href="#">Analyze Bot Scanner report for migration</a> on page 1534</p>

**Enterprise 11 and Enterprise 10 features**

Stop, or pause and resume migration

You can stop, or pause and then resume the migration process from the bot launcher and the **Activity > In progress** page.

[Stop bot migration](#) on page 1618 | [Pause and resume bot migration](#) on page 1617

Migrate bots that use capture scrollable text action in App Integration command

Enterprise 11 and Enterprise 10 App Integration commands that capture text from an application window with a vertical scroll bar are migrated to the **App integration > Capture scrollable text** action in Enterprise A2019.

[Package mapping for migration](#) on page 1620

**Enterprise 11 only features**

Map output of PDF integration command to multiple variables

The output of an Enterprise 11 bot that uses the PDF integration command is mapped with multiple variables in the equivalent actions of the PDF package after the bot is migrated to Enterprise A2019.

Migrate bots that use the following attributes:

- Bots that send Japanese text in the VT100 terminal using the **Send Text** command
- Bots that use the **Get Single Node** or the **Get Multiple Nodes** command to extract nodes that contain namespaces from an XML file
- Bots that contain the **Connect** command of the Terminal Emulator command and the value in the **Wait Time Out** field that is less than hundred milliseconds

Migrate bots that use the following options in the Active Directory command:

- The **Modify Object** command with the Rename, Delete, Move, and Set Property actions for the **Computer** and **Organizational Unit** object type.
- The **Modify Group** command with the **Add users to a group** and **Remove users from a group** actions.

[Package mapping for migration](#) on page 1620

**Enterprise 10 only features**

Migrate latest version of Enterprise 10 bots enabled with version control

You can now migrate the latest version of bots from your Enterprise 10 Control Room configured with SVN version control to Enterprise A2019. Use the **Copy 10.x data** option to copy the latest version of the Enterprise 10 bots to Enterprise A2019 and then use the Bot Migration Wizard to migrate the bots to Enterprise A2019.

[Copy Enterprise 10 data](#) on page 1581 | [How Enterprise 10 data is copied to Automation 360](#) on page 1578



## Enterprise A2019

**Important:** This release includes a required update to your . Ensure that you complete the update to continue with your automation activities when upgrading from a previous release to this release.

[Automatically update the Bot Agent](#) on page 1361 | [Manually update the Bot Agent](#) on page 1362

To verify which version is compatible with this release, see [Compatibility with release builds](#) on page 1333.

New features
<p>Auto-login settings</p> <p>Use the auto-login configuration in the Control Room to reduce bot startup time by reusing an existing user session. Configure auto-login in the <b>Administrator</b> settings for all devices or customize it from the <b>Devices</b> page for each device.</p> <ul style="list-style-type: none"> <li>• Configure the auto-login settings for a user session to create a new session or reuse an existing session</li> <li>• Keep user sessions unlocked</li> <li>• Log off from a user session after the bot completes execution</li> </ul> <p><a href="#">Configure auto-login settings</a> on page 1804   <a href="#">Devices</a> on page 1873</p>
<p>New CPU utilization and device memory settings</p> <p>Configure the CPU utilization and device memory threshold value in the Control Room settings to determine whether to deploy bots on devices or not.</p> <p><a href="#">Configure threshold settings for user devices</a> on page 1804</p>
<p>Install Bot Agent on devices without administrator privileges</p> <p>You can now choose to install the Bot Agent on user devices with either local user privileges (without administrator privileges) at the local user level or administrator privileges at the system level.</p> <p><a href="#">Install Bot Agent and register device</a> on page 1347   <a href="#">Create device pools</a> on page 1883   <a href="#">Users</a> on page 1737</p> <p>When you install the Bot Agent at the user level, the device will not be available as a default device for another user or for device pool selection during bot deployment. For more information, see <a href="#">Bot Agent known limitations</a>.</p>
<p>New diagnostic utility for Bot Agent</p> <p>Use the Bot Agent diagnostic utility to perform diagnostic checks on Bot Runner devices and to resolve Bot Agent connectivity issues.</p> <p><a href="#">Perform Bot Agent diagnostic checks</a> on page 1364</p>

New features
<p>New features in Data Table package (Service Cloud case ID: 00656843, 00707635)</p> <ul style="list-style-type: none"><li>Use the <b>Change column type</b> action in the Data Table package to perform operations on the column of a data table. Use this action to change the column data type to <b>Boolean, Datetime, Number, or String</b>.</li><li>Sort the data in the data table in <b>Number, Datetime, Boolean, or String</b> format.</li></ul> <p><a href="#">Data Table package</a> on page 2452</p>
<p>New action in App Integration package</p> <p>Use the <b>Capture scrollable text</b> action to extract text from the selected window or any control within the selected window and save it to a variable. If you click any control within the window, then text from that specific control is extracted. If you click outside the window, then all the text from that window is extracted.</p> <p><a href="#">App Integration package</a> on page 2423</p>
<p>New encoding combo box option in Terminal Emulator for VT Series</p> <p>To send and receive Japanese text, you can now use the <b>Encoding</b> and <b>CodePage</b> combo boxes when you connect to the Terminal Emulator for the VT series terminal type.</p> <p><a href="#">Using Connect action for Terminal Emulator</a> on page 3119</p>
<p>New actions in Active Directory package</p> <p>Use the following actions in the Active Directory to automate a task:</p> <ul style="list-style-type: none"><li>Move a computer <a href="#">Using the Move computer action</a> on page 2377</li><li>Move an organizational unit <a href="#">Using the Move organizational unit action</a> on page 2383</li><li>Add users to a group <a href="#">Using the Add users to group action</a> on page 2385</li><li>Remove users from a group <a href="#">Using the Remove users from group action</a> on page 2388</li></ul>
<p>New system variable for new line character (Service Cloud case ID: 00669232, 00672775, 00673578)</p> <p>Use the <code>\$String:Newline\$</code> system variable to add a new line character. This variable adds a new line character in various applications regardless of the operating system of the device.</p>
<p>Zero-size form for Enterprise A2019 (Service Cloud case ID: 00677611)</p> <p>The <b>Run</b> action uses the zero-size form with name <code>AAZeroSizeForm</code> that can be used by DLLs to identify zero-size forms created by Enterprise A2019.</p>

New features
<p>Enhancement to define parent path in Active Directory</p> <p>When you establish a connection with an LDAP server, you can now select the LDAP path by connecting to the server.</p> <p><a href="#">Using Connect action for Active Directory</a> on page 2380</p>
<p>Obtain information about Run-As user after bot deployment</p> <p>Use the AATaskExecutor system variable to return the username, first name, last name, and email of the user that ran the bot. If the bot is deployed on an attended Bot Runner, this variable returns information about the logged-in user. If the bot is deployed by a trigger, this variable returns information about the user associated with that Bot Runner license.</p> <p><a href="#">System settings and parameters</a> on page 2329</p>
<p>Enhancements to the Recorder</p> <ul style="list-style-type: none"> <li>• Universal Recorder now supports object capture in Mozilla Firefox. <ul style="list-style-type: none"> <li>You must install the A2019 extension from Mozilla Firefox browser add-ons.</li> </ul> </li> <li>• Capture table, grid view, and main window objects from SAP applications.</li> </ul> <p><a href="#">Universal Recorder supported applications and browsers</a> on page 2248   <a href="#">Actions performed on objects captured with Universal Recorder</a> on page 2923</p>
<p>Multi-user device supported on Citrix Windows 10 Enterprise (Service Cloud case ID: 00526001)</p> <p>Multi-user device sessions are now supported on Windows 10 Enterprise on Citrix, enabling multiple users to access the same device at the same time.</p>
<p>Event triggers on unattended Bot Runners (Service Cloud case ID: 00681548)</p> <p>Ensure that you select the <b>Reuse an existing session</b> option for auto-login settings in the Control Room to use event triggers on unattended Bot Runners when a device is locked or is in a disconnected state (such as RDP).</p> <p><a href="#">Configure auto-login settings</a> on page 1804</p>
<p>Auto Login support on Citrix VDI (Service Cloud case ID: 00680200)</p> <p>Auto Login is now supported on Citrix VDI, which enables bot deployment in unattended mode.</p> <p><a href="#">Configure auto-login settings</a> on page 1804.</p>
<p>Restore bots from Git repository</p> <p>If your database is deleted or corrupted, the admin user can restore all your bots and the associated dependent files from the Git repository to your new empty database.</p> <p><a href="#">Restore bots from Git repository</a> on page 1832</p>

New features
<p>Bot Deploy API checks for available devices in the order of listed pool IDs</p> <p>If you enter multiple pool IDs in the request body, the API checks the pools for available devices in the order that you listed the pool IDs. If none of the devices are available at the time of deployment, the automation is queued.</p> <p><a href="#">Bot deploy API</a></p>
Changed features
<p>Enhanced security for multi-user Bot Agent devices (Service Cloud case ID: 00695858)</p> <p>The Bot Agent configured on multi-user devices for RDP-based deployments now uses the updated version of <code>wfreerdp.exe</code> for enhanced security.</p>
<p>Deployment API enhancement (Service Cloud case ID: 00655548)</p> <p>When you invoke a regular deployment API, if a RunAsUser is being used to deploy a bot, the deployment API will not deploy other bots until the RunAsUser is free to run the other bots.</p>
<p>Status change initiates workload automation deployment</p> <p>When you change the status of a Work Item from <b>Failed</b> to <b>New</b> in the Control Room (<b>Queues</b>), the deployment of a workload automation in queue is initiated.</p>
<p>Install Google Chrome Enterprise extension offline with Bot Agent (Service Cloud case ID: 00623511, 00689623, 00715413)</p> <p>You can now install the extension for Google Chrome Enterprise offline from the Bot Agent setup and MSI files.</p>
<p>ANSI as default encoding in Data Table package</p> <p>For text write operations, Data Table package &gt; <b>Write to file</b> action supports ANSI as default encoding type.</p> <p>Bots created in the previous version of Enterprise A2019 with UTF-8 is not impacted by this change.</p>
<p>Enhancement to PDF package</p> <p>In the PDF package, when you enter an incorrect page range in the <b>Page range</b> field and execute the bot, an error message is now displayed, requesting you to provide the correct page range. The message is displayed for the following actions:</p> <ul style="list-style-type: none"><li>• Merge document</li><li>• Split document</li><li>• Extract text</li><li>• Extract image</li></ul>

Changed features
<p>Bots wait for Google Chrome web page to load</p> <p>When automating a task in the Google Chrome browser, bots now wait up to 30 seconds for the web page to load, and then run the subsequent <b>Recorder &gt; Capture</b> action. When the page loads, bots search for the object for the duration specified in the <b>Wait for control</b> field. Waiting for the web page to fully render increases the bot's ability to identify the target object in the web page.</p>
<p>Enhancement to desktop operations</p> <p>When you create a bot and select an option for desktop operations, the data selected from the drop-down list now persists even when you navigate to other fields.</p>
<p>Flow view updates in the Bot editor (Service Cloud case ID: 00701626)</p> <ul style="list-style-type: none"> <li>The <b>Flow</b> view is disabled when you create or edit a bot and the bot exceeds 500 lines of code. Use the <b>Show list view</b> option to navigate to the list view.</li> <li>In the Bot editor <b>Flow</b> view, a warning message is displayed when the bot exceeds 400 lines of code or if the bot has more than 100 variables.</li> </ul>

The following table lists the fixed features and the builds in which they were fixed (Build 8147 is the latest build, and builds 8145, 8134, 8122, and 8098 are the previous builds). These fixes are cumulatively available in the latest build.

Fixed features		
Build number	Service Cloud case ID	Description
8147	00737695	When you insert a system variable into an action field, the variable now appears in that field.
8147	00725978, 00727695	When you create a table variable in On-Premises, the table expands to the full size of the window. Previously the table only showed three rows at a time.
8147	00733529,00739634	You no longer encounter any issues when you edit a bot in the Bot editor and open the packages listing page. Previously, if an installed package had an object name with a space ( ' ') character in it, the package listing page displayed an error.
8145	00727695	You can now assign a bot from your private workspace to a file variable.
8145	--	When you create a variable in an action, the variable automatically appears in the field for which you created the variable.
8145	--	You can now use <b>.png</b> files in actions in the Image Recognition package.

Fixed features		
Build number	Service Cloud case ID	Description
8145	00734972, 00734266	You can now select a Control Room file with uppercase letters in the file extension in the <b>Image Recognition &gt; Find image in window</b> action.
8145	00734784	Variables names are now displayed correctly in the Bot editor List view; uppercase letters in the variable name are no longer changed to lowercase letters and hyphens are not changed to underscores.
8145	00734842, 00734999	Actions now display Boolean, date time, or list type variables if the variable name contains uppercase letters.
8145	00727228, 00722888, 00732830, 00732835, 00733877, 00733362, 00726489, 00733070, 732959, 733160, 733269, 733321, 733391, 733435, 733438, 733451, 733680, 733765, 733770, 733790, 733940, 734067	You can now deploy bots on a multi-user device when the user session is signed out and no active session (signed in, locked, or disconnected) exists either for that user or any other user. The following error message is no longer displayed on the <b>View historical activity (Activity &gt; Historical)</b> page: Unable to perform auto-login for user <username>.
8145	--	The Cloud migration utility no longer keeps running in the background if you close the utility when the Enterprise 11 data is being uploaded.
8134	00727031, 00730358, 00733607, 00733544, 00734642	You can now successfully execute bots when you use Image Recognition with the <b>Find window in window</b> action in a child bot. Previously, bot execution failed when you used Image Recognition with this action in the subtask.
8134	00733263,00733459, 00733007, 00733988, 00734168, 00733141, 00733074, 00733087, 00733001,00734019	The Data Table, List, and Loop packages now support variables with camel case names.
8122	00713867	Variables are now listed in alphabetical order in the Variables palette and in the <b>Insert a value</b> window that appears when you press the F2 key.

Fixed features		
Build number	Service Cloud case ID	Description
8122	--	The Control Room now does not take time to launch, and the following error message is no longer displayed: An Unexpected Problem Occurred.
8098	00689022, 00697417, 00697420, 00697079	A Bot Agent device no longer disconnects from the Control Room that is configured on Microsoft Azure. The following error message is no longer displayed: disconnecting due to outstanding pong.
8122	00719167, 00721731	Tasks such as scheduling bots and connecting to user devices are not delayed in an Control Room hosted on Cloud.
8098	00626595, 00680433	The actions in the Image Recognition package no longer return an incorrect error message about the target image data type.
8098	00698201	Fixed an issue where bots were stuck in the preprocessing mode when the bot was used as a child bot in several running bots or was deployed back to back using the Deploy API. Now bots are deployed from the cache and fewer calls are made to the database, thus avoiding a database deadlock.
8098	--	The Bot Scanner now displays the correct message for the MetaBot logic that contains credential variables that cannot be migrated to Enterprise A2019.
8098	00687223	An Enterprise 11 bot that passes a blank value as an input to the string, list, one-dimensional array, and two-dimensional array of string type variable used in a DLL no longer encounters an error when you run that bot after migrating to Enterprise A2019.
8098	00677231	A bot is no longer unresponsive if it contains an action to close the Google Chrome browser followed by an action to open the Google Chrome browser.

Fixed features		
Build number	Service Cloud case ID	Description
8098	00687207	When an Enterprise 11 bot contains objects captured using the Object Cloning command and that object has a property that contains an expression within the \$ character, the Enterprise 11 bot no longer encounters an error after migration.
8098	00689286	The Bot Scanner no longer encounters an error when you scan an Enterprise 11 bot that contains the If command with the <b>Windows control</b> condition selected and is automating a task on a Microsoft Excel file.
8098	00706438	An error is no longer encountered when you are installing Enterprise A2019 and: <ul style="list-style-type: none"> <li>You are migrating from Enterprise 11 to Enterprise A2019</li> <li>Active Directory is configured on the Enterprise 11 Control Room</li> <li>The restored Enterprise 11 database contains the <b>AAE_Meta Bot Designer</b> role</li> </ul>
8098	00708522	An error is no longer encountered when you clone a dependent file of an Enterprise 11 bot after it is migrated to Enterprise A2019. The error is encountered only when the migrated bot contains a null description.
8098	00626664	You can now migrate bots that automate tasks in BMC applications. The migrated bots use the <b>Legacy automation &gt; Manage web controls</b> action to automate interactions with objects.
8098	--	You can now select the regular expression <b>Case insensitive</b> option in actions that contain a window title field and successfully perform a recapture in the application window.
8098	00688134	In the Database package, Korean characters are now displayed properly when you use the <b>Insert/Update/Delete</b> action in an Excel file. Previously, the Korean characters were not displayed properly when the action was used.



Fixed features		
Build number	Service Cloud case ID	Description
8098	00675749	In the Email package, you can now forward an email using groupId or Alias. Previously, the mails were not sent by the SMTP server if the email address contained groupId or Alias in the <b>To address</b> field.
8098	--	You can now use a double backslash (\ \) in the <b>Send text</b> action of the Terminal Emulator and execute bots. Previously, when a double backslash (\\) was used in this action and the bot was executed, the terminal displayed a single slash (\).
8098	00688692	When you connect to the EWS server to read mails using Loop, the retrieved email now displays the content correctly per the selected mode (HTML or plain text formats). Previously, when connecting to the EWS server to read an email in HTML format, the email body displayed a blank output.
8098	00659456	In the Loop package, when you select <b>For each file in folder</b> as the <b>Iterator</b> option, the <b>Note</b> below the <b>Assign file name and extension to this variable</b> field now displays the key name in English. Previously, the key name in the <b>Note</b> was translated to the languages you selected.
8098	--	A bot no longer runs intermittently when the focus changes from one window to another window and does not display the Type_015 Google Chrome plug-in error.
8098	00683528	In the Database package, single entries are now inserted in the database when you execute a store procedure to add rows in the table and the option <b>Export data to CSV</b> is selected. Previously, duplicate entries were added in the database.
8098	00693664	Fixed an issue where Japanese characters did not display correctly when input into a field that contained a variable.
8098	00677167	The locker <b>Participants</b> tab now shows only the assigned participants for that specific locker. Previously, the tab displayed the participants of the previously viewed locker, requiring the user to refresh the browser to see the correct participants.

Fixed features		
Build number	Service Cloud case ID	Description
8098	--	The Control Room services can now be run using the non-administrator service account users. The Bad Gateway error message is no longer displayed.
8098	00691232	Fixed an issue that did not allow users to update the value of a file type input variable after saving the bot.
8098	--	The <b>Save</b> option is now correctly enabled when users make any changes to the metadata, unique entity, or SAML assertion mode.
8098	--	The username is no longer saved in the login window after the user logs out unless the user has selected the <b>Remember my username</b> option.
8098	00682021	When you check in a bot that has cloned bots as dependencies, the dependent files are no longer lost from the private workspace. Also, after the check-in, if you create a new bot using the same dependencies as in the earlier bot, the new bot executes successfully.
8098	--	Work Items are now processed for workload automation after you add more Work Items to an existing queue.
8098	--	Work Items are now reprocessed for workload automation after you change the status from failed to new.
8098	00711410	You can now migrate workload automations in an Control Room configured to use a manual mode for Credential Vault.
8098	00667047, 00673289	Auto-login for a user session no longer fails for bots deployed on virtual machines when the VDI session is disconnected or is in a locked state, and the following token error message is no longer displayed: <code>An attempt was made to reference a token that does not exist.</code>
8098	00560593, 00585092	Universal Recorder is now aligned with the Bot Agent, so the recorder can capture objects on devices with any proxy server configuration.

Fixed features		
Build number	Service Cloud case ID	Description
8098	00675695	When you use the Excel advanced package, the bot now opens an Excel file without any issues. Previously, the bots failed to open an Excel file in some scenarios due to internal hardware components.
8098	00678567	CSV formulaic entries are no longer permitted in data fields of web applications, such as device names. These fields are limited to accept alphabetic characters, numbers, hyphen, and underscore entries only.
8098	00691551	Turkish characters are now supported in user names.

Known limitations
<p>When you update the Bot Agent from user level to system level, the user is unable to capture objects using recorder actions or from a window list in a Google Chrome browser.</p> <p>Workaround: Remove the registry entry for the user. Ensure the registry entry is in HKLM: Computer\HKEY_CURRENT_USER\SOFTWARE\Google\Chrome\NativeMessagingHost\Automation*.</p>
<p>When you uninstall the Bot Agent, the Bot Agent service and registry entry are not removed. Therefore, subsequent Bot Agent reinstallations fail.</p> <p>Workaround:</p> <ol style="list-style-type: none"> <li>1. Stop the Bot Agent service from the Task Manager.</li> <li>2. Delete the Bot Agent registry key from Computer\HKEY_LOCAL_MACHINE\SYSTEM\ControlSet001\Services\Automation Anywhere Bot Agent.</li> <li>3. Reinstall the Bot Agent.</li> </ol>
<p>When you install a Bot Agent at the user level, the user device is not registered as admin.</p> <p>Workaround: Before installing the Bot Agent, ensure that the user has write permission to the user profile folders (for example, C:\Program Files).</p>
<p>When you deploy a bot using a custom package and if the package has an object name with a semicolon (;) or percentage (%) character in it, the bot execution fails.</p> <p>Workaround: Do not use special characters such as a semicolon (;) or percentage (%) in the custom package name.</p>

Known limitations
<p>Limitation for multi-user deployments with auto-login</p> <p>If the auto-login setting in the Control Room is set to lock the session when the bot finishes executing from an existing unlocked session, deployments will fail when you deploy a bot on a multi-user device with non-admin user session and another admin user session is also active on the device.</p> <p>Workaround: Restart the Bot Agent service from the Windows Start menu and log off from the admin user session.</p>
<p>Bot Agent installation</p> <p>Starting from this release, when you install the Bot Agent at the local user level, keep the following in mind:</p> <ul style="list-style-type: none"><li>• You cannot install the Bot Agent at the user level if you log in to the device as the root administrator.</li><li>• Auto-login is not supported for local users and unattended Bot Runners.</li><li>• The auto-update feature for the Bot Agent will be applicable from the subsequent release because the option to install the Bot Agent at the local user level is introduced in this release.</li><li>• You cannot configure multi-user devices.</li><li>• Enterprise A2019 recorders for third-party applications:<ul style="list-style-type: none"><li>• No separate setup is required for JRE 6 and 7.</li><li>• Citrix XenApp is not supported because administrator privileges are required to set up Citrix.</li><li>• You must upgrade to the Enterprise A2019.19 Recorder package to use Discovery Bot.</li><li>• You must have write permission to AISense Recorder logs.</li></ul></li></ul>
<p>Bots encounter a Java heap space error when they use the Excel basic package to open an Excel file that is 20 MB or larger.</p> <p>Workaround: Increase the Java virtual machine heap space to 8 GB:</p> <ol style="list-style-type: none"><li>1. Navigate to <code>C:\Program Files\Automation Anywhere\Bot Agent\config</code>.</li><li>2. If it does not already exist, create a new text file named <code>nodemanager.properties</code>.</li><li>3. Open the file and copy the following text and paste it in the file: <code>bot.launcher.jvm.options=-Xmx8092m</code></li><li>4. Open Windows Services and restart the Bot Agent.</li></ol>
<p>Bots wait a maximum of 30 seconds for an object to appear in the Google Chrome browser, regardless of the value in the <b>Wait for control</b> field in the <b>Recorder &gt; Capture</b> action.</p>

Known limitations
<p>Limitations in Cloud migration</p> <ul style="list-style-type: none"><li>• The backup of the Enterprise 11 data created by the Cloud migration utility is not deleted when you close the Cloud migration utility after the Enterprise 11 data is uploaded to Cloud.</li><li>• Enterprise 11 bots that contain Japanese characters in their name encounter an error when you run these bots after they are migrated to Cloud.</li><li>• The Cloud migration utility does not show a validation error when you run the utility and the Automation Anywhere Control Room Reverse Proxy service is running if you have reinstalled Enterprise 11 Control Room using the same database that you have used in the previous Enterprise 11 instance.</li></ul>
<p>(Service Cloud case ID: 00737669) When you upgrade to this release, the Bot Agent is also updated. As a result, all the event triggers associated with Bot Runner (attended or unattended) users are stopped.</p> <p>Workaround: Bot Runner (attended and unattended) users must re-login to the Control Room to activate the associated event triggers.</p>
<p>Enterprise 11 bots that use identical names for variables that are differentiated by a hyphen or an underscore (for example, L-Lower and L_Lower) encounter an error when you run them after migrating to Enterprise A2019.</p> <p>Workaround: Update the name of one of the variables to a different name before migrating the bot.</p>
<p>String system variables do not function in Email action fields when the format is set to HTML.</p> <p>Workaround: Use HTML tags that perform the same function as the string variables. For example, instead of <code>String:Enter</code> or <code>String:Newline</code>, you can use the HTML tag <code>&lt;br&gt;</code>. Similarly, for the string variable <code>String:Tab</code>, you can enter <code>&amp;nbsp;</code>.</p>
<p>When you insert a variable into an action field that contains other content, the variable appears at the end of the content, regardless of the cursor position.</p> <p>Workaround: Highlight the variable name, and then cut and paste it to the correct position in the action field.</p>
<p>(Service Cloud case ID: 00781974) In a Linux environment, some of the Control Room log messages are stored in the <code>/var/log/messages</code> file instead of the <code>/var/log/automationanywhere</code> directory. As a result, disk space increases, and the services might stop when the disk space is full.</p> <p>Workaround: Clear the messages file regularly to avoid a disk storage issue.</p>

## Automation Co-Pilot for Business Users (Automation Co-Pilot)

New features
<p>New filter task in the process editor</p> <p>In the process editor, the <b>Filter Task</b> enables users to filter variables such as human or bot task output with a specific filter criterion.</p> <p><a href="#">Create a process automation in Process Composer</a> on page 3454</p>
<p>New process task in the process editor</p> <p>Use the new <b>Process Task</b> option in the process editor to call a subprocess within the main process. This feature enables you to separate tasks into different processes instead of including all the tasks in a single process. Multiple teams can now work at the same time on different tasks within the main process and remain segregated, without any conflicts.</p> <p><a href="#">Create a process automation in Process Composer</a> on page 3454</p>
<p>Hide a task or view a hidden task</p> <p>With a Bot Creator license, you can now perform the following:</p> <ul style="list-style-type: none"> <li>• Hide the display of human and bot tasks by selecting the <b>Hide this task after completion</b> option in the process editor.</li> <li>• View a hidden human or bot tasks by selecting the <b>View hidden tasks</b> option in the tasks view page.</li> </ul> <p><a href="#">Create a process automation in Process Composer</a> on page 3454</p>
<p>Edit title in process editor</p> <p>Users can now edit the title in the process editor.</p>
<p>Rich-text editor updates (web interface)</p> <p>In the web interface, you can use rich-text editor features such as bold text, italics, underline, alignment, formatting, color, and size in tasks.</p>
<p>Table element updates (web interface)</p> <p>In the web interface, the <b>Table</b> element now supports the use of date, number, drop-down, and text values in tasks.</p>
<p>Updates to elements in form builder</p> <p>The form builder now includes the following new elements:</p> <ul style="list-style-type: none"> <li>• <b>Select Folder</b> element: Add an upload folder option in the form. <a href="#">Using the Select Folder element</a> on page 3449</li> <li>• <b>Hyperlink</b> element: Assign a URL in the form. <a href="#">Using the Hyperlink element</a> on page 3443</li> </ul>

New features
<p>Enhancement to the Checkbox action trigger</p> <p>If a form with a <b>Checkbox</b> element is used within a trigger loop package, you can now use the <b>Value selected</b> and <b>Value unselected</b> trigger actions.</p> <p><a href="#">Trigger loop package</a> on page 3136</p>

Changed features
<p>Create and view requests (Automation Co-Pilot manager)</p> <p>An Automation Co-Pilot manager can create and view requests from processes that are assigned to the team they belong to or own. They can also create and view requests from processes that are assigned to themselves but not to the team.</p>
<p>Same device cannot be assigned to Bot Creator and unattended Bot Runner for triggers</p> <p>After you update to this Enterprise A2019 version from an earlier version, a default device that is assigned to a Bot Creator or an attended Bot Runner cannot be assigned to an unattended Bot Runner for deploying triggers.</p> <p>Recommended action: Use separate devices or device credentials (auto-login) for a Bot Creator and an attended Bot Runner as deployments can overlap or override across licenses.</p>
<p>Create a Request action URI</p> <p>The process selector in the <b>Create a Request</b> action is replaced with a public repository uniform resource identifier (URI).</p> <p><a href="#">Process Composer package</a> on page 2893</p>

Fixed features		
Build number	Service Cloud case ID	Description
8134	--	The table element now renders properly even when the <b>Row before scrolling</b> parameter value does not match the number of rows. Previously, the table did not render properly and displayed empty cells.
8122	--	When you check out a process, and add, modify, or remove tasks in the process editor, the dependencies are now correctly updated when the process is checked in.
8098	00707684, 00707688, 00707192, 00706781, 00707900, 00709109	All event triggers are now retained when you update to this version from an earlier version.

Fixed features		
Build number	Service Cloud case ID	Description
8098	--	In the process editor, undo and redo functions are now available for both canvas and properties panel interactions by default. Previously, the undo and redo functions were only available for canvas interactions.
8098	--	Previously during bot runtime, if you deleted all the existing rows from a table before adding a new row, the columns and rows of the table were misaligned. You can now drag and resize any column to reset the table alignment.
8098	--	All the trigger events within a form are now retained and no longer fail when the form is closed and reopened during bot runtime.
8098	--	In the process editor, if you replace the <b>Go to</b> option with an <b>End process</b> , the <b>End process</b> icon now displays the correct status (Completed, Failed, Canceled). Previously, the status was not displayed correctly and had to be changed manually by using the <b>End process</b> option.
8098	--	When you delete a request from the <b>Request</b> tab and it is sent to the recycle bin, the related task from the <b>Task</b> tab is now removed.
8098	--	When you filter your tasks in the <b>Task</b> tab, the results shown in the tab now retain the information when you navigate between different tabs.

Deprecated features
<p>Support removed for device pool configuration</p> <p>An Automation Co-Pilot administrator can no longer use the device pool configuration to deploy bots in a process. After upgrading to Enterprise A2019.19 from an earlier version, verify that the scheduler user configuration is set up in order to successfully execute your bots in the process.</p> <p><a href="#">Configure scheduler user for Automation Co-Pilot</a> on page 3413</p>



Known limitations
<p>When you create a request from a process (public or private) and enter all the required information in the initial form, the initial form cannot be submitted because the <b>Submit</b> option does not work. This issue occurs for all initial forms with at least one mandatory field.</p> <p>Workaround: Make all fields optional.</p>
<p>When you submit an initial form or task in a request view that contains a check box with at least two options and at least one option is selected, the check box value is not changed and defaults to a false Boolean value.</p>
<p>If the <b>Set</b> action is used immediately after a <b>Get</b> action, the value assigned to a variable using the <b>Get</b> action is not retrieved in the specified form element of the <b>Set</b> action during bot runtime.</p>
<p>An Automation Co-Pilot manager can create a request from a process that is assigned to them but not to their team. They can create and complete the request if the process contains only bot tasks. If the process contains a human task, the manager cannot assign the human task to themselves.</p> <p>Workaround: Assign the process to both the manager and their team.</p>
<p>In the process editor, the <b>Go To</b> option shows only the <b>Human Task</b> and <b>Bot Task</b>, it does not show the <b>Filter Task</b> or the <b>Process Task</b>.</p>
<p>(Service Cloud case ID: 00736309, 00765069, 00784362) If you use a file trigger for a document that is in .csv, .xlsx, or .xls format, the corresponding bot is not triggered when that document is modified.</p>

## Discovery Bot

New features
<p>View the duration of each recorded step</p> <p>A recorded step is now displayed in minutes and seconds for the business user and analyst. Use this information to understand which steps are a bottleneck in the current process and will provide most benefit from automation. The step duration is displayed from the <b>Recordings</b> page (below the screenshot image), and from the <b>View process</b> and <b>View opportunities</b> page from the Preview pane window.</p> <p><a href="#">Record a Discovery Bot business process</a> on page 3910</p>

Changed features
<p>Enhancement to the screenshot</p> <p>The screenshot image of the recorded step is now increased to full size for a more clear, detailed view of the recorded step.</p>

Fixed features	
Service Cloud case ID	Description
--	You can now click the <b>Screen</b> icon to display an image that you have hidden and saved. Previously, you had to click <b>Screen</b> and then click <b>Save</b> to display the image again.
--	When an opportunity is created for a system-generated view with filters applied, the filter now persists across the view displayed in the <b>Aggregated</b> tab from the <b>Opportunities</b> page. The filter is not reapplied on the view from the <b>Opportunities</b> page and the No recording data message is no longer displayed.
--	When you now cancel a recording, the recording is not displayed on the process tile in <b>Process Cycle</b> .
--	You can now approve a recording with 2000 steps. The Recording status is displayed as approved.

Known limitations
Actions such as double-click, drag-drop, click and hold, and text select are not supported when you are recording a business process.

## IQ Bot

New features
Support for variables in IQ Bot actions (Service Cloud case ID: 00511178) IQ Bot On-Premises and Cloud You can now use variables in the <b>Download all documents</b> and <b>Upload Document</b> actions in the IQ Bot package. <a href="#">Create a variable</a> on page 2336   <a href="#">IQ Bot package</a> on page 2758

Changed features
Rename a learning instance (Service Cloud case ID: 00675803) You can now rename a learning instance in staging in IQ Bot.

Changed features
<p>Sequential document processing (Service Cloud case ID: 00662968, 00665331)</p> <p>When you click <b>See Extraction Results</b>, IQ Bot now opens that request in a new browser tab where its number in the queue is displayed. This number keeps decreasing as the previous requests in queue are processed.</p>
<p>Dutch language support</p> <p>IQ Bot now supports the Dutch language with ABBYY FineReader Engine.</p>
<p>Configure OCR settings using REST APIs</p> <p>A user with AA IQ Bot Administrator role can now use the <code>appConfigurations</code> API to read and update the OCR settings.</p> <p><a href="#">Select an OCR engine</a></p>

Fixed features	
Service Cloud case ID	Description
00639117	Numeric format in the Polish language is now accepted in the IQ Bot Validator.
--	When you upload a document immediately after deleting a bot it was associated with, extraction results are now displayed irrespective of when the bot was deleted. Previously, an interval of 3 minutes was required to view the extraction results of the deleted bot.
00636899, 00683451	When you create a learning instance using the custom domain, the field names now appear correctly, irrespective of the custom domain language.
00459301, 00677204, 00532325, 00658245	Custom Python logic now displays extraction results in the Designer without any errors.
00657928, 00679540	Exported IQ Bot archive (.iqba) files no longer contain any unclassified records in the .csv files.
00704365	If documents uploaded during production have fewer pages than the staging documents that the bot was trained with, these production documents are now processed without any errors.
00703560, 0062442	When you migrate learning instances using the append option, all records are now correctly migrated, irrespective of the number of records in the IQBA file.

Fixed features	
Service Cloud case ID	Description
00715124	IQ Bot now deletes temporary files downloaded from Amazon S3 server in the C:\windows\temp\ folder when they are no longer required. As a result, storage is no longer consumed by these temporary files.
00686297	IQ Bot machine learning services are now correctly installed when you install IQ Bot.
00657928, 00679540, 00727633	You can now migrate learning instances to production, even if they contain unclassified documents.

Known limitations	
IQ Bot On-Premises and Cloud	If you click <b>See Extraction results</b> multiple times, the <b>Learning instances listing</b> page is opened instead of the extraction results.
IQ Bot On-Premises and Cloud	When creating a table on the <b>Designer</b> page, if you click <b>See Extraction results</b> without completing the table creation, extraction results are not displayed. Workaround: Create the table first and then click <b>See Extraction results</b> .
IQ Bot On-Premises and Cloud	An error message is displayed when you refresh the extraction results page for a learning instance when the associated bot is moved to production.
IQ Bot On-Premises and Cloud	When a bot is deleted, an incorrect error message is displayed when you click the <b>Test bot</b> option on the <b>Bots listing</b> page.
IQ Bot On-Premises and Cloud	If you rename a learning instance in production and download the files, all the files associated with the original learning instance are also downloaded. For example, if you rename a learning instance from Sales1 to Sales2, all the files associated with Sales1 are also downloaded when you download Sales2.
IQ Bot On-Premises and Cloud	If you have multiple learning instances and you click <b>See Extraction results</b> for all of them, the extraction results are not processed in the order of their request.
IQ Bot On-Premises and Cloud	When you create a learning instance with check box fields and run a Python script associated with the check box, an error message is displayed on the <b>Designer</b> page.

Known limitations
<p data-bbox="329 247 704 275">IQ Bot On-Premises and Cloud</p> <p data-bbox="329 296 1417 426">When you upload staging or production documents to a learning instance, temporary files are created in the C:\Windows\Temp folder, and the folder size might increase over a period of time. Therefore, manually delete the files from this folder because it can cause IQ Bot to stop responding.</p>
<p data-bbox="329 447 704 474">IQ Bot On-Premises and Cloud</p> <p data-bbox="329 495 1398 558">If you select the <b>Only for me</b> option when installing the Bot Agent, the <b>IQ Bot Extraction</b> action has the following issues:</p> <ul data-bbox="329 579 1109 642" style="list-style-type: none"><li data-bbox="329 579 927 606">• Takes a very long time to process a document.</li><li data-bbox="329 611 1109 642">• Some of the documents might not be processed successfully.</li></ul> <p data-bbox="329 678 1393 741">Workaround: During Bot Agent installation, choose the <b>Anyone who uses this computer (all users)</b> option.</p>
<p data-bbox="329 768 574 795">IQ Bot On-Premises</p> <p data-bbox="329 816 1398 911">(Service Cloud case: 00762174) Using the Database Migration Assistant to migrate from IQ Bot 11.x (five databases) to A2019 (unified database) in Microsoft Azure Database is not supported.</p>
<p data-bbox="329 936 704 963">IQ Bot On-Premises and Cloud</p> <p data-bbox="329 984 1378 1079">When you change the display language of any learning instance that has a document in Validator, although the selected display language is successfully applied to the learning instance, an error message is still displayed.</p>
<p data-bbox="329 1104 493 1131">IQ Bot Cloud</p> <p data-bbox="329 1152 1362 1247">The auto-correction and auto-suggestion features, which are part of the <b>MLScheduler</b> service, use system resources extensively and cause the system to slow down or stop responding.</p>
Deprecated features
<p data-bbox="329 1375 1159 1402">IQ Bot On-Premises is no longer supported on Windows Server 2012.</p>

## Bot Insight

Fixed features	
Service Cloud case ID	Description
00669196	When you apply date filters on a dashboard and then apply an attribute filter in the widget, the system now filters by a specific date. Previously, the date filter applied at the dashboard level was ignored when the attribute filter was selected at the widget level. As a result, historical data was also displayed.

**Important:** The supported packages information is moved to this topic: [Packages available in Automation 360](#) on page 2316.

## Enterprise A2019.18 Release Notes

Release date: 11 January 2021

Review the new features, changed features, fixed features, known limitations, and supported packages in the Enterprise A2019.18 (Build 7560) release. For IQ Bot, Build 7553 is available for Cloud customers and Build 7554 is available for On-Premises customers. There are no security fixes in this release.

**Important:** We have updated Enterprise A2019.18 to Build 7560 to include fixes for issues with workload management (Service Cloud case IDs 00696614 and 00703339) and SSO authentication on Automation Anywhere Cloud (Service Cloud case IDs 00706042, 00706074, 00706201, 00706195, 00706134, 00706022, and 00707033). See the [Fixed features](#) section for more information.

- [Migration features](#) on page 567
- [Enterprise A2019](#) on page 568
- [AARI](#)
- [Discovery Bot](#) on page 580
- [IQ Bot](#) on page 582
- [Bot Insight](#) on page 585
- [Supported packages](#) on page 585

## Migration features

Enterprise 11 and Enterprise 10 features
<p>Migrate MetaBots with screens</p> <p>Migrate MetaBots that contain screens as assets. You can migrate screens based on HTML, MSAA, and .NET technologies and captured using the <b>Object</b>, <b>Image</b>, and <b>Coordinate</b> play modes.</p>
<p>Configure timeout in Bot Migration package</p> <p>When migrating bots, you can now set a timeout value in the range of 3 through 90 minutes (default value is 90 minutes). If the migration of any specific bot is not completed within the set time, a timeout message is displayed and the migration process moves to the next bot.</p>
<p>Use regular expressions in variables (Service Cloud case ID: 00628227)</p> <p>Use regular expressions (regex) in value type variables to specify the entity on which you want to perform an operation. For example, actions in the File, Folder, String, and Window packages allow use of regular expression in variables.</p> <p>When Enterprise 11 or Enterprise 10 bots with commands that use regular expressions in variables are migrated, if their equivalent actions in Enterprise A2019 do not support regular expressions, the regular expression is converted to string in the migrated bots.</p>
<p>Migrate MetaBot that returns a list variable</p> <p>You can now migrate MetaBots that contain logic that return a list variable to the parent bot.</p>
<p>Migrate bots that use functional keys</p> <p>Migrate bots that use functional keys such as F1, F2, and F3 in the <b>Send Text</b> command.</p>
<p>Migrate bots that extract information from PDF</p> <p>Migrate bots that use the <b>Extract Form Fields</b> command to extract data from the fields in a PDF file.</p>

Enterprise 11 only features
<p>Migrate bots to Enterprise A2019 Cloud</p> <p>You can now migrate to Enterprise A2019 Cloud by using the Cloud Migration Utility. Use the utility to upload your Enterprise 11 data to Automation Anywhere Cloud.</p> <p><a href="#">Migrate from 11.x to Cloud</a></p>
<p>Migrate to Enterprise A2019 on Linux CentOS (Service Cloud case ID: 00654757)</p> <p>You can now migrate from Enterprise 11 to Enterprise A2019 installed on Linux CentOS.</p> <p><a href="#">Migrate to Linux CentOS</a></p>

Enterprise 11 only features
<p>Migrate imported Enterprise 11 bots to Enterprise A2019</p> <p>You can now migrate Enterprise 11 bots that you imported using the Bot Lifecycle Management feature or the Import API to Enterprise A2019 by using the migration wizard.</p>
<p>Migrate bots that use the following attributes:</p> <ul style="list-style-type: none"> <li>• Bots that use regular expression (regex) to search for the string and title of an application window on which you want to perform an operation</li> <li>• (Service Cloud case ID: 00616115) Bots for which custom format is configured for system dates</li> </ul> <p>The system uses the <b>AADefaultDateFormat</b> global value to store the format of the date.</p> <ul style="list-style-type: none"> <li>• Bots that use the <b>Search Field</b> command to search a field index or field name by using text in the Terminal Emulator</li> </ul>

## Enterprise A2019

**Important:** This release includes a required update to your . Ensure that you complete the update to continue with your automation activities when upgrading from a previous release to this release.

[Automatically update the Bot Agent](#) on page 1361 | [Manually update the Bot Agent](#) on page 1362

To verify which version is compatible with this release, see [Compatibility with release builds](#) on page 1333.

New features
<p>Create a Citizen Developer user</p> <p>Administrators can now use the Citizen Developer license to create Citizen Developer roles and users in the Control Room. Users with this license can create and run bots (including bots with triggers) on their devices.</p> <p><a href="#">Automation 360 licenses</a> on page 1407   <a href="#">Create a Citizen Developer role</a> on page 1764   <a href="#">Create a Citizen Developer user</a> on page 1745</p>
<p>Recorder enhancements</p> <ul style="list-style-type: none"> <li>• Use the AISense Recorder <b>Define</b> option to record an interaction, such as click active text, with an object that is only visible when you hover the mouse over the object.</li> <li>• If you record a click and keystrokes in a text box with a <b>Control Type</b> of <code>PASSWORD_TEXT</code>, the <b>Recorder</b> does not capture the keystrokes entered into the field. Instead, the action selects the <b>Set text</b> option and offers users the option to select a credential from the Credential Vault, enter a credential variable, or enter an insecure string.</li> </ul>



New features
<p>Export and import Bot Insight dashboards using Bot Lifecycle Management</p> <p>The Bot Lifecycle Management feature now enables you to export and import Bot Insight dashboards (default, custom, and published) associated with analytics bots from one Control Room instance to another. You can also export and import Bot Insight dashboards using the Bot Lifecycle Management export and import APIs.</p> <p><a href="#">Export bots</a> on page 2033   <a href="#">Import bots</a> on page 2035</p>
<p>Support for non-persistent VDI</p> <p>Non-persistent virtual desktop infrastructure (VDI) is now supported for temporary devices so that you can configure settings for temporary devices in the Control Room or during Bot Agent installation.</p> <p>The feature includes the following capabilities:</p> <ul style="list-style-type: none"> <li>• Automatically register a device.</li> <li>• Automatically mark a device as default for the logged-in user.</li> <li>• Automatically add a device to an existing pool.</li> <li>• Delete offline devices from a list of devices.</li> <li>• Add parameters for temporary devices in the Bot Agent MSI file.</li> </ul> <p><a href="#">Manage device settings</a> on page 1797   <a href="#">Configure temporary devices</a> on page 1803   <a href="#">Bulk install Bot Agent on devices</a> on page 1354</p>
<p>Efficiently map input and output variables between parent and child bots (Service Cloud case ID: 00537090, 00698697)</p> <p>For input variables, use the <b>Quick map</b> option to select the variables and set the values for the parent bot to pass. For output variables, use the <b>Multiple variables</b> tab to associate each dictionary key with a variable. This feature eliminates the need to use actions to extract the output dictionary values.</p> <p><a href="#">Task Bot package</a> on page 3109   <a href="#">Using the Run action</a> on page 3111</p>
<p>Support for PowerBuilder application in App Integration package (Service Cloud case ID: 00680703)</p> <p>The App Integration package now supports PowerBuilder to capture and extract text from a window application. The <b>Capture text of window</b> action enables you to open a PowerBuilder screen to capture all the data and verify the captured text.</p>
<p>Enhancements to check-out option in the private workspace</p> <ul style="list-style-type: none"> <li>• The <b>My bots</b> page in the private workspace displays a new status <b>Checked out edited</b> for bots that are checked out and edited.</li> <li>• Use the <b>Revert edits</b> option to cancel any changes you made to the checked-out bot in the private workspace.</li> </ul>
<p>Programmatically delete bots, files, and folders</p> <p>Use the <code>Delete files/folders</code> API to delete objects from the private or public workspace.</p> <pre>DELETE &lt;control_room_URL&gt;/v2/repository/files/{id}</pre>

New features
<p>Manage scheduled bots using APIs</p> <p>Use the <b>Bot Scheduler</b> APIs to create, update, and view details, and delete bot schedules. Bots can be scheduled to run at a specific date and time on an unattended Bot Runner, or on a recurring basis.</p>
<p>New action in Terminal Emulator package</p> <p>Use the <b>Search Field</b> action in the Terminal Emulator package to search for a field based on the text it contains. This action returns the name or index of the field based on the option selected.</p> <p><a href="#">Terminal Emulator package</a> on page 3117</p>
<p>New action in PDF package</p> <p>Use the <b>Get Property</b> action in the PDF package to retrieve the properties of a PDF file and assigns the properties to a dictionary variable.</p> <p><a href="#">Using the Get property action</a> on page 2885</p>
<p>New actions in Browser package</p> <p>Use the following actions in the Browser package:</p> <ul style="list-style-type: none"> <li>• <b>Close:</b> Closes a Google Chrome browser window or tab.</li> <li>• <b>Get source code:</b> Retrieves the source code of a web page and saves it to a string variable.</li> <li>• <b>Go back:</b> Returns to a web page that you previously visited in the current tab.</li> <li>• <b>Open:</b> Opens the browser to a specific web page in an existing tab, new tab, or window.</li> <li>• <b>Run JavaScript:</b> Executes JavaScript in a web page.</li> </ul> <p><a href="#">Browser package</a> on page 2435</p>
<p>Specify application window dimensions</p> <p>Use the <b>Resize windows</b> option to set the window height and width to specific dimensions or to the dimensions at which it was captured. This feature enhances the bot's ability to identify the target object.</p> <p>The following packages support this feature:</p> <ul style="list-style-type: none"> <li>• App Integration</li> <li>• If <b>Image recognition</b> condition</li> <li>• If <b>Legacy Automation &gt; Window Control</b> condition</li> <li>• Image Recognition</li> <li>• Simulate keystrokes</li> <li>• Legacy Automation <b>Desktop &gt; Manage windows controls</b> action</li> <li>• Loop <b>While &gt; Image recognition</b> condition</li> <li>• Loop <b>While &gt; Legacy Automation &gt; Window Control</b> condition</li> <li>• Mouse</li> <li>• OCR</li> <li>• Screen</li> </ul>

New features
<p>Support for function keys in Terminal Emulator package</p> <p>Function keys (F1 through F24) are now supported to automate processes using ANSI and VT100 terminals in the Terminal Emulator package.</p>
<p>Use regex case insensitive flag for Window title</p> <p>Enable the regex <b>Case insensitive</b> flag to identify a <b>Window title</b> field as not case-sensitive. This feature enables you to successfully run the bots even if the letter case does not match the captured window title.</p> <p>The following packages and actions support this feature:</p> <ul style="list-style-type: none"> <li>• Wait</li> <li>• Image Recognition</li> <li>• Simulate keystrokes</li> <li>• Mouse &gt; <b>Click</b> action</li> <li>• Legacy Automation <b>Desktop &gt; Manage windows controls</b></li> <li>• OCR &gt; <b>Capture window, Capture area</b></li> <li>• Screen &gt; <b>Capture window, Capture area</b></li> <li>• Recorder &gt; <b>Capture</b></li> <li>• Window: <b>Activate, Close, Maximize, Minimize, Resize</b></li> </ul>
<p>Unattended Bot Runner supported on Citrix devices</p> <p>You can now deploy bots on unattended Bot Runners on virtual machines on Citrix XenDesktop and Citrix VDI Windows 2016.</p>

Changed features
<p>Only Bot Scanner related files and folders are deleted</p> <p>The Bot Scanner now deletes only Bot Scanner related files and folders from the destination folder.</p> <p><a href="#">Scan Enterprise 11 or 10 bots using Bot Scanner</a> on page 1531</p>
<p>Enhanced transport layer security (Service Cloud case ID: 00677546, 00681830)</p> <p>The default Elasticsearch ports (47599, 47600) now use the more secure TLS version 1.2 and later as the communication channel between the Control Room and Elasticsearch server.</p>
<p>Enhanced Update node action in XML package (Service Cloud case ID: 00663089)</p> <p>When you edit and save an XML node, the bot updates the required attributes and their values in an alphabetical order, without removing any existing attributes of the node.</p> <p>For example, consider two existing attributes in an XML node such as <code>Name=Peter</code> and <code>Phone=9829xxxxxx</code>. If you change the value of the phone attribute as <code>9887xxxxxx</code> and add a new attribute <code>Gender</code> with value as <code>Male</code>, the bot updates the phone value and adds the gender as a new attribute, without removing the existing name attribute.</p>

Changed features
<p>Interface change in Excel basic and Excel advanced packages</p> <p>The <b>session name</b> field is now the last field in actions in the Excel basic and Excel advanced packages.</p>
<p>Access at subfolder level in Control Room repository (Service Cloud case ID: 00634847, 00681221, 00685654)</p> <p>An administrator can now allow access at the subfolder level in the Control Room by assigning the <b>Run, Check-in</b> and <b>Check-out</b> permissions to the subfolder. You can only access the contents of the subfolder and not the other bots or files in the parent folder.</p>
<p>Increased working area in the Bot editor</p> <p>More horizontal and vertical screen area is available in the Bot editor for developing bots. You can hide or display the <b>Actions</b> and <b>Details</b> panels to maximize the working area in the Bot editor.</p>

The following table lists the fixed features and the builds in which they were fixed (Build 7560 is the latest build, and Build 7554 is the previous build). The fixes are cumulatively available in the latest build.

Fixed features		
Build number	Service Cloud case ID	Description
7560	00696614	Bot deployment is no longer delayed after you insert Work Items if idle devices are available for the deployment in queues.
7560	00703339	The post Work Item insertion flow is now improved so that bot deployments are not delayed.
7560	00706042, 00706074, 00706201, 00706195, 00706134, 00706022, 00707033	An issue with Control Room login page not supporting SAML for SSO and reporting an errant IPD response has been addressed. The SSO function of the Control Room login works as expected.
7554	00659336	Enterprise 11 bots that use the Image Recognition command or <b>Image Recognition</b> condition of the If command now run successfully after migration.
7554	00647634	The Bot Scanner no longer becomes unresponsive when scanning a large repository.
7554	00678614	An error is no longer encountered when you migrate a bot with a credential name that contains a space character or a special character.

Fixed features		
Build number	Service Cloud case ID	Description
7554	00669247	An error is no longer encountered when you download a file from a URL that contains a Unicode character using the <b>Download files</b> action of the Browser package.
7554	00685916	If you have used the <b>Date</b> system variable as an input variable in a MetaBot, the <b>Date</b> system variable is now available after migration.
7554	00674594	The Bot Scanner no longer encounters an error when scanning a bot that uses the <b>Excel Column</b> system variable after the Loop command and the column name specified in that variable contains a space character.
7554	00691905	An error is no longer encountered when you edit a user after migrating to Enterprise A2019 from Version 11.3.3.
7554	00691072	An error is no longer encountered because of the bypass configuration of proxy settings when you use the Bot Migration Wizard.
7554	00689910	You can now import more than 2100 bot files without any SQL exception error.
7554	00669927	When you execute the Bot Insight <b>Business Data</b> and <b>Operations Data</b> APIs, only information limited to the logged-in tenant is now retrieved in the API response.
7554	00639779	After you log in to the Control Room and connect manually to a VPN, the Bot Agent now reconnects automatically. You do not have to restart the Bot Agent service to reconnect.
7554	00622075	When you run a bot on a user device that has an extended display, the runtime window is now completely visible on the main display. Previously, the window was partially visible between the main and extended display.
7554	00678454	In Excel advanced, you can now use the <b>Set cell</b> action to write more than 4100 characters in the excel file. Previously, the bot execution failed when the cell value had more than 4100 characters.

Fixed features		
Build number	Service Cloud case ID	Description
7554	00675333	In the Number package, the field in the <b>Assign</b> action is now corrected as <b>Select the source number variable/ value</b> . Previously, the <b>Select the source string variable/ value</b> field was incorrect.
7554	00674315, 00677925, 00684201	When you create a Task Bot using the <b>If</b> and <b>Else if</b> actions and change the placement of the <b>Else if</b> block action, there is improved visibility in the <b>Flow</b> view. Previously, the Task Bot was not displayed properly on a low contrast display when the <b>Else if</b> block placement was changed.
7554	00662072, 00674336	In the Terminal Emulator package, you can now correctly page up using the KEY_PGUP function key and page down using KEY_PGDOWN for the <b>TN5250</b> terminal type.
7554	00658261	The PDF <b>Extract image</b> action now supports CMYK (cyan, magenta, yellow, black) images format when you extract and save a CMYK image to an RGB (red, green, and blue) image. Previously, if PDF files contained CMYK images, the bot could not extract them and displayed an error.
7554	00675749	When you receive emails using the EWS server option, the <code>emailCc</code> and <code>emailTo</code> variables now return the proper value. Previously, these variables returned blank values.
7554	00663610	In the Ftp/Sftp package, you can now connect to <code>ftp.box.com</code> and use the <b>Get folder</b> action. Previously, the <b>Get folder</b> action downloaded files in the folder, causing the bot to run in an infinite loop.
7554	00675710	In the Data Table package, the <b>Remove duplicate rows</b> action now removes all duplicate rows rather than a single duplicate row.
7554	00539762	In the <b>For value</b> action of the Prompt package, characters are no longer visible during keystrokes of masked values.
7554	00679370, 00673085, 00674546, 00676912, 00678852, 00678796, 00692420, 00695390	An unknown error is no longer encountered when you run the <b>Open</b> Excel file action from a network drive.

Fixed features		
Build number	Service Cloud case ID	Description
7554	00672719, 00673048	Audit log entries in the Control Room are now retained even if the Elasticsearch data is configured to a file path other than c:\ (C drive) during installation.
7554	--	You can now insert Work Items from one queue to another queue for workload automation.
7554	--	You no longer have to pause and resume queues because Work Items are now processed and not randomly skipped when you use the priority queuing or round-robin method for workload automation.
7554	--	The Recorder package no longer takes time to upload to a remote application repository path of an On-Premises Control Room deployed on Microsoft Azure.
7554	00683744	You can now capture objects from the Google Chrome browser using the Recorder capture action. The plug-in not installed or disabled error is no longer displayed.
7554	00672446, 00671782, 00671065, 00683870	When you upgrade to this release from an earlier release (for example, Enterprise A2019.16), the Elasticsearch OpenDistro error message is no longer displayed. Also, the previous <code>application_log</code> indices from Elasticsearch are deleted to free up disk space for the upgrade.
7554	00690003	You can now use the Terminal Emulator package without any change in the screen resolution for the mainframe terminal type TN3270. Previously, the screen resolution was not supported for terminal type TN3270.
7554	00679244	In Dictionary and List packages, you can now use the <b>Datetime</b> data type in the source dictionary variable field of the <b>Assign</b> action. Previously, an error was encountered during bot execution if you used <b>Datetime</b> data type in the source dictionary variable field.
7554	00673591	Fixed an issue in the Task Bot package where the system selected all the input variable options when the user clicked away from and returned to the action.

Fixed features		
Build number	Service Cloud case ID	Description
7554	00684905, 00703481	A Task Bot now runs as scheduled and no longer shows the device status as <b>Picked at runtime</b> on the <b>View task in progress</b> (Activity) page when the Task Bot is running.
7554	00573081	The audit log page in the Control Room now records all entries related to bot deployment. Also, when a parent task with many child bots is deployed, the audit log now shows correct entries. Previously, some audit log entries were missing for bot deployment and if a parent task with many child bots was deployed, the entries displayed were incorrect.

Known limitations
Enterprise A2019 does not yet support the counter behavior of the \$Excel Cell Row\$ system variable in Enterprise 11 when the variable is used in the Loop command and the <b>Each row in Excel Dataset</b> option is selected. This behavior is available in 11.3.0 and earlier versions by default, and in the Version 11.3.1.2 and later versions when the <code>retainexcelcellrowlegacybehavior</code> tag in the <code>AASettings.xml</code> file is set to true.
A bot fails when it runs an action that reloads the web page, such as the <b>Recorder &gt; Capture</b> action when it is used to click a link or the <b>Browser &gt; Open</b> action, followed by a <b>Browser &gt; Run JavaScript</b> or <b>Browser &gt; Extract source</b> action.  You must add a delay of at least 5 seconds to give the browser time to load.
A bot fails when it runs the <b>Browser &gt; Close</b> action to close the last Google Chrome window and the window contains only one tab.  Use the <b>Tab</b> or <b>All browsers</b> options instead.
A bot can return only a maximum of 3 MB to an output variable.  Workaround: Store the bot output on the device, such as in a .txt file. If the output must be shared across multiple Bot Runners, store the output in a shared drive.
The AISense Recorder fails if you manually upgrade the Recorder package version, such as by importing a bot that contains a Recorder package version from a more recent build than the destination Control Room. Always upgrade the Recorder package through the Control Room.
If you install the Google Chrome extension in the Microsoft Edge browser, it causes recording and runtime errors in bots that interact with the Google Chrome browser. Even if you did not manually install the Google Chrome extension, the auto-sync settings in the Microsoft Edge browser might have automatically installed the extension.  If the Google Chrome extension is installed in the Microsoft Edge browser, you must remove the Google Chrome extension from the <code>edge://extensions</code> page.



Known limitations
<p>When the regex <b>Case insensitive</b> flag is enabled for actions that include the window title, a recapture of the application window fails.</p>
<p>The input parameters for DLLs are not automatically passed from the parent bot to the child bot in Enterprise A2019 for migrated MetaBots.</p>
<p>Workload automation limitation for manual Credential Vault mode (Service Cloud case ID: 00711410)</p> <p>You might face issues when migrating your workload automation if the Control Room is configured to use a manual mode for Credential Vault.</p> <p>Workaround: As the Control Room administrator, perform the following steps:</p> <ol style="list-style-type: none"> <li>1. Change the Credential Vault mode to express from manual in the Control Room database configuration table.</li> <li>2. Add the credential vault key to the <code>CredentialVault.dat</code> file in the Control Room server repository.</li> <li>3. Restart the Automation Anywhere Control Room Service.</li> <li>4. Re-register the Bot Agent or restart the Bot Agent service.</li> </ol>
<p>Cloud migration limitations</p> <ul style="list-style-type: none"> <li>• The Cloud migration utility keeps running in background if you close the utility when the Enterprise 11 data is being uploaded.</li> <li>• If you have configured Enterprise 11 Control Room in cluster mode, you must stop the Automation Anywhere Control Room Service on all the nodes available in the cluster.</li> <li>• If the Cloud migration utility is installed on a different device than the device on which the Enterprise 11 Control Room you want to migrate is installed, an Elasticsearch unavailable error occurs.</li> <li>• If you have SSO configured on the Enterprise 11 Control Room, an error is encountered after migration to Cloud if you change the authentication from database to SSO.</li> <li>• If you provide the validation code within double quotation marks, the utility successfully validates the code but fails when uploading the Enterprise 11 data.</li> </ul>
<p>If you open a table variable for editing and then open another table variable and click <b>Cancel</b> in the <b>Edit table</b> window, the schema of that table reverts to the same schema of the first table. This occurs only in the interface; it does not impact the bot.</p> <p>Workaround: Refresh the window containing the Control Room.</p>
<p>If you use different versions of a package in a parent bot and a child bot, the capability to share a session across bots is currently not supported in the following packages: DLL, Excel advanced, Excel basic, and Terminal Emulator</p> <p>To share a session across parent and child bots, ensure that you use the same version of the package in both the parent and child bots.</p>

## Automation Co-Pilot for Business Users (Automation Co-Pilot)

New features
<p>New Automation Co-Pilot on the web package</p> <p>Use the Automation Co-Pilot on the web package to perform actions such as assign, query, and cancel tasks; create and query requests; and retrieve a list of team members.</p> <p><a href="#">Process Composer package</a> on page 2893</p>
<p>Filter by time</p> <p>You can now filter your requests and tasks by time:</p> <ul style="list-style-type: none"> <li>• <b>Requests</b> tab: Use the <b>Created</b> and <b>Updated</b> options in the <b>Filter</b> window to select any dates.</li> <li>• <b>Tasks</b> tab: Use the <b>Task created</b> and <b>Task updated</b> options in the <b>Filter</b> window to select any dates.</li> </ul> <p><a href="#">Filter and search for a request</a> on page 3391   <a href="#">Filter and search for a task</a> on page 3393</p>
<p>View updated dates</p> <ul style="list-style-type: none"> <li>• Use the new <b>Updated</b> column in the <b>Requests</b> tab to view the dates and time of a request that was last updated.</li> <li>• Use the new <b>Task Updated</b> column in the <b>Tasks</b> tab to view the date and time of a task that was last updated.</li> </ul>
<p>Variable options</p> <p>In the <b>Insert a variable</b> window, the <b>Variable</b> field now shows child elements of available references, which include <b>Dictionary</b>, <b>List</b>, <b>Record</b>, and <b>Table</b> variable types.</p>
<p>Delete a request</p> <p>Automation Co-Pilot administrators, managers, and users can now delete requests created by the Automation Co-Pilot process. The Automation Co-Pilot administrator can delete any requests. Automation Co-Pilot managers can delete requests of the team for which they are the owner. Automation Co-Pilot users can delete only the requests they have created.</p> <p><a href="#">Delete a request</a> on page 3385</p>
<p>Automatically assign managers and users</p> <p>Users can now select the <b>Auto assign this task</b> option in the <b>Human Task</b> to assign managers or users to the task. Users can also select the <b>Auto assign the target task to</b> option in the <b>Go to</b> element to assign managers to the task.</p> <p><a href="#">Create a process automation in Process Composer</a> on page 3454</p>

**New features**

Enhancements to elements in the form builder

- **Time** element: Includes the time element in a form.  
[Using the Time element](#) on page 3453
- **Date** element: Set the date format of the user machine as the default format for the date element in the form.  
[Using the Date element](#) on page 3440
- **Select file** element: Drag the selected file into the form during bot runtime.  
[Using the Select File element](#) on page 3448
- **Password** element: View the password you enter in this field during bot runtime.  
[Using the Password element](#) on page 3446

Updates to interactive forms

- Use the **Change Form Title** to edit or change the title of the selected form during bot runtime.
- Use the **Validate form** option now for the **Table** element.

[Interactive forms package](#) on page 2738

**Changed features**

Process package renamed to Automation Co-Pilot on the web package

The **Process** package is now renamed to the Automation Co-Pilot on the web package, which includes the **Create a Request** action and additional new actions.

[AARI web package](#)

Enhancement to process management page

In the process management page, the Automation Co-Pilot admin can now edit the **Process Title** and **Process Description** metadata. You can now add a title and provide a short description for the process.

Enhancement to the activity page

All the Bot Runner (attended or unattended) trigger deployments in queue are now displayed in the **Activity > In progress** page.

[Activities](#) on page 2121

Edit check box, radio button, and drop-down form elements in process editor

In the process editor, you can now edit and update the **List of options** and **Default value** fields for the following form elements: **Checkbox**, **Radio button**, and **Dropdown**.

Fixed features	
Service Cloud case ID	Description
00678572	You can now view the <b>strict-transport-security</b> header when using the Automation Co-Pilot on the web interface. This attribute informs the web browser to automatically convert websites requesting HTTP to load HTTPS instead in order to comply with the HTTP Strict-Transport-Security (HSTS) policy.
--	The <b>Display message</b> field in the <b>If/Else</b> pair action now displays the status message in request view. Previously, the status message was not displayed in the request view.
--	When you access Automation Co-Pilot through the web interface, the <b>Request ID</b> and <b>Task ID</b> now correctly identify the data as numeric data type and sort it accordingly. Previously, the data was considered as string type and the sorting was not appropriate.
00646148	A bot is no longer deployed multiple times when the files and folders triggers are used.

Known limitations
When a user with a Citizen Developer license deletes an event trigger, this activity is not captured in the <b>Audit log</b> tab.
When you delete a request from the <b>Request</b> tab, the tasks associated with the request are not deleted and they are displayed in the <b>Tasks</b> tab.
If you click the refresh option in the <b>Tasks</b> tab and navigate away and back to the tab, the task filter applied does not remain the same. The filter always switches to <b>Pending</b> status.

## Discovery Bot

New features
<p>Use Model option for system-generated views</p> <p>You can now use the <b>Model</b> option to compare and find the best aggregated view for your recordings. Use this option to save as many views with different combinations as required.</p> <p>You can also save the view as a manual view to further customize your view and compare side-by-side. Select either an <b>Easy</b> or <b>Strict</b> model so that you can view recordings where the steps are the same versus recordings with different results with more branches in the process path.</p> <p><a href="#">Create a process view with branches and opportunities</a></p>

New features
<p>Use Filter option for system-generated views</p> <p>You can now use the <b>Filter</b> option to use a set of values to compare different sections of a process across various recordings by selecting a specific path and step filter. Used along with the <b>Model</b> option, the path and step filter options for a system-generated or manual view can help you to determine and decide on a good candidate for automation.</p> <p><a href="#">Create a process view with branches and opportunities</a></p>
<p>Use toggle frequency counter option for system-generated views</p> <p>You can now use the toggle frequency counter to display the number of recordings that a particular path takes in the flow in a system-generated view. Use this option to help you understand the frequency of the path compared to other recordings or views.</p> <p><a href="#">Create a process view with branches and opportunities</a></p>
<p>Remove recording screenshot for data privacy</p> <p>Use the <b>Screen</b> option (icon) to display or hide the recording screenshot before submitting the recording for the analyst to review. Use this option when you do not want to share personal image details with the analyst.</p> <p><a href="#">Record a Discovery Bot business process</a> on page 3910</p>
<p>Download PDD from the Opportunities table</p> <p>You can now download a process definition document (PDD) for an opportunity directly from the Opportunities table listed on the <b>Opportunities</b> page. The PDD is automatically generated when the opportunity is created. After the PDD is generated, the field changes from generating PDD to <b>Download PDD</b>. You can then download and save the document.</p> <p><a href="#">Review opportunities and convert to</a></p>

Changed features
<p>Screenshot image is increased</p> <p>The screenshot image is now increased to allow for better readability of captured steps. You can now use the scroll wheel to get a zoomed-in view of the step.</p>
<p>The <b>Export to Word</b> option now supports 2000 steps.</p>
<p>The <b>Convert to Bot</b> option now supports 2000 steps.</p>

Fixed features	
Service Cloud case ID	Description
--	The <b>Delete</b> icon is now properly visible in the edit recordings screen in Internet Explorer.

Fixed features	
Service Cloud case ID	Description
--	You can now change the zoom level in any canvas using the two-finger swipe on the trackpad of the <b>Aggregated</b> and <b>Comparison</b> tabs.
--	The red highlight is now visible on the captured screenshots from the <b>Recordings</b> page and from the preview pane from the <b>Aggregated</b> and <b>Opportunity</b> tabs for analyst review.

Known limitations
When upgrading to this release, you must regenerate all PDDs created in Enterprise A2019.17. Click <b>Retry PDD Generation</b> to regenerate the PDDs.
If you want to display an image that you have hidden and saved, you must first click the <b>Screen</b> icon and then click <b>Save</b> to display the image again.
In the <b>Opportunities</b> table, the search field and filter drop-down option are not available for the <b>Process</b> and <b>Owner</b> columns.
When an opportunity is created for a system-generated view with filters applied, the filter is reapplied on the view displayed within the <b>Aggregated</b> tab from the Opportunities page. The filter incorrectly displays No recording data. The <b>Convert to Bot</b> and the <b>Download PDD</b> options are not affected.
When a recording is canceled, the recording is incorrectly incremented and displayed on the process tile in <b>Process Cycle</b> .
You cannot approve a recording with more than 500 steps.

## IQ Bot

New features
<p>New IQ Bot Extraction package</p> <p>On-Premises and Cloud</p> <p>IQ Bot now includes the IQ Bot Extraction package for processing invoices. The package uses Bot Runners on your local device instead of an IQ Bot server for processing.</p> <p><a href="#">IQ Bot Extraction package</a> on page 2749</p>

Changed features
<p>Enhancement to Migration Utility</p> <p>When you now export an IQ Bot archive (.iqba) file, only a single document associated with every available bot (group) training is exported.</p>
<p>Enhancement to Document Classifier package</p> <p>The Document Classifier package now supports all languages supported by ABBYY FineReader Engine. Previously, only English language was supported.</p> <p><a href="#">ABBYY FineReader Engine OCR supported languages</a></p>

Fixed features	
Service Cloud case ID	Description
00668625	When you upload documents containing digital signatures to learning instances, the Designer now displays the correct success or error message.
00619139, 00695157	When you now run a bot and try to edit it while it is still running, the following correct message is displayed: <code>Staging Documents for this Vision bot is in progress. Please try after some time.</code> Previously, the following incorrect message was displayed: <code>Learning instance not found.</code>
00408482	You can now successfully export a custom domain created using Korean or other Asian languages.
00669197, 00681599	Node.js is now upgraded to version v10.22.1 to fix a security vulnerability.
--	Fixed an issue that caused the following error: <code>failed to upgrade DB -1.</code> You can now install IQ Bot in express mode without any errors.
00633197	During validation, if there is an error in the validation pattern, the validation process now fails, the correct message is displayed, and error logs are generated.
00689326	You can now view the extraction results correctly even when the bot is trained with check box fields.
00666456	IQ Bot machine learning services are now correctly installed when you install IQ Bot.

Known limitations
<p data-bbox="329 245 704 275">IQ Bot On-Premises and Cloud</p> <p data-bbox="329 296 1092 325">The following limitations apply to the IQ Bot Extraction package:</p> <ul data-bbox="329 342 1406 541" style="list-style-type: none"> <li data-bbox="329 342 1341 405">• If you process documents that do not belong to any created groups, they are not displayed in the <b>Details</b> page of the learning instance.</li> <li data-bbox="329 411 967 441">• The <b>Checkbox</b> extraction option is not supported.</li> <li data-bbox="329 447 1406 510">• Some of the input invoices are not processed when you set up workload management with shared input and output folders.</li> <li data-bbox="329 516 1065 541">• Pre-processing settings from IQ Bot server are not applied.</li> </ul>
<p data-bbox="329 590 704 619">IQ Bot On-Premises and Cloud</p> <p data-bbox="329 640 1401 703">When creating learning instances, IQ Bot sometimes does not restrict users from creating duplicate fields.</p>
<p data-bbox="329 726 704 756">IQ Bot On-Premises and Cloud</p> <p data-bbox="329 777 1360 806">Occasionally IQ Bot fails to execute Python logic for tables other than the default one.</p> <p data-bbox="329 827 1125 856">Workaround: Retry after you perform one of the following actions:</p> <ul data-bbox="329 873 711 936" style="list-style-type: none"> <li data-bbox="329 873 621 903">• Click <b>Save and close</b>.</li> <li data-bbox="329 909 711 936">• Click <b>See Extraction results</b>.</li> </ul>
<p data-bbox="329 984 704 1014">IQ Bot On-Premises and Cloud</p> <p data-bbox="329 1035 1325 1098">In PDF documents containing multiple pages, at times the segments do not display correctly on all pages.</p> <p data-bbox="329 1119 1036 1148">Workaround: Use PDFBox OCR to process the documents.</p>
<p data-bbox="329 1169 704 1199">IQ Bot On-Premises and Cloud</p> <p data-bbox="329 1220 1398 1314">For the <b>Get page content</b> action of the IQ Bot Pre-processor package, if you select the <b>Create variable</b> option from the <b>List of strings extracted from page</b> menu, you can only use <b>Any</b> from the <b>Subtype</b> drop-down menu.</p>
<p data-bbox="329 1341 951 1371">IQ Bot Community Edition, On-Premises and Cloud</p> <p data-bbox="329 1392 1300 1486">If you use Internet Explorer version 11.0.973.17763 to log in to IQ Bot and open <b>See extraction results</b> for a learning instance, you cannot open or download the <code>Preview.csv</code> file.</p>
<p data-bbox="329 1514 573 1543">IQ Bot On-Premises</p> <p data-bbox="329 1564 1195 1593">You must be a service account user to install IQ Bot on a fresh machine.</p>
<p data-bbox="329 1614 699 1644">IQ Bot On-Premises and Cloud</p> <p data-bbox="329 1665 1360 1759">The auto-correction and auto-suggestion features, which are part of the <b>MLScheduler</b> service, use system resources extensively and cause the system to slow down or stop responding.</p>



## Bot Insight

New features
<p>Access Bot Insight data from Tableau</p> <p>Use the Tableau connector in Bot Insight to access business and operational information. The Tableau connector connects to the Bot Insight APIs to create various business and operational metrics that you can analyze and visualize within Tableau.</p> <p><a href="#">Configure Tableau web data connector in Bot Insight</a> on page 3959</p>
<p>Assign Bot Insight license (Service Cloud case ID: 00651973)</p> <p>Assign the Bot Insight license to users to enable them to view and perform tasks on the <b>Business</b> dashboard. You can now assign the license on a per-user basis, irrespective of the assigned roles.</p> <p><a href="#">Automation 360 licenses</a> on page 1407</p>

Fixed features	
Service Cloud case ID	Description
00689802	You no longer encounter an issue when you create and view default dashboards in a development (dev) environment. Previously, an error was displayed when you open the bot and clicked <b>Analyze</b> to create the default dashboard.

## Supported packages

Package	Version
Application	2.1.0-20201112-22332
App Integration	2.3.0-20201210-171315
Active Directory	2.1.0-20201112-223323
Boolean	2.1.0-20201126-165109
Browser	2.3.0-20201211-222811
Clipboard	2.1.0-20201126-165124
Comment	2.3.0-20201126-165125
CSV/TXT	2.3.0-20201126-165126
Database	2.2.0-20201112-223343
Data Table	2.5.0-20201201-130615
Datetime	2.2.0-20201126-165136

Package	Version
Delay	2.2.0-20201126-165137
Dictionary	3.2.0-20201126-165138
Run DLL	3.3.0-20201126-165850
Email	3.2.0-20201120-062604
Error handler	2.3.0-20201126-165148
Excel basic	2.4.0-20201126-165604
Excel advanced	5.3.0-20201208-090251
File	3.2.0-20201126-165151
Folder	3.1.0-20201126-165154
FTP / SFTP	2.2.0-20201115-072759
Image Recognition	2.2.0-20201117-081754
JavaScript	2.4.0-20201126-165412
Simulate keystrokes	2.5.0-20201112-223902
Legacy Automation	3.2.0-20201124-064544 1.5.0-20201125-004358
List	2.2.0-20201126-165427
Log To File	2.2.0-20201126-165428
Loop	2.1.0-20201126-165429
Message Box	2.1.0-20201126-165430
Mouse	2.2.0-20201112-223917
Number	2.1.0-20201126-165444
OCR	2.3.0-20201126-081210
Microsoft 365 Excel	2.2.0-20201104-062559
Microsoft 365 Calendar	2.1.0-20201111-162101
Microsoft 365 OneDrive	2.2.0-20201126-165550
PDF	2.6.0-20201126-165555
PGP	2.2.0-20201126-165557
Ping	2.1.0-20201126-165559
Play Sound	2.1.0-20201127-115706
Prompt	2.2.0-20201109-192507
Python Script	2.4.0-20201208-064944
Recorder	2.10-20201215-211402
REST Web Service	3.2.0-20201112-224735

Package	Version
SAP	2.2.0-20201126-165852
Screen	2.2.0-20201126-165855
SNMP	2.1.0-20201126-165859
SOAP Web Service	3.2.0-20201123-093411
String	3.1.0-20201126-165909
System	3.0.0-20200921-090225
Terminal Emulator	3.6.0-20201213-084139
VBScript	2.4.0-20201208-065526
Wait	3.1.0-20201126-165922
Window	2.3.0-20201123-093430
Workload	2.1.0-20200825-071644
XML	2.1.0-20201126-165927

Related reference

[Community Edition A2019.18 Release Notes](#) on page 819

## Enterprise A2019.17 Release Notes

Release date: 2 December 2020

Review the new features, changed features, fixed features, security fixes, known limitations, and supported packages in the Enterprise A2019.17 (Build 7103) release. IQ Bot is on Build 7082.

- [Enterprise A2019](#)
- [AARI](#)
- [Discovery Bot](#)
- [IQ Bot](#)
- [Bot Insight](#) on page 614
- [Supported packages](#)

### Migration features

---

**Important:** Migration to Enterprise A2019 (currently available only to customers in the Migration Early Adopter Program)

Migration to Enterprise A2019 is currently only available to select customers through our Migration Early Adopter Program. If you are interested in learning more about this program or a timeline for when migration will be available to all customers, contact your Automation Anywhere representative.

---

The following features apply to both Enterprise 11 and Enterprise 10 :

Obtain information about upcoming support for commands and variables	Bot Scanner provides information about the upcoming Enterprise A2019 release in which a specific command or variable will be supported or available.
Migrate MetaBots with screens	Migrate MetaBots that contain screens as assets. You can migrate screens based on the Java technology and captured using the <b>Object</b> , <b>Image</b> , and <b>Coordinate</b> play modes. <a href="#">How MetaBots are migrated</a> on page 1596
View progress of bot migration	A progress bar is displayed in the migration results tab when the system starts migrating the bots.
Migrate bots that use SAP command	You can migrate Enterprise 11 bots that use the <b>GUI Automation</b> command to capture various objects from an SAP application. <a href="#">Package mapping for migration</a> on page 1620
Migrate bots that use the following attributes:	<ul style="list-style-type: none"> <li>• Regular expression to search for files on which you want to perform an operation.</li> <li>• Variable to specify the child bot you want to run.</li> <li>• System variables to retrieve information about a device's settings and its performance.</li> <li>• The <b>Save header To</b> option and containing array and dictionary variables in the REST Web Service command to store the response header.</li> <li>• Bots that contain failure responses from the REST Web Service command by using the <b>Capture failure response</b> option in Enterprise A2019. For Enterprise 11 bots, this option is enabled by default. <a href="#">REST Web Service package</a> on page 2961</li> <li>• Variables with names containing Arabic or Russian characters, or Japanese double-byte numbers. <a href="#">Unicode range supported in variables</a> on page 2341</li> </ul>

The following features apply to Enterprise 11 only:

Increment loop counter value by 1	The \$Counter\$ variable used in loop in Enterprise 11 bots is replaced with the \$Condition-Counter\$ variable in the migrated bots and value for the variable set to 1.
-----------------------------------	---

Service Cloud case ID: 00659314

View audit log migration reports

View the status of audit log migration and other related information in the **All migrations** page. View additional information by using the **View migration** option for each audit migration instance.

[Migrate Enterprise 11 audit logs](#) on page 1569 | [View migration reports](#) on page 1675

Migrate Enterprise 11 Bot Insight data and dashboards

- Migrate Enterprise 11 Bot Insight data and published dashboards of bots enabled for analytics by using the Bot Insight pre-migration utility and Bot Migration Wizard.

[Export Enterprise 11 Bot Insight dashboards for migration](#) on page 1568 | [Migrate Enterprise bots](#) on page 1590

- View Bot Insight migration reports from the new **Bot Insight results** tab on the **Administration > Migration > View migration** page.

[View migration reports](#) on page 1675

Migrate bots that use the following attributes:

- MetaBots with DLLs that use credential variables of string, character, or byte data type.
- The **Launch website** action of the Browser package to open a website in the Microsoft Edge browser.
- Shared session to establish a connection with a terminal server or open a Microsoft Excel spreadsheet and close the shared session from the child bot.
- IBM 5555 B01 and C01 models for TN5250 terminal types and the **Default** terminal for the VT100 terminal type.

## Enterprise A2019

---

**Important:** This release includes a required update to your . Ensure that you complete the update to continue with your automation activities when upgrading from a previous release to this release.

[Automatically update the Bot Agent](#) on page 1361 | [Manually update the Bot Agent](#) on page 1362

---

To verify which version is compatible with this release, see [Compatibility with release builds](#) on page 1333.

New features
<p>Connect to EWS server with OAuth authentication</p> <p>A new authentication is available for the Exchange Web Services (EWS) protocol with OAuth. You can use the OAuth authentication and enable your EWS-managed API applications to access Exchange online in Office 365.</p> <p><a href="#">Using Connect action in Email package</a> on page 2523</p>
<p>Google Cloud Platform supported for On-Premises deployment</p> <p>You can now host the Control Room, and create and deploy automation on devices configured to use the Google Cloud Platform environment.</p> <p><a href="#">Operating system, environment, and platform supported for Control Room</a> on page 1194</p>
<p>LDAP channel binding for enhanced network security in On-Premises deployment</p> <p>Control Room supports LDAP channel binding in order to comply with a security release from Microsoft. LDAP channel binding provides enhanced security for network communications between an Active Directory and its clients. It provides a more secure LDAP authentication over SSL and TLS.</p> <p><a href="#">Configure LDAP channel binding</a> on page 1377</p>
<p>Use Bot Agent with AWS WorkSpaces (Service Cloud case ID: 00652474, 00676112)</p> <p>You can now deploy bots on Bot Agent devices that are configured on AWS WorkSpaces.</p> <p><a href="#">Bot Agent compatibility</a> on page 1332</p>
<p>VT220 terminal type supported in Terminal Emulator</p> <p>To establish a connection and communicate with another machine, you can now use the VT220 terminal for sending and receiving text.</p> <p><a href="#">Using Connect action for Terminal Emulator</a> on page 3119</p>
<p>Permission to cancel checkout in Control Room</p> <p>Use the <b>Cancel checkout</b> permission to cancel checked-out Task Bots or files from the public or private workspace.</p> <ul style="list-style-type: none"><li>• In the public workspace, the status of the bot changes to public.</li><li>• In the private workspace, the status of the bot changes to new if any changes were made to the bot. If there are no changes, the bot is replaced with a clone.</li></ul> <p><a href="#">Check out a single bot</a> on page 2305</p>

New features
<p>Enhancements to the Recorder</p> <ul style="list-style-type: none"> <li>Record a task using the Universal Recorder or AISense Recorder from a single point of entry. Both recorders are now managed through a single package, which enables faster and more efficient updates.</li> <li>You can now record tasks in a Microsoft Edge browser that runs on Chromium (versions 79 and later).</li> <li>Use the AISense Recorder <b>Define</b> option to capture an object that is only visible when you hover the mouse over the object.</li> <li>Use the <b>Resize window</b> option in the <b>Recorder &gt; Capture</b> action to set the window width and height.</li> </ul> <p>This option delivers a more reliable bot. It resizes the window to the dimensions at which the task was recorded, thus increasing the likelihood that the bot identifies the target object.</p> <p><a href="#">Get started with recorders</a> on page 2238   <a href="#">Universal Recorder supported applications and browsers</a> on page 2248   <a href="#">Using the Capture action</a> on page 2940</p>
<p>Use shared session in Terminal Emulator</p> <p>Use the new <b>Shared session</b> option to pass the exact state of an application to a concurrently occurring Task Bot or MetaBot logic. For example, instead of connecting to the same application multiple times for different tasks, you can use the option to connect to the application using a single task, thus optimizing your automation logic in the long run.</p> <p><a href="#">Share session between Task Bot logic</a> on page 3133</p>
<p>Share an Excel session between bots</p> <p>Use the <b>Set session</b> action from the Excel basic or Excel advanced package to assign an Excel session to a variable, and then pass that variable from a parent to a child bot. This enables the child bot to access the worksheet opened in the parent bot.</p> <p><a href="#">Excel basic package</a> on page 2558   <a href="#">Excel advanced workbook operations</a>   <a href="#">Example for sharing an Excel session between bots</a> on page 3114</p>
<p>New option for Run Task</p> <p>In the Task Bot package, you can now use the <b>Run</b> action with an option to repeat the selected task until you choose to stop it.</p>
<p>New search for roles in User Management API</p> <p>Use the new <code>search_for_roles</code> API in the User Management APIs in Swagger to obtain a list of all the roles or details for a specific role.</p>
<p>Capture response status of REST API</p> <p>In the REST Web Service package, you can capture the response status of the REST API in the dictionary variable. The dictionary variable now shows the response key with its value.</p>
<p>New option for REST Web Service (Service Cloud case ID: 00489741, 00646436)</p> <p>Use the <b>Capture failure response</b> action in the REST Web Service package to capture response details in the response body.</p>

**New features**

## Use regular expressions in packages

You can use regular expressions (regex) in certain actions to support pattern-based search in a file, folder, or Windows title. Regular expressions are supported in the actions of the File and File and Folder packages such as **Copy**, **Delete**, **Rename**, **Print Multiple files**, and **Zip**.

You can also use regular expressions in some packages that support the wildcard character in their window titles.

The following packages and actions support regular expressions:

- Wait
- Image Recognition
- Simulate keystrokes
- Mouse > **Click** action
- Legacy Automation > **Manage windows control**
- OCR
- Screen
- Recorder > **Capture**
- Run DLL > **Run function (Legacy)**, **Run function**
- Window: **Activate**, **Close**, **Maximize**, **Minimize**, **Resize**

[Using Copy Desktop file action for file](#) on page 2601 | [Using the Capture action](#) on page 2940

## Support for overloaded functions in DLL package

The **DLL > Run function** action can now handle .dll files that contain multiple functions of the same name. The action calls the function based on the number of parameters passed.

[Using the Run function action](#) on page 2505

## New actions for SAP captured objects

Use new actions that are available for **Tree**, **Tab**, and **Label** controls to perform operations for the various objects captured from an SAP application.

[Recorder actions supported in various SAP versions](#) on page 2952



**New features**

Enhancements to elements in the form builder

- **Image** element: Upload image files to the form using this element.  
[Using the Image element](#) on page 3443
- **Button** element: Validate all the fields in a form using the **Validate all form fields when this button is clicked** option.  
[Using the Button element](#) on page 3438
- **Password** element: Use one of the following formatting options:
  - **Standard**: set the character limit and choose additional security options.
  - **Custom**: add a custom password on the **Regular expression** page.  
[Using the Password element](#) on page 3446
- **Rich Text Editor** element: Use this element in the **Set** action when creating a bot in order to add or overwrite the value of a variable.
- **Table** element: Includes the following updates:
  - New data types for **Column settings**:
    - Date
    - Number
    - Dropdown
  - The following actions, which you can use during bot runtime:
    - **Set** action to add rows to the table.
    - Trigger events to add rows and delete rows.
    - Sort table columns.
- **Text Box** element: Choose one of the following formatting options:
  - **Standard**: set the character limit for this field.
  - **Custom**: add a custom password on the **Regular expression** page.  
[Using the Text Box element](#) on page 3453
- **Select file** or **Snapshot** element: When you click **Preview** during bot runtime, the system default application is used to display the selected file.  
[Using the Select File element](#) on page 3448 | [Using the Snapshot element](#) on page 3450

Enhancement to List view of bots

In the **List** view of the Bot editor, you now drag a selected action to the task logic.

New features
<p>Import Enterprise 11 bots to Enterprise A2019 (Service Cloud case ID: 00512847)</p> <ul style="list-style-type: none"><li>• Bot Lifecycle Management Import feature: The Bot Lifecycle Management import feature enables you to import Enterprise 11 bots from multiple Enterprise 11 Control Room instances to a single Enterprise A2019 instance by using the <code>aapkg</code> file.</li></ul> <p><a href="#">Bot Lifecycle Management</a> on page 2030   <a href="#">Import bots</a> on page 2035</p> <ul style="list-style-type: none"><li>• Bot Lifecycle Management Import API: You can also use this API to import Enterprise 11 bots to the Enterprise A2019 instance by uploading the <code>aapkg</code> file. However, you can import a password-protected <code>aapkg</code> package only by using the Import API.</li></ul> <p><a href="#">BLM API</a>   see Import repository bots in <a href="#">BLM API</a></p>
<p>New endpoint in License API</p> <p>Use the <b>List details of Control Room licenses</b> endpoint to retrieve metadata including the license type, number of available licenses, number of licenses used in a specific Control Room instance, and number of licenses used in all Control Room instances.</p> <p><a href="#">License API</a></p>
<p>Programmatically manage device login credentials</p> <p>Use the <b>Login setting</b> endpoint of the Credential Vault API to set or update the device login credentials to allow bots to run on the device.</p>
<p>Store multiple lines of text in a string variable</p> <p>You can use a string variable containing multiple lines of text in the following actions:</p> <ul style="list-style-type: none"><li>• <b>String &gt; Assign</b></li><li>• <b>String &gt; Extract text</b></li><li>• <b>String &gt; Compare</b></li><li>• <b>String &gt; Lowercase</b></li><li>• <b>String &gt; Replace</b></li><li>• <b>String &gt; Reverse</b></li><li>• <b>Log to file</b></li><li>• <b>Message box</b></li><li>• The string condition in the <b>If</b>, <b>Wait</b>, and <b>While</b> actions</li></ul>
<p>Arabic, Japanese, and Russian characters supported in variable names</p> <p>You can now create variables with names containing Arabic or Russian characters, or Japanese double-byte numbers.</p> <p><a href="#">Unicode range supported in variables</a> on page 2341</p>

Changed features
<p>Configure granular security for Bot Agent (Service Cloud case ID: 00653807)</p> <p>Starting from this release, only registered Bot Agent device IP addresses that are added in the <b>Allowed IP addresses</b> list of the <b>Network Settings</b> can connect to the Control Room. In previous releases, devices from all subnets and IP addresses within the corporate network were allowed to connect to the Control Room URL.</p> <p><a href="#">Add access public IP addresses</a> on page 1808</p>
<p>Update to Excel advanced package</p> <p>The <b>Open</b> action in the Excel advanced package now opens a Microsoft Excel spreadsheet even when a file extension is not provided.</p>
<p>Disable clone and view content permissions for check-in (Service Cloud case ID: 00656157)</p> <p>When the <b>Check in</b> permission is selected, the <b>Clone</b> and <b>View content</b> permissions are also automatically selected. As a Control Room administrator, you can now disable the <b>Clone</b> and <b>View content</b> permissions when required.</p>
<p>Associate triggers with unattended Bot Runners</p> <p>Ensure that the default device is not in locked state if you are associating triggers with unattended Bot Runners.</p>
<p>Additional license support enhancements</p> <p>Control Room administrators are enabled to install a new GUID license before an existing license expires.</p>
<p>Change in edit device permission</p> <p>Starting from this release, the permission to edit devices is not available in the system-created <b>AAE_Basic</b> role by default in the Control Room. A user has to select the <b>Edit the device(s)</b> permission separately.</p> <p><a href="#">Devices</a> on page 1873</p>

The following table lists the fixed features and the builds in which they were fixed (Build 7103 is the latest build, and Build 7096 is the previous build). The fixes are cumulatively available in the latest build.

Fixed features		
Build number	Service Cloud case ID	Description
7103	00684905, 00703481	A Task Bot now runs as scheduled and no longer shows the device status as <b>Picked at runtime</b> on the <b>View task in progress</b> (Activity) page when the Task Bot is running.

Fixed features		
Build number	Service Cloud case ID	Description
7103	00676476	An error is no longer encountered when you run a child bot that contains a Japanese full-width space character in the name.
7103	00689935, 00689381, 00690368, 00690217, 0069053	License server syncing error generated when control room licenses and licenses stored on a server are updated on different schedules. This issue has been fixed. Should an error message appear, click "Sync licenses from Server" for any new licenses in production to manually sync the licenses.
7096	00667396, 00670001, 00653771, 00671553	Bot Scanner no longer encounters an error when scanning bots with non-ASCII characters in their name.
7096	00659334	The <b>Offset from match</b> option in the Image Recognition package now works correctly in migrated bots.
7096	00669166	You can now migrate large bots (for example, with 30+ dependencies and 500+ lines) using the Bot migration package. The system no longer encounters an error when migrating a bot that contains a large number of nested IF/ELSE commands.
7096	00659349	You can now migrate bots with special characters in their names.
7096	00670985, 00674145	The system no longer encounters an error due to Bot Store credentials when you migrate from Version 11.3.3 or a later version to Enterprise A2019.
7096	00679817	An unknown error is no longer displayed when you are migrating a bot that the Bot Scanner listed as ready for migration.

Fixed features		
Build number	Service Cloud case ID	Description
7096	00457898, 00488494	<p>You can now register a device with a username that contains non-ASCII characters such as Korean language characters.</p> <hr/> <p><b>Note:</b> Before upgrading the Bot Agent to the current version, ensure that the registered device is configured to use non-ASCII characters.</p> <hr/> <p><a href="#">Configuring post-installation settings</a> on page 1315</p>
7096	00611887	<p>You can now download an exported bot package using the Internet Explorer browser by opening the download link received in the email. You can also do this from the <b>Activity &gt; Historical</b> page.</p>
7096	00647932	<p>When you create a bot using the <b>Get method</b> action in the REST Web Service package, the UTF-8 character set is now supported. Therefore, Korean characters are processed correctly in the REST API response. Previously, UTF-8 characters were not supported.</p>
7096	00641126	<p>You can now use the <b>Get single cell</b> action in the Excel basic package to extract the date correctly for the Japanese date format. Previously, the Japanese date was displayed in double quotation marks.</p>
7096	00634102	<p>You can now use the Simulate keystrokes package with the Alt +F4 key and set a longer delay value between each keystroke. Previously, the bots displayed an error when a longer delay value was set with the Alt+F4 key.</p>

Fixed features		
Build number	Service Cloud case ID	Description
7096	00655739	In REST Web Service, the Rest API Get call now works properly even when the encoded URL string has special characters such as double quotation marks. Previously, the Rest API Get call failed when the URL string had double quotation marks.
7096	00653944	The String package now shows the correct output when you use the loop action to read a file name that does not have an extension. Previously, when the file did not have any extension, the filename extracted using the loop displayed an incorrect output.
7096	00677941	When an optional field ( <b>Mark field required</b> is not selected) is now left blank, a form is validated without any error messages during bot runtime.
7096	00662011	When using the files and folders trigger, you can now use any available network drive to start a bot.
7096	00666441, 00673888	For a folder trigger, you can now select a folder name containing a space character and the bot runs successfully without encountering any issues.  For example, you can select a folder called 'Sales chart'.
7096	00622100	When <b>Simulate keystrokes</b> is enabled for a hot key trigger, you can now start a bot multiple times using the associated hot keys without encountering any issues.
7096	--	If an element is marked as <b>Read-only</b> on the form builder screen, a validation error is no longer displayed for that field during bot runtime.

Fixed features		
Build number	Service Cloud case ID	Description
7096	00570660	You can now use Windows forms with the <b>Run function</b> action of the DLL package.
7096	00624644	The system no longer encounters an error when you upgrade from an earlier version of Enterprise A2019 to a later version when the settings are preserved and the installation path is not the default location.
7096	00670008	You can now pause or resume a task from the <b>Activity &gt; In progress</b> page.
7096	00667210, 00672875	In the Excel advanced package, you can now use the <b>Go to cell</b> action even if the Excel sheet does not have any data or an active cell is out of the worksheet range. Previously, an issue was encountered when you used the <b>Go to cell</b> action and chose the cell option as <b>Active cell</b> with the <b>Beginning of the row, End of the row, Beginning of the column, or End of the column</b> option.
7096	00659098, 00669437	You can now edit the <b>Start date</b> of an existing schedule to today's date, provided the start time is set before the bot is scheduled to run.
7096	00671392	You can now stop a bot that is in progress using the <b>Stop</b> option from the <b>In progress (Activity)</b> page or the <b>Stop</b> option on the runtime window that appears when the bot is being executed.
7096	00647761	You can now define a list variable of subdata type Boolean or datetime within an action. Previously, the bot encountered an error in this scenario.

Fixed features		
Build number	Service Cloud case ID	Description
7096	00671478	Fixed an issue in the <b>Task Bot &gt; Run</b> action where the value of an input variable disappeared when the user clicked <b>Save</b> . This issue only occurred when the <b>Current Task Bot</b> option was selected.
7096	00663719, 00635437	Fixed an issue where the OCR package was missing from Control Room instances hosted on Microsoft Azure. The connection with the Microsoft Azure database timed out before the OCR package .jar file could complete the upload.
7096	00631133, 00636174	In the Wait package, the <b>Wait for condition</b> action in the recorder object no longer waits indefinitely during bot execution. If the required window or its control does not exist, the bot waits for the required window or its control for the time specified in the <b>Wait for control</b> field. If the required window or its control is not found within this specified time, the bot continues to perform the next set of actions.
7096	00628863	Bot files or dependencies are no longer lost when you check in or check out a bot from the private or public workspace when the Elasticsearch service is running and not in index read-only mode. Previously, an error occurred when a bot was either checked in or checked out, and the bot files or dependencies were lost and could not be recovered.
7096	00673520	When a bot is deployed through RDP with a predefined screen resolution, the RDP resolution settings are now applied correctly during bot execution. Previously, the bot was executed with an interchanged resolution (the height and width pixels were interchanged).



Fixed features		
Build number	Service Cloud case ID	Description
7096	00670346	After you edit a bot schedule, the input value of a variable in the bot no longer has to be reinitialized and the bot does not show the default output value for the variable when it is executed.
7096	00653056, 00651853, 00647949, 00657465,00670024	The <b>In progress</b> activity is now displayed correctly for bots deployed on Bot Runners by any user.
7096	--	<p>When developing custom packages, you can now set your name in the vendor column. To set the name, update the <code>author</code> property of the <code>build.gradle</code> file, as shown below:</p> <pre>packageJson{   artifactName =     project.name   group = "\$groupName"   author = "&lt;entername&gt;" }</pre> <p>Leaving the field empty shows the vendor name as unspecified.</p>
7096	--	Multiple users can now simultaneously run a bot associated with a form without encountering any issues on the same Bot Runner machine.
7096	--	You can now migrate Enterprise 11 bots that contain variables that are in a different letter case (uppercase or lowercase) than those in Enterprise A2019. Variables are case-sensitive in Enterprise A2019 but not in Enterprise 11, which previously resulted in an error.
7096	00592758	You can now create a variable with a name that starts with a numerical character.
7096	00670994	You can now register with the Control Room from a multiple-user device configured for Active Directory users.

Fixed features		
Build number	Service Cloud case ID	Description
7096	00677479	The deployment time of a priority queue no longer takes a long time (for example, more than 1 hour) to process Work Items required for workload automation.
7096	00667110	You no longer have to restart the Automation Anywhere Bot Agent service to resume queued Work Items that are stuck in in-progress state.
7096	00673043	When you specify a value in the numOfRunAsUsersToUse parameter of the Bot Deploy API, the weighted system algorithm now assigns tasks to the Bot Runners with the least number of tasks queued and currently running. Previously, the algorithm did not correctly calculate the weight of queued and running tasks, which resulted in an inefficient task allocation to the same one or two Bot Runners.

Known limitations
<p>When a bot opens a website inside a loop, the Recorder <b>Capture</b> action fails after the execution of Launch Website.</p> <p>Workaround: Add a delay of a few seconds in the loop between the Launch Website and Recorder <b>Capture</b> action.</p>
<p>The Recorder <b>Capture</b> action does not support object recapture for the AISense technology type.</p>
<p>The system does not display a value for a session variable when the variable is selected as <b>Watched variables</b> in <b>Debug</b> mode.</p>
<p>The session variable returns a blank value when it is used as output in a bot and the bot is deployed using the Bot Deploy API.</p>
<p>After an upgrade to the latest version of Enterprise A2019, the bot might encounter an error if you are using the <b>Close</b> action of the <b>Window</b> package version 2.1.0-20200813-181240 or earlier.</p> <p>Workaround: Add a delay of 50 milliseconds after the <b>Close</b> action in the bot.</p>

Known limitations
<p>The Recorder package takes a long time (for example, approximately 6 hours) to upload to a remote application repository path of an On-Premises Control Room deployed on Microsoft Azure.</p> <p>Workaround:</p> <ol style="list-style-type: none"> <li>1. Before you install or upgrade to this version, configure the repository path in a local directory of the Control Room node to upload the package.</li> <li>2. After installing or upgrading, verify that all packages are available in the <b>Packages</b> page of the Control Room.</li> <li>3. Change the repository path to a remote file share.</li> </ol>
<p>The AISense Recorder fails if you manually upgrade the Recorder package version, such as by importing a bot that contains a Recorder package version from a more recent build than the destination Control Room. Always upgrade the Recorder package through the Control Room.</p>

## Automation Co-Pilot for Business Users (Automation Co-Pilot)

New features
<p>Run a process in private workspace</p> <p>You can now run a process in your private workspace by using the <b>Run</b> option in the process editor. The bots in the process are then executed on the default device of the Bot Creator.</p> <p><a href="#">About Process Composer</a> on page 3419</p>
<p>Use the Data Privacy tag field</p> <p>The <b>Data Privacy tag</b> enables users to generate hidden custom output in their process tasks (<b>Start</b> panel, <b>Human Task</b>, and <b>Bot Task</b>). Users can enter the variables for this field during runtime with values. In the web portal, the Automation Co-Pilot admin can use this tag to check for requests or tasks by using personal user data. The admin can also filter using this field.</p> <p><a href="#">Create a process automation in Process Composer</a> on page 3454   <a href="#">Filter and search for a request</a> on page 3391   <a href="#">Filter and search for a task</a> on page 3393</p>
<p>Use variables types</p> <p>You can now use new variables in the process editor such as <b>createdOn</b> and <b>updatedOn</b> (DateTime), <b>id</b> (Number), and <b>title</b> (String). These variables are part of a data flow (workflow engine) that moves data between each step of a process and requires variable input for the process to run properly.</p> <p><a href="#">Supported variable types in Process Composer</a> on page 3433</p>

New features
<p>View previous selected tasks</p> <p>Automation Co-Pilot users can now reference selected actions of their tasks. When they view a submitted task in request view, a check mark indicator is now displayed next to the buttons that are selected.</p>

Changed features
<p>Configure scheduler user to allocate device pool to Automation Co-Pilot on the web interface</p> <p>In the <b>AARI Settings</b> page, the Automation Co-Pilot administrator can now configure a scheduler user to allocate the Control Room resources (devices and unattended Bot Runners) to Automation Co-Pilot on the web interface.</p> <p>The scheduler user must have <b>View my bots</b> and <b>Run my bots</b> permissions and have access to a device pool and Bot Runners. The Automation Co-Pilot process can then use those resources for each bot deployment.</p> <p><a href="#">Configure scheduler user for Automation Co-Pilot</a> on page 3413</p>
<p>End point display</p> <p>In the <b>Completed</b> panel, the <b>End point</b> has a new display option <b>Update request title</b> that enables the user to update the request title. When the user updates the <b>Display message</b> field, the update is now reflected in request view.</p> <p><a href="#">Create a process automation in Process Composer</a> on page 3454</p>
<p>Use F2 to insert variables</p> <p>You can now use the F2 keyboard shortcut to insert variables in the process editor.</p>

Fixed features	
Service Cloud case ID	Description
--	The <b>Task display name</b> option in the <b>Start</b> panel is now set to <b>Request Creation</b> by default. Any name changes by the user is now reflected in the request view.
--	The <b>Feed data into form</b> table in the process editor now works properly and users can now edit the field.
--	In a form that contains a <b>Number</b> field set to a 10-character limit, when you enter the maximum character limit (for example, 1234567890) in the number field in request view, the number values are now accepted.

Fixed features	
Service Cloud case ID	Description
--	When you create a process with a form that contains a <b>Date</b> element, the <b>Condition</b> option in the <b>If/Else pair</b> action now allows you to enter a variable. Previously, the option did not allow you to enter a variable.

Known limitations	
In the process editor, if a bot contains an incorrect input variable, the properties panel highlights the wrong element: <b>Browse</b> in the <b>Select Task Bot</b> field is highlighted instead of the incorrect variable.  Workaround: Hover your mouse over the red icon next to the <b>Bot Task</b> in the process editor to see the error.	
In the process editor, if you replace the <b>Go to</b> option with an <b>End Process</b> , the <b>End Process</b> icon does not display the status (Completed, Failed, Canceled) correctly.  Workaround: Click the <b>End Process</b> icon and change the status.	
A <b>Bot Task</b> cannot pass data to the next task ( <b>Human Task</b> or <b>Bot Task</b> ) if it contains Japanese characters in its output variable name.  Workaround: Use English characters for the variable name in the <b>Bot Task</b> .	
If a scheduler user has multiple sets of configurations (device pools and Bot Runners), due to a mismatch in the selection of the device pool and the Bot Runners, the bot deployment fails.  Workaround: Set Bot Runners in the <b>Run As</b> section of the consumer role. Ensure the scheduler user has access to only one device pool and one consumer role that has run-as users.	
When you access Automation Co-Pilot through the web interface, the <b>Request ID</b> and <b>Task ID</b> consider the data as string type instead of numeric data type and sorts it accordingly.  For example, if a <b>Request ID</b> or <b>Task ID</b> starts from 1 through 30, the IDs are sorted as string data type (1, 10, 11, 12, 13, ..., 2, 22, 23, ..., 30) instead of numeric data type (1, 2, 3, 4, ..., 30).	
In some bot development failure scenarios, for example, files are not found or the scheduler user does not have access to the bot file, bot development fails by timing out after one hour instead of displaying an error.	
If an Automation Co-Pilot manager creates a team with the same name as a team created by any other manager, no error message is displayed and two teams are created with the same name.	

Known limitations
<p>When you access Automation Co-Pilot through the web interface, the task and case list pages do not display the following words in the localized languages:</p> <ul style="list-style-type: none"> <li>• Search task</li> <li>• Results</li> <li>• Request title</li> </ul>
<p>In the process editor page, the following words are not displayed in the localized languages:</p> <ul style="list-style-type: none"> <li>• Process entry</li> <li>• Run</li> <li>• Undo</li> <li>• Redo</li> <li>• Data privacy tag</li> <li>• Auto assign this task to</li> <li>• InitialData</li> <li>• Update request title (optional)</li> <li>• Update task name (optional)</li> <li>• Boolean condition</li> </ul>

## Discovery Bot

New features
<p>Column headers updated in Recordings page</p> <p>The <b>Recordings</b> page now displays labeled column headers when you review captured steps for recordings. The following headers are displayed for the associated text field:</p> <ul style="list-style-type: none"> <li>• Screenshot</li> <li>• Application</li> <li>• Data</li> <li>• Step description</li> </ul> <p><a href="#">Record a Discovery Bot business process</a> on page 3910</p>
<p>Highlight where you click or enter data when recording processes</p> <p>The system now displays the area, component, or control where you click or enter data with a red highlighted box at the time of recording.</p> <hr/> <p><b>Note:</b> The red highlight is only shown in the captured screenshot in the generated bot. The highlight is not shown on captured screenshots from the <b>Recordings</b> page for review and after submission to the analyst. The highlight is also not shown from the preview pane from the <b>Aggregated</b> and <b>Opportunity</b> tabs for the analyst review.</p> <hr/> <p><a href="#">Supported applications and browsers for Discovery Bot</a> on page 3908</p>

New features
<p>Condition and value displayed for each branch in Aggregated view</p> <p>For the <b>System generated</b> view, the condition and its value for each branch are automatically retrieved and displayed as part of the auto-generated Aggregated view.</p>
<p>System-generated aggregation</p> <p>You can now merge multiple recordings into a single aggregated view automatically by selecting the required set of recordings.</p> <p><a href="#">Create a process view with branches and opportunities</a></p>
<p>Convert system-generated aggregated view to a manual view</p> <p>You can now convert a system-generated aggregated view to a manual view using the <b>Save as [manual]</b> option or the <b>Convert to Manual</b> option from the <b>Views</b> table. This option enables you to add more recordings or steps from other recordings to your process view.</p> <p><a href="#">Create a process view with branches and opportunities</a></p>
<p>Create an opportunity, including all steps and branches</p> <p>You can now use the <b>Select all steps</b> option to create an opportunity that includes all steps, branches, and sub-branches.</p> <p><a href="#">Create a process view with branches and opportunities</a></p>
<p>Download a process definition document (PDD) (previously, Export to Word)</p> <p>The <b>Export to Word</b> option is now renamed as <b>Download Process Definition Document (PDD)</b>. When an opportunity is created, the PDD begins processing in the background automatically. When the PDD is ready for download from the Control Room, an email notification is sent to the email address on file to the opportunity owner.</p> <hr/> <p><b>Note:</b> You must be the owner of the opportunity to be able to download the PDD.</p> <hr/> <p><a href="#">Review opportunities and convert to</a></p>
<p>Receive email notification when your bot is converted successfully</p> <p>You can now receive an email notification when your bot is successfully converted. Click the hyperlink in the email to take you to your folder in which the bot was generated.</p> <p><a href="#">Review opportunities and convert to</a></p>
Changed features
<p>Zoomed-in view of captured steps is increased</p> <p>The zoomed-in view in the <b>Screenshot</b> field is now increased from x4 to x8 for better readability of captured steps.</p>

Changed features
<p>Permissions layout</p> <p>The layout of the permissions for Discovery Bot is now changed to separate the individual and "all" permissions to easily manage access control.</p>

Fixed features	
Service Cloud case ID	Description
--	<p>When you create a branch in a view, typically a single step from the current branch is moved into the left branch while a new branch with an empty box is added to the right branch. You can add steps from a different recording only into the empty box in the right branch. Typically, only one step from the original branch is included in the left branch. If the branch is created following the last step in the flow, then no steps will be included in the left branch. You can now add new steps to the left branch in case it was the last step. You can also move the endpoint of the newly created branch lower or higher in the process to include additional steps in the left branch.</p>

Known limitations
<p>In the <b>Opportunities</b> tab, the process and owner column does not allow you to sort in ascending or descending order, or when you sort for both process and owner.</p>
<p>In the <b>Opportunities</b> tab, the search field and the filter drop-down option do not work when you search for the <b>Process</b> or <b>Owner</b> columns.</p>
<p>The <b>Download PDD</b> option is disabled if you are not the owner of the opportunity.</p>
<p>The <b>Delete</b> icon is not properly visible in the edit recordings screen in Internet Explorer.</p> <p>Two-finger swipe on the track pad does not change the zoom level in any canvas of the <b>Aggregated</b> and <b>Comparison</b> tabs.</p>
<p>Discovery Bot is currently not supported on Linux.</p>
<p>The red highlight is only shown in the captured screenshot in the generated bot. The red highlight is not shown on captured screenshots from the <b>Recordings</b> page for review and after submission to the analyst. The highlight is also not shown from the preview pane from the <b>Aggregated</b> and <b>Opportunity</b> tabs for analyst review.</p>



## IQ Bot

New features
<p>Support for Arabic language</p> <p>When creating a learning instance, you can now choose the Arabic language from the <b>Primary language of documents</b> drop-down menu, with the following limitations:</p> <ul style="list-style-type: none"><li>• Advance table extraction is not available.</li><li>• Search field on the is not supported.</li><li>• Arabic numerals are not supported.</li></ul> <p>For example, if the document has date or time in Arabic language, it is extracted as text and validations can fail.</p> <hr/> <p><b>Note:</b> You can still use string-based validation checks (such as regular expressions) for Arabic numerals.</p> <hr/> <ul style="list-style-type: none"><li>• Arabic is only supported on ABBYY FineReader Engine 12.4.</li></ul> <p><a href="#">Creating a learning instance</a></p>
<p>Default validations for a group</p> <p>When editing a learning instance, you can now use the <b>Select the default validations group</b> drop-down menu to select an available group. This allows all the new group documents in production to be extracted based on the custom logic and validations defined in this selected group, before it goes to the Validator.</p> <p><a href="#">Edit a learning instance</a></p>
Changed features
<p>Automatically detect check box</p> <p>IQ Bot can now automatically detect check boxes and radio buttons in a document. You can enable this feature when creating a learning instance.</p> <p><a href="#">Creating a learning instance</a></p> <ul style="list-style-type: none"><li>• With this feature enabled, during training, if you select <b>check box</b> from the <b>data type</b> drop-down list and then you select the <b>field value</b>, only the check box segments are displayed.</li><li>• This feature does not work with the PDFBox option enabled.</li></ul> <p><a href="#">Disable PDFBox option</a></p>

Changed features
<p>Tegaki API OCR improvements</p> <p>IQ Bot now uses enhanced Tegaki API OCR segmentation to improve accuracy in the following scenarios:</p> <ul style="list-style-type: none"> <li>• Multiple fields are merged into a single SIR</li> <li>• Segmentation on empty spaces</li> <li>• Overlapping SIRs</li> <li>• Incorrectly located SIRs</li> <li>• Partial or incorrectly captured values from SIRs</li> </ul> <p><a href="#">IQ Bot Tegaki API OCR engine</a></p>
<p>Updated versions of RabbitMQ v3.8.18 and Erlang/OTP</p> <p>The IQ Bot installation package now includes RabbitMQ v3.8.18 version 3.8.8 and Erlang/OTP version 23.0.4.</p> <p><a href="#">RabbitMQ and Erlang/OTP upgrade</a></p>
<p>PyArabic removed from Python installation</p> <p>PyArabic is one of the Python libraries that was used in content extraction for Arabic language (right to left). Because Arabic language is now supported by default with IQ Bot installation, PyArabic is removed from Python installation.</p> <hr/> <p><b>Note:</b> Ensure you update any bot that you have deployed using PyArabic.</p> <hr/>
<p>Performance improvement (Service Cloud case ID: 00629302)</p> <p>IQ Bot now takes significantly less time to create a bot for groups containing only production documents.</p>

Fixed features	
Service Cloud case ID	Description
00500914	<p>The <code>TesseractLog.log</code> file is now available in the following directory: <code>C:\Users\Public\Public Documents\Automation Anywhere IQBot Platform\Logs\Engine\</code>.</p> <p>The log level is set to <code>error</code> by default. You can change this setting in the <code>CognitiveServiceConfiguration.json</code> file.</p>
00430923, 00618234, 00636422, 00478986, 00414921	<p>All uploaded documents are now rendered correctly, irrespective of their content orientation while uploading, which enables you to train them without encountering any issues. Previously, when you created a learning instance, documents that did not have the correct content orientation (they were upside down or tilted) could not be trained.</p>

Fixed features	
Service Cloud case ID	Description
00653929	IQ Bot On-Premises: With segmentation improvements, you can now train documents in the Korean language using the Tegaki API OCR engine without any system-identified region (SIR) errors.
--	The system no longer creates any unnecessary folders for successfully classified documents that are uploaded using the IQ Bot [Local Device] package.
--	You can now use the designer page when creating a learning instance to test all the documents, without any error messages.
00590165	For a learning instance, you can now use the <b>See extraction results</b> option to browse all the documents in the selected group.
00672470	After validating the fields of production documents, you can now use the <b>Save current document</b> option to save all the validated document, without any error messages.
--	Check box fields are now extracted with better accuracy. You can use the <b>Checkbox auto-detection</b> feature so that IQ Bot automatically detects the check box fields and radio buttons.
00652269, 00619139	When you now run a bot and try to edit it while it is still running, the following correct message is displayed: <code>Staging Documents for this Vision bot is in progress. Please try after some time.</code> Previously, the following incorrect message was displayed: <code>Learning instance not found.</code>
00601401	When creating a learning instance, you can now use the Thai language for form and field names without encountering any issues.
00624416	When you migrate a learning instance, group descriptions are now migrated without any errors.
--	If you select any field on the Validator screen, the focus from that field is no longer lost when you now click or draw to select SIR.
00662968	Sometimes, when you click <b>See Extraction Results</b> and the preview fails, IQ Bot now correctly displays the following error message after a timeout of 2 minutes: <code>Error occurred while extracting the document. Please re-check the training/document.</code> Previously, when the preview failed, the page kept loading indefinitely.

Fixed features	
Service Cloud case ID	Description
00674110	Production documents are now moved to the without any errors, irrespective of how the bot was trained (number pages, number of segments in each page, or number of tables and fields extracted).

Known limitations	
IQ Bot On-Premises and Cloud	In the table area of the Validator, if you add a new row, enter a value, and then delete this row, the value of the next row is replaced by the content you entered in the deleted row.
IQ Bot On-Premises and Cloud	In the Validator, when you click any validated field and then click any other cell, the value in the validated field is deleted.
IQ Bot On-Premises and Cloud	<p>When you upload a document to production immediately after deleting a bot it was associated with, extraction results are not displayed.</p> <p>Workaround: Use one of the following options:</p> <ul style="list-style-type: none"> <li>• Select the <b>Disable cache</b> option in the <b>Network</b> tab.</li> <li>• Ensure you wait at least 3 minutes between deleting the bot and uploading the document.</li> <li>• Empty the cache and reload the page.</li> </ul>
IQ Bot On-Premises and Cloud	You cannot use <b>Express</b> mode to install IQ Bot.
IQ Bot On-Premises and Cloud	Numerals in the Polish language are not accepted or validated in the Validator.
IQ Bot On-Premises and Cloud	If you create a user role with 2-byte non-English characters, services fail with an <code>invalid characters</code> message.
IQ Bot On-Premises and Cloud	If the name of a learning instance has both English and Arabic characters, the time stamp of the backup file is appended in between the filename.
IQ Bot On-Premises and Cloud	You cannot use the draw functionality to generate an SIR when you zoom in on a document in the Validator.

Known limitations
<p>IQ Bot On-Premises</p> <p>After installing IQ Bot, MLWeb services stops responding.</p> <p>Workaround: Manually stop and restart the MLWeb services.</p>
<p>IQ Bot On-Premises</p> <p>If you add a new language after upgrading to IQ Bot A2019, the <b>Learning Instance</b> page is not displayed due to Language API cache issues.</p> <p>Workaround: Clear the cache and restart the IQ Bot service.</p>
<p>IQ Bot On-Premises and Cloud</p> <p>If you try to process a PDF document with <b>pdfboxOCR</b> enabled, the SIRs are not placed correctly on the check boxes.</p> <p>Workaround: Disable the pdfbox OCR when you create a learning instance.</p>
<p>IQ Bot On-Premises and Cloud</p> <p>If you create a learning instance with <b>Auto Checkbox Detection</b> enabled, check box SIRs cannot be selected.</p> <p>Workaround: Draw on top of the check box SIR instead of selecting the identified SIR field.</p>
<p>IQ Bot On-Premises and Cloud</p> <p>Starting with IQ Bot A2019.17, the default OCR engine is changed to ABBYY FineReader Engine 12.4 from the previous 12.2 version. Therefore, if you have migrated learning instances from earlier versions, you might have to retrain your bots because there could be a change in segmentation.</p>
<p>IQ Bot On-Premises and Cloud</p> <p>The <b>Default validations group</b> is not overwritten on the imported learning instance even when the <b>Overwrite</b> option is used when you import that learning instance.</p> <p>Workaround: Edit the learning instance after importing the IQBA file and change the default group.</p>
<p>IQ Bot On-Premises and Cloud</p> <p>A learning instance is exported as an IQBA file that contains <code>Projectdetails.csv</code>. When you extract this <code>.csv</code> file, the column header name for the <b>Default validations group</b> in the table is not available. However, the corresponding value in that column is available.</p>
<p>IQ Bot On-Premises and Cloud</p> <p>If you re-import an IQBA file for a deleted learning instance, the <b>Default validations group</b> setting available in that IQBA file is not applied to the learning instance.</p> <p>Workaround: Edit the learning instance after importing the IQBA file and change the default group.</p>

## Bot Insight

New features
<p>New Automation Co-Pilot dashboard in Bot Insight</p> <p>Use the Automation Co-Pilot dashboard to view various widgets that provide information about requests created from published processes in Automation Co-Pilot. The dashboard also provides statistics on the status of created requests.</p> <p><a href="#">Automation Co-Pilot dashboard</a> on page 3940</p>

Security fixes	
Service Cloud case ID	Description
--	The <b>Allow Header HTTP</b> header is removed from Bot Insight.

## Supported packages

Package	Version
Application	2.1.0-20200921-085720
App Integration	1.1.0-20201014-042506
Analyze	2.2.4-20200903-113949
Active Directory	2.1.0-20200921-085716
Boolean	2.1.0-20201014-042509
Bot Migration	2.5.0-20200902-045043
Browser	2.1.0-20201002-123733
Clipboard	2.1.0-20201014-042520
Comment	2.2.0-20201014-042520
CSV/TXT	2.3.0-20201014-082525
Database	2.2.0-20201013-052941
Data Table	2.3.0-20201030-143334
Datetime	2.2.0-20201014-042531
Delay	2.2.0-20201014-042532
Dictionary	3.2.0-20201014-042532
Run DLL	3.2.0-20201105-205159
Email	3.1.0-20201104-062204
Error handler	2.2.0-20201014-042541

Package	Version
Excel basic	2.3.0-20201027-160012
Excel advanced	5.1.0-20201027-155758
File	3.1.0-20201016-065515
File & folders	1.1.0-20201023-202725
Folder	3.0.0-20201016-065517
FTP / SFTP	2.1.0-20200921-085757
IF/ELSE	2.1.0-20200921-085758
Image Recognition	2.1.0-20201014-042552
Interactive forms	2.17.3-20201102-103733
IQ Bot	2.1.0-20201013-095304
JavaScript	2.3.0-20201104-062431
Simulate keystrokes	2.4.0-20201021-163833
Legacy Automation	3.2.0-20201104-062439 1.3.0-20201105-151906
List	2.2.0-20201014-042806
Log To File	2.2.0-20201014-042806
Loop	2.1.0-20201014-042808
Message Box	2.1.0-20201014-042808
Migration	2.7.0-20201106-072418
Mouse	2.1.0-20201014-042814
Number	2.1.0-20201014-042823
OCR	2.2.0-20201104-062503
Microsoft 365 Excel	2.2.0-20201104-062559
Microsoft 365 Calendar	2.1.0-20200921-085726
Microsoft 365 OneDrive	2.1.0-20201014-042924
PDF	2.5.0-20201014-042929
PGP	2.2.0-20201014-042931
Ping	2.1.0-20201014-042932
Printer	2.1.0-20200921-090131
Play Sound	2.1.0-20200921-090123
Prompt	2.1.0-20200918-081201
Python Script	2.3.0-20201105-204912
Recorder	2.0.9-20201105-164103

Package	Version
REST Web Service	3.1.0-20200928-231420
SAP	2.2.0-20200921-090209
Screen	2.1.0-20201014-043037
SNMP	2.1.0-20201014-043041
Service	3.0.0-20200921-090214
SOAP Web Service	3.1.0-20200921-090219
String	3.1.0-20201014-043052
System	3.0.0-20200921-090225
Task	2.0.1-20201023-202703
Terminal Emulator	3.4.0-20201028-021451
Trigger Email	1.1.0-20201105-152220
VBScript	2.3.0-20201105-205228
Wait	3.1.0-20201014-043117
Window	2.2.0-20201022-121649
Workload	2.3.0-20201105-205233
XML	2.1.0-20201014-043121

Related reference

[Community Edition A2019.17 Release Notes](#) on page 826

## Enterprise A2019.16 Release Notes

Release date: 28 September 2020

Review the new features, supported packages, changed features, fixed features, security fixes, and known limitations in the Enterprise A2019.16 (Build 6463) release. IQ Bot is on Build 6443.

---

**Important:** We have updated Enterprise A2019.16 to Build 6463 to include fixes for issues with checking in and checking out bots (Service Cloud case ID 00666880, 00670899, 00672441, 00670455, 00672346), and Universal Recorder (Service Cloud case ID 00664020). See the [Fixed features](#) section for more information.

---

- [Enterprise A2019](#) on page 617
- [Discovery Bot](#) on page 635
- [IQ Bot](#) on page 639
- [Bot Insight](#) on page 640
- [Automation Co-Pilot for Business Users \(Automation Co-Pilot\)](#) on page 641



## Enterprise A2019

---

**Note:** Starting with this release, if you are installing the Control Room in Linux environment, ensure that Python 3.6 is installed.

---

**Important:** This release includes a required update to your . Ensure that you complete the update to continue with your automation activities when upgrading from a previous release to this release.

[Automatically update the Bot Agent](#) on page 1361 | [Manually update the Bot Agent](#) on page 1362

---

To verify which version is compatible with this release, see [Compatibility with release builds](#) on page 1333.

**New features**

Migration to Enterprise A2019 ([currently available only to customers in the Migration Early Adopter Program](#))

Enterprise A2019

Migration to Enterprise A2019 is currently only available to select customers through our Migration Early Adopter Program. If you are interested in learning more about this program or a timeline for when migration will be available to all customers, contact your Automation Anywhere representative.

- Enterprise 11 only
  - Migrate audit logs to Enterprise A2019.  
[Migrate Enterprise 11 audit logs](#) on page 1569
  - Migrate bots that contain disabled commands that have validation errors.
  - Migrate bots that contain **Delete**, **Delete All Messages**, and **Get All Messages** commands to automate an email-related task on Exchange Web Services (EWS).
- Enterprise 10 only
 

Migrate user credentials to the Enterprise A2019 Credential Vault.

[How Enterprise 10 data is copied to Automation 360](#) on page 1578
- Enterprise 11 and Enterprise 10
  - Migrate bots that contain the **Variable Operation** command, which re-initializes the row and column index of an array variable using a variable.
  - Migrate bots that run MetaBot Logic and return the values to a dictionary variable.
  - Migrate MetaBots that contain DLLs that use lists, values, arrays, and two-dimensional arrays as input and output.  
[How MetaBots are migrated](#) on page 1596
  - Migrate bots that contain **Send Email** with **Attach Variable** option from the Error Handling command to the Enterprise A2019 Error handler package.  
[Package mapping for migration](#) on page 1620
  - Migrate bots that contain the **Image** and **Coordinates** play modes from the Object Cloning command to the Recorder package in Enterprise A2019.  
[Package mapping for migration](#) on page 1620
  - Migrate bots that contain credential variables in select commands such as Active Directory, Excel, REST Web Service, and Terminal Emulator to Enterprise A2019.  
For the complete list of commands, see [Variable mapping for migration](#) on page 1655.

Support for using CSV and TXT files as databases

Enterprise A2019 and Community Edition

Use the actions from the Database package to connect with and perform create, read, and update operations on the file.

[Using Connect action for database](#) on page 2469 | [Database package](#) on page 2466

New features
<p data-bbox="329 245 1305 277">Universal Recorder support for standard Microsoft controls in Microsoft Silverlight</p> <p data-bbox="329 294 824 325">Enterprise A2019 and Community Edition</p> <p data-bbox="329 342 1409 436">The Universal Recorder can now capture calendars, buttons, check boxes, combo boxes, date pickers, labels, links, list views, radio buttons, sliders, tabs, tables, text boxes, and trees from applications running Microsoft Silverlight version 5.</p>
<p data-bbox="329 455 812 487">Use variable to specify a child bot to run</p> <p data-bbox="329 504 532 535">Enterprise A2019</p> <p data-bbox="329 552 1347 615">Use the Control Room path in the <b>Run</b> action of the Task Bot package to use a string variable to specify the child bot you want to run.</p> <p data-bbox="329 632 711 663"><a href="#">Task Bot package</a> on page 3109</p>
<p data-bbox="329 686 1289 718">Install Bot Agent in bulk using registration key (Service Cloud case ID: 00616591)</p> <p data-bbox="329 735 532 766">Enterprise A2019</p> <p data-bbox="329 783 1409 909">As an Control Room administrator, you can generate a registration key from the Control Room settings to install Bot Agent in bulk on multiple devices. You can use the registration key in an installation script or as part of the Active Directory group policy for configuring the Control Room users.</p> <p data-bbox="329 926 1120 957"><a href="#">Generate registration key to install Bot Agent in bulk</a> on page 1836</p>
<p data-bbox="329 980 1260 1043">Automatically detect proxy settings for Bot Agent installation to support NTLM authentication (Service Cloud case ID: 00446932, 00639773)</p> <p data-bbox="329 1060 824 1092">Enterprise A2019 and Community Edition</p> <p data-bbox="329 1108 1398 1234">The proxy settings for a Bot Agent are automatically detected if the <b>Automatically detect settings</b> option is selected in the LAN settings for a <b>System user</b> and <b>Current user</b> on the machine where the Bot Agent is installed. This allows Control Room users to be authenticated using NTLM.</p>
<p data-bbox="329 1264 964 1295">Restrict network access to Cloud Control Room URL</p> <p data-bbox="329 1312 532 1344">Enterprise A2019</p> <p data-bbox="329 1360 1414 1549">System administrators can restrict access to the Cloud Control Room URL from only those IP addresses within the corporate network for more granular security. The Automation Anywhere Control Room provides the ability to specify a list of IP addresses or IP subnets that are allowed for Cloud Control Room URL and API access. Enterprise A2019 users with Control Room administrator privileges, such as to access <b>Administration &gt; Settings</b>, can view, add, or edit this list.</p> <p data-bbox="329 1566 873 1598"><a href="#">Add access public IP addresses</a> on page 1808</p>

New features
<p>Add Elasticsearch credentials for enhanced monitoring and alerting</p> <p>Enterprise A2019</p> <p>An option to provide Elasticsearch credentials is now available in the installer because the updated Elasticsearch version 7.8 configured for Control Room uses Open Distro version 1.9.0. This feature enables the server to deploy an enhanced monitoring and alerting system.</p> <p><a href="#">Add OpenSearch credentials</a> on page 1259</p>
<p>Support for Chinese, Japanese, and Korean characters in variable names</p> <p>Enterprise A2019 and Community Edition</p> <p>You can now create variables with names containing Chinese, Japanese, or Korean characters. You can also migrate bots that contain variables named using these characters.</p> <p><a href="#">Unicode range supported in variables</a> on page 2341</p>
<p>Support for Chinese language for Terminal Emulator (Service Cloud case ID: 00500324)</p> <p>Enterprise A2019</p> <p>You can now use the simplified and traditional Chinese language with 5250E terminal DBCS models such as IBM 5555-C01 and IBM 5555-B01.</p>
<p>New Services package available</p> <p>Enterprise A2019 and Community Edition</p> <p>Use the new Services package to automate operations and application services. You can start, stop, pause, resume, or to get the status of a Windows or application service.</p> <p><a href="#">Service package</a> on page 3016</p>
<p>Enhancements to the Excel advanced package</p> <p>Enterprise A2019 and Community Edition</p> <p>In the Excel advanced package, you can now use <b>Read value</b> from a cell. You can choose the <b>Read</b> option to read either visible text or the value from the cell. The default option is set to <b>Read visible text in cell</b>.</p> <p>For example, if the cell has \$50 as the value, then the <b>Read cell value</b> option reads the value as 50, ignoring the currency format. The <b>Read visible text</b> option reads the content along with currency format as \$50.</p> <p>This option is available for the following actions:</p> <ul style="list-style-type: none"> <li>• Get single cell</li> <li>• Get multiple cells</li> <li>• Read row</li> <li>• Read column</li> <li>• Get worksheet as datatable</li> <li>• Loop</li> </ul> <p><a href="#">Cell operations in Excel advanced</a> on page 2586   <a href="#">Row and column operations in Excel advanced</a> on page 2581   <a href="#">Loop package</a> on page 2784</p>

New features
<p>Automate a task on a range of cells in an Excel worksheet (Service Cloud case ID: 00651299)</p> <p>Enterprise A2019 and Community Edition</p> <p>In the Excel advanced package, you can perform operations on the range of cells for <b>Go to cell</b> and <b>Set Cell</b> actions.</p> <p><a href="#">Cell operations in Excel advanced</a> on page 2586</p>
<p>New condition in the If and Loop packages</p> <p>Enterprise A2019 and Community Edition</p> <p>Use the <b>Service is running</b> or <b>Service is not running</b> condition to execute actions based on whether a particular service is running or not. For example, when you send a mail using this condition, the bot can verify if the SMTP service is running or not.</p> <p><a href="#">If package</a> on page 2724   <a href="#">Loop package</a> on page 2784</p>
<p>Capture hidden objects using AISense Recorder</p> <p>Enterprise A2019</p> <p>Use AISense Recorder to capture hidden image buttons on the application screen.</p> <p><a href="#">Edit a task recorded using AISense</a> on page 2259</p>
<p>New operations on SAP captured objects</p> <p>Enterprise A2019</p> <p>Use new options that are available to perform operations such as <b>Set Focus</b> and <b>Select item by key</b> for the various objects captured from an SAP application.</p>
<p>Pass parameters of various types to a DLL function</p> <p>Enterprise A2019</p> <p>Use the new <b>Run function</b> action to pass parameters of various types to a DLL function. The <b>Run function</b> that was available in earlier versions is now renamed to <b>Run function (Legacy)</b> and enables you to pass only dictionary variable as parameter to a DLL function.</p> <p><a href="#">Using the Run function action</a> on page 2505   <a href="#">Using the Run function (Legacy) action</a> on page 2504</p>
<p>Form builder updates</p> <p>Enterprise A2019</p> <p>The form builder now includes the following new elements:</p> <ul style="list-style-type: none"> <li>• <b>Rich text editor</b>- Enables you to add a customizable element to the form.</li> <li>• <b>Table</b>- Enables you to add tables to a form.</li> </ul> <p><a href="#">Create a form</a></p>

New features
<p>Enhancements to the form preview</p> <p>Enterprise A2019</p> <p>When you click the <b>Preview</b> option in the form builder screen, you can drag the form. The corresponding <b>X</b> and <b>Y</b> coordinates are updated automatically.</p>
<p>Enhancement to the Snapshot element</p> <p>Enterprise A2019</p> <p>You can now create a folder if the filepath is not available or change the destination folder of the snapshot file during bot runtime.</p> <p><a href="#">Using the Snapshot element</a> on page 3450</p>
<p>Update to the Interactive forms package</p> <p>Enterprise A2019</p> <p>Use the <b>Validate form</b> action to validate all the elements of a selected form.</p> <p><a href="#">Interactive forms package</a> on page 2738</p>
<p>New permission to view basic information about users and roles (Service Cloud case ID: 00491694)</p> <p>Enterprise A2019</p> <p>The <b>View Users and Roles basic information</b> permission enables you to view the names of users and roles when you are performing various tasks in the Control Room. For example, a user must have this permission to view the roles that can be assigned to a user when creating or editing that user. After you upgrade from an earlier version to this release, this permission is granted to all existing roles.</p>
<p>Securely pass values in header and parameters of calls to a REST or SOAP web service</p> <p>Enterprise A2019 and Community Edition</p> <p>Credential variables enable users to retrieve sensitive values from the Credential Vault and pass them to the web service. Use credential variables in the header or parameter fields of actions from the REST Web Service or SOAP Web Service package.</p> <p><a href="#">Credentials and credential variables in the Bot editor</a> on page 2344   <a href="#">REST Web Service package</a> on page 2961   <a href="#">SOAP Web Service package</a> on page 3084</p>
<p>Return system parameters of the device on which a bot is running</p> <p>Enterprise A2019 and Community Edition</p> <p>Use the <b>Get environment variable</b> action from the System package to return the system parameters, including HomePath, ProgramData, ProgramFiles, SystemRoot, and UserDomain.</p> <p><a href="#">Get environment variable action</a> on page 3106</p>

New features
<p>Remove Git integration configuration (Service Cloud case ID: 00633948)</p> <p>Enterprise A2019</p> <p>You can now remove or disable a Git integration configuration from your Control Room when the bot information stored in your Control Room does not have to be synchronized with the remote Git host.</p> <p><a href="#">Remove Git integration configuration</a> on page 1829</p>
<p>Expanded data type support in DLL package</p> <p>Enterprise A2019 and Community Edition</p> <p>The DLL package now accepts table variables as input parameters or to hold action output.</p> <p><a href="#">Using the Run function (Legacy) action</a> on page 2504</p>
<p>Create variable within <b>Dictionary &gt; Assign</b> and <b>List &gt; Assign</b> actions</p> <p>Enterprise A2019 and Community Edition</p> <p>The <b>Assign</b> action from the Dictionary and List packages now offers users the option to create a new variable within the <b>Select source variable</b> field. Previously, users could only select a variable from a list of existing variables.</p>
<p>New API for license management</p> <p>Enterprise A2019</p> <p>The License API contains endpoints to retrieve Control Room license details (such as the expiration date and license mode) and to update the Control Room after license reallocation or renewals.</p> <p><a href="#">License API</a></p>
<p>New expression in the Legacy Automation package</p> <p>Enterprise A2019</p> <p>The <b>List to table</b> expression supports migrated bots containing a variable that has to be converted from a list type to a table type.</p> <p><a href="#">Legacy Automation package</a> on page 2765</p>

New features
<p>Multi-user device sessions on terminal servers</p> <p>Enterprise A2019</p> <p>Multi-user device sessions are now supported on terminal servers. You can perform the following actions:</p> <ul style="list-style-type: none"> <li>• Set screen resolution at either the device or Control Room level.</li> <li>• Set a multi-user device as the default device for Bot Creator users and attended and unattended Bot Runner users.</li> <li>• As a licensed user (with a default device), set another device as your default device using the <b>Make default device</b> option from the device menu.</li> <li>• View and edit the device settings on the device landing page.</li> </ul> <p>The device landing page shows additional information about the user-provided device name (device nickname), device type, and the default user.</p> <ul style="list-style-type: none"> <li>• Convert an existing device to a multi-user device in order to share the same device between Bot Runner and Bot Creator users who can then coexist in different sessions simultaneously. (Service Cloud case ID: 00624046)</li> </ul> <p><a href="#">About multi-user devices</a> on page 1876   <a href="#">Convert an existing device to a multi-user device</a> on page 1879   <a href="#">Configure RDP-based deployment for multi-user devices</a> on page 1877</p>

Supported packages	
Package	Version
Node Manager	14.1.7079
Application	2.1.0-20200819-064505
App Integration	1.1.0-20200825-070948
Analyze	2.2.4-20200903-113949
Active Directory	2.1.0-20200825-070945
Boolean	2.1.0-20200831-031000
Bot Migration	2.5.0-20200902-045043
Browser	2.1.0-20200825-071008
Clipboard	2.1.0-20200831-031014
Comment	2.1.0-20200831-031015
CSV/TXT	2.3.0-20200825-071131
Database	2.1.0-20200913-060112
Data Table	2.1.0-20200831-031946
Datetime	2.2.0-20200831-031025
Delay	2.2.0-20200831-031026
Dictionary	3.2.0-20200831-031027



Supported packages	
Package	Version
Run DLL	3.0.0-20200831-110441
Email	3.0.0-20200901-105426
Error handler	2.1.0-20200831-031055
Excel basic	2.1.0-20200831-031843
Excel advanced	5.0.0-20200909-124042
File	2.2.0-20200831-031057
File & folders	1.1.0-20200907-073046
Folder	2.2.0-20200831-031100
FTP / SFTP	2.1.0-20200825-071155
IF/ELSE	2.1.0-20200825-071156
Image Recognition	2.1.0-20200825-071159
Interactive forms	2.16.0-20200914-151814
IQ Bot	2.1.0-20200901-105449
JavaScript	2.1.0-20200831-031525
Simulate keystrokes	2.3.0-20200901-093759
Legacy Automation	3.1.0-20200831-031532 1.1.0-20200825-071342
List	2.2.0-20200831-031539
Log To File	2.2.0-20200831-031539
Loop	2.1.0-20200831-031540
Message Box	2.1.0-20200831-031541
Migration	2.5.0-20200902-045043
Mouse	2.1.0-20200831-031542
Number	2.1.0-20200831-031551
OCR	2.2.0-20200825-071359
Microsoft 365 Excel	2.1.0-20200825-071452
Microsoft 365 Calendar	2.1.0-20200825-071013
Microsoft 365 OneDrive	2.1.0-20200825-071459
PDF	2.5.0-20200831-031836
PGP	2.2.0-20200831-031838
Ping	2.1.0-20200831-031839
Printer	2.1.0-20200825-071516

Supported packages	
Package	Version
Play Sound	2.1.0-20200825-071509
Prompt	2.1.0-20200824-092056
Python Script	2.1.0-20200831-031850
Recorder	2.0.8-20201009-015051
REST Web Service	3.1.0-20200824-092129
SAP	2.2.0-20200825-071614
Screen	2.1.0-20200825-071618
SNMP	2.1.0-20200825-071620
Service	3.0.0-20200821-060952
SOAP Web Service	3.1.0-20200827-210959
String	3.1.0-20200831-031943
System	3.0.0-20200831-031944
Task	2.0.1-20200907-072949
Terminal Emulator	3.3.0-20200831-031950
Trigger Email	1.1.0-20200903-114514
VBScript	2.1.0-20200831-031953
Wait	3.1.0-20200831-031955
Window	2.1.0-20200813-181240
Workload	2.1.0-20200825-071644
XML	2.1.0-20200831-031958

Changed features
<p>Enhanced Capture area action in OCR package</p> <p>The <b>Capture area</b> action now captures text from the visible area of the screen even if the target area is below the visible screen. Previously, the bot showed an error when the captured area was below the visible screen.</p> <p><a href="#">Using Capture area action from OCR package</a> on page 2809</p>
<p>Bot Scanner update</p> <p>The Bot Scanner now displays error messages for bots that cannot be migrated to Enterprise A2019 in the summary report.</p> <p><a href="#">Analyze Bot Scanner report for migration</a> on page 1534</p>
<p>Flow view update</p> <p>A line number is now displayed for each action in the <b>Flow</b> view of the Bot editor.</p>

Changed features
<p>CSV/TXT package update</p> <p>The CSV/TXT package processes a space as character. For example, if your CSV or text file includes <code>January, "March, April"</code>, then the output is displayed in the following format:</p> <p>January "March (space before the double quotation mark) April"</p> <p>If the CSV or text file contains the same information but without a space between January and March (for example, <code>January, "March, April"</code>), then the output is displayed in the following format:</p> <p>January March, April</p>
<p>Upgrade for resilient bot deployment</p> <p>After you upgrade the Control Room and Bot Agent to Enterprise A2019.16, scheduled and queued bots are not terminated. This is part of the resiliency improvements where the Control Room and Bot Agent are set in a consistent state. As a result, the device reconnects to the Control Room if there are any network disruptions, and scheduled and queued bots are deployed.</p> <hr/> <p><b>Important:</b> During the upgrade to Enterprise A2019.16, all bots that are running will be terminated. After the upgrade, if the system is in an inconsistent state, restart the Bot Agent so that the system is in a consistent state.</p> <hr/>
<p>Internet Explorer waits for completion before initiating Recorder action</p> <p>When you use the Recorder package, the bot now waits for the Internet Explorer browser to finish loading the page before executing any action. This enhances the reliability of the bot by preventing it from failing while the page is loading. For example, the Recorder does not try to search the object before the web page is fully loaded.</p> <p><a href="#">Using the Capture action</a> on page 2940</p>
<p>High availability enhancement</p> <p>Starting from this release, configure the required minimum three Control Room nodes in an Enterprise A2019 data center cluster for high availability deployment.</p> <p><a href="#">High availability deployment</a> on page 1235</p>

The following table lists the fixed features and the builds in which they were fixed (Build 6463 is the latest build, and Build 6453, and Build 6448 are previous builds). The fixes are cumulatively available in the latest build.

Fixed features		
Build number	Service Cloud case ID	Description
6463	00644915	The Bot Agent now checks for additional SSL certificate from the Windows CERT_SYSTEM_STORE_LOCAL_MACHINE system stores in addition to the Java Credential Store. This allows the Bot Agent to be updated automatically from an earlier release to this release.
6463	00666880, 00670899, 00672441, 00670455, 00672346	Bot files or dependencies are no longer lost when you check in or check out a bot from the private or public workspace. Previously, an error occurred while either checking in or checking out a bot, and the bot files or dependencies were lost and could not be recovered.
6463	00664020	You can now successfully run a bot that contains the <b>Capture</b> action from the Recorder package with both the HTML InnerText and InnerHTML object properties selected.
6463	--	Fixed an issue where the Universal Recorder failed to perform a click, set text, or append text action on the correct control in Google Chrome when a debug window or download bar was open.
6453	00669040, 00669164, 00668923, 669332, 00669473, 00671509, 00669178	The Automation Anywhere Elastic Search Service now restarts during the certificate retrieval process when you upgrade from Enterprise A2019.15 to Enterprise A2019.16. However, if you encounter any issues with the Automation Anywhere Elastic Search Service during the restart, see <a href="#">Automation 360 v.16 upgrade error: Elasticsearch Service fail to start during certificate retrieval process (A-People login required)</a> .
6448	00573048	You can now preview table variables in debug mode and validate the bot logic. Previously, watch variables containing Japanese and Chinese characters did not display values in the table variable.
6448	00656475	The Bot Deploy API call now consecutively executes all the runAs users that are set in the runAsUserIds parameter.

Fixed features		
Build number	Service Cloud case ID	Description
6448	00569832, 00628474, 00656267	The device registration issue due to Bot Agent version extraction is now fixed. The exception of "for input string null" no longer occurs.
6448	00609073	You can now successfully integrate your Control Room with your remote Git repository without any error. Previously, the Git integration failed because of a 404 error.
6448	00632444, 00626829, 00667531	When you import a main task containing subtasks using the overwrite option, the dependent subtask references are no longer deleted for other existing main tasks that use the same subtasks. As a result, the execution of other main tasks containing the same dependent subtasks does not fail.
6448	00501208, 00572346	For the <b>Create user</b> event name, the audit log now properly displays the username who created that user in the <b>Event Started By</b> column. Previously, the same column did not display any value.
6448	00616202, 00637626, 00653919, 00664039, 00664744	When the debug log is enabled in logs configuration and you use the <b>For each row in a SQL query dataset</b> option from the Loop action to iterate each row, the iteration now completes without any error. Previously, the iteration failed because of a change in the debug log configuration.
6448	00653064	After the caching service is restarted, the bot execution no longer fails. The caching client instances are reconnected and reinitialized after the restart.
6448	00577612	In a bot with dependencies, if you check out and edit a child bot in your private workspace and later check out the parent bot, you will no longer lose the changes made to the checked-out child bot. Previously, changes made to the child bot were overwritten.

Fixed features		
Build number	Service Cloud case ID	Description
6448	00623154	When a Bot Creator that does not have create folder permission tries to check in a bot to the public workspace, an appropriate error message is now recorded in the audit log, indicating the specific reason for the failure. Previously, the audit log recorded an <code>unexpected error occurred</code> message.
6448	00622977	In the <b>Edit role</b> page, file permissions are now correctly aligned in Internet Explorer. Previously, the <b>Delete from Public</b> option was displayed below the <b>Select all</b> option. As a result, the folder and permissions were not placed next to each other.
6448	00615437	You can now migrate MetaBots that contain input and output type variables with a description containing unsupported characters such as quotation marks (") and forward slash (/).
6448	00636169	The Control Room now disables a user account when the number of consecutive failed login attempts specified in the Control Room settings is reached or exceeded.
6448	00530550	A variable now returns the correct value when the regional setting of the device is set to the Brazilian metric system.
6448	00604893	A bot no longer encounters an error when the system cannot finish pre-processing the bot due to an ignite cache issue.
6448	00578277	An error is no longer encountered when the <b>Connect</b> and <b>Disconnect</b> actions of the SAP package are used in a loop and the iteration is set to more than 500 times.
6448	00635890	The Bot Scanner now scans all the bots in a repository and displays the correct count of child bots.
6448	00634238	You can now use the form builder in Internet Explorer (version 11 or later) to add more items to the <b>Checkbox</b> and <b>Radio Button</b> elements without encountering any issues.
6448	--	For the <b>Select file</b> element, you can now upload a file with a dot (.) in the filename. For example, <code>Sales.March.jpg</code> .

Fixed features		
Build number	Service Cloud case ID	Description
6448	--	Software version notification for Cloud was not always displayed in the UI. This issue is now fixed.
6448	00633793	You can run a bot when the operational parameter is used in the <b>SOAP Web Service</b> action. Previously, the bot encountered errors when the operational parameter was used in the action and the corresponding <code>wsdl</code> file did not have the <code>elementFormDefault</code> attribute.
6448	00630975	Captured images in a nested <b>If</b> action are now retained when you check in a bot to the public repository. Previously, when using any action that used an image in a nested <b>If</b> action, the image nested was missing after the check-in.
6448	00630004	When loop is used to read all <b>Unread</b> emails, the emails are now marked as <b>Read</b> only after emails are read. Previously, all unread emails were marked as read when a <b>Loop Break</b> action was used.
6448	00612913	In <b>Excel Advanced &gt; Remove blank rows</b> , when you select the <b>Specific row</b> option and set A1 as the beginning cell, an error is no longer encountered when you run the bot.
6448	00608265	In the CSV/TXT package, when you use Japanese OS ANSI (Shift-JIS) as encoding to read text file content, the Japanese Shift-JIS characters are now displayed correctly.
6448	00568718	Japanese language supported pop-up messages no longer appear truncated when multiple bots are deleted.
6448	00598023, 00611480	In the <b>DLL</b> package, <b>Run function</b> now works properly and does not display an error or show broken characters when the parameter includes Japanese characters.
6448	00638120	When you upgrade from an earlier version of Enterprise A2019 to a later version and change the <b>If</b> package version to the latest one, multiple conditions now appear in <b>If/Else If</b> after the <b>If</b> package is upgraded. Previously, some of the conditions did not show in the logic.

Fixed features		
Build number	Service Cloud case ID	Description
6448	00632228, 00649606	You can now use the <b>Send Email</b> action when the package version is different in the task and subtask. Previously, the <b>Send Email</b> action in the <b>Email</b> package had issues when the task and subtask had a different package version.
6448	00544219, 00635206	The <b>Get cell</b> action in <b>Excel Advanced</b> can now be used without any error. You can use the <b>Read</b> option to read visible data or the exact value of the cell.
6448	00646254, 00650712, 00653137, 00658122, 00666883	You can now change the package version of the <b>If</b> package. Previously, if there were multiple conditions in the <b>If</b> action, the system did not allow you to change the package version.
6448	00613453	Version 11.3 bots that used the Object Cloning command to find interface objects using coordinates or image recognition are now migrated to Enterprise A2019 with the <b>Mouse &gt; Click</b> action, <b>Simulate keystrokes</b> action, <b>OCR &gt; Capture area</b> action, or <b>Image recognition &gt; Find window in window</b> action.
6448	--	When you run migrated bots that perform mathematical operations on values containing decimals or commas, the output from Enterprise A2019 now matches the output from Version 11.3.5. Previously, an operation that resulted in an output of 0.999 in Version 11.3 resulted in an output of 0.9899999 in Enterprise A2019.
6448	00467664	Fixed an issue where the Universal Recorder entered characters in a text box incorrectly when the user configured the <b>Keystrokes</b> field using a Japanese keyboard.
6448	00630545, 00631418, 00621875	You can now assign input values from a parent bot in the <b>Task Bot &gt; Run</b> action. Previously, an issue caused input values to disappear when a bot containing more than two input values was saved.
6448	--	The Workload <b>In progress</b> activity page now displays the Workload bot name instead of the automation name.



Fixed features		
Build number	Service Cloud case ID	Description
6448	00635306	Fixed an issue where a red error screen appeared if a bot attempted to pass a file variable to another bot.
6448	00635326	You can now run bots built using Recorder package versions from earlier builds.
6448	00616261	You can now pass credential values to the main bot when you deploy it from the <b>Run bot now</b> page.
6448	00647135, 00647652, 00647665, 00647144, 00648742, 00646535, 00648883, 00648980, 00654937, 00657039, 00664049, 00663797, 00664138, 00667384	When you upgrade to the latest version of Enterprise A2019, bots in queued state now run without any issues because a new token is automatically generated when an existing session expires.
6448	00611109	Fixed an issue where the <code>\$System:CPUUsage\$</code> system variable returned an inaccurate value.
6448	00647239	In the Data Table package, when you use the <b>Merge</b> action to merge two data tables, the data is now properly merged and the merged content stores the correct data in the result data table. Previously, the <b>Merge</b> action had issues when no header data in a table was extracted, resulting in incorrect data export to CSV file.
6448	00444907, 00556374, 00582469, 00628801, 00624681, 00632668	A bot launcher error for a user session is no longer displayed when you run a bot on a Bot Agent device registered to a user who is assigned developer privileges.

Security fixes	
Service Cloud case ID	Description
00552076	The vulnerabilities found in Elasticsearch in Enterprise A2019 are now addressed.
00631233	In the Database package, when you connect to the database, the username and password are no longer visible in the logs.

Known limitations
<p>When you are upgrading from an earlier version of Enterprise A2019 to the current version, the system displays the error message <b>Self Sign Certificate Failure</b>, and the installation process is rolled back if both the following conditions occur:</p> <ol style="list-style-type: none"> <li data-bbox="331 365 1416 491">1. The earlier version was installed on a non-default installation path instead of the default path (C:\Program Files\Automation Anywhere\Enterprise). For example, the previous version was installed on D:\Program Files\Automation Anywhere\Enterprise.</li> <li data-bbox="331 506 1406 600">2. You also select <b>Yes</b> to retain the current installation parameters during upgrade in the message window that appears after the <b>Welcome</b> screen when the installation wizard detects an earlier version.</li> </ol> <p>Workaround: Select <b>No</b> so that you can choose to enter the installation parameters during the upgrade.</p> <p><a href="#">Control Room upgrade fails with self signed certificate failure error (A-People login required)</a></p>
<p>Service Cloud case ID: 00672719, 00673048</p> <p>When you are upgrading the Control Room to the current version, the installer uses an existing or creates a new Elasticsearch data folder in the default path (C:\ProgramData\AutomationAnywhere\elasticsearch\data) if the Elasticsearch data from the earlier version is saved to a non-default path. Therefore, the earlier Elasticsearch data and audit logs will not be available after the upgrade.</p> <p>Workaround: Before upgrading to the current version, copy the existing Elasticsearch data from the non-default path to the default path.</p>
<p>When an Automation Anywhere package is manually uploaded using the Control Room interface, the <b>Vendor</b> column should show Automation Anywhere. Instead, the interface displays <b>Unspecified</b>. Automation Anywhere packages that are installed on a server as a part of an upgrade show the <b>Vendor</b> as Automation Anywhere, which is expected.</p>
<p>For existing device sessions, you cannot use the option to enforce the resolution set at either the device or Control Room level. The screen resolution set at these levels only work for new device sessions.</p>
<p>When attended and unattended Bot Runners are run concurrently, attended Bot Runner users are queued until the unattended Bot Runner session becomes available. This occurs even when the number of allowed concurrent sessions is not exceeded. For an attended Bot Runner user deployment, use a single user session to stop them from being queued.</p>
<p>When a user connects to a multi-user device and sets it as their default device, they are taken through the device registration wizard to enable the Google Chrome plug-in. During the registration process, users are allowed to select the device type and the concurrent sessions value. Users must ensure that they set the same value for the concurrent sessions as set by the administrator. If there is a difference in the value, other users will be impacted.</p>

Known limitations
<p>When a bot is deployed through RDP with a predefined screen resolution, the RDP resolution settings are not applied correctly during bot execution. The bot is executed with an interchanged resolution (the height and width pixels are interchanged). For example, if the resolution for bot deployment is set as 1366x768, the bot is deployed with the resolution 768x1366.</p> <p>Workaround: For information about how to resolve this issue, see <a href="#">Automation 360 v.16 - RDP based deployment does not run bot with pre-defined set screen resolution (A-People login required)</a>.</p>
<p>The element label or text appears distorted during bot runtime when you add it in Japanese or any other non-English language, and the <b>Font name</b> is set to <b>System default</b>.</p>
<p>Service Cloud case ID: 00667210</p> <p>In Excel advanced, you cannot use the <b>Go to cell</b> action if the Excel sheet does not have data or if an active cell is out of the worksheet range. This issue is encountered when you use the <b>Go to cell</b> action and choose the cell option as <b>Active cell</b> with the <b>Beginning of the row</b>, <b>End of the row</b>, <b>Beginning of the column</b> or <b>End of the column</b> option.</p> <p>Workaround: Use the earlier version of the Excel advanced package 4.0.0-20200723-234413 released with Enterprise A2019.15.</p>
<p>HTTP authenticated proxy is not supported for On-Premises users.</p>

## Discovery Bot

New features
<p>Discovery Bot installer integrated with Enterprise A2019 installer</p> <p>Enterprise A2019</p> <p>The Discovery Bot installer is now integrated with the Enterprise A2019 installer. No separate installation is required for Discovery Bot On-Premises users. Discovery Bot supports custom installation for Windows.</p> <p><a href="#">Prerequisites for Discovery Bot</a> on page 3896</p>
<p>Create multi-role users</p> <p>Enterprise A2019</p> <p>Combine up to three Discovery Bot system-generated roles and two process discovery licenses to provide additional functionality for your users.</p> <p><a href="#">Create multi-role users for Discovery Bot</a> on page 3900</p>

New features
<p>Create custom role user</p> <p>Enterprise A2019</p> <p>Create a unique custom role using the permissions from the Discovery Bot standard user roles (Admin, Business user, or Analyst roles).</p> <p><a href="#">Create a custom role for Discovery Bot</a> on page 3902</p>
<p>Manual aggregated view integrated with Dashboard tab</p> <p>Enterprise A2019</p> <p>The Manual aggregated view is now integrated with the Dashboard tab. You can now select and display recordings and views from the <b>Dashboard</b>, <b>Aggregated</b>, and <b>Comparison</b> tabs, enabling you to make a change in one tab that will persist across all tabs. This feature enables a synchronized representation of your metadata for views and recordings.</p>
<p>Internalization, localization, and language support for Discovery Bot</p> <p>Enterprise A2019</p> <p>Internalization and localization is now supported for Discovery Bot. For example, you can automate and translate the UI for your region in French, Spanish, and Italian, among other languages supported.</p> <p><a href="#">Internationalization, localization, and language support</a> on page 1214</p>

Fixed features	
Service Cloud case ID	Description
--	You can now sort on the recording ID. The recent recording (ID) created now displays at the beginning of the list in the Recordings table.
--	When editing the aggregated view, you can now move the endpoint upward in the path flow to change the selection of the steps. You can also move the branch endpoint lower in the path flow to include more than one step.
--	You can now select partial steps in a branch, and create and save an opportunity from the <b>Opportunities</b> tab.
--	The copy field now displays the correct view information from the view (view ID) that it is copied from.
00673381	If you are using an instance in an AWS special region, you can now view recordings for users that are successfully completed (not canceled by the user).

Known limitations
When manually editing an aggregated view, if you create a branch in the process flow where a step was deleted, the step will be missing on the left side of the branch. To add a step on the left side, you can drag the branch endpoint (small circle) down (below the next step) in the process flow to add a step back in the branch. <a href="#">Missing step observed in aggregated view while using A2019.16 Discovery Bot (A-People login required)</a>
When an opportunity is created with 300+ steps, exporting the opportunity to Microsoft Word will fail.
The <b>Convert to Bot</b> option fails when an opportunity contains 140 or more steps.

## IQ Bot Community Edition

The IQ Bot Community Edition is available for this release and has feature parity with IQ Bot Version 11.3.4.2.

[Automation 360 IQ Bot feature comparison matrix](#) on page 1005

[Automation 360 IQ Bot version compatibility](#) on page 1010

---

**Important:** This new Community Edition includes a preview of IQ Bot with Auto-extraction.

---

Community Edition for IQ Bot is a special version of our product in the Cloud, available for all users who want to try RPA and IQ Bot at no cost. Users are not required to purchase a license, and there are no time limitations. However, there are some functionality constraints as follows:

- Users can create learning instances using pre-trained Invoices in English only.
- Users can create up to a maximum of 5 learning instances per user account.
- In the Learning Instance list, users can see and access only those learning instances and data created by them.
- Users can process up to a 100 pages per month for each user account.

[Document Automation Community Edition](#) on page 3724

New features (using auto-extraction)
Create a learning instance Use a pre-trained invoice (document type) to process and validate your documents in English (only). <a href="#">Create a learning instance in Community Edition</a> on page 3726
Extract data from documents Create a bot to extract data from documents using the learning instance you created.
Validate documents Validate failed documents manually using the validator form. <a href="#">Process documents in Community Edition</a> on page 3728

**New features (using auto-extraction)**

## Bot Insight integration

View learning instance dashboard metrics that is integrated with Bot Insight.

## Use the IQ Bot (Preview) package

Use the IQ Bot (Preview) package to process and validate documents using Enterprise A2019.

**Changed features**

For the Custom Logic feature, the identified list of Python libraries now includes an additional set of safe libraries for IQ Bot Community Edition. Go to Automation Anywhere support for a list of the safe libraries you can use.

**Fixed features (using Auto-extraction)****Service Cloud case ID****Description**

00628958

The Task Bot now successfully processes all documents without displaying any error messages.

**Known limitations (using Auto-extraction)**

PDF documents with raster format or JBIG2 encoding are not supported.

Workaround: Convert such documents to one of the supported formats before processing your documents for data extraction.

**Note:** Digital PDFs, JPEG, JPG, and PNG are supported formats.

Rotated documents are not supported.

Workaround: Pre-process such documents to correct their orientation before data extraction.

Only a predefined set of form and table fields are supported. The table header does not support multiple fields in a single column.

During the validation process, if a user deletes all rows from a table, the user is unable to add a new row.

Workaround: Perform these steps:

1. Cancel the validation user form and open the document again.
2. Create a new row before deleting the unwanted rows.

Known limitations (using Auto-extraction)
<p>Documents that are pending review from Enterprise A2019.15 cannot be validated in Enterprise A2019.16 using the <b>Review documents</b> option.</p> <p>Workaround: Create a Task Bot using the IQ Bot <b>Validation</b> action in the Enterprise A2019.15 package, and validate the review pending documents.</p>

## IQ Bot

New features
<p>Updates to IQ Bot Pre-processor package</p> <p>On-Premises and Cloud</p> <p>You can now perform the following tasks using the new actions in the IQ Bot package:</p> <ul style="list-style-type: none"> <li>• Link or combine two images using <b>Concatenate image</b></li> <li>• Adjust the size of the selected image file using <b>Edit image</b></li> <li>• Enhance the image resolution and other aspects using <b>Enhance image</b></li> <li>• Change the image orientation such as angle using <b>Orient image</b></li> </ul> <p><a href="#">IQ Bot Pre-processor package</a> on page 2742</p>
<p>IQ Bot [Local Device] package enhancements</p> <p>The IQ Bot [Local Device] package now enables you to add custom logic (Python scripts) in the Designer to extend text extraction and validation capabilities.</p> <p><a href="#">Add custom logic in IQ Bot to improve extraction</a></p>

Fixed features	
Service Cloud case ID	Description
00590165	You can now train the selected document because error messages are no longer displayed when you click <b>Learning instances &gt; See extractions</b> for a group.
--	If you remove a bot ( <b>Delete a bot</b> ) associated with a document from the staging environment, you must create a group before uploading this document to the production environment. After deleting the bot from the staging environment, you can now create or edit the group when you upload the same document to the production environment.
00601840	You can now view a public bot without any errors when you click <b>BOTS &gt; My bots &gt; PUBLIC</b> in Enterprise A2019.
00672482	You can now validate documents with a large number of fields (more than 100) and navigate between multiple documents without any issues on the .

Fixed features	
Service Cloud case ID	Description
00648013, 00670191	You can now migrate, export, import, or download IQ Bot learning instance backup (.iqba) files of up to 1.4 GB. The previous limit was 600 MB.

Known limitations	
Migration of learning instances does not get completed if the IQBA file size is more than 2 GB. Workaround: <a href="#">Migration of learning instance is not getting completed if the IQBA is more than 2GB (A-People login required)</a>	
In the IQ Bot Designer, sometimes while training documents when the user clicks <b>See extraction results</b> , an error message appears and the user cannot proceed with the task.	
You cannot access Cloud OCR through a proxy server in IQ Bot.	
In IQ Bot Community Edition, when you click <b>New instance</b> to create a learning instance, the <b>My learning instances</b> page appears and then automatically reloads after a few seconds. Workaround: Wait until the page reloads before you start entering the details to create a learning instance.	

## Bot Insight

New features	
Power BI connector available as part of Microsoft Power BI desktop Enterprise A2019 and Community Edition The Automation Anywhere connector for Bot Insight is now certified and officially a part of the Microsoft Power BI Desktop August release. <a href="#">Data connector for Power BI</a> on page 3956	
Business analytics support for attended Bot Runners Enterprise A2019 and Community Edition Business analytics data is now logged when bots are run with attended Bot Runners licenses. Also, a new attribute <b>User Name</b> is available in the <b>Business Dashboard</b> in <b>Transaction Data</b> . This attribute shows the user who is running the bot.	



**Changed features**

Convert bot duration metric to percentage

In the **Device** dashboard, when you select the metric as **Bot Duration**, you have an additional option to convert the bot duration to percentage. This option appears only if a selected group or subgroup is of date type variable.

[Operations dashboard](#) on page 3932

**Known limitations**

Due to security reasons, you cannot access the following Bot Insight APIs and a 403 forbidden error is displayed.

```
GET/v2/botinsight/data/api/gettasklogdata
GET/v2/botinsight/data/api/gettaskvariableprofile
DELETE/data/api/deletetasklogdata
GET/data/api/getbotrundata
GET/data/api/getaudittraildata
```

**Automation Co-Pilot for Business Users (Automation Co-Pilot)**

**Important:** This Automation Co-Pilot version is available for all users starting from Enterprise A2019.16.

**New features**

Assign tasks

Enterprise A2019

Automation Co-Pilot managers and users can now assign tasks. Managers can assign and reassign tasks to any users from teams with an assigned process. Users can assign tasks to other users of the same team.

[Assign or unassign a task](#) on page 3390

Filter and search tasks

Enterprise A2019

Automation Co-Pilot users can now perform the following tasks:

- Filter, sort, and search tasks for quick results
- Search task names using **Search Title**
- Sort by completed, pending, and unassigned tasks using the **Filter** option
- Configure results based on assignee or title using **Advanced filter**
- Click a column to sort by ascending or descending orders

[Filter and search for a task](#) on page 3393.

New features
<p>Summarized information of tasks</p> <p>Enterprise A2019</p> <p>The <b>Tasks</b> tab in the main page shows statistical insight for the numbers of completed, pending, and unassigned tasks.</p>
<p>Process package</p> <p>Enterprise A2019</p> <p>The <b>Process</b> package enables users to create a request inside a specified process from a bot.</p> <p><a href="#">Process package</a> on page 2904</p>
<p>Preview bot</p> <p>Enterprise A2019</p> <p><b>Human Tasks</b> and <b>Bot Tasks</b> now include the <b>Preview bot</b> option, which enables users to quickly preview relevant bot or forms information.</p>
<p>Process editor metadata</p> <p>Enterprise A2019</p> <p><b>Human Tasks</b> and <b>Bot Tasks</b> now accept username and email metadata. Users can enter the name and email values to their process workflow such as <code>\$Task.assignedTo{username}\$</code> and <code>\$Task.assignedTo{email}\$</code>.</p>
<p>Enhancements to roles</p> <p>Enterprise A2019</p> <p>The Automation Co-Pilot admin can now assign a process to a team they created and become the manager assigned to that process. The admin can also assign a process to a team they did not create and the manager of that team is assigned to the process.</p>
<p>Administration permission</p> <p>Enterprise A2019</p> <p>The Automation Co-Pilot admin and manager are now assigned a new <b>Administration</b> permission by default called <b>View Users and Roles basic information</b>. The admin can now view the process management page to assign or unassign managers.</p>

Changed features
<p>Process management page</p> <p>The process management page in Automation Co-Pilot on the web is now removed for managers.</p>
<p>Password field in request view</p> <p>The <b>Password</b> element is now removed when viewed in the request tab.</p>

Fixed features	
Service Cloud case ID	Description
--	A team name is no longer limited to 20 characters.
--	When you open many request tabs, the navigation bar now functions properly and allows you to navigate to your tabs by using the arrow icon.
--	When you view tasks in the request view, the request and task now show the correct status.
--	The manager can now be removed in the process management page.
--	The bot status in the request view is now represented as a progress bar.
--	The <b>Element name</b> field in the process editor now shows the correct error message when the field contains spaces.
--	When you select the <b>Make field uneditable</b> option for the <b>Checkbox, Date, Dropdown, Number, Password, Radio Button, Text Area, and Text Box</b> elements, the values can no longer be edited.
--	The team management page now shows the <b>Owner</b> column.
--	When number values are entered in a number field, such as a phone number box, the values are now accepted.
--	In the device pool configuration page, the Bot Runner users check box is now selected.
--	The <b>Checkbox</b> and <b>Radio Button</b> elements now support horizontal format.
--	The <b>Document</b> element can now access the <b>Open the doc in browser</b> link.
--	The <b>Number</b> element values are no longer limited to 8 characters and can now be rendered properly when the values contain trailing zeroes, commas, and decimals.
--	When you select the <b>Insert a variable</b> option in the process editor, the <b>Variable</b> field now shows specific variable names.
--	The redo functions now works properly in the process editor.
--	The <b>Text Box</b> element now accepts number-only inputs.
--	The timestamp of the closing step now shows the timestamp of the last step in request view.
--	When you access a public process, the existing variable in the field can no longer be changed.

Fixed features	
Service Cloud case ID	Description
--	The <b>Masked data</b> option is now fully supported for all elements.
--	When you edit a checked-out process that contains conditional steps with variables, you can now edit and save these conditional steps.
--	When a process is configured with two forms that contain a <b>Dropdown</b> element, the process creation shares the <b>Dropdown</b> element data between the forms. The <b>Dropdown</b> element in the second form now receives data from the first form.
--	The manager can now access their team without encountering any errors.
--	You can now update values in a prepopulated text field in request view.
--	When you create a request and encounter a preprocessing error, the request creation ends and the request view now shows the failed status.
--	The <b>Go To</b> option in the process editor now shows the <b>Human Task</b> or <b>Bot Task</b> name.
--	Users with the Automation Co-Pilot manager and user roles are now automatically redirected to the web interface when they access the Control Room URL.

Known limitations	
When you provide your <b>Bot Task</b> and <b>Human Task</b> the same element name, an error occurs for the <b>Go to</b> element, but the process editor does not prompt an error. Workaround: Create unique element names for your <b>Bot Task</b> and <b>Human Task</b> .	
When you create a form that contains a <b>Document</b> element and access your <b>Human Task</b> in the process editor, you cannot assign your variable because the <b>Add element</b> option is not available.	
The <b>Display message</b> field in the <b>If/Else pair</b> action does not function correctly when displaying a message in request view.	
The titles ( <b>Title</b> field) of completed requests in Automation Co-Pilot on the web are replaced by endpoint display names.	
When you create a form that contains a <b>Number</b> field set to a 10-character limit and you enter 1234567890 in the number field in request view, the number values are not accepted.	
When you create a process with a form that contains a <b>Date</b> element, the <b>Condition</b> option in the <b>If/Else pair</b> action does not allow you to enter a variable.	

## Enterprise A2019.15 Release Notes

Release date: 14 August 2020

Review the new features, supported packages, changed features, fixed features, security fixes, and known limitations in the Enterprise A2019.15 (Build 5933) release. IQ Bot and Discovery Bot are on Build 5931.

- [Enterprise A2019](#) on page 645
- [Discovery Bot](#) on page 655
- [IQ Bot](#) on page 656
- [Bot Insight](#) on page 660
- [Automation Co-Pilot for Business Users](#) on page 660

## Enterprise A2019

To verify which version is compatible with this release, see [Compatibility with release builds](#) on page 1333.

New features
<p>Introducing Discovery Bot and Automation Co-Pilot for Business Users</p> <p>Enterprise A2019</p> <p><a href="#">Discovery Bot</a> on page 655   <a href="#">Automation Co-Pilot for Business Users</a> on page 660</p>
<p>Migration from Enterprise 11 and Enterprise 10 to Enterprise A2019 (<a href="#">currently available only to those in the Migration Early Adopter Program</a>)</p> <p>Enterprise A2019</p> <p>Migration to Enterprise A2019 is currently only available to select customers through our Migration Early Adopter Program. If you are interested in learning more about this program or a timeline for when migration will be available to all customers, contact your Automation Anywhere representative.</p>
<p>Perform an action on multiple objects of the same type</p> <p>Enterprise A2019</p> <p>The variable anchor in AISense Recorder enables you to perform an action on multiple objects of the same type.</p> <p><a href="#">Use variable anchor</a></p>
<p>Run Enterprise 11 bots from Enterprise A2019</p> <p>Enterprise A2019</p> <p>The V11 Task Bot package enables you to run Enterprise 11 bots from Enterprise A2019 in the Enterprise 11 Control Room.</p> <p><a href="#">V11 Task Bot package</a> on page 3149</p>

New features
<p>Enhancements to the Interactive forms</p> <p>Enterprise A2019</p> <p>Interactive forms include the following updates:</p> <ul style="list-style-type: none"> <li>You can include the <b>Dynamic</b> element of the selected form in the <b>Change label</b> action.</li> <li>In the <b>Dynamic area</b> actions: <ul style="list-style-type: none"> <li>You can add a maximum of four elements for the <b>Add row in Dynamic area</b> action.</li> <li>In the <b>Add element</b> screen, use additional options from the <b>Type</b> drop-down menu such as Checkbox, Dropdown, File, Snapshot, RadioButton, Text Area, and TextBox.</li> </ul> </li> </ul> <p><a href="#">Interactive forms package</a> on page 2738</p>
<p>Support for interactions with Oracle EBS tables</p> <p>Enterprise A2019 and Community Edition</p> <p>Use the Universal Recorder or the <b>Recorder &gt; Capture</b> action to read data from an Oracle EBS table. The following actions are now supported:</p> <ul style="list-style-type: none"> <li>Get Total Row</li> <li>Get Total Column</li> <li>Get Cell text by Index</li> <li>Get Cell index by text</li> </ul>
<p>Expanded data type support in DLL package</p> <p>Enterprise A2019 and Community Edition</p> <p>The DLL package now accepts dictionary and list variables as input parameters or to hold action output.</p> <p><a href="#">Using the Run function (Legacy) action</a> on page 2504</p>
<p>Create device pools using API</p> <p>Enterprise A2019</p> <p>You can now create a device pool and add unattended Bot Runners to the device pool using an API. This API uses deviceId, automationScheme, ownerId, and consumerId as parameters to create a device pool.</p> <p><a href="#">Device Pools API</a></p>

Supported packages	
Package	Version
Node Manager	12.1.6000
Application	2.0.0-20200721-221935
App Integration	1.0.0-20200721-221933
Analyze	2.2.3-20200624-011702

Supported packages	
Package	Version
Active Directory	2.0.1-20200721-221930
Boolean	2.0.0-20200721-221936
Bot Migration	2.4.0-20200604-174031
Browser	2.0.0-20200721-221938
Clipboard	2.0.0-20200721-221947
Comment	2.0.0-20200721-221948
CSV/TXT	2.0.0-20200726-052504
Database	2.0.0-20200723-022707
Data Table	2.0.0-20200721-222456
Datetime	3.0.1-20200721-222000
Delay	2.1.0-20200721-221959
Dictionary	2.0.0-20200624-041629
Run DLL	2.0.0-20200721-222437
Email	2.0.0-20200721-222003
Error handler	2.0.0-20200721-222009
Excel basic	2.0.0-20200721-222339
Excel advanced	4.0.0-20200723-234413
File	2.1.0-20200624-041638
File & folders	2.1.0-20200721-222011
Folder	2.1.0-20200721-222013
FTP / SFTP	2.0.0-20200721-222017
IF/ELSE	2.0.0-20200721-222021
Image Recognition	2.0.0-20200721-222024
Interactive forms	2.15.0-20200729-084624
IQ Bot	2.0.0-20200415-125005
JavaScript	2.0.0-20200721-222202
Simulate keystrokes	2.1.0-20200721-222204
Legacy Automation	2.0.0-20200721-222207 1.0.0-20200515-133334
List	2.0.0-20200721-222211
Log To File	2.1.0-20200721-222212
Loop	2.0.0-20200721-222213

Supported packages	
Package	Version
Message Box	2.0.0-20200721-222213
Migration	2.4.0-20200728-033126
Mouse	2.0.0-20200721-222218
Number	2.0.0-20200721-222224
OCR	2.1.0-20200721-222225s
Microsoft 365 Excel	2.0.0-20200721-222319
Microsoft 365 Calendar	2.0.0-20200721-221944
Microsoft 365 OneDrive	2.0.0-20200721-222326
PDF	2.4.0-20200721-222331
PGP	2.1.0-20200721-222333
Ping	2.0.0-20200721-222334
Printer	2.0.0-20200721-222342
Play Sound	2.0.0-20200721-222335
Prompt	2.0.0-20200721-222344
Python Script	2.0.0-20200721-222345
Recorder	2.0.6-20200626-193519
REST Web Service	2.0.0-20200721-222436
SAP	2.1.0-20200723-234637
Screen	2.0.0-20200721-222442
SNMP	2.0.0-20200721-222445
SOAP Web Service	3.0.0-20200721-222448
String	3.0.0-20200721-222454
System	2.0.0-20200721-222454
Task	2.0.0-20200624-103759
Terminal Emulator	3.2.0-20200721-222500
Trigger Email	1.1.0-20200721-222511
VBScript	2.0.0-20200721-222503
Wait	3.0.0-20200721-222505
Window	2.0.0-20200721-222507
Workload	2.0.1-20200721-222508
XML	2.0.0-20200721-222509



Changed features
<p>User validation for change in authentication type (Service Cloud case ID: 00602788)</p> <p>Enterprise A2019</p> <p>The username is now validated when an admin user updates the Control Room authentication configuration from <b>Database</b> to <b>SAML (Administration &gt; Settings &gt; User Authentication)</b>. An error message appears if the username already exists.</p> <p><a href="#">Set up SAML authentication</a> on page 1390</p>
<p>The Before and After fields in the <b>String &gt; Extract</b> action are now optional (Service Cloud case ID: 00617151)</p> <p>Enterprise A2019 and Community Edition</p> <p>Users can now build and run bots that do not have a value in the <b>Before</b> or <b>After</b> fields. This ensures migrated bots that contain the <b>String &gt; Extract</b> action can run without disruption.</p>
<p>Improved debugging for Image Recognition actions</p> <p>Enterprise A2019 and Community Edition</p> <p>When a bot fails while running one of the Image Recognition actions, the captured source and target images are stored in the log folder. Users can review the images to identify issues such as the application image not captured correctly or low quality of the image due to differences in the Bot Creator and Bot Runner devices.</p> <p><a href="#">Image Recognition package</a> on page 2731</p>

Fixed features	
Service Cloud case ID	Description
00609293	The AATaskName system variable now uses a backslash (\) to support the migration of Enterprise 11 bots that use this variable to Enterprise A2019.
00600367, 00620149	When calling REST APIs for using the REST Web Service command, the API now returns the correct status and the response code.
--	When Work Items are processed for automation in the Bot Agent, you can now view the workload automation name in the <b>Workload &gt; Queue &gt; View Activity in progress</b> and <b>Run bot with queue &gt; View</b> pages, even when the workload automation ID and schedule automation ID are the same in the Control Room database.
00606636	The migration of 11.3.x bots that read a date from a file to an Enterprise A2019 variable now results in the correct date format: dd/mm/yyyy. Previously, a series of numbers were displayed in Enterprise A2019.
00576004	Fixed an issue where some emails were retrieved with HTML tags, even when the user selected the <b>Plain text</b> option.

Fixed features	
Service Cloud case ID	Description
00585830	Fixed an issue where the <b>Loop &gt; For each meeting in calendar</b> iterator only returned details for the first meeting of the day. Now, the output variable refreshes after each iteration and returns details for each meeting.
00505228, 00576757	When the browser language is set to Japanese, error messages from the <b>Control Room &gt; Administration &gt; Settings &gt; Email</b> page are now displayed correctly. The distorted Japanese character issue is now fixed.
--	You can now check in any forms or bots in the <b>Public</b> folder that were created using any of the earlier versions of Enterprise A2019.
--	You can now use the <b>Get</b> action without any errors for an empty dynamic element of a form during bot runtime.
00575400, 00597633	You can now use <b>Email trigger</b> to start a bot even when Microsoft Office is set to a non-English language.
--	If you are using the <b>Snapshot</b> element, the form is no longer minimized even if you set an invalid file path to save the snapshot during bot runtime.
00566225	If you add a form with a Japanese name, error messages are not displayed during bot runtime.
00571773	If you have added element label or text in Japanese and set <b>Font name &gt; System default</b> , the form elements are now displayed without any distortion during bot runtime. <a href="#">Create a form</a>
00620911	For the <b>Select file</b> element in a form, the file path is now displayed correctly when you select a file with a Japanese name during bot runtime.
--	If a form has a <b>Dynamic</b> field, any errors within any of the available elements are now displayed immediately during bot runtime.
--	An error is now displayed if you use the <b>Tab</b> key to navigate out of the <b>Dropdown</b> element in a form during bot runtime.
00616251	If a Bot Runner (attended or unattended) user is running a bot and an event trigger that is associated with this user starts, the event trigger is now queued and deployed after the current bot has completed.
00557617	The Simulate keystrokes action now supports ASCII characters when the device language is set to Russian.
--	Installing cloud-based license files is now supported on Control Room deployments using Linux CentOS 7.

Fixed features	
Service Cloud case ID	Description
00615038	All packages and actions now work with the “Portuguese (Brazil)” browser language. Previously, some packages and actions caused an unresponsive Control Room when “Portuguese (Brazil)” was selected as the browser language.
--	You can now reset the password successfully when the service credential expires or is disabled. Previously, users intermittently experienced issues while resetting the password.
--	The default logging for Bot Agent is no longer in debug mode. Previously, debug mode was the default logging, which caused an increase in the number of logs and resulted in high storage space and decreased system performance.
00588077	If you create a copy or edit the content of an existing CSV file, the modified content that is uploaded in the Control Room will now display correctly and will not cause any run-time error when the bot is executed.
00541524,00531540	You can now run bots even when the path of the bot location is more than 255 characters. Previously, the bot failed with an error.
00615106	The Bot Scanner now analyzes large bots within a few minutes.
00610366	Keyboard shortcuts such as Ctrl+C, Ctrl+V, and Ctrl+X work as expected on Internet Explorer.
00577850, 00608065, 00597132, 00596397, 00619463	The Control Room now does not become unresponsive after a period of inactivity.
00608824	An error is no longer encountered when a bot opens the Excel application after it is forcefully terminated.
00542144	The wait option in various packages now works as expected for applications based on HTML technology. Previously, the wait option used to wait for a period in multiples of 15 seconds based on the value provided. For example, if the wait value was in the range of 1-14, the system waited for 15 seconds.
00508478, 00504802, 00569822	An error is no longer encountered when a bot is running and an application window is closed when the bot is performing the find window operation.
00494857	A user that does not have the <b>Register device</b> permission can no longer register a device by creating a custom Bot Creator role.

Fixed features	
Service Cloud case ID	Description
00501619, 00614130, 00620198	An error is no longer encountered when a user deletes a device after upgrading to a later version of Enterprise A2019.
00616786	Fixed an issue where periodic scheduled bot deployments failed with the following error message (even though the credentials provided by the bot is correct):  Either your username or your password is incorrect. This might be due to a misspelling, your Caps Lock might be on, the password might have expired, or the domain might be required. To continue, retype your username and password.
00494893	Fixed an issue where the <b>Error handling &gt; Catch</b> action was not handling a runtime error with the record variable. Previously, the <b>Catch</b> action did not capture an index out of bounds error when the record variable was entered in a <b>Message box</b> action with the index specified by name.
--	The Get Property datetime format within the Active Directory package now displays the information using the system datetime format.
--	When you edit a bot using a previous package version (for example, Enterprise A2019.13 version) and the Desktop session automatically starts, if you exit the Bot editor while the Desktop session is trying to launch, the current package version will now be displayed when you open a new Bot editor instance. Previously, the previous package version (for example, Enterprise A2019.13 version) was displayed.
00563346	Credentials with non-ASCII characters are now allowed to be stored in the <b>Credential Vault</b> in the Control Room. Therefore, when you run Task Bots to open files that are protected using passwords containing non-ASCII characters, the application does not respond with an HTTP 500 error.
00525552, 00470841	The Run task no longer fails when the child bot name contains allowed special characters. Previously, when the child bot name contained allowed special characters, the run task displayed an error message.
00501212	Fixed an issue in the SMTP settings where the Control Room was sending notification emails for all of the conditions, including the disabled conditions.

Fixed features	
Service Cloud case ID	Description
00607005	A security scan of Enterprise A2019 no longer reports the Recorder package as a malicious software. Previously, the security scan reported it as a malicious software because the <code>check.exe</code> file was missing the root identification certificate.
00564129	On an operating system configured for Japanese, the Roles pages in the Control Room now shows English text as expected when you select English in the Control Room language selection.
00629523	When you upgrade from an earlier version of Enterprise A2019 to a later version and change the If package version to the latest one, conditions combined with the <b>AND</b> or <b>OR</b> condition now appear in the logic. Previously, except for the first condition, the rest of the conditions with the <b>AND</b> or <b>OR</b> condition were not shown.
00631477	When Work Items from multiple queues are processed for Workload automation from one device pool with the round-robin method for a time slice of 5 minutes, the Workload automation does not run in a loop and thereby causing an increased CPU usage.
00633829	As system admin permissions for Workload automation are verified by the application when you run a bot with queue from a single device pool to process multiple Work Items concurrently, CPU usage does not increase drastically.
00615086	Fixed an issue where the Java Application Launcher continued to run after a user stopped the Bot Scanner, which caused device performance issues for some users.
--	Variables of the List type are now available for migration from Enterprise 10 and Enterprise 11 to Enterprise A2019.
00607949	Disabled packages will not be enabled when you upgrade from an earlier version of Enterprise A2019 to a later version. Previously, packages that were disabled were enabled after an upgrade.
--	You can now debug a bot with watch variables that contain Japanese characters. Previously, watch variables containing Japanese characters did not output a value.
00623186, 00624876, 00624060, 00627123, 00629873, 00639523, 00630880, 00634577, 00636166	The correct status of a deployed bot now appears instead of <code>Device yet to be determined</code> in the Control Room <b>Activity</b> page, and the user is allowed to delete the device that has completed running a bot. The following message no longer appears: <code>Device is part of active deployment.</code>

Fixed features	
Service Cloud case ID	Description
00573461	Fixed an issue where a bot was failing in preprocessing mode if the user had inserted and then disabled the <b>Error Handler &gt; Catch</b> action without also disabling the <b>Finally</b> or <b>Catch</b> actions.
00629046	In the Database package, when you use Microsoft Excel as a database, the bot launcher now executes properly. Previously, the bot launcher stopped working when reading data from an Excel sheet that had some empty rows.

Security fixes	
Service Cloud case ID	Description
00491697	The Transport Layer Security (TLS) protocol using CBC mode of encryption for configuring the network security of the Control Room is now secured from man-in-the-middle or cyrstallographic timing attack.

Known limitations
When you add a form with the <b>Dynamic</b> element to a bot, click <b>Add element</b> , select <b>Dropdown</b> or <b>Radio group</b> as the <b>Type</b> , and leave the <b>Default value/ Default path</b> field blank, the elements appear as labels during bot runtime.
You can move a form around by dragging the title bar during bot runtime.
When you copy and paste the filepath for the <b>Select file</b> element of a form during bot runtime, invalid characters are displayed.
When the <b>Set focus</b> action is assigned to a disabled form element, an error icon is displayed when the focus is lost during bot runtime.
When you enable any of the disabled fields during bot runtime, error icons are not displayed.
Error messages during bot runtime are not displayed in the language selected in the Control Room.
If email trigger is used to start a bot, the status of the most recent email that you have viewed is changed to <b>Unread</b> every time any bot is triggered based on the trigger interval set in the <b>Check every</b> drop-down menu.
In an Control Room configured for Active Directory users, the following message appears after the first admin user is created: <code>Do you want to leave this page?</code> Workaround: Click <b>Stay on page</b> so that you can go to the Control Room login page.
If the device is already registered by a user other than the Bot Creator and the Bot Creator has the <b>Register device</b> permission, then when you run a bot from the Bot editor window, the deployment fails at the <code>Connecting your computer to Enterprise Control Room</code> step.

Known limitations
The migration process does not migrate manual dependency files added in the Enterprise 11 Control Room using the API. Bots associated with these dependencies will be migrated successfully but will fail during execution because the system cannot find these dynamically added dependency files at runtime in Enterprise A2019.
When a bot execution is in progress and the Control Room server refreshes, the progress status of the <b>In-Progress</b> activity will not be displayed even though the bot execution continues without interruption.

## Discovery Bot

### Introduction

Discovery Bot enables process automation by capturing document processes, identifying automation opportunities from business processes, and prioritizing opportunities based on ROI. Users can convert these opportunities into automated processes.

[Process discovery by using Discovery Bot](#) on page 3888

Known limitations
<p>Discovery Bot is not supported in high availability (HA) mode. When two Control Room instances are used in a cluster configuration, the recording artifacts are split between the two Control Room instances and the recording might fail to process.</p> <p>Workaround: To enable Discovery Bot in HA mode, you must update the <code>processdiscovery.properties</code> file to point to the repository path specified in the Control Room:</p> <ol style="list-style-type: none"> <li>1. From the Control Room, go to <b>Administration &gt; Settings &gt; General</b>.</li> <li>2. Select the <b>Control Room Database and Software</b> tab.</li> <li>3. Scroll to the <b>Control Room Repository</b> section.</li> <li>4. Copy the path specified in the <b>Repository path</b> field.</li> <li>5. Go to <code>C:\Program Files\Automation Anywhere\Enterprise\config</code>.</li> <li>6. Open the <code>processdiscovery.properties</code> file.</li> <li>7. In the <code>processdiscovery.data.staging</code> path, paste the repository path in the <code>&lt;yournetworkshareddrive&gt;</code> here: <code>\\&lt;yournetworkshareddrive&gt;\Processdiscovery\staging\data</code></li> <li>8. Restart the Discovery Bot service.</li> </ol>
When HTTP proxy is installed in a cloud environment, you can use the Discovery Bot recorder to record processes.
Custom role setup for Discovery Bot is currently not supported.

Known limitations
The Discovery Bot recorder continues to record your steps even after you have logged out of the Control Room.
<b>Note:</b> Manually stop the recorder to end the recording session.
The Discovery Bot recorder displays an internal error message when accessing Google Apps. Pause the recording and then resume the recording again to recapture the steps.
The recent recording (ID) created is displayed at the end of the list in the <b>Recordings</b> table. You cannot sort on the recording ID at this time.
The recording count for a process is incremented by one even if a user stops or cancels a recording session. The incremented number is displayed in the <b>Recordings</b> section in the tile for a process.
By default, you cannot move the endpoint in an upward direction in the path flow to change the selection of the steps. You can move the branch endpoint lower in the path flow to include more than one step.
You must add at least one step to a branch for you to select the branch and create an opportunity.
You must select all steps in a branch to create an opportunity. Selecting partial steps in a branch will result in branch being dropped in the opportunity that is displayed from the <b>Opportunities</b> tab.
Currently, the <b>copy of</b> field does not display the correct view information from the view (view ID) that it is copied from.
If the Control Room is not installed in the C:\ drive ( C:\Program Files\Automation \Enterprise), the Discovery Bot installer fails to install correctly. If the Control Room is not installed in the C:\ drive, then perform the instructions provided in this article: <a href="#">A2019.15 Discovery Bot installation issue with non-OS drive (A-People login required)</a> .
The <b>Export to Word</b> option supports a maximum of 500 steps.
The <b>Convert to Bot</b> option supports a maximum of 500 steps.

Changed features
.

## IQ Bot

Review the compatibility of the IQ Bot On-Premises version with the corresponding Control Room On-Premises version.

[Automation 360 IQ Bot version compatibility](#) on page 1010

For feature information about IQ Bot, see [Automation 360 IQ Bot feature comparison matrix](#) on page 1005.



The IQ Bot Cloud version provides users with automatic provisioning for up to three environments such as Development, Test, and Production.

**Note:** IQ Bot Build 5931 is compatible with Enterprise A2019 Build 5933.

New features
<p>New IQ Bot Pre-processor package</p> <p>On-Premises and Cloud</p> <p>The following new actions are available as part of the IQ Bot package:</p> <ul style="list-style-type: none"> <li>• Convert image to PDF</li> <li>• Get barcodes</li> <li>• Get document info</li> <li>• Get page content</li> </ul> <p><a href="#">IQ Bot Pre-processor package</a> on page 2742</p>
<p>Search by filename in Validator</p> <p>On-Premises and Cloud (Service Cloud case ID: 00372981)</p> <p>Use the <b>Search by filename</b> field in the <b>Validator</b> screen to search a document in IQ Bot.</p> <p><a href="#">IQ bot Validator enhancements</a></p>
<p>IQ Bot [Local Device] package (currently available on request only)</p> <p>On-Premises and Cloud</p>
<p><b>Important:</b> Contact your Automation Anywhere representative to request the On-Premises package. For Cloud, it is available as a pre-installed package.</p>
<p>Use the <b>IQ Bot [Local Device] &gt; Process documents</b> action to process documents using Task Bots created in the Control Room. You can scale by processing documents on multiple devices simultaneously without setting up a separate IQ Bot cluster. You can set this up using workload management in the Control Room.</p> <p><a href="#">Workload management</a> on page 1996</p> <p>The validation is done using the current IQ Bot Validator and usage metrics on the dashboards, which is available with the installed IQ Bot server.</p>
<p><b>Note:</b> You can create validators using interactive forms if they do not want to send data to the IQ Bot server.</p>
<p><a href="#">IQ Bot [Local Device] package (Archived PDF)</a></p>

New features
<p>Document Classifier package (currently available on request only)</p> <p>On-Premises and Cloud</p> <p>The Document Classifier package enables you to group documents into appropriate learning instances for content extraction.</p> <p>This package is not available as part of the standard IQ Bot installation.</p> <hr/> <p><b>Important:</b> Contact your Automation Anywhere representative to request the package.</p> <hr/> <p><a href="#">Document Classifier package</a> on page 2506</p>
<p>Migrate learning instances using Migration Utility</p> <p>On-Premises and Cloud</p> <p>Use the Migration Utility feature to migrate learning instances from one environment to another. Additionally, you can back up, restore, download, delete, and upload learning instances.</p> <p><a href="#">Migrate learning instances</a> on page 1725</p>
<p>Control creation of groups</p> <p>On-Premises and Cloud</p> <p>Use the <b>New groups creation setting</b> section in the <b>Learning Instance &gt; Edit</b> page to limit creating groups when uploading training documents to IQ Bot. Use the <b>Threshold to create new groups</b> value and <b>Never create new groups</b> check box to define the parameters.</p> <p><a href="#">Bots</a></p>

Changed features
<p>For the Custom Logic feature, the identified list of Python libraries now includes an additional set of trusted libraries for IQ Bot On-Premises and Cloud. Go to Automation Anywhere support for a list of the safe libraries you can use.</p>

Fixed features	
Service Cloud case ID	Description
00376179	The Automation Anywhere Cognitive Project is now created without any errors even when you use the IQ Bot batch files to install or uninstall IQ Bot.
00560185	The <b>Download Document</b> in IQ Bot now runs without any errors, irrespective of the language in which the learning instances are saved.
00574815	You can now use the Google Vision API engine to classify the selected PDF files without creating any unclassified groups.

Fixed features	
Service Cloud case ID	Description
--	Documents are now classified correctly by the Google Vision API, irrespective of the display limitations set. Previously, an incorrect resolution limitation created unclassified documents.
--	You can now use Internet Explorer to save a document or mark it as invalid in the learning instances validator screen, without any error messages.
00620237, 00623175	After logging in to the Control Room as an IQ Bot administrator, the <b>IQ Bot</b> tab is no longer displayed in the navigation bar.
--	The <code>Output.csv</code> file generated for a validated document and validated data are now displayed without any error messages.
00605607	When you click <b>Save current document</b> in the validator screen, the document is saved without any errors and the corresponding <code>.csv</code> file is created in the output folder.
--	IQ Bot deletes learning instances from Community Edition if they have not had activity in 60 days.

Known limitations
<p>IQ Bot On-Premises and Cloud</p> <p>When you click the <b>Save and go to next group</b> option, the available groups or the learning instances are sometimes not displayed.</p>
<p>IQ Bot On-Premises and Cloud</p> <p>A validation error message along with the corrected field is displayed in the output (<code>.csv</code>) file for documents validated using ValidatorURL.</p>
<p>IQ Bot Cloud (Service Cloud Case ID: 00647700, 00657619, 00656643)</p> <p>The output (<code>.csv</code>) files are not downloaded even when you click <b>Download all documents</b> button, and an error message is displayed.</p> <p>Contact Automation Anywhere support for more information.</p>

## Bot Insight

New features
<p>Date Interval option</p> <p>Enterprise A2019</p> <p>When you create new widgets that support date fields for a group or subgroup, the <b>Date Interval</b> option is enabled with the default option set to <b>Month</b>.</p> <p><a href="#">Configuring a Line Bar Chart query</a> on page 3953</p>
<p>New clustered line bar chart widget</p> <p>Enterprise A2019 and Community Edition</p> <p>The Clustered Line Bar Chart widget enables you to view and analyze information about your metrics and attributes. You can provide two metrics and two attributes in your clustered line bar chart. Now when two attributes are selected, a clustered graph grouped by primary and secondary attributes is displayed.</p> <p><a href="#">Bot Insight visualizations</a> on page 3952</p>
<p>New Device dashboard in the Operations dashboard</p> <p>Enterprise A2019 and Community Edition</p> <p>The Bot Insight Device dashboard displays various widgets that provide information about the utilization of the machines on which the bots are executed. You can analyze the device utilization and activity history of different Bot Runner machines.</p> <p><a href="#">Operations dashboard</a> on page 3932</p>

Fixed features	
Service Cloud case ID	Description
00540647	Dates are now displayed correctly on the dashboard after the data is grouped based on the date. Previously, incorrect dates were shown on the dashboard.

Deprecated feature
The <b>Widget Event Distribution by workbench</b> is removed and will no longer be displayed in the <b>Audit Dashboard</b> .

## Automation Co-Pilot for Business Users

### Introduction

Automation Co-Pilot for Business Users (Automation Co-Pilot) enables users to design a process workflow to address their business requirements. The processes incorporate human and bot tasks using forms to define parameters and render supported UI elements on the web. When using

Automation Co-Pilot on the web, users create requests to use their created process workflow for process instances (case) and run their tasks.

Automation Co-Pilot is available as a part of the Enterprise A2019 installer. You can view the Automation Co-Pilot components in the **Administration** page.

**Important:** This Automation Co-Pilot version has limited availability and is available only to sales and internal users.

Known limitations
<p>When you edit a checked-out process that contains conditional steps with variables, you cannot edit and save these conditional steps. The steps will revert any new variables you add.</p> <p>Workaround: Delete and add a new condition.</p>
<p>The <b>If</b>, <b>Else If</b>, and <b>Else</b> actions cannot be placed before another bot logic in your workflow. You can only place these actions at the end of the bot logic.</p> <p>Workaround: Make a clear boundary on the conditional block.</p>
<p>In a process, when you use a date format such as 2020/07/04 in the <b>input_date</b> field in <b>Bot Task</b>, the bot does not accept the date input.</p> <p>Workaround: Create a separate date variable to use an input.</p>
<p>Form elements that are not supported and are deleted by the process editor include: <b>Button</b>, <b>Dynamic</b>, <b>Select File</b>, and <b>Snapshot</b>.</p> <p>Workaround: Instead of using the <b>Button</b> element, add a form action.</p>
<p>The <b>Import bots</b> and <b>Export bots</b> user interface labels do not match for a process but are still applicable to importing or exporting a process.</p>
<p>When you access a public process, the <b>Request display name</b> field in <b>Process entry</b> is not locked and can be edited. The existing variable in the field can be changed but not saved.</p>
<p>The <b>Task display name</b> option in <b>Process entry</b> has a field set to <b>initialData</b> that cannot be edited in the process editor.</p>
<p>The <b>Feed data into form</b> table in the process editor does not allow editing.</p>
<p>The <b>Element name</b> field in the <b>Bot Task</b> and <b>Human Task</b> cannot contain spaces.</p>
<p>When you create two forms and assign the data of the first form to the second form using <code>\$FormStep.input [ ] \$</code>, the second form data is not evaluated.</p>
<p>Redo functions are only available for canvas interactions. The redo functions are not available by default until your first canvas interaction. The functions are available again when you interact with your second canvas.</p>
<p>A team name that has a length of 20 characters or more is not accepted.</p>

Known limitations	
Limitations in Automation Co-Pilot on the web	
Navigation bar	When you open too many request tabs, the tabs are hidden in the navigation bar.
Timestamp	The timestamp of the closing step shows a duplicate timestamp of the starting step in request view.
Imported process	<p>When you export a process from an Control Room and import that process as public to another Control Room, the imported process cannot be viewed.</p> <p>Workaround: You can check in and then check out the process, or import the process as private and then do a check-in.</p>
Configuration page	<p>In the device pool configuration page, the Bot Runner users check box cannot be deselected.</p> <p>Workaround: Double-click the check box in the header.</p>
Process management page	A check-in process that is deleted from the Control Room repository is still visible in the process management page.
Form rendering	<ul style="list-style-type: none"> <li>• The <b>Masked data</b> option is not fully supported for all elements. When this option is added to hide data, the data is visible.</li> <li>• The <b>Checkbox</b> and <b>Radio Button</b> elements do not fully support horizontal format. When these elements are configured to display horizontally, the elements are displayed vertically instead.</li> <li>• The <b>Document</b> element is not fully supported. When this element is configured to a <b>Default file</b> path, the entire document is not rendered.</li> <li>• The <b>Number</b> element encounters issues with large numbers. When this element is configured to contain three number fields and number values with trailing zeroes, commas, and decimals, these values are not honored and are not rendered. When number values are entered in a number field, such as a phone number box, the number values are not accepted.</li> <li>• The <b>Text Box</b> element encounters issues with number-only input. When this element is configured in a form to submit data, the <b>Submit</b> option is not</li> </ul>

- The **Password** element encounters issues with maximum character limits. The maximum limit is not enforced

## Enterprise A2019.14 Release Notes

Release date: 9 July 2020

Review the new features, supported packages, changed features, fixed features, and known limitations in the Enterprise A2019.14 (Build 5322) release. There are no security fixes in this release.

- [Enterprise A2019](#)
- [IQ Bot A2019](#)
- [Bot Insight A2019](#) on page 678

## Enterprise A2019

To verify which version is compatible with this release, see [Compatibility with release builds](#) on page 1333.

New features
<p>Migration from Enterprise 11 and Enterprise 10 to Enterprise A2019 (<a href="#">currently available only to those in the Migration Early Adopter Program</a>)</p> <p>Enterprise A2019</p> <p>Migration to Enterprise A2019 is currently only available to select customers through our Migration Early Adopter Program. If you are interested in learning more about this program or a timeline for when migration will be available to all customers, contact your Automation Anywhere representative.</p> <ul style="list-style-type: none"> <li>• Workload management data is automatically migrated to Enterprise A2019 when you install Enterprise A2019 and point the Control Room to the restored Enterprise 11 database. <ul style="list-style-type: none"> <li>• <a href="#">How workload management data is migrated</a> on page 1573</li> </ul> </li> <li>• Version 11.3.1 and Version 11.3 are certified for migration to Enterprise A2019. <ul style="list-style-type: none"> <li>• <a href="#">Migrate to Automation 360</a> on page 1496</li> </ul> </li> <li>• Additional support is provided for packages and variables. <ul style="list-style-type: none"> <li>• <a href="#">Package mapping for migration</a> on page 1620   <a href="#">Variable mapping for migration</a> on page 1655</li> </ul> </li> <li>• Migrate Task Bots and MetaBots created in Enterprise 10 to Enterprise A2019 using APIs. <ul style="list-style-type: none"> <li>• <a href="#">Migration API</a></li> </ul> </li> </ul>
<p>Bypass legal disclaimer</p> <p>Enterprise A2019</p> <p>When you allocate a device license to a user, the <b>Bypass legal disclaimer</b> option is automatically enabled to allow the user to run bots on the device without having to manually acknowledge a disclaimer.</p> <p><a href="#">Create a user</a> on page 1739</p>

New features
<p>Choose to automatically update Bot Agent (Service Cloud case ID: 00497873)</p> <p>Enterprise A2019 and Community Edition</p> <p>An Control Room administrator can now choose to automatically update the Bot Agent to a later version (<b>Administration &gt; Devices</b>) using the auto-update capability. In the earlier version, each Bot Agent had to be updated manually after logging in to a device, resulting in more downtime.</p> <hr/> <p><b>Note:</b> In this release, Bot Agent users have to update each Bot Agent manually. From subsequent releases, the auto-update setting will be applied and each Bot Agent will be updated automatically.</p> <hr/> <ul style="list-style-type: none"><li>• For Cloud and Community Edition, the auto-update option is enabled by default.</li><li>• For On-Premises, the default update option is set to manual.</li></ul> <p><a href="#">Automatically update the Bot Agent</a> on page 1361</p>
<p>Universal Recorder new features</p> <p>Enterprise A2019 and Community Edition</p> <ul style="list-style-type: none"><li>• The Universal Recorder can now capture objects in SAP versions 730, 740, and 760 patch 5.</li><li>• You can build automations in an SAP application using multiple connections (user accounts) and several sessions per connection at one time.</li><li>• You can now record and run bots to capture objects from a Google Chrome browser that does not have a zoom level setting of 100%.</li></ul>
<p>Capture active text, passive text, image button, and scroll in combo box in AISense Recorder</p> <p>Enterprise A2019</p> <p>You can now capture active text, passive text, image button, and scroll in a combo box from a remote application when recording a task with AISense Recorder.</p> <p><a href="#">Record a task with AISense Recorder</a> on page 2257</p>
<p>New Database package features (Service Cloud case ID: 00537047)</p> <p>Enterprise A2019 and Community Edition</p> <ul style="list-style-type: none"><li>• The <b>Connect</b> action now enables you to connect to an Excel database.</li><li>• Use the <b>Export to data table</b> action to retrieve records from the database and store the retrieved data in a table variable.</li><li>• You can now store the output of the <b>Run stored procedure</b> action in a dictionary variable.</li></ul> <p><a href="#">Using Connect action for database</a> on page 2469   <a href="#">Using the Export to data table action</a> on page 2480   <a href="#">Using the Run stored procedure action</a> on page 2476</p>



New features
<p>New Active Directory package available</p> <p>Enterprise A2019 and Community Edition</p> <p>Use actions from the Active Directory package to manage users across a group or organization. You can perform operations such as create, modify, and delete users, groups, or organizational units with centralized control.</p> <p><a href="#">Active Directory package</a> on page 2374</p>
<p>Log in securely when connecting to Active Directory server</p> <p>Enterprise A2019 and Community Edition</p> <p>You can use the <b>Connect</b> action from the Active Directory to enter your credentials (username and password). You can either insert the credentials from the Credential Vault or insert a variable that holds a credential type value.</p> <p><a href="#">Using Connect action for Active Directory</a> on page 2380   <a href="#">Credentials and credential variables in the Bot editor</a> on page 2344   <a href="#">Your variables (user-defined)</a> on page 2331</p>
<p>Support for Excel cell formats, including Number, Percentage, Currency, Scientific, and Date</p> <p>Enterprise A2019 and Community Edition</p> <p>Use the <b>Get single cell</b> and <b>Get multiple cell</b> actions from the Excel basic package and the <b>For each row in worksheet</b> Loop iterator to retrieve values in the format set in the Excel worksheet. For example, a value from a cell of Currency formatting retains the currency symbol when passed to a table or record variable.</p> <p><a href="#">Excel basic package</a> on page 2558   <a href="#">Loop package</a> on page 2784</p>
<p>Automate a task on a range of cells in an Excel worksheet</p> <p>Enterprise A2019 and Community Edition</p> <p>Specify a cell range in the <b>Delete cells</b> action to perform the operation on the cells in the range.</p> <p><a href="#">Excel advanced cell operations</a></p>
<p>New PDF package action</p> <p>Enterprise A2019 and Community Edition</p> <p>Merge multiple PDF files into a single PDF file using the <b>Merge documents</b> action.</p> <p><a href="#">Using the Merge documents action</a> on page 2886</p>
<p>Support for Czech and United States 2 code pages in Terminal Emulator package</p> <p>Enterprise A2019 and Community Edition</p> <p>The TN3270E and TN5250E terminal types support the Czech and United States 2 code pages. Use the <b>Connect</b> action to select the terminal type and code page.</p> <p><a href="#">Using Connect action for Terminal Emulator</a> on page 3119</p>

New features
<p>Proxy support for packages</p> <p>Enterprise A2019</p> <p>If a device is configured with a proxy, all outbound requests from the following packages are routed through the proxy server:</p> <ul style="list-style-type: none"><li>• Recorder</li><li>• REST Web Service</li><li>• SOAP Web Service</li></ul>
<p>Form builder enhancements</p> <p>Enterprise A2019</p> <p>The form builder now includes the following new elements:</p> <ul style="list-style-type: none"><li>• <b>Dynamic</b> - Enables dynamic rendering of the selected area.</li><li>• <b>Snapshot</b> - Enables you to take a snapshot of the form.</li></ul>
<p>Enhancements to actions in Interactive forms</p> <p>Enterprise A2019</p> <ul style="list-style-type: none"><li>• Enhanced highlight action</li></ul> <p>The <b>Highlight</b> action in the Interactive forms includes a <b>Highlight type</b> drop-down menu. You can use <b>Warning</b> or <b>Error</b> to highlight the selected form element during the bot runtime.</p> <ul style="list-style-type: none"><li>• New <b>Change label</b> action</li></ul> <p>Use this action to change the label or title of the selected element of a specific form.</p> <ul style="list-style-type: none"><li>• Dynamic area action<ul style="list-style-type: none"><li>• The <b>Add row in Dynamic area</b> action enables you to append or overwrite a dynamic element of a form.</li><li>• The <b>Clear</b> action enables you to remove the dynamic elements.</li></ul></li></ul> <p><a href="#">Interactive forms package</a> on page 2738</p>
<p>Retrieve trigger event data</p> <p>Enterprise A2019</p> <p>You can now retrieve the trigger event data during bot runtime by defining a variable as the input type.</p> <p><a href="#">Add a file and folder trigger</a> on page 2291</p>
<p>Record variable support for schema</p> <p>Enterprise A2019 and Community Edition</p> <p>You can create a new record variable with a schema to set the order of the fields and the type of data that can be entered into each field.</p> <p><a href="#">Record variable</a> on page 2340</p>

New features
<p>Product interface now available in Russian language</p> <p>Enterprise A2019</p> <p>Enterprise A2019 is now available in Russian.</p> <p><a href="#">Internationalization, localization, and language support</a> on page 1214</p>
<p>Clone and view content in Control Room</p> <p>Enterprise A2019</p> <p>The Control Room now includes the following new permissions:</p> <ul style="list-style-type: none"><li>• View content: This permission allows you to view the contents of a cloned bot. This permission applies to both public and private workspaces.</li><li>• Clone: This permission allows you to create a read-only copy of the bot from the public workspace. The same bot can be cloned by multiple users. This permission applies only to the public workspace.</li></ul> <p><a href="#">Bot permissions for a role</a> on page 1763</p>
<p>New condition in the If and Loop packages</p> <p>Enterprise A2019 and Community Edition</p> <p>Use the <b>Dictionary &gt; Check key</b> condition to execute actions based on whether the value of the specified key is <b>Equal to</b> or <b>Not equal to</b>, or <b>Contains</b> or <b>Does not contain</b> the target value.</p> <p><a href="#">If package</a> on page 2724   <a href="#">Loop package</a> on page 2784</p>
<p>New encoding type in CSV/TXT and Log To File packages</p> <p>Enterprise A2019 and Community Edition</p> <p>The UTF-16LE encoding option provides support for files that contain the byte order mark (BOM) Unicode character. In the <b>CSV/TEXT &gt; Open</b> action, selecting this option causes the BOM character to be ignored when data is retrieved from the file using a subsequent <b>Read</b> or <b>Loop</b> action. In the <b>Log to file</b> action, this option inserts a BOM character at the beginning of the file.</p> <p><a href="#">Using the Open action for CSV/TXT file</a> on page 2450   <a href="#">Using Log text to file action</a> on page 2782</p>
<p>Retrieve a list of available users using Device API</p> <p>Enterprise A2019</p> <p>Use the Device API to identify all available users with unattended Bot Runner licenses, or to filter for users by name. This API returns details of each user, including the user ID, username, and device name.</p> <p><a href="#">Device API</a></p>

New features
<p>Manually configure time interval value of database connection retries property (Service Cloud case ID: 00573167)</p> <p>Enterprise A2019 and Community Edition</p> <p>You can manually configure the time interval value of the database connection retries in the <code>cluster.properties</code> file. If the database is reconnected within the time specified in the <code>cluster.properties</code> file, the Apache Ignite cache node in the cluster setup will not restart the Apache Ignite server, keeping the device and the Control Room user connected. The default value of the time property <code>ignite.max.duration.db.connection.retries</code> in the <code>cluster.properties</code> file is 10000. The recommended maximum time for this property is up to 5 minutes (300000 msec).</p> <hr/> <p><b>Note:</b> Restart the Control Room services on each node for the manually configured value of the time property to work effectively. Also, set the time in milliseconds.</p> <hr/>
<p>Run as user to default device mapping in Workload automation (Service Cloud case ID: 00563115)</p> <p>Enterprise A2019 and Community Edition</p> <p>Workload automation now allows one-to-one (1:1) mapping of the <b>Run As</b> user with default devices when these devices are part of a device pool. Therefore, you can select default devices that are mapped to a Bot Runner to avoid auto-login failures in environments where the security policy does not allow a user to log in to any other device or devices.</p> <p><a href="#">Add queue, Bot Runner, and device pool</a> on page 1888</p>
<p>Authentication proxy support</p> <p>Support is now available for proxy authentication servers where any application going through the proxy is authenticated and authorized before accessing the internet.</p>

Supported packages	
Package	Version
Node Manager	12.1.6000
Application	2.0.0-20200624-041608
App Integration	1.0.0-20200624-041607
Analyze	2.2.3-20200624-011702
Active Directory	2.0.1-20200624-041605
Boolean	2.0.0-20200624-041610
Bot Migration	2.4.0-20200604-174031
Browser	2.0.0-20200624-041611
Clipboard	2.0.0-20200624-041619
Comment	2.0.0-20200624-041619

Supported packages	
Package	Version
CSV/TXT	2.0.0-20200624-041620
Database	2.0.0-20200624-041623
Data Table	2.0.0-20200624-042148
Datetime	2.0.0-20200624-041628
Delay	2.1.0-20200624-041629
Dictionary	2.0.0-20200624-041629
Run DLL	2.0.0-20200630-062222
Email	2.0.0-20200624-041631
Error handler	2.0.0-20200624-041636
Excel basic	2.0.0-20200630-062144
Excel advanced	4.0.0-20200630-062063
File	2.1.0-20200624-041638
File & folders	1.1.0-20200627-151822
Folder	2.1.0-20200624-041640
FTP / SFTP	2.0.0-20200624-041644
IF/ELSE	2.0.0-20200624-041646
Image Recognition	2.0.0-20200624-041747
Interactive forms	2.14.0-20200629-185534
IQ Bot	2.0.0-20200415-125005
JavaScript	2.0.0-20200630-062021
Simulate keystrokes	2.0.0-20200624-041915
Legacy Automation	2.0.0-20200624-041919 1.0.0-20200515-133334
List	2.0.0-20200624-041923
Log To File	2.0.0-20200624-041923
Loop	2.0.0-20200624-041924
Message Box	2.0.0-20200624-041925
Mouse	2.0.0-20200624-041929
Number	2.0.0-20200624-041934
OCR	2.1.0-20200630-062040
Microsoft 365 Excel	2.0.0-20200630-062127
Microsoft 365 Calendar	2.0.0-20200630-061819

Supported packages	
Package	Version
Microsoft 365 OneDrive	2.0.0-20200630-062133
PDF	2.1.0-20200624-042032
PGP	2.1.0-20200630-062139
Ping	2.0.0-20200624-042035
Printer	2.0.0-20200624-042042
Play Sound	2.0.0-20200624-042037
Prompt	2.0.0-20200624-042043
Python Script	2.0.0-20200624-042044
Recorder	2.0.6-20200626-193519
REST Web Service	2.0.0-20200624-042128
SAP	2.1.0-20200624-042131
Screen	2.0.0-20200624-042134
SNMP	2.0.0-20200624-042137
SOAP Web Service	3.0.0-20200624-042140
String	3.0.0-20200624-042145
System	2.0.0-20200624-042146
Task	2.0.0-20200624-103759
Terminal Emulator	3.2.0-20200625-032209
Trigger Email	1.1.0-20200624-042201
VBScript	2.0.0-20200630-062305
Wait	3.0.0-20200624-042156
Window	2.0.0-20200624-042224
Workload	2.0.0-20200624-042158
XML	2.0.0-20200624-042200

Changed features
<p>Changes in the <b>Database &gt; Run stored procedure</b> action</p> <ul style="list-style-type: none"> <li>It is now optional to enter an input or output parameter name.</li> <li>You must specify the data type of an input parameter. Choose from Boolean, date, number, or string date type.</li> </ul>
<p>The terminal screen for ANSI and VT100 terminals now displays 24 rows, instead of 25 rows as in earlier versions.</p>

Changed features
<p><b>Email &gt; Send</b> action interface changes</p> <p>For the <b>Use secure connection (SSL/TLS)</b> and <b>My server requires authentication</b> fields, you must now select <b>True</b> or <b>False</b>, or insert a Boolean variable. Previously, the fields were activated by selecting a check box.</p>
<p>Import bots in public or private workspace</p> <p>Service Cloud case ID: 00456712</p> <p>Users can now import bots into the public workspace if they have the required permissions, regardless of their licenses. Additionally, users with a Bot Creator license can now import the bots either into the public or private workspace.</p> <p><a href="#">Import bots</a> on page 2035</p>

Fixed features	
Service Cloud case ID	Description
00554068	In the Community Edition, when you upgrade your Bot Agent to a later compatible version, Task Bots created with system variables of numeric type now run successfully. The Control Room does not show a preprocessing error when you deploy the Task Bots.
00443421	The <b>Run stored procedure</b> action in the Database package runs as expected with Oracle Database when you use input and output parameters.
00557374	The Universal Recorder now consistently captures objects from an SAP application and identifies the technology for those objects as SAP when all prerequisites are met.
00611874	An error is no longer encountered when a variable containing Japanese characters is used in the <b>Write to file</b> action of the Data Table package.
00564534	A modified dependency file with the same name as the original file and a new size is now successfully checked in from the private to the public repository. The old file that was previously checked in is no longer referenced after the modified file is checked in to the public repository, thereby preventing a bot execution failure.
00570537	When you clone a bot with or without dependency files, the cloned bot now displays the actual file size for the bot and its dependency files.
00577247, 00587976	Fixed an issue where the <b>Email &gt; Move all</b> action did not move emails when a bot ran the action on an OS configured with the Japanese language setting.
00552729	The <b>PGP &gt; Decrypt</b> action now works for PDF files.

Fixed features	
Service Cloud case ID	Description
00487805	<p>You can now access the TN3270 terminal without the terminal screen displaying all text with strike lines. Before using any type of terminal to execute terminal commands, install the latest VC ++ package.</p> <p><a href="#">Latest supported Visual C++ downloads</a></p>
00584051	<p>Python 3 script now supports using Unicode characters in input variables. Bot error messages are no longer displayed when Python 3 is used to pass Japanese characters to a variable.</p>
00540651, 00587963, 00593302	<p>You can now use the <b>Assign, Join, Merge, and Sort</b> actions from the Data Table package when you change the default language from English to Simplified Chinese.</p> <p>You can also use the <b>Assign</b> action when you change the default language from English to Japanese, Korean, and other non-English languages.</p>
00577284	<p>The <b>Split document</b> action in the PDF package now executes correctly for a horizontal PDF file, and the large-width output file is not cut off from the sides.</p>
00595357	<p>You can now export and import two different bots (with the same name) in different folders from a staging environment into a production environment.</p>
00569527	<p>You can now perform a check-in and check-out of bots with dependencies.</p>
00574309	<p>You can now update or remove <b>Cluster ip addresses</b> from the <b>Elastic search disaster recovery backup cluster</b> setting from the Control Room <b>Administration</b> page.</p>
00525854	<p>When a file type variable is used to open an Excel, CSV, or Java script file, bots can now be executed successfully when the file variable is used as an input.</p>
00609184	<p>After the existing license expires, the admin user can now successfully install a new Control Room license for a Control Room hosted on Linux CentOS.</p>
00576202	<p>You can now insert a user-defined string variable in a message box display when the string variable is included in the expression for multi-line values.</p>
00560706	<p>You can now view the actions menu (vertical ellipsis) to edit or delete the variable string name when the character length is more than 35 characters.</p>
-	<p>For the <b>Checkbox</b> element, changes made to the check box names in the <b>Checkbox content</b> field are now updated when you enable <b>Advance behaviors &gt; Make default selections</b>.</p>



Fixed features	
Service Cloud case ID	Description
-	You can now set the default selection in <b>Advance behaviors</b> for the <b>Radio button</b> element in a form.
00557395	You can now check in bots that use the variable <code>\$prompt-assignment\$</code> without receiving an error message. Previously, when you opened the bot in List view, an error icon was displayed next to the actions that contain the variable.
00560356	Previously, when a task that consisted of one or more subtasks was run, the In Progress entry for the task was moved into a historical report with the completion of the first subtask, not the entire governing task. Now, the In Progress tasks are not moved to historical status until the completion of the entire task.
00556113	In Community Edition opened in Google Chrome, you can now select the device icon in a non-English language, and the <code>[link]</code> and <code>[icon]</code> tags are no longer displayed.
00559360	You can now re-import a bot that has failed previous imports. The <code>query did not return a unique result: 2</code> displayed during re-import attempts is now fixed.
00443590	Fixed an issue where after a bot is deployed on a Bot Runner device, that device is in a different state compared to the state before the bot deployment. For example, if a Bot Runner device is locked before bot deployment, after it is unlocked to deploy the bot, it will now be moved back to lock status.
00559507, 00594149	Support for scheduling bots with Internet Explorer version 11 is now improved. Users in the Control Room can scroll through multiple pages of scheduled bots without issues with scrolling through the interface.

Known limitations
<p>In Enterprise A2019 On-Premises, a security scan might report the Recorder package as malware because the <code>check.exe</code> file is missing the root identification certificate.</p> <p>You can contact Automation Anywhere Support to get an updated package with the signature fix and upload it to your Control Room.</p> <p><a href="#">Add packages to the Control Room</a> on page 1908</p>

Known limitations
<p>Version Enterprise 10 or Enterprise 11 bots containing commands that have white space in the credential attributes cannot be migrated to Enterprise A2019. The migration process stores some credential attributes in global values in Enterprise A2019. Global values do not support white spaces.</p> <p>To migrate bots that use credential attributes, you can remove the white spaces or replace them with characters.</p>
<p>If you use the <b>Get</b> action for an empty dynamic element of a form, errors are displayed during bot runtime.</p>
<p>If you use <b>Trigger loop: Handle</b> within a bot, link it to a form with <b>Select File</b> element, and set the <b>Select action trigger &gt; Lost focus</b>, the next event is not triggered when you click <b>Browse</b>.</p>
<p>The <b>Set focus</b> action in <b>Interactive forms</b> does not work when you use it to link the fields between two different forms.</p>
<p>In the form builder screen, text is displayed in English even when you change the display to non-English language.</p>
<p>You might see the schedule automation name instead of the Workload automation name in the <b>Workload &gt; Queue &gt; View Activity in progress</b> and <b>Run bot with queue &gt; View</b> pages when Work Items are processed for automation in the Bot Agent. This occurs if the Workload automation ID and schedule automation ID are the same in the Control Room database.</p>
<p>The <b>Task bot &gt; Run</b> action only supports files selected from the Control Room repository. Also, this action only supports file type variables with a set default value and the <b>input</b> option disabled. You cannot modify the file variable value using the <b>File &gt; Assign</b> action.</p>
<p>When you edit a bot using a previous package version (for example, an Enterprise A2019.13 version) and the Desktop session automatically starts, if you exit the Bot editor while the Desktop session is trying to launch, the previous package version will be displayed when you open a new Bot editor instance. However, you should see the Enterprise A2019.14 package version associated with the new Bot editor instance. If you close and reopen the new Bot editor instance, the Enterprise A2019.14 package version will be displayed.</p>

Known limitations
<p>There is an issue for a specific, manually generated license key file supplied by Automation Anywhere to upgrade from Enterprise A2109.13 to Enterprise A2019.14.</p> <p>This issue applies only to customers who are in the following specific category (all must be true):</p> <ol style="list-style-type: none"> <li>1. Control Room is at the customer premises</li> <li>2. Control Room is running Enterprise A2019.13 or earlier</li> <li>3. Installed a license file that was provided to them in July 2020 (not self-generated through the customer self-service license portal)</li> <li>4. User has upgraded the On-Premises Control Room to Enterprise A2019.14.</li> </ol> <p>For this issue, contact Automation Anywhere for updated license files.</p> <hr/> <p><b>Important:</b> Users who self-generated their license files through the A-People License portal are not affected by this issue. Cloud customers are also not affected by this issue.</p> <hr/> <p>A bot that contains the <b>Capture</b> action from the Recorder package fails when both the HTML InnerText and InnerHTML object properties are selected.</p> <p>Workaround: Select only one of the object properties.</p> <hr/> <p>The Universal Recorder fails to perform a click, set text, or append text action on the correct control when a debug window or download bar is open. This occurs only in the Google Chrome browser with the device display set to 100%.</p> <p>Workaround: Disable the Google Chrome download bar.</p> <hr/> <p>When you create, edit, or run a bot from the Bot editor window, close the Bot editor window when the socket connection has just been established, and then navigate to the <b>My bots</b> page, the Recorder window opens for a moment and then closes.</p>

Known limitation

## IQ Bot

The IQ Bot A2019 On-Premises version supports all the features and functionality available in IQ Bot Version 11.3.4.2.

[Automation 360 IQ Bot feature comparison matrix](#) on page 1005

Review the compatibility of the IQ Bot On-Premises version with the corresponding Control Room On-Premises version.

[Automation 360 IQ Bot version compatibility](#) on page 1010

The IQ Bot A2019 Cloud version is available for this release and supports all features and functionality available in IQ Bot Version 11.3.4.2. This version provides users with automatic provisioning for up to three environments such as Development, Test, and Production. Users can migrate learning instances between environments using APIs.

New features
<p>Delete bot option in IQ Bot Designer (Service Cloud case ID: 00096258, 00595526)</p> <p>IQ Bot On-Premises and Cloud</p> <p>Users with Edit bot permission can view and use the <b>Delete bot</b> option in the Designer. After a bot is deleted from the system, it will not be displayed in the <b>Learning Instance</b> or <b>Bots</b> listing pages.</p> <p>IQ Bot removes all document details from staging, and all unprocessed production documents are moved to the Validator.</p>
<p><b>Note:</b> The <b>Migration Utility &gt; Import/Export</b> functionality is not affected in any way by the Delete bot feature.</p>
<p><a href="#">Bots</a></p>
<p>Extract data from a table that spans across multiple pages (Service Cloud case ID: 00371795)</p> <p>IQ Bot On-Premises and Cloud</p> <p>IQ Bot can now extract data successfully from an entire table that spans across multiple pages and has a table header only on the first page.</p>
<p>Add fields and field alias to custom domain (Service Cloud case ID: 00471075)</p> <p>IQ Bot On-Premises and Cloud</p> <p>You can now add additional fields (form or table) and field aliases to a custom domain for an existing learning instance.</p>
<p>Alert for successful or pending document validations</p> <p>IQ Bot On-Premises and Cloud</p> <p>Document validation status is now displayed on the <b>Learning instances</b> page. A green icon is used for all successful document validations, and a red icon shows any pending validations.</p>

Changed features
<p>Import custom domains from the staging to the production server in any order (Service Cloud case ID 00472445)</p> <p>You can now edit and update an existing custom domain multiple times and import them to the production server multiple times, and in any order, before importing the learning instances. After importing the learning instances, the system classifies all documents in the production server correctly, allowing for successful processing of documents.</p> <p><a href="#">Custom domains in IQ Bot</a></p>

Changed features
<p>Validator enhancements (Service Cloud case ID: 00470258)</p> <p>Some of the Validator enhancements are as follows:</p> <ul style="list-style-type: none"> <li>You can now hide the <b>Skip to next file</b> and <b>Mark as Invalid</b> options using configuration settings. The options are currently enabled by default.</li> </ul> <p>To enable the option to hide them, contact Automation Anywhere Support.</p> <ul style="list-style-type: none"> <li>You can now hide the <b>Hide successful fields</b> and <b>Hide optional fields</b> options using configuration settings. The options are enabled by default.</li> </ul> <p>To enable the option to hide them, contact Automation Anywhere Support.</p> <hr/> <p><b>Note:</b> Selecting the <b>Hide successful fields</b> and <b>Hide optional fields</b> check boxes hides all the valid fields and reduces the display of a large number of fields, thus making correction easier. However, if there is an invalid field, it continues to be displayed because the invalid field requires correction.</p> <hr/> <ul style="list-style-type: none"> <li>Clicking in any column field expands the column width to accommodate the text entry. The Validator shows the value of the field that is being validated, in the document.</li> <li>Draw an area around single or multiple values in the document image to automatically populate a field in the Validator. This function is similar to the Designer.</li> </ul>

Fixed features	
Service Cloud case ID	Description
00552830	You can now use the unique validation link to access the documents without any errors.
-	When you use table extraction from a document with multiple tables, the data from the specified table is now extracted correctly.
00551886	Unicode issue with table validation for Asian languages is now resolved.
00538480	The Options method is now disabled for HTTP requests.
00538480	Cross origin resource sharing is now restricted in IQ Bot.
00421067	The activities time stamp is now captured correctly in the Control Room <b>Audit Logs</b> tab.
00522817	The <b>TestRun</b> output of a custom logic now displays the characters without any distortion, irrespective of the language you select.
00605420, 00605741, 00606561	After upgrading to IQ Bot Cloud if you restart the Control Room, you can now view or create learning instances immediately without restarting the IQ Bot service.

Known limitations
<p>IQ Bot On-Premises and Cloud</p> <p>If you create a learning instance and click <b>Learning instances</b> &gt; <b>Edit</b>, a blank page is displayed.</p> <p>Workaround: Clear your browser cache and try to edit the learning instances.</p>
<p>IQ Bot On-Premises and Cloud</p> <p>If you log in to the Control Room as an IQ Bot administrator, a 502 <code>system error</code> is displayed when you click the <b>IQ Bot</b> tab in the navigation bar.</p>
<p>IQ Bot On-Premises and Cloud</p> <p>You can view the <code>ValidatorURL</code> error message for a validated document along with the corrected field in the <code>.csv</code> output file.</p>
<p>IQ Bot On-Premises and Cloud</p> <p>In Internet Explorer, you cannot save a document or mark it as invalid in the learning instances validator screen.</p> <p>Workaround: Use the Google Chrome browser to access the learning instances validator screen.</p>
<p>IQ Bot Community Edition</p> <p>If you remove a bot (<b>Delete a bot</b>) associated with the document from the staging environment, you must create a group before uploading this document to the production environment. However, after deleting the bot from the staging environment, you cannot create or edit the group when you upload the same document to the production environment.</p>

## Bot Insight A2019

New features
<p>Line Bar Chart widget available</p> <p>Enterprise A2019</p> <p>The <b>Line Bar Chart</b> widget enables you to view and analyze information about your metrics and attributes. You can input two metrics and one attribute and display a bar graph when only one attribute is selected or display a clustered graph when two or more attributes are selected. You can use <b>Date</b> types as interval options, grouped by <b>Day</b>, <b>Week</b>, <b>Month</b>, and <b>Year</b>.</p> <p><a href="#">Bot Insight visualizations</a> on page 3952</p>

**New features**

Advanced settings for a query

Enterprise A2019

You can use the **Advanced Settings** option to configure more of your queries when you create a new widget. You can now set limits to your attribute values as grouped by **10**, **20**, **50**, and **100** values. You can also sort your data by ascending or descending order.

[Configuring a Line Bar Chart query](#) on page 3953

## Enterprise A2019.13 Release Notes

Release date: 15 June 2020

Review the new features, supported packages, changed features, fixed features, and known limitations in the Enterprise A2019.13 release. There are no security fixes in this release.

A2019.13 Build 4701 is available for Cloud customers, and Build 4705 is available for On-Premises customers. Community Edition remains on A2019.12 and will be upgraded to A2019.14 upon availability.

- [Enterprise A2019](#)
- [IQ Bot](#) on page 688
- [Bot Insight](#) on page 691

## Enterprise A2019

To verify which version is compatible with this release, see [Compatibility with release builds](#) on page 1333.

**New features**

Migration from Enterprise 11 and Enterprise 10 to Enterprise A2019 ([currently available only to those in the Migration Early Adopter Program](#))

Migration to Enterprise A2019 is currently only available to select customers through our Migration Early Adopter Program. If you are interested in learning more about this program or a timeline for when migration will be available to all customers, contact your Automation Anywhere representative.

- The Insert work item command, workload management queues, and device pools are now migrated to Enterprise A2019.
- Schedules are migrated when you copy Enterprise 10 data to Enterprise A2019 or update Enterprise 11 data to Enterprise A2019. You then have to remap some dependencies to enable the migrated schedules.

[Enable schedules after migration](#) on page 1616

- Additional support is provided for packages and variables.

[Package mapping for migration](#) on page 1620 | [Variable mapping for migration](#) on page 1655

New features
<p>Record tasks with a device display setting of 125% or 150%</p> <p>You can now record tasks using Universal Recorder in Java, Microsoft Active Accessibility, and Microsoft UI automation applications on a computer that has a device display setting configured at 125% or 150%, in addition to the existing setting of 100%.</p>
<p>Export bots without enabling SMTP in Bot Lifecycle Management</p> <p>When you export a bot, you can now download the exported package even when SMTP is not enabled. The link to download the exported package is available in the <b>ACTIVITY &gt; Historical</b> page.</p> <p><a href="#">Export bots</a> on page 2033</p>
<p>Export and import files using Bot Lifecycle Management APIs</p> <p>Use the Bot Lifecycle Management export and import APIs to move bots from one environment to another based on your organization's automation requirements.</p> <p>You can export bots with dependent files and command packages from the public workspace of one Control Room and import them to a private workspace in another Control Room, and check them into a public workspace. To export and import bots, you must have the Export bots, Import bots, View and Manage packages, and Check in and Check out permissions to the necessary folders and have the Bot Creator license.</p> <p><a href="#">BLM API</a></p>
<p>Capture scroll action and table using AISense Recorder</p> <p>You can now capture the scroll action in an application window and table control from a remote application when recording a task with AISense Recorder.</p> <p><a href="#">Record a task with AISense Recorder</a> on page 2257</p>
<p>Form builder enhancements for interactive forms</p> <p>The form builder includes the following elements:</p> <ul style="list-style-type: none"><li>• <b>Select File:</b> To enable file upload in the form.</li><li>• <b>Dropdown:</b> To create a drop-down menu in the form.</li></ul> <p><a href="#">Create a form</a></p>
<p>Extract text from a specific area in a window</p> <p>Use the <b>App Integration &gt; Capture area</b> action to extract text from within the captured area of a window and save it to a string variable.</p> <p><a href="#">App Integration package</a> on page 2423</p>
<p>Read string variable values from a text file</p> <p>Use the <b>String &gt; Import string from text file</b> action to read values from a text file and save them to a string variable.</p> <p><a href="#">String package</a> on page 3086</p>



New features
<p>Automate in IBM-5555 terminals using the Terminal Emulator package</p> <p>The TN5250E terminal type now supports the IBM-5555-C01 and D01 terminal models.</p> <p><a href="#">Terminal Emulator package</a> on page 3117</p>
<p>Specify events within email trigger</p> <p>For email triggers, specify an event within the server type (Outlook, Email, or EWS server) to trigger a bot.</p> <p><a href="#">Add an email trigger</a> on page 2287</p>
<p>Use hot key for interface trigger</p> <p>For interface triggers, you can select hot key as one of the conditions to trigger the bot</p> <p><a href="#">Add an interface trigger</a> on page 2294</p>
<p>Assign action in interactive forms package</p> <p>The interactive forms package now includes an <b>Assign</b> action that you can use to assign values dynamically in the <b>Dropdown</b> element of a form.</p> <p><a href="#">Interactive forms package</a> on page 2738</p>
<p>Create a shortcut of a file or folder</p> <p>Use the <b>Folder &gt; Create shortcut</b> or <b>File &gt; Create shortcut</b> action to create a shortcut in the specified destination file path. The shortcut is dependent on the source file or folder. If you make changes to the source file or folder, the changes will also apply to the shortcut.</p> <p><a href="#">File package</a> on page 2600   <a href="#">Folder package</a> on page 2612</p>
<p>New conditions in the If and Loop packages</p> <ul style="list-style-type: none"><li>• Use the <b>Data table &gt; Data table is empty</b> condition to execute actions based on whether the specified table contains values.</li><li>• Use the <b>Data table &gt; Number of columns</b> and <b>Data table &gt; Number of rows</b> conditions to execute actions based on whether the number of columns or rows is <b>Equal to</b>, <b>Greater than</b>, or <b>Less than</b> the specified value.</li></ul> <p><a href="#">If package</a> on page 2724   <a href="#">Loop package</a> on page 2784</p>
<p>Generate a random string of a user-specified number of characters and assign it to a string variable</p> <p>Use the <b>String &gt; Random</b> action to generate a string of uppercase and lowercase alphanumeric characters. You can specify the number of characters that the generated string consists of, with a maximum of 300 characters.</p> <p><a href="#">String package</a> on page 3086</p>

New features
<p>Upgrading Enterprise A2019 enables pre-filling installation parameters</p> <p>If you are upgrading from one Enterprise A2019 version to another, you have the option to pre-fill the installation parameters with existing installation content. Existing installation parameters include, for example, the installation path, HTTPS ports, database names, IP addresses, and TLS configuration. The username and password have to be manually entered.</p> <p>Note that this is applicable only to a Windows-based installation.</p> <p><a href="#">Run Control Room installer</a> on page 1247   <a href="#">Installing Control Room on Linux</a> on page 1293</p>

Supported packages	
Package	Version
Node Manager	7.1.5207
Application	2.0.0-20200515-071407
App Integration	1.0.0-20200515-071406
Analyze	2.2.2-20200515-101604
Boolean	2.0.0-20200515-071408
Bot Migration	2.4.0-20200604-174031
Browser	2.0.0-20200515-071410
Clipboard	2.0.0-20200515-071418
Comment	2.0.0-20200515-071418
CSV/TXT	2.0.0-20200515-071419
Database	2.0.0-20200515-071421
Data Table	2.0.0-20200515-071731
Datetime	2.0.0-20200515-071424
Delay	2.1.0-20200515-071425
Dictionary	2.0.0-20200418-005349
Run DLL	2.0.0-20200515-071713
Email	2.0.0-20200515-071427
Error handler	2.0.0-20200515-071432
Excel basic	2.0.0-20200515-071623
Excel advanced	4.0.0-20200604-173722
File	2.1.0-20200515-071434
File & folders	2.0.0-20200317-030352
Folder	2.1.0-20200515-071436

Supported packages	
Package	Version
FTP / SFTP	2.0.0-20200515-071439
IF/ELSE	2.0.0-20200515-071441
Image Recognition	2.0.0-20200515-071454
Interactive forms	2.12.0-20200420-084203
IQ Bot	2.0.0-20191031-150538
JavaScript	2.0.0-20200515-071459
Simulate keystrokes	2.0.0-20200515-071502
Legacy Automation	2.0.0-20200515-133330 1.0.0-20200515-133334
List	2.0.0-20200515-071509
Log To File	2.0.0-20200515-071509
Loop	2.0.0-20200515-071511
Message Box	2.0.0-20200515-071511
Mouse	2.0.0-20200515-071517
Number	2.0.0-20200515-071522
OCR	2.1.0-20200516-083309
Microsoft 365 Excel	2.0.0-20200515-071608
Microsoft 365 Calendar	2.0.0-20200515-071414
Microsoft 365 OneDrive	2.0.0-20200515-071614
PDF	2.1.0-20200515-071618
PGP	2.1.0-20200515-071620
Ping	2.0.0-20200515-071621
Printer	2.0.0-20200515-071626
Play Sound	2.0.0-20200515-071622
Prompt	2.0.0-20200515-071627
Python Script	2.0.0-20200515-071628
Recorder	2.0.5-20200523-020302
REST Web Service	2.0.0-20200515-071712
SAP	2.1.0-20200515-071715
Screen	2.0.0-20200515-071718
SNMP	2.0.0-20200515-071720
SOAP Web Service	3.0.0-20200515-071723

Supported packages	
Package	Version
String	3.0.0-20200515-071729
System	2.0.0-20200515-071729
Task	2.0.0-20200519-082744
Terminal Emulator	2.0.0-20200515-071735
Trigger Email	1.1.0-20200515-022805
VBScript	2.0.0-20200515-071737
Wait	3.0.0-20200515-071739
Window	2.0.0-20200515-071753
Workload	2.0.0-20200422-054201
XML	2.0.0-20200515-071743

Changed features
The <b>Dictionary &gt; Put</b> action is now the <b>Dictionary &gt; Set value</b> action. When you provide the key name, if the key does not already exist, this action creates a new key-value pair. In addition, you can now manually enter a value; previously, you had to select from a list of variables.
In the <b>Excel advanced &gt; Get worksheet as data table</b> action, the <b>Tick if the first row is the header</b> option is now the <b>Sheet contains header</b> option. There is no change in functionality.
The <b>File &gt; Rename</b> and <b>Folder &gt; Rename</b> actions now accept the full file path in the <b>New file name</b> and <b>New folder name</b> fields. Previously, these fields only accepted the new file or folder name.
When you select a file from the desktop for the JavaScript, Python Script, or VBScript packages, it is no longer necessary to isolate that file in a separate folder. Previously, when you selected a file with the <b>Open</b> action, all the files in that folder were selected too.
The <b>Database &gt; Run stored procedure</b> action now has a different interface that enables you to configure input parameter values and output parameter data types. This action is not backward-compatible because the user interface controls and input data type have changed. You must modify the <b>Run stored procedure</b> action fields in the bots that contain previous versions of this action.
The Cloud License feature is now enabled by default in the Control Room.

Fixed features	
Service Cloud case ID	Description
00492377, 00511639	Bots using the Image Recognition action can now recreate the recorded activity and run successfully.

Fixed features	
Service Cloud case ID	Description
00599586, 00600149, 00601142, 00599483	The <code>Processing failure</code> error encountered when using the <b>Wait for condition</b> action is now fixed. Bots using this action now run successfully.
00583248	During Work Item consumption, a running task is no longer canceled when the next bot is deployed.
00548456	The Workload Management v3 APIs are now successfully executed in Swagger and do not fail because of a case-sensitive issue.
00601083	For Cloud deployment, users can now successfully export bot files and download them without any errors.
00568664	The <b>Git integration</b> option is now displayed for admin users when they navigate to <b>ADMINISTRATION &gt; Settings</b> in the Control Room.
--	The minimum length value of a form element cannot be 0. If you set the value as 0 in <b>Character limit &gt; Min</b> field, the <b>Make field required</b> is disabled.
00571125	When you check in a non-bot file by itself, the file is now checked in without any error. Older files that exist in Build 4111 are also unlocked and checked in after upgrading to Build 4705.
--	The form preview feature is now consistent across the Internet Explorer and Google Chrome browsers.
--	A blank page is no longer displayed when you paste content into any of the existing form elements on the form builder.
--	A form that is linked to a bot through the <b>Display</b> action of interactive forms is now displayed in front of all other windows when the <b>Always display form window in front</b> option is selected.
--	When a user login failed due to a Global Catalog (GC) availability issue, the response only indicated a communication error. The process now checks for errors and exceptions in the GC and processes the authentication with appropriate messages, so users can take appropriate action.
00520394	The VBScript package actions now support Unicode characters.
00536881	When you delete a bot, any trigger that is associated with it is also deleted and is not listed in the <b>Activity list</b> page.
00506169	You can now use the interface trigger to run a bot without any errors in the Japanese operating system.

Fixed features	
Service Cloud case ID	Description
00537640, 00538369	When you check out a bot from the Control Room and add a trigger, you can now use <b>Run with triggers</b> to run this bot without any errors.
00531912	JavaScript package actions can now be used to parse the values in a list.
00475183	Double-byte characters returned unreadable ANSI characters in the bot Log To File text. This issue is now fixed and ANSI encoding takes the system default charset.
00475129	You can now use double-byte characters in a variable name.
00511675	The <b>Excel advanced &gt; Find</b> action now searches for values in merged cells when the <b>By rows</b> search option is used.
00468103, 00475142	Bot names using Unicode characters, such as German umlaut, Japanese characters, and others, display correctly in the pop-up window at runtime.
00552701, 00558919	You can now select multiple actions from the Bot editor and drag them into a <b>Step, Loop, or If</b> action.
00507240	Fixed an issue where a running parent bot could not be stopped after it ran a child bot. Now you can stop a bot at any time.
00482810	VBScript actions can now run scripts that contain Unicode characters.
00472684, 00541922, 00551632, 00534508, 00570602	The <b>Email &gt; Send</b> action now supports a user-input port number for sending emails from an SMTP server, such as AWS Simple Email Service. Previously, the action only used port 25, even if the user entered a different port number.
00475230	Fixed an issue where the <b>String &gt; Replace</b> action did not support an empty string in the <b>Replace with</b> field. You can now use the action to replace a specific string with an empty string.
00472665	When a child bot shows an error, the parent bot now handles the exception by running the <b>Error Handler &gt; Catch</b> action. Previously, the parent bot was also showing an error, even when it contained Error handler actions.
00566476, 00560339	Fixed an issue where bots that contain the <b>Capture</b> action stopped working when running the action during deployment, or they could not be checked out after they were checked-in for editing.

Fixed features	
Service Cloud case ID	Description
00537139	A bot running the <b>Capture</b> action can now capture specific objects from a Google Chrome browser on a device running the Windows 10 operating system. In some cases, bots running the <b>Capture</b> action from Version A2019.11 On-Premises could only capture the entire browser window.
00421864	The <b>Create a bot</b> screen now displays properly in Internet Explorer. Previously, some display issues occurred where the screen was cut on the right side and the screen could not be moved.
00584341	Fixed an issue where some of the historical activity entries were incorrectly displayed. These entries are now displayed correctly when a user drills down for more information.

Known limitations
When you create a Dictionary/Table variable and use it in the <code>name</code> field of the PROPERTIES control, the bot does not deploy successfully. This issue occurs because Dictionary/Table variables are not supported for the <code>name</code> field in the PROPERTIES control. You can pull the <code>name</code> value into a String or Number variable before using it in the PROPEPTIES control, and then use that String or Number variable in it.
You can use Swagger to export bots but not to download exported bots. You have to use the REST Client to download exported bots.
When you run a bot, the runtime window is minimized after you preset the desktop.
The OSS Disclosure report provided in the A2019 installer is outdated. Starting from this release, you can log in to Automation Anywhere Support site and download the updated report: <a href="#">A-People Downloads page (Login required)</a> .
When you capture a table control from an application using the AISense Recorder, you cannot set text using the <b>Set text</b> option from the <b>Actions</b> list. You can set text in the table by capturing a cell from the table as a text box and then using the <b>Set text</b> option from the <b>Actions</b> list.
When upgrading from one Enterprise A2019 version to another, you have the option to pre-fill the installation parameters with existing installation content, but only if you used the default installation path <code>C:\Program Files</code> .
<b>Note:</b> This is applicable only to a Windows-based installation.
Based on the permission assigned by an administrator, users can only view the <b>Public</b> tab that lists the available forms and bots. However, users can edit an available form or bot by replacing <b>View</b> with <b>Edit</b> in the Control Room URL.

Known limitations
When you create a bot and link a form to it, the bot is included only when you check in the form; it is not available on form check-out.
When you click multiple icons (Copy, Cut, and Paste) at the top of the form builder or bot creator page, the tooltips overlap.
<p>Issues in the form builder:</p> <ul style="list-style-type: none"> <li>• If you drag any form element into a specific position on the form builder, it always appears at the bottom of the available elements.</li> <li>• If you drag form elements around in the form builder screen in Internet Explorer, the mouse pointer flickers continuously.</li> <li>• For the <b>Radio button</b> element, you cannot set the default selection in <b>Advance behaviors</b>.</li> <li>• For the <b>Checkbox</b> element, changes made to the check box names in the <b>Checkbox content</b> field are not updated when you enable <b>Advance behaviors &gt; Make default selections</b>.</li> </ul>
When a bot runs Terminal Emulator package actions in an IBM-5555 terminal, the terminal window does not display double-byte characters, including Chinese and Japanese characters.
If you used the Universal Recorder to capture a menu item from a Microsoft Active Accessibility application on a computer that has a display scale setting configured to 100%, at runtime the bot does not click the correct menu item on a computer that has a display scale setting configured to 125% or 150%.
During GUID provisioning, License Sync is called internally after a successful installation. If the internal License Sync fails but the installation is successful, users can log in and continue to work.
When a task that consists of one or more subtasks is run, the In Progress entry for the task is placed into a historical report upon completion of the first subtask, not the entire governing task.
An error occurs if the parent bot contains actions for objects captured using the AISense Recorder and the child bot contains actions for objects captured using the Universal Recorder, or vice versa.

## IQ Bot

The IQ Bot On-Premises version supports all the features and functionality available in IQ Bot Version 11.3.4.2.

[Automation 360 IQ Bot feature comparison matrix](#) on page 1005

Review the compatibility of the IQ Bot On-Premises version with the corresponding Control Room On-Premises version.

[Automation 360 IQ Bot version compatibility](#) on page 1010



The IQ Bot Cloud version is available for this release and supports all features and functionality available in IQ Bot Version 11.3.4.2. This version provides users with automatic provisioning for up to three environments such as Development, Test, and Production. Users can migrate learning instances between environments using APIs.

For the Custom Logic feature, there is an identified list of Python libraries and packages that are safe to use for IQ Bot Cloud. Use only these packages to ensure security for your cloud infrastructure, file systems, databases, and network resources.

New features
<p>Migrate data to a unified database</p> <p>IQ Bot On-Premises and Cloud</p> <p>The Database Migration Assistant enables you to migrate data from IQ Bot Version 6.5 or later databases to a unified database in IQ Bot A2019.</p> <p><a href="#">Migrate earlier IQ Bot versions to Automation 360 IQ Bot On-Premises</a> on page 1722</p>
<p>Support for custom validation Python scripts</p> <p>IQ Bot Cloud</p> <p>You can use custom logic in Python to modify intermediate extracted data in IQ Bot.</p> <p><a href="#">Add custom logic in IQ Bot to improve extraction</a></p>
<p>Select an OCR engine when creating a learning instance</p> <p>IQ Bot On-Premises and Cloud</p> <p>You can select different OCR engines directly from the UI based on your requirements for data extraction from specific document types, when creating a new learning instance. You do not have to stop and restart IQ Bot services for implementing the engine change.</p> <p><a href="#">Select an OCR engine</a></p>
<p>Enable or disable PDFBox option</p> <p>IQ Bot On-Premises and Cloud</p> <p>You can enable or disable the <b>My PDF documents do not have images</b> check box directly in the UI when creating a learning instance.</p> <p><a href="#">Disable PDFBox option</a></p>
Changed feature
<p>The draw box icon for document values is no longer available. However, you can still click and drag a box on the document to draw boxes for the labels along with the values.</p>

Fixed features	
Service Cloud case ID	Description
--	A new REST API is now available that contains the IQ Bot validator URLs of all the available documents that are not locked by any users. A validator URL retrieved from the REST API can be used in any browser to navigate directly to that specific document.
00343034	You are now redirected to a specific document using the validator URL after a successful login.
00471068, 00339407	The draw box functionality for field labels now ensures that the selected value is treated as an entire word rather than distinct characters. You can now select multiple system identified regions (SIRs) or a specific part of a single SIR from a field label, which enables accurate data extraction.
--	The PDF Box feature now enables you to generate an SIR for a PDF file that contains content in multiple formats.
00481720	The Service account user password can now include special characters. The service account will not be locked and all the IQ Bot services will start successfully after an installation, irrespective of whether the password has special characters.
00510286, 00548393	When the Automation Anywhere Cognitive Application service restarts after installing IQ Bot Build 4705, the user login information is now captured without any duplication.  However, if you upgrade from any earlier version of IQ Bot to IQ Bot A2019.13 (Build 4705), you must deregister and register IQ Bot services.
00522978	When you now install IQ Bot, the user account is not locked even when the password has special characters, and all the IQ Bot services start without any issues.
00581425, 00581949, 00604394, 00602630	You can now register IQ Bot with child tenant using API, which enables you to view all the available domains and learning instances.
00575939, 00417631, 00423076	The <code>.csv</code> file is now displayed in the <b>Output</b> folder when you upload a document with a long filename (more than 60 characters) using <b>IQ Bot Upload</b> .

Known limitations
<p>IQ Bot On-Premises</p> <p>The OSS Disclosure report provided in the IQ Bot A2019 installer is outdated. Starting from this release, you can go to Automation Anywhere support site to download the updated report:</p> <p><a href="#">A-People Downloads page (Login required)</a>.</p>

Known limitations
<p>IQ Bot On-Premises and Cloud</p> <p>Images on the Designer in IQ Bot appear distorted while scrolling in Internet Explorer.</p>
<p>IQ Bot On-Premises and Cloud</p> <p>Installation errors are displayed for the Database Migration Assistant.</p> <p>Workaround: Install the <code>MsSqlCmdLnUtils</code> utility and <code>Microsoft ODBC Driver 17</code> for SQL Server before installing the Database Migration Assistant.</p>
<p>IQ Bot On-Premises and Cloud</p> <p>Logs are not captured if the Database Migration Assistant installation fails.</p>
<p>IQ Bot Cloud</p> <p>System suggestions are not updated when documents are validated by the user.</p> <p>Workaround: Users must update the correction manually in the validator for IQ Bot Cloud if the system suggestions are not displayed.</p>
<p>IQ Bot Community Edition</p> <p>The <b>Create new learning instance</b> page refreshes automatically, which causes the user to lose data from the <b>General information</b> fields.</p>
<p>(Service Cloud case ID: 00737991)</p> <p>When you are creating a learning instance and training your document, IQ Bot system cannot extract data from tables with the same Header Name and Column Value.</p> <p>Workaround: Try combining Header Name or Column Value with the adjacent column. Additionally, you can provide a Python postprocessing script to separate the values during extraction.</p>

## Bot Insight

New features
<p>Compare mode widget filter</p> <p>The Bot Insight compare mode introduces widget filters that you can apply to your existing dashboards. A new <b>Filter</b> option shows a <b>Filter</b> window with the <b>Attributes</b>, <b>Numeric</b>, and <b>Time</b> widgets.</p> <p><a href="#">Comparing dashboards</a> on page 3944</p>
<p>Hourly support for widgets</p> <p>The Bot Insight widgets include an <b>Hour</b> interval option in the <b>Group By</b> field for <b>Date</b> type. The analytics for this widget groups your data by hourly intervals and displays the chart accordingly.</p> <p><a href="#">Using widgets</a> on page 3950</p>

Changed features
<p>Power BI connector</p> <p>You can access the AABotInsightV3.mez data connector file from C:\Program Files\Automation Anywhere\Enterprise\Connectors\PowerBI and copy it to C:\Users\<your user="">\Documents\PowerBI Desktop\Custom Connectors to deploy the Power BI connector.</your></p> <p><a href="#">Deploy Power BI connector</a> on page 3957</p>
<p>Bot Insight APIs</p> <ul style="list-style-type: none"><li>• All of the parameters are now optional.</li><li>• The botname parameter in the Get task log data API supports multiple bot names, separated with a comma.</li><li>• There are no time period limitations now on the data retrieved.</li></ul> <p><a href="#">Bot Insight API</a></p>

## Enterprise A2019.12 Release Notes

Release date: 18 May 2020

Review the new features, supported packages, changed features, fixed features, and known limitations in the Enterprise A2019.12 (Build 4111) release. IQ Bot Build 4088 is compatible with Enterprise A2019.12 Build 4111. There are no security fixes in this release.

- [Enterprise A2019](#)
- [IQ Bot A2019](#)
- [Bot Insight A2019](#)

## Enterprise A2019

---

**Important:** This release includes a required update to your . Ensure that you complete the update to continue with your automation activities when upgrading from a previous release to this release.

[Automatically update the Bot Agent](#) on page 1361 | [Manually update the Bot Agent](#) on page 1362

---

To verify which version is compatible with this release, see [Compatibility with release builds](#) on page 1333.

New features
<p data-bbox="331 247 1419 310">Migration from Enterprise 11 and Enterprise 10 Task Bots and MetaBots to Enterprise A2019 (currently available only to those in the Migration Early Adopter Program)</p> <p data-bbox="331 325 532 352">Enterprise A2019</p> <p data-bbox="331 373 1414 468">Migration to Enterprise A2019 is currently only available to select customers through our Migration Early Adopter Program. If you are interested in learning more about this program and requirements, contact your Automation Anywhere representative.</p> <ul data-bbox="331 485 1419 892" style="list-style-type: none"><li data-bbox="331 485 1419 562">• Migrate Task Bots and MetaBots created in Enterprise 10 to Enterprise A2019. <a href="#">Migrate Enterprise bots</a> on page 1590</li><li data-bbox="331 569 1419 678">• The summary report generated by the Bot Scanner now provides information about the number of bots that can or cannot be migrated to Enterprise A2019. <a href="#">Analyze Bot Scanner report for migration</a> on page 1534</li><li data-bbox="331 684 1419 800">• (Enterprise 11 only) Additional support is provided for packages and variables. <a href="#">Package mapping for migration</a> on page 1620   <a href="#">Variable mapping for migration</a> on page 1655</li><li data-bbox="331 806 1419 892">• (Enterprise 11 only) Migration APIs enable you to migrate a single Enterprise 11 bot or entire folders of bots to Enterprise A2019. Use the Repository Management API to identify bots and folders for migration. <a href="#">Migration API</a>   <a href="#">Repository Management API</a></li></ul>
<p data-bbox="331 989 959 1016">Integrate Control Room with a remote Git repository</p> <p data-bbox="331 1037 532 1064">Enterprise A2019</p> <p data-bbox="331 1085 1409 1207">Integrate the Control Room with remote Git repositories to manage bot version controls, and back up and restore bots and the dependent files. The integration ensures one-to-one mapping of bots between the Control Room and the remote Git file structure. When you perform a bot check-in, a Git commit is performed at the remote Git host.</p> <p data-bbox="331 1228 1057 1255"><a href="#">Integrating Control Room with Git repositories</a> on page 1824</p>
<p data-bbox="331 1283 935 1310">Additional actions in the Interactive forms package</p> <p data-bbox="331 1331 824 1358">Enterprise A2019 and Community Edition</p> <p data-bbox="331 1379 1065 1407">The Interactive forms package includes the following actions:</p> <ul data-bbox="331 1428 1252 1528" style="list-style-type: none"><li data-bbox="331 1428 1252 1455">• <b>Set focus:</b> Sets the focus on the selected form element.</li><li data-bbox="331 1461 1252 1488">• <b>Highlight:</b> Highlights the selected element of a form.</li><li data-bbox="331 1495 1252 1522">• <b>Unhighlight:</b> Removes the highlight from the selected element of a form.</li></ul> <p data-bbox="331 1564 813 1591"><a href="#">Interactive forms package</a> on page 2738</p>

New features
<p>Form builder enhancements for interactive forms</p> <p>Enterprise A2019 and Community Edition</p> <p>The form builder includes the following elements:</p> <ul style="list-style-type: none"> <li>• <b>Document:</b> Use this element to render an image (.jpg) or PDF file along with the form.</li> <li>• <b>Password:</b> Use this element for a field that requires masking of the input data.</li> </ul> <p><a href="#">Create a form</a></p>
<p>Run Task Bot option for attended Bot Runner (Service Cloud case ID: 00453797)</p> <p>Enterprise A2019 and Community Edition</p> <p>If the default device is mapped to the Bot Agent, a user with an attended Bot Runner license in the Control Room can now use the <b>Run Task Bot</b> option from the bot context menu (vertical ellipsis) to run the bot.</p> <p><a href="#">Considerations for running a bot</a> on page 2283</p>
<p>New features in Universal Recorder and actions that use the recorder feature</p> <p>Enterprise A2019 and Community Edition</p> <ul style="list-style-type: none"> <li>• Secure recording mode ensures that sensitive data is not stored in the bots. When secure recording mode is enabled, the bots do not capture application images or values.</li> </ul> <p>Actions in the Image Recognition, Mouse, OCR, Screen, and Recorder packages support this feature.</p> <ul style="list-style-type: none"> <li>• JRE 6 is supported on both 32-bit and 64-bit systems.</li> <li>• After you capture an object, you are returned to the window containing the Bot editor.</li> </ul> <p>Actions in the Image Recognition, Mouse, OCR, Screen, and Recorder packages support this feature.</p> <p><a href="#">Recording tasks in applications that run on JRE</a> on page 2256   <a href="#">Secure recording mode</a> on page 2255</p>
<p>Insert a work item action</p> <p>Enterprise A2019 and Community Edition</p> <p>The Insert work item action provides you the flexibility to insert a work item from an existing queue to another queue as part of the bot execution. You can orchestrate multiple bots, enabling optimal device utilization through the queueing mechanism of workload management.</p> <p><a href="#">Workload package</a> on page 3184</p>
<p>View error details of a work item</p> <p>Enterprise A2019 and Community Edition</p> <p>You can view the reason for a workload automation failure in the new <b>Error</b> section on the <b>View work item</b> details page.</p> <p><a href="#">View work items</a> on page 2026</p>

New features
<p>Extract text from windows</p> <p>Enterprise A2019 and Community Edition</p> <p>Use the <b>Capture text of window</b> action to extract text from a window and save it to a string variable. You can capture text from UNIX shells and Windows applications.</p> <p><a href="#">App Integration package</a> on page 2423</p>
<p>Store string values securely in a credential variable</p> <p>Enterprise A2019 and Community Edition</p> <p>Configure a credential variable to hold a user-provided value or a credential from the Credential Vault. A credential variable cannot be converted to another data type, and the value cannot be displayed in a message box or written to a file.</p> <p><a href="#">User-defined variables: Credential</a></p>
<p>Preload packages for improved bot performance</p> <p>Enterprise A2019 and Community Edition</p> <p>Preload packages on your local device to shorten the bot runtime. When you preload packages used in a bot, the system skips the package download process at bot runtime, thereby improving the bot performance.</p> <p><a href="#">Preload packages</a> on page 2310</p>
<p>New features in the If and Loop packages</p> <p>Enterprise A2019 and Community Edition</p> <ul style="list-style-type: none"><li>Execute actions based on whether the value of the source datetime variable is <b>Equal to</b> or <b>Not Equal to</b>, or is <b>Greater than</b> or <b>Equal to</b>, or is <b>Lesser than</b> or <b>Equal to</b> the value of the target datetime variable.</li><li>Execute actions on migrated bots based on whether <b>Web control</b> exists or is active.</li><li>Configure a <b>Loop</b> action with multiple conditions. Specify whether all or either of the conditions must be met.</li></ul> <p><a href="#">If package</a> on page 2724   <a href="#">Loop package</a> on page 2784</p>
<p>Run a bot by inserting a file variable in the Run action</p> <p>Enterprise A2019 and Community Edition</p> <p>The <b>Task Bot &gt; Run</b> action now supports a file variable input in the <b>Task Bot to run</b> field.</p>
<p>Configure a table variable using the <b>Assign</b> action in Data Table package</p> <p>Enterprise A2019 and Community Edition</p> <p>You can use this action to manually enter values, assign column names, specify the column data type (string, number, datetime, or Boolean), and move columns and rows.</p> <p><a href="#">Data Table package</a> on page 2452</p>

New features
<p>Configure Wait package actions to terminate a running bot if a condition is unsatisfied</p> <p>Enterprise A2019 and Community Edition</p> <p>Select the <b>Throw an exception</b> option in the Wait for screen change and Wait for window actions to show an error message and terminate a bot if the screen does not change or the window does not open or close within the specified amount of time.</p> <p><a href="#">Using Wait for screen change action</a> on page 3157   <a href="#">Using Wait for window action</a> on page 3160</p>
<p>Email trigger for new emails</p> <p>Enterprise A2019 and Community Edition</p> <p>Use email triggers to start a bot when a new email message is received in the specified email service. Supported email services are:</p> <ul style="list-style-type: none"><li>• Microsoft Outlook</li><li>• Email Server</li><li>• EWS Server</li></ul> <p><a href="#">Add an email trigger</a> on page 2287</p>
<p>Generate a random integer from a user-specified range and assign it to a number variable</p> <p>Enterprise A2019 and Community Edition</p> <p>Use the <b>Random</b> action from the Number package to generate an integer in the range of -9,223,372,036,854,775,808 through 9,223,372,036,854,775,807.</p> <p><a href="#">Random number action</a></p>
<p>Enterprise A2019 Bot Agent OS support</p> <p>Enterprise A2019</p> <p>Enterprise A2019 Bot Agent is now supported for single users on Windows Server 2019, Windows Server 2016, Windows Server 2012, Windows 8, and Windows 7 SP1.</p> <p><a href="#">Bot Agent compatibility</a> on page 1332</p>
<p>Return the Bot Agent installation path using the system variable AAInstallationPath</p> <p>Enterprise A2019 and Community Edition</p>
<p>Copy and paste actions and triggers between bots (Service Cloud case ID: 00455116)</p> <p>Enterprise A2019 and Community Edition</p> <p>Use the <b>Copy to shared clipboard</b> and <b>Paste from shared clipboard</b> icons at the top of the Bot editor to duplicate actions, triggers, and metadata at a time.</p>



New features
<p>GDPR self-reporting</p> <p>Enterprise A2019 and Community Edition</p> <p>General Data Protection Regulation self-reporting enables the Control Room administrator to run reports that include the following data elements (sensitive data will be masked in the output):</p> <ul style="list-style-type: none"> <li>• User Bot Runner device access.</li> <li>• User data in associated credential vault.</li> <li>• Devices registered by the user.</li> <li>• All documents (artifacts) uploaded or updated to public or private repositories by the user.</li> <li>• All bots associated to the user.</li> <li>• Bot Insight dashboard report includes a list of all dashboards associated to this user ID.</li> </ul>

Supported packages	
Package	Version
Node Manager	6.5.4738
Application	2.0.0-20200418-005328
App Integration	1.0.0-20200418-005326
Analyze	2.2.1-20200314-193039
Boolean	2.0.0-20200418-005329
Bot Migration	2.3.0-20200424-015945
Browser	2.0.0-20200418-005330
Clipboard	2.0.0-20200418-005342
Comment	2.0.0-20200418-005342
CSV/TXT	2.0.0-20200418-005342
Database	2.0.0-20200418-005345
Data Table	2.0.0-20200418-005637
Datetime	2.0.0-20200418-005348
Delay	2.1.0-20200418-005348
Dictionary	2.0.0-20200418-005349
Run DLL	2.0.0-20200418-005620
Email	2.0.0-20200418-005352
Error handler	2.0.0-20200418-005357
Excel basic	2.0.0-20200422-000204
Excel advanced	2.0.0-20200422-000103

Supported packages	
Package	Version
File	2.0.0-20200418-005358
File & folders	2.0.0-20200317-030352
Folder	2.0.0-20200418-005400
FTP / SFTP	2.0.0-20200418-005404
IF/ELSE	2.0.0-20200418-005406
Image Recognition	2.0.0-20200420-104210
Interactive forms	2.12.0-20200420-084203
IQ Bot	2.0.0-20191031-150538
JavaScript	2.0.0-20200418-005413
Simulate keystrokes	2.0.0-20200418-005415
Legacy Automation	1.0.0-20200422-075546 1.0.0-20200422-075549
List	2.0.0-20200418-005422
Log To File	2.0.0-20200418-005423
Loop	2.0.0-20200418-005424
Message Box	2.0.0-20200418-005424
Mouse	2.0.0-20200418-005428
Number	2.0.0-20200418-005433
OCR	2.1.0-20200418-005434
Microsoft 365 Excel	2.0.0-20200418-005517
Microsoft 365 Calendar	2.0.0-20200418-005338
Microsoft 365 OneDrive	2.0.0-20200418-005523
PDF	2.1.0-20200418-005526
PGP	2.1.0-20200418-005528
Ping	2.0.0-20200418-005529
Printer	2.0.0-20200418-005535
Play Sound	2.0.0-20200418-005530
Prompt	2.0.0-20200418-005536
Python Script	2.0.0-20200418-005537
Recorder	2.0.0-20200318-020414
REST Web Service	2.0.0-20200418-005619
SAP	2.1.0-20200418-005622

Supported packages	
Package	Version
Screen	2.0.0-20200418-005625
SNMP	2.0.0-20200418-005627
SOAP Web Service	3.0.0-20200418-005630
String	3.0.0-20200418-005635
System	2.0.0-20200418-005636
Task	2.0.0-20200417.230104-1256
Terminal Emulator	2.0.0-20200418-005641
Trigger Email	1.1.0-20200418-005652
VBScript	2.0.0-20200418-005643
Wait	3.0.0-20200418-005645
Window	2.0.0-20200418-005700
Workload	2.0.0-20200422-054201
XML	2.0.0-20200418-005650

Changed features
<p>Build 4105 replaced with Build 4111</p> <p>Build 4105 has been deprecated and replaced with Build 4111. If you have installed Build 4105 on Windows, perform a regular upgrade to get the new build. If you have installed Build 4105 on Linux, you must uninstall it and reinstall Build 4111. After you are on Build 4111, an update to Bot Agent 7.0.4789 is also required.</p> <p><a href="#">Update Automation 360 to latest version</a> on page 1423</p>
<p>User interface changes in Excel basic and Excel advanced packages</p> <p>The text field titled <b>Cell name</b> is now <b>Cell address</b> in the actions from the Excel basic and Excel advanced packages.</p>
<p>Specify the column title in the Get cell address action in the Excel advanced package</p> <p>The <b>Specific cell</b> option is now the <b>Based on header</b> option, which accepts the column title as either the column heading or the default column title.</p> <p><a href="#">Using the Get cell address action</a> on page 2588</p>
<p>Edit a work item without changing its status</p> <p>You no longer have to change the status of a new work item for editing. You can now edit work items that are in <b>New</b> status. Previously, you were allowed to edit the work item attribute values after changing the state of the attributes so that the edits to the work item could be saved.</p> <p><a href="#">Edit work items</a> on page 2027</p>

Changed features
<p>Mark work items for reprocessing</p> <p>The <b>Ready to run</b> action is now updated to <b>Re-process</b> so that you can mark work items that are in <b>Failed</b>, <b>Data error</b>, or <b>On hold</b> state to <b>New</b> status for reprocessing.</p> <p><a href="#">View work items</a> on page 2026   <a href="#">Edit queues</a> on page 2013</p>

Fixed features	
Service Cloud case ID	Description
00560339	You can now do a second checkout of the same bot, make updates (for example delete a command) , and check it back in. The "File Not Found" error that prevented subsequent checkouts of the same bot and data deletion not actually getting deleted has been fixed.
--	Devices running an older version of the Bot Agent can now connect to A2019.12 Control Room.
--	Secure Data Store (SDS) installation on Enterprise A2019.12 is now working.
00530388	Multiple bot updates and check-ins succeed irrespective of the Enterprise A2019 version used to import the bot.  Bot check-in on Cloud deployments used to fail when the bot was imported multiple times and overwritten. This issue is now fixed.
00521691	After Excel files are extracted from a .zip file, common tasks such as renaming and deleting the Excel files failed. This issue is now fixed.
00519528	Bot Scanner version 2.0.0 now works as expected. The crash issue is now fixed.
00517040	When the Email package is used in Exchange Web Services, the action loop exited after processing 10 emails. This early exit is fixed. Now all specified emails are processed before the loop exits.
00504163	When bots are run using the <b>Open</b> and <b>Close</b> actions from the <b>DLL</b> package in a loop, the Bot Agent window now functions correctly. The Bot Agent service does not require a manual restart after a bot is run.
00494267	Actions from the <b>DLL</b> package can now be run inside and outside a loop.
00494273	The <b>Create worksheet</b> action in the Excel advanced package now supports default sheet names for all the supported languages in Enterprise A2019.
00492554	The <b>Sort table</b> action in the Excel advanced package now supports OS setting for the Swedish region.

Fixed features	
Service Cloud case ID	Description
00446956	The <b>Open</b> action in the CSV/TXT package can now read values from files encoded with UTF-8.
00503230	The SOAP Web Service action now supports responses with non-English characters.
00522147	The <code>StringVar.String:trim</code> shorthand now trims leading and trailing spaces in a string when used in the <b>Message box</b> package.
--	You can now deploy bots on selected Bot Runner devices with the <b>Run as</b> option from the <b>My bots</b> page in an Control Room configured on Microsoft Azure.
--	Scheduled bots now run as expected and do not get stuck in the queue in an Control Room configured on Microsoft Azure.
--	After you capture an object in a browser or application window, the browser window containing the Bot editor is now reactivated. Previously, users had to manually return to the Bot editor.  Actions in the Image Recognition, Mouse, OCR, Screen, and Recorder packages support this feature.
00475070	Exporting a report to CSV from <b>Activity &gt; Historical</b> now correctly outputs the data.
00516331	You can now build a bot that contains more than one <b>Database &gt; Read from</b> action that is followed by a <b>Loop</b> action, within the same database session. Each time the bot runs the <b>Read from</b> action, the query results are refreshed, and the loop will only iterate on the current results.
00509735	Auto Login now works when you deploy a bot as an unattended Bot Runner on a Horizon Virtual Desktop Infrastructure (VDI) session.
00509831	Prompt package actions now support long inputs. The user interface displays up to 512 characters. If the input is longer than 512 characters, the rest appear as a tooltip when the user hovers over the prompt box.
00518566	You can now use the recorder feature within actions to select window titles and file paths on a device that has proxy authentication enabled. Previously, users had to manually enter this information because they could not access the device through actions while building a bot.
00475107	The Japanese language now supports column names when using CSV-related actions.

Fixed features	
Service Cloud case ID	Description
00532894 00532253 00539241	When you reimport a bot using exported files from a different Control Room of the same version (from version A2019.12 onward) and choose to overwrite the bot, you can now check-in that bot. The error generated when you choose the overwrite option that prevented check-in of the reimported bot is now fixed only for version A2019.12 onward. Reimporting bots on A2019.11 and older releases are not supported at this time.
00521222, 00525635, 00529274, 00526613, 00526489, 00530609, 00530787, 00533445, 00535366, 00530900, 00538070	The progress of a Task Bot is not stalled at line 0 and does not remain in queue to run when you deploy the bot on a Bot Runner. The status of the device reflects <b>Yet to Be Determined</b> until the device is available to process the items.
00421195	You can now create a work queue by providing details such as the queue name, queue owners, participants, consumers, and work item structure. This feature is available from <b>Workload &gt; Queues &gt; Create Queue</b> .
00533465	When you delete any action from an existing bot, the corresponding metadata for the deleted action is now removed from the bot.

Known limitations
If you are running A2019.12 Enterprise On-Premises with build 4105 on Linux and want to use Build 4111, then you must uninstall Build 4105 and do a fresh installation of Build 4111. You cannot perform an upgrade to get Build 4111. See <a href="#">Uninstall Automation 360 On-Premises from Linux server</a> on page 1301. A2019.12 Enterprise On-Premises on Windows can be upgraded as normal.
The <b>Send reset password email</b> functionality (from the <b>Administration &gt; User</b> page) to help users reset their password is not working and returns a 401 error. Users should use the "Forgot password?" flow to reset their password.
Folders created using the <b>Folder &gt; Create</b> action cannot have names that contain system actions or device references such as AUX, CON, LPT, NUL, and PRN.
Mouse click with key combo for preset triggers in SAP application is currently not supported.

Known limitations
<p>The following are known limitations in the form builder:</p> <ul style="list-style-type: none"> <li>• If the character limit is set to 0 and the field is marked necessary for the <b>Password</b> element in a form, an error message is displayed when you run the bot.</li> <li>• An invalid file path associated with the <b>Document</b> element in a form displays an error message when the <b>Get</b> and <b>Set</b> actions of the interactive forms are used.</li> <li>• A blank page is displayed on the form builder when you paste content into any of the existing form elements.</li> <li>• A form that is linked to a bot through the <b>Display</b> action of interactive forms is displayed in front of all other windows, even when the <b>Always display form window in front</b> option is not selected.</li> </ul>
<p>Cloud-enabled deployments only support local authentication.</p>
<p>Linux is not supported for Cloud-enabled On-Premises installations.</p>
<ul style="list-style-type: none"> <li>• Work items might be queued on the <b>View queues</b> page as the number of devices in the device pool increase. This should not affect the bot execution because the queues are cleared when the work items are processed.</li> <li>• You cannot simultaneously insert work items from multiple devices in a queue.</li> <li>• You cannot create a draft queue.</li> <li>• When you insert a number value using the <b>Insert work item</b> to a queue, the system shows an incorrect value. For example, if you insert 023456789, the system shows 2.3456789E7.</li> <li>• When you add more devices to a device pool that is processing workload management automations, the newly added devices might not immediately pick up the pending work items.</li> </ul> <p>Workaround: Pause and resume the workload management automation.</p>
<p>If a device goes idle while processing workload management work items in a device pool, it will not process the work items. However, those work items can be processed by other devices in the pool.</p>
<p>When you create a form with using the <b>Document</b> element and provide an incomplete file path, your bot will not run successfully.</p>
<p>When you create a form and specify that a password is required, the password length can be set to 0.</p>

## IQ Bot (Build 4088)

Enterprise A2019.12 Build 4111 is compatible with IQ Bot A2019 (Build 4088).

The IQ Bot On-Premises version supports all the features and functionality available in IQ Bot Version 6.5.2.

[IQ Bot feature comparison matrix](#)

Review the compatibility of the IQ Bot On-Premises version with the corresponding Automation Anywhere Control Room On-Premises version.

[Automation 360 IQ Bot version compatibility](#) on page 1010

The IQ Bot Cloud version is available for this release and supports all features and functionality available in IQ Bot Version 6.5.2. This version provides users with automatic provisioning for up to three environments such as Development, Test, and Production. Users can migrate learning instances between environments using APIs.

The IQ Bot Community Edition and the free trial version are available for this release. Both versions have feature parity and are based on IQ Bot Version 6.5.2.

Known limitations
<p>IQ Bot On-Premises</p> <p>IQ Bot registration is not supported for Cloud-enabled On-Premises installations.</p>

## Bot Insight

New features
<p>View filtered data of the dashboard widgets</p> <p>Enterprise A2019 and Community Edition</p> <p>The Bot Insight dashboard widget filter enables you to apply filters across the widgets in the dashboard to display filtered data. While the dashboard filters enable you to view different combinations of information from a single dashboard, the widget filters enable you to drill down to information from the already filtered data. You can also save and publish the custom dashboards with the preset widget filters.</p> <p><a href="#">Bot Insight dashboard filter</a> on page 3942</p>
<p>Retrieve information from the Bot Insight API, and generate and visualize data analytics on Microsoft Power BI</p> <p>Enterprise A2019 and Community Edition</p> <p>The Automation Anywhere custom connector enables you to establish a secure connection to Microsoft Power BI, and generate and visualize data analytics. You can select the Bot Insight APIs in Microsoft Power BI and apply specific parameters for each of the APIs. The custom connector transforms the Bot Insight API responses to data model visualizations in Microsoft Power BI.</p> <p><a href="#">Data connector for Power BI</a> on page 3956</p>
<p>Preview and analyze business information in the default business dashboard</p> <p>Enterprise A2019 and Community Edition</p> <p>The <b>Data Preview</b> menu in the Bot Insight default business dashboard displays information that is logged for multiple <b>Analyze Open</b> and <b>Close</b> commands used in the bot. The <b>Preview Data</b> menu does not appear when you perform a comparison between the default dashboards.</p>



**New features**

API enhancements

Enterprise A2019

The `deletetasklogdata` API is updated to include the `runId` parameter. The `getbotrundata` API retrieves information about the vital statistics of the bot. The `getaudittraildata` API retrieves information about the audit data that is logged for all users.

[Bot Insight API](#)

Related concepts

[Migrate to Automation 360](#) on page 1496

Migration (upgrade) is the process of moving your data and bots from Enterprise 11 or Enterprise 10 to Automation 360. Migration includes but is not limited to replicating and updating your existing database and repository, converting your bots to the Automation 360 format, and migrating learning instances for IQ Bot and dashboards for Bot Insight.

Related tasks

[Update Automation 360 to latest version](#) on page 1423

Update Automation 360 On-Premises to the latest version to get new features and enhancements that help improve and scale your automation programs.

[Updating Automation 360 IQ Bot](#) on page 1476

Update Automation 360 IQ Bot On-Premises to the most recent version for all the latest features and enhancements.

## Enterprise A2019.11 Release Notes

Review the new features, supported packages, changed features, fixed features, and known limitations in the Enterprise A2019.11 (Build 3337) release. There are no security fixes in this release.

- [Enterprise A2019](#)
- [IQ Bot](#)
- [Bot Insight](#)

## Enterprise A2019

**Important:** This release includes a required update to your . Ensure that you complete the update to continue with your automation activities when upgrading from a previous release to this release.

[Automatically update the Bot Agent](#) on page 1361 | [Manually update the Bot Agent](#) on page 1362

To verify which version is compatible with this release, see [Compatibility with release builds](#) on page 1333.

**New features**

## Migrate 11.x Task Bots and MetaBots to Enterprise A2019

## Enterprise A2019

- Additional support is provided for packages and variables.  
[Package mapping for migration](#) on page 1620 | [Variable mapping for migration](#) on page 1655
- You can now migrate MetaBots (with DLLs) and their components from Enterprise 11 to Enterprise A2019. You cannot migrate screen-based MetaBots.  
[How MetaBots are migrated](#) on page 1596
- Use the Bot Scanner to analyze MetaBots to determine if they can be migrated.
- Verify the list of certified Enterprise 11 bot versions available for migration: [Supported Control Room versions for migration](#) on page 1506

## Bot Store integration with the Control Room

## Enterprise A2019

You can now access the Bot Store from within the Control Room. You can install, configure, and run the Bot Store bots within the Control Room.

As a registered user, you can log in to the Bot Store from the Control Room and access all your downloads. You can install bots and packages from your downloads to the Control Room private repository. You can also submit your existing bots and packages from the Control Room to the Bot Store.

[Bot Store](#) on page 3607

## Use interactive forms in a bot

## Enterprise A2019

Interactive forms provide a form builder experience for users to build interfaces for submitting and regrouping data being used to send and receive data from various applications within their attended automation process. Users with Bot Creator and Bot Runner license can use the interactive forms package to control and manage the form flow within a bot during runtime. Actions performed by users on the interactive forms can be monitored to execute logic using subtasks.

Interactive forms are first-class citizens within the bot repository and have the same workflows for moving forms between public and private workspaces, and for export or import actions. No additional licenses or permission are required to use interactive forms.

Action items in the interactive forms can be used to manage various forms within a bot.

[Using interactive forms](#) on page 3292

New features
<p>Reuse an identical value between bots by configuring a global value in the Control Room Enterprise A2019 and Community Edition</p> <p>A global value enables users to reuse an identical value between bots instead of creating a new variable for each bot. Global values remain constant for all users and bots in an Control Room instance. A user with the <code>AAE_admin</code> role can configure a global value with a default value and enable non-admin users to overwrite the value to use in their bots.</p> <p><a href="#">Global values</a> on page 2350   <a href="#">Create a global value</a> on page 2351   <a href="#">Overwrite the default value</a> on page 2353</p>
<p>Workload enhancements</p> <p>Enterprise A2019 and Community Edition</p> <ul style="list-style-type: none"><li>• Monitor the progress of ongoing workload automations. You can also pause, resume, or stop the automations as required.</li><li>• Configure and edit workload automations to ensure that the automations are deployed seamlessly to unattended Bot Runner devices. Execute the workload automations with priority or round-robin mode from the <b>Devices &gt; Edit Device pool</b> page.</li><li>• Set the output status of the work item processed in the Control Room on the <b>Queues</b> and <b>Work item</b> details page using the <code>\$workItemResult\$</code> variable in a Task Bot.</li><li>• Edit work items that are in <b>Ready to run</b>, <b>On hold</b>, <b>Data error</b>, or <b>Failed</b> state.</li><li>• Set the individual work item status to <b>Mark complete</b>, <b>Defer</b>, or <b>Re-process</b> from the <b>Edit work item</b> page or in bulk from the <b>View queues</b> page.</li></ul> <p><a href="#">View automation of a queue</a> on page 2018   <a href="#">Edit device pools</a> on page 1885   <a href="#">Edit work items</a> on page 2027   <a href="#">Use Work Item variables</a> on page 2343</p>
<p>Download a file from the Control Room to your device</p> <p>Enterprise A2019 and Community Edition</p> <p>Use the <b>Download CR file</b> action from the File package to download a file from the Control Room to your device.</p> <hr/> <p><b>Note:</b> You cannot use this action to download a bot or a file from the <code>My Scripts</code> folder.</p> <hr/> <p><a href="#">File package</a> on page 2600</p>

**New features**

## Clone a bot or files

Enterprise A2019 and Community Edition

Create a read-only copy of a selected bot or file from the public repository to the private repository. The clone is a local copy for the same user and will not be updated with the public repository copy automatically. This provides a testing environment experience for Bot Creators to make and validate changes locally and take advantage of reusable Task Bots in concurrent developments by reusing an existing bot or file as a dependency.

- Cloned bots and files cannot be edited, renamed, or moved.
- Cloned bots and files can be deleted from a private repository.
- Users can create a copy of the cloned bot.
- A cloned bot can be used in Run Task action in another bot.
- Cloned bots and files can be added as a manual dependency for another bot.

## New features in the If package

Enterprise A2019 and Community Edition

- Configure an **If** action with multiple conditions.
  - Specify whether all or either of the conditions must be met.
- Verify whether JavaScript, Task, or VBScript ran successfully or not.
- Verify whether a string variable is empty or not.
- Execute actions only if two strings have matching uppercase and lowercase letters.

[If package](#) on page 2724 | [Example of using a conditional statement](#) on page 3208

## Universal Recorder enhancements

Enterprise A2019 and Community Edition

Universal Recorder now enables you to:

- Automate in Java applications that run using Java Runtime Environment (JRE) 9, 10, and 11.
- Capture objects in tables in Oracle EBS applications.
- Automate interactions with user interface objects in the taskbar, desktop, or currently active window. This option is available in the window selection drop-down list in the following packages:
  - Image Recognition
  - Mouse
  - Recorder
  - Screen
  - Simulate keystrokes
  - Window

[Universal Recorder for object-based automation](#) on page 2239

New features
<p>New features in the Excel advanced package</p> <p>Enterprise A2019 and Community Edition</p> <ul style="list-style-type: none"> <li>• In the <b>Replace</b> action, you can choose to replace cell values with an empty character.</li> <li>• In the <b>Get cell address</b> action, you can choose to save the retrieved cell address to a string variable.</li> </ul> <p><a href="#">Using the Replace action</a> on page 2593   <a href="#">Using the Get cell address action</a> on page 2588</p>
<p>Add DLL dependencies</p> <p>Enterprise A2019 and Community Edition</p> <p>As a bot creator, you can use a DLL that refers to a child DLL.</p> <p><a href="#">Bot dependencies</a> on page 2359</p>
<p>Licensing server failover</p> <p>Enterprise A2019</p> <p>HA failover from a primary cluster to a secondary cluster applies to all the servers, including the licensing server, and is handled by the data center high availability tools.</p> <p><a href="#">Distributed architecture with HA/DR support</a> on page 1028</p>
<p>Automate locking, logging off, restarting, or shutting down the computer</p> <p>Enterprise A2019 and Community Edition</p> <p>Use actions from the System package at the end of tasks to automate locking, logging off, restarting, or shutting down the computer.</p>
<p>Manage running bots with the Pause and Stop actions from the Task Bot package</p> <p>Enterprise A2019 and Community Edition</p> <ul style="list-style-type: none"> <li>• Insert a <b>Pause</b> action to temporarily pause the running bot.</li> <li>• Insert a <b>Stop</b> action to terminate the running bot.</li> </ul> <p><a href="#">Task Bot package</a> on page 3109</p>
<p>Automate printer settings</p> <p>Enterprise A2019 and Community Edition</p> <p>Use actions from the Printer package to automate retrieving and setting the default printer.</p>
<p>Return the path and name of the currently running Task Bot using the system variable AATaskName</p> <p>Enterprise A2019 and Community Edition</p> <p><a href="#">Predefined variables</a> on page 2328</p>

New features
<p>Run JavaScript, Python, or VBScript from a file selected from your desktop</p> <p>Enterprise A2019 and Community Edition</p> <p>You can select the file containing the script as part of configuring the action.</p> <hr/> <p><b>Note:</b> The file and any dependencies must be in a standalone folder. When you select a file for upload, all files and folders at the same folder level are uploaded.</p> <hr/> <p><a href="#">JavaScript package</a> on page 2760   <a href="#">Python Script package</a> on page 2907   <a href="#">VBScript package</a> on page 3153</p>
<p>Device optimization for bot deployment (Zendesk ID: 238675)</p> <p>Enterprise A2019 and Community Edition</p> <p>Bot Runner devices that are used for Workload automation are now available for deployment in the <b>Scheduled Automations</b> page. This ensures that idle devices during a workload cycle are available to the user with scheduling rights for Control Room deployment.</p> <p><a href="#">Edit device pools</a> on page 1885</p>

## Supported packages

Package	Version
Node Manager	6.0.4015
Application	2.0.0-20200302-135910
Analyze	2.2.1-20200314-193039
Boolean	2.0.0-20200302-135912
Browser	2.0.0-20200302-135913
Clipboard	2.0.0-20200302-135922
Comment	2.0.0-20200302-135922
CSV/TXT	2.0.0-20200312-122802
Database	2.0.0-20200302-135926
Data Table	2.0.0-20200302-140308
Datetime	2.0.0-20200302-135930
Delay	2.1.0-20200302-135931
Dictionary	2.0.0-20200302-135932
Run DLL	2.0.0-20200313-170350
Email	2.0.0-20200302-135934
Error handler	2.0.0-20200302-135940

Package	Version
Excel basic	2.0.0-20200302-140133
Excel advanced	2.0.0-20200302-140020
File	2.0.0-20200316-045955
File & folders	2.0.0-20200317-030352
Folder	2.0.0-20200302-135945
FTP / SFTP	2.0.0-20200302-135948
IF/ELSE	2.0.0-20200302-135950
Image Recognition	2.0.0-20200302-135953
IQ Bot	2.0.0-20191031-150538
JavaScript	2.0.0-20200313-170107
Simulate keystrokes	2.0.0-20200313-170111
Legacy Automation	1.0.0-20200317-220124 1.0.0-20200317-220128
List	2.0.0-20200302-140013
Log To File	2.0.0-20200302-140014
Loop	2.0.0-20200302-140015
Message Box	2.0.0-20200302-140016
Migration	2.0.0-20200317-220133
Mouse	2.0.0-20200302-140016
Number	2.0.0-20200302-140023
OCR	2.1.0-20200302-140025
Microsoft 365 Excel	2.0.0-20200309-140138
Microsoft 365 Calendar	2.0.0-20200305-124125
Microsoft 365 OneDrive	2.0.0-20200309-110128
PDF	2.1.0-20200302-140126
PGP	2.1.0-20200309-110135
Ping	2.0.0-20200302-140130
Printer	2.0.0-20200311-100204
Play Sound	2.0.0-20200309-110137
Prompt	2.0.0-20200302-140148
Python Script	2.0.0-20200313-170254
Recorder	2.0.0-20200318-020414
REST Web Service	2.0.0-20200312-090358

Package	Version
SAP	2.1.0-20200302-140250
Screen	2.0.0-20200302-140254
SNMP	2.0.0-20200302-140257
SOAP Web Service	2.0.0-20200312-110311
String	2.0.0-20200302-140306
System	2.0.0-20200309-140321
Task	2.0.0-20200317-030340
Terminal Emulator	2.0.0-20200302-140313
VBScript	2.0.0-20200313-170417
Wait	2.0.0-20200302-140319
Window	2.0.0-20200302-140348
XML	2.0.0-20200302-140321

Changed features
<p>Change in the <b>Dictionary &gt; Remove</b> action</p> <p>The <b>Dictionary &gt; Remove</b> action offers the option to assign the removed value to a variable.</p> <p><a href="#">Dictionary package</a> on page 2493</p>
<p>The <b>Update migration status</b> permission name has been changed to <b>Allow a bot-runner user to run migrations</b>. All functionalities remain the same.</p>
<p>When multiple bots are scheduled to run on the same user or device, the bots are now queued and run whenever the previous bots completes its run.</p> <p>Service Cloud case ID: 00440072</p> <p><a href="#">Scheduled activities</a> on page 2129   <a href="#">Workload management</a> on page 1996</p>

## Fixed features

Service Cloud case ID	Description
00483976	When the copy function is used, nested subfolders were not visible when users clicked browse to search through directories. This issue has been fixed.
00457550	When a user checks out a bot that uses the <b>Run</b> action to run child bots, the child bots are now cloned from the public repository to the private.



Service Cloud case ID	Description
00492706	When a user exports a bot from another Control Room and imports that same bot to a new Control Room, the imported bot and enabled packages now show all required actions.
00482934	Bot deployments and website launches are now optimized for quicker process.
00421864	When a user is viewing historical activity details in <b>Historical activity</b> , the run option is no longer displayed.
00505120	When bots fail the check-in process, the contents are now restored in the <b>Private</b> repository.
00488504	Bots with more than 100 dependencies are now exported successfully without an error, even if the parent bots are in the list of those 100 dependencies.
00444902	When the Control Room is used in Internet Explorer 11, the Bot Agent is now compatible and the UI is rendered properly.
00454079	When the <b>Capture</b> action in the Recorder package is used, content in the browser is captured successfully.
00460530	In a developer Control Room, a user can now successfully import a bot with cyclic dependency.
00493605	In the <b>Run</b> action in the Task Bot package, the <b>Assign the output to variable (optional)</b> option now functions properly when an assigned variable is removed.
00486734	When the <b>Set cell</b> action in the Excel advanced or Excel basic package is used with multiple Microsoft Excel files, the values of the <b>Active cell</b> operation now activate and set the cells accordingly in the respective Microsoft Excel file.
00530915	Migration is not advisable for Enterprise 11 customers using Workload Management due to known issues.
--	You can now add date variables in the <b>Vertical Bar Graph</b> widget in the Bot Insight <b>Business</b> dashboard.
00475173	All fields of the <b>Recorder &gt; Capture</b> action have been translated to Enterprise A2019 supported languages.
00476820	When a Bot Runner machine is logged off, the device shows the state as Disconnected in the Control Room. Previously, the device showed the state as Connected in the Control Room.

Known limitations
MetaBot logic that uses a DLL function call with one or more parameters migrates successfully. However, when you run the migrated bot, an error is shown.

Known limitations
Global values of the Date time data type cannot be used in actions.
The Enterprise A2019 On-Premises Control Room installation does not support the semicolon (;) special character in the Windows user password. The installation fails if you use this special character.
When data is exported into a CSV file from <b>User Management, Audit Logs, and Roles Management</b> for all locales except English, the respective language is not displayed correctly.  Workaround: Export to a CSV file and access a Microsoft Excel file. Import and save that CSV file as a CSV with UTF-8 encoding.
Users must explicitly enable the feature flag for the forms feature in the On-Premises build.  <b>Note:</b> Go to Automation Anywhere support site for more information: <a href="#">Interactive forms not available in Automation 360 v.11 On-Premises (A-People login required)</a>
Forms with many radio buttons and check boxes in the same row are not rendered correctly.
Only the <b>Form Events</b> and <b>UI Triggers</b> event types are supported by event loop as the file or folder triggers and hot keys have issues.

## IQ Bot

The IQ Bot On-Premises version is available for this release with additional features or updates since the last release. This IQ Bot version supports all the features and functionality available in IQ Bot Version 6.5.2.

[IQ Bot feature comparison matrix](#)

Review the compatibility of the IQ Bot On-Premises version with the corresponding Automation Anywhere Control Room On-Premises version.

[Automation 360 IQ Bot version compatibility](#) on page 1010

The IQ Bot Cloud version is available for this release and supports all features and functionality available in IQ Bot Version 6.5.2. This version provides users with automatic provisioning for up to three environments such as Development, Test, and Production. Users can migrate learning instances between environments using APIs.

The IQ Bot Community Edition and the free trial version are available for this release. Both versions have feature parity and are based on IQ Bot Version 6.5.2 .

New features
Upgrade from earlier versions of IQ Bot to the latest IQ Bot On-Premises IQ Bot On-Premises  If you are using any of the earlier versions of IQ Bot (5.3.x or 6.5.x), you can upgrade to IQ Bot A2019 Build 3337 On-Premises.  <a href="#">Updating Automation 360 IQ Bot</a> on page 1476

New features
<p>Use API to migrate learning instances between environments</p> <p>You can use an API to migrate learning instances in IQ Bot On-Premises.</p>
<p>Access IQ Bot from the Control Room dashboard</p> <p>Enterprise A2019 and Community Edition</p> <p>You can access IQ Bot from the Control Room through a link, provided you have registered IQ Bot in the Control Room. Otherwise, the IQ Bot section remains hidden.</p>

Known limitations
<p>IQ Bot On-Premises</p> <p>IQ Bot installation fails if the user password contains any of these special characters: single quotation mark ( ' ), quotation mark ( " ), or semicolon ( ; ).</p>
<p>IQ Bot Cloud</p> <ul style="list-style-type: none"> <li>• ABBYY FineReader Engine is the default OCR for data extraction in IQ Bot Cloud.</li> <li>• Data validation using Python script is not supported.</li> <li>• IQ Bot extensions for custom extraction are not available.</li> </ul>
<p>IQ Bot On-Premises and IQ Bot Cloud</p> <p>When you upload vector PDF documents to a new learning instance, a few documents are identified as unclassified. Alternatively, if you convert the documents from PDF to TIFF and upload them, the documents are processed successfully.</p>

## Bot Insight

New features
<p>View filtered data of Bot Insight dashboards</p> <p>Enterprise A2019</p> <p>The Bot Insight dashboard filter enables you to apply filters across dashboards to display filtered data on the dashboard widgets. The filter enables you to view different combinations of information from a single dashboard, thereby eliminating the need to maintain separate dashboards for different sets of users.</p> <p><a href="#">Bot Insight dashboard filter</a> on page 3942</p>

**New features**

View business analytics for multiple transactions simultaneously

Enterprise A2019

The **Multiple Transaction Names** menu displays transactional information about bots with multiple **Analyze- Open** and **Close** commands. Each **Analyze- Open** and **Close** command is considered as a transaction, and each transaction is displayed as a unique block in the data preview section. The number of rows for each unique transaction block is limited to 100.

[Business dashboard](#) on page 3935

## Enterprise A2019.10 Release Notes

Review the new features, supported packages, changed features, fixed features, and known limitations in Enterprise A2019.10 (Build 2545). There are no security fixes in this release.

- [Enterprise A2019](#)
- [IQ Bot](#)
- [Bot Insight](#)

## Enterprise A2019

To verify which version is compatible with this release, see [Compatibility with release builds](#) on page 1333.

**New features**

Migrate 11.3.x Task Bots to Enterprise A2019

Enterprise A2019

- Analyze whether you can migrate bots created in Enterprise Client version 10.x using the Bot Scanner.

[Analyze Bot Scanner report for migration](#) on page 1534

- Additional support is provided for packages and variables.

[Package mapping for migration](#) on page 1620 | [Variable mapping for migration](#) on page 1655

- Multiple Bot Runner users are supported for bot migration.

[Migrate Enterprise bots](#) on page 1590

AI Sense Recorder to capture objects from remote applications

This is a Beta release on Enterprise A2019 (Cloud deployment only) and Community Edition

Record a task and capture objects using the AI Sense Recorder from applications that are usually accessed remotely and with a complex user interface (UI).

[Record a task with AI Sense Recorder](#) on page 2257

New features
<p>Manage your automation as Work Items for resource optimization and workload automation</p> <p>Enterprise A2019 and Community Edition</p> <p>Divide your automation into small, logical modules called Work Items using the new feature. Process these Work Items simultaneously using queues to ensure that your organization's automation goals are achieved with optimum resource utilization.</p> <p>Use the workload module to create and manage workload queues and run bots on unattended Bot Runners through the workload queues. Also, pass the Work Item attributes or values to the bot from the Control Room when you <b>Run bot with queue</b> with the help of Work Item variables.</p> <p><a href="#">Workload management</a> on page 1996</p>
<p>Install Control Room on Red Hat Enterprise Linux 7.7 and Linux CentOS 7.7</p> <p>Enterprise A2019</p> <p>Use the command line to install your Control Room on your Linux servers in the datacenter.</p> <p><a href="#">Installing Control Room on Linux</a> on page 1293</p>
<p>Use wildcard characters in folder and file path fields in the Encrypt and Decrypt actions</p> <p>Enterprise A2019 and Community Edition</p> <p>Substitute an asterisk (*) for one or more unknown alphanumeric characters or symbols. This maximizes the search results by returning all folders and files that contain the string that you have specified.</p> <p><a href="#">Encrypt</a>   <a href="#">Decrypt</a></p>
<p>Use system variables to return data from the computer that is connected to the running Bot Agent</p> <p>Enterprise A2019 and Community Edition</p> <p>You can use the following system variables:</p> <ul style="list-style-type: none"><li>• <b>AAControlRoom</b>: Returns the URL of the Control Room.</li><li>• <b>CPUUsage</b>: Returns the percentage utilization of the CPU.</li><li>• <b>RAMUsage</b>: Returns the RAM usage in megabytes.</li><li>• <b>OSName</b>: Returns the operating system.</li><li>• <b>TotalRAM</b>: Returns the total amount of RAM available.</li></ul>

New features
<p>Automate tasks in Oracle EBS and Forms with the Universal Recorder Enterprise A2019 and Community Edition</p> <p>Open Oracle EBS applications in a browser as Java Web Start applications or as a thick client. The Universal Recorder can capture the following objects:</p> <ul style="list-style-type: none"> <li>• Window/Tab</li> <li>• Button</li> <li>• Text box</li> <li>• Label (read-only)</li> <li>• Radio button</li> <li>• Check box</li> <li>• Table/Grid</li> <li>• Scroll bar</li> <li>• Menu</li> <li>• Combo-box/Drop-down list</li> </ul>

## Supported packages

Package	Version
Node Manager	2.0.2885
Application	2.0.0-20200131-085947
Analyze	2.1.0-20200204-154550
Boolean	2.0.0-20200131-085949
Browser	2.0.0-20200127-180439
Clipboard	2.0.0-20200131-085958
Comment	2.0.0-20200130-183435
CSV/TXT	2.0.0-20200205-175938
Database	2.0.0-20200205-175940
Data Table	2.0.0-20200131-200235
Datetime	2.0.0-20200131-090006
Delay	2.1.0-20200131-090007
Dictionary	2.0.0-20200205-175946
Run DLL	2.0.0-20200205-230300
Email	2.0.0-20200206-135926
Error handler	2.0.0-20200130-183452
Excel basic	2.0.0-20200205-110122

Package	Version
Excel advanced	2.0.0-20200205-110012
File	2.0.0-20200131-090018
Folder	2.0.0-20200131-090021
FTP / SFTP	2.0.0-20200206-110020
IF/ELSE	2.0.0-20200131-090025
Image Recognition	2.0.0-20200131-090028
IQ Bot	2.0.0-20191031-150538
JavaScript	2.0.0-20200205-180013
Simulate keystrokes	2.0.0-20200205-105955
List	2.0.0-20200131-090039
Log To File	2.0.0-20200131-090040
Loop	2.0.0-20200131-090041
Message Box	2.0.0-20200131-090041
Migration	1.1.0-20200206-180601
Mouse	2.0.0-20200131-090044
Number	2.0.0-20200205-110015
OCR	2.1.0-20200131-090053
Microsoft 365 Excel	2.0.0-20200205-180122
Microsoft 365 Calendar	2.0.0-20200206-105949
Microsoft 365 OneDrive	2.0.0-20200127
PDF	2.1.0-20200131-090152
PGP	2.1.0-20200205-110117
Ping	2.0.0-20200131-090156
Play Sound	2.0.0-20200127-180654
Prompt	2.0.0-20200127-180707
Python Script	2.0.0-20200205-180148
Recorder	2.0.0-20200212
REST Web Service	2.0.0-20200206-110309
SAP	2.1.0-20200205-180245
Screen	2.0.0-20200131-090311
SNMP	2.0.0-20200207-090446
SOAP Web Service	2.0.0-20200127-180819
String	2.0.0-20200131-090323

Package	Version
System	2.0.0-20200205-110240
Terminal Emulator	2.0.0-20200131-090330
VBScript	2.0.0-20200205-180309
Wait	2.0.0-20200131-090335
Window	2.0.0-20200131-090337
XML	2.0.0-20200131-090339

Changed features
<p>Updated layout for the summary report generated by Bot Scanner</p> <p>The layout of the summary report is updated to provide information about the number of bots scanned, and the commands and variables used in the scanned bots that are supported in Enterprise A2019.</p> <p><a href="#">Analyze Bot Scanner report for migration</a> on page 1534</p>
<p>Python script and VBScript packages return output without quotation marks</p> <p>The actions in the Python script and VBScript packages now return output without any quotation marks. For example, if the action previously returned "ABC" as the output, now the action returns only ABC.</p>
<p>Use Microsoft SQL Server address as alias for database</p> <p>Service Cloud case ID: 00401484</p> <p>The Control Room now supports using a Microsoft SQL Server address as alias for a database during installation.</p> <p><a href="#">Automation 360: Steps to change database server post Control Room installation (A-People login required)</a></p>

## Fixed features

Service Cloud case ID	Description
00463210	In a virtual machine using Remote Desktop Protocol, the <b>Keystrokes</b> action now functions properly without prompting a special characters error.
00455359, 00466407, 00475122	When the Control Room is used in Google Chrome, renaming a folder in the <b>My bots</b> section no longer causes the browser to crash.
00440659	In the <b>Data Table</b> package, the <b>Create folders/files if it doesn't exist</b> option in the <b>Write to file</b> action now functions properly and does not create a file when the option is not selected.



Service Cloud case ID	Description
00377861, 00466104	When you install Enterprise A2019 On-Premises with Amazon Relation Database Service (RDS) and there is no internet connectivity, the installation now completes successfully.
00472738, 00496476	In the Control Room, the bot now runs successfully without prompting an interactive bot error message in any circumstance.
00472655	In the Loop action, selecting the <b>Cell range</b> in the <b>Loop through</b> option now functions properly with the <b>For each row in worksheet</b> in the <b>Iterator</b> option.
00475040	When a bot is developed in Google Chrome, the pause and resume options now function correctly.
00445671	The time taken to connect to the Control Room is now less than 2 minutes after you restart the Control Room services.
00421864	You can now configure your Bot Agent using the Google Chrome browser. The following error message is no longer displayed: Please use Chrome to configure your bot agent.
00462095	Bot compilation time has decreased, so it takes less time for the bot to run. Previously, some bots took up to 40 seconds in pre-processing mode.

## IQ Bot

The IQ Bot On-Premises version is available for this release with additional features or updates since the last release. This IQ Bot version supports all the features and functionality available in IQ Bot Version 6.5.2.

[IQ Bot feature comparison matrix](#)

Review the compatibility of the IQ Bot A2019 On-Premises version with the corresponding Automation Anywhere Control Room On-Premises version.

[Automation 360 IQ Bot version compatibility](#) on page 1010

New features
<p>IQ Bot On-Premises unified database</p> <p>IQ Bot Build 2545 On-Premises now supports a unified database. You have to run a migration script to migrate the databases of Builds 1089, 1598, and 2079 to Build 2545.</p> <p><a href="#">Run IQ Bot On-Premises database migration script</a> on page 1476</p>

---

**Note:** The version number in the IQ Bot installer is incorrect and will be fixed in the next release.

---

## Bot Insight A2019

New features
<p>New Bot Insight homepage</p> <p>The new homepage displays all the available dashboards in a single page and enables you to directly access the dashboard of your choice. The smart search functionality enables you to search for dashboards in the <b>Search</b> text field. The homepage also enables you to bookmark your favorite dashboards and to sort the dashboards based on the following parameters:</p> <ul style="list-style-type: none"><li>• <b>Dashboard Name</b></li><li>• <b>Type</b></li><li>• <b>Total Views</b></li><li>• <b>Last Refreshed</b></li></ul> <p><a href="#">Bot Insight dashboards</a> on page 3929</p>
<p>Operations dashboard</p> <p>View information about the bots that are deployed on different Bot Runner machines and their statistics based on the performance from the Bot Insight <b>Operations</b> dashboard. You can use this information to enhance productivity and take measures based on real-time information for RPA deployments.</p> <p>You can directly access the <b>Bots</b> and <b>Audit</b> dashboards from the hyperlinks in the <b>Operations</b> dashboard.</p> <p><a href="#">Operations dashboard</a> on page 3932</p>
<p>Transaction data</p> <p>View data that is aggregated and logged by the bots when they are deployed in the Bot Runner machines by using the <b>Transaction</b> data feature in the <b>Profile</b> menu. You can access this feature from the <b>Business</b> dashboard.</p> <p><a href="#">Business dashboard</a> on page 3935</p>
<p>Exporting data from widgets</p> <p>Export data that is generated by the various smart widgets to comma-separated value (CSV) files on your local drive from the <b>Custom Business</b> dashboard. The export file for all the widgets, except the <b>Data Table Chart</b> and the <b>US Map</b>, contains the following headers:</p> <ul style="list-style-type: none"><li>• Group</li><li>• Subgroup</li><li>• Metric</li><li>• Volume</li></ul> <p>The <b>Data Table Chart</b> export file contains all the headers that are present in the <b>Data Table Chart</b>. The <b>US Map</b> export file contains the state codes, metric values, and the volume headers.</p> <p><a href="#">Exporting data from a dashboard widget</a> on page 3956</p>

**New features**

Visualization updates

Customize the widgets on the Bot Insight dashboards to gain insights for specific scenarios. The following widgets are added to Bot Insight:

- **Heat Map**
- **Data Table Chart**

[Bot Insight visualizations](#) on page 3952

## Known limitations

Using the Universal Recorder in Oracle EBS applications:

- The **Select item by text** action does not retrieve the value of a selected **ListView** object.

Workaround: Manually enter the item value after capturing the object control or use the **Select item by index** action.

---

**Note:** Item index count starts at 1.

- At runtime, the **Select item by text** and **Select item by index** actions do not appear to select the item specified in a **PageTab** object, but the bot successfully executes the action.
- At runtime, the **Select item by text** and **Select item by index** actions do not appear to select the item specified in a **ComboBox** object, but the bot successfully executes the action.

In Enterprise A2019 On-Premises, the following activities are currently not logged in the workload logs:

- Create a queue
- Create a device pool
- Create a bot
- Run a bot with a queue

You can access the logs from the C:\ProgramData\AutomationAnywhere\Logs folder.

Related information

<https://www.automationanywhere.com/in/lp/rpa-editions-comparison>

## Enterprise A2019 (Build 2094) Release Notes

These release notes describe new features, changed features, fixed features, security fixes, deprecated features, and known limitations in Enterprise A2019 (Build 2094).

To verify which version is compatible with this release, see [Compatibility with release builds](#) on page 1333.

## Enterprise A2019 Build 2094

Build 2094 contains updates for the following:

- [Enterprise Community Edition](#)
- [Bot Insight A2019](#)
- [IQ Bot A2019](#)
- [On-Premises](#) (Build 2079)

## New features in Build 2094

Feature	Description
Migration	<p>Migrate Enterprise 11.3.x Task Bots to Enterprise A2019.</p> <ul style="list-style-type: none"> <li>• Run the Bot Scanner (previously called the pre-migration utility) to analyze if your Enterprise 11.x bot (currently only 11.3.1, 11.3.2, and 11.3.2.x versions are supported) can be migrated to Enterprise A2019. The utility generates a summary report in HTML format and a separate report for each bot in XML format. <a href="#">Bot Scanner for migration</a> on page 1529</li> <li>• Migrate multiple Task Bots with dependent Task Bots using a single Run-as user. <a href="#">Migrate Enterprise bots</a> on page 1590</li> <li>• As part of the bot migration process, you can identify previously migrated Task Bots on the bot selection page and preview a list of the dependent Task Bots before finalizing the migration. <a href="#">Migrate Enterprise bots</a> on page 1590</li> <li>• Analyze the status of individual bot migrations and identify any unsupported commands or attributes associated with the migrated bot and its dependencies. <a href="#">View migration reports</a> on page 1675</li> <li>• Additional support is provided for packages and variables. <a href="#">Package mapping for migration</a> on page 1620</li> </ul>
SAML 2.0	<p>Switch an authenticated environment Control Room database to a SAML identity provider (IDP). <a href="#">Set up SAML authentication</a> on page 1390</p>

Feature	Description
Bot Deploy API	<p>The Bot Deploy API now includes / automations/deplo y and is introduced to support the runAs user feature for Bot deployment.</p> <ul style="list-style-type: none"> <li>• The Bot Deploy API works only in Enterprise public accounts, and not in Community Edition.</li> <li>• The API supports callback URL for environments that have both the Control Room and callback server on the same network.</li> </ul>
Geo Presence	<p>The Geo Presence feature is a multi-tenant, secure, scalable, Cloud Control Room enhancement to securely communicate with users and Bot Runners over a customer network.</p>
Exchange Web Services support	<p>Actions in the Email package enable users to automate email-related operations using Exchange Web Services#(EWS).</p> <p><a href="#">Email package</a> on page 2517</p>
Variables in place of an index or key value	<p>Data table, dictionary, list, and record type variables can express index and key values as variables.</p> <p><a href="#">Variable types</a> on page 2333</p>
Copy bot	<p>The copy bot functionality retains the metadata of the original bot, including captured images, recorded objects, called files, and child bots.</p> <p><a href="#">Copy a bot</a> on page 2311</p>
Excel actions to retrieve cell, column, or row location	<p>The following actions enable users to retrieve location information from an Excel sheet and save it to a variable.</p> <ul style="list-style-type: none"> <li>• <a href="#">Get cell address</a></li> <li>• <a href="#">Get column</a></li> <li>• <a href="#">Get row</a></li> </ul>
Recorder enhancements	<p>Users can discard the most recently captured object while the Recorder is running.</p>

## Supported packages

Package	Version
Node Manager	1.0.1891
Application	2.0.0-20191223-210256
Boolean	2.0.0-20191223-210258
Browser	2.0.0-20191223-210259
Clipboard	2.0.0-20191223-210308
Comment	2.0.0-20191223-210309
CSV/TXT	2.0.0-20191223-210310
Database	2.0.0-20191223-210312
DataTable	2.0.0-20191223-210802
DateTime	2.0.0-20191223-210316
Delay	2.1.0-20191223-210318
Dictionary	2.0.0-20191223-210318
DLL	2.0.0-20191223-210742
Email	2.0.0-20200114-060001
Error Handler	2.0.0-20191223-210326
Excel	2.0.0-20200107-140225
Excel_MS	2.0.0-20200107-140116
File	2.0.0-20200114-060009
Folder	2.0.0-20200114-060012
FTP/SFTP	2.0.0-20191223-210334
If/Else	2.0.0-20191223-210336
IR	2.0.0-20191223-210339
IQ Bot	2.0.0-20191031-150538
JavaScript	2.0.0-20191223-210345
Keystrokes	2.0.0-20191223-210348
List	2.0.0-20191223-210350
LogToFile	2.0.0-20191223-210350
Loop	2.0.0-20191223-210352
MessageBox	2.0.0-20191223-210352
Migration	1.1.0-20200111-070201
Mouse	2.0.0-20191223-210355

Package	Version
Number	2.0.0-20191223-210402
OCR	2.1.0-20191223-210525
Office 365 Excel	2.0.0-20191231-170605
Office 365 Calendar	2.0.0-20191231-170422
Office 365 OneDrive	2.0.0-20191231-170612
PDF	2.1.0-20191223-210631
PGP	2.1.0-20191223-190649
Ping	2.0.0-20191223-210634
PlaySound	2.0.0-20191223-210636
Prompt	2.0.0-20191231-130717
Python	2.0.0-20191223-210644
Recorder	2.0.1-20200111-070529
Rest	2.0.0-20191231-120639
SAP	2.1.0-20191223-210745
Screen	2.0.0-20191223-210748
SNMP	2.0.0-20191223-210752
SOAP	2.0.0-20191210-081952
String	2.0.0-20200114-110316
System	2.0.0-20191223-210800
Terminal Emulator	2.0.0-20191223-210806
VBScript	2.0.0-20191223-210809
Wait	2.0.0-20191223-210812
Window	2.0.0-20191223-210814
XML	2.0.0-20191223-210815

## Changed features

Feature	Description
Office 365 packages authorization	<p>Authorize each Office 365 package separately through the <b>Connect</b> package in each package.</p> <p><a href="#">Using Connect action in Microsoft 365 Calendar package on page 2814</a></p>

## Fixed features

Feature	Description
Bot Agent	In the Control Room, upgrading to the latest Bot Agent version now successfully executes the bot without any prompted error messages. See <a href="#">Switch Bot Agent to a different Control Room</a> on page 1350.
Excel advanced package	In the <b>Excel advanced</b> package, the <b>Close</b> action now terminates only a specific open session as defined by the <b>session name</b> .
Keystrokes	The <b>Keystrokes</b> command now functions properly with the Japanese keyboard layout.

## Security fixes

The security fixes in this release have not changed since the previous release. For a list of these fixes, see [Enterprise A2019 \(Builds 1598 and 1610\) Release Notes](#) on page 730.

## Deprecated features

The deprecated features in this release have not changed since the previous release. For a list of these deprecations, see [Enterprise A2019 \(Builds 1598 and 1610\) Release Notes](#) on page 730.

## Known limitations in Build 2094

### Migration

- When selecting a bot for migration, values for the **Last Migrated** and **Migrated By** columns might differ for the same bot in the **Available Files** and **Selected** tables.
- The "System" value in the **Migrated By** column indicates that the bot has not been migrated previously.
- When viewing commands and variables associated with each migrated bot, you should only see the unsupported commands and variables. Currently, all commands and variables are shown.

## IQ Bot Build 2079

IQ Bot On-Premises version is available for this release with no additional features or updates since the last release. This version is based on IQ Bot Version 6.5.2 feature and functionality.

[IQ Bot feature comparison matrix](#)

IQ Bot On-Premises version is compatible with the corresponding Automation Anywhere Control Room On-Premises version.



[Automation 360 IQ Bot version compatibility](#) on page 1010

For a fresh Control Room installation, the user has to upload the IQ Bot package manually. See [Add packages to the Control Room](#) on page 1908 for details.

Go to Automation Anywhere support site to download the package:

[A-People Downloads page \(Login required\)](#).

### **IQ Bot fixed features**

The fixed features in this release have not changed since the previous release.

### **IQ Bot security fixes**

The security fixes in this release have not changed since the previous release.

### **IQ Bot deprecated features**

The deprecated features in this release have not changed since the previous release.

### **IQ Bot known limitations**

There are no new known limitations in this release.

### **Bot Insight new features in Build 2094**

Feature	Description
Visualizations	The <b>Visualization</b> widget in the Bot Insight dashboard provides a host of highly customizable widgets that you can use to gain insights on specific scenarios. Vertical and horizontal <b>Clustered</b> and <b>Stacked</b> bars are added. <a href="#">Adding a dashboard widget</a> on page 3951

### **Bot Insight changed features**

The changed features in this release have not changed since the previous release.

### **Bot Insight fixed features**

The fixed features in this release have not changed since the previous release.

## Bot Insight deprecated features

The deprecated features in this release have not changed since the previous release.

## Bot Insight known limitations

The known limitations in this release have not changed since the previous release.

## Enterprise A2019 (Builds 1598 and 1610) Release Notes

These release notes describe new features, changed features, fixed features, security fixes, deprecated features, and known limitations in Enterprise A2019 (Builds 1598 and 1610).

To verify which version is compatible with this release, see [Compatibility with release builds](#) on page 1333.

## Enterprise A2019 Builds 1598 and 1610

Build 1598 contains updates for the following:

- [Enterprise Community Edition](#)
- [Bot Insight](#)
- [IQ Bot](#)

Build 1610 contains updates for the following:

- [On-Premises](#)
- [Bot Insight](#)
- [IQ Bot](#)

## New features in Builds 1598 and 1610

Feature	Description
Pre-migration utility for On-Premises	<p>The Automation Anywhere pre-migration utility evaluates your 11.x bots for migration to Enterprise A2019.</p> <p>Run the pre-migration utility to verify whether your existing 11.x bots can be migrated to Enterprise A2019. Use the summary report generated by the utility to identify the bots that can and cannot be migrated and decide if you want to start the migration.</p> <hr/> <p><b>Note:</b> This is an initial version of the pre-migration utility. We plan to include updates to the utility in upcoming releases to help migrate most of your bots.</p>
On-Premises Windows installer	Enterprise A2019 On-Premises Windows installer is certified for Azure.
Bot Creator and Bot Runner on Azure Cloud	Users can create and execute bots for devices on Azure Cloud.
Action localization	Labels, buttons, and tooltips are localized to the supported language set.
Updated action packages	<ul style="list-style-type: none"> <li>• Additional REST Web Service error codes for better troubleshooting of API calls</li> <li>• PGP package for encrypting and decrypting files</li> <li>• Improvements to SAP actions</li> </ul>
Control Room to a SAML-based, SSO-authenticated Control Room	Enterprise A2019 integrates with SAML identity providers (IDPs). Post installation, administrators can switch the Control Room to a SAML-based, SSO-authenticated Control Room.
Move email messages to different folder	The Move message command enables the user to move all the filter-matched emails to a different folder.

## Supported packages

Package	Version
Node Manager	1.0.2110
Application	2.0.0-20191128-060339
Boolean	2.0.0-20191128-060340

Package	Version
Browser	2.0.0-20191128-060342
Clipboard	2.0.0-20191128-060350
Comment	2.0.0-20191128-060351
CSV/TXT	2.0.0-20191128-060352
Database	2.0.0-20191128-060354
DataTable	2.0.0-20191128-060707
DateTime	2.0.0-20191128-060358
Delay	2.1.0-20191128-060359
Dictionary	2.0.0-20191128-060400
DLL	2.0.0-20191128-060648
Email	2.0.0-20191205-100336
Error Handler	2.0.0-20191128-060404
Excel	2.0.0-20191128-060547
Excel_MS	2.0.0-20191128-060434
File	2.0.0-20191128-060407
Folder	2.0.0-20191128-060409
FTP/SFTP	2.0.0-20191128-060412
If/Else	2.0.0-20191128-060414
IR	2.0.0-20191121-100240
IQ Bot	2.0.0-20191031-150538
JavaScript	2.0.0-20191128-060423
Keystrokes	2.0.0-20191128-060426
List	2.0.0-20191128-060427
LogToFile	2.0.0-20191128-060428
Loop	2.0.0-20191128-060429
MessageBox	2.0.0-20191128-060429
Mouse	2.0.0-20191128-060430
Number	2.0.0-20191128-060437
OCR	2.1.0-20191121-100301
PDF	2.1.0-20191128-060540
PGP	2.1.0-20191129-100500
Ping	2.0.0-20191128-060544
PlaySound	2.0.0-20191128-060545

Package	Version
Prompt	2.0.0-20191128-150505
Python	2.0.0-20191128-060553
Recorder	1.0.45-20190904-210340
Rest	2.0.0-20191128-060646
SAP	2.1.0-20191128.003143-259
Screen	2.0.0-20191121-100518
SNMP	2.0.0-20191128-060656
String	2.0.0-20191128-060704
System	2.0.0-20191128-150557
Terminal Emulator	2.0.0-20191128-060711
VBScript	2.0.0-20191121-110553
Wait	2.0.0-20191128-060716
Window	2.0.0-20191128-060718
XML	2.0.0-20191017-030831

## Fixed features

The fixed features in this release have not changed since the previous release. For a list of these features, see [Enterprise A2019 \(Builds 1082 and 1089\) Release Notes](#) on page 736.

## Security fixes

The security fixes in this release have not changed since the previous release. For a list of these fixes, see [Enterprise A2019 \(Builds 1082 and 1089\) Release Notes](#) on page 736.

## Deprecated features

The deprecated features in this release have not changed since the previous release. For a list of these deprecations, see [Enterprise A2019 \(Builds 1082 and 1089\) Release Notes](#) on page 736.

## Known limitations in Builds 1598 and 1610

- IQ Bot is not supported in Automation Anywhere Cloud and users cannot register any IQ Bot instance with the Cloud Control Room.
- If a bot is deployed on a device, no other bots can be deployed on that device until the first bot has completed the deployed task.

- When deploying a bot using Unattended Bot Runner on a virtual machine with Windows 10 desktop, users have to enable remote access to the device (**Control Panel > System Properties > Allow Remote Access**).
- Deploying a bot with Bot Runner on a locked device will leave that device in an unlocked state.
- A Bot Creator is not able to view devices as assigned by the Control Room administrator. With this release, changes to the basic role has removed the **View and manage all devices** permission so that unless this permission is expressly granted by the Control Room administrator, the Bot Creator will no longer be able to see other devices in the Control Room. Bot Creators can register their devices directly; however, they will not be able to see the other devices in the Control Room.
- Unable to deploy bots from a private workspace using the wizard. Bot Creators can deploy bots from the editor.
- If users have set up Active Directory for Control Room authentication, changing to SAML or Control Room Database is not supported.
- Device pool administrators can delete a device pool after automation is scheduled and assigned to the pool.
- Users without SMTP can still import bots and packages.
- When users delete a bot from the Public workspace, the same bot is deleted from the Private workspace as well.
- Elastic Search Disaster Recovery backup is not supported.
- Using the Run Task action with the child task using triggers is not supported.
- User cannot export a bot with dependencies if that user does not have access to any of the related dependencies.
- Users cannot check out bots if they are linked through circular dependencies.
- Minimizing the window for some Microsoft Active Accessibility apps, such as Notepad, Calculator, or Remote Desktop Applications, can cause the operation to fail.
- UI Automation, such as Snagit Editor Window for example, will not work in the background unless expressly minimized.
- UI Triggers are not generating events with Snagit Editor or Inflow app.
- Applications such as calculator use different technologies on Windows 10 vs. Windows 2012 or other servers. In these cases, when a bot is created in one server configuration, the bot cannot be carried to another server. User triggers in these cases will not trigger bot deployment and there are no errors in the trigger listener or node manager logs.
- UI Triggers that are configured with multiple triggers are taking as much as 25 seconds to complete.
- UI Triggers with a single capture and a filter do not work with files larger than 2 MB.
- Button events where a user is switched from one window to a new window of an application fail to deploy a bot when listening for UI Triggers.
- For Automation Anywhere Elastic Search Service users, the `C:\ProgramData\AutomationAnywhere` folder has to be removed before installing Enterprise A2019.
- Users cannot enable SMTP with TLS for the On-Premises version of the Control Room (On-Premises only).
- User credentials are not editable (On-Premises only).
- Even when a newly added device is registered correctly, the indication icon does not turn green.
- **Activity - In Progress** table is not cleaning event records until the user performs a hard refresh (F5) of the browser.
- Domains are not shown for the **Device/Run as** tab when creating a role. This option is also missing when running a bot.

- Node manager is not able to establish a handshake SSL connection to the Control Room running on SSL certificate (On-Premises only).
- Repository Management API is incomplete; there is only one URL in the Swagger file.
- Device pools display completed automations, not scheduled automations.
- If a user is not the device pool administrator, the devices are not correctly displayed when editing a device pool.
- For an Unattended Bot Runner, with a device assigned and auto-login credentials set, and **Run as self** selected, the **Run now** option is disabled.
- When a user is running a bot from the Run Wizard and the Bot Agent requires an update, after the user has updated the agent from the pop-up box, the user cannot deploy the bot until the user navigates back to the previous page and returns to the workflow to run the wizard.
- Folder triggers do not deploy bots when a folder change event occurs.

## IQ Bot Builds 1598 and 1610

IQ Bot On-Premises version is available for this release with no additional features or updates since the last release.

## IQ Bot changed features

IQ Bot is compatible with A2019 Builds 1598 and 1610.

## IQ Bot fixed features

The fixed features in this release have not changed since the previous release.

## IQ Bot security fixes

The security fixes in this release have not changed since the previous release.

## IQ Bot deprecated features

The deprecated features in this release have not changed since the previous release.

## IQ Bot known limitations

There are no new known limitations in this release.

## Bot Insight new features in Builds 1598 and 1610

Feature	Description
<b>Operation</b> dashboard	<p>The <b>Operation</b> dashboard in Bot Insight displays the <b>Audit</b> dashboard.</p> <p>You can search for the dashboards using the <b>Search</b> text box. You can also customize the dashboards based on your requirements. Role-based access control and permissions are applied to the dashboards so that the dashboard shows data only a specific user is authorized to view.</p> <p>See <a href="#">Operations dashboard</a> on page 3932.</p>
Analytic visualization widgets	<p>The following new widgets are added:</p> <ul style="list-style-type: none"> <li>Stacked Bar Chart</li> <li>Clustered Bar Chart</li> </ul> <p>See <a href="#">Adding a dashboard widget</a> on page 3951.</p>

## Bot Insight changed features

The changed features in this release have not changed since the previous release.

## Bot Insight fixed features

The fixed features in this release have not changed since the previous release.

## Bot Insight deprecated features

The deprecated features in this release have not changed since the previous release.

## Bot Insight known limitations

The deprecated features in this release have not changed since the previous release.

## Enterprise A2019 (Builds 1082 and 1089) Release Notes

These release notes describe new features, changed features, fixed features, security fixes, deprecated features, and known limitations in Enterprise A2019.

To verify which version is compatible with this release, see [Compatibility with release builds](#) on page 1333.



## Enterprise A2019 Builds 1082 and 1089

Build 1082 contains updates for the following:

- [Enterprise Community Edition](#)
- [Bot Insight](#)

Build 1089 contains updates for the following:

- [On-Premises](#)
- [IQ Bot](#)
- [Bot Insight](#)

## New features in Builds 1082 and 1089

Feature	Description
Universal recorder support for SAP	The universal recorder now supports the SAP graphical interface for fast and accurate control and ease of editing generated scripts.
Citrix support	Citrix agent enables remote application recording for object cloning on Citrix servers and leverages ICA to create user sessions.
Enhanced code editing	Select multiple lines of code in editor to copy, move, disable, enable, as well as disable/enable a line of an action in a bot script.  Users can run bots from a particular line of code or action inside the bot.
Bot import and export	Users can export bots with dependencies into a common zip file, including all actions. Users can manually exclude packages from the export process.  All imported action packages will be automatically installed into the target Cloud Control Room and the bots placed inside the user private workspace.
Background processing	Background processing for Citrix Virtual Apps and Windows native applications. Excel packages inherently support background processes.
REST package	Support for GET, POST (text, XML, and HTML), PUT, and DELETE methods. Authentication types supported include Basic, Logged-in AD user, and NTLM.
OCR Action	Users can capture window and capture image by path.

Feature	Description
Active Directory integration for On-Premises	Allowing auto-discovery of sites and domains, Enterprise A2019 On-Premises integrates Active Directory to support multi-domain as well as multi-forest deployments.

## Supported packages

Package	Version
Node Manager	1.0.1745
Application	2.0.0-20191016.213334-22
Boolean	2.0.0-20191017-030403
Browser	2.0.0-20191017-030404
Clipboard	2.0.0-20191016.213334-16
Comment	2.0.0-20191017-030408
CSV/TXT	2.0.0-20191017-030409
Database	2.0.0-20191017-030411
DataTable	2.0.0-20191029.062940-3
DateTime	2.0.0-20191017-030416
Delay	2.1.0-20191017-030417
Dictionary	2.0.0-20191017-140648
DLL	2.0.0-20191031-100332
Email	2.0.0-20191024-120209
Error Handler	2.0.0-20191031-100110
Excel	2.0.0-20191024-160417
Excel_MS	2.0.0-20191101-120011
File	2.0.0-20191017-140654
Folder	2.0.0-20191017-140657
FTP/SFTP	2.0.0-20191023-181858
If/Else	2.0.0-20191017-030432
IR	1.0.0-20190923-115359
IQ Bot	2.0.0-20191031-150538
JavaScript	2.0.0-20191031-100128
Keystrokes	2.0.0-20191018-100419
List	2.0.0-20191017-030447

Package	Version
LogToFile	2.0.0-20191017-030447
Loop	2.0.0-20191017-030449
MessageBox	2.0.0-20191017-030449
Mouse	2.0.0-20191017-030450
Number	2.0.0-20191029-100152
OCR	2.1.0-20191017-030626
PDF	2.1.0-20191017-030713
Ping	2.0.0-20191017-030715
PlaySound	2.0.0-20191024-160415
Prompt	2.0.0-20191024-160423
Python	2.0.0-20191031-100238
Recorder	1.0.45-20190904-210340
Rest	2.0.0-20191024-090501
SAP	2.1.0-20191031-100334
Screen	2.0.0-20191017-030809
SNMP	2.0.0-20191023-181621
String	2.0.0-20191025-221016
Terminal Emulator	2.0.0-20191023-181907
VBScript	2.0.0-20191031-100352
Wait	2.0.0-20191017-030828
Window	2.0.0-20191017-030829
XML	2.0.0-20191017-030831

## Changed features

Changed features	
Task Bot	All rich features of MetaBot, such as DLL and code protection using execute permission, are now part of a standard TaskBot. This also includes inline scripting using Python, VBScripts, and more to help reduce the learning curve for new users and provides a uniform bot development experience.

## Fixed features

The fixed features in this release have not changed since the previous release. For a list of these features, see [Enterprise A2019 \(Build 550\) Release Notes](#) on page 744.

## Security fixes

The security fixes in this release have not changed since the previous release. For a list of these fixes, see [Enterprise A2019 \(Build 550\) Release Notes](#) on page 744.

## Deprecated features

The deprecated features in this release have not changed since the previous release. For a list of these deprecations, see [Enterprise A2019 \(Build 550\) Release Notes](#) on page 744.

## Known limitations in Builds 1082 and 1089

- IQ Bot is not supported in Automation Anywhere Cloud and users cannot register any IQ Bot instance with Cloud Control Room.
- To create database tables in Cloud Control Room where internet access is restricted and deploying Liquibase, users are required to unblock the Java process to connect to [www.liquibase.org](http://www.liquibase.org) in order to download the schema and allow java.exe to have internet access.
- The Folder trigger has the following event options: create, modify, and delete. The File trigger only has the modify and delete event options.
- A bot cannot have duplicate Triggers that point to the same directory.
- Using the action Run Task with the child task using triggers is not supported.
- Activity - In Progress is not cleaning the event record until user does hard refresh (F5) of the browser.
- User cannot export a bot with dependencies if that user does not have access to any of the related dependencies.
- Users cannot checkout bots if they are linked via circular dependencies.
- Minimizing the window for some Microsoft Active Accessibility apps, such as Notepad, Calculator, or Remote Desktop Applications, can cause the operation to fail.
- UI Automation, such as Snagit Editor Window for example, will not work in the background unless expressly minimized.
- If the system Citrix plugin is not updated, the Recorder will not launch.
- If the user renames a previously saved recorder bot, a download error is generated and results in loss of images.
- For Elasticsearch users, remove the C:\ProgramData\AutomationAnywhere folder prior to installing Enterprise A2019.
- Users cannot enable SMTP with TLS for the on-premises version of the Control Room (On-Premises only).
- User credentials are not editable (On-Premises only).
- Installer fails to create credentials using Windows Authentication. Use SQL Authentication service credentials (On-Premises only).

- In an On-Premises environment, creating credentials with the Credential Vault is not supported in this release.
- When using the Recorder with Citrix in an On-Premises deployment, the Citrix Agent could generate an internal server error during the recording process.

## **IQ Bot Builds 1082 and 1089**

IQ Bot Community Edition is available for this release. IQ Bot is not yet available on Automation Anywhere Cloud.

See [IQ Bot Community Edition quick start guide](#) .

## **IQ Bot changed features**

IQ Bot is compatible with Enterprise A2019 Build 1089.

## **IQ Bot fixed features**

The fixed features in this release have not changed since the previous release.

## **IQ Bot security fixes**

The security fixes in this release have not changed since the previous release.

## **IQ Bot deprecated features**

The deprecated features in this release have not changed since the previous release.

## **IQ Bot known limitations**

For On-Premises, if IQ Bot and Control Room are installed on the same machine, on restarting the machine, IQ Bot does not work, and displays an error message.

---

**Note:** We recommend restarting Automation Anywhere Control Room Reverse Proxy service to resolve the issue.

---

## Bot Insight new features in Builds 1082 and 1089

Feature	Description
Smart data profiling for country, state, and zip codes	<p>Bot Insight analyzes information provided in the variables to automatically identify information based on the country, state, and zip or postal code. You can use this information to create the <b>World</b> and <b>US Map</b> widgets.</p> <p>See <a href="#">Editing a data profile</a> on page 3941.</p>
Business data delete API	<p>Use this API to delete logged data from either the production mode or the development mode for a particular Control Room instance.</p> <pre>DELETE &lt;control_room_url&gt;/v2/botinsight/data/api/deletetasklogdata.</pre>
Business data profile API	<p>Use this API to extract the business data profile logged in Bot Insight.</p> <pre>GET &lt;control_room_URL&gt;/v2/botinsight/data/api/gettaskvariableprofile</pre>
Business data API	<p>Use this API to extract the business data logged in Bot Insight.</p> <pre>GET https://{ControlRoomURL}/v2/botinsight/data/api/gettasklogdata?botname=&lt;botname&gt;</pre>
Resize dashboard widgets	<p>You can resize and save the widgets in the Bot Insight dashboard based on your requirements. When you resize a dashboard widget, other widgets in the dashboard are automatically adjusted to fill in the available layout.</p> <p>See <a href="#">Editing a dashboard widget</a> on page 3954.</p>
US map widget	<p>The <b>US Map</b> widget enables you to visualize and analyze information about Country, State, City, and Zip Code.</p> <p>See <a href="#">Adding a dashboard widget</a> on page 3951.</p>

Feature	Description
World map widget	The <b>World Map</b> widget enables you to visualize and analyze information about Country, State, Zip Code, Latitude, and Longitude.  See <a href="#">Adding a dashboard widget</a> on page 3951.
Parent child dashboard	When you create a new bot, Bot Insight automatically creates a default dashboard. If you have a parent bot and a child bot, Bot Insight creates a separate dashboard for each of the bots.  See <a href="#">Bot Insight dashboards</a> on page 3929.
Notification of variable updates in the standard dashboard	Data profile updates are highlighted with a red dot in the standard dashboard.  See <a href="#">Customizing a dashboard</a> on page 3945.
Data logging	When you deploy and run a bot on the Bot Runner machine, Bot Insight aggregates all the information about that bot. The published dashboard for that bot displays the aggregated bot information.  See <a href="#">Bot Insight dashboards</a> on page 3929.
Bot Insight	The <b>Analyze</b> package provides the following functions to enable business analytics in the Bot Insight dashboard: <ul style="list-style-type: none"> <li>• <b>Analyze Open</b></li> <li>• <b>Analyze Close</b></li> </ul>

### Bot Insight changed features

The changed features in this release have not changed since the previous release.

### Bot Insight fixed features

The fixed features in this release have not changed since the previous release.

### Bot Insight deprecated features

The deprecated features in this release have not changed since the previous release.

## Bot Insight known limitations

The known limitations in this release have not changed since the previous release.

## Enterprise A2019 (Build 550) Release Notes

These release notes describe new features, changed features, fixed features, security fixes, deprecated features, and known limitations in Enterprise A2019 (Build 550).

### New features in A2019 Build 550

Feature	Description
On-premises installer	The on-premises installation application for Enterprise A2019.
IQ Bot supports IE11	IQ Bot (Build 550) supports Internet Explorer version 11 (IE11).
<b>Download all documents</b> action	Use the <b>Download all documents</b> action to download the extracted results from an IQ Bot server that was created by running a Task Bot, using the <b>Upload Document</b> action.

### Supported packages in Build 550

The supported packages in this release have not changed since the previous release. For a list of these packages, see [Enterprise A2019 \(Build 543\) Release Notes](#) on page 745.

### Changed features

IQ Bot (Build 550) Changed Features	
Issue	Description
Language toggle UI redesigned	<p>On the IQ Bot landing page, user can click the language toggle at the top right corner, to select a language from the drop-down list. The UI displays in the selected language.</p> <p>User can select a language from either the Control Room or IQ Bot language toggle icon.</p> <hr/> <p><b>Note:</b> After logging out of the system, the system performs a reset. This requires the user to select the language again at login.</p> <hr/>



IQ Bot (Build 550) Changed Features	
Issue	Description
<b>Upload document</b> action	The <b>Upload document</b> action lets you to upload documents for processing with IQ Bot, using a Task Bot.

## Fixed features

IQ Bot (Build 550) fixed features:

- Japanese documents using Microsoft Azure Computer Vision OCR engine get classified correctly.
- In the Designer window, during document training, user is able to move from one page to the other successfully along with mapping of form and table fields.
- Download API can download successfully processed documents after moving the bot and learning instance to production.

## Security fixes

No security features are introduced in this build.

## Deprecated features

No deprecated features are introduced in this build.

## Known limitations

IQ Bot (Build 550) known limitations:

- When using Internet Explorer (IE) 11, icons disappear after a page refresh. A hard refresh (Ctrl plus F5) helps fix the issue.
- When using Internet Explorer (IE) 11, if user imports a domain, the system shows an error message. However, the feature works as expected.
- User is unable to migrate IQBA files from other versions of IQ Bot.
- IQ Bot portal does not launch after a machine restart. User has to restart Automation Anywhere Control Room Reverse Proxy Service as well.

## Enterprise A2019 (Build 543) Release Notes

These release notes describe new features, changed features, fixed features, security fixes, deprecated features, and known limitations in Enterprise A2019 (Build 543).

To verify which version is compatible with this release, see [Compatibility with release builds](#) on page 1333.

## New features in A2019 Build 543

Feature	Description
Next generation bot workbench	<p>Create bots from any device, from anywhere through a web browser. The intuitive new design for applying multiple personas with varying bot building skills and a redesigned work area for simple assembly and deployment. These include:</p> <ul style="list-style-type: none"> <li>• A universal recorder to simplify capturing processes</li> <li>• <b>List</b> and <b>Flow</b> views for Task Bot creation</li> <li>• Powerful bot code management capabilities</li> <li>• Rich variable passing with no cross-language mapping required</li> </ul>
Bot Runner	Access and run bots from the cloud. When bots are deployed to Bot Runners, any dependent actions are also deployed. When updates to Actions are available, the updates are also automatically pushed.
Package manager	The package manager centralizes control over bundled actions to enable users to deploy and upgrade only those targeted actions being used.
Advanced variable types	Access expanded variables and array types for enhanced action implementation, including DateTime, numbers, list, Boolean, dictionary, multi-dimension arrays for reading Microsoft Excel documents, and file data column for .CSV files.
Inline scripting	Native support for Python and VBScript inline scripting languages enables simple data passing between scripts and bots.
New UX	The new user experience provides assistance for users who are getting started and includes step-by-step guidance for common tasks.
Excel automation	Configure Microsoft Excel Task Bot automation without installing Microsoft Office on the Bot Runner machine.
Recording of automation	Record automation, even from a remote device.
IQ Bot	Enterprise A2019 will fully support IQ Bot, the only AI-driven solution for users to automate processing of complex documents.

Feature	Description
Bot Insight	<p>The <b>Analyze</b> package provides the following functions to enable business analytics in the Bot Insight dashboard:</p> <ul style="list-style-type: none"> <li>• <b>Analyze Open</b></li> <li>• <b>Analyze Close</b></li> </ul>

Table 1: Supported packages in Build 543

Package	Version
Node Manager	1.0.1221
Application	1.0.0-20190919.040305-1231
Boolean	1.0.0-20190919.040305-1435
Browser	1.0.0-20190919.040305-1287
Clipboard	1.1.0-20190919.040305-1492
Comment	1.0.0-20190919.040305-633
CSV/TXT	1.2.0-20190919.040305-1349
Database	1.1.0-20190919.040305-1287
DateTime	1.0.0-20190919.040305-1189
Delay	1.1.0-20190919.040305-1492
Dictionary	1.0.0-20190919.040305-1337
DLL	1.0.0-20190920.070246-677
Email	1.0.0-20190919.040305
Error Handler	1.0.0-20190919.040305-1333
Excel	1.1.0-20190921.042722-1353
Excel_MS	1.0.0-20190921.042722-1309
File	1.0.0-20190919.040305-1382
Folder	1.0.0-20190919.040305-1337
FTP/SFTP	1.0.0-20190919.040305-660
If/Else	1.0.0-20190919.040305-1375
IR	1.0.0-20190923.062209-1140
IQ Bot	2.0.0-20191031-150538
JavaScript	1.0.1-20190919.040305-989
Keystroke	1.1.0-20190919.040305-1492
List	1.0.0-20190919.040305-1466

---

Package	Version
Log to File	1.1.0-20190919.040305-1456
Loop	1.0.0-20190919.040305-1466
Message Box	1.1.0-20190919.040305-1492
Mouse	1.1.0-20190919.040305-1492
Number	1.0.0-20190919.040305-1148
PDF	1.1.0-20190919.040305-1492
Ping	1.0.0-20190919.040305-1319
PlaySound	1.0.0-20190919.054049-118
Prompt	1.1.0-20190919.040305-1180
Python	1.0.3-20190919.040305-1287
Recorder	1.0.45-20190904.153347-191
RunTask	1.1.0-20190701.181500-763
SAP	1.1.0-20190923.152217-493
Screen	1.0.0-20190919.040305-1105
SNMP	1.0.0-20190919.040305-359
Step	1.0.0-20190701.181442-695
String	1.1.0-20190919.040305-1469
Table	1.0.0-20190919.040305-719
VBScript	1.0.1-20190919.040305-1334
Wait	1.0.0-20190919.040305-1287
Window	1.0.0-20190919.040305-1333
XML	1.0.0-20190919.040305-717

### Changed features

This build does not include any changed features.

### Fixed features

No fixed features are introduced in this build.

### Security fixes

No security fixes are introduced in this build.

## Deprecated features

No deprecated features are introduced in this build.

## Known limitations

Feature	Limitation description
Recorder	.NET Framework 4.6.1 is required for the Recorder package.
Bot agent	Users of build 543 are required to download and install the latest agent.
Bot Insight	<p>Bot Insight has the following limitations:</p> <ul style="list-style-type: none"> <li>• Bot Insight dashboard does not support Drag and Drop to move and arrange the dashboard widgets within the dashboard.</li> <li>• The <b>Date</b> widget in the dashboard displays the Unix time stamp.</li> <li>• Bot Insight does not support the <b>Aggregate By</b> feature in the <b>Table</b> widget, if the table contains a <b>Timestamp</b>.</li> <li>• Once the bots run successfully, the default dashboard is generated after 5 to 10 seconds.</li> </ul>

## Community Edition Release Notes

Review the new capabilities in different Automation 360 Community Edition releases.

### Important:

The following products are renamed:

- AARI is called Automation Co-Pilot, and RPA Workspace is called Automation Workspace from Automation 360 v.28 release. Although release notes earlier than v.28 will show the new name, the content in these release notes is applicable and relevant to AARI and RPA Workspace.
- Enterprise A2019 is now called Automation 360. Although the release notes for releases earlier than Automation 360 v.21 release reference the old product name, the content in these release notes is applicable and relevant to Automation 360.

**Note:** For information about Automation 360 v.24R2 patch for Community Edition, see [Automation 360 v.24R2 Release Notes for Internet Explorer 11 EOL](#) on page 347.

Follow the links to view the release note updates for the respective release.

Related concepts

[Automation 360 Release Notes](#) on page 17

Review the new capabilities, changes, fixes (resolved issues), security fixes, deprecated features, and limitations in each release.

## Automation 360 v.31 Community Edition Release Notes

Release date: 6 December 2023

Review what's new in the Community Edition of the Automation 360 v.31 (Build 21023) release. Build 21023 replaces Build 20926.

**Note:** When a Bot Agent update is required, the Bot Agent is automatically updated to the compatible version.

For more information on updating to this release, see these resources:

- [Automatically update the Bot Agent](#) on page 1361 | [Manually update the Bot Agent](#) on page 1362
- [Compatibility with release builds](#) on page 1333

### Automation Workspace

What's new
<p>Improved usability of the Assistant utility</p> <p>The Bot editor, API editor, and the Template editor are now enhanced to remember the last position of the <b>Assistant</b> utility before you exit the editor. This improves the usability of the <b>Assistant</b> as you no longer have to move the <b>Assistant</b> to the right of the editor to view the Actions panel each time you open the bot within the editor.</p> <p><a href="#">Debugging your automations</a> on page 2353</p>
<p>Auto-purge of historical activities (Service Cloud case ID: 01255033, 01753613, 01764385, 01907781, 01951958, 02004210)</p> <p>Historical activities that are older than 30 days are automatically purged (deleted).</p>

### Automation Co-Pilot for Business Users

What's new
<p>Select a user group in a Process task in Process Composer</p> <p>As a Bot Creator or Citizen Developer, you can assign a user group based on role or team when creating a new Process task in Process Composer. If you do not designate a user group, the default user group will be used in the Process task.</p> <p><a href="#">Add Process Task to a process automation</a> on page 3462</p>

**What's new**

Move a process automation between folders in Process Composer

As a Bot Creator or Citizen Developer, you can move a new process automation from one folder to another within a private workspace.

[Move a process automation between folders](#) on page 3485

Assign custom roles with more granular permissions in Process Composer and Automation Co-Pilot

As an administrator, you can create custom roles with greater granular permissions to adhere to your organization's security directives and align with principles or least privileges. You are no longer required to use the system-defined roles provided by applications. You can create roles and assign permissions related to tasks, requests, and processes.

[Process Composer roles and permissions](#) on page 3421

Administrators can also customize roles to more specific functionality in Automation Co-Pilot (for example, Teams, extensions, and bots).

[Feature permissions for a role](#) on page 1749

All privileges granted to existing user-created roles persist, as expected. The new permission model continues to be based on product behavior. Permission options are simply offered across a broader scope to include product developments since the previous model.

**What's changed**

Improved image file upload

The experience has been improved for selecting and uploading a file to the image element when creating a form. Now the thumbnail of the image element is interactive, and users can click to open the file finder for selection or simply drag the file into the image element on the canvas. This improvement is in addition to the existing method of selecting files in the configuration panel.

Favorite automations are now persisted on the server side

Within Automation Co-Pilot (both Embedded and Assistant), automations selected as favorite will persist across browser sessions, to display as a filtered group for quick access when the user selects the **Show my favorites** check-box. When showing favorites, the automation list will default to display only selected favorites until the user clears the **Show my favorites** check-box. Previously, if cache was cleared or the user used a different browser, all favorite selections would need to be made again.

## Document Automation

What's new
<p>RegexExtract action in validation rules</p> <p>You can now use the <b>RegexExtract</b> action in validation rules for table and form fields. When a value is extracted from a document, this feature allows users to apply a regular expression (regex) to the extracted value to retrieve a specific substring. It extracts only the first match found in the value based on the regex pattern.</p> <p><a href="#">Validation rules in Document Automation</a> on page 3651   <a href="#">Using regex extract action in validation rule</a> on page 3655</p>

## IQ Bot

What's changed
<p>Deprecation of IQ Bot from Community Edition</p> <p>The IQ Bot is removed from Control Room for Community Edition users. The <b>Train other documents</b> button on the <b>Manage &gt; Learning Instances</b> tab is removed as part of this deprecation.</p> <p><a href="#">Document Automation Community Edition</a> on page 3724</p>

## Automation 360 v.30 Community Edition Release Notes

Release date: 21 September 2023

Review what's new in the Community Edition of the Automation 360 v.30 (Build 19678) release. Build 19678 replaces Build 19669.

We have released an updated build for a fix after the Automation 360 v.30 Community Edition Build 19669. For information about the fix in the updated build, see [Updated release builds](#) on page 753.

---

**Note:** When a Bot Agent update is required, the Bot Agent is automatically updated to the compatible version.

For more information on updating to this release, see these resources:

- [Automatically update the Bot Agent](#) on page 1361 | [Manually update the Bot Agent](#) on page 1362
  - [Compatibility with release builds](#) on page 1333
-



## Updated release builds

- We have released an updated Build 19688 that includes a fix for the Apache ActiveMQ remote code execution vulnerability. For more information, see [Apache ActiveMQ Remote Code Execution Vulnerability CVE-2023-46604 \(A-People login required\)](#).
- Fix for a checkout and export issue after updating bot with more meta data when folder name and bot names are similar.

(Service Cloud case ID: 02085658, 02086676, 02087581, 02087873, 02087885)

- We have released an updated Build 19669 which contains the following:
  - Fix for Automation Co-Pilot issue for not displaying process with external dependencies on bot in the process editor.

(Service Cloud case ID: 02087219, 02087722, 02087795, 02087354, 02087749, 02087942, 02087591, 02087593, 02088270, 02088622, 02088698)

- Fix for Automation Co-Pilot issue for not displaying process created from the learning instance in the process editor.

(Service Cloud case ID: 02087749, 02087795)

- Fix for Automation Co-Pilot issue for not being able to submit a request using a form with validation rules built-in.

(Service Cloud case ID: 02086037, 02087396)

## Automation Workspace

What's new
<p>Automation Command Center for Pro and Citizen Developers</p> <p>Automation Command Center (ACC) is now available for Pro and Citizen Developers. As a key component of automation lifecycle management, Pro and Citizen Developers now have a personalized and centralized view to quickly access their automations. Additionally, help is available with direct links to other developer resources, such as Pathfinder Community and Automation Anywhere University.</p> <p><a href="#">ACC home page for Pro and Citizen Developers</a> on page 2044</p>
<p>Packages displayed in sorted order in Bot editor</p> <p>When you use the actions menu (vertical ellipsis at the top-right) to select <b>Packages</b> in the Bot editor, packages now display in sorted order, making it easier to identify them. Packages are sorted on the <b>Name</b> field instead of the <b>Short name</b> field.</p>

**What's new**

Packages sorted alphabetically within Bot editor (Service Cloud case ID: 01766378)

For easier navigation, professional developers can quickly find packages and actions that are now sorted alphabetically at the following places in the Bot editor:

- Actions pane
- When you use the actions menu (vertical ellipsis at the top-right) to select **Packages**, the list of used and available packages displays alphabetically.
- When you use an **If**, **Else if**, **Loop**, or **Wait** for condition in a bot, the conditions and the iterators display alphabetically.

**New Legacy Loop behavior option**

For bots that were created using the Loop action in Automation 360 v.26 or earlier releases, you can now enable the **Legacy Loop behavior** option from the **Administration > Settings** to iterate the loop based on the specified value. When you enable this option and either increment or decrement the variable value in the end condition, loop iterations will not vary dynamically based on the new value generated.

[Settings](#) on page 1789

**Debug enhancements**

- To follow the standard Debug convention across different integrated development environments, the Debugger tool has been renamed to Debug.
- When you start debugging, in the Bot editor, you can now see a header bar below the bot name that displays the name of the bot being debugged. The header bar displays **Now debugging** and the bot name afterward. For example: **Now debugging: MSGBot5**
- When you start debugging a bot, the **Actions** panel on the left side of the Bot editor automatically collapses. This helps in providing more horizontal area to view the actions added in the Bot editor while debugging.

---

**Note:** Once the debugging stops, the **Actions** panel expands again.

---

**API Tasks for creating automations**

You can now create API Task automations in Automation 360 Cloud. API Tasks interact with an application directly via API. These API Tasks run on Cloud devices to provide better latency and faster processing time.

API Task is a new feature in v.30 and has limited availability in the United States (US East, US West, and US Sandbox) regions. To enable this feature, contact your customer support manager (CSM).

[#unique\\_158](#)

## Automation Co-Pilot for Business Users

### What's new

Ability to start a process using input variables in Process Composer

As a Pro developer, you can create and add input variables to start a process without having to build a form as the point of entry. You define input variables directly within the process itself which is particularly useful if your process requires complex variable types such as a dictionary, table, or list.

[Add input variables to a process automation](#) on page 3460

### What's changed

When local desktop automations are run from Automation Co-Pilot, the progress bar on the activity page now displays an accurate completed percentage for the executing automation. Previously, an indeterminate progress indicator was used.

Reference IDs available for all tasks

All tasks now have reference IDs that are visible in the URL which you can use to share the task with another user. The ID also allows users to access a task directly in a request, even if that task is already completed. Previously, only the last pending task of a request was accessible directly.

## Document Automation

### What's new

Custom data manipulation and validation through Document Extraction package (01936705)

The Document Extraction package now provides the **Get Document Data** and **Update Document Data** actions to allow customization of document fields. With the **Get Document Data** action, you can retrieve extracted data through a dictionary or JSON file, and use all the available packages to read values and customize them. After manipulating the extracted data, you can use the updated dictionary or JSON string (extracted values or coordinates) as input by using the **Update Document Data** action and update the documents on the server. This feature helps maximize straight-through processing (STP) and reduce manual verification efforts.

[Get document data action](#) on page 2512 | [Update document data action](#) on page 2513

Copy learning instance option added to Document Automation

Copy an existing learning instance to reuse the learning instance fields, parser information, document type, language, and local associations in the learning instance copy. Additionally, you can copy the heuristic feedback training and validation rules, as required.

[Create a learning instance in Document Automation](#) on page 3642

What's changed
<p>Create custom roles and permissions in Document Automation</p> <p>You are not required to use the system-defined administrator roles for Document Automation roles and permissions anymore. You can create custom roles with limited or no access to administrative permissions while adhering to your organization's security policies.</p> <p><a href="#">Document Automation users</a> on page 3638</p>
<p>Changes in IQ Bot Classifier package (01955258)</p> <p>The IQ Bot Classifier package has been enhanced to improve its usability:</p> <ul style="list-style-type: none"> <li>• The package name has been changed to Document Classifier package.</li> <li>• You can track consumption on the license administration page for processed documents in the Document Classifier package.</li> </ul> <p><a href="#">Document Classifier package updates</a> on page 899</p>

## Automation 360 v.29 Community Edition Release Notes

Release date: 6 June 2023

Review what's new in the Community Edition of the Automation 360 v.29 (Build 18361) release. Build 18361 replaces Build 18345.

**Note:** When a Bot Agent update is required, the Bot Agent is automatically updated to the compatible version.

For more information on updating to this release, see these resources:

- [Automatically update the Bot Agent](#) on page 1361 | [Manually update the Bot Agent](#) on page 1362
- [Compatibility with release builds](#) on page 1333

## Automation Workspace

What's new
<p>Introducing Help Center - In-app help used to search for automation information</p> <p>Help Center is a centralized location that contains all the information developers need to develop automations. Wherever you navigate to in the , the Help Center will show suggested topics related to the page you are on in the widget. Developers can leverage the suggested topics or search for specific , , or information they need help with. Additionally, the documentation link from contextual help loads the content directly within the Help Center. This feature eliminates the developer from having to switch back and forth between the and the documentation portal providing a distraction-free experience.</p> <p><a href="#">In-product user assistance</a> on page 1159</p>

**What's new**

Enhancement to the `ai_installer` (Service Cloud case ID: 01857405)

We have enhanced the `ai_installer` by including new `.exe` files for the **Bot launcher**, **Node manager**, **Triggers**, and **Child session launchers**. When you create and run a `bot` using `ai_installer` from the `ai_installer`, `ai_installer`, or `ai_installer`, and if your organization has configured security policies such as Document Security Solution (NASCA) DRM (Digital Rights Management), the files will be encrypted and secured by the security program.

The following changes occur in the installer when you:

- Install the `ai_installer`, `java.exe` will be replaced by `NodeManager.exe`.
- Run a `bot`, `javaw.exe` will be replaced by `BotLauncher.exe`.
- Configure a trigger, the trigger will be activated with `TriggerListener.exe` instead of `javaw.exe`.
- Run a `bot` with (AARI), `javaw.exe` will be replaced with `ChildSessionLauncher.exe`.

**Note:**

- If your `bot` or scripts use `java.exe` or `javaw.exe` in the `ai_installer` folder, we recommend that you modify your `bot` or scripts using the new `.exe` files.
- Ensure that the `ai_installer` version installed on your system is the version that is released with v.29.

[Install Bot Agent and register device](#) on page 1347

**Time filter for historical activities**

As a `user` with appropriate permissions, you can use the **Time filter** option to search for and view specific historical activities based on time duration. Additionally, you can customize the date and time to view these activities.

[Time filter](#) on page 2123

**Run `ai_installer` in elevated mode**

After updating to this release, an administrator can use the `A360Elevator.exe` application to run a `bot` in an elevated or administrative mode. This enables the `users` to run `bots` that might access any application that requires administrator credentials.

[Run a bot in elevated mode](#) on page 2285

**What's new**

## Change variable values while debugging

You can use the **Debugger** tool to edit the values of the following variable types added to the **Watched variables** list when you pause in debug mode during a run:

- Number
- String
- Boolean
- Datetime

This enables you to troubleshoot and fix any related errors, determine the correct value to use during execution, and resolve the issue without stopping the debugger.

**Note:**

- You cannot edit constant variables.
- Ensure that the version installed on your system is the version that was released with v.29.

Improved searchability for and files in subfolders (Service Cloud case ID: 01759969, 01838997, 01858215)

You can quickly search and locate , files, processes, and forms within a folder and its subfolders in public and the private workspaces even if your repository contains multiple folders and subfolders. To enable this enhanced search feature, select the **Include items within sub-folders** check box. A new column, **Folder path**, is displayed which contains the location of the folder and subfolders for the .

View references for non- file dependencies (Service Cloud case ID: 01793080)

You can view the references (immediate parents) for non- file dependencies such as: CSV, PDF, JPG, GIF, XLS, DOC, and PPT in public and private workspaces. You can use this feature to identify the , processes, or forms that refer to a non- file dependency. When you have many automations dependent on various file dependencies, it is easier to modify or delete the dependencies when you understand the impact of this change on the automations. You can efficiently check the effect of either modifying or deleting the dependency on the automations that refer to it.

Enhancement to the Bot Scanner utility

We have enhanced the utility and it now includes the option to scan that contain any of the and Triggers that use the EWS option.

[Scan bots for Basic authentication](#) on page 1134

## Document Automation

What's new
<p>Validate table data quicker using auto fill</p> <p>You can use the <b>Auto fill</b> button in the validation interface to extract hundreds of rows of data from multipage tables. After you manually validate three cells in a column, auto fill extracts the remaining values from that column in the document.</p>
<p>Improved heuristic feedback with form and table extraction</p> <p>provides an improved extraction through heuristic feedback with a focus on complex scenarios, such as multitable. Additionally, there are extraction improvements for both form fields and out-of-the-box performance (specifically for table fields).</p>
<p>Document-level data validation in</p> <p>With document-level data validation, you can create rules to ensure the accuracy of extracted data across multiple fields in your documents. You can define various conditions, such as pattern matching or equality checks. When those conditions are met, you can effortlessly take action to flag errors or warnings, clean up or replace values, or set new values.</p>

## Automation 360 v.28 Community Edition Release Notes

Release date: 22 March 2023

Review what's new in the Community Edition of the Automation 360 v.28 (Build 17566) release. Build 17566 replaces Build 17557.

**Important:** This release includes an optional Bot Agent update. You can continue to run your existing bots without updating the Bot Agent. However, if you want to use the new features in Automation 360 v.28, you must update the Bot Agent available with this release.

For more information on updating to this release, see these resources:

- [Automatically update the Bot Agent](#) on page 1361 | [Manually update the Bot Agent](#) on page 1362
- [Compatibility with release builds](#) on page 1333

## Automation Workspace

What's new
<p>Workday package</p> <p>You can use the new Workday package from Automation 360 to automate your Workday processes such as reporting, data upload/download, or triggering workflows with our new point-and-click experience. The package provides deep API-level integration with Workday that enables you to build automations easily, without having to code.</p> <p><a href="#">Workday package</a> on page 3162</p>
<p>Apigee package</p> <p>You can use the new Disconnect and Resume Integration features in the Apigee package. You can disconnect from your Apigee instance and clear the session using the Apigee Disconnect action. You can resume an integration that is suspended in Apigee using the Apigee Resume Integration action.</p> <p><a href="#">Apigee Disconnect</a> on page 2416   <a href="#">Apigee Resume Integration</a> on page 2421</p>
<p>Extended attributes supported in the Terminal Emulator Package (Service Cloud case ID: 01870633, 01928396, 01809815)</p> <p>The TN3270E terminal type supports extended attributes. To enable extended attributes for TN3270E terminals, select the <b>Extended Attribute</b> check box in the <b>Connect</b> action.</p>
<p>Enhanced error messages display errors from the child bots (Service Cloud case ID: 01264352)</p> <p>When you create a bot where the parent bot calls a child bot, and if an error occurs in the child bot, the error message provides the following details:</p> <ul style="list-style-type: none"> <li>• Line number of the parent bot which ran the child bot.</li> <li>• Line number of the child bot where the error occurred.</li> <li>• Error message details, such as what went wrong with that line number and the corresponding corrective action.</li> </ul> <p><a href="#">Using Bot editor</a> on page 2232</p>
<p>Timeout option in Database Connect action (Service Cloud case ID: 00753858)</p> <p>We added a timeout option in the <b>Connect</b> action of the Database Package. When you connect with Microsoft SQL Server to automate database-related tasks, and if the database is down or experiences any network issues, the automation will time out and fail if the database connection is not established in the specified time.</p> <p><a href="#">Using Connect action for database</a> on page 2469</p>



**What's new**

Improved readability with new formatting capabilities in XML document (Service Cloud case ID: 01886455, 01925386)

When you insert, update, or delete nodes, the XML package does not remove carriage return characters between nodes but does remove all blank text nodes from the XML document. By using **Prettyprint** to format XML files, developers can easily improve the readability of a document. Developers can save time by using the following new options that have been added to the XML Package:

- **Use Prettyprint:** The **Save session data** action supports the Prettyprint format in the XML document. When you select the **Use Prettyprint** check box and use the **Insert node**, **Update node**, or **Delete node** actions and then save the XML document, the code is formatted with proper indentation as per Prettyprint.
- **Remove text nodes that contain only white space:** The **Start Session** action provides an option to remove blank text nodes when you parse the XML document.

[Save session data action in XML](#) on page 3191 | [Start session action in XML](#) on page 3191

New features added to the Email Package (Service Cloud case ID: 01835214, 01846425, 01756713, 01882482)

To support extensive process automation, we added the following action-related features to the Email Package:

- Ability to use the **Reply All** action.
- Enhanced the **Delete all** action to delete all emails from a specific folder. Additionally, you can apply filter parameters to emails such as:
  - All, Read, and Unread
  - Subject
  - From a specific sender
  - Before, on, or after a received date
- The dictionary variable for email properties includes a new variable, `emailNoOfAttachments`, used to retrieve the attachment count.

[Reply All action](#) on page 2533 | [Example using Email actions in a bot](#) on page 3272 | [Delete all action](#) on page 2522

Automate controls using Microsoft UI Automation (COM) technology

You can use the Microsoft UI Automation (COM) technology to automate the following scenarios:

- Capture and automate link controls
- Capture and automate tree controls

[Capture using specific technology](#) on page 2948 | [Actions performed on objects captured with Universal Recorder](#) on page 2923

What's new
<p>Insert Custom column in Data Table</p> <p>A new <b>Custom column</b> option has been added to the <b>Data Table &gt; Insert column</b> action that enables you to insert a new column at a specified index in a data table. When you read an Excel spreadsheet and assign it to a data table, you can modify the table by adding a new column and entering any required data.</p> <p><a href="#">Insert column action</a> on page 2456</p>
<p>New Label option in Loop package</p> <p>A new <b>Label</b> option has been added to the Loop package that enables you to break or continue a specific loop from the nested loops.</p> <p><a href="#">Loop package</a> on page 2784</p>
<p>Add and configure If action conditions</p> <p>You can add and configure a maximum of 32 conditions in a single <b>If</b> action.</p>
<p>Improved automation reliability for web applications</p> <p>When you use the <b>Recorder &gt; Capture</b> action to automate web pages running on Google Chrome and Microsoft Edge browsers, the <b>Recorder &gt; Capture</b> action no longer scrolls down the web page if the target object is visible on the screen. This feature improves the user experience and reliability of automation when there is a fixed top pane on the web page and if some physical actions such as mouse clicks do not work as expected.</p> <hr/> <p><b>Note:</b> Ensure that you install the browser extension (version 3.0.8.0) and use the Recorder package (version 2.10.2) to capture the control.</p> <hr/>
<p>Preferred view retained as default view in the Bot editor</p> <p>As a bot developer, you no longer have to manually select the preferred view when you open the Bot editor. To improve the developer's productivity and user experience, when creating bots in the Bot editor, your preferred view (List, Flow, or Dual) in the Bot editor will persist across user sessions and browsers. When you navigate in the Control Room or after your next log in, the Bot editor will retain your last used or selected view.</p> <p><a href="#">Using Bot editor</a> on page 2232</p>
<p>Line markers for collapsible sections of code in the Bot editor</p> <p>When you create bots using <b>Loop, If/If-else, Step, Trigger-loop, Try, Catch,</b> and <b>Finally</b> statements, the Bot editor clearly shows the collapsible sections. When building automations, developers can use these visual indicator line markers at the beginning and end of the collapsible section to improve their productivity.</p> <hr/> <p><b>Note:</b> The visual indicator line marker for the collapsible section applies only to the <b>List</b> view in the Bot editor.</p> <hr/> <p><a href="#">Using Bot editor</a> on page 2232</p>

**What's changed**

Improved secure registration for Community Edition or Automation 360 users

When a user registers for the Community Edition or Automation 360 account, the registration email sent to the user contains a temporary registration link used to create the user credentials. This registration method is more secure than sending the user their password in plain text.

## Automation Co-Pilot for Business Users

**What's new**

Stationary action buttons

While completing forms in Automation Co-Pilot, action buttons are positioned in the fixed footer of the form. The footer and its contents are responsive to the size of your window and adjust to fit buttons and minimize the footprint.

[Add Form Task to a process automation](#) on page 3458

Forms have improved responsiveness due to this next generation of form rendering technology.

## Document Automation

**What's changed**

**Important:** New Community Edition users will have access to Document Automation but not IQ Bot

As of Automation 360 v.27 release and later, only Document Automation will be provisioned to new Community Edition users. New users will not have IQ Bot permissions, however, IQ Bot will be available for existing, registered users.

## Automation 360 v.27 Community Edition Release Notes

Release date: 15 December 2022

Review what's new in the Community Edition of the Automation 360 v.27 (Build 16701) release. Build 16701 replaces Build 16667.

**Note:** This release includes an optional Bot Agent update. You can continue to run your existing bots without updating the Bot Agent. However, if you want to use the new features in Automation 360 v.27, you must update the Bot Agent available with this release.

For more information on updating to this release, see these resources:

- [Automatically update the Bot Agent](#) on page 1361 | [Manually update the Bot Agent](#) on page 1362
- [Compatibility with release builds](#) on page 1333

## Updated release build

The updated Build 16701 includes fixes for the following issues (Service Cloud case ID: 01937106, 01947340, 01829572):

- Bots were failing because of file dependency or interactive form that included multibyte characters in file names.
- Changes to Automation Co-Pilot Desktop Assistant to manage and clear automations for start, stop, and resume actions.

## Automation Workspace

What's new
<p>Windows 365 Cloud PC now supported as Bot Runner (Service Cloud case ID: 01792699)</p> <p>We support Windows 365 Cloud PC as a Bot Runner to create and run bots on Windows 365 Cloud PC.</p> <p><a href="#">Bot Runner device requirements</a> on page 1167</p>
<p>View keyboard shortcuts in Bot editor</p> <p>In Bot editor, you can now open a menu to view the available keyboard shortcuts.</p> <p><a href="#">Keyboard shortcuts list</a> on page 2235</p>
<p>Enhanced Automation Anywhere Debugger tool</p> <p>The Automation Anywhere Debugger tool is available in the <b>Bot Assistant</b> utility to provide a better user experience. When you invoke the Debugger tool from the Bot editor, you can add, update, or delete actions and variables in a bot.</p> <p>By default, the <b>Watched variables</b> lists is empty. With a single click, you can add all the used variables in a bot. These variables display in a pop-up window where you can select or deselect, one or more variables, from the list.</p> <p><a href="#">Debugger tool</a></p>
<p>ServiceNow package</p> <p>You can use the ServiceNow package from Automation 360 to authenticate and perform several actions with records and attachments in ServiceNow tables.</p> <p><a href="#">ServiceNow package</a> on page 3018</p>
<p>ServiceNow triggers</p> <p>You can use ServiceNow triggers to call an action when there is a new or updated record.</p> <p><a href="#">ServiceNow New Record trigger</a> on page 2299</p>

What's new
<p>Quick assistance at hand for the developers in the Bot editor</p> <p>The accessibility and usability of the Bot editor, actions, and packages have been improved. As a citizen developer or an RPA developer, when you are creating bots, you can quickly look up information about the actions without navigating outside the Bot editor. Under the <b>Actions</b> pane, quick help is enabled with contextual information about actions. Additionally, an icon is configured with a link to the documentation. If you want more information about an action, you can click the link, which redirects you to the relevant page in the documentation portal. This feature is currently available in the following actions and packages.</p> <ul style="list-style-type: none"><li>• Database</li><li>• Email</li></ul>
<p>Enhanced user experience through refreshed and intuitive icons</p> <p>With the new and intuitive icons for actions in the Bot editor, citizen developers and RPA developers can quickly locate the correct action while creating automation for a day-to-day task. These unique and renewed icons are developed according to brand and global standards.</p>
<p>New option in Read from action of Database package (Service Cloud case ID: 01263940)</p> <p>A new check box is available when you use the <b>Read from</b> action to retrieve records from the database and save the retrieved data in a CSV file. When you select this check box, no CSV file is created if the executed SQL query does not return any data.</p>
<p>64-bit ODBC driver now supported in Database package (Service Cloud case ID: 01256142, 01829360, 01849908)</p> <p>We now support connecting to databases by using the 64-bit ODBC driver. This option is available when the connection mode is the default. Organizations transitioning to Microsoft 365 will benefit from leveraging this enhancement and can sustain automation build with 32-bit ODBC drivers.</p> <p><a href="#">Using Connect action for database</a> on page 2469</p>
<p>OAuth 2.0 support in Email and Email trigger packages (Service Cloud case ID: 01798311, 01803702, 01791859, 01828526)</p> <p>Microsoft is deprecating the ability to use Basic authentication in Exchange Online for these specific protocols:</p> <ul style="list-style-type: none"><li>• IMAP</li><li>• POP3</li><li>• EWS</li></ul> <p>We support OAuth 2.0 authentication for these protocols in the Email and Email trigger packages. For enhanced security, you can maintain the business continuity of your email automations by switching the authentication type from Basic to OAuth 2.0, (as recommended by Microsoft).</p> <p><a href="#">Using Connect action in Email package</a> on page 2523</p>

What's new									
<p>Retry mechanism supported in credential variables (Service Cloud case ID: 01786319, 01887182)</p> <p>The credential variables support the retry mechanism. When you create a bot that uses credential variables, if the bot fails during run time to retrieve those variables from the Credential Vault because the Control Room is disconnected or the Control Room services stop intermittently, then the bot tries three times to retrieve the credential variables from the Credential Vault.</p> <hr/> <p><b>Note:</b> Ensure that the Bot Agent version installed on your system is the version that is released with Automation 360 v.27.</p> <hr/>									
<p>Support of other domain name in the Active Directory package (Service Cloud case ID: 01807358, 01910765)</p> <p>We now support Active Directory user operations by logon name with domain and can provide the domain name to extract user details. When you retrieve the user property or perform any user operation based on the logon name (userPrincipalName), and if the user domain name differs from the domain specified in the LDAP path, the user properties are now successfully retrieved with or without a domain name.</p> <p>For example, LDAP Path: LDAP://ADServer/DC=automation, DC=net</p> <table border="1"> <thead> <tr> <th>User</th> <th>Logon name</th> </tr> </thead> <tbody> <tr> <td>userPrincipalName: kim@aaengg.net</td> <td>User can provide logon name as kim@aaengg.net.</td> </tr> <tr> <td>userPrincipalName: shaun@aasales.net</td> <td>User can provide logon name as shaun@aasales.net.</td> </tr> <tr> <td>userPrincipalName:sarah@automation.net</td> <td>User can provide a logon name as either sarah or sarah@automation.net.</td> </tr> </tbody> </table>		User	Logon name	userPrincipalName: kim@aaengg.net	User can provide logon name as kim@aaengg.net.	userPrincipalName: shaun@aasales.net	User can provide logon name as shaun@aasales.net.	userPrincipalName:sarah@automation.net	User can provide a logon name as either sarah or sarah@automation.net.
User	Logon name								
userPrincipalName: kim@aaengg.net	User can provide logon name as kim@aaengg.net.								
userPrincipalName: shaun@aasales.net	User can provide logon name as shaun@aasales.net.								
userPrincipalName:sarah@automation.net	User can provide a logon name as either sarah or sarah@automation.net.								
<p>The following list of actions supports logon name with domain.</p> <ul style="list-style-type: none"> <li>• Update user details</li> <li>• Rename user</li> <li>• Delete user</li> <li>• Enable user account</li> <li>• Disable user account</li> <li>• Set user property</li> <li>• Get user property</li> </ul> <p><a href="#">User account operations</a> on page 2384</p>									

What's new
<p>New action in Text file package</p> <p>You can use the new <b>Read variables</b> action in the Text file package to read the values of variables from the text file.</p> <hr/> <p><b>Note:</b> The <b>Import string from text file</b> action in the String package has been deprecated and will not be available for new bots. We recommend that you use the new <b>Read variables</b> action with enhanced capabilities. This deprecation does not impact any existing bots or bots which were migrated previously and they will continue to run properly. See <a href="#">Support and deprecation policy for packages</a> on page 1079 for package lifecycle and deprecation policy.</p> <hr/> <p><a href="#">Read variables action</a> on page 3135</p>
<p>Call an existing JavaScript function in a webpage</p> <p>You can use the new <b>Call a JavaScript function</b> action in the Browser package to call an existing JavaScript function directly in a webpage or in an iFrame within a webpage in Google Chrome and Chromium-based Microsoft Edge browsers. In the bot, you can also pass one or more input parameters to the JavaScript function and process the return value from the function.</p> <p><a href="#">Call a JavaScript function action</a> on page 2436</p>
<p>Automate controls using Microsoft UI Automation (COM) technology</p> <p>You can use the Microsoft UI Automation (COM) technology to automate the following scenarios:</p> <ul style="list-style-type: none"> <li>• Capture and automate client controls</li> <li>• Capture and automate password text controls</li> <li>• Capture and automate page tab controls</li> </ul> <p><a href="#">Actions performed on objects captured with Universal Recorder</a> on page 2923   <a href="#">Capture using specific technology</a> on page 2948</p>
<p>Capture objects on applications running in administrator mode</p> <p>You can use the Recorder to capture objects on applications running in administrator mode. To capture the object, select the <b>Capture and run with admin privileges</b> option from the Bot editor.</p> <p><a href="#">Recorder package</a> on page 2916</p>
<p>Enhanced bot performance when using global values across bots</p> <p>When you use global values across a parent bot and a child bot, the bot performance is enhanced by reducing the bot execution time. To enable enhanced bot performance, you must set the <b>Bot compatibility version</b> to <b>3</b> in the <b>Advanced settings</b> page of the Bot editor.</p> <hr/> <p><b>Note:</b> Ensure that the Bot Agent version installed on your system is the version that is released with Automation 360 v.27.</p> <hr/> <p><a href="#">Bot compatibility version</a> on page 2322</p>

**What's new**

Enhanced user interface for Define functionality in AISense Recorder

- We have enhanced the user interface of **Define** window in the AISense Recorder that enables you to use anchors easily and automate UI objects that are not detected by AISense Recorder automatically. To improve functional clarity, the following object types are renamed:
  - **Active text** is renamed to **Link**
  - **Passive text** is renamed to **Text value**
- If you unintentionally click the screen or click before the highlighter appears, the AISense Recorder provides visibility into it. You must confirm to capture the object again or use the **Define** functionality to define the object on the screen.
- In the **Define** window, the AISense Recorder shows embedded help for each of the control types so you can select the correct control types for custom objects.

[Use variable anchor](#) on page 2273 | [Capture Textbox, Radio, Checkbox, and Combobox](#) on page 2268 | [Capture text value through AISense Recorder](#) on page 2267 | [Capture link button through AISense Recorder](#) on page 2266 | [Capture Image button through AISense Recorder](#) on page 2264

New virtual key added to the Simulate keystrokes package

In the **Simulate Keystrokes > Keystrokes** action, a new key named **Return** has been added to the virtual keyboard for Enter functionality and the Enter key in the Number pad has been renamed to **Num Enter**. As a result, the **Return** key is the main Enter key on the keyboard. This enhancement keeps the keyboard in sync with the physical keyboard. The nomenclature has been changed to avoid confusion between the Enter key on the keyboard and the Enter key on the Number pad.

Support for global variable for all Datetime actions

In the Datetime package, you can use the Datetime global variable across all **Datetime** actions. You can select to use either **String** variable or a **Global** variable in the **Source date and time variable** option. This avoids creating multiple local variables and reduces the total number of actions used in a bot.

[Datetime package](#) on page 2484

Workato Integration

You can integrate the Automation 360 platform and Workato by using the Automation Anywhere connector. You can establish a connection with the Automation Anywhere Control Room and perform various operations using the Control Room APIs.

[Workato integration](#)

SnapLogic Integration

You can now integrate the Automation 360 platform and SnapLogic. You can establish a connection with the Automation Anywhere Control Room and perform various operations by using the Control Room APIs.

[Snaplogic integration](#)



## Automation Co-Pilot for Business Users

What's new
<p>Build forms easily by dragging elements to form builder</p> <p>You can now build your forms by just dragging your elements to a blank form builder. As you add elements to the form builder, it automatically adjusts without your input, letting you focus on the form-building experience. You can also re-size the columns of your elements.</p> <p><a href="#">Create a form</a></p>
<p>New actions in the Process Composer</p> <p>In the Process Composer, you can now use a set of actions when you build out your process. For example, you can double-click a task, such as <b>Bot Task</b> and <b>Human Task</b>, and the task will be updated in your process flow automatically. With this, you can save time because you do not need to task specific tasks to your process. In addition, you can now copy, cut, and paste using <b>CTRL + C</b>, <b>CTRL + X</b> and <b>CTRL + V</b>, respectively to retain, reuse, or replace data.</p> <p><a href="#">Supported behaviors for tasks and elements in Process Composer</a> on page 3422   <a href="#">Create a process automation in Process Composer</a> on page 3454</p>
<p>Use a reference ID meta type in Process Composer</p> <p>You can now use a reference ID with a <b>Meta</b> variable type for your variables in the Process Composer. When you set a reference ID as a meta variable type, you can now use your reference ID data when you run your tasks in the web interface. This simplifies your references because you only need to rely on using the reference ID instead of relying on other variable types or references.</p> <p><a href="#">Create a process automation in Process Composer</a> on page 3454</p>
<p>Center your forms in preview</p> <p>You can now preview your forms in the new preview window and get an accurate assessment on how your form will look when it is rendered. You can select the <b>Make form preview centered</b> option to enable the preview window. You can also set the appropriate display resolution, x and y coordinates, and even center your form.</p> <p><a href="#">Create a form</a></p>
<p>Upload images directly to the form composer</p> <p>You can now upload images directly to the form composer by using the <b>Image</b> element. This saves you time to view the images in the form without a file reference, rather than in the initial step, where the image requires a file reference to be viewed.</p> <hr/> <p><b>Note:</b> Image files are limited to 150 kb (like a logo).</p> <hr/> <p><a href="#">Using the Image element</a> on page 3443</p>

What's new
<p>Change label action for Button element</p> <p>The change label action in the form rules now applies to the <b>Button</b> element. When you use the change label action in form rules and apply it to the buttons in your form, the changes will be automatically applied to the buttons where you set the rules. This keeps the flow consistent with the elements that you are using because all the buttons inherit the same rule.</p> <p><a href="#">Conditional actions, rules, and elements</a> on page 3428</p>
<p>Rules editor for Table element</p> <p>The rules editor is now applicable to the <b>Table</b> element. When you use the rules editor for your tables, the rules conditions are applied for each individual columns while any actions that you set are applied for each row in the row level. This makes things consistent for each new or existing row that you use because all the rows inherit the same rule.</p> <p><a href="#">Conditional actions, rules, and elements</a> on page 3428</p>

## Document Automation

What's new
<p>Document Automation supports regular expression pattern-based extraction</p> <p>When configuring fields that the learning instance will extract, you can specify a regular expression (regex) pattern to help the extraction engine find the field. After entering the regex pattern you can test the expression using sample content within the <b>Create Learning instance</b> window. You can use regex pattern extraction for values that follow a specific pattern, such as a VAT number or a PO number.</p>
<p>Validation interface support for shortcut keys</p> <p>Zoom in and out on documents in the Validation interface by holding the Alt key and scrolling with your mouse wheel.</p>

## Automation 360 v.26 Community Edition Release Notes

Release date: 22 September 2022

Review what's new in the Community Edition of the Automation 360 v.26 (Build 15450) release. Build 15450 replaces Build 15439.

**Note:** The v.26 build supports Manifest V3 browser extensions for Google Chrome and Microsoft Edge browsers. For more information, see [Chrome and Edge Manifest V3 extensions](#) on page 1138.

This release includes an optional Bot Agent update. You can continue to run your existing bots without updating the Bot Agent. However, if you want to use the new features in Automation 360

v.26, you must update the Bot Agent available with this release. For more information on updating to this release, see these resources:

- [Automatically update the Bot Agent](#) on page 1361 | [Manually update the Bot Agent](#) on page 1362
- [Compatibility with release builds](#) on page 1333

## Automation Workspace

What's new
<p>Community Edition users provisioned to closest region</p> <p>Registered Community Edition users are now provisioned to a region that is closest to their country (either in the US or EU). Provisioning is based on the country of the users account.</p>
<p>Support for Manifest V3 extensions</p> <p>Automations that use Google Chrome Manifest V2 based extensions will stop working sometime after June 2023. The deprecation timelines of Manifest V2 based extensions are currently under review and subject to change by Google.</p> <ul style="list-style-type: none"> <li>• For Google Chrome Manifest V2 extensions timelines, see <a href="#">Manifest V2 support timeline</a>.</li> <li>• For Microsoft Edge Manifest V2 extensions timelines, see <a href="#">Overview and timelines for migrating to Manifest V3</a>.</li> </ul> <p>This might impact your existing automations that use Manifest V2 based extensions for Google Chrome and Microsoft Edge browsers. Automation 360 v.26 and later includes Manifest V3 extensions by default to support features that use Google Chrome and Microsoft Edge browsers.</p> <p>You can automatically enable Manifest V3 based extensions for Google Chrome and Microsoft Edge on all the Bot Runner devices by enabling the <b>Browser extensions</b> option from the Control Room. Enabling this option applies the browser extension settings on all the registered Bot Agent devices.</p> <hr/> <p><b>Note:</b> We will continue to support Manifest V2 based extensions for Google Chrome until June 2023. To know about Microsoft Edge Manifest V2 based extensions timelines, see <a href="#">Overview and timelines for migrating to Manifest V3</a>.</p> <hr/> <p><b>Note:</b> Manifest V3 extension is supported on Google Chrome and Microsoft Edge browsers version 91 and later only.</p> <hr/> <p><a href="#">Configure browser extensions</a> on page 1799   <a href="#">Chrome and Edge Manifest V3 extensions</a> on page 1138</p>
<p>Microsoft Windows 11 Enterprise now supported (Service Cloud case ID: 01252605, 1252605, 1253745, 01255134, 01379865, 01801610, 01810148)</p> <p>We now support Microsoft Windows 11 Enterprise, so you can now install and update the Bot Agent and run bots on the Windows 11 Enterprise operating system.</p> <p><a href="#">Bot Agent compatibility</a> on page 1332</p>

What's new
<p>Salesforce command package</p> <p>You can now authenticate from Automation 360 to access Salesforce and run several command actions by using the new Salesforce command package.</p> <p><a href="#">Salesforce package</a> on page 2973</p>
<p>SAP GUI 770 version now supported (Service Cloud case ID: 01793132, 01792775, 1776805, 01792623, 787725, 01805482, 01805479, 01792623, 01810356, 01822839, 01851451, 01853577, 01860050)</p> <p>SAP GUI 770 (patch 6) is now certified and supported with Recorder and SAP package.</p> <p><a href="#">Recorder actions supported in various SAP versions</a> on page 2952</p>
<p>Configure and use custom proxy configuration in REST Web Service package (Service Cloud case ID: 01271527, 01765084, 01839282)</p> <p>REST Web Service package is now enhanced to support custom proxy configuration for each <b>Delete</b>, <b>Get</b>, <b>Patch</b>, <b>Post</b>, and <b>Put</b> action. This provides you more flexibility in calling REST APIs with different proxy configuration and allow you to create hybrid API automation.</p> <p><a href="#">REST Web Service package</a> on page 2961</p>
<p>Keyboard shortcuts to reduce scrolling</p> <p>When developing large bots, you can now use keyboard shortcuts to expand and collapse individual or all sections and move through the lines of code quickly instead of scrolling and minimizing sections individually.</p> <p><a href="#">Keyboard shortcuts to expand or collapse elements in bot logic</a> on page 2234</p>
<p>Set value in any editable control field to be blank in SAP application (Service Cloud case ID: 00821861, 01807129)</p> <p>When you use the <b>Set text</b> action of the SAP package, you can now set the value in any editable control field in the SAP application to be blank. For example, you can set the value in the text field or the date field to be blank.</p>
<p>Loop through emails and move them one at a time (Service Cloud case ID: 00749763, 01807189, 01840743)</p> <p>You can now loop through all the emails in a mailbox and move one email at a time to a destination folder by using the <b>Move</b> action in the Email package.</p> <p><a href="#">Move action</a> on page 2533</p>
<p>Configure p12 certificate for SOAP-based automations (Service Cloud case ID: 00757213)</p> <p>In the SOAP Web Service action, you can now select the p12 certificate file and provide a password for user authentication. With this enhancement, you can now access web services that use the p12 certificate-based authentication (a more secure type of SSL certificate).</p> <p><a href="#">Example of using the SOAP web service action</a> on page 3240</p>

What's new
<p>Improved accessibility, usability of content on Terminal Emulator window (Service Cloud case ID: 01609467)</p> <p>You can now have improved accessibility and usability of the content displayed on the Terminal Emulator window. When you use the enhanced <b>Get text</b> action of the Terminal Emulator package, you can now view and extract all the lines and text present in the Terminal Emulator window and perform an operation based on your requirement.</p> <p><a href="#">Using Get text action for Terminal Emulator</a> on page 3125</p>
<p>Run bots with or without window title matching in letter case</p> <p>You can now run bots even when the title of a captured window does not match the letter case. For a bot to identify a static window or browser titles and titles with a wildcard character, you can opt for a case-sensitive match if you want the letter case to be matched, or a case-insensitive match otherwise, by using the <b>Case sensitive</b> option.</p>
<p>Control image preview and storage in Control Room during secure recording</p> <p>You can now choose whether or not the object images are available for preview and stored in the Control Room during secure recording by enabling the <b>Recorder preview image</b> setting. When you enable the setting, the image is previewed in the Bot editor and stored in the Control Room for 60 minutes. If you choose not to preview, images are not captured.</p> <p><a href="#">Secure recording</a> on page 1042   <a href="#">Secure recording mode</a> on page 2255   <a href="#">Settings</a> on page 1789</p>
<p>Automate Microsoft Excel spreadsheets from SharePoint</p> <p>You can now automate Microsoft Excel spreadsheets that are uploaded and shared on SharePoint. Use <b>Excel advanced &gt; Open</b> action to open the Microsoft Excel spreadsheets from SharePoint location.</p> <p><a href="#">Using the Open action for Excel advanced</a> on page 2571</p>
<p>Automate Citrix Virtual Apps in Edge with IE mode</p> <p>When using the Recorder, you can now automate Citrix Virtual Apps running on Microsoft Edge Chromium with IE mode.</p>
<p>Automate controls using Microsoft UI Automation (COM) technology</p> <p>For automation, you can now use the Microsoft UI Automation (COM) technology in the following scenarios:</p> <ul style="list-style-type: none"><li>• Capturing controls with secure recording mode</li><li>• Capturing and automating combo box and list view controls</li><li>• Using <b>Object exists</b> and <b>Object does not exist</b> Recorder conditions in If, Loop, and Wait packages</li></ul> <p><a href="#">Capture using specific technology</a> on page 2948   <a href="#">Actions performed on objects captured with Universal Recorder</a> on page 2923</p>

**What's new**

## Seamless automation of Citrix Virtual Apps and other Citrix applications

With the new Automation 360 remote agent for Citrix, you can now seamlessly automate all types of Citrix Virtual Apps and other Citrix applications that are supported on desktop applications using the Recorder.

The new Automation 360 remote agent for Citrix supports the following browsers and technologies:

- Google Chrome
- Internet Explorer
- Microsoft Edge
- Microsoft Edge with IE mode
- Mozilla Firefox
- Java
- Electron apps
- Microsoft Active Accessibility (MSAA)
- Microsoft UI automation

[Installing Automation Anywhere remote agent on Citrix servers](#) on page 1227 | [Using the Recorder on Citrix Virtual Apps servers](#) on page 1222

## Implement coding standards with code analysis

You can now implement best coding practices by configuring coding rules in the Control Room. This feature helps you prevent potential errors, improve bot reliability, and makes the code more uniform, accessible, reliable, and efficient.

- As an administrator or a user with **View policies** and **Manage policies** permission, you can configure the code analysis policy for all users.
- As a Citizen Developer, you can run code analysis to analyze your bots against readability, maintenance, security, and compliance best practices.

[Code analysis](#) on page 2178

## Fetch execution details for specific execution IDs with new Control Room API

You can now fetch the execution details, such as `botOutVariables` and `CallbackInfo`, for a specific execution ID by using the new API endpoint, `v3/activity/execution/<id>` API.

## Automation Co-Pilot for Business Users

What's new
<p>Embedded automation with OAuth 2.0</p> <p>Embedded automation streamlines access to the automation experience.</p> <p><a href="#">Embed automations in your application using Automation Co-Pilot</a> on page 3298</p> <ul style="list-style-type: none"> <li>Automation Co-Pilot Integrations embeds in web applications as a widget, so if you are an end user, you can access automated processes and bots without leaving your environment.</li> <li>Automation Co-Pilot Extensions offers further adaptability through Chrome browser extensions, enabling automation directly in any web scenario. Business users can now access automations through a widget, available through an extension in their web browser.</li> <li>With an OAuth 2.0 connection, existing access to automations in the Control Room are now shared with the Extensions to offer you a seamless user experience.</li> </ul> <p><a href="#">Embed automations in your application using Automation Co-Pilot</a> on page 3298</p>
<p>Delete files permanently from Automation Co-Pilot cloud storage</p> <p>You can now delete files permanently from Automation Co-Pilot cloud storage. When you delete a request, the associated file is also permanently deleted now and not just sent to the recycle bin.</p> <p><a href="#">Cloud storage usage</a> on page 3481</p>
<p>Append or overwrite operations in your form</p> <p>Append or overwrite operations in your form by using the <b>Assign</b> form rules for the web, with the <b>Checkbox</b> and <b>Radio Button</b> elements, which now support form rules.</p>
<p>Assign dynamic values with support for new elements in your forms</p> <p>When you use the interactive forms package, you can now assign dynamic values with the <b>Assign</b> action, which now supports <b>Checkbox</b> and <b>Radio Button</b> elements in your form.</p> <p>You can also change the label of the selected form elements with the <b>Change label</b> action for the <b>Button</b> element.</p> <p><a href="#">Interactive forms package</a> on page 2738</p>

## IQ Bot

What's new
<p>Search for form or table fields</p> <p>When creating a learning instance, when you are configuring fields, you can now search for fields by field name, field label, or data type.</p>

## Previous Community Edition Release Notes

Review the release notes for previous Community Edition releases.

### Automation 360 v.25 Community Edition Release Notes

Release date: 21 June 2022

Review what's new in the Community Edition of the Automation 360 v.25 (Build 14304) release.

**Important:** This release includes an optional Bot Agent update. You can continue to run your existing bots without updating the Bot Agent. However, if you want to use the new features in Automation 360 v.25, you must update the Bot Agent available with this release.

For more information on updating to this release, see these resources:

- [Automatically update the Bot Agent](#) on page 1361 | [Manually update the Bot Agent](#) on page 1362
- [Compatibility with release builds](#) on page 1333

### Automation Workspace

What's new
<p>Support to automate applications supported on Citrix Workspace app (Service Cloud case ID: 01758063)</p> <p>The Citrix Workspace app is now supported on Automation 360. You can now automate applications that are accessed through the Citrix Workspace app by using the <b>Recorder &gt; Capture</b> action or the <b>Start recording</b> option.</p>
<p>Install Bot Agent on devices that have Enterprise 11 Enterprise Client</p> <p>When you are creating a bot in Automation 360, you can now install the Bot Agent on a device with an existing Enterprise 11 Enterprise Client. You can create or run bots from both the Control Room instances.</p> <p><a href="#">Install Bot Agent and register device</a> on page 1347</p>
<p>IE 11 EOL notification banner displayed in Control Room</p> <p>Starting from the Automation 360 v.25 release, if you use the Microsoft Internet Explorer browser to access the Control Room, you will be prompted to use an alternative supported browser, such as Google Chrome or Microsoft Edge (Chromium). When you log in to the Control Room, a notification banner is displayed indicating that support for Internet Explorer 11 is ending.</p> <p><a href="#">Log in to Automation Anywhere Control Room</a> on page 1488</p>



**What's new**

AI Sense Recorder: Support for Korean language and complex table operations

- You can now use AI Sense Recorder to automate applications that use Korean and a combination of Korean and English interfaces.

[AI Sense for recording tasks from remote applications](#) on page 2256

- With AI Sense Recorder, you can now extract tabular data from complex tables. You can capture and automate tables with wider columns and tables that have columns with controls such as check boxes and options. You can also capture specific columns from tables.

**Note:** If the table is not detected automatically, use the **Define** option to detect the table.

[Table data extraction through AI Sense Recorder](#) on page 2270

Enhancements to Recorder

- When you run a bot, you can now automate objects that appear behind the bot runtime window by using the **Recorder > Capture** action. (Service Cloud Case ID: 00684306, 00770636, 01146672)
- You can now use the Recorder to capture and automate objects with a specific technology. The **Capture object** tab now has the option to select a specific technology and capture using that technology. You can capture objects with the following technologies:
  - Microsoft Active Accessibility (MSAA)
  - UI automation
  - Microsoft (MS) COM UI Automation

[Capture using specific technology](#) on page 2948

(Service Cloud Case ID: 01760871, 01865823)

- You can now use the Recorder to automate third-party plug-in window objects on Google Chrome or Microsoft Edge browsers by using a specific technology.

**Reduce Data Loss** option in PDF package

In the **PDF > Extract text** action, for the **Structured text** type field, a new **Reduce Data Loss** option is now available. When you use this option, you can extract the complete text with minimal overlap of characters.

[Using Extract text action from PDF](#) on page 2882

Enhancement to the String package (Service Cloud case ID: 00770822)

In the **String > Extract text** action, a new **When extracting** option is now available. You can use this option to specify whether the case of the text in the extracted substring must match that in the source string.

[Using Extract text action of String package](#) on page 3089

What's new
<p>Download files from URLs that require NTLM authentication (Service Cloud case ID: 01189873)</p> <p>With the enhanced Browser package, you can now download files from URLs that require NTLM authentication by using the <b>Browser &gt; Download file</b> action.</p>
<p>Enhancement to multiple attachments option in Send email action (Service Cloud case ID: 00800976, 00817136, 00821405, 00936080, 01256523, 01256320, 01262069, 01259369, 00936080, 01801928)</p> <p>When you send email from bots, you can now send multiple attachments as a list of files or a variable that contains the list of file objects. With this feature, you can attach files such as data files, spreadsheets, and word processor documents to your email. You can attach multiple filepaths from a local drive or a network drive, or you can use a variable that contains a filepath.</p> <p><a href="#">Using Send action</a> on page 2540</p>
<p>Enhancement to SOAP Web Service package</p> <p>When you build a SOAP response for an Xpath expression in the SOAP Web Service package, the result of the Xpath expression can be stored as a list of strings.</p> <p><a href="#">Example of using the SOAP web service action</a> on page 3240</p>
<p>View version history of non-bot file dependencies (Service Cloud case ID: 01615105)</p> <p>You can now view the version history of your non-bot file dependencies. This helps to identify relevant changes made to your file by other users during a specific date and time along with the check-in messages.</p> <p><a href="#">View version history of non-bot file dependencies</a> on page 2363</p>
<p>Edit non-empty folder names in private workspace (Service Cloud case ID: 00535388, 00730075, 00786633, 00791528, 01615295, 01820406)</p> <p>You can now edit your non-empty folder names in the private workspace. With this feature, you can now manage folders more easily. Ensure the following when you rename a folder:</p> <ul style="list-style-type: none"><li>• It does not contain checked-out or cloned bots even at subfolder levels.</li><li>• It does not contain more than 100 items including subfolders and files.</li></ul> <p><a href="#">Create and rename folders</a> on page 2325</p>
<p>View dependency maps for bots</p> <p>You can now view the dependency map for your bot in both the public and private workspaces. The dependency map shows the immediate parent and child bots for any selected bot. If you are an RPA developer, you can use the dependency map to better understand where a bot is invoked and which child bots are invoked by the bot. With this information, you can gauge the impact of the change in a bot, use the bot effectively, maintain better bot code and reusability, and prevent conflicts.</p> <p><a href="#">View bot dependency map</a> on page 2315</p>

## Automation Co-Pilot for Business Users

What's new
<p>Create request in new tab</p> <p>You can now open and run your new requests in a separate tab when you select the <b>Open request in New Tab</b> option in the initial form. With this option, you can create requests concurrently without changing your current page navigation.</p> <p><a href="#">Create a request and complete a task</a> on page 3384</p>
<p>Duplicate rows for Table element</p> <p>In the web interface, when you are adding rows to your form by using the <b>Table</b> element, you can now save time by duplicating a row in the table with the new <b>Duplicate row</b> option. The duplicated row will now be placed under the highlighted row that you had selected.</p>
<p>Interface triggers support more technologies</p> <p>You can now use interface triggers with the following technologies:</p> <ul style="list-style-type: none"><li>• Windows native</li><li>• SAP Desktop</li><li>• Google Chrome and Edge Chromium browsers</li></ul> <p><a href="#">Add an interface trigger</a> on page 2294</p>

**What's new**

## Enhancements to form rules

- Use custom formatting

When you are adding a rule, if you use the **If** menu to set the rule conditions on certain elements such as **Text Box** or **Text Area**, you can now select **Is** from the drop-down menu to enable additional options. Select the **Custom** option and click **Add regular expression** to apply custom formatting requirements on the selected element.

Consider a scenario where the user IDs of all your employees have AV as prefix. For example, for an employee whose name is Adam, the user ID is AVAdam. Use the **Add regular expression** option to set the value in the **Regular expression** field as ^AV. If a user enters Adam in the user ID field, an alert is displayed.

- Set custom value or append element value

When you are adding a rule, use the **Then** menu to select a form element. For this form element, you can set one of the corresponding actions using **Set Value** or **Append value**:

- **Value**: Data entered in the **Enter value** field is applied to the selected element.
- **Form element**: Data from the form element selected in the **Select element** drop-down menu is appended.

Consider a scenario where a user registration form has 'First name' and 'Employee ID' fields. You can set one of the following rules for the value in the Employee ID field:

- Select **Value** and enter Emp1013 as preset value.

This value is displayed in the 'Employee ID' field when the bot runs.

- Select **Form element** and set 'First name' element in the **Select element** drop-down menu.

The value from the 'First name' field is appended to the 'Employee ID' field when the bot runs.

You can use elements in the same way that variables are used in the Bot editor. You can enter **\$** to view a list of elements.

[Conditional actions, rules, and elements](#) on page 3428

## Document Automation

IQ Bot Extraction360 (Preview) is now Document Automation. Community Edition enables users to try features from Document Automation, including creating up to five learning instances, connecting to learning instances in Automation 360 IQ Bot, uploading documents for processing, and validating documents using Automation Co-Pilot task manager.

[Document Automation Community Edition](#) on page 3724

**What's changed**

The **Document Workspace** folder now holds learning instance assets (bots, process, and form). Previously, these assets were located in the **IQ Bot Processes** folder.

What's changed
The actions which support document processing are now located in the Document Extraction package. Previously, these actions were located in the IQ Bot Extraction360 (Preview) package.
Learning instances from prior releases have been deleted to enable the upgrade to Build 14304.

Limitations
Document Automation supports a device username of 21 characters or fewer.
The value beside the <b>Validate documents</b> link, which indicates the number of documents awaiting validation for a learning instance, sometimes does not appear.
When you are validating a document, if you draw a box, zoom in, and then click <b>Fit to screen</b> , the box appears at a different location from where you clicked.
If you connect to a learning instance from Automation 360 IQ Bot with an optional field that has a set default value and some fields that are unmapped, when you process documents in that learning instance in Document Automation, the default value appears in the unmapped fields.
When a bot runs an action from the Document Extraction package, the <b>Activity &gt; In progress</b> page shows the item name as IQBotAutoExtract.
Although the Learning instances page states that users can not delete learning instances, a user can delete a learning instance by mousing over the actions menu to the right of the learning instance and clicking the <b>Delete</b> icon.

## Automation 360 v.24 Community Edition Release Notes

Release date: 22 March 2022

Review what's new in the Community Edition of the Automation 360 v.24 (Build 12350) release.

**Note:** For information about Automation 360 v.24R2 patch for Community Edition, see [Automation 360 v.24R2 Release Notes for Internet Explorer 11 EOL](#) on page 347.

### Automation Workspace

**Important:** This release includes an optional Bot Agent update. To use the new features in v.24 (including updates to Bot Migration, Browser, DLL, Process Discovery, and Recorder packages), update the Bot Agent available with this release. However, note that if you want to run your existing bots, you do not have to update your Bot Agent to this release.

For more information on updating to this release, see these resources:

- [Automatically update the Bot Agent](#) on page 1361 | [Manually update the Bot Agent](#) on page 1362
- [Compatibility with release builds](#) on page 1333

What's new
<p>Do more with Microsoft Edge Chromium</p> <p>You can now use the Microsoft Edge Chromium browser extension for the following:</p> <ul style="list-style-type: none"> <li>• Bot Agent proxy configuration</li> <li>• Automatic population of device credentials</li> </ul> <p><a href="#">Browser requirements for Automation Workspace</a> on page 1210</p>
<p>Reduce turnaround time</p> <p>You can now reduce the turnaround time for collecting information on issues by capturing log files from the Bot Runner device. You can save the log files by using the new <code>-collectLogs</code> command with the Bot Agent diagnostic utility.</p> <p><a href="#">Perform Bot Agent diagnostic checks</a> on page 1364</p>
<p>Enhancement to AISense Recorder</p> <p>You can now use AISense Recorder to automate applications that use Japanese and a combination of Japanese and English interfaces.</p> <p><a href="#">AISense for recording tasks from remote applications</a> on page 2256</p>
<p>Support for copying metadata from one bot to another</p> <p>You can now copy image and metadata files from one bot to another by using the <b>Copy to shared clipboard</b> option.</p>
<p>Wait time option in SOAP Web Service and REST Web Service packages (Service Cloud case ID: 00756730, 00792793, 01255869, 01753287)</p> <p>When you create a bot, you can now set a time-out value for actions in REST and SOAP requests. To indicate how long a bot should wait for a response from the server before timing out, you can set a wait time (in milliseconds) in the <b>Wait for actions to complete</b> field. You can enter a number or a variable or provide a global value.</p>
<p>Format text with new HTML editor in Email package</p> <p>In the Email package, when you use the <b>Send</b>, <b>Reply</b>, and <b>Forward</b> actions, you can now create and customize your email layout and body by using the new <b>HTML</b> design editor. Use the editor toolbar to make various changes to your text, such as applying bold, italic, and other formatting effects, inserting links, and changing the font and size of the text. You can copy the content from the design editor and paste it to other windows.</p>
<p>Task Bot package now supports passing Window variable to child bot (Service Cloud case ID: 00691890, 00804359, 01258948, 01764292)</p> <p>In the <b>Run</b> action of the Task Bot package, when you select <b>Input values</b> fields and enter the values or variables to pass to the child bot, you can now choose the <code>Window</code> type variable and pass it from parent bot to child bot.</p>

What's new
<p>New option in Content type field of REST Web Service package (Service Cloud case ID: 00666852, 00789910, 00771194, 00785116, 00825945, 01762199)</p> <p>You can now use the <b>multipart/form-data</b> option to upload files and data through REST Web Service. The content type multipart/form-data can be used to submit form elements containing files, non-ASCII data, and binary data. This option is available for actions such as <b>POST</b>, <b>PUT</b>, and <b>PATCH</b>.</p>
<p>Custom delimiter option in SOAP Web Service package</p> <p>For responses specific to XPath, you can now use the custom delimiter option to delimit the return content from the SOAP response. In the <b>Custom Delimiter</b> field, you can provide a character or a variable, and the output of the delimited response will be a complete string.</p>
<p>New option in Run function action of DLL package (Service Cloud case ID: 00830568, 01063654, 01259336, 01767965)</p> <p>In the <b>Run function</b> action of the DLL package, when the C# DLL interacts with the Windows API to perform system-related operations, such as keystroke, mouse click, or window switching, an intermediate window (AAZeroSizeForm) is displayed occasionally and interrupts the user's operation when the bot is running. In some cases, the DLL function does not interact with the Windows API to perform actions, such as keystroke, mouse click, or window switching, on the operating system UI through the DLL function. In such cases, you can now select the <b>Run function in background</b> check box to bypass the intermediate window (AAZeroSizeForm) and run the C# DLL in the console application without the form. This feature also helps to improve the performance of the DLL execution if the <b>Run function in background</b> check box is selected.</p>
<p>Autoscroll supported in Bot editor (Service Cloud case ID: 00730747)</p> <p>When you are creating or editing bots with a large number of lines of code and when you drag actions up or down the page, the page now automatically scrolls up or down accordingly. This feature is supported in both <b>Flow</b> and <b>List</b> views.</p>
<p>New JSON package</p> <p>Use the JSON package to automate JSON data. You can now extract the required information from JSON text or file and directly use the values in the bot.</p> <p><a href="#">Json package</a> on page 2762</p>
<p>New option in Catch action of Error handler package (Service Cloud case ID: 00766117)</p> <p>In the Error handler package, you can now ignore errors from actions inside the <b>Catch</b> block by using the <b>Catch &gt; On error, continue with next action</b> option. When you select the <b>On error, continue with next action</b> check box, even if there is an error from an action in the <b>Catch</b> block, no exception is thrown and the bot ignores the error and continues to the next action.</p> <hr/> <p><b>Note:</b> This enhancement applies to all nested actions in the <b>Catch</b> block. For example, if you have a <b>Try/Catch</b> action inside a main <b>Catch</b> action, if the check box is selected on the main <b>Catch</b> action, any error from actions within the nested block will also be ignored.</p>

**What's new**

## Enhancement to String package

In the **Extract text** action of the String package, when you use the **After** or **Before and/or after** option, you can now extract a substring from a specified source string that occurs in the range of 1 through 999999 times in a file.

## Search for files by specific date

You can now search for files created or modified on a specific date by using the new **On a date** option available in the **File Date** condition of various packages.

You can use this feature with the following packages and actions:

- File package
  - **Copy Desktop files** action
  - **Delete** action
  - **Print** action
  - **Print multiple files** action
  - **Rename** action
- Folder package
  - **Copy** action
  - **Delete** action
  - **Rename** action
- If > File date condition
- Loop > While > File date condition

## New action in Excel advanced package (Service Cloud Case ID: 01263892, 01782290)

When you perform actions in a Microsoft Excel worksheet, you can now disable or enable real-time screen update by using the new **Disable or enable real-time screen update** action of the Excel advanced package. This action is useful to improve the performance of Excel-based automations at run time when dealing with large data sets.

[Worksheet operations in Excel advanced](#) on page 2574

## Use Recorder conditions in Chromium-based Microsoft Edge with Internet Explorer (IE) mode

You can now use the **Object exists** and **Object does not exist** Recorder conditions in Chromium-based Microsoft Edge with IE mode for the following packages:

- Loop > While condition
- Wait > Wait for condition
- If package



**What's new**

Internet Explorer browser support for Browser package and window variables

- The following actions of the Browser package now support the Internet Explorer browser:
  - Open
  - Close
  - Go back
  - Get source code
- In the **Browser** option, you can now select the Internet Explorer tabs from the list of active tabs.

[Browser package](#) on page 2435

Enhancement to Datetime package

The **Variable** option in the **Datetime > Assign** action is now enhanced and divided into two options:

- **Datetime**: Enables you to select the date and time along with the time zone manually and assign it to a Datetime variable.
- **Variable**: Enables you to select the Datetime variable or other variables that can have Datetime as a subtype, such as the Dictionary, Record, and list variables.

[Using the Assign action](#) on page 2486

Enhancement to Recorder package

You can now capture and automate objects inside a cross-domain IFrame that has multiple IFrames with the same frame source and IFrames that are loaded at run time in Google Chrome and Microsoft Edge Chromium browsers. You can do this by using the **Recorder > Capture** or the **Start recording** option. This support is also available for offline Google Chrome extensions.

[Recorder package](#) on page 2916

Support for pop-up windows and dialog boxes in Google Chrome, Microsoft Edge Chromium, and Mozilla Firefox browsers (Service Cloud Case ID: 00762207, 00769773, 00781196, 00786646, 00777907, 00795677, 00785995, 00808600, 00811044, 00767486, 01282172, 01286665, 01256750, 01762040)

When you are automating a web page on the supported browsers, you can now capture the pop-up windows, alert dialog boxes, confirmation dialog boxes, and prompt dialog boxes that appear. You can do this by using the **Recorder > Capture** or **Start recording** option.

[Recorder package](#) on page 2916

What's new
<p>Retrieve source code of an iFrame in Google Chrome browser</p> <p>You can now retrieve the source code of an iFrame in the Google Chrome browser by using the <b>Browser &gt; Get source code</b> action. You can use the new <b>Capture object</b> option to capture these iFrames.</p> <hr/> <p><b>Note:</b> The <b>Capture object</b> feature is optional and is only used to retrieve the source code of an iFrame.</p> <hr/>
<p>Run JavaScript inside an iFrame in Google Chrome browser</p> <p>You can now run JavaScript in a page that contains iFrames in the Google Chrome browser by using the <b>Browser &gt; Run JavaScript</b> action. You can use the new <b>Capture object</b> option to capture iFrames on which you want to run JavaScript.</p> <hr/> <p><b>Note:</b> The <b>Capture object</b> feature is optional and is only used to run JavaScript inside an iFrame.</p> <hr/>
<p>Global session support for Excel basic package</p> <ul style="list-style-type: none"><li>• The Global session option is now supported for the Excel basic package. Use the Global session option to share a Microsoft Excel session across multiple bots so that you can use the same Excel worksheet across these bots.</li><li>• The <b>Session name</b> field is now renamed <b>Create Excel session</b>.</li></ul> <p><a href="#">Using the Open action for Excel basic</a> on page 2563</p> <hr/>
<p>Default variable to hold number type data</p> <p>When you are building or testing a bot, you can now use the default number variable <code>SampleNumber</code>, which is included in the Variables palette.</p> <hr/> <p><b>Note:</b> The default number variable is only available in new bots.</p> <hr/>
<p>Export and import password-protected files</p> <p>To improve security by providing protection against unauthorized access and malicious editing and also to protect privacy, the export and import features are now enhanced to include the password option. With this feature you can now perform the following:</p> <ul style="list-style-type: none"><li>• Set a password for the files that you want to export from your Control Room.</li><li>• Import the password-protected exported file into your Control Room.</li></ul> <p><a href="#">Export bots</a> on page 2033   <a href="#">Import bots</a> on page 2035</p>

What's new
<p>New options in Git configuration (Service Cloud case ID: 00782957, 00837059, 00687394, 00783715, 00714059, 00659476, 00749755, 00786233, 00748166, 00776417)</p> <p>You can now perform the following actions for Git configuration:</p> <ul style="list-style-type: none"> <li>• Choose either the HTTPS or SSH authentication method to set up the Git configuration. The SSH authentication method is more secure as the authentication is based on a public and private key pair.</li> <li>• Specify the branch to which you want to push your Git commits. This helps with team coordination and workflow management.</li> <li>• Connect to your Git repository by using a proxy server.</li> </ul> <p><a href="#">Configure a remote Git repository in Control Room</a> on page 1824   <a href="#">Restore bots from Git repository</a> on page 1832</p>

## Automation Co-Pilot for Business Users

What's new
<p>Microsoft Edge Chromium and Safari supported for Automation Co-Pilot</p> <p>You can now create forms and processes in the Automation Workspace and run your requests, tasks, and bots in the web interface on Microsoft Edge Chromium and Safari browsers.</p> <p><a href="#">Browser requirements for Automation Workspace</a> on page 1210</p>
<p>Create password fields and hide sensitive information (Service Cloud case ID: 00714159, 01063512)</p> <p>In the Automation Workspace, you can now create password fields by using the <b>Password</b> element in your form builder. You can use the <b>Password</b> element in the web interface to add masked text to your password fields in the initial forms to hide sensitive information.</p> <p><a href="#">About Process Composer</a> on page 3419   <a href="#">Password element behavior</a> on page 3427</p>
<p>Reference ID enhancement to requests</p> <p>You can now view the reference ID associated with your process in the <b>Reference</b> column of the <b>Requests</b> page. The reference ID is a combination of a prefix and a number that is created from a <b>Process Key</b> that you can enter when you edit your process for the first time. This reference ID is incremented whenever a request is created from the corresponding process.</p> <p><a href="#">Reference ID properties</a> on page 3380   <a href="#">Configure a process</a> on page 3398</p>
<p>Cancelled status for tasks</p> <p>You can now filter tasks by the <b>Cancelled</b> status in the <b>Tasks</b> page. This status will show a <b>Cancelled</b> label next to the filtered results to inform you of the tasks that were cancelled by a user. You can filter by this status from the drop-down menu in the status bar.</p> <p><a href="#">Filter and search for a task</a> on page 3393</p>

What's new
<p>Fill initial form elements by URL parameters</p> <p>When you create a request, you can now fill initial form elements by creating query scripts that enter specific parameters in the initial form URL. These parameters are applicable only for <b>Date</b>, <b>Number</b>, <b>Text Box</b>, and <b>Time</b> elements.</p> <p><a href="#">Construct URL parameters for supported elements</a> on page 3426</p>
<p>Customize text in forms using updates to Label element</p> <p>You can now customize the text in your forms in various ways, such as applying bold, italic, underline, and other formatting effects, changing the font size and color, and so on, by using the <b>Label</b> element. With these options, you can highlight specific messages or texts, such as next steps, warnings, or errors, when they are rendered in the initial form in the web interface.</p> <p>The <b>Label</b> element now provides the following formatting options:</p> <ul style="list-style-type: none"> <li>• <b>Emphasis</b></li> <li>• <b>Font color</b></li> <li>• <b>Font size</b></li> <li>• <b>Text alignment</b></li> </ul> <p><a href="#">Using the Label element</a> on page 3444</p>
<p>Search and filter columns in a table</p> <p>On the form builder screen, if you select the <b>Enable column filtering</b> check box for the <b>Table</b> element, users can search and filter the content for all the available columns when the bot is running.</p> <p>When you use the <b>Table</b> element to render a table in your initial forms, you now have the enhanced ability to search each column of your table by value.</p> <p><a href="#">Using the Table element</a> on page 3451</p>

## Discovery Bot

What's new
<p>Save the recording with a name</p> <p>After recording a process, you can now save the recording with a name. The name of the recording is displayed on the <b>Recordings</b> page for that process.</p> <p><a href="#">Record a Discovery Bot business process</a> on page 3910</p>
<p>Share a description of the recording</p> <p>You can now provide a description for a recording of a process by using the <b>Recordings</b> page for that process. In the <b>Recordings</b> page, use the <b>Description</b> field to share the context and the purpose of the recording with the analyst. The description provided is also displayed in the PDD.</p> <p><a href="#">Record a Discovery Bot business process</a> on page 3910</p>

What's new	
Delete a recording	
<p>After you record a process, if you do not want to submit the recording data to an analyst for review, you can delete the recording by using the <b>Recordings</b> page for that process. In the <b>Recordings</b> page, use the <b>Delete</b> option to delete the recording.</p> <p><a href="#">Record a Discovery Bot business process</a> on page 3910</p>	
Record business processes using Automation Co-Pilot Desktop Assistant	
<p>You can now use Automation Co-Pilot Desktop Assistant to record business processes without signing in to the Control Room. To record a business process, start Automation Co-Pilot Desktop Assistant by double-clicking the Automation Co-Pilot icon on your desktop.</p> <p><a href="#">Record a Discovery Bot process using Automation Co-Pilot Desktop Assistant</a> on page 3914</p>	
Enhancements to custom opportunities	
<p>You can now update the potential cost and savings for custom opportunities and save your changes to the process diagram. The potential cost and potential savings can be updated at any time as you review the steps from various recordings and make changes within the process diagram.</p> <p><a href="#">Review opportunities, convert to bot, and generate PDD</a> on page 3916</p>	
Enhancement to PDD	
<p>You can now view the entire process diagram from within Discovery Bot by clicking the URL link provided in the PDD. The PDD does not display the process diagram if more than 100 steps are selected.</p> <p><a href="#">Review opportunities, convert to bot, and generate PDD</a> on page 3916</p>	

Fixes	
Service Cloud case ID	Description
--	In the Community Edition and Free Trial version, you can now create and delete five or more processes, and the autogeneration opportunity does not fail. You can create up to five opportunities.

## Automation 360 v.23 Community Edition Release Notes

Release date: 30 December 2021

Review what's new in the Community Edition of the Automation 360 v.23 (Build 11524) release. Build 11524 replaces Build 11513.

**Important:** Build 11524 includes a fix for the issue of frequent device disconnections caused by either high load or the database being locked.

## Automation Workspace

**Important:** This release includes a required update to your . Ensure that you complete the update to continue with your automation activities when upgrading from a previous release to this release.

[Automatically update the Bot Agent](#) on page 1361 | [Manually update the Bot Agent](#) on page 1362

To verify which version is compatible with this release, see [Compatibility with release builds](#) on page 1333.

What's new
<p>Microsoft Edge (Chromium) supported for Control Room and Bot Agent</p> <p>You can now perform Control Room operations, and install and register your Bot Agent device using the Microsoft Edge based on Chromium browser.</p> <p><a href="#">Browser requirements for Automation Workspace</a> on page 1210</p>
<p>Support to automate Microsoft Edge Chromium with Internet Explorer compatibility mode (Service Cloud case ID: 00767502, 00787186)</p> <p>You can now automate web applications running on Microsoft Edge Chromium, by enabling the Internet Explorer compatibility mode, using the Universal Recorder where the objects are captured using HTML technology.</p> <p><a href="#">Record a task with the Universal Recorder</a> on page 2240</p>
<p>Support for cross-domain IFrames in Google Chrome and Microsoft Edge Chromium browsers (Service Cloud case ID: 00825656)</p> <p>You can now capture and automate objects inside a cross-domain IFrame in Google Chrome and Microsoft Edge Chromium browsers by using <b>Recorder &gt; Capture</b> or the <b>Start recording</b> option. After you capture an object inside a cross-domain IFrame, the path to the frame is stored in the <b>FrameDOMXPath</b> property, by default.</p> <p>The new <b>FrameDOMXPath</b> property identifies the path to the frame in which the object is located. You must select this property to run the bot successfully to capture objects on a cross-domain IFrame.</p> <p><b>Note:</b> This feature is available for the bots you create using the 2.4.0-20211016-070100 version of the Recorder package starting from this release.</p> <p><a href="#">Recorder package</a> on page 2916</p>
<p>Support for Capture anchor in AISense Recorder</p> <p>The AISense Recorder now supports the <b>Capture Anchor</b> option. When you run a bot to search for an object in an application in which the anchor changes frequently, you can use <b>Capture anchor</b> to override the default anchor and manually select an anchor to detect the object.</p> <p><a href="#">Edit a task recorded using AISense</a> on page 2259</p>

What's new
<p>Enhanced support when selecting Object property in Recorder package</p> <p>After you capture an object using the <b>Recorder &gt; Capture</b> action, you can now select a particular object property name from the list of available properties in order to retrieve the value of the object property using the <b>Get property</b> action. The list includes suggested property names from the search criteria in the <b>Object Properties</b> table.</p> <p><a href="#">Recorder package</a> on page 2916</p>
<p>File ID supported in Check permission action of Google Drive package (Service Cloud case ID: 00777716)</p> <p>The <b>Check permission</b> action of the Google Drive package now supports the <b>File ID</b> option to refer to files available in the <code>Shared with me</code> folder of Google Drive. By providing the <b>File ID</b>, you can now verify the <b>Read</b>, <b>Write</b>, or <b>Delete</b> access granted to you in the <code>Shared with me</code> folder of the Google Drive files.</p> <p><a href="#">Google Drive package</a> on page 2694</p>
<p>New Credential package</p> <p>You can now use the <b>Assign</b> action in the Credential package to assign an insecure string or a variable directly to the credential variable.</p> <p><a href="#">Credential package</a> on page 2448</p>
<p>Web Services security supported in SOAP Web Service package (Service Cloud case ID: 00481836)</p> <p>As a Bot Creator, you can now provide credential variables in the raw data of the <b>SOAP Web service</b> action. You can create a credential variable, map the credential with a reference name in the credential mapper, and use the reference name in the raw data. Because this ensures that all security-related data can be defined in the Credential Vault and the credentials can be used in bots, you can safely deploy tasks without compromising security.</p> <p><a href="#">Example of using the SOAP web service action</a> on page 3240</p>
<p>New option in SOAP Web Service package</p> <p>Use the <b>Build Xpath</b> option in the SOAP Web Service package to extract values from the SOAP response. You can now specify the Xpath expression or select the appropriate node from the response body and store the output in a variable.</p>
<p>Read email from shared mailbox in Microsoft Outlook (Service Cloud case ID: 00728579, 00831622)</p> <p>To automate email-related tasks, you can now select a shared account in Microsoft Outlook so that email messages can be read from the shared mailbox.</p>

**What's new**

New encoding types supported in the Write to file action of Data Table package (Service Cloud case ID: 00767158)

When you use the **Write to file** action to write data from a Table type variable to a CSV or TXT file, you can now use the following encoding types from the encoding list:

- UTF-8: Works as UTF-8 without BOM
- UTF-8 with BOM (called UTF-8 previously)
- UTF-16LE
- Shift-JIS (Japanese encoding)

Auto-save functionality in Bot editor

In the Bot editor, when you use actions to build an automation, when a bot is not manually saved, an auto-save is performed and the bot now automatically saves the changes for specific events.

**Note:** The auto-save functionality is currently available only for specific events.

Some of the events that support auto-save functionality are as follows:

- Recorder: When you create a bot with certain actions and click **Recorder**, the event is saved, and when the recording is complete, the event is automatically saved.
- Variable manager: When you create or edit a variable to insert it in an action, the changes are saved.

**Note:** The auto-save functionality is not supported when you delete a variable or insert it by pressing F2 to open the variable list.

- Actions menu (vertical ellipsis): When you select any action from this menu, for example **Packages**, the event is saved automatically. When you make any change to the **Packages** page and return to the Bot editor, the event is saved.
- Find a file: When you click the **Find a file** icon, the bot is saved if it is not manually saved. Also, after you click the **Add** option, the bot is automatically saved.
- Dialog boxes: When a dialog box is opened, it is automatically saved if any changes are made.

**Note:** Auto-save is triggered only for top-level dialog boxes and not for nested dialog boxes.

- Deleting variables: When you delete unused variables, the event is saved.
- Bot name change: If you edit the name of a bot, the event is saved.

New option in FTP / SFTP package (Service Cloud case ID: 00792346)

Use the **Credential** option when you connect with the **Secure FTP** server type to automate a task. You can now use username and password for authentication.

[Connect action](#) on page 2620



What's new
<p>Enhancement to AI Sense Recorder</p> <p>AI Sense Recorder now supports automation of applications that use Brazilian-Portuguese and a combination of Brazilian-Portuguese and English interfaces.</p> <p><a href="#">AI Sense for recording tasks from remote applications</a> on page 2256</p>
<p>Enhancements to Number package</p> <ul style="list-style-type: none"><li>• In the <b>Random</b> action of the Number package, you can now specify and limit the number of decimal digits required in the random number generated in the output.</li><li>• The existing <b>Save the outcome to a number variable</b> field is now renamed as <b>Save the outcome to a variable</b>.</li></ul> <p><a href="#">Number package</a> on page 2802</p>
<p>Enhancements to Wait package</p> <p>Use the new <b>Capture region</b> feature in the <b>Wait for screen change</b> action of the Wait package to capture a specific region on an application by drawing a rectangle around it so that the bot automatically captures the coordinates of this region. You can perform the following actions:</p> <ul style="list-style-type: none"><li>• Capture a specific region on a Windows application.</li><li>• Preview the captured image in the <b>Preview</b> window.</li><li>• Recapture a region if the image in the <b>Preview</b> window is not per user requirement.</li></ul> <p>The coordinates are renamed as follows:</p> <ul style="list-style-type: none"><li>• <b>Left</b> is now <b>X</b></li><li>• <b>Top</b> is now <b>Y</b></li><li>• <b>Right</b> is now <b>Width</b></li><li>• <b>Bottom</b> is now <b>Height</b></li></ul> <p><a href="#">Using Wait for screen change action</a> on page 3157</p>
<p>Enhancement to String package</p> <p>In the <b>Extract text</b> action of the String package, you can now extract a substring from a specified source string that occurs more than 1000 times in a file and up to a maximum limit of 999999.</p>
<p>Enhancement to File conditions in If package</p> <p>You can now use the new <b>File extension</b> condition from the <b>Condition</b> list in the <b>If</b> package to check the extensions of files and then execute actions based on the results.</p>
<p>Enhancement to Excel advanced package (Service Cloud case ID: 00799071)</p> <p>Use the <b>Open</b> action of the Excel advanced package to open files with <b>.ods</b>, <b>.htm</b>, <b>.html</b>, <b>.mht</b>, <b>.mhtml</b>, <b>.slk</b>, and <b>.pdf</b> extensions.</p> <p><a href="#">Excel advanced package</a> on page 2565</p>

What's new
<p>Global session support for loop iterator based on Excel advanced</p> <p>You can now use the <b>Global session</b> option when you loop through each row in an Excel advanced worksheet. Use the <b>Global session</b> option to share a Microsoft Excel session across multiple bots so that you can use the same Excel worksheet across these bots.</p> <p><a href="#">Using the Open action for Excel advanced</a> on page 2571</p>
<p>New APIs for devices</p> <p>You can now allocate default devices by using the new APIs introduced in the v1/ <b>Devices</b> section. Choose to set or not set a specific device as the default deployment device for a specified user by using the following APIs respectively:</p> <ul style="list-style-type: none"> <li>• <code>/runasusers/default</code></li> <li>• <code>/runasusers/default/unset</code></li> </ul>

## Automation Co-Pilot for Business Users

What's new
<p>New query filter in Query Requests and Query Tasks actions</p> <p>Use the new filter now available in the <b>Query Requests</b> and <b>Query Tasks</b> actions of the <b>AARI Web</b> package to filter query requests and tasks by team name in the Automation Co-Pilot web interface.</p>
<p>Team name filter</p> <p>You can filter your tasks and requests by team name in the <b>Task</b> and <b>Request</b> pages in the web interface, respectively. Select the <b>Team</b> label from the filter and search by team name to view the teams assigned to a task or request.</p> <p><a href="#">Filter and search for a request</a> on page 3391   <a href="#">Filter and search for a task</a> on page 3393</p>
<p>Support for audit logs (Service Cloud case ID: 00801166)</p> <p>You can now view the audit logs and refer to events relating to requests, teams, scheduler, process setups, bot setups, human tasks, and bot tasks that you have created, deleted, updated, submitted, or recovered.</p> <p><a href="#">Audit log</a> on page 2143</p>

**What's new**

## Enhancement to user task assignment in Human Task

In the process editor, the **Auto-assign this task** option in **Human Task** provides the following alternatives:

- **The user who created the request:** The task is automatically assigned to the user creating the request in the web interface.
- **The user who opens this task:** The task is automatically assigned to the user who opens the task in the web interface.

This feature helps to reduce conflicts in assigning a task to oneself, particularly in case of specialized users such as Validator for whom the action of opening a task is equivalent to assigning the task to oneself.

## Enhancement to team setup

You can now simultaneously add multiple users with similar roles (custom role) to the Automation Co-Pilot team in the web interface. The custom role in the Control Room is now aligned with a team in the Automation Co-Pilot web interface, and the enhanced team setup works as follows:

- The users added with the role are assigned a **Member** role in the team. The role cannot be changed to **Owner** or **Admin**.
- You cannot view these users in the **Users** tab of the **Team** page.
- If a user is both part of a role and added manually to the team, their role in the team will be the same as the role assigned to them manually. For example, if a user is a member, they will continue to have the **Member** role whereas if the user is an owner, they will be assigned the **Owner** role in the team.
- If the user is no longer part of a role, the user will also not be a part of the team.

Also, the **Team** page is now enhanced with navigation options at the top so that you can navigate through the various tabs (**General**, **Users**, **Roles**, **Processes**, and **Bots**). Use the **General**, **Users**, and **Roles** tabs to create teams and add users to them. The **Processes** and **Bots** tabs display the processes and bots assigned to teams, respectively.

[Team management](#) on page 3377 | [Create a team and assign roles to team members](#) on page 3387

## Bot setup support

The Automation Co-Pilot Admin can use the **Bot Setup** page to view the bots that are assigned to a team, assign teams to a bot, and edit bots to remove or reassign teams. Attended Bot Runners who can view all the bots that are checked in to the **Public** workspace can now view the bots that are assigned to teams in Automation Co-Pilot Desktop Assistant.

[Bot setup for Bot Runner users](#) on page 3390

## Enhancement to the form logo

You can now use the **Logos in footer** field to select up to two separate logos that are displayed in the footer of the form during bot runtime.

**What's new**

Add rules to various form elements

When you are creating or editing a form in the form builder, you can now add rules to the following form elements by using the **Form rules** tab:

- **Checkbox**
- **Date**
- **Document**
- **Dropdown**
- **Label**
- **Number**
- **Password**
- **Radio Button**
- **Rich Text Editor**
- **Text Area**
- **Text Box**
- **Time**

For the **Checkbox** and **Radio Button** elements, the rules are triggered only if the corresponding presets are selected. For example, if a form has two mutually exclusive options, such as **Yes** and **No**, the rules associated with these options are triggered only when you select one of the two options.

[Conditional actions, rules, and elements](#) on page 3428

**What's new**

Updates to triggers

The following triggers are now available to run a bot:

- **Process trigger:** Starts a bot when the status of the specified process in Microsoft Windows meets one of the following preset conditions:

- **Starts**
- **Stops**

[Add a process trigger](#) on page 2296

- **Service trigger:** Starts a bot when the status of the specified service in Microsoft Windows meets one of the following preset conditions:

- **Starts**
- **Stops**
- **Resumes**
- **Pauses**
- **Is running**
- **Has stopped**
- **Is paused**

[Add a service trigger](#) on page 2297

- **Window trigger:** Starts a bot when the specified application window meets one of the following preset conditions:

- **Opens**
- **Closes**

[Add a window trigger](#) on page 2298

## Discovery Bot

**What's new**

Install Bot Agent seamlessly

If you have not already installed the Bot Agent, you are now prompted to install the Bot Agent from the **Processes** tab. Follow the screen instructions to install the Bot Agent. After the installation, you are prompted to enable a Chrome plug-in in order to proceed with your recording tasks.

[Prerequisites for Discovery Bot](#) on page 3896

What's new
<p>Enhancement to auto-generated opportunities</p> <p>You can now begin reviewing an auto-generated opportunity from the <b>Opportunities</b> tab when at least one process recording is submitted for review. Review the auto-generated opportunity and choose to create a custom opportunity from an auto-generated opportunity, as required.</p> <p><a href="#">Review opportunities, convert to bot, and generate PDD</a> on page 3916</p>
<p>New recordings for review for custom opportunity</p> <p>You can now review new recordings submitted by a Discovery Bot user for a custom opportunity. You can choose to accept or dismiss the recording updates as part of the custom opportunity work flow. This option allows you to quickly and easily review new recordings in real time as the recordings are submitted by the user for that process.</p> <p><a href="#">Review opportunities, convert to bot, and generate PDD</a> on page 3916</p>
<p>Enhancements to Opportunities page</p> <p>The opportunities page is now updated to include an opportunities evolution map, along with other graphs, to help you review and analyze data for a potential opportunity for automation. Use the opportunities evolution map to help guide you on which opportunities to automate first.</p> <p><a href="#">Analyzing opportunities for automation</a> on page 3915</p>
<p>Download PDD document from the Recordings page</p> <p>You can now download and export a PDD document from the <b>Recordings</b> page. After you submit a recording for an analyst to review, the PDD begins processing in the background automatically. When the PDD is generated, the field changes from Processing PDD to <b>Download</b>. You can now choose to download the document in Word format, PDF, or both. An email notification to the business user is also sent to the email address on file. The Download PDD for Word or PDF document is also available for a custom opportunity from the Opportunities list table.</p> <p><a href="#">Review opportunities, convert to bot, and generate PDD</a> on page 3916</p>
Limitations
<p>In the Community Edition and Free Trial version, if five processes are created by the user and then deleted, the auto-generated opportunity will fail when the recording is submitted for the sixth process.</p> <p>Workaround: Create a new Community Edition and Free Trial user to create new processes and opportunities.</p>

## IQ Bot

What's new
<p>Document Automation released in Community Edition</p> <p>Community Edition now offers limited features from the Document Automation version. This version is integrated with the Community Control Room. When you create a learning instance, IQ Bot automatically creates RPA bots to extract and download the data and an Automation Co-Pilot process to manage the end-to-end process. Validation now takes place in Automation Co-Pilot tasks.</p> <p>Use IQ Bot Community Edition to extract data from invoices in English.</p> <p><a href="#">Document Automation Community Edition</a> on page 3724</p>
<p>Classifier enhancements</p> <p>You can now create custom document groups in a learning instance. This reduces the possibility of an OCR failing to detect fields in a document, which will cause the Classifier to create a document group unnecessarily or send the document to a wrong group.</p> <p><a href="#">About the Classifier</a> on page 3743</p>

## Automation 360 v.22 Community Edition Release Notes

Release date: 15 September 2021

Review the new features in the Community Edition of the Automation 360 v.22 (Build 10535) release.

## Automation Workspace

What's new
<p>Introducing Text file package</p> <p>A new Text file package is now available and includes the <b>Get text</b> action. Use this action to extract text from files that have Japanese characters with Shift-JIS encoding and then save the content in the files to a string variable.</p> <p><a href="#">Text file package</a> on page 3134</p>
<p>Share session across bots</p> <p>Share a DLL, Excel, and Terminal Emulator session across multiple bots using the <b>Global session</b> option. You can also share a session with specific child bots using the <b>Variable</b> option and share a session with only the current bot using the <b>Local session</b> option.</p> <p><a href="#">Sharing sessions across bots</a> on page 2503</p>

What's new
<p>Enhancement to AISense Recorder</p> <p>AISense Recorder now enables automation of applications that use Russian and a combination of Russian and English interfaces.</p> <p><a href="#">AISense for recording tasks from remote applications</a> on page 2256</p>
<p>Enhancements to recorder conditions for packages</p> <ul style="list-style-type: none"> <li>Use the new <b>Object does not exist</b> condition from the Condition list of any package to verify whether a specific object in a window exists and then execute actions based on the result.</li> </ul> <p>This condition works with SAP technology as well.</p> <ul style="list-style-type: none"> <li>The existing <b>Object</b> condition is now renamed as <b>Object exists</b>.</li> </ul> <p><a href="#">Loop package</a> on page 2784</p>
<p>Enhancements to Excel advanced package</p> <ul style="list-style-type: none"> <li>Open files with <code>.xml</code> and <code>.txt</code> extensions using the <b>Open</b> action.</li> <li>Use the wildcard character (*) in the <b>Open</b> action for file names to search based on the wildcard pattern.</li> <li>When you use the <b>Run macro</b> action and specify an argument that has a blank value, this blank value can now be passed to the macro.</li> </ul>
<p>New option in Database: Disconnect action</p> <p>In the <b>Database: Disconnect</b> action, you can now use the <b>Keep database schema in cache until bot finishes running</b> option to enable the <b>Loop</b> action to iterate the dataset by using cached schema after disconnecting from the database.</p>
<p>Use regular expressions in File &gt; Open action (Service Cloud case ID: 00737614)</p> <p>Use regular expressions (regex) in the <b>Open</b> action of the File package to support pattern-based search.</p>
<p>Specify timeout for bots (Service Cloud case ID: 00667049, 00690892, 00699158, 00706491, 00739420, 00739415, 00741590, 00769795)</p> <p>You can now specify the amount of time by which the execution of a bot must be completed. The system stops the bot execution if it is not completed within the time you specified.</p> <p><a href="#">Configure timeout for bot execution</a> on page 2324</p>
<p>New Exchange version supported in Email package</p> <p>In the Email package, when you choose an <b>EWS</b> server to establish a connection, you can now use the <b>Exchange2013</b> option in the <b>Exchange Version</b> field.</p>



What's new
<p>New actions in Window package</p> <ul style="list-style-type: none"> <li>• Use the <b>Close all</b> action to close all windows or programs running on the system, except the windows added in the <b>Add window</b> field.</li> <li>• Use the <b>Restore</b> action to restore the size of a maximized or a minimized window or application running on the system.</li> </ul> <p><a href="#">Window package</a> on page 3174</p>
<p>New option to search text within bot content in Bot editor (Service Cloud case ID: 00735685, 00736201, 00739122, 00740481, 00733885, 00748970, 00746459, 00738181,00756441,00759037,00761453,00764478)</p> <p>In the Bot editor, use the search box in the Flow, List, or Dual view to search for text, variables, or actions in the entire bot content such as package name, action name, string name, or variable name. This feature helps you to view or edit a bot with long code lines to determine where the searched text, such as variables, strings, or actions, is used and in which line.</p> <p><a href="#">Actions to build bots</a> on page 2363</p>
<p>Enhanced support for SOAP Web Service URI (Service Cloud case ID: 00759811)</p> <p>In the SOAP Web Service package, if the input to the <b>Address location</b> field is empty, the bot now retrieves the address location from the WSDL file.</p>
<p>New option in SOAP Web Service package</p> <p>Use the <b>Build SOAP request</b> option in the SOAP Web Service package to retrieve SOAP request details from the SOAP URI or the WSDL file. You can now select any operations from the list of services and ports available in the SOAP Request to automatically populate data in the fields of the SOAP Web Service action.</p> <p><a href="#">Example of using the SOAP web service action</a> on page 3240</p>
<p>TNS name supported for Oracle Database connection</p> <p>TNS (Transparent Network Substrate) name is now supported in the Oracle Database. You can connect to the Oracle Database by specifying the TNS name and path of the <code>tnsnames.ora</code> configuration file.</p>
<p>Wait time option in Google Sheets package (Service Cloud case ID: 00738249, 00817449, 00814775)</p> <p>When you use the <b>Connect</b> in the action in the Google Sheets package to establish a connection with the Google server, you can now set a wait time in the <b>Wait for actions to complete</b> field when performing actions such as <b>Get</b>, <b>Set</b>, or <b>Delete</b>. For example, if you have a large file that takes a long time to open, you can now set the wait time for the file to open before the system executes the next set of actions.</p>
<p>New option for Put action in Dictionary package</p> <p>You can now assign a static value to a key for a dictionary variable by using the <b>Static value</b> option in the <b>Put</b> action in the Dictionary package.</p> <p><a href="#">Dictionary package</a> on page 2493</p>

**What's new**

Relative click and occurrence supported in packages (Service Cloud case ID: 0055643,00754173)

When you capture a target image using the Image Recognition package, you can now use the **Preview** option to select a specific captured occurrence and position your click location relative to the image.

The feature is supported in the following packages and actions:

- Image Recognition > Find image in window
- Image Recognition > Find window in window
- If > Image Recognition condition
- Loop > While > Image Recognition condition
- Wait for condition action > Image Recognition condition

[Using Find image in window action](#) on page 2732|[Using the Find window in window action](#) on page 2735

Enhancements to execution type key in AATaskExecutor variable

- When you schedule a bot to run, the `Execution_Type` key in the AATaskExecutor variable now returns information about the execution type with schedule type (frequency) such as `Run as schedule Daily`, `Run as schedule Weekly`, or `Run as schedule Monthly`.
- When you use a trigger in a bot, the `Execution_Type` key can be accessed through the trigger data. The `Execution_Type` key returns the `Run through Trigger` as a string for triggers.

Language support for variable names

Variable names now support Greek and Japanese languages. You can now create variable names using the following characters:

- Greek uppercase and lowercase characters
- Japanese Katakana full-width and half-width characters.

New option in REST Web Service (Service Cloud case ID: 00764198, 00800287)

In the REST Web Service package, you can now use the **Allow insecure connection when using https** option to skip SSL certificate validation and to allow non-secure connections.

Work item ID and time filters for workload automations

Combine the work item ID and start time of a queue to search for specific work items and monitor the progress of these work items. The start time filters the list of all work items that start between specified start date and start time.

[Actions allowed on view queue page](#) on page 2016

What's new
<p>Enhancements to the bot structure</p> <p>We have enhanced the overall readability of the bot structure and updated the node labels of the bot to show selected properties and parameters of each action in detail in the Flow, List, and Dual views. You no longer have to expand each action to view these details.</p> <p>The Flow, List, and Dual views display the following properties of actions:</p> <ul style="list-style-type: none"> <li>• The value you enter for actions such as <b>Set text</b> for all supported technologies</li> <li>• Names of objects on which actions such as <b>Set text</b>, <b>Click</b>, <b>Left click</b>, <b>Get property</b>, and <b>Select item by index</b> are performed</li> <li>• Name of the object property mentioned in the action</li> <li>• Name of the return variable if some value is assigned to a variable</li> <li>• List of properties for the <b>Get property</b> action</li> </ul>
<p>Java applications supported in App integration package</p> <p>The App integration package now supports Java applications that are based on the Standard Widget Toolkit and Abstract Window Toolkit, which can draw text using Windows text-drawing APIs.</p>
<p>Direct download support in Bot Store</p> <p>Users who cannot connect their Control Room to the internet can now directly download Automation 360 bots and packages locally from Bot Store and then import them to their Control Room.</p> <p><a href="#">Download locally and import bots and packages from Bot Store to Control Room</a> on page 3611</p>

## Automation Co-Pilot for Business Users

What's new
<p>Select File element input supported for Create a Request action</p> <p>The <b>Create a Request</b> action in the AARI Web package now supports passing input in the request creation forms for the <b>Select File</b> element. You can now use bots to create a request and upload or download files as input with the <b>Select File</b> element. These input files are uploaded to the storage service to be available for further processing in the request.</p>
<p>Output variables support in Process Editor</p> <p>The <b>Output variables</b> section in the process editor enables you to create a user-defined variable that can be set as an output to any process. This helps you pass the output from the child (sub) process, which was called in the <b>Process Task</b>, to the parent (main) process.</p> <p><a href="#">Display child process automation output</a> on page 3490</p>

**What's new**

## Detail view in Tasks page

The new **Detail view** option in the **Tasks** page provides better insight into individual tasks for better task management. The detail view previews each task in its respective request view page without opening another page, which helps organize and correspond your tasks with the available requests. Users can interact with their tasks as well.

**Discovery Bot****What's new**

## View Groups of steps

When reviewing a process view, you can now use the group option or icon to display groups of steps that belong to the primary level action and secondary level action (and subgroup level actions) used during the recording session.

Use the group icon to help you decide what groups of steps to select for a task you want to automate. For example, a primary level action displays Microsoft Outlook, a secondary level action displays Outlook mail notification, and subgroup level actions display terms such as Email -Add To, Email – Add Subject.

[Create a process view with branches and opportunities](#)

## Use Dynamic option for system-generated views

You can now use the **Dynamic** option from the Model options to view recordings where groups of steps display a set of repeating patterns that belong to the same application or same primary level action used during the recording session.

Use this option to decide the context of the process or the task you want to automate. Groups of steps that are labeled belong to supported applications such as Microsoft (Excel, Outlook, and Notepad), Notepad++, text editors, most windows use cases, and Chrome browser functionality.

[Create a process view with branches and opportunities](#)

## Enhancements to PDD Word document

The PDD Word document now includes a process recording flow chart and the time on each individual step in hours, minutes, and seconds.

[Review opportunities and convert to](#)

**Automation 360 v.21 Community Edition Release Notes**

Release date: 02 June 2021

Review the new features in the Community Edition of the Automation 360 v.21 (Build 9664) release.

- [Automation Workspace](#) on page 805
- [AARI](#)

- [Discovery Bot](#) on page 809

## Automation Workspace

**Important:** This release includes a required update to your . Ensure that you complete the update to continue with your automation activities when upgrading from a previous release to this release.

[Automatically update the Bot Agent](#) on page 1361 | [Manually update the Bot Agent](#) on page 1362

To verify which version is compatible with this release, see [Compatibility with release builds](#) on page 1333.

New features
<p>Automation 360 navigation enhancements</p> <p>We have enhanced the overall readability and accessibility of the Automation 360 interface. To make navigation easier, menus and views are organized based on frequently used features and related tasks.</p> <p>The interface includes the following updates:</p> <ul style="list-style-type: none"> <li>• The Device, Profile, and Help icons are now located at the bottom of the navigation menu, consolidating all controls on the left for easy access.</li> </ul> <p>When you click these icons, flyout panels of content and actions are shown.</p> <ul style="list-style-type: none"> <li>• The side navigation menu can be collapsed to a slim bar to maximize the main workspace area.</li> </ul> <p>You can continue to use the side navigation in collapsed mode, with flyouts for each section.</p> <p><a href="#">Automation 360 navigation updates</a></p>
<p>Deploy workload automation on a multi-user Windows terminal server</p> <p>To optimize workload automation and multi-user devices, you can deploy workload automations on a multi-user Windows terminal server so that a single device can process multiple work items concurrently.</p> <p><a href="#">About multi-user devices</a> on page 1876   <a href="#">About device pools</a> on page 1881</p>
<p>New actions in the SAP BAPI package</p> <p>Use the following new actions:</p> <ul style="list-style-type: none"> <li>• <b>Run standard workflow:</b> Runs a standard workflow in SAP BAPI.</li> <li>• <b>Run custom workflow:</b> Runs a custom workflow in SAP BAPI.</li> </ul> <p><a href="#">SAP BAPI package</a> on page 3003</p>

New features
<p>New actions in File package</p> <p>Use the following new actions:</p> <ul style="list-style-type: none"><li>• <b>Get name:</b> Reads a file name and stores it to a string.</li><li>• <b>Get path:</b> Reads the path of the file and stores it to a string.</li></ul> <p><a href="#">File package</a> on page 2600</p>
<p>Common table expression supported in Database package</p> <p>You can now use common table expression (CTE) in the <b>Read from</b> action using the <b>WITH</b> keyword in SQL-compliant databases such as Oracle and MySQL. Use CTE statements within a SQL query to simplify complex joins and subqueries.</p> <p><a href="#">Using the Read from action</a> on page 2475</p>
<p>Support for large numbers in Number package (Service Cloud case ID:00557619)</p> <p>You can now perform mathematical operations for large numbers with more precision in the Number package.</p> <p><a href="#">Number package</a> on page 2802</p>
<p>Snowflake database support using ODBC driver (Service Cloud case ID:00761695)</p> <p>Snowflake ODBC driver is now supported in the Database package. You can connect to the Snowflake database using ODBC-based client applications.</p> <p>The following actions support this feature:</p> <ul style="list-style-type: none"><li>• Connect</li><li>• Disconnect</li><li>• Read from</li><li>• Export to data table</li><li>• Insert/Update/Delete</li></ul>
<p>Variables: new features and enhancements (Service Cloud Case ID:00740585)</p> <ul style="list-style-type: none"><li>• Edit the variable name after the variable is created.</li><li>• Delete all or a specific selection of unused variables from a bot.</li></ul>
<p>Universal Recorder new features and enhancements</p> <ul style="list-style-type: none"><li>• Record object interactions in applications built on the Electron framework.</li><li>• Perform double-click in all supported applications and browsers.</li></ul>
<p>Limit credential attribute use to password fields only (Service Cloud Case ID:00740585)</p> <p>When you create or edit a credential attribute, ensure that bots input the attribute value only in fields that are identified as password fields by selecting the <b>Set this attribute as a password</b> option.</p>

New features
<p>Default names for output variables</p> <p>When you configure an output variable for the actions in the Error handler and Python Script packages, the Control Room automatically generates a descriptive default variable name. If you create more than one output variable for an action, the subsequent variable names are appended with a -1, -2, -3, and so on to avoid a variable name conflict.</p>
<p>New string action to support nested variables</p> <p>Use the <b>String &gt; Evaluate value</b> action to compare a user-specified string variable with the string variables in the bot. If a match is found, the action returns the value of the matching variable.</p> <p><a href="#">String package</a> on page 3086</p>
<p>Delete Global values</p> <p>A user with the <b>AAE_Admin</b> role can delete a global value from the <b>All global values</b> page.</p> <p><a href="#">Global values</a> on page 2350</p>
<p>ODBC driver support for all connection strings (Service Cloud Case ID: 00748887, 00777676)</p> <p>An Open Database Connectivity (ODBC) driver is now available to support all the ODBC connection strings in the same way it was used in the Enterprise 11 version. Using SQL as a standard for accessing and managing data, you can connect to MySQL, Google BigQuery, Snowflake, and other databases using the ODBC driver.</p>
<p>Share a DLL session</p> <p>You can now share a DLL session between bots.</p>

## Automation Co-Pilot for Business Users

New features
<p>Download, delete, or view files in browser in initial forms or tasks</p> <p>Users can now use the <b>Select File</b> element to download files that are uploaded to the initial forms or tasks, and they can also delete files or access the hyperlink file to view the file in within the browser. The uploaded file can be accessed as a hyperlink, and new icons are available for download and delete.</p>

New features
<p>Enhancement to team roles</p> <p>The Automation Co-Pilot team consists of three roles:</p> <ul style="list-style-type: none"><li>• Member: Can create, view, and delete their own requests. All the tasks are automatically assigned to the member when they create the request in a private team. In a shared team, the member can assign tasks to other members.</li><li>• Owner: Can create, view, delete, and assign all the requests from the members in the team.</li><li>• Admin: Can create, view delete, and assign all the requests from the members in the team. The admin can also modify the team.</li></ul> <p>An Automation Co-Pilot admin or manager can edit their teams and update their team members' roles. They also have the option to add or remove team members. The Automation Co-Pilot manager is the team admin by default when they create a team.</p>
<p>Assign to me feature in tasks</p> <p>When a task is unassigned and users access the tasks, use the <b>Assign to me</b> option to allow the tasks to be assigned to the current user so that they can immediately access the form.</p> <p><a href="#">Assign or unassign a task</a> on page 3390</p>
<p>New Bot page</p> <p>When Automation Co-Pilot team members with attended Bot Runner licenses access the web interface, they are automatically redirected to Automation Co-Pilot Desktop Assistant. Users can view all the bots created by them on this page. They can also pin, search, and sort their assigned bots.</p>
<p>New team reference in Request and Process pages</p> <p>The user can now reference the team from which a request is created by referring to the new <b>Team</b> column in the <b>Request</b> page or the team name added in the process tile in the <b>Process</b> page, to help guide their team assignment.</p>
<p>New Request Visibility field (Service Cloud case ID: 00718119)</p> <p>Request visibility enables users to allow or restrict access to a request they created to other team members. When the <b>Request Visibility</b> field is set to <b>Shared</b>, all the requests are accessible by all members, owners, and team admins. If the field is set to <b>Private</b>, the requests are available only to the user who has created the request, owner, and the team admin.</p>
<p>Enhancement to the Processes page</p> <p>The following enhancements are available on the <b>Processes</b> page:</p> <ul style="list-style-type: none"><li>• Sort the processes by name, in ascending or descending order.</li><li>• Toggle the pinning of a process.</li><li>• Use the responsive view to adjust the display to the screen size.</li></ul>



New features
<p>Automation Co-Pilot Desktop Assistant for attended Bot Runners</p> <p>The Automation Co-Pilot Desktop Assistant application enables users with the attended Bot Runner license to access their bots without logging in to the Control Room. Automation Co-Pilot web users can use the Automation Co-Pilot Desktop Assistant when the attended Bot Runner license is enabled along with their Automation Co-Pilot User license without impacting their existing functionality.</p> <p><a href="#">Automation Co-Pilot Desktop Assistant</a> on page 3361</p>
<p>Add rows from header row context menu</p> <p>Only the header row is displayed when a form that has a table is launched during bot runtime. Use one of the following methods to add new rows to the table:</p> <ul style="list-style-type: none"> <li>Header row context menu of the table <ul style="list-style-type: none"> <li><a href="#">Using the Table element</a> on page 3451</li> </ul> </li> <li>The <b>Set</b> action in a bot <ul style="list-style-type: none"> <li><a href="#">Set action</a> on page 3079</li> </ul> </li> </ul>

## Discovery Bot

New features
<p>Sort for a process tile from the Processes page</p> <p>You can now use the sort field to help you locate a process tile quickly. From the <b>Processes</b> page, use the drop-down menu to sort on a process tile based on the process name in alphabetical order. Alternatively, you can sort in the order of the newest process created to the oldest process and vice versa.</p> <p><a href="#">Create a Discovery Bot process</a> on page 3905</p>
<p>Enhancements to opportunities</p> <p>You can now review and analyze automatically generated (or system-generated) opportunities immediately from the <b>Opportunities</b> page. Auto-generated opportunities are created when at least two recordings are approved by the user. You can create a custom opportunity from an auto-generated opportunity and apply the <b>Model</b> and <b>Filter</b> options to target a specific opportunity for automation.</p> <p>You can now prioritize opportunities based on a simple formula for all recordings in a process. From the Opportunities table, you can view the cost without automation and savings for an opportunity. The system automatically calculates the cost and potential savings for each opportunity generated. You can customize these metrics based on your organization's model for cost and savings.</p> <p><a href="#">Review opportunities and convert to</a></p>

**New features**

Generated PDD files are available on your local server

The generated PDD file for an opportunity is now stored locally on your server for On-Premises deployments. The existing PDD files are automatically moved to the new location and are not deleted when a re-installation or update is performed in the Control Room.

[Prerequisites for Discovery Bot](#) on page 3896

## Community Edition A2019.20 Release Notes

Release date: 14 April 2021

Review the new features in the Community Edition A2019.20 release (Build 8846).

- [Community Edition](#)
- [AARI](#)
- [Discovery Bot](#) on page 814
- [Bot Insight](#) on page 815

### Community Edition

**Important:** This release includes a required update to your . Ensure that you complete the update to continue with your automation activities when upgrading from a previous release to this release.

[Automatically update the Bot Agent](#) on page 1361 | [Manually update the Bot Agent](#) on page 1362

To verify which version is compatible with this release, see [Compatibility with release builds](#) on page 1333.

**What's new**

Automate SAP-related tasks using SAP BAPI

Use the actions available in the SAP BAPI package to automate SAP-related tasks using SAP BAPI.

[SAP BAPI package](#) on page 3003

What's new
<p>Default names for output variables</p> <p>When you configure an output variable for the following packages, the Control Room shows a descriptive default variable name. If you create several output variables, subsequent variable names are appended with a -1, -2, -3, and so on to avoid duplication.</p> <ul style="list-style-type: none"><li>• Browser</li><li>• CSV/TXT</li><li>• Email</li><li>• Excel advanced</li><li>• JavaScript</li><li>• Loop</li><li>• Recorder</li><li>• VBScript</li><li>• Window</li></ul>
<p>PDF split with blank pages supports scanned image documents (Service Cloud case ID: 00683923)</p> <p>Use the PDF <b>Split</b> action to separate a blank page from pages with scanned images. With pixel-based split, you can now use <b>Split document</b> to split a PDF with blank page separators for scanned (image-based) documents.</p>
<p>SMTP port range expanded to include ports 1 through 65535</p> <p>The Email package now supports ports in the range of 1 through 65535 for the SMTP server. You can use the <b>Send</b> email action by configuring the SMTP port in this range.</p>
<p>New actions in the Active Directory package</p> <ul style="list-style-type: none"><li>• <b>Update account options:</b> Sets account attributes for the user.</li><li>• <b>Change user password:</b> Use this option to change a user's password.</li></ul> <p><a href="#">User account operations</a> on page 2384</p>
<p>Enhancement to Create user action in Active Directory package</p> <p>You can now use the <b>Create user</b> action to create an Active Directory user with password.</p> <p><a href="#">Using the Create user action</a> on page 2386</p>
<p>Universal Recorder expanded support and new features</p> <p>Use the Universal Recorder to perform the following:</p> <ul style="list-style-type: none"><li>• Automate clicks and data retrieval in drop-down lists and combo boxes in Oracle EBS applications such as Compass.</li><li>• Link an object that the bot cannot reliably identify to a nearby object (such as a link or button) that is easier for the bot to find. Use this feature in MSAA, UI Automation, or Java applications.</li></ul>

What's new
<p>Support for new languages in variable names</p> <p>You can now use Czech, Danish, Dutch, Finnish, French, German, Hungarian, Italian, Norwegian, Polish, Portuguese, Romanian, Spanish, and Swedish characters in variable names.</p> <p><a href="#">Unicode range supported in variables</a> on page 2341</p>
<p>Search and add child bot in the parent bot</p> <p>Search for a child bot in the public and private workspaces so that you can add it in the parent bot. You can search for the child bot from the Bot editor and the <b>Run</b> action of the Task Bot package.</p> <p><a href="#">Using the Run action</a> on page 3111   <a href="#">Bot editor for creating bots</a> on page 2228</p>
<p>Obtain information about user that deployed the bot</p> <p>Use the AATaskInvoker system variable to return the username, first name, last name, and email of the user that ran or scheduled the bot. If the bot is deployed to an attended Bot Runner, this variable returns information about the logged-in user. If the bot is deployed by a trigger, this variable returns information about the user who set the trigger.</p> <p><a href="#">System settings and parameters</a> on page 2329</p>
<p>New condition in If package (Service Cloud case ID: 00536088, 00690073,00717514, 00737243, 00702383)</p> <p>Use the new <b>Window with same title does not exist</b> or <b>Window with same title exist</b> condition available in the If package to verify whether a window with the same title exists or whether the window title has changed.</p> <p><a href="#">If package</a> on page 2724</p>
<p>Google packages are now generally available</p> <p>Google Calendar, Google Drive, and Google Sheets packages are now generally available in Automation 360, and contain these new actions:</p> <ul style="list-style-type: none"><li>• <b>Write from data table</b> and <b>Insert row/column</b> actions in the Google Sheets package.</li><li>• Each Google package contains a <b>Connect</b> action to authenticate your account before adding other actions from that package to your automation. This action replaces the deprecated <b>OAuth</b> action from the G-Apps package.</li><li>• Each Google package contains a <b>Disconnect</b> action to terminate the connection.</li></ul> <p><a href="#">Connect action for Google packages</a> on page 2717</p>

## Automation Co-Pilot for Business Users (Automation Co-Pilot)

What's new
<p>Get Storage file action</p> <p>The new <b>Get Storage file</b> action in the Automation Co-Pilot Web package enables you to download storage files to a bot device.</p> <p><a href="#">Process Composer package</a> on page 2893</p>
<p>Upload files in initial forms or tasks</p> <p>Add the <b>Select File</b> element to forms to enable users to select and upload files in the initial forms or tasks in the web interface. Users can browse to upload a new file or replace an existing file. The uploaded file is shown as a hyperlink and redirects users to a new tab when opened.</p> <p><a href="#">About Process Composer</a> on page 3419</p>
<p>Hyperlinks support for initial forms or tasks</p> <p>Use the new <b>Hyperlink</b> element to add links to forms and access them in initial forms and tasks.</p> <p><a href="#">About Process Composer</a> on page 3419</p>
<p>Configure a scheduler user for each process (Service Cloud case ID: 00713786)</p> <p>As an Automation Co-Pilot administrator, you can now configure a scheduler user for each process to allocate the Control Room resources (devices and unattended Bot Runners) on the web interface. By default, the <b>Global scheduler</b> user is selected if a scheduler user is not configured for individual processes.</p> <p><a href="#">Configure scheduler user for Automation Co-Pilot</a> on page 3413</p>
<p>Update to properties panel for human task (Service Cloud case ID: 00718109)</p> <p>As a Bot Creator, you can choose to not configure any actions in the human task by selecting the <b>Make the form read-only</b> check box in the <b>Properties</b> panel. The human task does not require any input and it is executed automatically to the next task.</p>
<p>Bookmark any page as landing page for Automation Co-Pilot on the web</p> <p>The web interface is now enhanced to a new multiple page system so that you can directly bookmark any page (<b>Requests</b>, <b>Tasks</b>, or <b>Recycle Bin</b>) as your landing page. Also, the tabs in the web interface have been removed so that the requests are opened one at a time and not simultaneously. To perform multiple tasks, you can open the requests pages in different browser tabs.</p>
<p>Navigation enhancement in Automation Co-Pilot on the web</p> <p>The web interface is now enhanced with a side navigation pane so that you can easily navigate to various pages (<b>Processes</b>, <b>Requests</b>, <b>Recycle Bin</b>, and <b>Tasks</b>).</p>

What's new
<p>New processes page (Service Cloud case ID: 00694786)</p> <p>As an Automation Co-Pilot user, navigate to your assigned processes and create new requests by using the new <b>Processes</b> page in the web interface. Use the navigation bar to quickly access the page.</p>
<p>Enhancements to the Button element</p> <ul style="list-style-type: none"> <li>Use the <b>Disallow button click when this form is first loaded</b> option to disable the <b>Button</b> element in a form when it is displayed for the first time during bot runtime.</li> <li>Use the <b>Subtle</b> option in the <b>Button type</b> drop-down menu if you want the button element to appear as a link during bot runtime.</li> </ul> <p><a href="#">Using the Button element</a> on page 3438</p>
<p>Enhancement to the form logo</p> <p>You can now use the <b>Logos in footer</b> field option to select up to two separate logos that are displayed in the footer of the form during bot runtime.</p> <p><a href="#">Create a form</a></p>

## Discovery Bot

What's new
<p>Search for a business process from the Processes page</p> <p>You can now use the search field to help you locate a specific process by name. The field is not case-sensitive. The search field is available from the <b>Processes</b> page.</p> <p><a href="#">Create a Discovery Bot process</a> on page 3905</p>
<p>View all captured images from the screenshot modal window</p> <p>You can now navigate across all captured screenshots when you click an image in full size from the modal window. Click the pagination located below the image to select a step number or use the right or left arrows to quickly display all captured images.</p> <p><a href="#">Record a Discovery Bot business process</a> on page 3910</p>
<p>Process Discovery package is included in default packages</p> <p>The Process Discovery package is now included in the default packages. You can preload the default package when you connect to your device. Preloading the package helps to speed the start time of the recorder the first time you begin recording a process</p> <p><a href="#">Prerequisites for Discovery Bot</a> on page 3896</p>

**What's new**

## Recorder enhancements

You can now perform actions such as double-click, drag-drop, click and hold, and text select when recording a business process. Actions performed using keyboard strokes are displayed in the **Data** field. Double-click is captured by the recorder and displayed in the screenshot from the **Recordings** page.

**Note:** The Discovery Bot recorder does not capture the drag-drop and click and hold actions from the **Recordings** page. To include these actions performed during the recording, you can document the individual steps in the **Step description** text field for the analyst.

[Record a Discovery Bot business process](#) on page 3910

**IQ Bot****Known limitations**

IPv6 addresses are not supported for IQ Bot, so ensure that you use only IPv4 addresses.

**Bot Insight****What's new**

## AAE\_Admin role access to operations API from Power BI connector

The Power BI connector now provides the **AAE\_Admin** user role access to the botrundata operational API. With this role, you can connect to the botrundata API and extract operational metrics to be analyzed and visualized within Power BI.

## Enhancements to the publish (production) dashboard

Users with the **AAE\_Bot Insight Admin** and **AAE\_Bot Insight Expert** role can now edit the published dashboard. You can use the save as option to save the production dashboard as a custom production dashboard and add widgets to your custom dashboard. You can also delete a default production dashboard and a custom production dashboard.

[Save a published dashboard](#) on page 3947 | [Delete a published dashboard](#) on page 3947

**Important:** The supported packages information is moved to this topic: [Packages available in Automation 360](#) on page 2316.

**Community Edition A2019.19 Release Notes**

Release date: 05 February 2021

Review the new features in the Community Edition A2019.19 release (Build 8145).

- [Community Edition](#) on page 816
- [AARI](#)
- [Discovery Bot](#) on page 819

## Community Edition

**Important:** This release includes a required update to your . Ensure that you complete the update to continue with your automation activities when upgrading from a previous release to this release.

[Automatically update the Bot Agent](#) on page 1361 | [Manually update the Bot Agent](#) on page 1362

To verify which version is compatible with this release, see [Compatibility with release builds](#) on page 1333.

New features
<p>New features in Data Table package (Service Cloud case ID: 00656843, 00707635)</p> <ul style="list-style-type: none"><li>• Use the <b>Change column type</b> action in the Data Table package to perform operations on the column of a data table. Use this action to change the column data type to <b>Boolean, Datetime, Number, or String</b>.</li><li>• Sort the data in the data table in <b>Number, Datetime, Boolean, or String</b> format.</li></ul> <p><a href="#">Data Table package</a> on page 2452</p>
<p>New action in App Integration package</p> <p>Use the <b>Capture scrollable text</b> action to extract text from the selected window or any control within the selected window and save it to a variable. If you click any control within the window, then text from that specific control is extracted. If you click outside the window, then all the text from that window is extracted.</p> <p><a href="#">App Integration package</a> on page 2423</p>
<p>New encoding combo box option in Terminal Emulator for VT Series</p> <p>To send and receive Japanese text, you can now use the <b>Encoding</b> and <b>CodePage</b> combo boxes when you connect to the Terminal Emulator for the VT series terminal type.</p> <p><a href="#">Using Connect action for Terminal Emulator</a> on page 3119</p>



New features
<p>New actions in Active Directory package</p> <p>Use the following actions in the Active Directory to automate a task:</p> <ul style="list-style-type: none"> <li>• Move a computer <a href="#">Using the Move computer action</a> on page 2377</li> <li>• Move an organizational unit <a href="#">Using the Move organizational unit action</a> on page 2383</li> <li>• Add users to a group <a href="#">Using the Add users to group action</a> on page 2385</li> <li>• Remove users from a group <a href="#">Using the Remove users from group action</a> on page 2388</li> </ul>
<p>New system variable for new line character (Service Cloud case ID: 00669232, 00672775, 00673578)</p> <p>Use the \$String:Newline\$ system variable to add a new line character. This variable adds a new line character in various applications regardless of the operating system of the device.</p>
<p>Zero-size form for Enterprise A2019 (Service Cloud case ID: 00677611)</p> <p>The <b>Run</b> action uses the zero-size form with name <code>AAZeroSizeForm</code> that can be used by DLLs to identify zero-size forms created by Enterprise A2019.</p>
<p>Enhancement to define parent path in Active Directory</p> <p>When you establish a connection with an LDAP server, you can now select the LDAP path by connecting to the server.</p> <p><a href="#">Using Connect action for Active Directory</a> on page 2380</p>
<p>Obtain information about Run-As user after bot deployment</p> <p>Use the <code>AATaskExecutor</code> system variable to return the username, first name, last name, and email of the user that ran the bot. If the bot is deployed on an attended Bot Runner, this variable returns information about the logged-in user. If the bot is deployed by a trigger, this variable returns information about the user associated with that Bot Runner license.</p> <p><a href="#">System settings and parameters</a> on page 2329</p>
<p>Enhancements to the Recorder</p> <ul style="list-style-type: none"> <li>• Universal Recorder now supports object capture in Mozilla Firefox. You must install the A2019 extension from Mozilla Firefox browser add-ons.</li> <li>• Capture table, grid view, and main window objects from SAP applications.</li> </ul> <p><a href="#">Universal Recorder supported applications and browsers</a> on page 2248   <a href="#">Actions performed on objects captured with Universal Recorder</a> on page 2923</p>

## Automation Co-Pilot for Business Users (Automation Co-Pilot)

New features
<p>New filter task in the process editor</p> <p>In the process editor, the <b>Filter Task</b> enables users to filter variables such as human or bot task output with a specific filter criterion.</p> <p><a href="#">Create a process automation in Process Composer</a> on page 3454</p>
<p>New process task in the process editor</p> <p>Use the new <b>Process Task</b> option in the process editor to call a subprocess within the main process. This feature enables you to separate tasks into different processes instead of including all the tasks in a single process. Multiple teams can now work at the same time on different tasks within the main process and remain segregated, without any conflicts.</p> <p><a href="#">Create a process automation in Process Composer</a> on page 3454</p>
<p>Hide a task or view a hidden task</p> <p>With a Bot Creator license, you can now perform the following:</p> <ul style="list-style-type: none"> <li>• Hide the display of human and bot tasks by selecting the <b>Hide this task after completion</b> option in the process editor.</li> <li>• View a hidden human or bot tasks by selecting the <b>View hidden tasks</b> option in the tasks view page.</li> </ul> <p><a href="#">Create a process automation in Process Composer</a> on page 3454</p>
<p>Edit title in process editor</p> <p>Users can now edit the title in the process editor.</p>
<p>Rich-text editor updates (web interface)</p> <p>In the web interface, you can use rich-text editor features such as bold text, italics, underline, alignment, formatting, color, and size in tasks.</p>
<p>Table element updates (web interface)</p> <p>In the web interface, the <b>Table</b> element now supports the use of date, number, drop-down, and text values in tasks.</p>
<p>Updates to elements in form builder</p> <p>The form builder now includes the following new elements:</p> <ul style="list-style-type: none"> <li>• <b>Select Folder</b> element: Add an upload folder option in the form. <a href="#">Using the Select Folder element</a> on page 3449</li> <li>• <b>Hyperlink</b> element: Assign a URL in the form. <a href="#">Using the Hyperlink element</a> on page 3443</li> </ul>

**New features**

Enhancement to the Checkbox action trigger

If a form with a **Checkbox** element is used within a trigger loop package, you can now use the **Value selected** and **Value unselected** trigger actions.

[Trigger loop package](#) on page 3136

## Discovery Bot

**New features**

View the duration of each recorded step

A recorded step is now displayed in minutes and seconds for the business user and analyst. Use this information to understand which steps are a bottleneck in the current process and will provide most benefit from automation. The step duration is displayed from the **Recordings** page (below the screenshot image), and from the **View process** and **View opportunities** page from the Preview pane window.

[Record a Discovery Bot business process](#) on page 3910

---

**Important:** The supported packages information is moved to this topic: [Packages available in Automation 360](#) on page 2316.

---

## Community Edition A2019.18 Release Notes

Release date: 05 January 2021

Review the new features and supported packages in the Community Edition A2019.18 release (Build 7560).

- [Community Edition A2019](#) on page 819
- [AARI](#)
- [Discovery Bot](#) on page 823
- [Bot Insight](#) on page 824
- [Supported packages](#)

## Community Edition A2019

---

**Important:** This release includes a required update to your . Ensure that you complete the update to continue with your automation activities when upgrading from a previous release to this release.

[Automatically update the Bot Agent](#) on page 1361 | [Manually update the Bot Agent](#) on page 1362

---

Build 7560 (Community Edition) is compatible with Bot Agent 16.19.8232.

New features
<p>Configure timeout in Bot Migration package</p> <p>When migrating bots, you can now set a timeout value in the range of 3 through 90 minutes (default value is 90 minutes). If the migration of any specific bot is not completed within the set time, a timeout message is displayed and the migration process moves to the next bot.</p>
<p>Use regular expressions in variables (Service Cloud case ID: 00628227)</p> <p>Use regular expressions (regex) in value type variables to specify the entity on which you want to perform an operation. For example, actions in the File, Folder, String, and Window packages allow use of regular expression in variables.</p> <p>When Enterprise 11 or Enterprise 10 bots with commands that use regular expressions in variables are migrated, if their equivalent actions in Enterprise A2019 do not support regular expressions, the regular expression is converted to string in the migrated bots.</p>
<p>Recorder enhancements</p> <ul style="list-style-type: none"> <li>• Use the AISense Recorder <b>Define</b> option to record an interaction, such as click active text, with an object that is only visible when you hover the mouse over the object.</li> <li>• If you record a click and keystrokes in a text box with a <b>Control Type</b> of <code>PASSWORD_TEXT</code>, the <b>Recorder</b> does not capture the keystrokes entered into the field. Instead, the action selects the <b>Set text</b> option and offers users the option to select a credential from the Credential Vault, enter a credential variable, or enter an insecure string.</li> </ul>
<p>Efficiently map input and output variables between parent and child bots (Service Cloud case ID: 00537090, 00698697)</p> <p>For input variables, use the <b>Quick map</b> option to select the variables and set the values for the parent bot to pass. For output variables, use the <b>Multiple variables</b> tab to associate each dictionary key with a variable. This feature eliminates the need to use actions to extract the output dictionary values.</p> <p><a href="#">Task Bot package</a> on page 3109   <a href="#">Using the Run action</a> on page 3111</p>
<p>Support for PowerBuilder application in App Integration package (Service Cloud case ID: 00680703)</p> <p>The App Integration package now supports PowerBuilder to capture and extract text from a window application. The <b>Capture text of window</b> action enables you to open a PowerBuilder screen to capture all the data and verify the captured text.</p>
<p>New action in Terminal Emulator package</p> <p>Use the <b>Search Field</b> action in the Terminal Emulator package to search for a field based on the text it contains. This action returns the name or index of the field based on the option selected.</p> <p><a href="#">Terminal Emulator package</a> on page 3117</p>

New features
<p>New action in PDF package</p> <p>Use the <b>Get Property</b> action in the PDF package to retrieve the properties of a PDF file and assigns the properties to a dictionary variable.</p> <p><a href="#">Using the Get property action on page 2885</a></p>
<p>New actions in Browser package</p> <p>Use the following actions in the Browser package:</p> <ul style="list-style-type: none"><li>• <b>Close</b>: Closes a Google Chrome browser window or tab.</li><li>• <b>Get source code</b>: Retrieves the source code of a web page and saves it to a string variable.</li><li>• <b>Go back</b>: Returns to a web page that you previously visited in the current tab.</li><li>• <b>Open</b>: Opens the browser to a specific web page in an existing tab, new tab, or window.</li><li>• <b>Run JavaScript</b>: Executes JavaScript in a web page.</li></ul> <p><a href="#">Browser package on page 2435</a></p>
<p>Specify application window dimensions</p> <p>Use the <b>Resize windows</b> option to set the window height and width to specific dimensions or to the dimensions at which it was captured. This feature enhances the bot's ability to identify the target object.</p> <p>The following packages support this feature:</p> <ul style="list-style-type: none"><li>• App Integration</li><li>• If <b>Image recognition</b> condition</li><li>• If <b>Legacy Automation &gt; Window Control</b> condition</li><li>• Image Recognition</li><li>• Simulate keystrokes</li><li>• Legacy Automation <b>Desktop &gt; Manage windows controls</b> action</li><li>• Loop <b>While &gt; Image recognition</b> condition</li><li>• Loop <b>While &gt; Legacy Automation &gt; Window Control</b> condition</li><li>• Mouse</li><li>• OCR</li><li>• Screen</li></ul>
<p>Support for function keys in Terminal Emulator package</p> <p>Function keys (F1 through F24) are now supported to automate processes using ANSI and VT100 terminals in the Terminal Emulator package.</p>

New features
<p>Use regex case insensitive flag for Window title</p> <p>Enable the regex <b>Case insensitive</b> flag to identify a <b>Window title</b> field as not case-sensitive. This feature enables you to successfully run the bots even if the letter case does not match the captured window title.</p> <p>The following packages and actions support this feature:</p> <ul style="list-style-type: none"> <li>• Wait</li> <li>• Image Recognition</li> <li>• Simulate keystrokes</li> <li>• Mouse &gt; <b>Click</b> action</li> <li>• Legacy Automation <b>Desktop</b> &gt; <b>Manage windows controls</b></li> <li>• OCR &gt; <b>Capture window, Capture area</b></li> <li>• Screen &gt; <b>Capture window, Capture area</b></li> <li>• Recorder &gt; <b>Capture</b></li> <li>• Window: <b>Activate, Close, Maximize, Minimize, Resize</b></li> </ul>

## Automation Co-Pilot for Business Users (Automation Co-Pilot)

New features
<p>New Automation Co-Pilot on the web package</p> <p>Use the Automation Co-Pilot on the web package to perform actions such as assign, query, and cancel tasks; create and query requests; and retrieve a list of team members.</p> <p><a href="#">Process Composer package</a> on page 2893</p>
<p>Filter by time</p> <p>You can now filter your requests and tasks by time:</p> <ul style="list-style-type: none"> <li>• <b>Requests</b> tab: Use the <b>Created</b> and <b>Updated</b> options in the <b>Filter</b> window to select any dates.</li> <li>• <b>Tasks</b> tab: Use the <b>Task created</b> and <b>Task updated</b> options in the <b>Filter</b> window to select any dates.</li> </ul> <p><a href="#">Filter and search for a request</a> on page 3391   <a href="#">Filter and search for a task</a> on page 3393</p>
<p>View updated dates</p> <ul style="list-style-type: none"> <li>• Use the new <b>Updated</b> column in the <b>Requests</b> tab to view the dates and time of a request that was last updated.</li> <li>• Use the new <b>Task Updated</b> column in the <b>Tasks</b> tab to view the date and time of a task that was last updated.</li> </ul>
<p>Variable options</p> <p>In the <b>Insert a variable</b> window, the <b>Variable</b> field now shows child elements of available references, which include <b>Dictionary, List, Record, and Table</b> variable types.</p>

New features
<p>Delete a request</p> <p>Automation Co-Pilot administrators, managers, and users can now delete requests created by the Automation Co-Pilot process. The Automation Co-Pilot administrator can delete any requests. Automation Co-Pilot managers can delete requests of the team for which they are the owner. Automation Co-Pilot users can delete only the requests they have created.</p> <p><a href="#">Delete a request</a> on page 3385</p>
<p>Automatically assign managers and users</p> <p>Users can now select the <b>Auto assign this task</b> option in the <b>Human Task</b> to assign managers or users to the task. Users can also select the <b>Auto assign the target task to</b> option in the <b>Go to</b> element to assign managers to the task.</p> <p><a href="#">Create a process automation in Process Composer</a> on page 3454</p>

## Discovery Bot

New features
<p>Access Discovery Bot capabilities in Community Edition</p> <p>Discovery Bot is now available in the Community Edition and the free trial version. Log in to the Control Room and click the Discovery Bot tab on the left panel to get started.</p> <p>The available limits to create processes, recordings, views, and opportunities are displayed on the respective page. Create any number of bots and download a PDD for your personal use as required.</p> <p>A single Community Edition user is a multi-role user with Admin plus Business user plus Analyst permissions.</p> <p><a href="#">Get started with Discovery Bot</a> on page 3889</p>
<p>Use Model option for system-generated views</p> <p>You can now use the <b>Model</b> option to compare and find the best aggregated view for your recordings. Use this option to save as many views with different combinations as required.</p> <p>You can also save the view as a manual view to further customize your view and compare side-by-side. Select either an <b>Easy</b> or <b>Strict</b> model so that you can view recordings where the steps are the same versus recordings with different results with more branches in the process path.</p> <p><a href="#">Create a process view with branches and opportunities</a></p>
<p>Use Filter option for system-generated views</p> <p>You can now use the <b>Filter</b> option to use a set of values to compare different sections of a process across various recordings by selecting a specific path and step filter. Used along with the <b>Model</b> option, the path and step filter options for a system-generated or manual view can help you to determine and decide on a good candidate for automation.</p> <p><a href="#">Create a process view with branches and opportunities</a></p>

New features
<p>Use toggle frequency counter option for system-generated views</p> <p>You can now use the toggle frequency counter to display the number of recordings that a particular path takes in the flow in a system-generated view. Use this option to help you understand the frequency of the path compared to other recordings or views.</p> <p><a href="#">Create a process view with branches and opportunities</a></p>
<p>Remove recording screenshot for data privacy</p> <p>Use the <b>Screen</b> option (icon) to display or hide the recording screenshot before submitting the recording for the analyst to review. Use this option when you do not want to share personal image details with the analyst.</p> <p><a href="#">Record a Discovery Bot business process</a> on page 3910</p>
<p>Download PDD from the Opportunities table</p> <p>You can now download a process definition document (PDD) for an opportunity directly from the Opportunities table listed on the <b>Opportunities</b> page. The PDD is automatically generated when the opportunity is created. After the PDD is generated, the field changes from generating PDD to <b>Download PDD</b>. You can then download and save the document.</p> <p><a href="#">Review opportunities and convert to</a></p>

## Bot Insight

New features
<p>Access Bot Insight data from Tableau</p> <p>Use the Tableau connector in Bot Insight to access business and operational information. The Tableau connector connects to the Bot Insight APIs to create various business and operational metrics that you can analyze and visualize within Tableau.</p> <p><a href="#">Configure Tableau web data connector in Bot Insight</a> on page 3959</p>

## Supported packages

Package	Version
Application	2.1.0-20201112-22332
App Integration	2.3.0-20201210-171315
Active Directory	2.1.0-20201112-223323
Boolean	2.1.0-20201126-165109
Browser	2.3.0-20201211-222811
Clipboard	2.1.0-20201126-165124
Comment	2.3.0-20201126-165125



Package	Version
CSV/TXT	2.3.0-20201126-165126
Database	2.2.0-20201112-223343
Data Table	2.5.0-20201201-130615
Datetime	2.2.0-20201126-165136
Delay	2.2.0-20201126-165137
Dictionary	3.2.0-20201126-165138
Run DLL	3.3.0-20201126-165850
Email	3.2.0-20201120-062604
Error handler	2.3.0-20201126-165148
Excel basic	2.4.0-20201126-165604
Excel advanced	5.3.0-20201208-090251
File	3.2.0-20201126-165151
Folder	3.1.0-20201126-165154
FTP / SFTP	2.2.0-20201115-072759
Image Recognition	2.2.0-20201117-081754
JavaScript	2.4.0-20201126-165412
Simulate keystrokes	2.5.0-20201112-223902
Legacy Automation	3.2.0-20201124-064544 1.5.0-20201125-004358
List	2.2.0-20201126-165427
Log To File	2.2.0-20201126-165428
Loop	2.1.0-20201126-165429
Message Box	2.1.0-20201126-165430
Mouse	2.2.0-20201112-223917
Number	2.1.0-20201126-165444
OCR	2.3.0-20201126-081210
Microsoft 365 Excel	2.2.0-20201104-062559
Microsoft 365 Calendar	2.1.0-20201111-162101
Microsoft 365 OneDrive	2.2.0-20201126-165550
PDF	2.6.0-20201126-165555
PGP	2.2.0-20201126-165557
Ping	2.1.0-20201126-165559
Play Sound	2.1.0-20201127-115706

Package	Version
Prompt	2.2.0-20201109-192507
Python Script	2.4.0-20201208-064944
Recorder	2.10-20201215-211402
REST Web Service	3.2.0-20201112-224735
SAP	2.2.0-20201126-165852
Screen	2.2.0-20201126-165855
SNMP	2.1.0-20201126-165859
SOAP Web Service	3.2.0-20201123-093411
String	3.1.0-20201126-165909
System	3.0.0-20200921-090225
Terminal Emulator	3.6.0-20201213-084139
VBScript	2.4.0-20201208-065526
Wait	3.1.0-20201126-165922
Window	2.3.0-20201123-093430
Workload	2.1.0-20200825-071644
XML	2.1.0-20201126-165927

## Community Edition A2019.17 Release Notes

Release date: 13 November 2020

Review the new features and supported packages in the Community Edition A2019.17 (Build 7103) release. IQ Bot is on Build 7082.

- [Community Edition A2019](#) on page 826
- [AARI](#)
- [IQ Bot](#) on page 830
- [Bot Insight](#) on page 831
- [Supported packages](#)

## Community Edition A2019

**Important:** This release includes a required update to your . Ensure that you complete the update to continue with your automation activities when upgrading from a previous release to this release.

[Automatically update the Bot Agent](#) on page 1361 | [Manually update the Bot Agent](#) on page 1362

New features
<p>Connect to EWS server with OAuth authentication</p> <p>A new authentication is available for the Exchange Web Services (EWS) protocol with OAuth. You can use the OAuth authentication and enable your EWS-managed API applications to access Exchange online in Office 365.</p> <p><a href="#">Using Connect action in Email package</a> on page 2523</p>
<p>VT220 terminal type supported in Terminal Emulator</p> <p>To establish a connection and communicate with another machine, you can now use the VT220 terminal for sending and receiving text.</p> <p><a href="#">Using Connect action for Terminal Emulator</a> on page 3119</p>
<p>Enhancements to the Recorder</p> <ul style="list-style-type: none"> <li>Record a task using the Universal Recorder or AISense Recorder from a single point of entry. Both recorders are now managed through a single package, which enables faster and more efficient updates.</li> <li>You can now record tasks in a Microsoft Edge browser that runs on Chromium (versions 79 and later).</li> <li>Use the AISense Recorder <b>Define</b> option to capture an object that is only visible when you hover the mouse over the object.</li> <li>Use the <b>Resize window</b> option in the <b>Recorder &gt; Capture</b> action to set the window width and height.</li> </ul> <p>This option delivers a more reliable bot. It resizes the window to the dimensions at which the task was recorded, thus increasing the likelihood that the bot identifies the target object.</p> <p><a href="#">Get started with recorders</a> on page 2238   <a href="#">Universal Recorder supported applications and browsers</a> on page 2248   <a href="#">Using the Capture action</a> on page 2940</p>
<p>Use shared session in Terminal Emulator</p> <p>Use the new <b>Shared session</b> option to pass the exact state of an application to a concurrently occurring Task Bot or MetaBot logic. For example, instead of connecting to the same application multiple times for different tasks, you can use the option to connect to the application using a single task, thus optimizing your automation logic in the long run.</p> <p><a href="#">Share session between Task Bot logic</a> on page 3133</p>
<p>Share an Excel session between bots</p> <p>Use the <b>Set session</b> action from the Excel basic or Excel advanced package to assign an Excel session to a variable, and then pass that variable from a parent to a child bot. This enables the child bot to access the worksheet opened in the parent bot.</p> <p><a href="#">Excel basic package</a> on page 2558   <a href="#">Excel advanced workbook operations</a>   <a href="#">Example for sharing an Excel session between bots</a> on page 3114</p>
<p>New option for Run Task</p> <p>In the Task Bot package, you can now use the <b>Run</b> action with an option to repeat the selected task until you choose to stop it.</p>

New features
<p>New search for roles in User Management API</p> <p>Use the new <code>Search for roles</code> API in the User Management APIs in Swagger to obtain a list of all the roles or details for a specific role.</p>
<p>Capture response status of REST API</p> <p>In the REST Web Service package, you can capture the response status of the REST API in the dictionary variable. The dictionary variable now shows the response key with its value.</p>
<p>New option for REST Web Service (Service Cloud case ID: 00489741, 00646436)</p> <p>Use the <b>Capture failure response</b> action in the REST Web Service package to capture response details in the response body.</p>
<p>Use regular expressions in packages</p> <p>You can use regular expressions (regex) in certain actions to support pattern-based search in a file, folder, or Windows title. Regular expressions are supported in the actions of the File and File and Folder packages such as <b>Copy</b>, <b>Delete</b>, <b>Rename</b>, <b>Print Multiple files</b>, and <b>Zip</b>.</p> <p>You can also use regular expressions in some packages that support the wildcard character in their window titles.</p> <p>The following packages and actions support regular expressions:</p> <ul style="list-style-type: none"><li>• Wait</li><li>• Image Recognition</li><li>• Simulate keystrokes</li><li>• Mouse &gt; <b>Click</b> action</li><li>• Legacy Automation &gt; <b>Manage windows control</b></li><li>• OCR</li><li>• Screen</li><li>• Recorder &gt; <b>Capture</b></li><li>• Run DLL &gt; <b>Run function (Legacy)</b>, <b>Run function</b></li><li>• Window: <b>Activate</b>, <b>Close</b>, <b>Maximize</b>, <b>Minimize</b>, <b>Resize</b></li></ul> <p><a href="#">Using Copy Desktop file action for file</a> on page 2601   <a href="#">Using the Capture action</a> on page 2940</p>
<p>Support for overloaded functions in DLL package</p> <p>The <b>DLL &gt; Run function</b> action can now handle <code>.dll</code> files that contain multiple functions of the same name. The action calls the function based on the number of parameters passed.</p> <p><a href="#">Using the Run function action</a> on page 2505</p>
<p>New actions for SAP captured objects</p> <p>Use new actions that are available for <b>Tree</b>, <b>Tab</b>, and <b>Label</b> controls to perform operations for the various objects captured from an SAP application.</p> <p><a href="#">Recorder actions supported in various SAP versions</a> on page 2952</p>

New features
<p>Store multiple lines of text in a string variable</p> <p>You can use a string variable containing multiple lines of text in the following actions:</p> <ul style="list-style-type: none"> <li>• <b>String &gt; Assign</b></li> <li>• <b>String &gt; Extract text</b></li> <li>• <b>String &gt; Compare</b></li> <li>• <b>String &gt; Lowercase</b></li> <li>• <b>String &gt; Replace</b></li> <li>• <b>String &gt; Reverse</b></li> <li>• <b>Log to file</b></li> <li>• <b>Message box</b></li> <li>• The string condition in the <b>If</b>, <b>Wait</b>, and <b>While</b> actions</li> </ul>
<p>Arabic, Japanese, and Russian characters supported in variable names</p> <p>You can now create variables with names containing Arabic or Russian characters, or Japanese double-byte numbers.</p> <p><a href="#">Unicode range supported in variables</a> on page 2341</p>

## Automation Co-Pilot for Business Users (Automation Co-Pilot)

New features
<p>View previous selected tasks</p> <p>Automation Co-Pilot users can now reference selected actions of their tasks. When they view a submitted task in request view, a check mark indicator is now displayed next to the buttons that are selected.</p>
<p>Run a process in private workspace</p> <p>You can now run a process in your private workspace by using the <b>Run</b> option in the process editor. The bots in the process are then executed on the default device of the Bot Creator.</p> <p><a href="#">About Process Composer</a> on page 3419</p>
<p>Use variables types</p> <p>You can now use new variables in the process editor such as <b>createdOn</b> and <b>updatedOn</b> (DateTime), <b>id</b> (Number), and <b>title</b> (String). These variables are part of a data flow (workflow engine) that moves data between each step of a process and requires variable input for the process to run properly.</p> <p><a href="#">Supported variable types in Process Composer</a> on page 3433</p>

New features
<p>Use the Data Privacy tag field</p> <p>The <b>Data Privacy tag</b> enables users to generate hidden custom output in their process tasks (<b>Start</b> panel, <b>Human Task</b>, and <b>Bot Task</b>). Users can enter the variables for this field during runtime with values. In the web portal, the Automation Co-Pilot admin can use this tag to check for requests or tasks by using personal user data. The admin can also filter using this field.</p> <p><a href="#">Create a process automation in Process Composer on page 3454</a>   <a href="#">Filter and search for a request on page 3391</a>   <a href="#">Filter and search for a task on page 3393</a></p>

## IQ Bot

New features
<p>Support for Arabic language</p> <p>When creating a learning instance, you can now choose the Arabic language from the <b>Primary language of documents</b> drop-down menu, with the following limitations:</p> <ul style="list-style-type: none"> <li>• Advance table extraction is not available.</li> <li>• Search field on the is not supported.</li> <li>• Arabic numerals are not supported.</li> </ul> <p>For example, if the document has date or time in Arabic language, it is extracted as text and validations can fail.</p> <hr/> <p><b>Note:</b> You can still use string-based validation checks (such as regular expressions) for Arabic numerals.</p> <hr/> <ul style="list-style-type: none"> <li>• Arabic is only supported on ABBYY FineReader Engine 12.4.</li> </ul> <p><a href="#">Creating a learning instance</a></p>
<p>Default validations for a group</p> <p>When editing a learning instance, you can now use the <b>Select the default validations group</b> drop-down menu to select an available group. This allows all the new group documents in production to be extracted based on the custom logic and validations defined in this selected group, before it goes to the Validator.</p> <p><a href="#">Edit a learning instance</a></p>

Fixed features	
Service Cloud case ID	Description
-	You can now create and edit a bot even if a document associated with a deleted bot appears in production. Previously, if a bot was deleted and a document associated with it appeared in production, you could not create a new bot.

## Bot Insight

New features
<p>New Automation Co-Pilot dashboard in Bot Insight</p> <p>Use the Automation Co-Pilot dashboard to view various widgets that provide information about requests created from published processes in Automation Co-Pilot. The dashboard also provides statistics on the status of created requests.</p> <p><a href="#">Automation Co-Pilot dashboard</a> on page 3940</p>

## Supported packages

Package	Version
Application	2.1.0-20200921-085720
App Integration	1.1.0-20201014-042506
Analyze	2.2.4-20200903-113949
Active Directory	2.1.0-20200921-085716
Boolean	2.1.0-20201014-042509
Bot Migration	2.5.0-20200902-045043
Browser	2.1.0-20201002-123733
Clipboard	2.1.0-20201014-042520
Comment	2.2.0-20201014-042520
CSV/TXT	2.3.0-20201014-082525
Database	2.2.0-20201013-052941
Data Table	2.3.0-20201030-143334
Datetime	2.2.0-20201014-042531
Delay	2.2.0-20201014-042532
Dictionary	3.2.0-20201014-042532
Run DLL	3.2.0-20201105-205159
Email	3.1.0-20201104-062204
Error handler	2.2.0-20201014-042541
Excel basic	2.3.0-20201027-160012
Excel advanced	5.1.0-20201027-155758
File	3.1.0-20201016-065515
File & folders	1.1.0-20201023-202725

Package	Version
Folder	3.0.0-20201016-065517
FTP / SFTP	2.1.0-20200921-085757
IF/ELSE	2.1.0-20200921-085758
Image Recognition	2.1.0-20201014-042552
Interactive forms	2.17.3-20201102-103733
IQ Bot	2.1.0-20201013-095304
JavaScript	2.3.0-20201104-062431
Simulate keystrokes	2.4.0-20201021-163833
Legacy Automation	3.2.0-20201104-062439 1.3.0-20201105-151906
List	2.2.0-20201014-042806
Log To File	2.2.0-20201014-042806
Loop	2.1.0-20201014-042808
Message Box	2.1.0-20201014-042808
Migration	2.7.0-20201106-072418
Mouse	2.1.0-20201014-042814
Number	2.1.0-20201014-042823
OCR	2.2.0-20201104-062503
Microsoft 365 Excel	2.2.0-20201104-062559
Microsoft 365 Calendar	2.1.0-20200921-085726
Microsoft 365 OneDrive	2.1.0-20201014-042924
PDF	2.5.0-20201014-042929
PGP	2.2.0-20201014-042931
Ping	2.1.0-20201014-042932
Printer	2.1.0-20200921-090131
Play Sound	2.1.0-20200921-090123
Prompt	2.1.0-20200918-081201
Python Script	2.3.0-20201105-204912
Recorder	2.0.9-20201105-164103
REST Web Service	3.1.0-20200928-231420
SAP	2.2.0-20200921-090209
Screen	2.1.0-20201014-043037
SNMP	2.1.0-20201014-043041



Package	Version
Service	3.0.0-20200921-090214
SOAP Web Service	3.1.0-20200921-090219
String	3.1.0-20201014-043052
System	3.0.0-20200921-090225
Task	2.0.1-20201023-202703
Terminal Emulator	3.4.0-20201028-021451
Trigger Email	1.1.0-20201105-152220
VBScript	2.3.0-20201105-205228
Wait	3.1.0-20201014-043117
Window	2.2.0-20201022-121649
Workload	2.3.0-20201105-205233
XML	2.1.0-20201014-043121

## Sandbox environment

The sandbox environment for Automation 360 Cloud enables you to test your production bots to ensure that these bots work seamlessly in your production environment. Use the sandbox environment to help plan and test new features for upcoming Automation 360 releases.

The sandbox environment is the same as any Automation 360 Cloud instance but includes updates from the upcoming new release at least 3 weeks before Automation Anywhere Cloud is updated.

**Note:** The sandbox environment should not be used as your production environment.

IQ Bot is not included in the sandbox environment.

The following image shows how a new build is tested in the sandbox environment before it is pushed to the production environment.

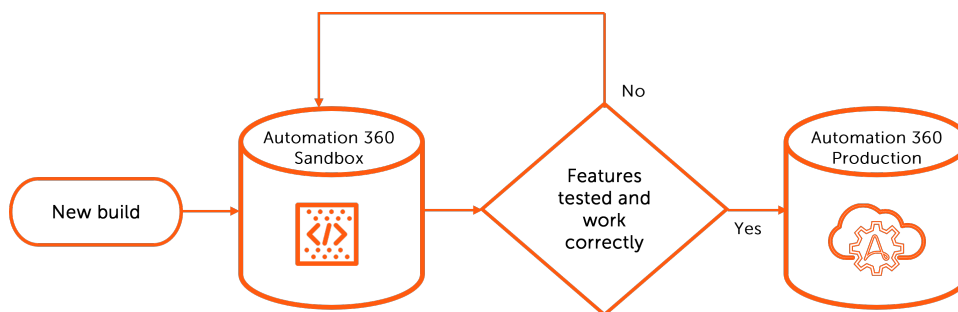

## Benefits

The environment provides the following benefits to the Automation 360 Cloud customers:

- Test new features and identify any changes that might be required in your current bots.
- Preview upcoming features and enhancements.
- Better plan and manage changes for the upcoming update to your environment.

The sandbox environment is available only for Automation 360 cloud and cloud-enabled deployments. The environment is not supported for a Control Room in a data center that is hosted by you or a third-party vendor. The environment includes upcoming updates for Automation 360, Discovery Bot, Document Automation, Automation Co-Pilot, and Bot Insight.

## Prerequisites

- You must have a valid Automation 360 Cloud license to use the sandbox environment.
- You must purchase an orderable sandbox SKU.

Contact your Customer Success Manager (CSM) or Partner Enablement Manager (PEM) for more details.

## Configure the environment

Perform the following tasks before you start using the environment:

1. De-allocate some of the licenses from your existing Automation 360 instances and allocate these licenses to the sandbox environment.
2. [Switch Bot Agent to the sandbox environment.](#)
3. Create the required users, roles, and other Automation 360 Cloud entities in the environment:
  - [Create a user](#) on page 1739
  - [Create a role](#) on page 1748
  - [Credentials and lockers in the Credential Vault](#) on page 1861
4. [Export bots from your existing Automation 360 Cloud .](#)
5. [Import the exported bots to the sandbox environment using Bot Lifecycle Management .](#)

See also:

- [Automation 360 software lifecycle policy](#) on page 1076
- [Automation 360 Cloud updates](#) on page 1072

## Package updates overview

Packages are typically updated in Automation 360 releases as part of new Control Room builds. We also plan to release some updates between these releases for early delivery of critical updates and fixes as package-only updates.

These package updates are planned for the middle of specific months (dates might vary to avoid weekends or holidays).

For more information, see [Periodic package updates - summary list](#) on page 836.

### How to get updated packages

Package updates will be automatically available on Cloud Control Room instances. For On-Premises Control Room instances, you can access these packages by enabling the package update feature.

- Cloud

When a new package is available, it will be downloaded automatically to the Control Room if the package is compatible with the Control Room.

The administrator can choose to enable or disable the package and choose to set an enabled package as default through **Administration > Settings > Packages > Package update**:

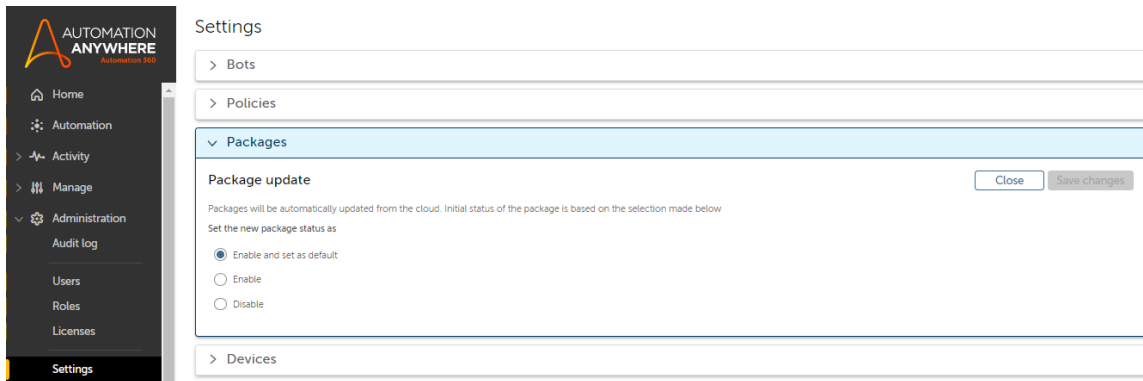

See [Automatic package updates for Cloud Control Room](#) on page 1907.

- On-Premises

The administrator can choose one of the following options:

- Enable cloud package updates.

See [Automatic package updates for On-Premises Control Room](#) on page 1906.

- Manually upload the package to the Control Room.

See [Add packages to the Control Room](#) on page 1908.

To get the updated package, download the file from this A-People page: [Automation 360 package releases \(A-People login required\)](#).

**Note:** For On-Premises instances when the **Automatically update packages from the cloud** option is enabled, or you manually upload a more recent package version to the Control Room and then later update the Control Room: If you have enabled the package version settings to

automatically set the latest version of the packages as the default version, then you might have to manually set the default package version to the new package version.

To avoid such disruption with these package updates, we recommend using **Enable** (set the default version when the packages are updated) or **Disable** options (prevent any automatic update of a newer version) before the On-Premises update to these packages.

Related concepts

[Updating packages in Control Room](#) on page 1905

The delivery of packages is developed to be separate from the main platform updates. This will help us respond quickly to changes and fixes required and provide the flexibility to deliver updates in packages, going forward.

Related reference

[Packages updated in v.30](#) on page 62

Review updates to the packages in Automation 360 v.30, including the compatible Control Room and Bot Agent versions.

## Periodic package updates - summary list

We will be updating specific packages in the Control Room to enable you to get early access to critical updates and fixes.

**Note:** Each package is associated with a minimum Control Room version. If the automatic update of packages option is enabled in your Control Room, the new package is downloaded automatically if your Control Room version is compatible with the minimum Control Room requirements for that package. For more information, see [How to get updated packages](#) on page 835.

### November 2023

The following table lists packages updated on 16 November 2023, after the v.30 release. Click the package version to view updates in that package.

Package name	Version	Bot Agent version	Control Room build
Browser	<a href="#">3.10.2</a> on page 851	21.210 or later	14140 or later
Document Extraction	<a href="#">3.31.17</a> on page 868	21.252 or later	19223 or later
Generative AI	<a href="#">1.3.2</a> on page 888	21.240 or later	17445 or later
Microsoft 365 Outlook trigger	<a href="#">1.1.1</a>	21.210 or later	13980 or later
Process Composer	<a href="#">7.30.2</a> on page 930	21.134 or later	12316 or later
Recorder	<a href="#">2.16.0-20231101-165452</a> on page 936	21.210 or later	14068 or later

## October 2023

The following table lists packages updated on 20 October 2023, after the v.30 release. Click the package version to view updates in that package.

Package name	Version	Bot Agent version	Control Room build
AI	<a href="#">1.0.2</a> on page 842	21.250 or later	18238 or later
Bot Migration	<a href="#">10.8.2</a> on page 849	21.220 or later	15224 or later
Excel basic	<a href="#">6.18.1</a> on page 881	21.112 or later	11307 or later
Recorder	<a href="#">2.15.2-20231004-180248</a> on page 937	21.210 or later	14068 or later

## September 2023

The following table lists packages updated on 21 September 2023, after the v.30 Sandbox release. Click the package version to view updates in that package.

Package name	Version	Bot Agent version	Control Room build
Bot Migration	<a href="#">10.7.0</a> on page 849	21.220 or later	15224 or later
Document Extraction	<a href="#">3.30.24</a>	21.252 or later	19223 or later
FTP / SFTP	<a href="#">2.11.0</a> on page 886	20.11 or later	8750 or later
Interactive Forms	<a href="#">3.0.0</a>	21.88 or later	10195 or later
Microsoft 365 Outlook	<a href="#">1.2.3</a> on page 918	21.210 or later	13980 or later
Recorder	<a href="#">2.14.1-20230904-102212</a> on page 938	21.210 or later	14068 or later
Terminal Emulator	<a href="#">4.11.0</a> on page 965	21.93 or later	10353 or later

## August 2023

The following table lists packages updated on 16 August 2023, after the v.29 release. Click the package version to view the updates in that package.

Package name	Version	Bot Agent version	Control Room build
Database	<a href="#">5.1.0</a> on page 859	21.88 or later	10204 or later
Document Extraction	<a href="#">3.30.21</a> and <a href="#">3.30.19</a>	21.98 or later	15345 or later
Recorder	<a href="#">2.13.6-20230809-153402</a> on page 939	21.210 or later	14068 or later
SAP	<a href="#">3.12.1</a> on page 948	21.88 or later	10195 or later

Package name	Version	Bot Agent version	Control Room build
SharePoint	<a href="#">2.1.2</a>	21.250	18000
SOAP Web Service	<a href="#">3.17.0</a> on page 958	21.240 or later	17571 or later

## July 2023

The following table lists packages updated on 17 July 2023, after the v.29 release. Click the package version to view the updates in that package.

Package name	Version	Bot Agent version	Control Room build
Browser	<a href="#">3.10.1</a> on page 852	21.210 or later	14140 or later
DLL	<a href="#">6.10.2</a> on page 865	21.22 or later	15238 or later
Document Extraction	<a href="#">3.29.17</a> on page 872	21.98 or later	15345 or later
Excel advanced	<a href="#">6.16.4</a> on page 880	21.112 or later	11307 or later
Generative AI	<a href="#">1.0.1</a> on page 889	21.240 or later	17445 or later
Google Sheets	<a href="#">2.13.0</a> on page 893	20.11 or later	8750 or later
Microsoft 365 Excel	<a href="#">2.13.2</a> on page 914	20.11 or later	8750 or later
Microsoft 365 Outlook	<a href="#">1.1.4</a> on page 919	21.210 or later	13980 or later

Related concepts

[Updating packages in Control Room](#) on page 1905

The delivery of packages is developed to be separate from the main platform updates. This will help us respond quickly to changes and fixes required and provide the flexibility to deliver updates in packages, going forward.

Related reference

[Packages updated in v.30](#) on page 62

Review updates to the packages in Automation 360 v.30, including the compatible Control Room and Bot Agent versions.

## Periodic package updates - FAQ

Review the FAQ to understand details on the periodic package updates.

What are these package updates?

These updates include enhancements and fixes to packages that we want our customers to get early access to. They are delivered in the form of package-only updates in between Automation 360 releases.

How often will such package updates be available?

These package updates will be delivered periodically, in the middle of specific months

	(dates might vary to avoid weekends or holidays).
Do I need to prepare anything in advance of receiving these package updates?	No. These updates do not require a maintenance window for the Control Room.
How will I know when a new version is made available?	<p>We will post in-app notifications a few days before the new package versions are made available.</p> <ul style="list-style-type: none"><li>• For Cloud Control Room instances, package updates will be automatically available.</li></ul> <p>When a new package is available, it will be downloaded automatically to the Control Room if the package is compatible with the Control Room. For more information, see <a href="#">Automatic package updates for Cloud Control Room</a> on page 1907.</p> <ul style="list-style-type: none"><li>• For On-Premises Control Room instances, you can access these packages by enabling the package update feature.</li></ul> <p>For more information, see <a href="#">Automatic package updates for On-Premises Control Room</a> on page 1906.</p>
Will these package updates also be available in the main Automation 360 releases?	Yes, these package updates will be made available in subsequent Automation 360 releases.
I have an On-Premises deployment and I don't have auto-update enabled for packages. Can I get these package updates?	<p>Yes, you can manually upload the packages to the Control Room, and choose whether to enable them and set them as the default, or only enable them but not set them as the default.</p> <ul style="list-style-type: none"><li>• The package files are available for download on this page: <a href="#">Automation 360 package releases (A-People login required)</a>.</li><li>• For how-to information on uploading the packages to the Control Room, see <a href="#">Add packages to the Control Room</a> on page 1908.</li></ul>
Are these packages tested/validated like those available with main releases?	<p>Customer success and trust continue to be our #1 priority at Automation Anywhere. Our Quality Assurance teams will certify the updated packages for compatibility with the minimum Control Room and Bot Agent versions defined.</p> <p>For the minimum compatible Control Room and Bot Agent version defined for each package, see <a href="#">Periodic package updates - summary list</a> on page 836.</p>

How do I know if these packages are compatible with my Control Room?

Each package is associated with a minimum Control Room version that it is compatible with. For the minimum compatible Control Room version for each package, see [Periodic package updates - summary list](#) on page 836.

If I run into any issues with the new package version, what should I do?

These package updates are the same as those available with the main releases. So follow the same Support process in case you face any issues.

## Active Directory package updates

Review the updates in released versions of the Active Directory package such as new and enhanced features as well as fixes and limitations. The page also lists the release dates of each version, and the compatible Control Room and Bot Agent versions.

### Versions summary

The following table lists the versions of Active Directory package released either with an Automation 360 release or as a package-only release (in descending order of release dates). Click the version link for information about updates in that package version.

Version	Release date	Release type	Bot Agent version	Control Room build
<a href="#">3.9.0</a> on page 840	6 September 2023	With Automation 360 v.30 (Sandbox) release	20.11 or later	8750 or later
<a href="#">3.8.0</a> on page 841	6 June 2023	With Automation 360 v.29 (Sandbox) release	20.11 or later	8750 or later

### 3.9.0

- Compatible Bot Agent version: 20.11 or later
- Compatible Control Room version: 8750 or later

What's changed
<p>Help Center for developers</p> <ul style="list-style-type: none"> <li>• Help Center: We have added an in-app help for developers to get contextual information about and when building automations.</li> <li>• Added intuitive icons for in a .</li> </ul>



Fix
<p>The following issues in the package are fixed:</p> <ul style="list-style-type: none"> <li>You can use the <b>Rename user</b> action to rename the user logon name or the user name.</li> <li>You can use the <b>Rename group</b> action to rename an existing group.</li> </ul>

### 3.8.0

- Compatible Bot Agent version: 20.11 or later
- Compatible Control Room version: 8750 or later

Fixes
<p>In the Active Directory package, when you use user names with special DN (distinguished names) characters such as semicolon (;), hash sign (#), equal (=), plus (+), less than/greater than (&lt; &gt;), or backslash (\), the bot now runs successfully.</p> <p>Previously, when you add a user to a group and if the user name had special characters, the bot failed when you tried to remove the user from the group.</p>
<p>When you create bots using the <b>Run query</b> action from the Active Directory package, it retrieves the complete object name even if the name contains special characters such as ( or \).</p> <p>Previously, it retrieved partial object name when the name contained special characters such as ( or \).</p> <p>Service Cloud case ID: 01924111</p>

Related reference

[Active Directory package](#) on page 2374

Use the Active Directory package to automate actions in the Active Directory. An Active Directory is a directory service provided by Microsoft to assist the admin in managing users across a group or organization.

## AI package updates

Review the updates in released versions of the AI package such as new and enhanced features as well as fixes and limitations. The page also lists the release dates of each version, and the compatible Control Room and Bot Agent versions.

### Versions summary

The following table lists the versions of AI package released either with an Automation 360 release or as a package-only release (in descending order of release dates). Click the version link for information about updates in that package version.

Version	Release date	Release type	Bot Agent version	Control Room build
<a href="#">1.0.2</a> on page 842	20 October 2023	Package-only; post Automation 360 v.30 release	21.250 or later	18238 or later

## 1.0.2

- Compatible Bot Agent version: 21.250 or later
- Compatible Control Room version: 18238 or later

What's new
You can use the new AI package to send data to an AI model that is already deployed and receive a response. <a href="#">AI package</a> on page 2390

## Advanced Classifier package updates

Review the updates in released versions of the Advanced Classifier package such as new and enhanced features as well as fixes and limitations. The page also lists the release dates of each version, and the compatible Control Room and Bot Agent versions.

### Versions summary

The following table lists the versions of Advanced Classifier package released either with an Automation 360 release or as a package-only release (in descending order of release dates). Click the version link for information about updates in that package version.

Version	Release date	Release type	Bot Agent version	Control Room build
<a href="#">2.0.4</a> on page 842	6 June 2023	With Automation 360 v.29 (Sandbox) release	21.250 or later	17953 or later

## 2.0.4

- Compatible Bot Agent version: 21.250 or later
- Compatible Control Room version: 17953 or later

**What's New**

Use Advanced Classifier package in Document Automation

You can use the Advanced Classifier package to classify documents and pages, and split documents into a folder structure. You can upload documents from the folders to their respective learning instance to extract content in Document Automation. You must set up a Skillja license in a credential vault to run a bot containing actions from this package.

Related reference

[Advanced Classifier package](#) on page 2401

The Advanced Classifier package enables you to classify documents into a folder structure. You can upload the documents from the folders to the respective learning instance for content extraction in Document Automation.

## Apigee package updates

Review the updates in released versions of the Apigee package such as new and enhanced features as well as fixes and limitations. The page also lists the release dates of each version, and the compatible Control Room and Bot Agent versions.

### Versions summary

Version	Release date	Release type	Bot Agent version	Control Room build
<a href="#">2.0.1</a> on page 843	6 September 2023	With Automation 360 v.30 (Sandbox) release	21.222 or later	15422 or later
<a href="#">1.1.1</a> on page 844	6 June 2023	With Automation 360 v.29 (Sandbox) release	21.222 or later	15422 or later

### 2.0.1

- Compatible Bot Agent version: 21.222 or later
- Compatible Control Room version: 15422 or later

**What's new****Control room OAuth connection**

Use this connection method by creating a custom Apigee OAuth connection and storing it in the Control Room.

[Apigee Connect](#) on page 2414

**What's new****Apigee Execute Integration**

In the **Discover integrations to configure** option you can now select different authentication types from the drop-down list. The different authentication types supported are user account, service account, and Control room OAuth connection.

[Apigee Execute Integration](#) on page 2417

**1.1.1**

- Compatible Bot Agent version: 21.222 or later
- Compatible Control Room version: 15422 or later

**What's new**

Help Center for developers

- Help Center: We have added an in-app help for developers to get contextual information about and when building automations.

[In-product user assistance](#) on page 1159

- Added intuitive icons for in a .

Related concepts

[Apigee action package](#) on page 2413

Use the Apigee package to connect to an Apigee instance to run integrations and collaborate efficiently to function as one unit.

## App Integration package updates

Review the updates in released versions of the App Integration package such as new and enhanced features as well as fixes and limitations. The page also lists the release dates of each version, and the compatible Control Room and Bot Agent versions.

### Versions summary

The following table lists the versions of App Integration package released either with an Automation 360 release or as a package-only release (in descending order of release dates). Click the version link for information about updates in that package version.

Version	Release date	Release type	Bot Agent version	Control Room build
<a href="#">4.13.0</a> on page 845	6 September 2023	With Automation 360 v.30 (Sandbox) release	21.88 or later	10195 or later

Version	Release date	Release type	Bot Agent version	Control Room build
<a href="#">4.12.0</a> on page 845	6 June 2023	With Automation 360 v.29 (Sandbox) release	21.88 or later	10195 or later

### 4.13.0

- Compatible Bot Agent version: 21.88 or later
- Compatible Control Room version: 10195 or later

What's changed
<p>Help Center for developers</p> <ul style="list-style-type: none"> <li>• Help Center: We have added an in-app help for developers to get contextual information about and when building automations.</li> </ul> <p><a href="#">In-product user assistance</a> on page 1159</p> <ul style="list-style-type: none"> <li>• Added intuitive icons for in a .</li> </ul>

### 4.12.0

- Compatible Bot Agent version: 21.88 or later
- Compatible Control Room version: 10195 or later

What's changed
<p>Help Center for developers</p> <ul style="list-style-type: none"> <li>• Help Center: We have added an in-app help for developers to get contextual information about and when building automations.</li> </ul> <p><a href="#">In-product user assistance</a> on page 1159</p> <ul style="list-style-type: none"> <li>• Added intuitive icons for in a .</li> </ul>

Fix
<p>For all the actions in the App Integration package, the bot now displays a timeout message if the target application stops responding (more than 30 seconds).</p> <p>Service Cloud Case ID: 01868180</p>

Related reference

[App Integration package](#) on page 2423

Extract text from a window and save it to a string variable by using the actions in the App Integration package.

## Application package updates

Review the updates in released versions of the Application package such as new and enhanced features as well as fixes and limitations. The page also lists the release dates of each version, and the compatible Control Room and Bot Agent versions.

### Versions summary

The following table lists the versions of Application package released either with an Automation 360 release or as a package-only release (in descending order of release dates). Click the version link for information about updates in that package version.

Version	Release date	Release type	Bot Agent version	Control Room build
<a href="#">3.8.0 on page 846</a>	6 June 2023	With Automation 360 v.29 (Sandbox) release	20.11 or later	8750 or later

### 3.8.0

- Compatible Bot Agent version: 20.11 or later
- Compatible Control Room version: 8750 or later

What's changed
<p>Help Center for developers</p> <ul style="list-style-type: none"> <li>• Help Center: We have added an in-app help for developers to get contextual information about and when building automations.</li> </ul> <p><a href="#">In-product user assistance on page 1159</a></p> <ul style="list-style-type: none"> <li>• Added intuitive icons for in a .</li> </ul>

Related reference

[Application package on page 2428](#)

Use the **Open Program/File** action in the **Application** package to launch an application or a file. This action supports .exe, .bat, script files, or shortcut paths.

## Boolean package updates

Review the updates in released versions of the Boolean package such as new and enhanced features as well as fixes and limitations. The page also lists the release dates of each version, and the compatible Control Room and Bot Agent versions.

### Versions summary

The following table lists the versions of Boolean package released either with an Automation 360 release or as a package-only release (in descending order of release dates). Click the version link for information about updates in that package version.

Version	Release date	Release type	Bot Agent version	Control Room build
<a href="#">2.11.1</a> on page 847	6 December 2023	With Automation 360 v.31 (Sandbox) release	20.11 or later	8750 or later
<a href="#">2.9.0</a> on page 848	6 June 2023	With Automation 360 v.29 (Sandbox) release	20.11 or later	8750 or later

### 2.11.1

- Compatible Bot Agent version: 20.11 or later
- Compatible Control Room version: 8750 or later

What's new
Internal update in packages Minor update to support API tasks.

What's changed
Intuitive icons at package level We have added intuitive icons at the package level. In the Action pane, when you navigate through the different packages, these icons are displayed at the package level and provide contextual information about packages.

## 2.9.0

- Compatible Bot Agent version: 20.11 or later
- Compatible Control Room version: 8750 or later

What's changed
<p>Help Center for developers</p> <ul style="list-style-type: none"> <li>• Help Center: We have added an in-app help for developers to get contextual information about and when building automations.</li> </ul> <p><a href="#">In-product user assistance</a> on page 1159</p> <ul style="list-style-type: none"> <li>• Added intuitive icons for in a .</li> </ul>

Related reference

[Boolean package](#) on page 2430

The **Boolean** package contains actions that enable you to do various operations on boolean values.

## Bot Migration package updates

Review the updates in released versions of packagesuch as new and enhanced features as well as fixes and limitations. The page also lists the release dates of each version, and the compatible Control Room and Bot Agent versions.

### Versions summary

The following table lists the versions of Bot Migration package released either with an Automation 360 release or as a package-only release (in descending order of release dates). Click the version link for information about updates in that package version.

Version	Release date	Release type	Control Room build	Bot Agent version
<a href="#">10.8.2</a> on page 849	20 October 2023	With Automation 360 v.31 (Sandbox) release and periodic package update	21.220 or later	15224 or later
<a href="#">10.7.0</a> on page 849	6 September 2023 and 21 September 2023	With Automation 360 v.30 (Sandbox) release and periodic package update	21.220 or later	15224 or later



Version	Release date	Release type	Control Room build	Bot Agent version
<a href="#">10.6.2</a> on page 850	6 June 2023	With Automation 360 v.29 (Sandbox) release	21.220 or later	15224 or later

## 10.8.2

- Compatible Bot Agent version: 21.220 or later
- Compatible Control Room version: 15224 or later

**Note:** This version is also available in the v.31 release.

Fix
<p>You can migrate a bot that is using an array or dictionary variable in the session field of the Database <b>Connect</b> command without encountering an error.</p> <p>Previously, you were unable to migrate such a bot.</p> <p>Service Cloud case ID: 00743352, 01938224, 01946530</p>
<p>Fixed security vulnerability issues. For more information, click the release download link and view the Security &amp; Compliance reports at <a href="#">A-People Downloads page (Login required)</a>.</p>
<p>You no longer encounter any issue when you migrate a bot that contains multiple Email dictionary variable (EmailSentDate) key and run the bot in Automation 360.</p> <p>Previously, it displayed an error on execution.</p>

## 10.7.0

- Compatible Bot Agent version: 21.220 or later
- Compatible Control Room version: 15224 or later

What's changed
<p>In Enterprise 11, if a bot was using the FTP / SFTP commands, after migration, the respective FTP / SFTP actions are assigned a local session in Automation 360.</p> <p>Service Cloud case ID: 01274780</p> <p><a href="#">Package mapping for migration</a> on page 1620</p>

Fix
<p>After migration, you can successfully execute the action that is set in the <b>DefaultAction</b> object property of the Recorder action in a bot.</p> <p>Previously, such a bot was unable to execute the action and displayed an error.</p> <p>Service Cloud case ID: 01961896</p>
<p>You can migrate MetaBot with screens with 'play mode as image for linked objects' and 'play mode as text for main objects'.</p> <p>Previously, migration of such a MetaBot was not supported.</p>
<p>When you migrate a MetaBot Logic that contains linked object (static text and combo box) of UI Automation technology and used in a Recorder command to Automation 360, the bot now executes successfully.</p> <p>Previously, such a bot was failing to identify the combo box.</p>
<p>Using the Bot Migration package version <b>10.7.0</b>, you can migrate and execute a bot successfully that is using the Database package version <b>5.1.0</b> and FTP / SFTP package version <b>2.11.0</b>.</p> <p>Service Cloud case ID: 02000852</p>

## 10.6.2

- Compatible Bot Agent version: 21.220 or later
- Compatible Control Room version: 15224 or later

What's changed
<p>Help Center for developers</p> <p>Help Center: We have added an in-app help for developers to get contextual information about and when building automations.</p> <p><a href="#">In-product user assistance</a> on page 1159</p>

Fix
Fixed security vulnerability issues.

Related reference

[Bot migration package](#) on page 2433

The **Bot migration** package enables you to migrate Enterprise 10 and Enterprise 11 bots to Automation 360 format. The package also enables you to convert Enterprise 10, Enterprise 11, or Automation 360 bots that use Internet Explorer to Microsoft Edge with IE mode. This package is used internally by the Bot Migration Wizard and the Update Bot wizard.

## Browser package updates

Review the updates in released versions of the Browser package such as new and enhanced features as well as fixes and limitations. The page also lists the release dates of each version, and the compatible Control Room and Bot Agent versions.

### Versions summary

The following table lists the versions of Browser package released either with an Automation 360 release or as a package-only release (in descending order of release dates). Click the version link for information about updates in that package version.

Version	Release date	Release type	Bot Agent version	Control Room build
<a href="#">3.10.2</a> on page 851	16 November 2023	Package-only; post Automation 360 v.30 release	21.210 or later	14140 or later
<a href="#">3.10.1</a> on page 852	17 July 2023	Package-only; post Automation 360 v.29 release	21.210 or later	14140 or later
<a href="#">3.9.0</a> on page 852	6 June 2023	With Automation 360 v.29 (Sandbox) release	21.210 or later	14140 or later

### 3.10.2

- Compatible Bot Agent version: 21.210 or later
- Compatible Control Room version: 14140 or later

**Note:** This version is also available in the v.31 release.

Fix
<p>You no longer encounter an indefinite wait issue when you run a bot using <b>Browser &gt; Find broken links</b> action with <b>Scope</b> selected as <b>check the whole site</b> option. The bot now executes successfully and stores the output to a CSV file.</p> <p>Previously, if you provided the URL of a website having links with invalid URLs and selected the <b>check the whole site</b> option, the bot executed infinitely and failed to store the data in a CSV file.</p> <p>Service Cloud Case ID : 02003603</p>

### 3.10.1

- Compatible Bot Agent version: 21.210 or later
- Compatible Control Room version: 14140 or later

Fixes
Removed JxCapture dependency.
When you add a variable for an application window in any of the actions in the Browser package, the following error message is now displayed: <Name of the browser action> is not supported for the selected browser type.

### 3.9.0

- Compatible Bot Agent version: 21.210 or later
- Compatible Control Room version: 14140 or later

What's changed
Help Center for developers
Help Center: We have added an in-app help for developers to get contextual information about and when building automations.
<a href="#">In-product user assistance</a> on page 1159

Related reference

[Browser package](#) on page 2435

The Browser package contains actions that enable you to download files, find broken links, and launch a website. This package supports Google Chrome, Chromium-based Microsoft Edge, and Internet Explorer browsers.

## Clipboard package updates

Review the updates in released versions of the Clipboard package such as new and enhanced features as well as fixes and limitations. The page also lists the release dates of each version, and the compatible Control Room and Bot Agent versions.

### Versions summary

The following table lists the versions of Clipboard package released either with an Automation 360 release or as a package-only release (in descending order of release dates). Click the version link for information about updates in that package version.

Version	Release date	Release type	Bot Agent version	Control Room build
<a href="#">3.8.0</a> on page 853	6 December 2023	With Automation 360 v.31 (Sandbox) release	20.11 or later	8750 or later
<a href="#">3.7.0</a> on page 853	6 June 2023	With Automation 360 v.29 (Sandbox) release	20.11 or later	8750 or later

### 3.8.0

- Compatible Bot Agent version: 20.11 or later
- Compatible Control Room version: 8750 or later

What's changed
<p>Intuitive icons at package level</p> <p>We have added intuitive icons at the package level. In the Action pane, when you navigate through the different packages, these icons are displayed at the package level and provide contextual information about packages.</p>

### 3.7.0

- Compatible Bot Agent version: 20.11 or later
- Compatible Control Room version: 8750 or later

What's changed
<p>Help Center for developers</p> <p>Help Center: We have added an in-app help for developers to get contextual information about and when building automations.</p> <p><a href="#">In-product user assistance</a> on page 1159</p>

Related reference

[Clipboard package](#) on page 2447

The Clipboard package contains actions that enable you to automate using the Windows clipboard. Use the actions to copy a string value to the clipboard, copy the clipboard value to a string variable, and clear the clipboard.

## Comment package updates

Review the updates in released versions of the Comment package such as new and enhanced features as well as fixes and limitations. The page also lists the release dates of each version, and the compatible Control Room and Bot Agent versions.

### Versions summary

The following table lists the versions of Comment package released either with an Automation 360 release or as a package-only release (in descending order of release dates). Click the version link for information about updates in that package version.

Version	Release date	Release type	Bot Agent version	Control Room build
<a href="#">2.16.0 on page 854</a>	6 December 2023	With Automation 360 v.31 (Sandbox) release	20.11 or later	8750 or later
<a href="#">2.14.0 on page 854</a>	6 June 2023	With Automation 360 v.29 (Sandbox) release	20.11 or later	8750 or later

### 2.16.0

- Compatible Bot Agent version: 20.11 or later
- Compatible Control Room version: 8750 or later

What's changed
<p>Intuitive icons at package level</p> <p>We have added intuitive icons at the package level. In the Action pane, when you navigate through the different packages, these icons are displayed at the package level and provide contextual information about packages.</p>

### 2.14.0

- Compatible Bot Agent version: 20.11 or later
- Compatible Control Room version: 8750 or later

**What's changed**

Help Center for developers

- Help Center: We have added an in-app help for developers to get contextual information about and when building automations.

[In-product user assistance](#) on page 1159

- Added intuitive icons for in a .

Related reference

[Comment package](#) on page 2452

Use the `Comment` package to insert a user-specified comment into your bot logic.

## Credential package updates

Review the updates in released versions of the Credential package such as new and enhanced features as well as fixes and limitations. The page also lists the release dates of each version, and the compatible Control Room and Bot Agent versions.

### Versions summary

The following table lists the versions of Credential package released either with an Automation 360 release or as a package-only release (in descending order of release dates). Click the version link for information about updates in that package version.

Version	Release date	Release type	Bot Agent version	Control Room build
<a href="#">1.7.1</a> on page 855	6 December 2023	With Automation 360 v.31 (Sandbox) release	20.11 or later	8750 or later
<a href="#">1.6.0</a> on page 856	6 June 2023	With Automation 360 v.29 (Sandbox) release	20.11 or later	8750 or later

### 1.7.1

- Compatible Bot Agent version: 20.11 or later
- Compatible Control Room version: 8750 or later

**What's new**

Internal update in packages

Minor update to support API tasks.

**What's changed**

Intuitive icons at package level

We have added intuitive icons at the package level. In the Action pane, when you navigate through the different packages, these icons are displayed at the package level and provide contextual information about packages.

**1.6.0**

- Compatible Bot Agent version: 20.11 or later
- Compatible Control Room version: 8750 or later

**What's changed**

Help Center for developers

- Help Center: We have added an in-app help for developers to get contextual information about and when building automations.

[In-product user assistance](#) on page 1159

- Added intuitive icons for in a .

Related reference

[Credential package](#) on page 2448

In the Credential package, use the **Assign** action to assign an insecure string or a variable value directly to the credential variable.

## CSV/TXT package updates

Review the updates in released versions of the CSV/TXT package such as new and enhanced features as well as fixes and limitations. The page also lists the release dates of each version, and the compatible Control Room and Bot Agent versions.

### Versions summary

The following table lists the versions of CSV/TXT package released either with an Automation 360 release or as a package-only release (in descending order of release dates). Click the version link for information about updates in that package version.

Version	Release date	Release type	Bot Agent version	Control Room build
<a href="#">2.13.0</a> on page 857	6 December 2023	With Automation 360 v.31 (Sandbox) release	20.11 or later	8750 or later



Version	Release date	Release type	Bot Agent version	Control Room build
<a href="#">2.12.0</a> on page 857	6 June 2023	With Automation 360 v.29 (Sandbox) release	20.11 or later	8750 or later

## 2.13.0

- Compatible Bot Agent version: 20.11 or later
- Compatible Control Room version: 8750 or later

What's changed
<p>Intuitive icons at package level</p> <p>We have added intuitive icons at the package level. In the Action pane, when you navigate through the different packages, these icons are displayed at the package level and provide contextual information about packages.</p>

## 2.12.0

- Compatible Bot Agent version: 20.11 or later
- Compatible Control Room version: 8750 or later

What's changed
<p>Help Center for developers</p> <p>Help Center: We have added an in-app help for developers to get contextual information about and when building automations.</p> <p><a href="#">In-product user assistance</a> on page 1159</p>

Related reference

[CSV/TXT package](#) on page 2449

The **CSV/TXT** package contains actions that enable you to open a CSV or text file, read data from that file, and assign the data to a Table variable. This package supports files encoded in ANSI, Unicode, UTF-8, or Windows-1251, and can process up to one million records.

## Data Table package updates

Review the updates in released versions of the Data Table package such as new and enhanced features as well as fixes and limitations. The page also lists the release dates of each version, and the compatible Control Room and Bot Agent versions.

### Versions summary

The following table lists the versions of Data Table package released either with an Automation 360 release or as a package-only release (in descending order of release dates). Click the version link for information about updates in that package version.

Version	Release date	Release type	Bot Agent version	Control Room build
<a href="#">4.8.0 on page 858</a>	6 June 2023	With Automation 360 v.29 (Sandbox) release	20.11 or later	8750 or later

### 4.8.0

- Compatible Bot Agent version: 20.11 or later
- Compatible Control Room version: 8750 or later

What's changed
<p>Help Center for developers</p> <ul style="list-style-type: none"> <li>• Help Center: We have added an in-app help for developers to get contextual information about and when building automations.</li> </ul> <p><a href="#">In-product user assistance</a> on page 1159</p> <ul style="list-style-type: none"> <li>• Added intuitive icons for in a .</li> </ul>

Related reference

[Data Table package](#) on page 2452

The Data Table package contains actions that enable you to perform various operations on the values of table variables. Use these actions to join or merge content, search for specific values, insert rows and columns, remove duplicate rows, and write values to a file.

## Database package updates

Review the updates in released versions of the Database package such as new and enhanced features as well as fixes and limitations. The page also lists the release dates of each version, and the compatible Control Room and Bot Agent versions.

### Versions summary

The following table lists the versions of Database package released either with an Automation 360 release or as a package-only release (in descending order of release dates). Click the version link for information about updates in that package version.

Version	Release date	Release type	Bot Agent version	Control Room build
<a href="#">5.2.1</a> on page 859	6 December 2023	With Automation 360 v.31 (Sandbox) release	21.88 or later	10204 or later
<a href="#">5.1.0</a> on page 859	16 August 2023	Package-only; post Automation 360 v.29 release	21.88 or later	10204 or later
<a href="#">4.12.2</a> on page 861	6 June 2023	With Automation 360 v.29 (Sandbox) release	21.88 or later	10204 or later

#### 5.2.1

- Compatible Bot Agent version: 21.88 or later
- Compatible Control Room version: 10204 or later

What's changed
Internal update in packages Minor update to support API tasks.

#### 5.1.0

- Compatible Bot Agent version: 21.88 or later
- Compatible Control Room version: 10204 or later

**Note:** This version is also available in the v.30 release.

#### What's new

Database package enhancements (Service Cloud case ID: 01881930, 01981681, 00743352, 01938224, 01946530, 01938224)

The following enhancements have been added to the Database package for Pro and Citizen Developers.

- Ability to share the Database session across parent and child bots.
  - You can now create a new global session using the **Database > Connect** action and pass this session from a parent to child bots or reuse this session in other actions of the Database package. This feature ensures data consistency in each bot because you perform the database operations on a standard set of data.
  - You can create a new session variable of the type database session to store the database sessions.
  - The existing session name field has been renamed to **Create Database session**.
- In default mode, you can now define connection strings with variables to substitute credentials such as username and password or any other security-related data in the **Connect** action. You can map these variables with credential vault values to ensure that sensitive information is not exposed in the connection string.
- You can now connect to any database with the JDBC connection string for the user-defined database option. This helps to significantly reduce development time and maintenance overhead because you are no longer required to automate processes that involve other databases.

[Using Connect action for database](#) on page 2469

#### What's changed

Changes to storing the database schema in Disconnect action (Service Cloud case ID: 00743352, 01938224, 01946530, 01938224)

In the **Disconnect** action, if you select the **Keep database schema in cache until bot finishes running** option and then try to create a new database session after the **Disconnect** action, while keeping the same session name as the previous one, an error occurs, and the new database session is not created. To avoid this, leave the **Keep database schema in cache until bot finishes running** option unchecked.

[Disconnect action](#) on page 2474

#### Fixes

For the **Insert/Update/Delete** action in the Database package, the 'Stream Closed' error is no longer displayed when you run a large SQL query (up to 65K ASCII text) over an ODBC connection.

Service Cloud case ID: 01991720

Fixes
Fixed the vulnerabilities reported in the security scan. Service Cloud case ID: 01967285

#### 4.12.2

- Compatible Bot Agent version: 21.88 or later
- Compatible Control Room version: 10204 or later

Fix
Fixed the vulnerabilities reported in the security scan. Service Cloud case ID: 01967285

Related reference

[Database package](#) on page 2466

Databases support internal operations of an enterprise by storing a variety of data, such as sales transactions, product catalogs, inventories, and customer profiles. Use the Database package to connect to a database, begin a transaction, and manipulate the stored data by retrieving, inserting, updating, deleting, and exporting it to a CSV file.

## Datetime package updates

Review the updates in released versions of the Datetime package such as new and enhanced features as well as fixes and limitations. The page also lists the release dates of each version, and the compatible Control Room and Bot Agent versions.

### Versions summary

The following table lists the versions of Datetime package released either with an Automation 360 release or as a package-only release (in descending order of release dates). Click the version link for information about updates in that package version.

Version	Release date	Release type	Bot Agent version	Control Room build
<a href="#">2.14.0</a> on page 862	6 December 2023	With Automation 360 v.31 (Sandbox) release	20.11 or later	8750 or later
<a href="#">2.12.1</a> on page 862	6 June 2023	With Automation 360 v.29 (Sandbox) release	20.11 or later	8750 or later

## 2.14.0

- Compatible Bot Agent version: 20.11 or later
- Compatible Control Room version: 8750 or later

What's changed
<p>Intuitive icons at package level</p> <p>We have added intuitive icons at the package level. In the Action pane, when you navigate through the different packages, these icons are displayed at the package level and provide contextual information about packages.</p>

## 2.12.1

- Compatible Bot Agent version: 20.11 or later
- Compatible Control Room version: 8750 or later

What's changed
<p>Help Center for developers</p> <p>Help Center: We have added an in-app help for developers to get contextual information about and when building automations.</p> <p><a href="#">In-product user assistance</a> on page 1159</p>

Related reference

[Datetime package](#) on page 2484

A datetime value consists of a date, time, and time zone. Automation Workspace stores datetime values in a Datetime variable. The **Datetime** package contains actions that enable you to perform various operations on datetime values. You can use these actions to manipulate and compare values in the Datetime variables.

## Delay package updates

Review the updates in released versions of the Delay package such as new and enhanced features as well as fixes and limitations. The page also lists the release dates of each version, and the compatible Control Room and Bot Agent versions.

### Versions summary

The following table lists the versions of Delay package released either with an Automation 360 release or as a package-only release (in descending order of release dates). Click the version link for information about updates in that package version.

Version	Release date	Release type	Bot Agent version	Control Room build
<a href="#">3.9.1</a> on page 863	6 December 2023	With Automation 360 v.31 (Sandbox) release	20.11 or later	8750 or later
<a href="#">3.8.0</a> on page 863	6 June 2023	With Automation 360 v.29 (Sandbox) release	20.11 or later	8750 or later

### 3.9.1

- Compatible Bot Agent version: 20.11 or later
- Compatible Control Room version: 8750 or later

What's changed
<p>Intuitive icons at package level</p> <p>We have added intuitive icons at the package level. In the Action pane, when you navigate through the different packages, these icons are displayed at the package level and provide contextual information about packages.</p>

### 3.8.0

- Compatible Bot Agent version: 20.11 or later
- Compatible Control Room version: 8750 or later

What's changed
<p>Functionality to set delay time value to 0</p> <p>In the <b>Delay &gt; Delay</b> action, you can now set the delay time value to 0 seconds or milliseconds. Previously when the delay time value was set to 0, the bot encountered an error during execution.</p>
<p>Help Center for developers</p> <ul style="list-style-type: none"> <li>• Help Center: We have added an in-app help for developers to get contextual information about and when building automations.</li> </ul> <p><a href="#">In-product user assistance</a> on page 1159</p> <ul style="list-style-type: none"> <li>• Added intuitive icons for in a .</li> </ul>

Related reference

[Delay package](#) on page 2492

Use the `Delay` package to add a timed delay to the logic.

## Dictionary package updates

Review the updates in released versions of the Dictionary package such as new and enhanced features as well as fixes and limitations. The page also lists the release dates of each version, and the compatible Control Room and Bot Agent versions.

### Versions summary

The following table lists the versions of Dictionary package released either with an Automation 360 release or as a package-only release (in descending order of release dates). Click the version link for information about updates in that package version.

Version	Release date	Release type	Bot Agent version	Control Room build
<a href="#">3.14.0</a> on page 864	6 December 2023	With Automation 360 v.31 (Sandbox) release	20.11 or later	8750 or later
<a href="#">3.12.0</a> on page 865	6 June 2023	With Automation 360 v.29 (Sandbox) release	20.11 or later	8750 or later

### 3.14.0

- Compatible Bot Agent version: 20.11 or later
- Compatible Control Room version: 8750 or later

What's new
Internal update in packages Minor update to support API tasks.

What's changed
Intuitive icons at package level We have added intuitive icons at the package level. In the Action pane, when you navigate through the different packages, these icons are displayed at the package level and provide contextual information about packages.



### 3.12.0

- Compatible Bot Agent version: 20.11 or later
- Compatible Control Room version: 8750 or later

What's changed
<p>Help Center for developers</p> <ul style="list-style-type: none"> <li>• Help Center: We have added an in-app help for developers to get contextual information about and when building automations.</li> </ul> <p><a href="#">In-product user assistance</a> on page 1159</p> <ul style="list-style-type: none"> <li>• Added intuitive icons for in a .</li> </ul>

Related reference

[Dictionary package](#) on page 2493

The **Dictionary** package contains actions that enable you to do various operations on dictionary-type values.

## DLL package updates

Review the updates in released versions of the DLL package such as new and enhanced features as well as fixes and limitations. The page also lists the release dates of each version, and the compatible Control Room and Bot Agent versions.

### Versions summary

The following table lists the versions of DLL package released either with an Automation 360 release or as a package-only release (in descending order of release dates). Click the version link for information about updates in that package version.

Version	Release date	Release type	Bot Agent version	Control Room build
<a href="#">6.10.2</a> on page 865	17 July 2023	Package-only; post Automation 360 v.29 release	21.22 or later	15238 or later
<a href="#">6.9.0</a> on page 866	6 June 2023	With Automation 360 v.29 (Sandbox) release	21.22 or later	15238 or later

### 6.10.2

- Compatible Bot Agent version: 21.22 or later

- Compatible Control Room version: 15238 or later

**Note:** This version is also available in the v.30 release.

Fix
<p>When you work with <b>Run function</b> action and uses the following DLL function, the output will be retrieved as:</p> <ul style="list-style-type: none"><li>• If the DLL function return type is String (string) and the output is null, it will retrieve an empty string.</li><li>• If the DLL function return type is Array of String (string []) and the output is null, it will retrieve an empty array of strings.</li><li>• If the DLL function return type is List of String (List&lt;string&gt;) and the output is null, it will retrieve an empty list of strings.</li></ul> <p>Previously, when you used the DLL function return type as String (string), Array of String (string []), or List of String (List&lt;string&gt;), and if it contained a NULL value, the output retrieved as <code>true</code> string.</p> <p>Service Cloud Case ID: 01964812, 01970306</p>

## 6.9.0

- Compatible Bot Agent version: 21.22 or later
- Compatible Control Room version: 15238 or later

What's changed
<p>Help Center for developers</p> <ul style="list-style-type: none"><li>• Help Center: We have added an in-app help for developers to get contextual information about and when building automations. <a href="#">In-product user assistance</a> on page 1159</li><li>• Added intuitive icons for in a .</li></ul>

Related reference

[DLL package](#) on page 2498

A dynamic-link library (DLL) file contains a shared library of functions that can be used by Windows programs. The **DLL** package uses a .d11 file as reference and calls functions from the bot.

## Document Extraction package updates

Review the updates in released versions of the Document Extraction packagesuch as new and enhanced features as well as fixes and limitations. The page also lists the release dates of each version, and the compatible Control Room and Bot Agent versions.

### Versions summary

The following table lists the versions of Document Extraction package released either with an Automation 360 release or as a package-only release (in descending order of release dates). Click the version link for information about updates in that package version.

Version	Release date	Release type	Bot Agent version	Control Room build
<a href="#">3.31.17</a> on page 868	22 December 2023	Package-only; post Automation 360 v.31 (Sandbox) release	21.252 or later	19223 or later
<a href="#">3.31.16</a> on page 868	6 December 2023	With Automation 360 v.31 (Sandbox) release	21.252 or later	19223 or later
<a href="#">3.31.15</a> on page 868	28 November 2023	With Automation 360 v.30 release	21.252 or later	19223 or later
<a href="#">3.31.13</a> on page 869	16 November 2023	Package-only; post Automation 360 v.30 release	21.252 or later	19223 or later
<a href="#">3.30.24</a>	21 September 2023	Package-only; post Automation 360 v.30 (Sandbox) release	21.252 or later	19223 or later
<a href="#">3.30.22</a>	6 September 2023	With Automation 360 v.30 (Sandbox) release	21.252 or later	19223 or later
<a href="#">3.30.21</a> on page 871	21 August 2023	Package-only; post Automation 360 v.29	21.98 or later	15345 or later
<a href="#">3.30.19</a>	16 August 2023	Package-only; post Automation 360 v.29	21.98 or later	15345 or later

Version	Release date	Release type	Bot Agent version	Control Room build
<a href="#">3.29.17</a> on page 872	17 July 2023	Package-only; post Automation 360 v.29 release	21.98 or later	15345 or later
<a href="#">3.29.14</a> on page 873	6 June 2023	With Automation 360 v.29 (Sandbox) release	21.98 or later	15345 or later

### 3.31.17

- Compatible Bot Agent version: 21.252 or later
- Compatible Control Room version: 19223 or later

Fixes
<p>With Google Vision OCR, you can now process the documents successfully without a Google Document AI license. Also, it does not generate an error message.</p> <p>Previously, it requested a Google Document AI license to process the documents and generated error while extracting documents. As a result, you were not able to extract documents with Google Vision OCR.</p> <p>Service Cloud Case ID: 02097428, 02096992, 02097798, 02097157, 02098378, 02098563, 02094573</p>

### 3.31.16

- Compatible Bot Agent version: 21.252 or later
- Compatible Control Room version: 19223 or later

Fixes
<p>When users create a learning instance with Google Document AI (BYOK) and authenticated proxy, the document extraction no longer fails for more than 10 pages document.</p> <p>Previously, in such cases, extraction failed with an error message and users were not able to process the documents.</p>

### 3.31.15

- Compatible Bot Agent version: 21.252 or later
- Compatible Control Room version: 19223 or later

**Fixes**

If **Document rules** contain multiple conditions using the **AND** operator with (or without) a group, an appropriate error message is now displayed. Also, the corresponding action is now applied on the fields.

**3.31.13**

- Compatible Bot Agent version: 21.252 or later
- Compatible Control Room version: 19223 or later

**What's Changed**

With improved extraction of unstructured documents in Document Automation, you can:

- Process complex queries effectively.
- Validate documents with improved navigation to relevant page.

**Fixes**

With improved table extraction using the ABBYY OCR engine, heuristic feedback is now working properly.

- For **German** language, invoice extraction works correctly after applying feedback and all the table data is extracted.
- For **Spanish** language, table data is extracted correctly from the invoice document.
- For **English** language, the invoice data is extracted from all the pages with ABBYY OCR.

Service Cloud Case ID: 01995901

When a user extracts the table data from a PDF file where table is expanded to multiple pages, the data from all the pages extracted successfully after applying the heuristic feedback.

Previously, users were not able to extract data from the second page of the PDF file where table is expanded to multiple pages.

Service Cloud Case ID: 01996536

Starting the extraction from first page for all the fields, the heuristic feedback is now working properly for multi-line table data capturing and generates the correct output.

Previously, the multi-line table data was not extracted even after providing the heuristic feedback. As a result, the output was not generated properly.

Service Cloud Case ID: 01944805, 01946809, 01952836, 01957090, 01975800, 01981088, 01944805, 01946809, 01952836, 01957090

For Microsoft Standard Forms, the table extraction no longer fails when cells are empty and users can extract the document successfully.

When a user imports a leaning instance and process the documents, the extracted document shows the correct order of words for dates in all the pages.

Fixes
<p>When a user imports a learning instance and process the documents, all the values are displayed in the table after extraction.</p> <p>Previously, in such cases, the system-identified region (SIR) was highlighted but an empty value was shown in the table.</p>
<p>When a user imports a .dw file with heuristic feedback and process a document that contains (-) value in the last row, the documents are extracted correctly without skipping the negative value in last row.</p> <p>Previously, in such cases, the last row was skipped resulting into either data loss or incorrect processing.</p>
<p>When a user processes a document that contains table, the extraction finishes successfully without the DOCUMENT_PARTIALLY_FAILED or Extraction Timeout error message.</p> <p>Previously, in such cases, some documents were not extracted because of multiple detections from the same table and caused table size (max () arg) issue.</p>
<p>When a user imports a learning instance and process the documents, all the rows are extracted separately from all pages.</p> <p>Previously, rows from second page were merged into one row.</p>

Limitations
<p>When a user uses the Google Vision OCR, the table detection or extraction will not work.</p> <p>Workaround: It is recommended to use the ABBYY OCR engine.</p> <p>Service Cloud Case ID: 01995901</p>
<p>In specific cases, where the tables are spanned across multiple pages without headers in all the pages (header less pages), users might observe that the data is not getting extracted from all the pages after applying the feedback.</p>

### 3.30.24

- Compatible Bot Agent version: 21.252 or later
- Compatible Control Room version: 19223 or later

Fixes
<p>Users can now view the extracted data from second row correctly by using the heuristic feedback.</p>
<p>For the <b>Purchase Order</b> document type, you can now extract the table field values correctly from all the pages.</p>
<p>The generated feedback file no longer shows any error message and users can process documents successfully.</p>

### 3.30.22

- Compatible Bot Agent version: 21.252 or later
- Compatible Control Room version: 19223 or later

What's New
Document Automation provides an improved extraction through new <b>Get document data</b> and <b>Update document data</b> actions. You can use these actions to apply custom logic for data manipulation and validation to maximize straight-through processing (STP) and reduce manual verification efforts.

### 3.30.21

- Compatible Bot Agent version: 21.98 or later
- Compatible Control Room version: 15345 or later

Fixes
This Document Extraction package release is a patch to fix the '501: DOCUMENT_PARTIALLY_FAILED' error that occurred while processing some documents.

### 3.30.19

- Compatible Bot Agent version: 21.98 or later
- Compatible Control Room version: 15345 or later

Fixes
-------

**Fixes**

The Document Extraction package provides improved extraction capability for complex table header columns.

- Scenario 1: Extracting data from table column headers with multiple headers merged into a single column.
- Scenario 2: Extracting data from table column headers with multiple split sub-headers.

Follow these steps to enable improved table header data extraction:

1. Create or edit a learning instance.
2. To add or edit the table fields, navigate to the **Table fields** tab, and click the **Add a field > Field Properties**.
3. Add each table header as a separate table field. For Example:
 

Scenario 1: Add the column header and each merged sub-header as a separate table field. Using the screen-shot as a reference, you would extract data from the three merged column header fields, for which you would create three separate table fields such as CGST with alias CGST, SGST with alias SGST, and CESS with alias CESS.

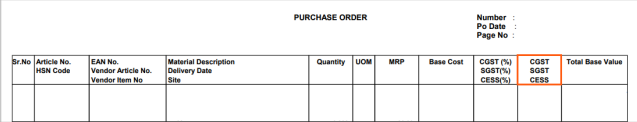

Scenario 2: Add the column header and each split sub-header as a separate table field. Similar to the above example, for a column header CGST with split sub-headers Rate and AMT, you would need to create two separate table fields CGST Rate with alias CGST Rate, and CGST AMT with alias CGST AMT.

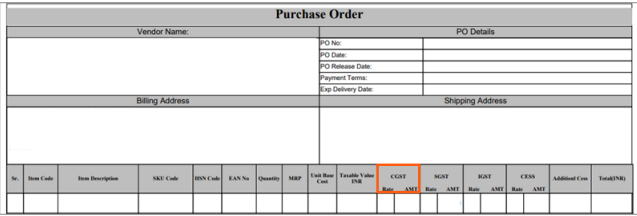
4. Click **Submit** to save your updates.

**3.29.17**

- Compatible Bot Agent version: 21.98 or later
- Compatible Control Room version: 15345 or later

**Fixes**

The Document Extraction package has extraction improvement fixes for both form and table fields.



### 3.29.14

- Compatible Bot Agent version: 21.98 or later
- Compatible Control Room version: 15345 or later

#### What's New

Document Automation provides an improved extraction through heuristic feedback with a focus on complex scenarios, such as multitables. Additionally, there are extraction improvements for both form fields and out-of-the-box performance (specifically for table fields).

## Email package updates

Review the updates in released versions of the Email package such as new and enhanced features as well as fixes and limitations. The page also lists the release dates of each version, and the compatible Control Room and Bot Agent versions.

### Versions summary

The following table lists the versions of Email package released either with an Automation 360 release or as a package-only release (in descending order of release dates). Click the version link for information about updates in that package version.

Version	Release date	Release type	Bot Agent version	Control Room build
<a href="#">3.19.2</a> on page 873	6 December 2023	With Automation 360 v.31 (Sandbox) release	21.210 or later	13980 or later
<a href="#">3.18.2</a> on page 874	6 September 2023	With Automation 360 v.30 (Sandbox) release	21.210 or later	13980 or later
<a href="#">3.17.6</a> on page 875	6 June 2023	With Automation 360 v.29 (Sandbox) release	21.210 or later	13980 or later

### 3.19.2

- Compatible Bot Agent version: 21.210 or later
- Compatible Control Room version: 13980 or later

Fix
<p>When you create a bot using the Email package, establish a connection with the <b>Outlook</b> client, and use <b>Move all</b> action, the bot moves the emails to the correct destination folder even if the folder names are similar.</p> <p>Service Cloud case ID: 01973624</p>

### 3.18.2

- Compatible Bot Agent version: 21.210 or later
- Compatible Control Room version: 13980 or later

Fixes
<p>Create a bot to read emails that have regular and embedded attachments in the message body and perform the following steps:</p> <ol style="list-style-type: none"> <li>1. Use the <b>Save attachment</b> action and select <b>HTML</b> or <b>PLAIN TEXT</b> format in the message body.</li> <li>2. Use the dictionary variable emailNoOfAttachments to retrieve the attachment count and print it in the message box.</li> </ol> <p>When you run the bot, it will display the correct attachment count.</p> <p>Service Cloud case ID: 01971661</p>
<p>When you use actions such as <b>Reply</b> or <b>Forward</b> and connect to an email server with authentication type as <b>Client credentials</b>, the email shows the Sender address correctly. Previously, the email displayed the Sender's address as unknown.</p> <p>Service Cloud case ID: 01966831</p>
<p>A bot no longer displays an error and an email is sent in the following scenario: When you use actions such as <b>Send, Forward, Reply, ReplyAll</b> and connect to the EWS server, choose OAuth 2 (Client credentials or PKCE) authentication mode, and deselect the <b>Raise error if the attachments are missing</b>.</p> <p>Service Cloud case ID: 01955838</p>
<p>Send email now works for locally hosted SMTP using the email server option.</p> <p>Previously, if you used port 465 for a secured SMTP server and selected <b>Use secure connection (SSL/TLS)</b> option as <b>False</b>, the bot failed and displayed an error message.</p> <p>Service Cloud case ID: 01961465</p>

**Known limitation**

When you connect with the **EWS** server and use **Loop** action to retrieve all the emails from the email server, and if the email subject contains the following characters, the bot fails to execute and displays an error message.

- Control characters
  - Range: 0x00 - 0x08 (except 0x09 - Horizontal Tab) and 0x0B - 0x0C (except 0x0A - Line Feed and 0x0D - Carriage Return)
  - Hexadecimal values: 0x00-0x08, 0x0B-0x0C, 0x0E-0x1F
- High surrogate and low surrogate pairs
  - Range: 0xD800 - 0xDFFF
  - Hexadecimal values: 0xD800 - 0xDFFF
- Non-character code points
  - Range: 0xFDD0 - 0xFDEF, 0xFFFFE - 0xFFFF
  - Hexadecimal values: 0xFDD0 - 0xFDEF, 0xFFFFE - 0xFFFF
- Restricted ranges
  - Range: 0x1FFFE - 0x1FFFF, 0x2FFFE - 0x2FFFF, 0x3FFFE - 0x3FFFF, 0x4FFFE - 0x4FFFF, 0x5FFFE - 0x5FFFF, 0x6FFFE - 0x6FFFF, 0x7FFFE - 0x7FFFF, 0x8FFFE - 0x8FFFF, 0x9FFFE - 0x9FFFF, 0xAFFFE - 0xAFFFF, 0xBFFFE - 0xBFFFF, 0xCFFFE - 0xCFFFF, 0xDFFFE - 0xDFFFF, 0xEFFFE - 0xEFFFF, 0xFFFFE - 0xFFFFF, 0x10FFFE - 0x10FFFF
  - Hexadecimal values: 0x1FFFE - 0x1FFFF, 0x2FFFE - 0x2FFFF, 0x3FFFE - 0x3FFFF, 0x4FFFE - 0x4FFFF, 0x5FFFE - 0x5FFFF, 0x6FFFE - 0x6FFFF, 0x7FFFE - 0x7FFFF, 0x8FFFE - 0x8FFFF, 0x9FFFE - 0x9FFFF, 0xAFFFE - 0xAFFFF, 0xBFFFE - 0xBFFFF, 0xCFFFE - 0xCFFFF, 0xDFFFE - 0xDFFFF, 0xEFFFE - 0xEFFFF, 0xFFFFE - 0xFFFFF, 0x10FFFE - 0x10FFFF

Service Cloud case ID: 01983181

**3.17.6**

- Compatible Bot Agent version: 21.210 or later
- Compatible Control Room version: 13980 or later

**What's new**

Enhanced error messages displayed during bot execution (Service Cloud case ID: 01887882)

When you create a bot using the **Send email** action with incorrect attachment logic, the bot execution fails and displays the following more detailed error message: `Incorrect inputs are specified for the Attachment field` when bot execution fails.

**What's new**

Email ID invalid option added to Send email action (Service Cloud case ID:01823424)

A new **Raise error if the email ids are invalid** option has been added to the **Send email** action of the Email package. If you add multiple addresses in the **To address** section and if any of the user email addresses are deactivated or invalid, the bot will display an appropriate error message.

[Using Send action](#) on page 2540

**Fixes**

You can create a bot using **Email package > Connect > IMAP protocol** with OAuth2 PKCE flow, then use **Save attachment** action in a **Loop** with an iterator as **For each mail in mailbox**.

Previously, when you used **Save attachment** action within a loop and if emails contained attachments with a colon character (:) in the attachment name, the bot failed at the loop action with an error.

Service Cloud case ID: 01937048, 01911264, 01938122, 01943463, 01952184, 01959982, 01964181

You no longer encounter any issues when you use the **Email package > Connect** action with the **EWS** option and can perform email-related operations such as reading or sending emails.

Previously, when you used actions from the Email package, it was not working and threw a connection timeout if the proxy was configured.

Service Cloud case ID: 01940196, 01937082, 01925438

You can now use the **Connect** action in the **Email** package along with other actions (such as **Reply** or **Forward**) from the same package in a bot without any issues.

Service Cloud Case ID: 01908595

Related reference

[Email package](#) on page 2517

The Email package contains actions to automate email-related tasks through Exchange Web Services (EWS), Microsoft Outlook, and other email servers. You can use these actions for sending, receiving, and modifying messages, folders, and the status of messages.

## Email trigger package updates

Review the updates in released versions of the Email trigger package such as new and enhanced features as well as fixes and limitations. The page also lists the release dates of each version, and the compatible Control Room and Bot Agent versions.

### Versions summary

The following table lists the versions of Email trigger package released either with an Automation 360 release or as a package-only release (in descending order of release dates). Click the version link for information about updates in that package version.

Version	Release date	Release type	Bot Agent version	Control Room build
<a href="#">2.10.2-20230106-091325</a> on page 877	June 2023	With Automation 360 v.29 (Sandbox) release	21.210 or later	13980 or later

### 2.10.2-20230106-091325

- Compatible Bot Agent version: 21.210 or later
- Compatible Control Room version: 13980 or later

Fixes
The bot no longer encounters any error when you use <b>Email &gt; Outlook client</b> where the <b>Subject</b> contains double quotes or has space in it.
When you create a bot using an Email trigger, the output of the trigger can be assigned to the Record type variable. You cannot assign the output to multiple variables because the <b>Multiple variables</b> option is not supported in the Email triggers. Service Cloud case ID: 01803026

Related concepts

[Adding a trigger to run a bot](#) on page 2286

Add triggers that can automatically run the selected bot whenever a specific event occurs. For example, clicking a specific button or using a combination of keystrokes.

## Error handler package updates

Review the updates in released versions of the Error handler package such as new and enhanced features as well as fixes and limitations. The page also lists the release dates of each version, and the compatible Control Room and Bot Agent versions.

### Versions summary

The following table lists the versions of Error handler package released either with an Automation 360 release or as a package-only release (in descending order of release dates). Click the version link for information about updates in that package version.

Version	Release date	Release type	Bot Agent version	Control Room build
<a href="#">2.11.3-20230316-162433</a> on page 878	June 2023	With Automation 360 v.29 (Sandbox) release	20.11 or later	8750 or later

### 2.11.3-20230316-162433

- Compatible Bot Agent version: 20.11 or later
- Compatible Control Room version: 8750 or later

What's changed
<p>Help Center for developers</p> <ul style="list-style-type: none"> <li>• Help Center: We have added an in-app help for developers to get contextual information about and when building automations.</li> </ul> <p><a href="#">In-product user assistance</a> on page 1159</p> <ul style="list-style-type: none"> <li>• Added intuitive icons for in a .</li> </ul>

Related reference

[Error handler package](#) on page 2552

If a bot encounters an error due to an abnormal condition or exceptions during execution, the normal execution of the bot is hindered, and the bot fails to complete the task. The Error handler package contains actions that enable you to easily handle exceptions a bot encounters and transfers control to the other actions within that bot.

## Excel advanced package updates

Review the updates in released versions of the Excel advanced package such as new and enhanced features as well as fixes and limitations. The page also lists the release dates of each version, and the compatible Control Room and Bot Agent versions.

### Versions summary

The following table lists the versions of Excel advanced package released either with an Automation 360 release or as a package-only release (in descending order of release dates). Click the version link for information about updates in that package version.

Version	Release date	Release type	Bot Agent version	Control Room build
<a href="#">6.17.0</a> on page 879	6 December 2023	With Automation 360 v.31 (Sandbox) release	21.112 or later	11307 or later
<a href="#">6.16.4</a> on page 880	17 July 2023	Package-only; post Automation 360 v.29 release	21.112 or later	11307 or later
<a href="#">6.15.1</a> on page 880	6 June 2023	With Automation 360 v.29 (Sandbox) release	21.112 or later	11307 or later

### 6.17.0

- Compatible Bot Agent version: 21.112 or later
- Compatible Control Room version: 11307 or later

What's new
<p>Updated actions in Excel advanced package ( Service Cloud Case ID: 01953992)</p> <p>The names of the following actions in the Excel advanced package have been updated and now include the option to filter and sort data within specified worksheets:</p> <ul style="list-style-type: none"> <li>• <b>Filter table</b> action is changed to <b>Filter</b> action. <a href="#">Using Filter action</a> on page 2595</li> <li>• <b>Sort table</b> action is changed to <b>Sort</b> action. <a href="#">Using Sort action</a> on page 2598</li> </ul>

## 6.16.4

- Compatible Bot Agent version: 21.112 or later
- Compatible Control Room version: 11307 or later

**Note:** This version is also available in the v.30 release.

Fixes
You can now use the <b>Open</b> action in the Excel advanced package to open a Microsoft Excel file on Sharepoint even when the file name contains characters in Japanese language. Service Cloud Case ID: 01949384
The description of the <b>Find</b> action is now correctly translated in the Japanese language. Service Cloud Case ID: 01952045

Fix
In the Excel advanced package, you can use the <b>Match case</b> or <b>Match entire cell contents</b> options within the <b>Search options</b> field of the <b>Find</b> action to search for a value in an Excel sheet, even when the specified sheet is in a protected or read-only mode. Service Cloud Case ID: 01970516, 01973805, 01981779

## 6.15.1

- Compatible Bot Agent version: 21.112 or later
- Compatible Control Room version: 11307 or later

Fix
You can now create an Excel workbook or .csv file using the <b>Create workbook</b> action in the <b>Excel advanced</b> package without any issues. Service Cloud Case ID: 01945223

Related reference

[Excel advanced package](#) on page 2565



The Excel advanced package contains actions that enable you to automate many of the repetitive tasks when working with Microsoft Excel spreadsheets.

## Excel basic package updates

Review the updates in released versions of the Excel basic package such as new and enhanced features as well as fixes and limitations. The page also lists the release dates of each version, and the compatible Control Room and Bot Agent versions.

### Versions summary

The following table lists the versions of Excel basic package released either with an Automation 360 release or as a package-only release (in descending order of release dates). Click the version link for information about updates in that package version.

Version	Release date	Release type	Bot Agent version	Control Room build
<a href="#">6.18.1</a> on page 881	20 October 2023	Package-only; post Automation 360 v.30 release	21.112 or later	11307 or later
<a href="#">6.15.0</a> on page 881	6 June 2023	With Automation 360 v.29 (Sandbox) release	21.112 or later	11307 or later

### 6.18.1

- Compatible Bot Agent version: 21.112 or later
- Compatible Control Room version: 11307 or later

Fix
<p>When you use the <b>Get single cell</b> or <b>Get multiple cell</b> actions to retrieve data from a Microsoft Excel sheet, the date is now extracted in the same format that was used in that Excel sheet.</p> <p>Service Cloud Case ID: 01990340</p>

### 6.15.0

- Compatible Bot Agent version: 21.112 or later
- Compatible Control Room version: 11307 or later

Fixes
<p>You can use the <b>Get cell address</b> action in the Excel basic package to read data from a specified cell in an Excel sheet, even when that cell contains advanced Excel function or formula (such as AVERAGEIFS,COUNTIF).</p> <p>Service Cloud Case ID: 01791154</p>
<p>The <b>Get multiple cells</b> action now displays the correct field name for selecting the range of cells.</p>

Related reference

[Excel basic package](#) on page 2558

The Excel basic package contains actions that enable you to automate many of the repetitive tasks in XLSX workbooks. You use these actions when Microsoft Excel is not available on the device that you want to use to automate Microsoft Excel-related tasks.

## File package updates

Review the updates in released versions of the File package such as new and enhanced features as well as fixes and limitations. The page also lists the release dates of each version, and the compatible Control Room and Bot Agent versions.

### Versions summary

The following table lists the versions of File package released either with an Automation 360 release or as a package-only release (in descending order of release dates). Click the version link for information about updates in that package version.

Version	Release date	Release type	Bot Agent version	Control Room build
<a href="#">6.9.1</a> on page 882	6 December 2023	With Automation 360 v.31 (Sandbox) release	21.98 or later	10789 or later
<a href="#">6.7.0</a> on page 883	6 June 2023	With Automation 360 v.29 (Sandbox) release	21.98 or later	10789 or later

#### 6.9.1

- Compatible Bot Agent version: 21.98 or later
- Compatible Control Room version: 10789 or later

**What's new**

Create dynamic file paths to assign a file (Service Cloud case ID: 01858508)

In the **File > Assign** action, you can now use the **Dynamic file path** option to insert variables in a file path when you assign a file from the Control Room where the file path is dynamic. This enables you to select a different file or a file from a different folder dynamically, as per the business logic. For example, `Bots\FileBots\${csvName}`

**Note:** The option for inserting variables in a file path was already available for local files.

[Assign action](#) on page 2601

**Fix**

The **Case sensitive** option works as expected when you define a regex pattern for a file name in the following actions:

- **File > Open**
- **File > Rename**
- **File > Print multiple files**
- **File > Delete**
- **File > Copy**

Service Cloud case ID: 01976721

## 6.7.0

- Compatible Bot Agent version: 21.98 or later
- Compatible Control Room version: 10789 or later

**What's new**

Performance improvement for Copy Desktop file action (Service Cloud case ID: 01858508)

To copy multiple files simultaneously, you can now use the new **Copy multiple files at the same time to increase the copy speed** option in the **File > Copy Desktop file** action. This enhances the performance of your bot enabling you to meet your SLAs quicker and effectively copy large number of files over a shared or network location.

[Using Copy Desktop file action for file](#) on page 2601

**Fix**

If you have used the **Open** action from the **Excel advanced** package, errors are no longer displayed when you use the **Create shortcut** action in the **File** package.

Related reference

[File package](#) on page 2600

Automate various file-related operations, such as creating, opening, copying, renaming, and deleting a file, by using the actions available in the `File` package.

## Folder package updates

Review the updates in released versions of the Folder package such as new and enhanced features as well as fixes and limitations. The page also lists the release dates of each version, and the compatible Control Room and Bot Agent versions.

### Versions summary

The following table lists the versions of Folder package released either with an Automation 360 release or as a package-only release (in descending order of release dates). Click the version link for information about updates in that package version.

Version	Release date	Release type	Bot Agent version	Control Room build
<a href="#">6.9.1</a> on page 884	6 December 2023	With Automation 360 v.31 (Sandbox) release	20.11 or later	8750 or later
<a href="#">6.8.0</a> on page 885	6 September 2023	With Automation 360 v.30 (Sandbox) release	20.11 or later	8750 or later
<a href="#">6.7.0</a> on page 883	6 June 2023	With Automation 360 v.29 (Sandbox) release	20.11 or later	8750 or later

### 6.9.1

- Compatible Bot Agent version: 20.11 or later
- Compatible Control Room version: 8750 or later

Fixes
The <b>Folder &gt; Unzip</b> action now successfully extracts files even if the folders contain files that do not have a name and extension.
<b>Note:</b> This action ignores the file without a name and extension and extracts the remaining correct files only.
Service Cloud case ID: 01997210

**Fixes**

The **Case sensitive** option works as expected when you define a regex pattern for a file name in the **Folder > Zip** action.

Service Cloud case ID: 01976721

**6.8.0**

- Compatible Bot Agent version: 20.11 or later
- Compatible Control Room version: 8750 or later

**What's new**

Iterate each sub-folder recursively

You can now use the new **Include all sub-folders** option in the **Loop > For each folder in folder** iterator to recursively iterate through each sub-folder within a folder including hidden folders.

**6.7.0**

- Compatible Bot Agent version: 20.11 or later
- Compatible Control Room version: 8750 or later

**Fixes**

You can now use the **Folder > Unzip** action to successfully extract a file from the zip folder where the folder name contains a space character at the trailing end.

Service Cloud case ID: 01947468

If you have used the **Open** action from the **Excel advanced** package, errors are no longer displayed when you use the **Create shortcut** action in the **Folder** package.

Related reference

[Folder package](#) on page 2612

Automate folder-related operations by using the actions available in the `Folder` package.

## FTP/SFTP package updates

Review the updates in released versions of the FTP / SFTP package such as new and enhanced features as well as fixes and limitations. The page also lists the release dates of each version, and the compatible Control Room and Bot Agent versions.

### Versions summary

The following table lists the versions of FTP / SFTP package released either with an Automation 360 release or as a package-only release (in descending order of release dates). Click the version link for information about updates in that package version.

Version	Release date	Release type	Bot Agent version	Control Room build
<a href="#">2.11.0</a> on page 886	6 September 2023 and 21 September 2023	With Automation 360 v.30 (Sandbox) release and periodic package update	20.11 or later	8750 or later
<a href="#">2.10.1</a> on page 887	6 June 2023	With Automation 360 v.29 (Sandbox) release	20.11 or later	8750 or later

### 2.11.0

- Compatible Bot Agent version: 20.11 or later
- Compatible Control Room version: 8750 or later

What's new
<p>New capabilities added to FTP / SFTP package (Service Cloud case ID: 01274780)</p> <ul style="list-style-type: none"> <li>• We now support global or shared session capabilities in the FTP / SFTP package. For code re-usability, the professional developers can create a new global session using the <b>FTP &gt; Connect</b> action and then reuse the global or shared FTP session in other actions of the FTP / SFTP package within the parent bot, or across different child bots. With this feature, professional developers no longer need to maintain multiple FTP sessions.</li> <li>• Introduced a new <b>Session</b> variable of type <b>FTP/SFTP session</b>.</li> <li>• The <b>FTP/SFTP Session name</b> field has been renamed to <b>Create FTP/SFTP session</b>.</li> </ul> <p><a href="#">Connect action</a> on page 2620   <a href="#">Disconnect action</a> on page 2623</p>

**What's changed**

Help Center for developers

- Help Center: We have added an in-app help for developers to get contextual information about and when building automations.
- Added intuitive icons for in a .

**Fix**

When you create a bot using **Connect** action from the **FTP/SFTP** package, the description for the **Connect** action is now displayed correctly in the Japanese language.

Service Cloud case ID: 01976971

**2.10.1**

- Compatible Bot Agent version: 20.11 or later
- Compatible Control Room version: 8750 or later

**What's changed**

Help Center for developers

- Help Center: We have added an in-app help for developers to get contextual information about and when building automations.  
[In-product user assistance](#) on page 1159
- Added intuitive icons for in a .

Related reference

[FTP / SFTP package](#) on page 2618

Use the FTP / SFTP package to automate FTP / SFTP operations.

**Generative AI package updates**

Review the updates in released versions of the Generative AI package such as new and enhanced features as well as fixes and limitations. The page also lists the release dates of each version, and the compatible Control Room and Bot Agent versions.

**Versions summary**

The following table lists the versions of Generative AI package released either with an Automation 360 release or as a package-only release (in descending order of release dates). Click the version link for information about updates in that package version.

Version	Release date	Release type	Bot Agent version	Control Room build
<a href="#">1.3.2</a> on page 888	16 November 2023	Package-only; post Automation 360 v.30 release	21.240 or later	17445 or later
<a href="#">1.1.0</a> on page 888	6 September 2023	With Automation 360 v.30 (Sandbox) release	21.240 or later	17445 or later
<a href="#">1.0.1</a> on page 889	17 July 2023	Package-only; post Automation 360 v.29 release	21.240 or later	17445 or later

### 1.3.2

- Compatible Bot Agent version: 21.240 or later
- Compatible Control Room version: 17445 or later

What's new
You can now use the new actions added as a part of Amazon Bedrock in the Generative AI package. <a href="#">Amazon Bedrock</a> on page 2627
Authenticate action is added to authenticate and get access to use the OpenAI models. <a href="#">Authenticate action</a> on page 2654
Authenticate action is added to authenticate and get access to use the Microsoft Azure models. <a href="#">Authenticate action</a> on page 2650
You can use the new models - <code>code-gecko@001</code> and <code>text-bison (latest)</code> in the Vertex Prompt AI of Generative AI package to send and receive prompts. <a href="#">Vertex AI: Prompt AI action</a> on page 2644

### 1.1.0

- Compatible Bot Agent version: 21.240 or later
- Compatible Control Room version: 17445 or later

---

**Note:** This version is also available in the v.30 release.

---



**Fix**

A minor localization issue is addressed.

**1.0.1**

- Compatible Bot Agent version: 21.240 or later
- Compatible Control Room version: 17445 or later

**What's new**

You can use the new Generative AI package to send and receive prompts and chats from some of the major vendors in the Generative AI space, such as Google, Microsoft, and OpenAI.

[Generative AI packages](#) on page 2626

**Google Calendar package updates**

Review the updates in released versions of the Google Calendar package such as new and enhanced features as well as fixes and limitations. The page also lists the release dates of each version, and the compatible Control Room and Bot Agent versions.

**Versions summary**

The following table lists the versions of Google Calendar package released either with an Automation 360 release or as a package-only release (in descending order of release dates). Click the version link for information about updates in that package version.

Version	Release date	Release type	Bot Agent version	Control Room build
<a href="#">2.12.2</a> on page 889	6 December 2023	With Automation 360 v.31 (Sandbox) release	20.11 or later	8750 or later
<a href="#">2.11.2</a> on page 890	6 June 2023	With Automation 360 v.29 (Sandbox) release	20.11 or later	8750 or later

**2.12.2**

- Compatible Bot Agent version: 20.11 or later
- Compatible Control Room version: 8750 or later

**What's new**

Support for Control Room managed OAuth2 authentication in Google Calendar package

The Google Calendar package is now enhanced to support a more secure OAuth2 authentication using the Control Room managed option in the **Connect** action. Using this option, you can now automate the Google Calendar application in unattended mode while ensuring compliance with your organization's security standards.

[Connect action for Google packages](#) on page 2717

**2.11.2**

- Compatible Bot Agent version: 20.11 or later
- Compatible Control Room version: 8750 or later

**What's changed**

Help Center for developers

- Help Center: We have added an in-app help for developers to get contextual information about and when building automations.

[In-product user assistance](#) on page 1159

- Added intuitive icons for in a .

Related reference

[Google Calendar package](#) on page 2692

The **Google Calendar** package contains actions that enable you to automate creating and deleting events.

**Google Drive package updates**

Review the updates in released versions of the Google Drive package such as new and enhanced features as well as fixes and limitations. The page also lists the release dates of each version, and the compatible Control Room and Bot Agent versions.

**Versions summary**

The following table lists the versions of Google Drive package released either with an Automation 360 release or as a package-only release (in descending order of release dates). Click the version link for information about updates in that package version.

Version	Release date	Release type	Bot Agent version	Control Room build
<a href="#">2.13.2</a> on page 891	6 December 2023	With Automation 360 v.31 (Sandbox) release	20.11 or later	8750 or later
<a href="#">2.12.2</a> on page 891	6 June 2023	With Automation 360 v.29 (Sandbox) release	20.11 or later	8750 or later

## 2.13.2

- Compatible Bot Agent version: 20.11 or later
- Compatible Control Room version: 8750 or later

What's new
<p>Support for Control Room managed OAuth2 authentication in Google Drive package</p> <p>The Google Drive package is now enhanced to support a more secure OAuth2 authentication using the Control Room managed option in the <b>Connect</b> action. Using this option, you can now automate the Google Drive application in unattended mode while ensuring compliance with your organization's security standards.</p> <p><a href="#">Connect action for Google packages</a> on page 2717</p>

## 2.12.2

- Compatible Bot Agent version: 20.11 or later
- Compatible Control Room version: 8750 or later

What's changed
<p>Help Center for developers</p> <ul style="list-style-type: none"> <li>• Help Center: We have added an in-app help for developers to get contextual information about and when building automations.</li> </ul> <p><a href="#">In-product user assistance</a> on page 1159</p> <ul style="list-style-type: none"> <li>• Added intuitive icons for in a .</li> </ul>

Fix
<p>When you use the <b>Upload file</b> action in the Google Drive package to upload a file from your computer to Google Drive and then create a variable to hold the ID of the uploaded file, the bot no longer returns an empty string as file id.</p> <p>Previously the bot returned an empty value as an uploaded file id.</p> <p>Service Cloud case ID: 01945867</p>

Related reference

[Google Drive package](#) on page 2694

Automate tasks related to files and folders by using the actions in the **Google Drive** package.

## Google Sheets package updates

Review the updates in released versions of the Google Sheets package such as new and enhanced features as well as fixes and limitations. The page also lists the release dates of each version, and the compatible Control Room and Bot Agent versions.

### Versions summary

The following table lists the versions of Google Sheets package released either with an Automation 360 release or as a package-only release (in descending order of release dates). Click the version link for information about updates in that package version.

Version	Release date	Release type	Bot Agent version	Control Room build
<a href="#">2.14.1</a> on page 892	6 December 2023	With Automation 360 v.30 (Sandbox) release	20.11 or later	8750 or later
<a href="#">2.13.0</a> on page 893	17 July 2023	Package-only; post Automation 360 v.29 release	20.11 or later	8750 or later
<a href="#">2.12.2</a> on page 893	6 June 2023	With Automation 360 v.29 (Sandbox) release	20.11 or later	8750 or later

### 2.14.1

- Compatible Bot Agent version: 20.11 or later
- Compatible Control Room version: 8750 or later

**What's new**

Support for Control Room managed OAuth2 authentication in Google Sheets package

The Google Sheets package is now enhanced to support a more secure OAuth2 authentication using the Control Room managed option in the **Connect** action. Using this option, you can now automate the Google Sheets application in unattended mode while ensuring compliance with your organization's security standards.

[Connect action for Google packages](#) on page 2717

**Fix**

When you create a bot to connect to the Google server and open a spreadsheet, and if the spreadsheet file has data of 4 lakh records, the bot no longer displays an error.

**Note:** If the spreadsheet has data of more than 4 lakh records, in some cases, the bot might take some time to load the data, depending on the machine's performance.

Service Cloud case ID: 01966153, 02006511

**2.13.0**

- Compatible Bot Agent version: 20.11 or later
- Compatible Control Room version: 8750 or later

**Note:** This version is also available in the v.30 release.

**Fix**

The name of the **Create sheet** action is now displayed correctly in the Japanese language.

**2.12.2**

- Compatible Bot Agent version: 20.11 or later
- Compatible Control Room version: 8750 or later

**What's changed**

Help Center for developers

- Help Center: We have added an in-app help for developers to get contextual information about and when building automations.

[In-product user assistance](#) on page 1159

- Added intuitive icons for in a .

Related reference

[Google Sheets package](#) on page 2703

The **Google Sheets** package contains actions that enable you to automate tasks involving cells, columns, rows, and sheets.

## Hotkey trigger package updates

Review the updates in released versions of the Hotkey trigger package such as new and enhanced features as well as fixes and limitations. The page also lists the release dates of each version, and the compatible Control Room and Bot Agent versions.

### Versions summary

The following table lists the versions of Hotkey trigger package released either with an Automation 360 release or as a package-only release (in descending order of release dates). Click the version link for information about updates in that package version.

Version	Release date	Release type	Bot Agent version	Control Room build
<a href="#">1.5.0-20230323-050200</a> on page 894	March 2023	With Automation 360 v.29 (Sandbox) release	20.11 or later	8750 or later

### 1.5.0-20230323-050200

- Compatible Bot Agent version: 20.11 or later
- Compatible Control Room version: 8750 or later

What's changed
We have set the recommended Bot Agent version and Control Room build for Hotkey trigger package.

## If package updates

Review the updates in released versions of the If package such as new and enhanced features as well as fixes and limitations. The page also lists the release dates of each version, and the compatible Control Room and Bot Agent versions.

### Versions summary

The following table lists the versions of If package released either with an Automation 360 release or as a package-only release (in descending order of release dates). Click the version link for information about updates in that package version.

Version	Release date	Release type	Bot Agent version	Control Room build
<a href="#">3.7.14-20231116-060453</a> on page 895	6 December 2023	With Automation 360 v.31 (Sandbox) release	20.11 or later	8750 or later
<a href="#">3.6.2-20230316-161323</a> on page 895	16 June 2023	With Automation 360 v.29 (Sandbox) release	20.11 or later	8750 or later

### 3.7.14-20231116-000453

- Compatible Bot Agent version: 20.11 or later
- Compatible Control Room version: 8750 or later

What's changed
Internal update in packages Minor update to support API tasks.

### 3.6.2-20230316-161323

- Compatible Bot Agent version: 20.11 or later
- Compatible Control Room version: 8750 or later

Fixes
<p>When you use the <b>If &gt; Window with same title exist</b> condition within the <b>Loop</b> action to detect a window and run the bot, the bot no longer gets stuck and continues to loop and if the target window does not exist, it breaks the loop and immediately moves to the next action.</p> <p>Previously, the bot stopped looping at a specific time 00.00 UTC and continued to detect the target window instead of moving to the next action.</p> <p>Service Cloud case ID: 01949046, 01924925, 01962938, 01976920</p>

Related reference

[If package](#) on page 2724

Use the actions in the `If` package to control the sequence of execution based on one or more conditions of a task.

## Image Recognition package updates

Review the updates in released versions of the Image Recognition package such as new and enhanced features as well as fixes and limitations. The page also lists the release dates of each version, and the compatible Control Room and Bot Agent versions.

### Versions summary

The following table lists the versions of Image Recognition package released either with an Automation 360 release or as a package-only release (in descending order of release dates). Click the version link for information about updates in that package version.

Version	Release date	Release type	Bot Agent version	Control Room build
<a href="#">3.17.2</a> on page 896	6 December 2023	With Automation 360 v.31 (Sandbox) release	21.210 or later	14100 or later
<a href="#">3.16.0</a> on page 897	6 September 2023	With Automation 360 v.30 (Sandbox) release	21.210 or later	14100 or later
<a href="#">3.15.2</a> on page 897	6 June 2023	With Automation 360 v.29 (Sandbox) release	21.210 or later	14100 or later

### 3.17.2

- Compatible Bot Agent version: 21.210 or later
- Compatible Control Room version: 14100 or later

Fixes
<p>You no longer encounter an issue while previewing the captured region in the Image Recognition package. Previously, when you tried to preview the capture region, the preview remained in the processing state without showing any error.</p> <p>Service Cloud Case ID: 01994933, 02001856, 02005588, 02092252</p>



### 3.16.0

- Compatible Bot Agent version: 21.210 or later
- Compatible Control Room version: 14100 or later

Fixes
<p>A bot now runs successfully when you use the <b>Image Recognition &gt; Find window in window</b> action where the name of the bot or the folder has Japanese, Chinese, or Korean characters.</p> <p>Service Cloud Case ID: 01941336, 01962070</p>

### 3.15.2

- Compatible Bot Agent version: 21.210 or later
- Compatible Control Room version: 14100 or later

What's changed
<p>Introduced window time out in Find window in window action</p> <p>When you use the <b>Image Recognition &gt; Find window in window</b> action in a bot and if the window that you selected is not responding, the bot now waits for a maximum of 30 seconds and times out with an error message: <code>Window not responding</code>. Previously, if the specific window was unresponsive, then the bot waited indefinitely for the window to respond.</p>

Related reference

[Image Recognition package](#) on page 2731

The **Image Recognition** package contains actions that enable you to search for a user interface (UI) element in an application based on an image to automate a task in that application.

## Interactive Forms package updates

Review the updates in released versions of Interactive Forms package such as new and enhanced features as well as fixes and limitations. The page also lists the release dates of each version, and the compatible Control Room and Bot Agent versions.

### Versions summary

Version	Release date	Release type	Bot Agent version	Control Room build
<a href="#">3.0.0</a>	21 September 2023	Package-only; post Automation 360 v.30 (Sandbox) release	21.88 or later	10195 or later
<a href="#">2.29.1-20230403-101855</a>	10 June 2023	With Automation 360 (.29 Sandbox)	20.11 or later	8750 or later

### 3.0.0

- Compatible Bot Agent version: 20.88 or later
- Compatible Control Room version: 10195 or later

Whats changed
Due to back-end updates, the package jar file size has increased which has resulted in the initial package download time to increase.
With this enhancement, in any automation a key-stroke or a mouse-click on a text-box, text-area, rich-text, number, date, or time element will trigger the associated rules. This is in addition to the focus-out cursor motion functionality that also triggers the associated rules.
Initially, the system displayed an error only if a form was called in an automation where the mandatory fields were not populated with data. Now, when creating or rendering a form from any automation, if the mandatory fields are missing value, the system displays an error.
In the Forms Composer, the rich-text element should be configured with 350 pixel width for a complete rendering of rich-text editor properties.
To troubleshoot issues for rendering an interactive form, refer to this new log-file location for more details: <code>C:\ProgramData\AutomationAnywhere\BotRunner\Logs\uiForms-electron.log</code> .

**Limitation**

The dynamic components for forms is not supported.

**2.29.1-20230403-101855**

- Compatible Bot Agent version: 20.11 or later
- Compatible Control Room version: 8750 or later

**Fixes**

Security updates to address vulnerabilities in Blackduck Apache PDFBox.

**Document Classifier package updates**

Review the updates in released versions of Document Classifier packagesuch as new and enhanced features as well as fixes and limitations. The page also lists the release dates of each version, and the compatible Control Room and Bot Agent versions.

**Versions summary**

**Note:** The IQ BotClassifier package is called the Document Classifier package from Build 19678.

The following table lists the versions of Document Classifier package released either with an Automation 360 release or as a package-only release (in descending order of release dates). Click the version link for information about updates in that package version.

Version	Release date	Release type	Bot Agent	Control Room build
<a href="#">3.30.1 on page 899</a>	21 September 2023	With Automation 360 v.30 (Sandbox) release	21.98 or later	10520 or later
<a href="#">2.5.4 on page 900</a>	6 June 2023	With Automation 360 v.29 (Sandbox) release	21.98 or later	10520 or later

**3.30.1**

- Compatible Bot Agent version: 21.98 or later
- Compatible Control Room version: 10520 or later

**What's changed**

The Document Classifier package is enhanced for better user engagement. Following are changes associated with the Document Classifier package:

- The package name is changed to Document Classifier package.
- You can track consumption of processed documents (number of pages) in the Document Classifier package.

**2.5.4**

- Compatible Bot Agent version: 21.98 or later
- Compatible Control Room version: 10520 or later

**Fix**

Fixed the vulnerabilities reported in the security scan.

**IQ Bot package updates**

Review the updates in released versions of IQ Bot packagesuch as new and enhanced features as well as fixes and limitations. The page also lists the release dates of each version, and the compatible Control Room and Bot Agent versions.

**Versions summary**

The following table lists the versions of IQ Bot package released either with an Automation 360 release or as a package-only release (in descending order of release dates). Click the version link for information about updates in that package version.

Version	Release date	Release type	Bot Agent version	Control Room build
<a href="#">3.31.2 on page 900</a>	6 December 2023	With Automation 360 v.31 (Sandbox) release	21.98 or later	10520 or later
<a href="#">2.4.5 on page 901</a>	6 June 2023	With Automation 360 v.29 (Sandbox) release	21.98 or later	10520 or later

**3.31.2**

- Compatible Bot Agent version:21.98 or later

- Compatible Control Room version:10520 or later

<b>Fix</b>
Fixed the vulnerabilities reported in the security scan.

### 2.4.5

- Compatible Bot Agent version:21.98 or later
- Compatible Control Room version:10520 or later

<b>Fix</b>
Fixed the vulnerabilities reported in the security scan.

## IQ Bot Pre-processor package updates

Review the updates in released versions of IQ Bot Pre-processor packagesuch as new and enhanced features as well as fixes and limitations. The page also lists the release dates of each version, and the compatible Control Room and Bot Agent versions.

### Versions summary

The following table lists the versions of IQ Bot Pre-processor package released either with an Automation 360 release or as a package-only release (in descending order of release dates). Click the version link for information about updates in that package version.

Version	Release date	Release type	Bot Agent	Control Room build
<a href="#">3.31.0 on page 901</a>	6 December 2023	With Automation 360 v.31 (Sandbox) release	21.98 or later	10520 or later
<a href="#">2.4.4 on page 902</a>	6 June 2023	With Automation 360 v.29 (Sandbox) release	21.98 or later	10520 or later

### 3.31.0

- Compatible Bot Agent version: 21.98 or later
- Compatible Control Room version: 10520 or later

**Fix**

Fixed the vulnerabilities reported in the security scan.

**2.4.4**

- Compatible Bot Agent version: 21.98 or later
- Compatible Control Room version: 10520 or later

**Fix**

Fixed the vulnerabilities reported in the security scan.

**JavaScript package updates**

Review the updates in released versions of the JavaScript package such as new and enhanced features as well as fixes and limitations. The page also lists the release dates of each version, and the compatible Control Room and Bot Agent versions.

**Versions summary**

The following table lists the versions of JavaScript package released either with an Automation 360 release or as a package-only release (in descending order of release dates). Click the version link for information about updates in that package version.

Version	Release date	Release type	Bot Agent version	Control Room build
<a href="#">2.16.0</a> on page 902	6 December 2023	With Automation 360 v.31 (Sandbox) release	20.11 or later	8750 or later
<a href="#">2.15.0</a> on page 903	6 June 2023	With Automation 360 v.29 (Sandbox) release	20.11 or later	8750 or later

**2.16.0**

- Compatible Bot Agent version: 20.11 or later
- Compatible Control Room version: 8750 or later

**What's changed**

Intuitive icons at package level

We have added intuitive icons at the package level. In the Action pane, when you navigate through the different packages, these icons are displayed at the package level and provide contextual information about packages.

**2.15.0**

- Compatible Bot Agent version: 20.11 or later
- Compatible Control Room version: 8750 or later

**What's changed**

Help Center for developers

- Help Center: We have added an in-app help for developers to get contextual information about and when building automations.

[In-product user assistance](#) on page 1159

- Added intuitive icons for in a .

Related reference

[JavaScript package](#) on page 2760

The JavaScript package contains actions to run a JavaScript from a bot. These actions can run JavaScript on Windows, Linux, and UNIX based devices.

**JSON package releases**

Review the updates in released versions of the JSON package such as new and enhanced features as well as fixes and limitations. The page also lists the release dates of each version, and the compatible Control Room and Bot Agent versions.

**Versions summary**

The following table lists the versions of JSON package released either with an Automation 360 release or as a package-only release (in descending order of release dates). Click the version link for information about updates in that package version.

Version	Release date	Release type	Bot Agent version	Control Room build
<a href="#">1.5.1</a> on page 904	6 December 2023	With Automation 360 v.31 (Sandbox) release	21.98 or later	10520 or later

Version	Release date	Release type	Bot Agent version	Control Room build
<a href="#">1.4.1</a> on page 904	6 June 2023	With Automation 360 v.29 (Sandbox) release	21.98 or later	10520 or later

### 1.5.1

- Compatible Bot Agent version: 21.98 or later
- Compatible Control Room version: 10520 or later

What's new
Internal update in packages Minor update to support API tasks.

What's changed
Intuitive icons at package level We have added intuitive icons at the package level. In the Action pane, when you navigate through the different packages, these icons are displayed at the package level and provide contextual information about packages.

### 1.4.1

- Compatible Bot Agent version: 21.98 or later
- Compatible Control Room version: 10520 or later

Fix
Few dependencies in the JSON jar file were updated to mitigate the security risk.



## Legacy Automation package updates

Review the updates in released versions of packagesuch as new and enhanced features as well as fixes and limitations. The page also lists the release dates of each version, and the compatible Control Room and Bot Agent versions.

### Versions summary

The following table lists the versions of Legacy Automation package released either with an Automation 360 release or as a package-only release (in descending order of release dates). Click the version link for information about updates in that package version.

Version	Release date	Release type	Bot Agent version	Control Room build
<a href="#">6.4.0</a> on page 905	6 December 2023	With Automation 360 v.31 (Sandbox) release	21.200 or later	13279 or later
<a href="#">6.3.2</a> on page 905	6 September 2023	With Automation 360 v.30 (Sandbox) release	21.200 or later	13279 or later
<a href="#">6.2.0</a> on page 906	6 June 2023	With Automation 360 v.29 (Sandbox) release	21.200 or later	13279 or later

### 6.4.0

- Compatible Bot Agent version: 21.200 or later
- Compatible Control Room version: 13279 or later

What's changed
<p>Help Center for developers</p> <p>Help Center: We have added an in-app help for developers to get contextual information about and when building automations.</p> <p><a href="#">In-product user assistance</a> on page 1159</p>

### 6.3.2

- Compatible Bot Agent version: 21.200 or later
- Compatible Control Room version: 13279 or later

**Fix**

Fixed security vulnerability issues. For more information, click the release download link and view the Security & Compliance reports at [A-People Downloads page \(Login required\)](#).

**6.2.0**

- Compatible Bot Agent version: 21.200 or later
- Compatible Control Room version: 13279 or later

**Fix**

Fixed security vulnerability issues. For more information, click the release download link and view the Security & Compliance reports at [A-People Downloads page \(Login required\)](#).

Related reference

[Legacy Automation package](#) on page 2765

The actions in the Legacy Automation package are only used in migrated bots to ensure that they run seamlessly in Automation 360. We do not recommend using this package for new bot development.

**List package updates**

Review the updates in released versions of the List package such as new and enhanced features as well as fixes and limitations. The page also lists the release dates of each version, and the compatible Control Room and Bot Agent versions.

**Versions summary**

Version	Release date	Release type	Bot Agent version	Control Room build
<a href="#">2.13.0</a> on page 906	6 December 2023	With Automation 360 v.31 (Sandbox) release	20.11 or later	8750 or later
<a href="#">2.11.0</a> on page 907	6 June 2023	With Automation 360 v.29 (Sandbox) release	20.11 or later	8750 or later

**2.13.0**

- Compatible Bot Agent version: 20.11 or later

- Compatible Control Room version: 8750 or later

What's new
Internal update in packages Minor update to support API tasks.

What's changed
Intuitive icons at package level We have added intuitive icons at the package level. In the Action pane, when you navigate through the different packages, these icons are displayed at the package level and provide contextual information about packages.

## 2.11.0

- Compatible Bot Agent version: 20.11 or later
- Compatible Control Room version: 8750 or later

What's changed
Help Center for developers <ul style="list-style-type: none"> <li>• Help Center: We have added an in-app help for developers to get contextual information about and when building automations. <a href="#">In-product user assistance</a> on page 1159</li> <li>• Added intuitive icons for in a .</li> </ul>

Related reference

[List package](#) on page 2774

The **List** package contains actions that enable you to perform various operations on a variable of the list data type.

## Log To File package updates

Review the updates in released versions of the Log To File package such as new and enhanced features as well as fixes and limitations. The page also lists the release dates of each version, and the compatible Control Room and Bot Agent versions.

### Versions summary

The following table lists the versions of Log To File package released either with an Automation 360 release or as a package-only release (in descending order of release dates). Click the version link for information about updates in that package version.

Version	Release date	Release type	Bot Agent version	Control Room build
<a href="#">3.8.0</a> on page 908	6 September 2023	With Automation 360 v.30 (Sandbox) release	21.134 or later	19321 or later

### 3.8.0

- Compatible Bot Agent version: 21.134 or later
- Compatible Control Room version: 19321 or later

What's new
<p>Added new Log variables to file action (Service Cloud case ID: 01263909)</p> <p>You can use the new, <b>Log variables to file</b> action in the Log To File package to log user-defined variable values of basic data types (such as Number, String, Boolean, and DateTime) to a log file. Use this action to troubleshoot and fix any automation issue by analyzing the variable values logged in the log file.</p> <hr/> <p><b>Note:</b> The existing <b>Log to file</b> action has been renamed to <b>Log text to file</b>.</p> <hr/> <p><a href="#">Log variables to file action</a> on page 2783   <a href="#">Example of using Custom selection option in Log variables to file action</a> on page 3287</p>

what's changed
<p>Help Center for developers</p> <ul style="list-style-type: none"> <li>• Help Center: We have added an in-app help for developers to get contextual information about and when building automations.</li> <li>• Added intuitive icons for in a .</li> </ul>

## Loop package updates

Review the updates in released versions of the Loop package such as new and enhanced features as well as fixes and limitations. The page also lists the release dates of each version, and the compatible Control Room and Bot Agent versions.

### Versions summary

The following table lists the versions of Loop package released either with an Automation 360 release or as a package-only release (in descending order of release dates). Click the version link for information about updates in that package version.

Version	Release date	Release type	Bot Agent version	Control Room build
<a href="#">3.8.1-20231117-175130</a> on page 909	December 2023	With Automation 360 v.31 (Sandbox) release	20.11 or later	17208 or later
<a href="#">3.7.5-20230316-155504</a> on page 909	June 2023	With Automation 360 v.29 (Sandbox) release	20.11 or later	17208 or later

### 3.8.1-20231117-175130

- Compatible Bot Agent version: 20.11 or later
- Compatible Control Room version: 17208 or later

What's changed
Internal update in packages Minor update to support API tasks.

### 3.7.5-20230316-155504

- Compatible Bot Agent version: 20.11 or later
- Compatible Control Room version: 17208 or later

What's new
The <b>Iterator</b> option to specify the number of times the set of actions will be repeated as part of the <b>Loop</b> action now includes the following packages: <ul style="list-style-type: none"> <li>• Microsoft 365 Calendar</li> <li>• Microsoft 365 Excel</li> <li>• Microsoft 365 Outlook</li> </ul>

Related reference

[Loop package](#) on page 2784

Use the Loop package to run a sequence of actions repeatedly for a specific number of times or until a specific condition is met.

## Message Box package updates

Review the updates in released versions of the Message Box package such as new and enhanced features as well as fixes and limitations. The page also lists the release dates of each version, and the compatible Control Room and Bot Agent versions.

### Versions summary

The following table lists the versions of Message Box package released either with an Automation 360 release or as a package-only release (in descending order of release dates). Click the version link for information about updates in that package version.

Version	Release date	Release type	Bot Agent version	Control Room build
<a href="#">3.7.0 on page 910</a>	6 December 2023	With Automation 360 v.31 (Sandbox) release	20.11 or later	8750 or later
<a href="#">3.6.0 on page 910</a>	6 June 2023	With Automation 360 v.29 (Sandbox) release	20.11 or later	8750 or later

### 3.7.0

- Compatible Bot Agent version: 20.11 or later
- Compatible Control Room version: 8750 or later

What's changed
<p>Intuitive icons at package level</p> <p>We have added intuitive icons at the package level. In the Action pane, when you navigate through the different packages, these icons are displayed at the package level and provide contextual information about packages.</p>

### 3.6.0

- Compatible Bot Agent version: 20.11 or later
- Compatible Control Room version: 8750 or later

**What's changed**

Help Center for developers

- Help Center: We have added an in-app help for developers to get contextual information about and when building automations.

[In-product user assistance](#) on page 1159

- Added intuitive icons for in a .

Related reference

[Message box package](#) on page 2796

Use the **Message box** action from the **Message box** package to insert a message box that shows a message when the task runs. For example, you can insert a **Message Box** action to follow a web form so that the action displays the message: Web Form Filled and Complete.

## Microsoft 365 Calendar package updates

Review the updates in released versions of the Microsoft 365 Calendar package such as new and enhanced features as well as fixes and limitations. The page also lists the release dates of each version, and the compatible Control Room and Bot Agent versions.

### Versions summary

The following table lists the versions of Microsoft 365 Calendar package released either with an Automation 360 release or as a package-only release (in descending order of release dates). Click the version link for information about updates in that package version.

Version	Release date	Release type	Bot Agent version	Control Room build
<a href="#">2.15.0</a> on page 911	6 December 2023	With Automation 360 v.31 (Sandbox) release	20.11 or later	8750 or later
<a href="#">2.13.3</a> on page 912	6 September 2023	With Automation 360 v.30 (Sandbox) release	20.11 or later	8750 or later
<a href="#">2.12.1</a> on page 912	6 June 2023	With Automation 360 v.29 (Sandbox) release	20.11 or later	8750 or later

### 2.15.0

- Compatible Bot Agent version: 20.11 or later

- Compatible Control Room version: 8750 or later

What's new
Internal update in packages Minor update to support API tasks.
Support for Control Room managed OAuth2 authentication The Microsoft 365 Calendar package is now enhanced to support a more secure OAuth2 authentication using the Control Room managed option in the <b>Connect</b> action. Using this option, you can now automate the Microsoft 365 Calendar application in unattended mode while ensuring compliance with your organization's security standards.

### 2.13.3

- Compatible Bot Agent version: 20.11 or later
- Compatible Control Room version: 8750 or later

What's changed
Help Center for developers <ul style="list-style-type: none"> <li>• Help Center: We have added an in-app help for developers to get contextual information about and when building automations. <ul style="list-style-type: none"> <li><a href="#">In-product user assistance</a> on page 1159</li> </ul> </li> <li>• Added intuitive icons for in a .</li> </ul>

### 2.12.1

---

**Note:** Microsoft has rebranded Office 365 to Microsoft 365. See [Microsoft is rebranding 'Office' to Microsoft 365](#).

---

- Compatible Bot Agent version: 20.11 or later
- Compatible Control Room version: 8750 or later

What's changed
The Office 365 Calendar package is renamed to Microsoft 365 Calendar package. <a href="#">Microsoft 365 Calendar package</a> on page 2811
Unauthenticated proxy is now supported.

Related reference

[Microsoft 365 Calendar package](#) on page 2811



This package contains actions that enable you to automate meeting-related tasks in Microsoft 365 Calendar.

## Microsoft 365 Excel package updates

Review the updates in released versions of the Microsoft 365 Excel package such as new and enhanced features as well as fixes and limitations. The page also lists the release dates of each version, and the compatible Control Room and Bot Agent versions.

### Versions summary

The following table lists the versions of Microsoft 365 Excel package released either with an Automation 360 release or as a package-only release (in descending order of release dates). Click the version link for information about updates in that package version.

Version	Release date	Release type	Bot Agent version	Control Room build
<a href="#">2.15.0</a> on page 913	6 December 2023	With Automation 360 v.31 (Sandbox) release	20.11 or later	8750 or later
<a href="#">2.13.3</a> on page 914	6 September 2023	With Automation 360 v.30 (Sandbox) release	20.11 or later	8750 or later
<a href="#">2.13.2</a> on page 914	17 July 2023	Package-only; post Automation 360 v.29 release	20.11 or later	8750 or later
<a href="#">2.12.1</a> on page 914	6 June 2023	With Automation 360 v.29 (Sandbox) release	20.11 or later	8750 or later

### 2.15.0

- Compatible Bot Agent version: 20.11 or later
- Compatible Control Room version: 8750 or later

What's new
Internal update in packages Minor update to support API tasks.

**What's new**

Support for Control Room managed OAuth2 authentication

The Microsoft 365 Excel package is now enhanced to support a more secure OAuth2 authentication using the Control Room managed option in the **Connect** action. Using this option, you can now automate the Microsoft 365 Excel application in unattended mode while ensuring compliance with your organization's security standards.

**2.13.3**

- Compatible Bot Agent version: 20.11 or later
- Compatible Control Room version: 8750 or later

**What's changed**

Help Center for developers

- Help Center: We have added an in-app help for developers to get contextual information about and when building automations.  
[In-product user assistance](#) on page 1159
- Added intuitive icons for in a .

**2.13.2**

- Compatible Bot Agent version: 20.11 or later
- Compatible Control Room version: 8750 or later

**Fix**

The name of the **Create sheet** action is now displayed correctly in the Japanese language.

**2.12.1**

**Note:** Microsoft has rebranded Office 365 to Microsoft 365. See [Microsoft is rebranding 'Office' to Microsoft 365](#).

- Compatible Bot Agent version: 20.11 or later
- Compatible Control Room version: 8750 or later

**What's changed**

The Office 365 Excel package is renamed to Microsoft 365 Excel package.

[Microsoft 365 Excel package](#) on page 2821

**What's changed**

Unauthenticated proxy is now supported.

Related reference

[Microsoft 365 Excel package](#) on page 2821

The Microsoft 365 Excel package contains actions that enable you to automate tasks in the online version of Microsoft Excel.

## Microsoft 365 OneDrive package updates

Review the updates in released versions of the Microsoft 365 OneDrive package such as new and enhanced features as well as fixes and limitations. The page also lists the release dates of each version, and the compatible Control Room and Bot Agent versions.

### Versions summary

The following table lists the versions of Microsoft 365 OneDrive package released either with an Automation 360 release or as a package-only release (in descending order of release dates). Click the version link for information about updates in that package version.

Version	Release date	Release type	Bot Agent version	Control Room build
<a href="#">2.15.0</a> on page 915	6 December 2023	With Automation 360 v.31 (Sandbox) release	20.11 or later	8750 or later
<a href="#">2.13.3</a> on page 916	6 September 2023	With Automation 360 v.30 (Sandbox) release	20.11 or later	8750 or later
<a href="#">2.12.1</a> on page 916	6 June 2023	With Automation 360 v.29 (Sandbox) release	20.11 or later	8750 or later

### 2.15.0

- Compatible Bot Agent version: 20.11 or later
- Compatible Control Room version: 8750 or later

**What's new**

Internal update in packages

Minor update to support API tasks.

**What's new**

Support for Control Room managed OAuth2 authentication

The Microsoft 365 OneDrive package is now enhanced to support a more secure OAuth2 authentication using the Control Room managed option in the **Connect** action. Using this option, you can now automate the Microsoft 365 OneDrive application in unattended mode while ensuring compliance with your organization's security standards.

**2.13.3**

- Compatible Bot Agent version: 20.11 or later
- Compatible Control Room version: 8750 or later

**What's changed**

Help Center for developers

- Help Center: We have added an in-app help for developers to get contextual information about and when building automations.  
[In-product user assistance](#) on page 1159
- Added intuitive icons for in a .

**Fixes**

When you use **Microsoft 365 OneDrive > Download file** action to download a file and then use the **File > Rename** action to rename that downloaded file running in a loop, the bot now runs successfully. Previously, the bot failed and the following error message was displayed: Unable to proceed with the action as the file is being used by another process

Service Cloud Case ID: 01925742

**2.12.1**

**Note:** Microsoft has rebranded Office 365 to Microsoft 365. See [Microsoft is rebranding 'Office' to Microsoft 365](#).

- Compatible Bot Agent version: 20.11 or later
- Compatible Control Room version: 8750 or later

**What's changed**

The Office 365 OneDrive package is renamed to Microsoft 365 OneDrive package.

[Microsoft 365 OneDrive package](#) on page 2841

**What's changed**

Unauthenticated proxy is now supported.

Related reference

[Microsoft 365 OneDrive package](#) on page 2841

The Microsoft 365 OneDrive package contains actions that enable you to automate many of the repetitive tasks in Microsoft cloud storage.

## Microsoft 365 Outlook package updates

Review the updates in released versions of Microsoft 365 Outlook package such as new and enhanced features as well as fixes and limitations. The page also lists the release dates of each version, and the compatible Control Room and Bot Agent versions.

### Versions summary

The following table lists the versions of Microsoft 365 Outlook package released either with an Automation 360 release or as a package-only release (in descending order of release dates). Click the version link for information about updates in that package version.

Version	Release date	Release type	Bot Agent version	Control Room build
<a href="#">1.3.0</a> on page 918	6 December 2023	With Automation 360 v.31 (Sandbox) release	21.210 or later	13980 or later
<a href="#">1.2.3</a> on page 918	21 September 2023	Package-only; post Automation 360 v.30 (Sandbox) release	21.210 or later	13980 or later
<a href="#">1.1.5</a> on page 918	6 September 2023	With Automation 360 v.30 (Sandbox) release	21.210 or later	13980 or later
<a href="#">1.1.4</a> on page 919	17 July 2023	Package-only; post Automation 360 v.29 release	21.210 or later	13980 or later
<a href="#">1.0.1</a> on page 919	6 June 2023	With Automation 360 v.29 (Sandbox) release	21.210 or later	13980 or later

### 1.3.0

- Compatible Bot Agent version: 21.210 or later
- Compatible Control Room version: 13980 or later

What's new
Internal update in packages Minor update to support API tasks.
Support for shared mailbox The Microsoft 365 Outlook package now supports automating shared mailbox. <a href="#">Microsoft 365 Outlook package</a> on page 2851
Support for Control Room managed OAuth2 authentication The Microsoft 365 Outlook package is now enhanced to support a more secure OAuth2 authentication using the Control Room managed option in the <b>Connect</b> action. Using this option, you can now automate the Microsoft 365 Outlook application in unattended mode while ensuring compliance with your organization's security standards. <a href="#">Using Connect action in Microsoft 365 Outlook package</a> on page 2855

### 1.2.3

- Compatible Bot Agent version: 21.210 or later
- Compatible Control Room version: 13980 or later

Fix
Connectivity issues are not encountered while using the <b>Connect</b> action to automate Microsoft 365 Outlook related tasks as the user profile read permission is no longer required. Service Cloud Case ID: 01981156, 01991340, 01994570

### 1.1.5

- Compatible Bot Agent version: 21.210 or later
- Compatible Control Room version: 13980 or later

**What's changed**

Help Center for developers

- Help Center: We have added an in-app help for developers to get contextual information about and when building automations.  
[In-product user assistance](#) on page 1159
- Added intuitive icons for in a .

**1.1.4**

- Compatible Bot Agent version: 21.210 or later
- Compatible Control Room version: 13980 or later

**What's new**

The **Connect** action in the Microsoft 365 Outlook package now supports a global session variable, that enables you to share the same session across parent and child bots

[Using Connect action in Microsoft 365 Outlook package](#) on page 2855.

**1.0.1**

---

**Note:** This package is new in v.29 and is based on Graph API. Microsoft has deprecated EWS API for Exchange Online and has recommended that users move to Graph API. See [Upcoming API Deprecations in Exchange Web Services for Exchange Online](#).

---

**Note:** The integration of Graph API requires an administrator to grant access, after which you can configure an application access policy and limit the scope of application permissions. See [Configure application access policy](#).

---

- Compatible Bot Agent version: 21.210 or later
- Compatible Control Room version: 13980 or later

**What's new**

Use the Microsoft 365 Outlook package (based on Graph API) to automate email-related tasks for sending, receiving, and modifying emails and folders, and saving attachments from email messages in Microsoft 365 Outlook.

[Microsoft 365 Outlook package](#) on page 2851.

**Limitation**

If you have used the **Connect** action in the Microsoft 365 Outlook package to automate any of the Microsoft Outlook related tasks, the bot might fail intermittently.

Service Cloud Case ID: 01981156, 01991340, 01994570

Related concepts

[Microsoft 365 Outlook package](#) on page 2851

The Microsoft 365 Outlook package enables you to automate Outlook emails over Microsoft Outlook server.

[Feature deprecations affecting Automation Anywhere products](#) on page 1086

Review the features and capabilities (from Automation Anywhere or third party) that are deprecated or nearing deprecation to understand how they affect your automation and what action is required.

## Mouse package updates

Review the updates in released versions of the Mouse package such as new and enhanced features as well as fixes and limitations. The page also lists the release dates of each version, and the compatible Control Room and Bot Agent versions.

### Versions summary

The following table lists the versions of Mouse package released either with an Automation 360 release or as a package-only release (in descending order of release dates). Click the version link for information about updates in that package version.

Version	Release date	Release type	Bot Agent version	Control Room build
<a href="#">2.15.0</a> on page 920	6 September 2023	With Automation 360 v.30 (Sandbox) release	21.210 or later	14100 or later
<a href="#">2.14.0</a> on page 921	6 June 2023	With Automation 360 v.29 (Sandbox) release	21.210 or later	14100 or later

### 2.15.0

- Compatible Bot Agent version: 21.210 or later
- Compatible Control Room version: 14100 or later



**What's changed**

Default time out and message for Mouse windows attribute

When you create an automation that contains **Mouse** actions to capture a UI element, (such as the screen or window), and if the target application is not responding, the bot times out after 30 seconds (default time) and displays a detailed message that includes:

- Description of what went wrong at that line number
- Corresponding corrective action to take

**2.14.0**

- Compatible Bot Agent version: 21.210 or later
- Compatible Control Room version: 14100 or later

**What's changed**

Help Center for developers

- Help Center: We have added an in-app help for developers to get contextual information about and when building automations.

[In-product user assistance](#) on page 1159

- Added intuitive icons for in a .

Related reference

[Mouse package](#) on page 2798

Use the `Mouse` package to simulate mouse actions.

**Number package updates**

Review the updates in released versions of packagesuch as new and enhanced features as well as fixes and limitations. The page also lists the release dates of each version, and the compatible Control Room and Bot Agent versions.

**Versions summary**

The following table lists the versions of Number package released either with an Automation 360 release or as a package-only release (in descending order of release dates). Click the version link for information about updates in that package version.

Version	Release date	Release type	Bot Agent version	Control Room build
<a href="#">3.9.1</a> on page 922	6 December 2023	With Automation 360 v.31 (Sandbox) release	20.18 or later	9130 or later
<a href="#">3.8.0</a> on page 922	6 June 2023	With Automation 360 v.29 (Sandbox) release	20.18 or later	9130 or later

### 3.9.1

- Compatible Bot Agent version: 20.18 or later
- Compatible Control Room version: 9130 or later

What's new
Internal update in packages Minor update to support API tasks.
Intuitive icons at package level We have added intuitive icons at the package level. In the Action pane, when you navigate through the different packages, these icons are displayed at the package level and provide contextual information about packages.

### 3.8.0

- Compatible Bot Agent version: 20.18 or later
- Compatible Control Room version: 9130 or later

What's changed
Help Center for developers <ul style="list-style-type: none"> <li>• Help Center: We have added an in-app help for developers to get contextual information about and when building automations. <ul style="list-style-type: none"> <li>• <a href="#">In-product user assistance</a> on page 1159</li> </ul> </li> <li>• Added intuitive icons for in a .</li> </ul>

Related reference

[Number package](#) on page 2802

The Number package contains actions that enable you to perform various operations on a number variable. A number variable holds numeric values, including integers and decimals. It holds

values from -9,223,372,036,854,775,808 to 9,223,372,036,854,775,807, and up to 15 decimal digits.

## OCR package updates

Review the updates in released versions of the OCR package such as new and enhanced features as well as fixes and limitations. The page also lists the release dates of each version, and the compatible Control Room and Bot Agent versions.

### Versions summary

The following table lists the versions of OCR package released either with an Automation 360 release or as a package-only release (in descending order of release dates). Click the version link for information about updates in that package version.

Version	Release date	Release type	Bot Agent version	Control Room build
<a href="#">2.13.1</a> on page 923	6 December 2023	With Automation 360 v.31 (Sandbox) release	21.118 or later	8750 or later
<a href="#">2.12.1</a> on page 923	6 June 2023	With Automation 360 v.29 (Sandbox) release	21.118 or later	8750 or later

#### 2.13.1

- Compatible Bot Agent version: 21.118 or later
- Compatible Control Room version: 8750 or later

What's changed
<p>Intuitive icons at package level</p> <p>We have added intuitive icons at the package level. In the Action pane, when you navigate through the different packages, these icons are displayed at the package level and provide contextual information about packages.</p>

#### 2.12.1

- Compatible Bot Agent version: 21.118 or later
- Compatible Control Room version: 8750 or later

What's changed
Enhanced OCR package error messaging
<p>When you create an automation which contains actions used to capture text from images or applications, and if the target application is not responding, the bot times out after 30 seconds (default time) and displays a more detailed message including: what went wrong at that line number and the corresponding corrective action to take.</p> <p><a href="#">Using Capture window action from OCR package</a> on page 2807  <a href="#">Using Capture area action from OCR package</a> on page 2809</p>
<p>Help Center for developers</p> <p>Help Center: We have added an in-app help for developers to get contextual information about and when building automations.</p> <p><a href="#">In-product user assistance</a> on page 1159</p>

Related reference

[OCR package](#) on page 2804

The OCR package contains actions that enable you to extract text from images or applications.

## PDF package updates

Review the updates in released versions of the PDF package such as new and enhanced features as well as fixes and limitations. The page also lists the release dates of each version, and the compatible Control Room and Bot Agent versions.

### Versions summary

The following table lists the versions of PDF package released either with an Automation 360 release or as a package-only release (in descending order of release dates). Click the version link for information about updates in that package version.

Version	Release date	Release type	Bot Agent version	Control Room build
<a href="#">3.10.0</a> on page 924	6 December 2023	With Automation 360 v.31 (Sandbox) release	21.31 or later	9300 or later
<a href="#">3.9.0</a> on page 925	6 June 2023	With Automation 360 v.29 (Sandbox) release	21.31 or later	9300 or later

### 3.10.0

- Compatible Bot Agent version: 21.31 or later

- Compatible Control Room version: 9300 or later

What's changed
Improved view of extract fields area in PDF viewer You can now scroll through the extracted field list in the PDF viewer when you open the PDF viewer from the <b>PDF &gt; Extract field</b> action. Service Cloud case ID: 01989048

### 3.9.0

- Compatible Bot Agent version: 21.31 or later
- Compatible Control Room version: 9300 or later

Fixes
You can now extract a drop-down field from a specific PDF file successfully using the <b>PDF &gt; Extract field</b> action. Service Cloud case ID: 01952183
When you use the <b>PDF &gt; Extract image</b> action to save the PDF file as an image, you no longer encounter data loss in the extracted image and color and black rectangle issues in JPEG image extractions.

Related reference

[PDF package](#) on page 2879

Use the PDF package to automate various operations on a PDF file.

## PGP package updates

Review the updates in released versions of the PGP package such as new and enhanced features as well as fixes and limitations. The page also lists the release dates of each version, and the compatible Control Room and Bot Agent versions.

### Versions summary

The following table lists the versions of PGP package released either with an Automation 360 release or as a package-only release (in descending order of release dates). Click the version link for information about updates in that package version.

Version	Release date	Release type	Bot Agent version	Control Room build
<a href="#">3.7.1</a> on page 926	6 December 2023	With Automation 360 v.31 (Sandbox) release	21.88 or later	10195 or later

Version	Release date	Release type	Bot Agent version	Control Room build
<a href="#">3.6.0</a> on page 926	6 June 2023	With Automation 360 v.29 (Sandbox) release	21.88 or later	10195 or later

### 3.7.1

- Compatible Bot Agent version: 21.88 or later
- Compatible Control Room version: 10195 or later

What's changed
<p>Intuitive icons at package level</p> <p>We have added intuitive icons at the package level. In the Action pane, when you navigate through the different packages, these icons are displayed at the package level and provide contextual information about packages.</p>

Fix
<p>The bot no longer encounters an error when you use the <b>PGP &gt; Decrypt</b> action to retrieve the contents of encrypted files even if both private and public keys are present in the same file.</p>

### 3.6.0

- Compatible Bot Agent version: 21.88 or later
- Compatible Control Room version: 10195 or later

What's changed
<p>Help Center for developers</p> <ul style="list-style-type: none"> <li>• Help Center: We have added an in-app help for developers to get contextual information about and when building automations.</li> </ul> <p><a href="#">In-product user assistance</a> on page 1159</p> <ul style="list-style-type: none"> <li>• Added intuitive icons for in a .</li> </ul>

Related reference

[PGP package](#) on page 2888

Use the PGP (Pretty Good Privacy) package to automatically encrypt and decrypt files for security.

## Ping package updates

Review the updates in released versions of the Ping package such as new and enhanced features as well as fixes and limitations. The page also lists the release dates of each version, and the compatible Control Room and Bot Agent versions.

### Versions summary

The following table lists the versions of Ping package released either with an Automation 360 release or as a package-only release (in descending order of release dates). Click the version link for information about updates in that package version.

Version	Release date	Release type	Bot Agent version	Control Room build
<a href="#">3.6.0 on page 927</a>	6 December 2023	With Automation 360 v.31 (Sandbox) release	20.11 or later	8750 or later
<a href="#">3.5.0 on page 927</a>	6 June 2023	With Automation 360 v.29 (Sandbox) release	20.11 or later	8750 or later

### 3.6.0

- Compatible Bot Agent version: 20.11 or later
- Compatible Control Room version: 8750 or later

What's changed
<p>Intuitive icons at package level</p> <p>We have added intuitive icons at the package level. In the Action pane, when you navigate through the different packages, these icons are displayed at the package level and provide contextual information about packages.</p>

### 3.5.0

- Compatible Bot Agent version: 20.11 or later
- Compatible Control Room version: 8750 or later

**What's changed**

Help Center for developers  
 Added intuitive icons for in a .

## Play Sound package updates

Review the updates in released versions of the Play Sound package such as new and enhanced features as well as fixes and limitations. The page also lists the release dates of each version, and the compatible Control Room and Bot Agent versions.

### Versions summary

The following table lists the versions of Play Sound package released either with an Automation 360 release or as a package-only release (in descending order of release dates). Click the version link for information about updates in that package version.

Version	Release date	Release type	Bot Agent version	Control Room build
<a href="#">2.6.0-20220421-071315</a> on page 928	April 2023	With Automation 360 v.29 (Sandbox) release	20.11 or later	8750 or later

### 2.6.0-20220421-071315

- Compatible Bot Agent version: 20.11 or later
- Compatible Control Room version: 8750 or later

**What's changed**

Help Center for developers

- Help Center: We have added an in-app help for developers to get contextual information about and when building automations.  
[In-product user assistance](#) on page 1159
- Added intuitive icons for in a .

Related reference

[Play Sound package](#) on page 2891



The Play Sound package contains actions that enable you to play a beep sound and media file before or after an action is executed in a bot.

## Printer package updates

Review the updates in released versions of the Printer package such as new and enhanced features as well as fixes and limitations. The page also lists the release dates of each version, and the compatible Control Room and Bot Agent versions.

### Versions summary

The following table lists the versions of Printer package released either with an Automation 360 release or as a package-only release (in descending order of release dates). Click the version link for information about updates in that package version.

Version	Release date	Release type	Bot Agent version	Control Room build
<a href="#">2.7.0 on page 929</a>	6 December 2023	With Automation 360 v.31 (Sandbox) release	20.11 or later	8750 or later
<a href="#">2.6.0 on page 929</a>	6 June 2023	With Automation 360 v.29 (Sandbox) release	20.11 or later	8750 or later

### 2.7.0

- Compatible Bot Agent version: 20.11 or later
- Compatible Control Room version: 8750 or later

What's changed
<p>Intuitive icons at package level</p> <p>We have added intuitive icons at the package level. In the Action pane, when you navigate through the different packages, these icons are displayed at the package level and provide contextual information about packages.</p>

### 2.6.0

- Compatible Bot Agent version: 20.11 or later
- Compatible Control Room version: 8750 or later

**What's changed**

Help Center for developers

- Help Center: We have added an in-app help for developers to get contextual information about and when building automations.  
[In-product user assistance](#) on page 1159
- Added intuitive icons for in a .

Related reference

[Printer package](#) on page 2891

Use the actions in the Printer package to automate retrieving and setting the default printer and removing a printer from the list of available printers.

## Process Composer package updates

Review the updates in released versions of Process Composer package such as new and enhanced features as well as fixes and limitations. The page also lists the release dates of each version, and the compatible Control Room and Bot Agent versions.

### Versions summary

Version	Release date	Release type	Bot Agent version	Control Room build
<a href="#">7.30.2</a> on page 930	16 November 2023	Package-only; post Automation 360 v.30 release	21.134 or later	12316 or later
<a href="#">7.29.0-20230509-185011</a> on page 931	18 May 2023	With Automation 360 (v.29 Sandbox)	21.134 or later	12316 or later

### 7.30.2

- Compatible Bot Agent version: 21.134 or later
- Compatible Control Room version: 12316 or later

**Fixes**

The **Query Human Task** action no longer generates an error message relative to the NumberValue field. As of the Automation 360 v.30 release, this error was generated regardless of which field was configured.

## 7.29.0-20230509-185211

- Compatible Bot Agent version: 21.134 or later
- Compatible Control Room version: 12316 or later

Fixes
Security updates to address vulnerabilities in Blackduck Apache PDFBox.
In the Bot editor, the <b>Create a request</b> action in the Process Composer package now supports table variables. This allows you to pass the data of a table to the initial form during run time in Automation Co-Pilot.

## Prompt package updates

Review the updates in released versions of the Prompt package such as new and enhanced features as well as fixes and limitations. The page also lists the release dates of each version, and the compatible Control Room and Bot Agent versions.

### Versions summary

The following table lists the versions of Prompt package released either with an Automation 360 release or as a package-only release (in descending order of release dates). Click the version link for information about updates in that package version.

Version	Release date	Release type	Bot Agent version	Control Room build
<a href="#">2.8.0</a> on page 931	6 December 2023	With Automation 360 v.31 (Sandbox) release	20.11 or later	8750 or later
<a href="#">2.7.1</a> on page 932	6 June 2023	With Automation 360 v.29 (Sandbox) release	20.11 or later	8750 or later

## 2.8.0

- Compatible Bot Agent version: 20.11 or later
- Compatible Control Room version: 8750 or later

**What's changed**

## Intuitive icons at package level

We have added intuitive icons at the package level. In the Action pane, when you navigate through the different packages, these icons are displayed at the package level and provide contextual information about packages.

**2.7.1**

- Compatible Bot Agent version: 20.11 or later
- Compatible Control Room version: 8750 or later

**What's changed**

## Help Center for developers

- Help Center: We have added an in-app help for developers to get contextual information about and when building automations.

[In-product user assistance](#) on page 1159

- Added intuitive icons for in a .

Related reference

[Prompt package](#) on page 2905

Use the Prompt package to accept an input value, a yes/no response, or to open a file or folder.

## Python Script package updates

Review the updates in released versions of the Python Script package such as new and enhanced features as well as fixes and limitations. The page also lists the release dates of each version, and the compatible Control Room and Bot Agent versions.

### Versions summary

The following table lists the versions of Python Script package released either with an Automation 360 release or as a package-only release (in descending order of release dates). Click the version link for information about updates in that package version.

Version	Release date	Release type	Bot Agent version	Control Room build
<a href="#">2.16.0</a> on page 933	6 December 2023	With Automation 360 v.31 (Sandbox) release	20.11 or later	8750 or later

Version	Release date	Release type	Bot Agent version	Control Room build
<a href="#">2.15.0</a> on page 933	6 June 2023	With Automation 360v.29 (Sandbox) release	20.11 or later	8750 or later

## 2.16.0

- Compatible Bot Agent version: 20.11 or later
- Compatible Control Room version: 8750 or later

What's changed
<p>Intuitive icons at package level</p> <p>We have added intuitive icons at the package level. In the Action pane, when you navigate through the different packages, these icons are displayed at the package level and provide contextual information about packages.</p>

## 2.15.0

- Compatible Bot Agent version: 20.11 or later
- Compatible Control Room version: 8750 or later

What's changed
<p>Help Center for developers</p> <ul style="list-style-type: none"> <li>• Help Center: We have added an in-app help for developers to get contextual information about and when building automations.</li> </ul> <p><a href="#">In-product user assistance</a> on page 1159</p> <ul style="list-style-type: none"> <li>• Added intuitive icons for in a .</li> </ul>

Related reference

[Python Script package](#) on page 2907

The Python Script package contains actions that enable Python Script functions in a task.

## Record package updates

Review the updates in released versions of packagesuch as new and enhanced features as well as fixes and limitations. The page also lists the release dates of each version, and the compatible Control Room and Bot Agent versions.

### Versions summary

The following table lists the versions of Record package released either with an Automation 360 release or as a package-only release (in descending order of release dates). Click the version link for information about updates in that package version.

Version	Release date	Release type	Bot Agent version	Control Room build
<a href="#">1.10.0</a> on page 934	6 December 2023	With Automation 360 v.31 (Sandbox) release	21.134 or later	17917 or later
<a href="#">1.8.2</a> on page 934	6 June 2023	With Automation 360 v.29 (Sandbox) release	21.134 or later	17917 or later

### 1.10.0

- Compatible Bot Agent version: 21.134 or later
- Compatible Control Room version: 17917 or later

What's changed
<p>Intuitive icons at package level</p> <p>We have added intuitive icons at the package level. In the Action pane, when you navigate through the different packages, these icons are displayed at the package level and provide contextual information about packages.</p>

### 1.8.2

- Compatible Bot Agent version: 21.134 or later
- Compatible Control Room version: 17917 or later

**What's new**

The following actions have been introduced in the Record package:

- **Add column** action
- **Delete column** action
- **Updated column** action

[Record package](#) on page 2912

**What's changed**

Help Center for developers

- Help Center: We have added an in-app help for developers to get contextual information about and when building automations.

[In-product user assistance](#) on page 1159

- Added intuitive icons for in a .

Related reference

[Record package](#) on page 2912

The **Record** package enables you to perform various operations on record-type variables. A record-type variable holds a row of data extracted from a database, spreadsheet, or table in name-field pairs. The fields can store values of Boolean, datetime, number, or string data type.

## Recorder package updates

Review the updates in released versions of the Recorder package such as new and enhanced features as well as fixes and limitations. The page also lists the release dates of each version, and the compatible Control Room and Bot Agent versions.

### Versions summary

The following table lists the versions of Recorder package released either with an Automation 360 release or as a package-only release (in descending order of release dates). Click the version link for information about updates in that package version.

Version	Release date	Release type	Bot Agent version	Control Room build
<a href="#">2.16.0-20231101-165437</a> on page 936	November 2023	Package-only; post Automation 360 v.30 release	21.210 or later	14068 or later
<a href="#">2.15.2-20231004-180236</a> on page 937	October 2023	Package-only; post Automation 360 v.30 release	21.210 or later	14068 or later

Version	Release date	Release type	Bot Agent version	Control Room build
<a href="#">2.14.1-20230904-102810</a> on page 938	10 September 2023	Package-only; post Automation 360 v.30 (Sandbox) release	21.210 or later	14068 or later
<a href="#">2.13.6-20230809-167407</a> on page 939	16 August 2023	Package-only; post Automation 360 v.29 release	21.210 or later	14068 or later
<a href="#">2.11.5-20230512-063352</a> on page 941	6 June 2023	With Automation 360 v.29 (Sandbox) release	21.210 or later	14068 or later

## 2.16.0-20231101-165457

- Compatible Bot Agent version: 21.210 or later
- Compatible Control Room version: 14068 or later

**Note:** This version is also available in the v.31 release.

What's new
<p>Improved automation start-up performance (Service Cloud case ID: 01981949)</p> <p>When you run the bot with the Recorder package, the executable files used to run configurations in the Bot Agent will now be executed within the Bot Agent component itself. This reduces the bot execution pre-configurations and will improve the performance of your bot execution.</p> <hr/> <p><b>Note:</b> Ensure that you use the Recorder package (version 2.16.0-20231101-165457 and later) with the Bot Agent (version 22.20.2) that was released with Automation 360 v.31.</p> <hr/> <p><a href="#">Recorder package</a> on page 2916</p>
<p>Citrix XenApp support for multi-version Recorder packages in parent and child bots</p> <p>You can now successfully execute parent and child bots that use different versions of the Recorder package in a Citrix XenApp environment.</p> <hr/> <p><b>Note:</b> To use and execute multiple versions of the Recorder package in a bot effectively, ensure that your bots, both parent and child, use the Recorder package (version 2.16.0-20231101-165457 and later). Using earlier versions might not support this feature and could cause inconsistencies or errors during bot execution in Citrix environments.</p> <hr/> <p><a href="#">Recorder package</a> on page 2916</p>



**Fixes**

You no longer encounter COMUI access violation issues due to unintended object releases during UI element search operations. This improves the overall system performance and user experience.

**2.15.2-20231004-180246**

- Compatible Bot Agent version: 21.210 or later
- Compatible Control Room version: 14068 or later

**What's new**

Improve productivity from a simplified recording experience

Use the new simplified Recorder to start a recording directly from the business application without having to identify the target application from the list of application titles opened. This enables you to have a simpler and faster recording experience and have a real-time visibility of the automated actions. You can:

- Review recorded actions and images of the recorded UI elements.
- Traverse through those recorded actions.
- Take actions in the midst of the recording.

**Important:** The simplified Recorder feature is not available out of the box and can be enabled on an on-demand basis. Contact your Automation Anywhere account team for assistance.

[Simplified recording experience](#) on page 2951

Launch Control Room as XenApp

You can now launch the Google Chrome or Microsoft Edge browser window from a Citrix XenApp application, access the Control Room from the specific browser, and automate other virtual applications which are run as XenApps. This enables reliable object-based automation when you deploy and launch both Control Room and business applications as virtual applications from the same system. The following actions now run successfully in a Citrix Xenapp environment:

- **Recorder > Capture** action
- **Mouse > Click and Move** actions

**Note:** When you launch the Control Room as a XenApp, Automation Anywhere remote agent for Citrix is not required.

[Recorder package](#) on page 2916

**What's new**

Automate partially loaded websites

You can now successfully automate specific objects on web pages that are not completely loaded during bot run. Use the new **Set system time out > Advanced** option in the **Recorder > Capture** action to choose whether to proceed to the object directly and capture it even if the web page has not loaded completely or to stop the bot and display an error message.

For example, some websites are constantly updating with latest data such as latest stock prices and are never technically fully loaded on screen. In such cases, the bot does not need to wait for the web page to load completely and can directly proceed with automating the web page after a certain time.

[Using the Capture action](#) on page 2940

**Fixes**

When you use the Recorder with Microsoft UI automation technology, you can now successfully retrieve the data from a specific cell in a table.

**Note:** Ensure that you recapture the table using Microsoft UI Automation.

You no longer encounter an issue when you use the List view control on the Java-based application to select an item by text or index.

Previously, multiple items were selected when you used list view control to automate an operation within the application.

Service Cloud case ID: 01991025

**Limitations**

When you launch the Control Room and business applications from the same XenApp sessions, click the **Start recording** option to capture objects, the task bar and the screen might appear blackened.

When you use the Recorder to automate electron applications using Microsoft UI Automation (COM) technology, you might not be able to capture child elements.

Workaround: Use Microsoft Active Accessibility or Microsoft UI Automation technology first to capture one child element. This will enable the accessibility in electron applications. You can then use Microsoft UI Automation (COM) technology to capture the remaining child elements.

**2.14.1-20230904-102210**

- Compatible Bot Agent version: 21.210 or later
- Compatible Control Room version: 14068 or later

Fixes
The <b>Recorder &gt; Get table</b> action for SAP technology successfully exports all the table data from the SAP application.
AI Sense technology now validates the table captured in the legacy Recorder package and the <b>Give</b> action is executed successfully. Service Cloud case ID: 01952160, 01952160

### 2.13.6-20230809-153403

- Compatible Bot Agent version: 21.210 or later
- Compatible Control Room version: 14068 or later

**Note:** This version is also available in the v.30 release.

What's new
Automate UI elements having parent controls with inline JavaScript Use the new <b>Debugger click</b> action in the Recorder when you are unable to execute the <b>Click</b> action on a control whose parent control has an inline JavaScript.
<b>Note:</b> <ul style="list-style-type: none"> <li>• You can use this action to automate controls only on web pages using HTML technology.</li> <li>• Ensure that you install the 3.1.0.0 version of Google Chrome and Microsoft Edge extensions and the Recorder package (version 2.13.6-20230809-153403) released with Automation 360 v.30.</li> </ul>

What's changed
Capture Electron applications using Microsoft UI Automation (COM) technology (Service Cloud case ID: 00785350) When automating an Electron application, the Recorder now captures specific controls on the application using the Microsoft UI Automation (COM) technology by default. This enables you to automate Electron applications seamlessly without having to recapture the object with a specific technology.
Support device credentials in UPN format with Recorder The Recorder now captures and automates objects successfully when you enter your device credentials in the UPN (user principal name) format.

**What's changed**

The **Handle unexpected pop-ups** functionality is enhanced with the following changes:

- Manage multiple (up to 5) pop-ups.
- Handle unexpected pop-ups for the HTML technology.

[Manage unexpected pop-ups](#) on page 1085

**Fixes**

When you capture an object in any browser using **Recorder > Capture** action with technology type as **Microsoft Active Accessibility**, the bot can now perform left click/right click/double click the object.

Previously, when you captured an object in any browser using MSA technology, the bot could not perform left click/right click/double click due to the runtime window in the foreground, and the control was not in focus (not visible).

Service Cloud case ID: 01969776

When you capture the **Page tab** or **Tree** control using Java technology and then use the **Get selected** or **Select item by text** actions, the application does not crash during bot execution.

Previously, the application on which Recorder package executed was crashing.

Service Cloud case ID: 01972119, 01983570, 01976678, 01986154

When you capture the **Page tab** control and perform the **Select item by text** action on an already selected tab, it will now execute the bot successfully without any issue.

Previously, the bot displayed an error when you executed the **Select item by text** action.

When you use Microsoft Edge in Internet Explorer mode to play the **HTML Recorder** action, the `Automation.CSharpDLLWrapper.exe` in the Recorder package does not crash any longer. Previously, the `Automation.CSharpDLLWrapper.exe` crashed intermittently when the `frame.length` was null.

Service Cloud case ID: 01983400

The **Capture** action now times out if the SAP application stops responding while trying to capture any interaction.

Service Cloud case ID: 01979580

When you use the Recorder to capture controls using Java technology, the bot now successfully extracts the **Path** object property of that specific control.

Previously, when you tried to extract the **Path** object property, it returned a blank value.

When you use the Recorder to automate controls on a Java application, use the **Get selected text** action to retrieve data from the selected item, and run the bot, the Java application no longer gets terminated.

Service Cloud case ID: 01986154, 01976678

Fixes
Removed JxCapture dependency.
<p>When you migrate a bot containing an Object Cloning command or MetaBot created using Java technology and run the same bot in Automation 360, it executes successfully without delay.</p> <p>Previously, when you executed the migrated bot in Automation 360, it took longer to complete execution due to some performance issues.</p> <p>Service Cloud case ID: 01957525</p>
<p>You can now use the Recorder to search and capture a specific control on a Java web application running on Microsoft Edge with IE mode using the <b>Path or variable path</b> object property. Previously, the Recorder searched the object by location if the search by path failed on a Java web application.</p> <p>Service Cloud case ID: 01948537, 01946746</p>
<p>You can now use the Recorder with Microsoft UI automation (COM) technology to successfully capture and extract rows from a Table control.</p> <p>Service Cloud case ID: 01937622, 01937158, 01942234, 01960301, 01956515, 01973683</p>
<p>You can now use the Recorder with Microsoft UI automation (COM) technology to capture and automate tables that have large data sets.</p> <p>Service Cloud case ID: 01953882, 01958202</p>
<p>When you use the Recorder (version 2.10.2-20230104-214915) to capture objects on a SAP Fiori application, the bot now captures the objects successfully. Previously, the bot failed with an error message: <b>Unable to find BUTTON. Search Criteria did not match.</b></p> <p>Service Cloud case ID: 01983593</p>
<p>You no longer encounter issues when you use the Recorder package to automate SAP applications and then use the <b>Control type</b> as <code>Table</code> (Grid view) to set cell by text or index. Previously, when you used the <b>Control type</b> as <code>Table</code> (Grid view) to set cell by text or index, the bot failed to set the values.</p>

### 2.11.5-20230512-083852

- Compatible Bot Agent version: 21.210 or later
- Compatible Control Room version: 14068 or later

**What's new**

Automate controls using Microsoft UI Automation (COM) technology

You can use the Microsoft UI Automation (COM) technology to capture and automate the following controls:

- Calendar controls
- Menu controls
- Slider controls

[Capture using specific technology](#) on page 2948 | [Actions performed on objects captured with Universal Recorder](#) on page 2923

New actions for Table control

When you use the Microsoft UI Automation (COM) technology in the Recorder to automate a table, you can select the following new **Table** control actions from the **Action** drop-down:

- **Click on cell by index**
- **Click on cell by text**
- **Left click on cell by index**
- **Left click on cell by text**
- **Right click on cell by index**
- **Right click on cell by text**
- **Double click on cell by index**
- **Double click on cell by text**

[Actions performed on objects captured with Universal Recorder](#) on page 2923

Automate business applications on remote devices accessed over VMWare VDIs

By installing our native Remote Agent on VMware server, you can now automate your business applications that are running on remote devices and are accessed over VMware VDIs. Our native Remote Agent enables secure communication between VMware server and Bot Agent and provides the object level information for automation creation and play back. This enhances the automation coverage to new use cases while providing a reliable native desktop user experience.

VMware-based automation is supported for all VMware protocols, viz VMware Blast, PCoIP, and Microsoft RDP. This eliminates the requirement for any security exceptions by IT administrators. VMware-based automation is supported for Web applications, Java applications and applications built on Microsoft Active Accessibility or UI Automation technologies.

[Automate applications running on remote machines](#) on page 2949

**What's new**

Improved performance when automating applications with multiple controls

When you use UI automation technology to automate window applications with more number of UI elements, you can now use the new **IsFirst** object property to enable the bot to detect the first object whose **ID** matches your search criteria. This improves the performance of your bot because the bot no longer needs to traverse the entire tree to match every control based on your search criteria, which would otherwise take more time and impact the performance of your bot. You can use the **IsFirst** object property when an object does not have a unique Automation ID and when the object hierarchy changes in the application.

[Using the Capture action](#) on page 2940

**Fixes**

When you use the **Recorder > Object exists** condition in the **If** action to detect an object in a window, use the **IsVisible** object property as a search criterion, and run the bot, the bot now returns the result based on the value (true or false) added in the **IsVisible** property for the captured object.

Service Cloud case ID: 01920409

When you use the Recorder package (version 2.11.5 and later) in your bot that runs on a multi-user Citrix machine on Windows Server 2012, the bot no longer fails with an error message: `Unable to initialize bot execution environment`

**Note:** If you are using a Recorder package (version earlier than 2.11.5) in your bots, then we recommend that you use the same version of the Recorder package in all your bots. However, from version 2.11.5 and later, you can use a combination of version 2.11.5 and later versions of the Recorder package.

Service Cloud case ID: 01959207

Related reference

[Recorder package](#) on page 2916

Recorder package captures a series of tasks in a process and then automates them. You can automate your business applications (for example, desktop, Web, SAP, and Java applications) using the Recorder to capture actions performed on application objects such as a text box, button, table, radio button, combo box, and list view.

## Remote agent updates

Review updates in the Remote agent versions such as new and enhanced features as well as fixes and limitations.

## Versions summary

The following table lists the Remote agent versions.

Version	Compatible with Recorder package version
<a href="#">2.3.3.29</a> on page 944	2.11.5 and later versions

### 2.3.3.29

Fix
<p>You no longer encounter issues when you capture an object and run the bot in the Xen app environment.</p> <p>Previously, when you captured an object, closed the application, and reran the same bot, it failed with an error.</p> <p>Service Cloud case ID: 01981082</p>

## Rest Web Services package updates

Review the updates in released versions of the Rest Web Services package such as new and enhanced features as well as fixes and limitations. The page also lists the release dates of each version, and the compatible Control Room and Bot Agent versions.

### Versions summary

Version	Release date	Release type	Bot Agent version	Control Room build
<a href="#">3.15.0</a> on page 944	6 September 2023	With Automation 360 v.30 (Sandbox) release	20.11 or later	8750 or later
<a href="#">3.14.0</a> on page 945	6 June 2023	With Automation 360 v.29 (Sandbox) release	20.11 or later	8750 or later

### 3.15.0

- Compatible Bot Agent version: 20.11 or later
- Compatible Control Room version: 8750 or later



**What's new****Control room OAuth connection**

Use this connection method by creating a custom OAuth connection and storing it in the Control Room. You can select the OAuth authentication type for all the actions available in the Rest Web Services package.

[REST Web Service package](#) on page 2961

**3.14.0**

- Compatible Bot Agent version: 20.11 or later
- Compatible Control Room version:
- 8750 or above

**Fix**

For the **Post method** action in the **REST web services** package, the input filetype (such as Postman) is identified automatically and is added to **Content type** in POST call.

Service Cloud Case ID: 01925817, 01958037

Related reference

[REST Web Service package](#) on page 2961

Use the actions in the REST Web Service package as methods (DELETE, GET, PATCH, POST, or PUT) to send requests to and receive responses from an API.

**Salesforce package updates**

Review the updates in released versions of the Salesforce package such as new and enhanced features as well as fixes and limitations. The page also lists the release dates of each version, and the compatible Control Room and Bot Agent versions.

**Versions summary**

Version	Release date	Release type	Bot Agent version	Control Room build
<a href="#">2.0.1</a> on page 946	6 September 2023	With Automation 360 v.30 (Sandbox) release	21.222 or later	15422 or later
<a href="#">1.3.2</a> on page 946	6 June 2023	With Automation 360 v.29 (Sandbox) release	21.222 or later	15422 or later

## 2.0.1

- Compatible Bot Agent version: 21.222 or later
- Compatible Control Room version: 15422 or later

What's new
<p><b>Control room OAuth connection</b></p> <p>Use this connection method by creating a custom Salesforce OAuth connection and storing it in the Control Room.</p> <p><a href="#">Salesforce Authentication action</a> on page 2973</p>

## 1.3.2

- Compatible Bot Agent version: 21.222 or later
- Compatible Control Room version: 15422 or later

What's changed
<p>Help Center for developers</p> <ul style="list-style-type: none"> <li>• Help Center: We have added an in-app help for developers to get contextual information about and when building automations.</li> </ul> <p><a href="#">In-product user assistance</a> on page 1159</p> <ul style="list-style-type: none"> <li>• Added intuitive icons for in a .</li> </ul>

Fix
<p>Bots using Salesforce package actions (Update or SOQL) are executing successfully without any proxy connection issues.</p> <p>Previously, some bots using Salesforce package actions (Update and SOQL) received a timeout error due to proxy connection issue.</p> <p>Service Cloud case ID: 01955727</p>

Related concepts

[Salesforce package](#) on page 2973

Salesforce is a cloud-based platform that provides software and services to create relevant customer experiences. Use the bot actions developed for the Salesforce package to automate Salesforce processes.

## SAP BAPI package updates

Review the updates in released versions of SAP BAPI package such as new and enhanced features as well as fixes and limitations. The page also lists the release dates of each version, and the compatible Control Room and Bot Agent versions.

### Versions summary

The following table lists the versions of SAP BAPI package released either with an Automation 360 release or as a package-only release (in descending order of release dates). Click the version link for information about updates in that package version.

Version	Release date	Release type	Bot Agent version	Control Room build
<a href="#">2.9.0 on page 947</a>	6 June 2023	With Automation 360 v.29 (Sandbox) release	21.2 or later	9249 or later

### 2.9.0

- Compatible Bot Agent version: 21.2 or later
- Compatible Control Room version: 9249 or later

What's new
<p>You can use the Secure Network Communications (SNC) method to authenticate to your SAP BAPI instance. SNC integrates SAP NetWeaver Single Sign-On (SSO) or an external security product with SAP systems. SNC secures the data communication paths between the various SAP system client and server components.</p> <p><a href="#">Using Connect action for SAP BAPI on page 3005</a></p>

Related reference

[SAP BAPI package on page 3003](#)

The SAP BAPI package contains actions to automate tasks and processes using SAP Business Application Programming Interface (BAPI). BAPI is a standardized method that enables a third-party application to interact with an SAP system.

## SAP package updates

Review the updates in released versions of packages such as new and enhanced features as well as fixes and limitations. The page also lists the release dates of each version, and the compatible Control Room and Bot Agent versions.

### Versions summary

The following table lists the versions of SAP package released either with an Automation 360 release or as a package-only release (in descending order of release dates). Click the version link for information about updates in that package version.

Version	Release date	Release type	Bot Agent version	Control Room build
<a href="#">3.13.0</a> on page 948	6 December 2023	With Automation 360 v.31 (Sandbox) release	21.88 or later	10195 or later
<a href="#">3.12.1</a> on page 948	16 August 2023	Package-only; post Automation 360 v.29 release	21.88 or later	10195 or later
<a href="#">3.10.0</a> on page 949	6 June 2023	With Automation 360 v.29 (Sandbox) release	21.88 or later	10195 or later

### 3.13.0

- Compatible Bot Agent version: 21.88 or later
- Compatible Control Room version: 10195 or later

What's new
Support for multiple sessions in SAP package (Service Cloud Case ID: 01851368, 01910749) You can now use multiple sessions in SAP package while creating a bot. <a href="#">SAP package</a> on page 2990

### 3.12.1

- Compatible Bot Agent version: 21.88 or later

- Compatible Control Room version: 10195 or later

**Note:** This version is also available in the v.30 release.

#### What's new

The **Connect** action in the **SAP** package is updated to include a new option called **SAP SSO**. This enables you to log into the SAP application using SSO.

[Using Connect action for SAP on page 2994](#)

### 3.10.0

- Compatible Bot Agent version: 21.88 or later
- Compatible Control Room version: 10195 or later

#### Fix

When you use the **Export table** action from the **SAP** package to export a table, the columns are no longer misaligned in the output `.csv` file.

Service Cloud Case ID: 01936415

Related reference

[SAP package](#) on page 2990

The SAP package contains actions to automate tasks and processes on a SAP application.

## Screen package updates

Review the updates in released versions of the Screen package such as new and enhanced features as well as fixes and limitations. The page also lists the release dates of each version, and the compatible Control Room and Bot Agent versions.

### Versions summary

The following table lists the versions of Screen package released either with an Automation 360 release or as a package-only release (in descending order of release dates). Click the version link for information about updates in that package version.

Version	Release date	Release type	Bot Agent version	Control Room build
<a href="#">2.10.0</a> on page 950	6 December 2023	With Automation 360 v.31 (Sandbox) release	20.11 or later	8750 or later

Version	Release date	Release type	Bot Agent version	Control Room build
<a href="#">2.9.2</a> on page 950	6 June 2023	With Automation 360 v.29 (Sandbox) release	20.11 or later	8750 or later

## 2.10.0

- Compatible Bot Agent version: 20.11 or later
- Compatible Control Room version: 8750 or later

What's changed
<p>Intuitive icons at package level</p> <p>We have added intuitive icons at the package level. In the Action pane, when you navigate through the different packages, these icons are displayed at the package level and provide contextual information about packages.</p>

## 2.9.2

- Compatible Bot Agent version: 20.11 or later
- Compatible Control Room version: 8750 or later

What's changed
<p>Help Center for developers</p> <ul style="list-style-type: none"> <li>• Help Center: We have added an in-app help for developers to get contextual information about and when building automations.</li> </ul> <p><a href="#">In-product user assistance</a> on page 1159</p> <ul style="list-style-type: none"> <li>• Added intuitive icons for in a .</li> </ul>

Related reference

[Screen package](#) on page 3011

Use the `Screen` package to automate the process of capturing screenshots. Using the actions in this package, you can capture an area of an application window, the entire computer screen, or an active open window and save it in a specified location in an image format.

## Service package updates

Review the updates in released versions of packages such as new and enhanced features as well as fixes and limitations. The page also lists the release dates of each version, and the compatible Control Room and Bot Agent versions.

### Versions summary

The following table lists the versions of Service package released either with an Automation 360 release or as a package-only release (in descending order of release dates). Click the version link for information about updates in that package version.

Version	Release date	Release type	Bot Agent version	Control Room build
<a href="#">4.9.0 on page 951</a>	6 December 2023	With Automation 360 v.31 (Sandbox) release	20.11 or later	8750 or later
<a href="#">4.8.0 on page 951</a>	6 June 2023	With Automation 360 v.29 (Sandbox) release	20.11 or later	8750 or later

### 4.9.0

- Compatible Bot Agent version: 20.11 or later
- Compatible Control Room version: 8750 or later

What's changed
<p>Intuitive icons at package level</p> <p>We have added intuitive icons at the package level. In the Action pane, when you navigate through the different packages, these icons are displayed at the package level and provide contextual information about packages.</p>

### 4.8.0

- Compatible Bot Agent version: 20.11 or later
- Compatible Control Room version: 8750 or later

**What's changed**

Help Center for developers

- Help Center: We have added an in-app help for developers to get contextual information about and when building automations.

[In-product user assistance](#) on page 1159

- Added intuitive icons for in a .

Related reference

[Service package](#) on page 3016

Use the Service package to automate operations in Windows and application services including starting, stopping, pausing, resuming, or getting the status of services.

## ServiceNow package updates

Review the updates in released versions of ServiceNow packagesuch as new and enhanced features as well as fixes and limitations. The page also lists the release dates of each version, and the compatible Control Room and Bot Agent versions.

### Versions summary

The following table lists the versions of ServiceNow package released either with an Automation 360 release or as a package-only release (in descending order of release dates). Click the version link for information about updates in that package version.

Version	Release date	Release type	Bot Agent version	Control Room build
<a href="#">2.0.1</a> on page 952	6 September 2023	With Automation 360 v.30 (Sandbox) release	21.230 or later	16455 or later
<a href="#">1.1.1</a> on page 953	6 June 2023	With Automation 360 v.29 (Sandbox) release	21.230 or later	16455 or later

### 2.0.1

- Compatible Bot Agent version: 21.230 or later
- Compatible Control Room version: 16455 or later



**What's new****Control room OAuth connection**

Use this connection method by creating a custom ServiceNow OAuth connection and storing it in the Control Room.

[ServiceNow authentication action](#) on page 3019

**1.1.1**

- Compatible Bot Agent version: 21.230 or later
- Compatible Control Room version: 16455 or later

**What's new**

Help Center for developers

- Help Center: We have added an in-app help for developers to get contextual information about and when building automations.

[In-product user assistance](#) on page 1159

- Added intuitive icons for in a .

Related concepts

[ServiceNow package](#) on page 3018

ServiceNow is a leading software provider of digital work flows for enterprise operations. The Automation 360 ServiceNow command package uses the ServiceNow APIs to let you build and deploy bots in Automation 360 that work with records and triggers in ServiceNow.

## SharePoint package updates

Review the updates in released versions of SharePoint packagesuch as new and enhanced features as well as fixes and limitations. The page also lists the release dates of each version, and the compatible Control Room and Bot Agent versions.

### Versions summary

The following table lists the versions of SharePoint package released either with an Automation 360 release or as a package-only release (in descending order of release dates). Click the version link for information about updates in that package version.

Version	Release date	Release type	Bot Agent version	Control Room build
<a href="#">2.1.2</a>	<ul style="list-style-type: none"> <li>6 September 2023</li> <li>16 August 2023</li> </ul>	<ul style="list-style-type: none"> <li>With Automation 360 v.30 (Sandbox) release</li> <li>Package-only; post Automation 360 v.29 release</li> </ul>	21.250 or later	18000 or later
<a href="#">1.0.4 on page 955</a>	6 June 2023	With Automation 360 v.29 (Sandbox) release	21.250 or later	18000 or later

## 2.1.2

Updated in v.30 release

- Compatible Bot Agent version: 21.250 or later
- Compatible Control Room version: 18000 or later

**Note:** Additional updates are available in the version in v.30, including the updates made available on .

What's new
<p><b>Control room OAuth connection</b></p> <p>Use this connection method by creating a custom SharePoint OAuth connection and storing it in the Control Room.</p> <p><a href="#">SharePoint authenticate action</a> on page 3038</p>

Updated in August 2023

- Compatible Bot Agent version: 21.250 or later
- Compatible Control Room version: 18000 or later

What's new
<p>You can now connect to a SharePoint Teams site using the <b>Teams site</b> option in the authenticate action. After connecting to the Teams site you can perform all SharePoint operations.</p> <p><a href="#">SharePoint authenticate action</a> on page 3038</p>

**What's new**

You can now use either a list name or a list ID when creating a list item in SharePoint. Previously, only list name was supported.

[SharePoint create list item action](#) on page 3058

**1.0.4**

- Compatible Bot Agent version: 21.250 or later
- Compatible Control Room version: 18000 or later

**What's new**

You can use the new SharePoint package to manage your documents, sites, and data. You can use the SharePoint package to perform the following CRUD (create, read, update, and delete) actions in a SharePoint site:

- CRUD operations for folder and file
- CRUD operations for list and list items

[SharePoint package](#) on page 3034

Related concepts

[SharePoint package](#) on page 3034

SharePoint is a web-based platform that is used for collaboration and document management. You can use the Automation 360 SharePoint command package to manage your documents, sites, and data.

## Simulate keystrokes package updates

Review the updates in released versions of the Simulate keystrokes package such as new and enhanced features as well as fixes and limitations. The page also lists the release dates of each version, and the compatible Control Room and Bot Agent versions.

### Versions summary

The following table lists the versions of Simulate keystrokes package released either with an Automation 360 release or as a package-only release (in descending order of release dates). Click the version link for information about updates in that package version.

Version	Release date	Release type	Bot Agent version	Control Room build
<a href="#">4.3.0 on page 956</a>	6 September 2023	With Automation 360 v.30 (Sandbox) release	21.200 or later	13297 or later

Version	Release date	Release type	Bot Agent version	Control Room build
<a href="#">4.2.0</a> on page 956	6 June 2023	With Automation 360 v.29 (Sandbox) release	21.200 or later	13297 or later

### 4.3.0

- Compatible Bot Agent version: 21.200 or later
- Compatible Control Room version: 13297 or later

Fixes
Removed JxCapture dependency

### 4.2.0

- Compatible Bot Agent version: 21.200 or later
- Compatible Control Room version: 13297 or later

What's changed
<p>Help Center for developers</p> <ul style="list-style-type: none"> <li>• Help Center: We have added an in-app help for developers to get contextual information about and when building automations.</li> </ul> <p><a href="#">In-product user assistance</a> on page 1159</p> <ul style="list-style-type: none"> <li>• Added intuitive icons for in a .</li> </ul>

Related reference

[Simulate keystrokes package](#) on page 3070

Use the Simulate keystrokes package to simulate keystrokes in Chinese (simplified and traditional), English, French, German, Japanese, Korean, Italian, or Spanish characters.

## SNMP package updates

Review the updates in released versions of the SNMP package such as new and enhanced features as well as fixes and limitations. The page also lists the release dates of each version, and the compatible Control Room and Bot Agent versions.

### Versions summary

The following table lists the versions of SNMP package released either with an Automation 360 release or as a package-only release (in descending order of release dates). Click the version link for information about updates in that package version.

Version	Release date	Release type	Bot Agent version	Control Room build
<a href="#">2.8.0</a> on page 957	6 December 2023	With Automation 360 v.31 (Sandbox) release	20.11 or later	8750 or later
<a href="#">2.7.1</a> on page 957	6 June 2023	With Automation 360 v.29 (Sandbox) release	20.11 or later	8750 or later

### 2.8.0

- Compatible Bot Agent version: 20.11 or later
- Compatible Control Room version: 8750 or later

What's changed
<p>Intuitive icons at package level</p> <p>We have added intuitive icons at the package level. In the Action pane, when you navigate through the different packages, these icons are displayed at the package level and provide contextual information about packages.</p>

### 2.7.1

- Compatible Bot Agent version: 20.11 or later
- Compatible Control Room version: 8750 or later

**What's changed**

Help Center for developers

- Help Center: We have added an in-app help for developers to get contextual information about and when building automations.

[In-product user assistance](#) on page 1159

- Added intuitive icons for in a .

Related reference

[SNMP package](#) on page 3072

The SNMP package allows you to automate network management tasks, such as retrieving and modifying data, and sending notification messages.

## SOAP Web Services package updates

Review the updates in released versions of packagesuch as new and enhanced features as well as fixes and limitations. The page also lists the release dates of each version, and the compatible Control Room and Bot Agent versions.

### Versions summary

The following table lists the versions of SOAP Web Service package released either with an Automation 360 release or as a package-only release (in descending order of release dates). Click the version link for information about updates in that package version.

Version	Release date	Release type	Bot Agent version	Control Room build
<a href="#">3.17.0</a> on page 958	16 August 2023	Package-only; post Automation 360 v.29 release	21.240 or later	17571 or later
<a href="#">3.15.0</a> on page 959	6 June 2023	With Automation 360 v.29 (Sandbox) release	21.90 or later	10227 or later

### 3.17.0

- Compatible Bot Agent version: 21.240 or later
- Compatible Control Room version: 17571 or later

---

**Note:** This version is also available in the v.30 release.

---

**What's changed**

Help Center for developers

- Help Center: We have added an in-app help for developers to get contextual information about and when building automations.  
[In-product user assistance](#) on page 1159
- Added intuitive icons for in a .

**Fix**

If one or more of the nested WSDL are not accessible, all the nested WSDL are ignored, and the bot will now execute the Build Soap Request desktop operation with the provided WSDL details.

Service Cloud Case ID: 01966914, 01985050

**3.15.0**

- Compatible Bot Agent version: 21.90 or later
- Compatible Control Room version: 10227 or later

**What's changed**

Help Center for developers

- Help Center: We have added an in-app help for developers to get contextual information about and when building automations.  
[In-product user assistance](#) on page 1159
- Added intuitive icons for in a .

Related reference

[SOAP Web Service package](#) on page 3084

Use the **SOAP web service** action from the SOAP Web Service package to access and exchange information between two systems in XML format.

## String package updates

Review the updates in released versions of the String package such as new and enhanced features as well as fixes and limitations. The page also lists the release dates of each version, and the compatible Control Room and Bot Agent versions.

### Versions summary

The following table lists the versions of String package released either with an Automation 360 release or as a package-only release (in descending order of release dates). Click the version link for information about updates in that package version.

Version	Release date	Release type	Bot Agent version	Control Room build
<a href="#">5.9.0</a> on page 960	6 December 2023	With Automation 360 v.31 (Sandbox) release	20.18 or later	9130 or later
<a href="#">5.8.0</a> on page 960	6 September 2023	With Automation 360 v.30 (Sandbox) release	20.18 or later	9130 or later
<a href="#">5.7.1</a> on page 961	6 June 2023	With Automation 360 v.29 (Sandbox) release	20.18 or later	9130 or later

### 5.9.0

- Compatible Bot Agent version: 20.18 or later
- Compatible Control Room version: 9130 or later

What's changed
Internal update in packages Minor update to support API tasks.

### 5.8.0

- Compatible Bot Agent version: 20.18 or later
- Compatible Control Room version: 9130 or later



Fixes
<p>The <b>Before</b> and <b>After</b> options in the <b>String &gt; Extract text</b> action in the interface are now correctly translated in Japanese language.</p> <p>Service Cloud Case ID: 01959775, 01995941</p>

### 5.7.1

- Compatible Bot Agent version: 20.18 or later
- Compatible Control Room version: 9130 or later

What's new
<p>Extract maximum number of characters from the source string</p> <p>A new <b>Up to</b> field has been added to the <b>String &gt; Extract text</b> action that enables you to enter the maximum number of characters to extract from the source string.</p> <p><a href="#">Using Extract text action of String package on page 3089</a></p>
<p>New option in the Substring action</p> <p>When you use the <b>String &gt; Substring</b> action to extract a part of content from a string, you can select the <b>Return blank if the range is not found</b> check box. This enables the bot to return a blank value when the value in the <b>Start from</b> index field is greater than the length of the source string.</p> <p><a href="#">Substring action on page 3099</a></p>

Fixes
<p>When you use the <b>String &gt; Extract text</b> action and select either <b>Before</b>, <b>Before and/or after</b>, or <b>After</b> options to extract the text, the event data now correctly shows the options that you select.</p> <p>Previously, when you used one of the specified options to extract the text, the event data of the bot showed only the <b>Before</b> option irrespective of the option that you had selected.</p>
<p>The bot no longer generates an incorrect output when you use the <b>String &gt; Replace</b> action to find and replace a string which contains a regular expression.</p> <p>Service Cloud Case ID: 01967997, 01969353, 01969353</p>

Related reference

[String package on page 3086](#)

Use the `String` package to perform various operations such as comparing two strings, retrieving the string length, or converting a string to uppercase or lowercase.

## System package updates

Review the updates in released versions of the System package such as new and enhanced features as well as fixes and limitations. The page also lists the release dates of each version, and the compatible Control Room and Bot Agent versions.

### Versions summary

The following table lists the versions of System package released either with an Automation 360 release or as a package-only release (in descending order of release dates). Click the version link for information about updates in that package version.

Version	Release date	Release type	Bot Agent version	Control Room build
<a href="#">3.14.0</a> on page 962	6 December 2023	With Automation 360 v.31 (Sandbox) release	21.88 or later	10217 or later
<a href="#">3.12.0</a> on page 962	6 June 2023	With Automation 360 v.29 (Sandbox) release	21.88 or later	10217 or later

### 3.14.0

- Compatible Bot Agent version: 21.88 or later
- Compatible Control Room version: 10217 or later

What's changed
<p>Intuitive icons at package level</p> <p>We have added intuitive icons at the package level. In the Action pane, when you navigate through the different packages, these icons are displayed at the package level and provide contextual information about packages.</p>

### 3.12.0

- Compatible Bot Agent version: 21.88 or later
- Compatible Control Room version: 10217 or later

**What's changed**

Help Center for developers

- Help Center: We have added an in-app help for developers to get contextual information about and when building automations.

[In-product user assistance](#) on page 1159

- Added intuitive icons for in a .

Related reference

[System package](#) on page 3105

Use the actions in the System package to automate locking, logging off, restarting, and shutting down the computer. Use these actions at the end of a task.

## Task Bot package updates

Review the updates in released versions of the Task Bot package such as new and enhanced features as well as fixes and limitations. The page also lists the release dates of each version, and the compatible Control Room and Bot Agent versions.

### Versions summary

The following table lists the versions of Task Bot package released either with an Automation 360 release or as a package-only release (in descending order of release dates). Click the version link for information about updates in that package version.

Version	Release date	Release type	Bot Agent version	Control Room build
<a href="#">2.8.0-20230530-152744</a> on page 963	15 September 2023	With Automation 360 v.30 (Sandbox) release	20.11 or later	8750 or later
<a href="#">2.7.2-20230316-166508</a> on page 964	16 June 2023	With Automation 360 v.29 (Sandbox) release	20.11 or later	8750 or later

### 2.8.0-20230530-152744

- Compatible Bot Agent version: 20.11 or later
- Compatible Control Room version: 8750 or later

**What's changed**

An additional attribute added to the **Run** action of the Task Bot package for internal use; however, there is no impact to existing bots on upgrade.

**2.7.2-20230316-160508**

- Compatible Bot Agent version: 20.11 or later
- Compatible Control Room version: 8750 or later

**What's changed**

Help Center for developers

- Help Center: We have added an in-app help for developers to get contextual information about and when building automations.

[In-product user assistance](#) on page 1159

- Added intuitive icons for in a .

Related reference

[Task Bot package](#) on page 3109

Use the **Run**, **Pause**, and **Stop** actions in the Task Bot package to manage running one or more child bots from a parent bot or with a third-party software using an API.

**Terminal Emulator package updates**

Review the updates in released versions of the Terminal Emulator package such as new and enhanced features as well as fixes and limitations. The page also lists the release dates of each version, and the compatible Control Room and Bot Agent versions.

**Versions summary**

The following table lists the versions of Terminal Emulator package released either with an Automation 360 release or as a package-only release (in descending order of release dates). Click the version link for information about updates in that package version.

Version	Release date	Release type	Bot Agent version	Control Room build
<a href="#">4.11.1</a> on page 965	6 December 2023	With Automation 360 v.31 (Sandbox) release	21.93 or later	10353 or later

Version	Release date	Release type	Bot Agent version	Control Room build
<a href="#">4.11.0</a> on page 965	21 September 2023	Package-only; post Automation 360 v.30 (Sandbox) release	21.93 or later	10353 or later
<a href="#">4.10.0</a> on page 966	6 June 2023	With Automation 360 v.29 (Sandbox) release	21.93 or later	10353 or later

#### 4.11.1

- Compatible Bot Agent version: 21.93 or later
- Compatible Control Room version: 10353 or later

Fix
Fixed the localization changes

#### 4.11.0

- Compatible Bot Agent version: 21.93 or later
- Compatible Control Room version: 10353 or later

What's new
<p>New capabilities added to the Terminal Emulator package (Service Cloud case ID: 01959254)</p> <p>The following features have been added to enhance the professional developer experience:</p> <ul style="list-style-type: none"> <li>• You can use the new <b>Set key mappings</b> action to overwrite the default mapping of keys. The set key mapping enables developers to map from the key lists, especially when keys behave differently on different terminals. For example, you can map <code>KEY_PAGEUP</code> to <code>{Page Up}</code>, <code>{Roll Down}</code>, or <code>\\x1b[5~</code> based on the terminal host you connected with.</li> <li>• When you select the <b>VT series</b> terminal type, you can select the <b>Custom DA string</b> check box and specify the string value so that the string is sent in response to a Device Attributes request.</li> <li>• You can select a new <b>Linux</b> terminal type to connect a Linux-based terminal. Using a Linux terminal, developers can execute commands and perform tasks faster.</li> </ul> <p><a href="#">Using Set key mappings</a> on page 3130   <a href="#">Using Connect action for Terminal Emulator</a> on page 3119</p>

## 4.10.0

- Compatible Bot Agent version: 21.93 or later
- Compatible Control Room version: 10353 or later

What's changed
<p>Help Center for developers</p> <p>Help Center: We have added an in-app help for developers to get contextual information about and when building automations.</p> <p><a href="#">In-product user assistance</a> on page 1159</p>

Fix
<p>Using <b>Terminal emulator</b> &gt; <b>Send text</b> action, you can create bots and perform operations on the <b>TN3270</b> terminal.</p> <p>Previously, in some scenarios the bot launcher failed at <code>ucrtbase.dll</code> when you used <b>Send text</b> or <b>Send key</b> actions from the Terminal Emulator package and performed some operations on the <b>TN3270</b> terminal.</p> <p>Service Cloud case ID: 01940731</p>

Related reference

[Terminal Emulator package](#) on page 3117

The **Terminal Emulator** package contains actions that enable you to connect to and automate tasks on another machine. Use these actions to access and control operations on a remote machine. For example, you can run applications and access files on a different operating system.

## Text file package updates

Review the updates in released versions of packages such as new and enhanced features as well as fixes and limitations. The page also lists the release dates of each version, and the compatible Control Room and Bot Agent versions.

### Versions summary

The following table lists the versions of Text file package released either with an Automation 360 release or as a package-only release (in descending order of release dates). Click the version link for information about updates in that package version.

Version	Release date	Release type	Bot Agent version	Control Room build
<a href="#">1.7.0</a> on page 967	6 December 2023	With Automation 360 v.31 (Sandbox) release	20.11 or later	8750 or later

Version	Release date	Release type	Bot Agent version	Control Room build
<a href="#">1.6.0</a> on page 967	6 June 2023	With Automation 360 v.29 (Sandbox) release	20.11 or later	8750 or later

## 1.7.0

- Compatible Bot Agent version: 20.11 or later
- Compatible Control Room version: 8750 or later

What's new
<p>Intuitive icons at package level</p> <p>We have added intuitive icons at the package level. In the Action pane, when you navigate through the different packages, these icons are displayed at the package level and provide contextual information about packages.</p>

## 1.6.0

- Compatible Bot Agent version: 20.11 or later
- Compatible Control Room version: 8750 or later

What's changed
<p>Help Center for developers</p> <ul style="list-style-type: none"> <li>• Help Center: We have added an in-app help for developers to get contextual information about and when building automations.</li> </ul> <p><a href="#">In-product user assistance</a> on page 1159</p> <ul style="list-style-type: none"> <li>• Added intuitive icons for in a .</li> </ul>

Related reference

[Text file package](#) on page 3134

Open a text file, read data from that file, and save the data to a string variable by using the **Text file** package. This package supports text files encoded in Shift-JIS, ANSI, UTF-16LE, UTF-16BE, Win 1521, Unicode, and UTF-8 and can extract content up to 64kb from text files.

## V11 Task Bot package updates

Review the updates in released versions of packagesuch as new and enhanced features as well as fixes and limitations. The page also lists the release dates of each version, and the compatible Control Room and Bot Agent versions.

### Versions summary

The following table lists the versions of V11 Task Bot package released either with an Automation 360 release or as a package-only release (in descending order of release dates). Click the version link for information about updates in that package version.

Version	Release date	Release type	Control Room build	Bot Agent version
<a href="#">1.14.0</a> on page 968	6 June 2023	With Automation 360 v.29 (Sandbox) release	20.11 or later	8750 or later

### 1.14.0

- Compatible Bot Agent version: 20.11 or later
- Compatible Control Room version: 8750 or later

What's changed
<p>Help Center for developers</p> <p>Help Center: We have added an in-app help for developers to get contextual information about and when building automations.</p> <p><a href="#">In-product user assistance</a> on page 1159</p>

Related reference

[V11 Task Bot package](#) on page 3149



The V11 Task Bot package enables you to run an Enterprise 11 bot from Automation 360 in the Enterprise 11 Control Room.

## VBScript package updates

Review the updates in released versions of the VBScript package such as new and enhanced features as well as fixes and limitations. The page also lists the release dates of each version, and the compatible Control Room and Bot Agent versions.

### Versions summary

The following table lists the versions of VBScript package released either with an Automation 360 release or as a package-only release (in descending order of release dates). Click the version link for information about updates in that package version.

Version	Release date	Release type	Bot Agent version	Control Room build
<a href="#">2.20.0 on page 969</a>	6 December 2023	With Automation 360 v.31 (Sandbox) release	21.210 or later	14100 or later
<a href="#">2.19.0 on page 969</a>	6 June 2023	With Automation 360 v.29 (Sandbox) release	21.210 or later	14100 or later

### 2.20.0

- Compatible Bot Agent version: 21.210 or later
- Compatible Control Room version: 14100 or later

What's changed
<p>Intuitive icons at package level</p> <p>We have added intuitive icons at the package level. In the Action pane, when you navigate through the different packages, these icons are displayed at the package level and provide contextual information about packages.</p>

### 2.19.0

- Compatible Bot Agent version: 21.210 or later
- Compatible Control Room version: 14100 or later

**What's changed**

Help Center for developers

Help Center: We have added an in-app help for developers to get contextual information about and when building automations.

[In-product user assistance](#) on page 1159

Related reference

[VBScript package](#) on page 3153

The VBScript package contains actions that enable VBScript functions in a task.

## Wait package updates

Review the updates in released versions of the Wait package such as new and enhanced features as well as fixes and limitations. The page also lists the release dates of each version, and the compatible Control Room and Bot Agent versions.

### Versions summary

The following table lists the versions of Wait package released either with an Automation 360 release or as a package-only release (in descending order of release dates). Click the version link for information about updates in that package version.

Version	Release date	Release type	Bot Agent version	Control Room build
<a href="#">4.10.1</a> on page 970	6 December 2023	With Automation 360 v.31 (Sandbox) release	20.11 or later	8750 or later
<a href="#">4.9.0</a> on page 971	6 June 2023	With Automation 360 v.29 (Sandbox) release	20.11 or later	8750 or later

#### 4.10.1

- Compatible Bot Agent version: 20.11 or later
- Compatible Control Room version: 8750 or later

**What's changed**

Intuitive icons at package level

We have added intuitive icons at the package level. In the Action pane, when you navigate through the different packages, these icons are displayed at the package level and provide contextual information about packages.

**4.9.0**

- Compatible Bot Agent version: 20.11 or later
- Compatible Control Room version: 8750 or later

**What's changed**

Introduced window time out in Wait for screen change action

When you use the **Wait > Wait for screen change** action in a bot and if the window that you selected is not responding, the bot now waits for a maximum of 30 seconds and times out with an error message: `Window not responding`. Previously, if the specific window was unresponsive, then the bot waited indefinitely for the window to respond.

Related reference

[Wait package](#) on page 3155

Use the actions in the `Wait` package to add a condition to wait for an application screen to change, or a separate window to open or close before proceeding to the next action.

**Window package updates**

Review the updates in released versions of packages such as new and enhanced features as well as fixes and limitations. The page also lists the release dates of each version, and the compatible Control Room and Bot Agent versions.

**Versions summary**

The following table lists the versions of Window package released either with an Automation 360 release or as a package-only release (in descending order of release dates). Click the version link for information about updates in that package version.

Version	Release date	Release type	Bot Agent version	Control Room build
<a href="#">5.11.0</a> on page 972	6 December 2023	With Automation 360 v.31 (Sandbox) release	20.11 or later	8750 or later

Version	Release date	Release type	Bot Agent version	Control Room build
<a href="#">5.10.0</a> on page 972	6 June 2023	With Automation 360 v.29 (Sandbox) release	20.11 or later	8750 or later

### 5.11.0

- Compatible Bot Agent version: 20.11 or later
- Compatible Control Room version: 8750 or later

Fix
<p>The <b>If &gt; Window with same title exists</b> condition now successfully identifies a window when the window title cases are changed, and the <b>Case sensitive</b> option is not selected.</p> <p>Service Cloud case ID: 01984178</p>

### 5.10.0

- Compatible Bot Agent version: 20.11 or later
- Compatible Control Room version: 8750 or later

What's changed
<p>Help Center for developers</p> <ul style="list-style-type: none"> <li>• Help Center: We have added an in-app help for developers to get contextual information about and when building automations.</li> <li>• <a href="#">In-product user assistance</a> on page 1159</li> <li>• Added intuitive icons for in a .</li> </ul>

Related reference

[Window package](#) on page 3174

Use the `Window` package to automate tasks relating to the window.

## Workday package updates

Review the updates in released versions of the Workday package such as new and enhanced features as well as fixes and limitations. The page also lists the release dates of each version, and the compatible Control Room and Bot Agent versions.

### Versions summary

Version	Release date	Release type	Bot Agent version	Control Room build
<a href="#">1.1.4</a> on page 973	6 June 2023	With Automation 360 v.29 (Sandbox) release	21.231 or later	17076 or later

#### 1.1.4

- Compatible Bot Agent version: 21.231 or later
- Compatible Control Room version: 17076 or later

What's new
<p>Help Center for developers</p> <ul style="list-style-type: none"> <li>• Help Center: We have added an in-app help for developers to get contextual information about <code>Window</code> and <code>Window</code> when building automations.</li> <li>• <a href="#">In-product user assistance</a> on page 1159</li> <li>• Added intuitive icons for <code>Window</code> in a <code>Window</code>.</li> </ul>

Related concepts

[Workday package](#) on page 3162

Workday is a leading provider of enterprise cloud applications that helps organizations manage various HR, finance, and business processes, including payroll, and more. The Automation 360

Workday package uses the Workday Web Services (set of SOAP APIs) to read and write data in and out of Workday.

## XML package updates

Review the updates in released versions of the XML package such as new and enhanced features as well as fixes and limitations. The page also lists the release dates of each version, and the compatible Control Room and Bot Agent versions.

### Versions summary

The following table lists the versions of XML package released either with an Automation 360 release or as a package-only release (in descending order of release dates). Click the version link for information about updates in that package version.

Version	Release date	Release type	Bot Agent version	Control Room build
<a href="#">3.12.0</a> on page 974	6 December 2023	With Automation 360 v.31 (Sandbox) release	20.11 or later	8750 or later
<a href="#">3.11.0</a> on page 974	6 September 2023	With Automation 360 v.30 (Sandbox) release	20.11 or later	8750 or later
<a href="#">3.10.0</a> on page 975	6 June 2023	With Automation 360 v.29 (Sandbox) release	20.11 or later	8750 or later

### 3.12.0

- Compatible Bot Agent version: 20.11 or later
- Compatible Control Room version: 8750 or later

What's new
Internal update in packages Minor update to support API tasks.

### 3.11.0

- Compatible Bot Agent version: 20.11 or later
- Compatible Control Room version: 8750 or later

**What's changed**

Help Center for developers

- Help Center: We have added an in-app help for developers to get contextual information about and when building automations.
- Added intuitive icons for in a .

**Fix**

When the input XML file contains comments before and after the root node and if the **Remove text nodes that contain only white space** ( **Start Session** action) and **Use Prettyprint** ( **Save session data** action) check boxes are selected, the output XML file formatting is displayed correctly on bot execution and a new line is added after the comment node.

**3.10.0**

- Compatible Bot Agent version: 20.11 or later
- Compatible Control Room version: 8750 or later

**What's changed**

Help Center for developers

Help Center: We have added an in-app help for developers to get contextual information about and when building automations.

[In-product user assistance](#) on page 1159

Related reference

[XML package](#) on page 3186

Extensible Markup Language (XML) is a markup language designed to store and transport data.

Use the actions in the XML package to automate the processing of XML data generated from web services and cloud computing applications.

## Previous Package SDK Release Notes

Review the new, changed, fixed, and deprecated features, and security fixes, known issues, and limitations for the previous Automation 360 (formerly Enterprise A2019) Package SDK.

### Automation 360 v.28

Feature	Description
Added security fix.	Added a security fix to the vulnerabilities reported in the previous release.

Feature	Description
Added allowed_agent_targets	<p>Added allowed_agent_targets attribute in @CommandPkg, which will mark the bot if it can be run as a service. Supported values are:</p> <ul style="list-style-type: none"> <li>- AllowedTarget.HEADLESS</li> <li>- AllowedTarget.WINDOWS</li> </ul>

SDK download link: [A360-package-sdk-2.7.0.zip](#)

Docs download link: [A360-package-sdk-2.7.0-javadoc.zip](#)

## Automation 360 v.27

Feature	Description
Added documentation_url and tutorial_url	<p>Added documentation_url and tutorial_url attributes in @CommandPkg.</p> <ol style="list-style-type: none"> <li><b>1.</b> documentation_url - Use this to add a documentation link to an action.</li> <li><b>2.</b> tutorial_url - Use this to add a video tutorial link to an action.</li> </ol> <p>For example:</p> <pre>@CommandPkg (     node_label =     "[[CMtoINCH.node_label]]",     label =     "[[CMtoINCH.label]]",     description =     "[[CMtoINCH.description]]",     name = "CMtoInch",     icon =     "ruler_icon.svg",     documentation_url =     "https://example.com/doc/     CMtoINCH.html",     tutorial_url =     "https://example.com/     tutorial/CMtoINCH.html",      minimum_controlroom_version     = "13980",      minimum_botagent_version =     "21.210")</pre>

[A360-package-sdk-2.6.1.zip](#)



## Automation 360 v.25

Feature	Description
Added default session_value	Added default_session_value attribute in @CommandPkg to set up the default value for global session.

[A360-package-sdk-2.5.0.zip](#)

## Automation 360 v.23

Feature	Description
Log4j version	Log4j version upgrade to 2.17.1.

[A360-package-sdk-2.4.1.zip](#)

## Automation 360 v.22

Feature	Description
Rebranded the package name	The package name is rebranded from A2019 to A360.
Added return settings	Added return settings for @CommandPkg to decide the setting or configurations related to the return type of the command.
Added a new annotation	Added a new annotation for SessionObject to indicate that the session object is passed to the command.
Added a new annotation	Added a new annotation for SessionAllowNonExistent to indicate that a non-existing session can be passed to the command.
Added a new attribute type	Added a new attribute type BAPIOBJECT that works with the control type named BAPIWORKFLOW with the following three tables. <ul style="list-style-type: none"> <li>• Import</li> <li>• Export</li> <li>• Table</li> </ul>
Added multiple return settings	Added multiple return settings in @CommandPkg to return multiple values from the command.

Feature	Description
Runtime library updates	Bundled the latest bot runtime libraries.

[A360-package-sdk-2.3.0.zip](#)

## Automation 360 v.21

Feature	Description
Added a new annotation	Added the new annotation for the Control Room and the Bot Agent.
Added a new annotation	Added the new annotation for the credential password (@CredentialAllowPassword).
Added a new example	Added the new example at: <code>botcommand/samples/commands/basic/types</code> , called <b>CredentialTypeDemo.java</b> file.
Added a new annotation	Added the new annotation to support the Trigger3 interface.
Updated trigger examples	Updated trigger examples to support the Trigger3 interface.
Runtime library updates	Bundled latest bot runtime libraries.

[A2019-package-sdk-2.1.0](#)

## Enhancements A2019.20

Feature	Description
Runtime library updates	Bundled latest bot runtime libraries.

[A2019-package-sdk-2.0.9](#)

## Enterprise A2019.19

Feature	Description
Runtime library updates	Bundled latest bot runtime libraries.
Added annotation rule	Added the <code>MultipleRecordPicker</code> annotation rule.
Added annotations	Added annotations for desktop operation stages.

[A2019-package-sdk-2.0.8](#)**Enterprise A2019.18**

Feature	Description
Runtime library updates	Bundled latest bot runtime libraries.
Added shared session	Added support for shared sessions.
Enhanced property creation	Now properties can accept one parameter.
Added rule for WindowResize and WindowBrowser	Added a new rule for WindowResize and WindowBrowser.
Non-essential dependencies in the <code>build.gradle</code> are commented out	Non-essential dependencies in the <code>build.gradle</code> are now commented out. Enable it to compile the Package SDK samples.

[A2019-package-sdk-2.0.7](#)**Enterprise A2019.17**

Feature	Description
Runtime library updates	Bundled latest bot runtime libraries.
Added author name in custom packages	Added support to add the author name in the vendor column of custom packages.
Added File2 attribute	Added the new attribute type File2.
Added File Type rule	Added the new rule File Type.

[A2019-package-sdk-2.0.6](#)**Enterprise A2019.16**

Feature	Description
Runtime library updates	Bundled latest bot runtime libraries.
Added NoLogging	Added NoLogging support.

[A2019-package-sdk-2.0.5](#)

## Enterprise A2019.15

Feature	Description
Runtime library updates	Bundled latest bot runtime libraries.

[A2019-package-sdk-2.0.4](#)

## Enterprise A2019.14

Feature	Description
Desktop operations	Added desktop operations support.
Samples for actions in the download file	Added additional samples for actions in the Package SDK download file.
Runtime library updates	Bundled latest bot run-time libraries.

[A2019-package-sdk-2.0.3](#)

## Enterprise A2019.13

Feature	Description
Time validation for locales	Added compile time validation for locales JSON file.
Entry list	Added support for ENTRYLIST
Runtime library updates	Bundled latest bot runtime libraries.

[A2019-package-sdk-2.0.2](#)

## Enhancements A2019.12.1

Feature	Description
Trigger samples	Added trigger samples in the Package SDK download file. Download the latest Package SDK to access the sample files.

[A2019-package-sdk-2.0.1.zip](#)

## Enterprise A2019.12

Feature	Description
Runtime libraries	Added the latest runtime libraries.
Custom trigger	Creating custom triggers is supported in this release.
Sample	We added more code samples.
HierarchyDemo.java code example added to package documentation. (Service Cloud case ID: 00469066)	Create a simple action with multiple choices. The UI differs based on the options selected.

[A2019-package-sdk-2.0.0.zip](#)

## Enhancements A2019.11

Feature	Description
Runtime libraries	This package contains the latest runtime libraries.

[A2019-package-sdk-1.0.11.zip](#)

## Enterprise A2019.10

Feature	Description
Updated annotation support	Added new attributes annotation support.
Improved bundling of SDK	Bundled java doc inside package SDK zip. You only need to download one zip file now.
Runtime libraries	Bundled latest bot runtime libraries.
More examples	Added new examples inside zip.
Datatypes	Added new datatypes.

[A2019.10-package-sdk-1.0.0.zip](#)

---

**Note:** All the components for the Package SDK are included in a single zip file starting with the A2019.10 release.

---

## Enterprise A2019.09

Feature	Description
Bot runtime libraries	Bundled latest bot runtime libraries for A2019.09 Package SDK.

- SDK Demo Package: [A2019.09-packageSDK-1.0.0.zip](#)
- Documentation: [A2019.09-package-annotations-javadoc.zip](#)

## Enterprise A2019.08

Feature	Description
Bot runtime libraries	Bundled latest bot runtime libraries for A2019.08 Package SDK.
Properties support	Extended support for properties.
Comments expanded and improved	Added more comments to sample commands to help use SDK.
Comment field formatting	Added text color and background color to comment fields.

- SDK Demo Package: [A2019.08-packageSDK-1.0.0.zip](#)
- Documentation: [A2019.08-package-annotqations-javadoc.zip](#)

## A2019.07

Feature	Description
Bot runtime libraries	The A2019.07 bot runtime libraries are bundled in the SDK package.
<b>CREDENTIAL</b> attribute	We provide support for credential attributes that require input from action screens.
Localized error messages and actions UI text	Enables developing packages with i18n error messages and localized (l10n) actions UI with localized text.
Java Development Kit 11	The A2019.07 Package Development Kit supports JDK 11.

- SDK Demo Package: [A2019.07-Package-Sdk-1.0.0.zip](#)
- Documentation: [A2019.07-package-annotations-javadoc.zip](#)

## Process Discovery Release Notes

Review the new features and improvements in each release.

Use the links to view the release notes updates for each release.

For information related to features and fixes in previous Process Discovery releases, see the PDFs for these releases: [Process Discovery documentation \(release versions\)](#).

### Process Discovery version 1.79.0 release notes

Review the new features, enhancement, and fixes available in this release.

Release Date: 14-December-2023

For information related to features and fixes in previous Process Discovery releases, see the PDFs for these releases: [Process Discovery documentation \(release versions\)](#).

#### What's changed

Enhanced account properties

In Process Discovery currently, an account is specified by an email address, which can only be linked to a specific tenant in a region.

With this release, we are enabling user accounts to have log-in with a username instead of an email address. Usernames will still require to be unique within a tenant and region, but the same email address can now be re-used across tenants. From this release onward, all new user accounts will be created with a username and password. For existing users, the email address has been set as the username.

Here's is a list of impacted Process Discovery log-in scenarios:

- Current user log-in: For any account created prior to this release, the account's email address is now mapped to the new **Username** field for that account. From this release, all current users would use their email address for the **Username** field to log-in.
- New user log-in: When new users log-in, they would see the **Username** and **Password** fields to enter their log-in credentials, instead of the **Email** and **Password** fields.
- Create new user: When creating a new user, users will now be asked to create a **Username** and **Password**. While the username must be unique for a tenant and region, the email address field provided when creating a user does not have to be unique across a tenant or region.
- Edit user : When editing an existing user account, users can update their email address, first, and last name fields.
- User log-in validation: While logging in to a tenant, if the log-in credentials are incorrect, the user would see a message saying that either the username or password is incorrect.
- Forgot password: If a user forgets their log-in password, they would get a log-in reset screen with a **Username** field, instead of an **Email** field; and an updated message saying 'If your Username is valid, a password reset link will be sent to your associated email address'.

---

**Note:** These enhancements will not impact the existing users.

---

## Fixes

An Admin user gets created in Kibana when converting from a non-admin role

You can now successfully convert non-admin accounts to admin accounts in Kibana and the system will update the role and create a new admin account for that user. Earlier, converting a non-admin account to an admin account was not updating the user role, hence an admin account was not getting created.

Number of processes and paths in the **Create a Mining Run > Advanced** tab is now limited

When defining the process and path parameters for creating a new mining run, you can now limit the **NUMBER OF PROCESSES** to 50, and the **NUMBER OF PATHS** to 100. Earlier you could define up to 999 processes and paths.

## Privacy Enhanced Gateway version 3.3.16 Release Notes

Review the new features and fixes available in this release.

Release Date: 5-Sep-2023

For information related to features and fixes in previous Privacy Enhanced Gateway releases, see the PDFs for these releases: [Process Discovery documentation \(release versions\)](#).

**Important:** We recommend using Process Discovery version 3.3.16 and above to ensure higher data reliability of events synched across Privacy Enhanced Gateway (PEG) and the Process Discovery Platform.

## What's new

View status of all the events

Review the status of all the events such as completed, pending or failed. In addition, you can also track specific reason for failure of each event when being transmitted to the Process Discovery platform from PEG.

[Manage PEG events](#) on page 3876

Regex to filter redaction results

Use the real-time redaction review to assess and setup redaction configurations based on regular expressions.

[Review redaction results](#) on page 3870

Export PEG metrics

As part of managing the redaction configurations, click the **Export PEG Metrics** button to export and download PEG metrics.

[Manage redaction list configurations](#) on page 3868



## Fix

Fix
OCR is now enhanced for mainframe applications to address poor detection results. The updated Deduction model that is available with this release is better at detection results, specifically in the Mainframe applications.

## Discovery Bot release notes

Review what's new and changed, and the fixes and limitations in the Discovery Bot release.

Limitations from previous releases (Discovery Bot v.26, v.27, v.28, v.29)
Depending on the memory available in your system, the PDD (in PDF or Microsoft Word format) can support up to 250 recorded steps captured in the document. If a process is recorded with more than 250 steps, the PDD generation periodically stops functioning. Workaround: Regenerate the PDD and click <b>Download</b> .

## CoE Manager Release Notes

Review the CoE Manager feature available in Automation 360 v.26 release.

### Introduction

Use CoE Manager - powered by Shibumi to scale your automation programs more quickly and efficiently. CoE Manager provides visibility into your end-to-end automation lifecycle and accelerates pipeline generation. It provides a consistent way of assessing automation opportunities which helps in minimizing the variations and maximizing the ROI.

CoE Manager is available out of the box and requires minimal configuration for first-time use.

### Automation Anywhere Enterprise compatibility

Automation 360: The Control Room can be a Cloud or On-Premises deployment.

[CoE Manager](#) on page 2047.

## Browser extensions for Automation 360

Create automation from supported browsers by using browser extensions. Extensions are periodically updated to support feature enhancements and fixes. Therefore, ensure that you have

the latest versions of extensions for the Google Chrome, Microsoft Edge, and Mozilla Firefox browsers.

Before you download the latest version of a browser extension, review the information in the following tables:

### Browser extension for Manifest V3

Extension name	Extensior Fixes version		Link to extension
Google Chrome	3.1.0.0	<ul style="list-style-type: none"> <li>You can run the JavaScript command and execute the JavaScript code without any issues.</li> </ul>	<a href="#">Google Chrome extension for Automation 360</a>
Microsoft Edge based on Chromium	3.1.0.0	<ul style="list-style-type: none"> <li>The bot runs the actions on the captured objects of the SAP Fiori application successfully while using the Recorder package (version 2.10.2-20230104-214915). Previously, the bot encountered an error as it was unable to find the button when the search criteria did not match.</li> </ul>	<a href="#">Microsoft Edge extension for Automation 360</a>

**Note:** Browser extension is used in the **Capture** action of the Recorder package. The information captured through the browser extension is stored within the bot and this information is not shared externally. Additionally, this stored information is only used on the machine where the bot was created or deployed.

### Browser extensions for Manifest V2

Impact to our customers: Automations that use Google Chrome Manifest V2 based extensions will stop working sometime after June 2023. The deprecation timelines of Manifest V2 based extensions are currently under review and subject to change by Google.

- For Google Chrome Manifest V2 extensions timelines, see [Manifest V2 support timeline](#).
- For Microsoft Edge Manifest V2 extensions timelines, see [Overview and timelines for migrating to Manifest V3](#).

Extension name	Extension version	Link to extension
Google Chrome	1.7.0.0	<a href="#">Automation 360 extension for Chrome</a>
Microsoft Edge based on Chromium	1.7.0.0	<a href="#">Automation 360 extension for Microsoft Edge</a>
Mozilla Firefox	1.7.0.0	<a href="#">Automation 360 extension for Mozilla Firefox</a>

Related concepts

[Automation 360 Release Notes](#) on page 17

Review the new capabilities, changes, fixes (resolved issues), security fixes, deprecated features, and limitations in each release.

Related reference

[Browser requirements for Automation Workspace](#) on page 1210

Access the Automation Workspace interface from a browser. After you have installed and enabled extensions in the browser, perform several tasks through the Automation Workspace interface based on your user role and automation requirements.

[Bot Agent compatibility](#) on page 1332

Before you install the Bot Agent, ensure that you review the compatible Automation 360 builds.

## Browser extensions for web applications

You can create automations using the Google Chrome and Microsoft Edge browser extensions for web applications running on Google Chrome and Microsoft Edge, which enables you to automate with enhanced security and performance.

### Features using browser extensions for web applications

The following Automation 360 features use the browser extensions for web applications running on Google Chrome or Microsoft Edge browsers:

- Automation of web applications through Universal Recorder or Browser package
- User interface-based triggers
- Bot Agent device registration with the Control Room
- Packages that use window titles, for example, OCR and **Mouse > Click**.

### Use browser extensions to automate web applications

To automate web applications, the browser extensions capture the properties of the targeted UI elements, application window title, and URL that enables you to create or update the actions that are specific to the Recorder in the bots. Newly created or updated bots are then uploaded from the browser of the Bot Creator to the Control Room. All bots are stored in the Control Room along with the properties of the UI element. When a bot is running, browser extensions are used to automate actions on the targeted UI elements of the web-based business applications.

When a Bot Creator or a Bot Runner user connects to the Control Room for the first time over Google Chrome or Microsoft Edge browsers, the browser extensions enable you to register your device by automatically sharing the device name and windows username, with the Control Room.

---

**Note:** Firefox browser extension supports object-based automation of web applications running in Firefox browser. Registering your device over Firefox browser is not yet supported.

---

## Previous versions of browser extensions

Review the version history of browser extensions from past releases.

### Version 3.0.9.0

Extension name	Fixes
Google Chrome	<ul style="list-style-type: none"> <li>You can perform web automation actions without any issues due to the following changes:               <ul style="list-style-type: none"> <li>The logic to use <code>DOMXPath</code> sent in as a request to retrieve an element was removed. Functionality to add the Automation Anywhere dynamic attribute and retrieve the element using the ID of the dynamic attribute instead was added. Previously, if you used the custom <code>DOMXPath</code> with a double quotation mark while executing the click action on inline JavaScript controls, then Automation Anywhere had to enable the Debugger and inject the JavaScript to execute that action.</li> <li>The logic to search on <code>hasFrame</code> and <code>frameSrc</code> was removed. As a result, the search for Frame information occurs within frame information object in the searched HTML element.</li> <li>The mechanism to wait for (Content Security Policy (CSP) flag to be set to <b>True</b> or <b>False</b> is now included before Automation Anywhere attempts to inject detect framework scripts with the Debugger in pages such as Salesforce(which have a CSP policy).</li> <li>The <code>invisible</code> property in the search algorithm has been added as search criteria.</li> </ul> </li> </ul>
Microsoft Edge based on Chromium	

### Version 3.0.8.0

Extension name	Fixes
Google Chrome	During web automation, the web page maintains its position when the target object is already visible on the page. This improves the automation reliability when there is a fixed pane on the web page and physical actions (such as mouse click) do not work as expected.
Microsoft Edge based on Chromium	

## Version 3.0.7.0

Extension name	Fixes
Google Chrome	<ul style="list-style-type: none"><li>• Timeout issues no longer occur on websites that previously had high loading time because now the JavaScript with debugger is performed successfully on any page that has a CSP policy.</li><li>• Fix provided for <code>document.evaluate</code> if the <code>document.querySelector</code> is blocked. Previously, user interaction functions on some websites were not available because the <code>document.querySelector</code> was blocked.</li></ul>
Microsoft Edge based on Chromium	<ul style="list-style-type: none"><li>• Timeout issues no longer occur on websites that previously had high loading time because now the JavaScript with debugger is performed successfully on any page that has a CSP policy.</li><li>• Fix provided for <code>document.evaluate</code> if the <code>document.querySelector</code> is blocked. Previously, user interaction functions on some websites were not available because the <code>document.querySelector</code> was blocked.</li></ul>

## Version 3.0.6.0

Extension name	Fixes
Google Chrome	<ul style="list-style-type: none"><li>• Enhancement to add case sensitivity option for static window titles in Google Chrome and Microsoft Edge</li><li>• Fixes to capture objects and perform selected actions in a migrated bot using Recorder in Google Chrome and Microsoft Edge</li><li>• Fixes to run JavaScript after executing Recorder actions in a bot in Google Chrome and Microsoft Edge</li><li>• Fixes to capture pop-up windows with Automation 360 plug-in enabled in Google Chrome and Microsoft Edge.</li></ul>

Extension name	Fixes
Microsoft Edge based on Chromium	<ul style="list-style-type: none"> <li>In the Recorder package, you can now use the <b>Click</b> or <b>Left click</b> action on the JavaScript alert, prompt, and confirmation pop-up windows to automate web pages on Microsoft Edge browser.</li> <li>In the package, you can now use the <b>Click</b> for the Link and Form tag controls that have inline scripting with using Manifest V3 extensions.</li> </ul>

### Version 3.0.5.0

Extension name	Fixes
Google Chrome	<ul style="list-style-type: none"> <li>Fixes to run JavaScript inside an iFrame in Google Chrome</li> <li>Enhancement to exclude page load for default pages in Google Chrome and Microsoft Edge</li> </ul>
Microsoft Edge based on Chromium	

## Automation 360 feature comparison matrix

Compare Automation 360 features with Enterprise 11.3.x and Enterprise 10 features to understand the benefits to Automation 360. Review advantages of Automation 360 if you are a new user of the product.

For details on latest features and enhancements, see Automation 360 release notes.

### Core components

	Automation 360	Enterprise 11.3.x	Enterprise 10.x
Target user	Citizen Developer Specialist/RPA Developer IT	RPA Developer IT	RPA Developer IT
Delivery model	On-Premises Cloud Cloud-enabled	On-Premises	On-Premises BotFarm (for Bot Runners)

	Automation 360	Enterprise 11.3.x	Enterprise 10.x
Operating system	Microsoft Windows Linux (Linux CentOS 7.7, 7.9, and 8.3) and (Red Hat Enterprise Linux 7.7, 7.9, and 8.3)  (Operating system not applicable for Cloud)	Microsoft Windows	Microsoft Windows
Microsoft Active Directory support	Available	Available	Available
SAML 2.0	Available	Available	Not available
Authenticated proxy support	Available	Not available	Not available
Localized user interface (UI)	8 languages	3 languages	Not available
Bot Insight support	Available	Available	Available (Basic)
IQ Bot support	Available	Available	Available (Basic)
Interactive forms (attended automation) support	Available	Not available	Not available
Bot Creator platform	On premises thin client	Thick client	Thick client
Bot Runner platform	Web-deployed	Thick client	Thick client
Attended bots	Available	Available	Not available
Unattended bots	Available	Available	Available
Upgrade to use new actions or commands	No upgrade required for Cloud Upgrade required for On-Premises and Cloud-enabled	Upgrade required	Upgrade required
Automated queuing for job	Available	Available	Not available
Centralized licensing	Available	Available	Available
High availability	Available	Available	Available
Load balancing	Available	Available	Available
Disaster recovery	Available	Available	Available

	Automation 360	Enterprise 11.3.x	Enterprise 10.x
Multi-domain support	Available	Available	Available
Hosting technology	Java	<ul style="list-style-type: none"> <li>Java (Control Room)</li> <li>Microsoft .NET Framework (Enterprise Client)</li> </ul>	Microsoft IIS
Role-based access	Available	Available	Available
Power BI	Available	Not available	Not available
Tableau connector for Bot Insight	Available	Not available	Not available
Version Control	Available through Git integration (Subversion is deprecated)	Available through Subversion integration	Available through Subversion integration
SysLog integration	Available	Available	Not available

### Control Room server capabilities

Feature	Automation 360	Enterprise 11.3.x	Enterprise 10.x
Version control - Set production version	Available	Available	Available
Version control - Compare two versions of a bot	Available	Available	Available
Version control - Check version history	Available	Available	Available
Version control - Roll back to previous version	Available	Available	Available
Version Control – Restore from git	Available	Not available	Not available
Multi or two factor authentication	Available (through SSO)	Available (Native and through SSO)	Not available
Banner text on Control Room login	Available	Available	Not available
Install Control Room on Oracle Database	Available	Available	Not available
Audit log	Available	Available	Available



Feature	Automation 360	Enterprise 11.3.x	Enterprise 10.x
Open web page in a new or existing tab of Internet Explorer	Available	Available	Available
Open web page in a new or existing tab of Google Chrome	Available	Not available	Not available
Setting for new login session in Control Room	Deprecated	Available	Not available
Configure API keys duration	Available	Not available	Not available
Configure email verification on user creation	Available	Available	Not available
Enable debug logging	Available	Available	Not available
Move bot	Available	Not available	Not available
Copy bot	Available	Available	Available
View references and dependencies	Available	Not available	Not available
Bulk check-in	Available	Available	Available
Bulk check-out	Available	Available	Available
Bot Promotion (without export/import)	Available	Not available	Not available
Recover private workspace	Available	Not available	Not available
Search within sub-folders	Available	Not available	Not available

## Bot development

Feature	Automation 360	Enterprise 11.3.x	Enterprise 10.x
In-product learning	Available	Not available	Not available
Bot Creator Flow view	Available	Not available	Not available
Bot Creator Dual view	Available	Not available	Not available

Feature	Automation 360	Enterprise 11.3.x	Enterprise 10.x
Bot Creator Code view	Available	Available	Available
Bot Creator Visualize view	Not available	Available	Available
Bulk package update	Available	Note available	Not available
Actions search	Available	Not available	Not available
Text search	Available	Available	Available
Advanced expressions	Available	Limited availability	Limited availability
Regular expressions	Available	Available	Available
Remote device testing	Available (Develop on one device and test on another device)	Not available	Not available
Localized actions	Available	Not available	Not available
Collaborative development	Available	Not available	Not available
Bot Store integration	Available	Available (Version 11.3.3 and later)	Not available
Email triggers	Available	Available	Available
File and folder triggers	Available	Available	Available
Hot-key triggers	Available	Available	Available
User Interface triggers	Available	Not available	Not available
Performance triggers	Not available	Available	Available
Process triggers	Available	Available	Available
Service triggers	Available	Available	Available
Windows triggers	Available	Available	Available
MetaBot Logic	Available through Task Bot	Available	Available
MetaBot DLL	Available through DLL: Run function action	Available	Available
MetaBot Screen recalibration	Not available	Available	Available

Feature	Automation 360	Enterprise 11.3.x	Enterprise 10.x
Bot Lifecycle Management - Import and export bots	Available	Available	Not available
Global values	Available	Not available	Not available
Bot cloning	Available	Not available	Not available
API deployment	Available	Available	Not available
Bot Runner sessions in Control Room	Available	Available	Available
Packaging Bot dependencies	Available	Available	Available
Bypass legal disclaimer	Available	Available	Available
Edit variable name	Available	Available	Available
Copy commands from one bot to another	Available Triggers option is not available.	Available	Available
Save bot as XML/TXT	Not available	Available	Available
Disable mouse and keyboard for the bot	Not available	Available	Available
Run bot in stealth mode	Not available	Available	Available
Show or hide errors while running a bot.	Not available (Deprecated for Automation 360)	Available	Available
Copy variables from one bot to another	Available	Available	Available
Cross domain iFrame support in browsers.	Available Supported in Google Chrome and Microsoft Edge.	Available Supported in Internet Explorer.	Available Supported in Internet Explorer.
Define and Enforce Coding Best Practices with Code Analysis	Available		

## Bot extensibility and code reuse

Feature	Automation 360	Enterprise 11.3.x	Enterprise 10.x
Custom actions in palette	Available (build using Package Development Kit)	Not available	Not available
Inline scripting	Available in Python, VBScript, and JavaScript	Available in VBScript	Not available
Code reuse	Available for Task Bots, custom actions, and DLLs	Limited availability for MetaBots and DLLs	Limited availability for MetaBots and DLLs
Quick map for variables	Available	Available	Available
Bot timeout	Available	Available	Available
Bot priority	Available	Available	Available
Share DLL session	Available	Not available	Not available
Run bot reusing the configuration of the past run from <b>Historical</b> page	Available	Not available	Not available

## Integration capabilities

Feature	Automation 360	Enterprise 11.3.x	Enterprise 10.x
Callouts using inline scripting	Available for Python, VBScript, and JavaScript	Not available	Not available
Control Room APIs	Available	Available	Not available
REST Web Service	Available	Available	Available
SOAP Web Service	Available	Available	Available

## Device utilization capabilities

Feature	Automation 360	Enterprise 11.3.x	Enterprise 10.x
Workload management	Available	Available	Not available

Feature	Automation 360	Enterprise 11.3.x	Enterprise 10.x
Device pools	Available for scheduling and workload management	Available in workload management only	Not available
Run-as users pool for automations	Available Set up multiple run-as users for device pools to provide effective license and device utilization	Not available	Not available
Background processing	Available	Not available	Not available
Non-persistent virtual desktop infrastructure (VDI)	Available	Available	Available

### Recorder capabilities

Feature	Automation 360	Enterprise 11.3.x	Enterprise 10.x
AI Sense Recorder	Available	Available	Not available
Unified Recorder	Available (includes support for Microsoft Edge Chromium) <ul style="list-style-type: none"> <li>Pattern-based data extraction is not available</li> <li>Legacy Microsoft Edge and Flash/Flex are deprecated</li> </ul>	Not available (Recording capabilities through Web Recorder, Smart Recorder, and Standard or Screen Recorder)	Not available (Recording capabilities through Web Recorder, Smart Recorder, and Standard or Screen Recorder)
Recorder for Web/Windows	Available	Available	Available
Recorder for SAP	Available	Available	Not available
Recorder for Citrix	Available	Available	Not available
Recorder for Oracle	Available	Available	Not available
Secure recording	Available	Available	Available
Microsoft Silverlight 5 desktop and web applications	Available (Third-party controls are not available)	Available	Available

Feature	Automation 360	Enterprise 11.3.x	Enterprise 10.x
Selection of capture technology in recorder	Available	Available	Available

## Bot packages

**Note:** To enhance automation capabilities, Automation 360 includes additional packages, all of which are not listed in this table. For a detailed list of packages in Automation 360, see [Packages available in Automation 360](#) on page 2316.

Feature	Automation 360 packages	Enterprise 11.3.x commands	Enterprise 10.x commands
Automation Co-Pilot on the web	Available	Not available	Not available
Active Directory	Available	Available	Available
Analyze	Available	Not available	Not available
Application	Available	Available	Available
App Integration	Available	Available	Available
Boolean	Available	Not available	Not available
Bot migration	Available	Not available	Not available
Browser	Available The following actions are only available for the Google Chrome browser: <ul style="list-style-type: none"> <li>Close</li> <li>Get source code</li> <li>Go back</li> <li>Run JavaScript</li> </ul>	Available (through Web Recorder) The Web Recorder commands are only available for the Internet Explorer browser.	Available (through Web Recorder) The Web Recorder commands are only available for the Internet Explorer browser.
Citrix Automation	Not available (Deprecated and replaced with Unified Recorder)	Available	Available
Clipboard	Available	Available	Available
Comment	Available	Available	Available
Credential Vault	Available	Available	Available
CSV/TXT	Available	Available	Available

Feature	Automation 360 packages	Enterprise 11.3.x commands	Enterprise 10.x commands
Data Table	Available	Available using Array type variable	Available using Array type variable
Database	Available	Available	Available
Datetime	Available	Not available	Not available
Delay	Available	Available	Available
Dictionary	Available	Not available	Not available
DLL	Available	Limited availability through MetaBots	Limited availability through MetaBots
Email	Available (SMTP, EWS, and Outlook)  Additional actions available: <ul style="list-style-type: none"> <li>• Change status</li> <li>• Check if folder exists</li> <li>• Forward</li> <li>• Move all</li> <li>• Move</li> <li>• Save email</li> <li>• Reply all</li> <li>• Reply</li> </ul>	Available (SMTP, EWS).  The following options are available: <ul style="list-style-type: none"> <li>• Send email with template</li> <li>• Insert images in an email</li> </ul>	Available (SMTP)
Error handler	Available (Advanced - Try, Catch, Finally, Throw)	Available (Basic)	Available (Basic)
Excel advanced	Available	Limited availability	Limited availability
Excel basic (without Excel)	Available	Not available	Not available
File operations	Available	Available	Available
Folder operations	Available	Available	Available
FTP / SFTP	Available	Available	Available
Google Document AI	Available	Not available	Not available
If	Available	Available	Available
Image Recognition	Available	Available	Available
Interactive form operations	Available	Not available	Not available
IQ Bot	Available	Available	Available
IQ Bot Pre-processor	Available	Not available	Not available

Feature	Automation 360 packages	Enterprise 11.3.x commands	Enterprise 10.x commands
IQ Bot (Local Device)	Deprecated	Not available	Not available
JavaScript	Available	Available through Run Script	Available through Run Script
Legacy Automation (for migrated bots)	Available (for migration)	Not available	Not applicable
List operations	Available	Not available	Not available
Log To File	Available	Available	Available
Loop	Available	Available	Available
Message Box	Available	Available	Available
MetaBot screens	Not available (Replaced with Universal Recorder)	Available	Available
Mouse	Available	Available	Available
Number	Available	Not available	Not available
OCR	Available	Available	Available
Microsoft 365 Calendar	Available	Not available	Not available
Microsoft 365 Excel	Available	Available (Desktop)	Not available
Microsoft 365 OneDrive	Available	Not available	Not available
Microsoft 365 Outlook	Available	Not available	Not available
One Drive	Available	Not available	Not available
PDF	Available	Available	Available
PGP	Available	Available	Available
Play Sound	Available	Available	Available
Printer	Available	Available	Available
Prompt	Available	Available	Available
Python Script (Inline)	Available	Not available	Not available
Record	Available	Not available	Not available
Recorder	Available	Available	Available
REST Web Service	Available	Available	Available
SAP support	Available (Native)	Limited availability through MetaBots	Limited availability through MetaBots



Feature	Automation 360 packages	Enterprise 11.3.x commands	Enterprise 10.x commands
SAP BAPI	Available Custom developed SAP BAPI is not supported.	Available	Available
Screen	Available	Available	Available
Services	Available	Available	Available
Simulate keystrokes	Available	Available	Available
SNMP	Available	Available	Available
SOAP Web Service	Available	Available	Available
Step	Available	Not available	Not available
String	Available	Available	Available
System	Available	Available	Available
Task Bot	Available	Available	Available
Terminal Emulator	Available	Available	Available
Text file	Available	Not available	Not available
Trigger Loop	Available	Not available	Not available
VBScript (Inline)	Available	Available as Run Script	Not available
Wait	Available	Available	Available
Window	Available	Available	Available
Workload	Available	Available	Not available
XML	Available	Available	Available

## Variables support

**Important:** When you migrate from Enterprise versions 11.3.x or Enterprise 10 to Automation 360, some variables are mapped directly while some contain a different configuration.

Variable	Automation 360	Enterprise 11.3.x	Enterprise 10.x
Application variables			
Analytics	Available	Available	Not available
ArrayRows	Available through Recursive expressions	Available	Available

Variable	Automation 360	Enterprise 11.3.x	Enterprise 10.x
ArrayColumns	Available through Recursive expressions	Available	Available
Clipboard	Available	Available	Available
Credential	Available	Available	Not available
Dictionary	Available through Dictionary package	Available	Not available
Enter (String variable)	Available	Available	Available
Prompt Assignment (user-defined)	Available	Available	Available
Read from Excel/CSV	Available through Excel advanced package	Available through Array type user-defined variable	Available through Array type user-defined variable
Read from database	Available through Database package	Available through Array type user-defined variable	Available through Array type user-defined variable
Read from text file	Available through CSV/TXT package	Available through Array, List, and Value type user-defined variables	Available through Array, List, and Value type user-defined variables
Separator (String variable)	Available	Available	Available
Tab (String variable)	Available	Available	Available
Work Item	Available	Available	Not available
System variables			
AAApplicationPath	Available through global values	Available	Available
AADefaultDateFormat	Available through global values	Not available	Not available
AAInstallationPath	Available	Available	Available
AATaskExecutor	Available	Available	Not available
AATaskName	Available	Available	Not available
AAControlRoom	Available	Available	Not available
Counter	Available through Number and Loop packages	Available	Available
CPUUsage	Available	Available	Available

Variable	Automation 360	Enterprise 11.3.x	Enterprise 10.x
CurrentDirectory	Available through Loop package	Available	Available
DatasetColumn	Available through Loop package	Available	Available
Date	Available	Available	Available
Day	Available	Available	Available
<i>Email</i> (includes EmailFrom, EmailMessages, EmailReceivedDate, EmailReceivedTime, EmailSubject, EmailTo, EmailSentDate, and EmailSentTime)	Available through Email, Dictionary, and Loop packages	Available	Available
ErrorLineNumber	Available through Error handler package	Available	Available
ErrorDescription	Available through Error handler package	Available	Available
Excel (includes ExcelColumn, ExcelCell, ExcelCellColumn, and ExcelCellRow)	Available through Excel advanced package	Available	Available
Extension	Available through GetProperty action of PDF package	Available	Available
FileDataColumn	Available as record type variable through Loop package	Available	Available
FileName	Available through File package	Available	Available
FolderName	Available through Folder package	Available	Available
Hour	Available	Available	Available
Machine	Available	Available	Available
Millisecond	Available	Not available	Not available
Minute	Available	Available	Available
Month	Available	Available	Available
OSName	Available	Available	Available

Variable	Automation 360	Enterprise 11.3.x	Enterprise 10.x
PDF (includes PDFFileName, PDFTitle, PDFAuthor, and PDFSubject)	Available through GetProperty action of PDF package	Available	Available
RAMUsage	Available	Available	Available
Second	Available	Available	Available
TableColumn	Not available	Available	Available
TotalRAM	Available	Available	Available
Trigger	Available through Interface trigger	Available	Available
Year	Available	Available	Available
XMLDataNode	Available as string type variable through Loop package	Available	Available

#### Related concepts

[Automation 360 Release Notes](#) on page 17

Review the new capabilities, changes, fixes (resolved issues), security fixes, deprecated features, and limitations in each release.

[Package SDK](#) on page 3509

Package SDK enables you in creating and uploading action packages to your Control Room.

#### Related reference

[Operating system, environment, and platform supported for Control Room](#) on page 1194

Automation 360 can be hosted on AWS, Microsoft Azure, Google Cloud Platform, IBM, and any public, private, or hybrid cloud service that meets the Control Room and Bot Agent hardware and software requirements.

[Automation 360 FAQ](#) on page 1018

For details and questions on the latest Automation Anywhere platform, Automation 360, review this FAQ.

[Variable mapping for migration](#) on page 1655

In migration, some variables map directly from previous product versions to Automation 360 while others behave differently or contain configuration changes.

[Global values](#) on page 2350

Global values enable users to reuse identical values between bots instead of creating new variables for each bot.

[Recursive expressions](#) on page 2340

Use a recursive expression to insert a variable in the place of an index or key of a dictionary, list, record, or table variable.

## Automation 360 IQ Bot feature comparison matrix

Compare the key features of Automation 360 IQ Bot deployment models and review the feature parity with the latest IQ Bot 11.3.x release.

IQ Bot basic features	Automation 360 IQ Bot			IQ Bot 11.3.x
	On-Premises	Cloud	Community Edition	
Prebuilt domains	Yes	Yes	Yes Supported domains include: <ul style="list-style-type: none"> <li>• Invoices</li> <li>• Purchase orders</li> <li>• Bank statements</li> <li>• Credit memo</li> <li>• Utility bills</li> </ul>	Yes
User confidence threshold in Validator	Yes	No	No	Yes
Learning instance creation/editing/renaming	Yes	Yes	Yes	Yes
Document image preprocessing	Yes	Yes	Yes	Yes
Document image classification	Yes	Yes	Yes	Yes
Document image OCR	Yes	Yes	Yes	Yes
Google Vision OCR	Yes	Yes	Yes	Yes
Tegaki API OCR engine	Yes	No	No	Yes
MICR (magnetic ink character recognition) extraction	Yes	Yes	Yes	Yes
PDFBox Toggle	Yes	Yes	Yes	Yes
Caching (enhanced performance)	Yes	Yes	Yes	Yes
Bot limiting	Yes	Yes	No	Yes

IQ Bot basic features	Automation 360 IQ Bot			IQ Bot 11.3.x
	On-Premises	Cloud	Community Edition	
Bot creation/editing/deletion	Yes	Yes	Yes	Yes
Designer/Preview/Test	Yes	Yes	Yes	Yes
Production toggle	Yes	Yes	Yes	Yes
Validator	Yes	Yes	Yes	Yes
CSV output files	Yes	Yes	Yes	Yes
Learning instance import/export	Yes	Yes	No	Yes
Default validations for a group	Yes	Yes	No	Yes
Adding groups manually	Yes	Yes	No	No
CyberArk support	Yes	No	No	No
CyberArk support with key rotation	Yes	No	No	No

Domain/training features	Automation 360 IQ Bot			IQ Bot 11.3.x
	On-Premises	Cloud	Community Edition	
Web-based UI	Yes	Yes	Yes	Yes
Domain import/export	Yes	Yes	No	Yes
Hover over text segment to view OCR	Yes	Yes	Yes	Yes
Resize mapped box in Designer	Yes	Yes	Yes	Yes
Delete mapped box in Designer	Yes	Yes	Yes	Yes
Populate text in <b>End of table/section indicator</b>	Yes	Yes	Yes	Yes
Single click to extract text in the Validator	Yes	Yes	Yes	Yes
Document group description	Yes	Yes	Yes	Yes
<b>See extraction results</b> action displays list of all training documents in an alphanumeric sequence	Yes	Yes	Yes	Yes

Domain/training features	Automation 360 IQ Bot			IQ Bot 11.3.x
	On-Premises	Cloud	Community Edition	
InstallShield patch installer with simplified upgrade/downgrade for IQ Bot	Yes	No	No	Yes
OCR Pre-processing Settings configuration	Yes	No	No	No

Extraction/validation features	Automation 360 IQ Bot			IQ Bot 11.3.x
	On-Premises	Cloud	Community Edition	
Original IQ Bot text segmentation/document classifier from IQ Bot Version 5.3.0/6.0	Yes	No	No	Yes
New IQ Bot text segmentation/ document classifier from IQ Bot Version 5.3.1/6.5	Yes	Yes	Yes	Yes
Option to select classifier version of existing learning instances during IQ Bot upgrade: <ul style="list-style-type: none"> <li>Version 1 (IQ Bot 5.3.0 or before 6.0)</li> <li>Version 2 (IQ Bot 5.3.1/ Version 6.5 Beta)</li> </ul>	Yes	No	No	Yes
Enhanced compatibility with ABBYY FineReader Engine 12.2 Plugin	Yes	Yes	Yes	Yes
Automated installation of ABBYY FineReader Engine 12.2 Plugin	Yes	Yes	Yes	Yes
Validator auto-correction	Yes	Yes	Yes	Yes
Check box extraction	Yes	Yes	Yes	Yes
Check box auto-detection	Yes	Yes	Yes	Yes
Advanced extraction: Repeated tables/sections; linking tables/sections; map some header-less columns	Yes	Yes	Yes	Yes

Extraction/validation features	Automation 360 IQ Bot			IQ Bot 11.3.x
	On-Premises	Cloud	Community Edition	
Alternative to stop extraction at <b>End of table/section indicator</b>	Yes	Yes	Yes	Yes
Select text segments that enclose or are enclosed by other text segments	Yes	Yes	Yes	Yes
Option to select default training document	Yes	Yes	Yes	Yes
Formula validation	Yes	Yes	Yes	Yes
List validation in UI	Yes	Yes	Yes	Yes
List validation through external file	No	No	No	No
File/folder search validator	Yes	Yes	Yes	Yes
Microsoft Azure Computer Vision API (OCR)	Yes	Yes	Yes	Yes
Add user logic in the Designer	Yes	Yes	Yes	Yes
View and test all documents in the <b>Designer</b> > <b>See extraction results</b>	Yes	Yes	Yes	Yes
IQ Bot extensions	Yes	No	No	Yes
Import standard form domains	Yes	Yes	No	Yes
(Beta) Enabled data capture and OCR using Google Vision API for Asian languages	Yes	Yes	Yes	Yes
Magnetic ink character recognition (MICR) extraction	Yes	Yes	Yes	Yes
Option to turn off PDFBox as OCR engine	Yes	Yes	Yes	Yes
Using variables in IQ Bot package	Yes	Yes	Yes	No
Extraction results opening in a new browser tab	Yes	Yes	Yes	No
IQ Bot standard forms	Yes	Yes	No	No



Enterprise features	Automation 360 IQ Bot			IQ Bot 11.3.x
	On-Premises	Cloud	Community Edition	
Access IQ Bot without device license (without Bot Creator or Bot Runner license)	Yes	Yes	Yes	Yes
Access IQ Bot as Validator users without Bot Creator or Bot Runner license	Yes	Yes	Yes	Yes
Database encryption	Yes	Yes	Yes	Yes
Roles-based access (RBAC) for new learning instances	Yes	Yes	No	Yes
Audit logs	Yes	Yes	No	Yes
Windows authentication	Yes	Yes	No	Yes
Azure PaaS Database Service	Yes	No	No	Yes
Counter for number of uploaded pages in production	Yes	Yes	No	Yes
API access	Yes	Yes	Yes	Yes
Access IQ Bot without sysadmin role that includes support for Amazon Relational Database Service (RDS) out of the box	Yes	No	No	Yes
Migrate learning instances as other learning instances are being edited	Yes	Yes	No	Yes
Migration Utility UI	Yes	Yes	No	Yes
Internationalization	Yes	Yes	Yes	Yes
UI Localization: <ul style="list-style-type: none"> <li>• Chinese Simplified</li> <li>• Chinese Traditional</li> <li>• French</li> <li>• German</li> <li>• Japanese</li> <li>• Korean</li> <li>• Spanish</li> <li>• Italian</li> <li>• Portuguese</li> </ul>	Yes	Yes	Yes	Yes

Automation 360 packages	Automation 360 IQ Bot		
	On-Premises	Cloud	Community Edition
Document Classifier package	Yes	Yes	No
IQ Bot [Local Device] package	Yes	Yes	Yes
IQ Bot Pre-processor package	Yes	Yes	Yes
IQ Bot Extractionpackage	Yes	Yes	Yes

Related reference

[Comparing Automation 360 and Enterprise 11 APIs](#) on page 3970

Compare Automation 360 and Enterprise 11 APIs to understand the contract changes when you migrate from Enterprise 11 to Automation 360.

Related information

[IQ Bot 11.x feature comparison matrix](#)

## Automation 360 IQ Bot version compatibility

Review the version compatibility information before you update from an earlier version of Automation 360 IQ Bot to the latest Automation 360 IQ Bot version, or from earlier versions of IQ Bot to Automation 360 IQ Bot.

### Compatibility with Automation 360 Control Room

Automation 360 IQ Bot On-Premises version compatibility with Automation 360 Control Room:

**Important:** The following table lists the latest build of each Control Room release that is compatible with the IQ Bot build. Note that, IQ Bot is compatible with all Automation 360 builds in a release. For example, Automation 360 v.21, IQ Bot build 9642 is compatible with Control Room build 9664 and builds released after that such as 9595, and 9642 for the same release version. We recommend that you update to the latest Control Room build for the latest fixes.

IQ Bot On-Premises	Control Room
Build 21023	Build 21023 (Automation 360 v.31)
Build 19688	Build 19688 (Automation 360 v.30)
Build 18371	Build 18399 (Automation 360 v.29)
Build 17571	Build 17593 (Automation 360 v.28)
Build 16685	Build 16685 (Automation 360 v.27)
Build 15459	Build 15459 (Automation 360 v.26)
Build 15112	Build 15112 (Automation 360 v.25)
Build 13343	Build 13343 (Automation 360 v.24R2)
Build 12350	Build 12350 (Automation 360 v.24)

<b>IQ Bot On-Premises</b>	<b>Control Room</b>
Build 11513	Build 11513 (Automation 360 v.23)
Build 10520	Build 10526 (Automation 360 v.22)
Build 9642	Build 9664 (Automation 360 v.21)
Build 8815	Build 8815 (A2019.20)
Build 8098	Build 8147 (A2019.19)
Build 7554	Build 7560 (A2019.18)
Build 7082	Build 7103 (A2019.17)
Build 6443	Build 6463 (A2019.16)
Build 5931	Build 5933 (A2019.15)
Build 5322	Build 5322 (A2019.14)
Build 4695	Build 4705 (A2019.13)
Build 4088	Build 4105 (A2019.12)
Build 3337	Build 3337 (A2019.11)
Build 2545	Build 2545 (A2019.10)
Build 2079	Build 2079
Build 1610	Build 1610
Build 1089	Build 1089
Build 550	Build 550

Automation 360 IQ Bot Cloud version compatibility with Automation 360 Control Room:

<b>IQ Bot Cloud</b>	<b>Control Room</b>
Build 19688	Build 19688 (Automation 360 v.30)
Build 18345	Build 18361 (Automation 360 v.29)
Build 17566	Build 17566 (Automation 360 v.28)
Build 16701	Build 16701 (Automation 360 v.27)
Build 15436	Build 15459 (Automation 360 v.26)
Build 14288	Build 14298 (Automation 360 v.25)
Build 12342	Build 12342 (Automation 360 v.24)

### **Migration compatibility with earlier IQ Bot versions**

Review the following version compatibility table to understand the available update options for Automation 360 IQ Bot:

---

IQ Bot version	Automation 360 IQ Bot (On-Premises)
Version 11.3.5.x	Yes
Version 11.3.4.x	Yes

To migrate to Automation 360 IQ Bot On-Premises from a version earlier than 11.3.4.x, first update to IQ Bot Version 11.3.4.x or later.

[Migrate to Automation 360 IQ Bot](#) on page 1718

Importing learning instances between different IQ Bot versions is not supported. If you want to retain the associated data for a learning instance, ensure you update or migrate to the correct IQ Bot version before importing the corresponding learning instance. For example, if you export a learning instance in IQ Bot On-Premises (Build 8815), you can only import it within an equivalent IQ Bot On-Premises or Cloud build.

[Migrate learning instances](#) on page 1725

# Automation 360

The Automation Anywhere Digital Workforce platform is the foundation to deliver the automation of complex business work securely and at scale. Automation 360 is an industry-leading RPA and digital workforce platform that combines an easy-to-use user interface with enterprise-class reliability and the security to enable real-time self-automation.

## Overview

Automation 360 is an industry-leading RPA and digital workforce platform that combines an easy-to-use user interface with enterprise-class reliability and the security to enable real-time self-automation. It delivers a browser-based, intuitive experience for business users to quickly automate tasks and tools for developers to build process automation. Automation 360 provides both On-Premises and Cloud deployment options and is the first platform that provides RPA-as-a-Service as an automation solution. It enables users to automate applications across different infrastructures and industries such as banking, telecommunications, and business process outsourcing (BPO) organizations.

Automation 360 provides capabilities such as the following:

- An intuitive interface to create a bot and design business process automation workflows.
- Support for multiple operating systems including Windows, Linux, and MacOS.
- Different views of bot to facilitate collaboration: flow view for business users, list view for developers, and dual view for collaboration.
- Recorder that works across various platforms such as Microsoft Windows, Citrix, Web, and SAP.
- Advanced variables capabilities and support for JavaScript, Python, and VBScript.
- A flexible architecture that enables you to add new packages.

The platform also includes attended automation and plug-ins that enable business users to automate tasks from within their business applications such as Microsoft Excel and Salesforce. This capability makes automation of front-office processes easier, faster, and more cost-efficient.

Automation 360 is available globally and in 10 languages, including English, French, German, Japanese, Korean, Italian, Portuguese, Russian, Spanish, Simplified Chinese, and Traditional Chinese.

## Automation 360 components

Automation Co-Pilot for Business Users  
(Automation Co-Pilot)

Automation Co-Pilot is an easy-to-use interface that enables business users to collaborate with bots. Users can start process automations, provide feedback to bots to resume processes, and escalate requests to additional users for downstream processing. Automation Co-Pilot enables the enterprise to unlock new automation opportunities between humans and bots that RPA could not previously address.

Automation Workspace	<p data-bbox="850 191 1406 254"><a href="#">Automation Co-Pilot for Business Users</a> on page 3296</p> <p data-bbox="850 279 1406 436">(formerly known as RPA Workspace) A web-based workspace that provides the tools and capabilities to create, upload, and deploy bots to automate repetitive tasks and processes. It includes the following:</p> <ul data-bbox="850 457 1081 625" style="list-style-type: none"><li>• Control Room</li><li>• Bot Runner</li><li>• Bot editor</li><li>• Bot Creator</li><li>• Credential Vault</li></ul>
Process Discovery	<p data-bbox="850 667 1419 730">Automation Workspace provides the following capabilities:</p> <ul data-bbox="850 751 1419 940" style="list-style-type: none"><li>• Enables users to manage, schedule, and execute bots</li><li>• Enables user management through Active Directory role mapping</li><li>• Enables users to manage large number of Work Items through workload management</li></ul> <p data-bbox="850 989 1419 1398">An intelligent business solution that delivers a real-time, data-driven map of your business to help you uncover transformational process insights across all applications, through each department, and for every single task. Process Discovery follows the human instead of process logs by using advanced computer vision, machine learning, and artificial intelligence to capture every step in every process across every system. It requires zero integration, is universally compatible, and provides the privacy and security of an on-premises solution.</p>
Privacy Enhanced Gateway	<p data-bbox="850 1419 1419 1446"><a href="#">Process Discovery</a> on page 3815</p> <p data-bbox="850 1472 1419 1845">Using Privacy Enhanced Gateway (PEG), enterprises can confidently execute on their strategic business initiatives by filtering their sensitive data in a secure and scalable manner. PEG works by redacting sensitive data that has been obtained on customer's machines within their own network before forwarding the data to the Process Discovery cloud for analysis. As all traffic from the agents goes through PEG before leaving the customer's perimeter, PEG removes personally identifiable information (PII) and sensitive data.</p>

Discovery Bot	<p><a href="#">Getting started with Privacy Enhanced Gateway</a> on page 3851</p> <p>An intelligent business solution for enterprise businesses that provides capabilities for end users to discover opportunities for automation using process discovery. Discovery Bot focuses on process automation by capturing document processes, identifying opportunities from business centric processes, and prioritizing opportunities based on ROI, and create bots automatically. Discovery Bot aligns business workers to uncover automation opportunities that can optimize the return on your RPA investment.</p>		
IQ Bot	<p><a href="#">Process discovery by using Discovery Bot</a> on page 3888</p> <p>An intelligent document processing solution that can read and process various complex documents and emails. IQ Bot combines RPA with multiple AI techniques to intelligently capture, classify, and extract semi-structured and unstructured data, allowing document-centric business processes to be automated end-to-end.</p>		
Bot Insight	<p><a href="#">Install and update Automation 360 IQ Bot</a> on page 1426</p> <p>The analytics platform that provides real-time, interactive, and smart insights about business processes and operational intelligence. Bot Insight uses the large amount of content-level and productivity data that the deployed bots generate and translates the data into insights through automatically generated and customizable dashboards.</p>		
Bot Store	<p><a href="#">Business analytics through Bot Insight</a> on page 3925</p> <p>Online marketplace for pre-built bots and Digital Workers that run on the Automation 360 platform. Access Bot Store directly from the Control Room to download or submit bots and packages.</p>		
	<p><a href="#">Bot Store</a> on page 3607</p> <table><tr><td data-bbox="859 1709 1057 1736">Private Bot Store</td><td data-bbox="1143 1709 1406 1894">A secure internal bot marketplace for a company to post and share details and documentation for all internally developed</td></tr></table>	Private Bot Store	A secure internal bot marketplace for a company to post and share details and documentation for all internally developed
Private Bot Store	A secure internal bot marketplace for a company to post and share details and documentation for all internally developed		

bots. Employees can easily discover internal bots and commands to reuse in addition to all of bots from the Automation Anywhere Bot Store.

[Private Bot Store](#) on page 3612

The following image shows the components of Automation 360:

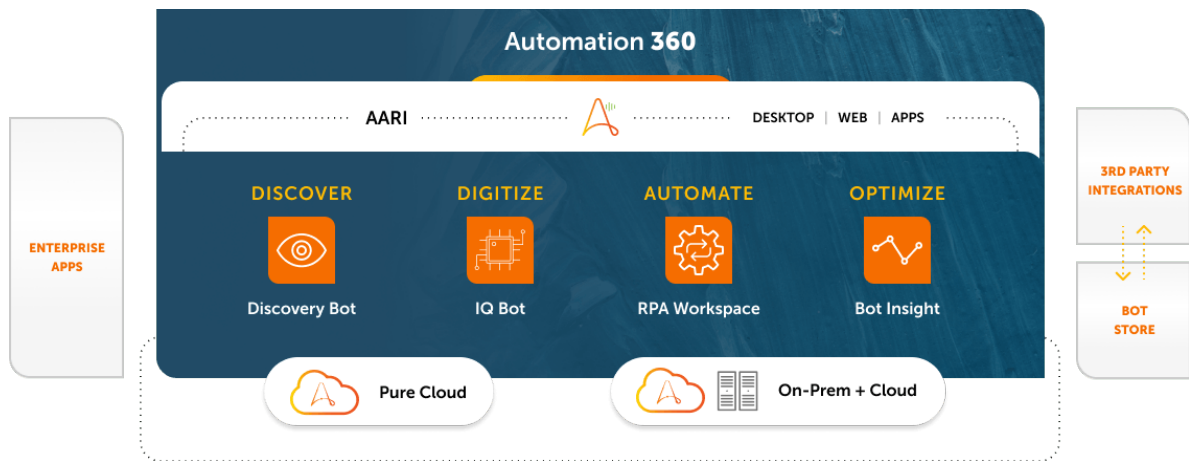

## Benefits

Faster time to value

- Instant web-based deployment that enables you to start developing bots quickly
- An intuitive interface that enables users with varying skill levels to easily use the product and speed up the learning process
- Easy collaboration between business, process, and IT

Business agility

- Regular updates to stay up-to-date on any device anywhere
- Business continuity with high availability and disaster recovery
- Scalability

Lowest total cost of ownership (TCO)

- No additional infrastructure investment required
- Single platform across front office, back office, and employee applications
- Reduced maintenance cost



Watch the following video to learn more about RPA:

## Deployment models

Automation 360 provides the following deployment models:

### Cloud

Automation 360 Cloud is hosted by Automation Anywhere, providing an easy consumption model of the Automation 360 platform built on a cloud-native architecture. With the Automation 360 Cloud service, the Automation 360 platform, which includes the Automation 360 Control Room and applications (Automation Workspace, IQ Bot, Bot Insight, Automation Co-Pilot, and Discovery Bot), is hosted by Automation Anywhere and accessed by users through a web browser. The Bot Agent devices where the bots run and execute the automations remain on the customer's infrastructure and securely connect to the Automation 360 Cloud service through HTTPS.

### Cloud-enabled

In this deployment model, data is hosted On-Premises. This model is suitable for customers who have to adhere to strict regulatory norms where data sovereignty is mandatory.

### On-Premises with packages updates through Cloud

With Automation Anywhere On-Premises with packages updates through Cloud service, all business, personal, and operational data is kept on and deployed from the server on-premises on the customer network.

The following image shows the deployment models for Automation 360:

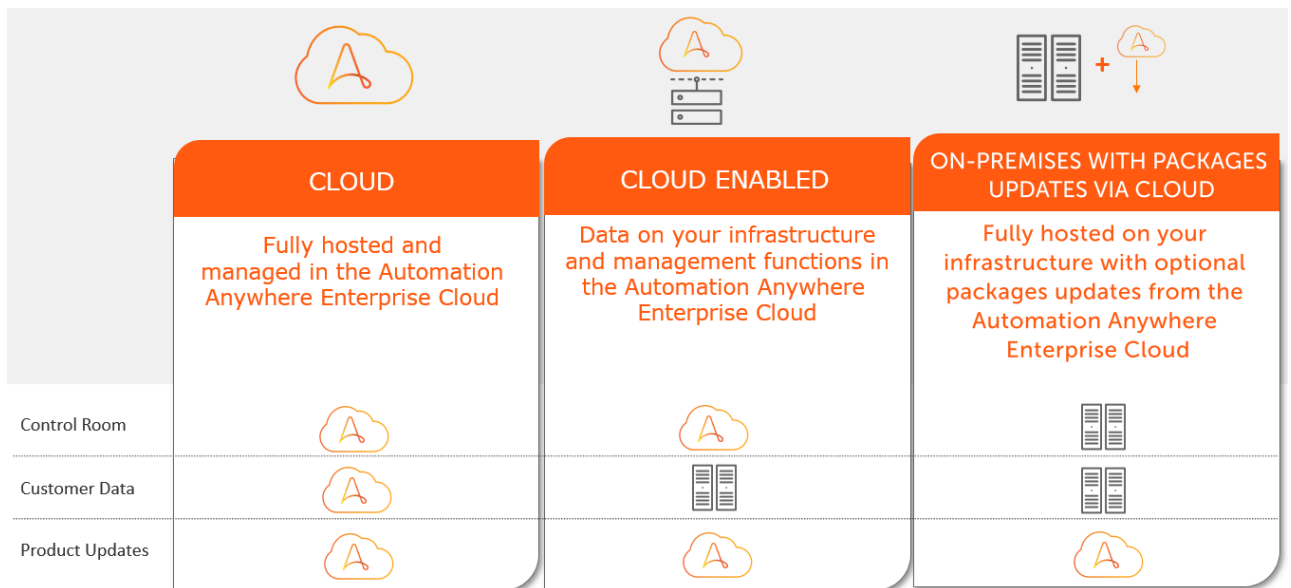

See also [Cloud operational responsibilities](#) on page 1033.

## Available offerings

The Automation 360 platform includes the following offerings:

- Automation 360 delivered in the cloud, hosted by Automation Anywhere with no client installation or additional infrastructure required
- Automation 360, the full platform delivered On-Premises
- Community Edition, a free web-based option for users to experience a wide-range of Automation 360 bot creation capabilities

---

**Note:** For information on the in-product help and guide, see [In-product user assistance](#) on page 1159.

---

## Documentation on previous releases

For documentation on previous versions of our products, see the PDFs available on these pages:

- [Automation 360](#)
- [Enterprise 11.x](#)
- [Process Discovery](#)
- [Integrations](#)
- [IQ Bot 11x](#)
- [Mobile apps](#)
- [Human-Bot Collaboration 11.x](#)

Related information

[Automation 360 platform](#)

[What is RPA?](#)

[What are RPA bots](#)

[RPA for Business Process Outsourcing \(BPO\)](#)

[Automation Anywhere University: RPA Training and Certification \(A-People login required\)](#)

## Automation 360 FAQ

For details and questions on the latest Automation Anywhere platform, Automation 360, review this FAQ.

What is Automation 360?

Automation 360 delivers a browser-based, intuitive experience for business users to easily automate tasks and powerful tools for developers to build process automation, delivering security, governance, and control on a scalable infrastructure for IT.

What is included in Automation 360?

Everything to build the bots you need to automate your business processes: Control Room cluster, Bot editor, Bot Runner,

How is Automation 360 deployed?	<p>Universal Recorder, Enterprise-grade security certifications, support, access to the Bot Store, and courses on Automation Anywhere University.</p> <p>Automation 360 can be deployed On-Premises as well as in the Cloud.</p> <p>For Automation 360 On-Premises deployment, the installation is on the customer's servers. With the web-based nature of the Bot Creator, there is no installation or deployment required on the user machines, resulting in a significant reduction in total cost of ownership (TCO).</p> <p>Automation 360 deployed in the Cloud offers a turnkey solution where the buyers do not have to worry about choosing the cloud provider, or any other infrastructure elements– Automation Anywhere takes care of it all. Admins get the complete set of features for user management, security, governance, and control that they also access through a web browser. The end users can then access the platform using their browser, log in, and start creating their bots.</p>
What additional cloud hosting options are available?	<p>Automation 360 can be hosted on AWS, Microsoft Azure, Google Cloud, IBM, and any public, private, or hybrid cloud service.</p>
How is Automation 360 delivered?	<p>You can start your automaton journey with Automation 360 in one of the following ways:</p> <ul style="list-style-type: none"><li data-bbox="850 1161 1427 1318">• Automation 360 (Cloud or On-Premises): Automation 360 is an intelligent cloud-native end-to-end platform you can use to automate your business processes across systems and applications.  For more information see: <a href="#">Automation 360</a> on page 1013.</li><li data-bbox="850 1402 1427 1591">• Community Edition: Community Edition provides a free web-based option for users to experience a range of Automation 360 bot creation capabilities. Community Edition can be used by small organizations (less than 250 machines).  Community Edition provides one Bot Creator license that you can use to log in to one device, and deploy one bot at a time. There is no limitation to the number of automations that you can create, but you will have access to only limited features.  For more information, see: <a href="#">Set up Community Edition</a> on page 1326  </li></ul>

[Community Edition capabilities](#) on page 1327.

What scripting languages does Automation 360 support?	Automation 360 supports JavaScript, Python, and VBScript.
Is Automation 360 available in languages other than English?	Yes, Automation 360 is available in 10 languages: English, French, German, Italian, Japanese, Korean, Portuguese, Spanish, Simplified Chinese, and Traditional Chinese.
How is Automation 360 updated?	<p>For Cloud deployed Automation 360, customers are always on the latest version with updates rolled out by Automation Anywhere on a regular basis. For features such as action packages, admins and users have the ability to test the latest packages before choosing to accept the update.</p> <p>For On-Premises customers, regular updates are made available through the customer portal, providing admins an opportunity to keep their business-wide installation on the version of their choice.</p>
What are some of the data privacy and security aspects of Automation 360?	<p>Automation Anywhere Cloud privacy is engineered with a comprehensive set of security features that either automatically provide or are configurable by the data owner to provide data protection. Automation Anywhere Cloud includes comprehensive security and encrypts data both in transit and at rest. No personal data goes outside of the environment—unless you tell it to; it remains completely under the control of the IT manager.</p> <p>To ensure customers can trust the AAI Enterprise Cloud, Automation Anywhere Cloud services are secured based on industry standards and frameworks like NIST Cybersecurity Framework, AWS Cloud Adaption Framework, Center for Information Security (CIS) baselines, and others.</p> <p>For more information see <a href="#">Compliance Portal</a> and <a href="#">Automation Trust and Security</a>.</p>

#### Related concepts

[Automation 360 Release Notes](#) on page 17

Review the new capabilities, changes, fixes (resolved issues), security fixes, deprecated features, and limitations in each release.

[Licenses and cloud services](#) on page 1404

The Licenses and Cloud Services portal enables you to manage the licenses, Cloud Control Room instances, and cloud RPA services linked to your account. As an Automation Anywhere customer

or partner, and an RPA, Control Room, or IT administrator, you need to manage your entire IT asset framework efficiently to realize the value of your investments.

Related reference

[Automation 360 Cloud FAQ](#) on page 1058

Answers to frequently asked questions (FAQ) and related information provide insight into various aspects related to Automation 360 Cloud.

## Automation 360 architecture and resiliency

Automation 360 is a single, integrated platform that transcends front office and back office technology silos to automate business processes across all systems and applications, including both SaaS and legacy apps.

The Automation 360 platform is deployed using a distributed architecture.

Centralized management is done through a web-based server, called the Control Room, to manage all development and execution of the digital workforce. The Bot Agent executes automation and are run time systems installed on the devices.

The following image shows the architecture and relation between Control Room and Bot Agent:

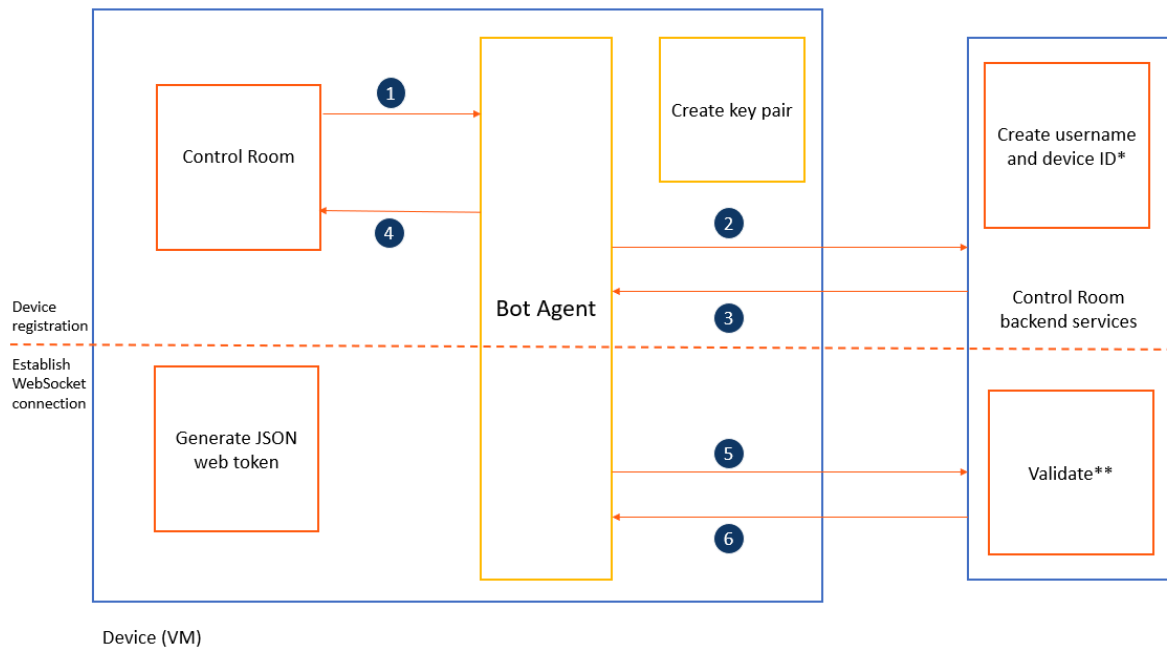

- \*indicates that the Control Room creates a unique user name and device ID to persist in the public key in the database.
- \*\*indicates that device public key is validated by the Control Room and a new token is created.

The following table describes the flow and the actions that occur between the Control Room, Bot Agent and the back end services (as numbered in the previous image):

Actions	Description
1	The browser sends the device token to the Bot Agent for registration.

Actions	Description
2	The Bot Agent then registers the device request to create a public key and a token.
3	The back end services of the Control Room sends a response to the Bot Agent that the device has been registered with a unique user name and device ID.
4	The Bot Agent sends a message to the browser that the device has been registered successfully.
5	The Bot Agent sends a message to the back end services of the Control Room to indicate that the JSON web token has been authenticated successfully.
6	The back end services of the Control Room then validates the device public key and establishes a Web Socket connection with the new token.

## Control Room and Bot Agent resiliency

The following table provides you the behavior and resiliency differences between Automation 360 and Enterprise 11.

Bot Agent in Automation 360	Bot Runner Client in Enterprise 11	Notes
Services are run on the local device.	Installation services are run inside an active user session.	
Registered to the Control Room.	An active user is registered to the Control Room.	Bot Agent service runs on the local system.
Authentication stores the agent public key in the database.	Control Room stores the authentication key in the memory.	In Automation 360, the Control Room stores the public key in the database. So when the Control Room restarts, the reconnection is accepted faster. The Bot Agent is resilient across Control Room restarts.  However, in Enterprise 11, the Control Room reconnection does not happen after a restart.

Bot Agent in Automation 360	Bot Runner Client in Enterprise 11	Notes
<p><b>Priority of bots is verified at deployment.</b></p> <p>When bots are queued for a Bot Runner user, higher-priority bots are deployed before lower-priority bots.</p> <p>However, if a lower-priority bot is already running, higher-priority bots are deployed only after the lower-priority bot completes running.</p>	<p>When a low-priority bot is running and a high-priority bot is deployed, the system pauses the low-priority bot and runs the high-priority bot.</p> <p>After the high-priority bot is run, the low-priority bot resumes.</p>	<p>Advantage in Automation 360 is that lower priority bots are not paused and complete their deployment before the high-priority bots are deployed.</p>
<p><b>Error handling</b> package handles actions to easily handle exceptions a bot encounters and transfers control to other actions within that bot.</p>	<p>Error Handling command helps in debugging when the Task Bot and MetaBot Logic are run.</p>	
<p><b>Devices</b> reconnected when device is registered with the Control Room.</p> <p>Reconnects when the device restarts.</p>	<p>When the Bot Runner Client restarts or loses connectivity with the Control Room, you must re-log to the Client to reconnect.</p>	<p>Bot Agent reconnects without individually logging in to every single device.</p>
<p><b>Bot Agent</b> reconnects automatically if there is an interruption.</p>	<p>The Bot Runner client needs to be reconnected manually.</p>	<p>Bot registration in Automation 360 is more robust and can reconnect automatically to the Control Room.</p>
<p><b>Public and private key</b> is generated at the time of registration. This key is used to authenticate to the Control Room.</p>	<p>Same behavior as in Automation 360.</p>	
<p><b>Services</b> are run as a service. When device reboots, the services are automatically connected to the Control Room.</p>	<p>Requires a client to log in and perform tasks.</p>	

Bot Agent in Automation 360	Bot Runner Client in Enterprise 11	Notes
<p><b>Remote Desktop Protocol</b> is supported only on multi-user devices.</p> <p>The Control Room does not maintain the RDP.</p>	<p>Remote Desktop Protocol is supported on both single and multi-user devices.</p> <p>In Enterprise 11, Remote Desktop Protocol connection is established from the Control Room and maintained by the Control Room.</p>	
<p><b>Control Room administrator updates</b> those to automatically update the Bot Agent to a later version using auto-update capability.</p>	<p>Auto-update option is not available.</p>	<p>Auto-update reduces downtime because each user is not required to log in to the Control Room to update the Bot Agent installed on the user device.</p>
<p><b>Configuration updates</b> pushed through updates</p>	<p>No standalone configuration updates, but you can change it manually.</p> <p>Enhancements to the configurations are released as patches.</p>	
<p><b>Configure device settings</b> automatically set a user's current device as default device after the user logs in to the Control Room.</p>	<p>Not available</p>	



Bot Agent in Automation 360	Bot Runner Client in Enterprise 11	Notes
<p>Bots that are already running will run to completion during the update from Bot Agent to Control Room</p>		<p>In general, bots already running can run to completion during the update. Exceptions are as follows:</p> <ul style="list-style-type: none"> <li>• If the bot tags data for Bot Insight, the bot will not run.</li> <li>• Parent/child bots will run to completion because the child bots are downloaded at the start of running the parent bot. However, if child bots are referenced using a variable parameter, calling those child bots need the Control Room to be available during parent bot runs.</li> <li>• Bots that use workload management (WLM) will not run.</li> <li>• If a bot is using values from Credential Vault, the bot execution might fail if the Control Room connection is interrupted or lost. This happens as the bot fetches the value from Credential Vault at the time of use.</li> </ul>

### Scheduling resiliency

Device pools provide built-in high availability (HA) for the Bot Runner devices if your unattended license is free to use. You are not tied to a single Bot Runner device, so if your device is unavailable for any reason and your unattended license is free for deployment, your automation is not affected. The scheduled automation will automatically run on the next available Bot Runner device, thereby providing high availability.

See [About device pools](#) on page 1881.

## Control Room overview

The Control Room manages, schedules, executes, and configures various capabilities of bots and Bot Runners using a collection of specialized web services.

### Components

The Control Room is a centralized management point for all bots. A reverse proxy is responsible for listening for remote connection requests and forwarding those requests to the correct specialized service. The following figure shows the On-Premises Control Room components and general data center interaction. Control Room components are shown in orange and data center components provided by your organization are shown in blue. Components that are centrally hosted on cloud and managed by Automation Anywhere such as license server are shown in white.

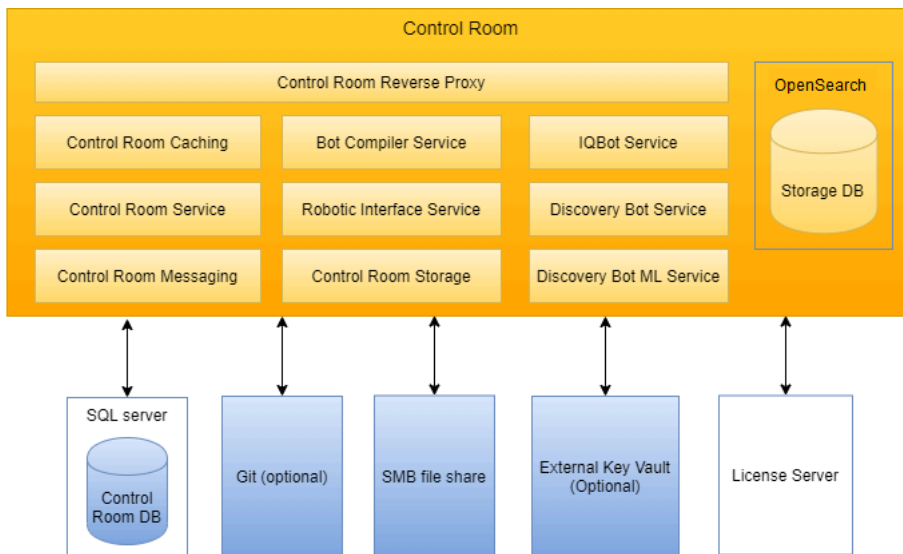

In the data center, Control Room is installed on a server and configured to interact with the other data center components.

The Control Room includes objects that performs the following:

- Control Room reverse proxy is managed through the following functions:
  - Control Room services
  - Control Room messaging
  - Control Room caching
- OpenSearch
- Licensing

The Control Room required data center components include:

- An SQL server with a Control Room database.
- A Server Message Block (SMB) file share

For Cloud Control Room architecture, see [Cloud Control Room architecture image](#).

## Centralized Automation Deployment

- Control Room acts as the single point of access and control for bot execution.
- Control Room provides bot upload and download features to facilitate seamless collaboration for end to end business process automation by multiple users.
- All scheduling is managed by the Control Room. Bots are deployed on the Bot Runners either ad hoc or on pre-defined schedules. Once the schedules are created, Control Room automatically and intelligently picks up the subsequent updates to bots, without any need to alter automation schedules.

## Centralized Access Control

- Least Privilege and Access controls user access. They are implemented in the Control Room through Role Based Access Control (RBAC).
- All Users and Roles are created and managed from the Control Room.

## Collaboration Centralized Workforce Management

- Control Room dashboards provide a single view of the entire automation infrastructure.
- Control Room receives real time heartbeat and telemetry from automations with events, exceptions and alerts.
- Unauthorized users cannot pause, resume or stop any of the ongoing automations on any Bot Runner.
- All historical automation data is logged in and available through Control Room Audit Logs.

Related information

[Control Room overview](#)

## Distributed architecture

Automation Anywhere platform is deployed using a distributed architecture.

Centralized management is accomplished via a web-based server, called the Control Room, to manage all development and execution of the digital workforce. The Control Room is connected to Bot Creators and Bot Runners. Bot Creators are development systems used for authoring and tailoring of automations. Bot Runners execute the automations; they are run-time systems installed on machines. Bot Runners can be deployed on desktops, on virtual machines in data centers or cloud.

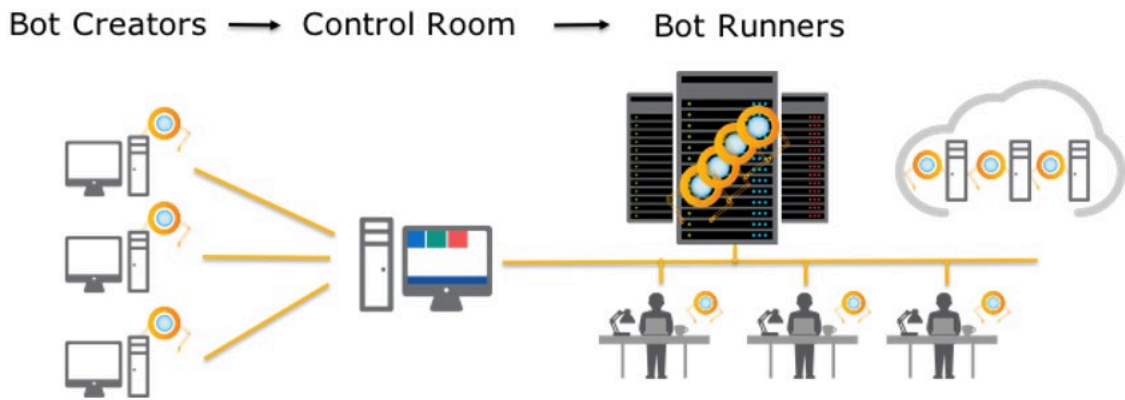

## Distributed architecture with HA/DR support

The Automation 360 self-contained platform within the customer environment mitigates the risk of "cross-contamination" from an unlikely event of a security breach from another network.

Automation Anywhere supports distributed architecture to deliver the optimal performance and security. Following are the main distributable components of Control Room which can be clustered to achieve High Availability (HA). In the image below, Automation Anywhere components are shown in orange and components provided by your organization are shown in blue. Components that are centrally hosted on cloud and managed by Automation Anywhere such as license server are shown in white.

Figure 1: Distributed Mode

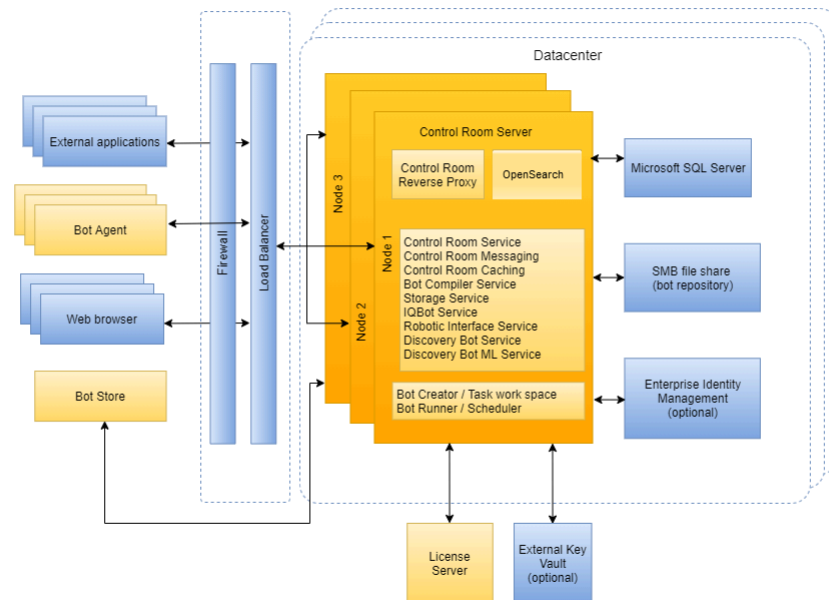

## Distributed Cache

Control Room architecture uses distributed cache to update all other nodes as soon as any information is updated in one of the nodes. This ensures fastest data synchronization across all the nodes and delivers seamless user experience. Automation 360 platform uses clustering mechanism to implement distributed cache, to synchronize all data operations. For example, when the Credential Vault is opened from one node, it is automatically opened for all other nodes too.

For information on HA/DR architecture for Automation 360 Cloud, see [Automation 360 Cloud Security and Data Privacy](#).

Related concepts

[HA and DR deployment models](#) on page 1230

Automation 360 provides several deployment options to meet various levels of enterprise cost/price performance and resiliency requirements. The options include installation on single nodes and on multiple nodes. Multi-node deployments can be configured for highly available (HA) clusters and disaster recovery (DR) sites.

## Security architecture

Many of the largest financial organizations in the world rely on the Automation 360 secure digital workforce platform to automate security-sensitive operations.

The platform's security architecture is founded on Least Privilege principles and a strict Separation of Duty model with 41 technical controls implemented across seven NIST 800-53r4 Control Families. Controls are applied across three components: the Control Room, Bot Creators (development systems), and Bot Runners (bot execution run times) through the bot life cycle from creation through decommissioning. This security architecture and the underlying controls are mapped to industry best practices as defined by NIST and can be readily mapped to other frameworks, for example, CoBIT (SOX) and ISO 27002.

## Access controls

Automation 360 limits and controls human and bot access to logical resources across components.

- Two independent control planes enforce least privilege. Only developers are enabled to read or write, only authorized Control Room users to execute automations, (Control Room authorizes and executes) subject to fine-grained Role Based Access Controls (RBAC) down to individual automations (bot), Bot Runners and domains.
- Bot- level Separation of Duty is enforced. Each bot is obfuscated and executed by its corresponding authorized Bot Runners.
- Bot execution is controlled via RBAC. Domain privileges are defined across groups of bot and Bot Runners.
- Security at-rest and in-transit: All access credentials are secured at-rest via a central Credential Vault with support for third-party credential stores. All communications are secured in-transit via SSL and TLS.

## Configuration management

Configuration management is controlled at both bots and Bot Runner levels.

- The Control Room authorizes, enforces, and logs changes to all Bot Creators and Bot Runners.
- Bots are controlled via a robust version control system, for rollback and full event logging.
- Bot change control on execution is enforced through encryption and authentication.

## Identification and authentication

Identification and authentication is controlled through Microsoft Windows authentication services.

- Bot Creators use Active Directory for authentication
- Bot Runners have two levels of authentication, one for autologin authentication of the runner and the other for execution of bots.
- Credentials are secured at-rest and in-motion through the Credential Vault or integration with third-party products.

## Risk assessment

Risk assessment is undertaken on Static, Dynamic, and Network-based Vulnerability Assessments. Audit and accountability are established through event capture, logging and auditing on all three components with granular event capture at the bot level and nonrepudiation. Bot Insight embedded analytics provides near-real-time Incident Response and integration with Security Event and Information Management systems.

Related information

[RPA Security](#)

## Security architecture model

Automation Anywhere Cognitive security architecture is founded on Least Privilege principles and a strict Separation of Duty model with 41 technical controls implemented across seven NIST Control families.

The NIST framework was selected as a foundation for best practices as a way to enumerate the controls implemented throughout. Translations from NIST to other control frameworks are widely available, resources are provided at the end of this topic.

The product security architecture is maintained by the Automation Anywhere Product Management team and forms part of a formal policy model as an integral part of the Automation Anywhere Development Roadmap. The following table lists the Control families and the corresponding features and security impacts. Details on each Control family and how the security architecture is implemented in Automation Anywhere products are in the corresponding topics.

Control Family	Control Code	Control Room Feature	Security Impact
Access controls	AC-3, 6, 7, 9, 10, 12	Central policy control	Enforce access restrictions for change control and least privileges on system components: <ul style="list-style-type: none"> <li>• Fine grained access to bots and Bot Runners is controlled via RBAC,</li> <li>• Bot and Bot Runner domains can be assigned to roles via RBAC</li> <li>• RBAC roles are fully audited</li> </ul>
	AC-2, 3, 5, 6	Role-based access control (RBAC)	Enable user access, restricts operational privileges, enforces least privilege principles
	AC-17	Bot repository	Bot versioning system with access restrictions
	AC-3, 7, 9, 10, 11	Bot and Bot Runner encryption	Encryption and obfuscation of sensitive information at bot level through credential vault and integration with key management systems
Configuration (change) management	CM-2, 5, 6, 7, 9	Centralized Bot Runner control	Restrict functionality based on roles, domains, implement deny-all and allow-by exception
	CM-10	Centralized licensing	Centralized provisioning, tracking and enforcement of Bot Creator and Bot Runner licensing
	CM-2, 5, 6, 8	Bot operations room	
	CM-8	Inventory control	Maintains centralized inventory control of all bots and runtimes

Control Family	Control Code	Control Room Feature	Security Impact
Bot Creator configuration management	SA-10	Bot Creator management, bot check-in, check-out	Control Room applies software life cycle management to bots from development, test, and production. Bot versioning enables change control of automations.
Audit and accountability	AU-1 through 15	Audit trail	Automated event logs captured on three levels: Control Room, Bot Runners, and Bot Creators. Non-repudiation is assured through read-only logs, all user identities are bound to actions.
Identification and authentication	IA-1 through 5	Active Directory integration, Bot Runner ID and Attestation	Implements Windows platform security including cryptographic bidirectional authentication, Bot Runner identification and attestation, and password management policies. Credential vault with integration with key management systems, protects the integrity of credentials.
Incident response	IR-4, 6	Incident response	Bot Insight embedded analytics capabilities can monitor events and generate alerts to SIEM systems for response.



Control Family	Control Code	Control Room Feature	Security Impact
Controlled maintenance	MA-2	Automated maintenance	Control Room versioning system provides an automated mechanism to roll out updates to bots, historical information is maintained.

(1) Resources: ISACA provides guides that map NIST SP800-53 to other security frameworks such as CoBIT (SOX), SANS Top20.

## Cloud operational responsibilities

Learn about secure deployment models, data element locations, and operational responsibilities.

## Securing the Cloud

Automation Anywhere Cloud is deployed to only allow access to Automation Anywhere Cloud Operations personnel and Security Team resources. Network and cloud control plane access is restricted using VPN with multi-factor authentication for AAI operational and security personnel. All AAI users must first authenticate using MFA tokens to retrieve short-term credentials to access cloud resources. User credentials are continuously monitored for compliance. All other operational users, cloud resources, and applications are restricted from access to the Control Room. Regular AAI user access certification is conducted to ensure only necessary access is provided to cloud operations personnel.

The cloud service is multi-tenanted and each customer control room environment uses a unique tenant identifier to ensure data separation between the Control Rooms. Automation Anywhere members cannot access a customer environment unless specific permission is provided by the customer, typically under support troubleshooting procedures and controls.

### Cloud

With the Automation Anywhere Cloud offering, all business, personal, and operational data is stored on Automation Anywhere administered cloud. Automation Anywhere is the cloud data controller and is responsible for customer data privacy as published in accordance with Automation Anywhere cloud security and compliance with data privacy.

[Privacy Policy for Automation Anywhere](#)

### Cloud-enabled

With the Automation Anywhere Cloud-enabled solution, business, personal, and operational data is stored and managed on the customer-controlled infrastructure, while specific operational data related to RPA is shared between the Automation Anywhere Cloud and the customer infrastructure. All data privacy and compliance rests with the customer.

On-Premises with updates through Cloud

With Automation Anywhere On-Premises with updates through Cloud service, all business, personal, and operational data is kept on and deployed from the server on-premises on the customer network. All data privacy and compliance rests with the customer.

For information about securing data, operations responsibilities, data types, and storage locations, see [Automation 360 Cloud Security and Data Privacy](#).

## Securing the RPA environment with external controls

The Automation Anywhere architecture consists of a standard desktop and server class infrastructure for the registered devices and the Control Room.

### RPA platform

This topic details the best practices for securing the RPA platform with external security controls. Network-based firewalls, Intrusion Detection Systems, anti-malware, and external log servers are all standard security controls that are relevant to RPA deployment and the other infrastructure in your environment. The following figure shows logically where these components are deployed in the RPA deployment:

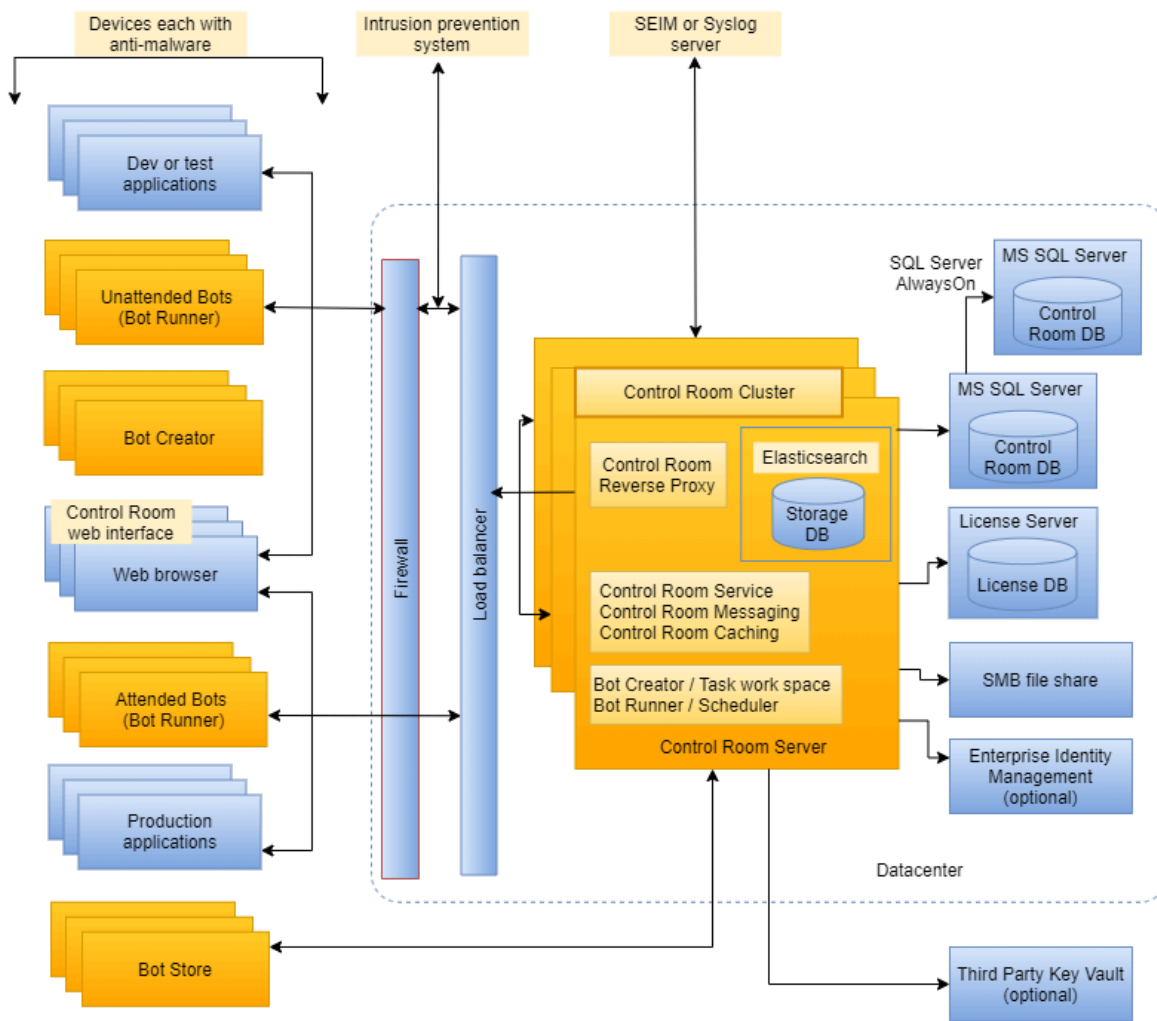

In the image, Control Room components are shown in orange and data center components provided by your organization are shown in blue.

Each external security control is discussed in detail in the following sections, in terms of placement and configuration. Supporting network services such as Active Directory, SMB File Share, Microsoft SQL Server, and production applications, and are accessed through network firewalls or directly, depending on their placement relative to the RPA components.

### Network-based access control to protect RPA with firewalls

Network-based firewalls and local server-based firewall are used to protect the Control Room or all nodes in a Control Room cluster. By default, required protocols on the Control Room are permitted from the corporate network. Additionally, all clustering protocols are permitted only between the nodes in the Control Room cluster. Network-based firewalls are used to isolate Development, Test, and Production RPA environments from the corporate network and from each other.

For unattended automation environments, the Bot Runners are placed in a specific isolated network and protected by a network-based firewall. Attended automations run from corporate

workstations with the Bot Runner Bot Agent installed and are protected via the corporate perimeter firewalls or internal firewalls protecting the corporate desktop infrastructure, like any desktop.

## **Anti-malware to protect RPA from viruses and malware**

The Automation Anywhere Bot Agent runs on desktop class infrastructure and is considered a corporate desktop. Anti-malware or anti-virus software is used to protect the registered device environment from malicious software in the form of viruses and malware.

## **Intrusion detection systems to protect RPA from direct attacks**

Intrusion Detection and Prevention Systems (IPS) protect the corporate network by detecting network-based attack through network traffic analysis. Like any other critical section of the data center, an IPS protects the RPA platform at the egress point, behind the network-based firewall.

## **Independent categories for Bot Creators and Bot Runners**

For logical separation of duties, Control Room divides automation users into two broad categories: Bot Creators (development) users and Bot Runners (run-time) users.

Bot Creators exist on a separate Microsoft Windows system with its own credentialing system to create, update, and unit test the bots on the Bot Creator. Bot Creators only upload and download bots to and from the Control Room. Users on the Control Room users have privileges to execute bots on Bot Runners but have no access to the Bot Creators. This separation of duty constitutes a dual authorization by requiring both the developer and the business user to create and execute the bot in conformance with NIST AC-3 best practices.

## **RBAC in Control Room**

Control Room implements Least Privileges and Separation of Duties through a configurable Role-Based Access Control (RBAC) capability that conforms to requirements in NIST AC 2, 3, 5, and 6.

All Control Room users are assigned one or more roles. Access are available based on the usage conditions assigned to each role when users are a member. Authorized users can temporarily or permanently suspend other users when needed. RBAC enforces session handling to prevent unauthorized access. If an unauthorized user attempts to view session details or gain access, the Control Room cluster will prevent this progress and immediately terminates the unauthorized session. The unauthorized user will be prompted to log in with valid credentials. Inactive accounts can be disabled.

The administrator controls are responsible for all security functions, consistent with best practices in NIST SC-3: Security Function Isolation.

The Control Room includes segmented administrator roles by default. Many permissions are supported for creating new roles.

Controls are implemented at the Control Room, Bot Creators, and Bot Runners layers, for NIST Access Controls (AC) and Change Management (CM) guidelines. The following technical controls are implemented to ensure access is governed through NIST Least Privileges.

## **RBAC on bots**

Access is deny all and allow by exception based on roles, except for admin roles. Addressing NIST AC-17 (access control), NIST configuration managements for NIST CM-2 (base line configurations), access restrictions for NIST CM-5, NIST CM-6, and NIST CM-7 (least functionality), and monitoring NIST CM-9 for bot activity across the development, test, and production environment.

## RBAC on Bot Runners

RBAC on Bot Runners facilitates complete isolation of one department Bot Runner seamlessly from the remaining departments' Bot Runners.

Bots are executed from the Control Room cluster. Local bot executions are protected through multiple layered security, and are designed to prevent fraud as a result from escalation of privileges on Microsoft Windows. The Bot Runner are executed by Windows, addressing access control enforcement in accordance with NIST AC-3 Access Enforcement and AC-6 Least Privilege for Code Execution.

If user roles does not have access to sets of Bot Runners, as a result, these users are unable to view the Bot Runners' executions or remote scheduling automation. See ([Role-based processing domains](#) on page 1038).

## RBAC for Credential Vault credentials management

Credentials created in the Control Room are used across Bot Creators and Bot Runners.

These credentials are securely stored in the centralized Credential Vault to facilitate access control, and to divide in logical groups called lockers. These lockers enable complete separation between the credentials of one department from another.

## Role-based permissions

Permissions for credential management-related roles include the following:

Manage my credentials and lockers	By default, all users can manage their own credentials and interact with the lockers to which they have permissions.
Manage my lockers	Allows the user to create and manage their own lockers.
Administer ALL lockers	User can do all the actions in the Admin row of the Locker permissions table below.
Create standard attributes for a credential	User can set an attribute value that remains the same for other users of that credential attribute.

## Locker permissions

Locker permissions are set when a locker is created or edited. A user can have the following permissions in a locker:

	View locker	Edit locker	Delete locker	Add participant owner	Remove participant owner	View credential	Assign credential	Remove credential	User-provided value	Standard value
Consume						#			#	
Participate						#	#			

	View locker	Edit locker	Delete locker	Add participant owner	Remove participant owner	View credential	Assign credential	Remove credential	User-provided value	Standard value
Manage	#	#	#			#	#	#		#
Own	#	#	#	#	#	#	#	#		#
Admin	#	#	#	#	#	#	#	#		#

#### Related tasks

[Create credential](#) on page 1864

Create a credential and add the required attributes.

[Create locker](#) on page 1866

Create a locker to group similar credentials to share with other users.

#### Related reference

[Credentials and lockers in the Credential Vault](#) on page 1861

The Credential Vault securely stores sensitive information such as passwords, account numbers, and social security numbers in credentials and lockers for use in automation tasks. It facilitates role-based access for users of a Control Room and ensures that sensitive values are not stored in bots or on devices.

## Role-based processing domains

The Control Room RBAC applies the least privilege principles to domains by implementing Processing Domains, specifying role-based privileges and permissions at the bots and Bot Runners level.

RBAC is applied at a folder level to completely and seamlessly isolate one department bot from the remaining department bots. If the user role does not have access to a set of bots, those bots do not exist, thereby enabling the separation of duties across different domains. For example, finance and accounting roles can access only the bots that automate their respective functions, and specific Bot Runners can execute these bots. This is consistent to best practices as defined by NIST AC-4 Processing Domains.

Authorized users assign various roles based on the business need.

## RBAC on Audit Log

Audit is automated for all privileged and nonprivileged roles to conform to best practices, as defined in NIST AC-6.

Access is view-only based on a deny all and allow by exception based on roles and domains as defined in the Audit section 7 addressing Audit and Accountability (NIST AU 1 through 15) and as required by NIST AC-2 Automated System Account Management. If a role does not have permission to view Audit Logs, then the Audit Trail tab is not visible to all members of that role. Audit automatically captures all events related to creation, modification, enablement, disablement, and removal of users, bots, Bot Creators, and Bot Runners.

## RBAC on viewing bot activity

The Control Room **Activity** menu provides options shows the status of the Automation Anywhere Enterprise automations. These options are: **In Progress**, **Scheduled**, and **Historical**.

Access to bot Activity status is deny all and allow by exception based on roles and domains as defined in RBAC. Two levels of checks are applied to access the bot Activity data. The user is required to be a member of a role that has access to view the Control Room. Users with Control Room access that can view only the bots belonging to their departments, as applied through RBAC on bots.

### **RBAC on User Management**

Access is deny all and allow by exception based on roles, domains as defined in RBAC. Only those users with access to User Management can manage other users in system.

This permission is further divided into the following sub permissions:

Create Users	Only those users that create new users from the Control Room.
Edit Users	Only those users that edit existing users from the Control Room.
Delete Users	Only those users that delete existing users from the Control Room.

Authorized users assign various combinations of these access permissions to different sets of users and roles based on the business requirements.

### **RBAC on roles and permissions management**

Access is deny all and allow by exception based on roles, domains as defined in RBAC.

Users with access to roles and permissions management can create, edit, and delete roles in the system. This permission is typically assigned to administrators and power users from across enterprises.

### **RBAC on bot schedules**

Access is deny all and allow by exception based on roles and domains as defined in RBAC.

This permission is further divided into the following sub permissions:

Schedule my bots to run	Only those users that create new schedules.
Edit my scheduled activity	Only those users that edit their schedules.
Delete my scheduled activity	Only those users that delete their schedules.
View and manage ALL scheduled activity	Only those users that manage (edit or delete) all the existing schedules created by any user.

Administrators assign various permutation and combinations of these accesses to different sets of users and roles based on the business requirements.

### **RBAC on license management**

Access to license management is deny all and allow by exception based on roles and domains as defined in RBAC.

Only those users with access to license management permission are able to update the license from the Control Room. A common license exists for all the users across Automation 360 for a

specific Control Room. The updated license is effective for all the Bot Creators and Bot Runners registered with the corresponding Control Room.

## Bot execution access by dynamic access token

The Control Room implements and enforces a Trusted Path for registration and authentication of Bot Creators and Bot Runners in accordance with NIST SC-11 to protect against any attempt to execute unauthorized bots.

The Control Room issues new client access tokens or identifiers through hashing, signed by the Control Room and sent to Bot Creators and Bot Runners over HTTPS. Every subsequent communication between Control Room and Bot Creator or Bot Runner is serviced by the Control Room after validation of the signature of the latest access token sent by the Bot Creator or Bot Runner. Each access token is unique to every Bot Creator or Bot Runner. This ensures that even if an unauthorized user could bypass enterprise security and access the system, the Control Room security restricts any damage.

## Secure credential store through Credential Vault

The Automation Anywhere platform provides a centralized Credential Vault to securely store all credentials and provision them to bots on an on-demand basis.

Use the Credential Vault to store other information deemed confidential or sensitive. The credential store implements NIST controls IA-2 to uniquely identify and authenticate organizational users (or processes acting on behalf of organizational users).

Sensitive information does not have to be stored in bots or on Bot Runner systems, the Credential Vault facilitates a logical separation of credentials from the bots.

Credential Vault variables (credentials) are created in the Control Room. They are available to the Bot Creators and Bot Runners who are assigned roles that provide them access to the lockers that contain the credentials.

The Credential Vault adds flexibility and dynamic character to bots because only the credential references are present in the bots, and not the credentials. When bots are moved from one environment to another environment, absolutely no change is required in the bots. Bots can seamlessly pick up the credentials values applicable for the new environment from the Credential Vault of that environment. Additionally, the Control Room automatically stores configuration-related sensitive data into the Credential Vault by default.

## Credential Vault encryption

The Automation 360 platform offers the embedded Credential Vault and provides an extensive set of safeguards to protect data at rest and in transit, but also while it is in use on individual systems.

## Encryption keys and vault

During the Automation 360 installation process, the system generates an RSA 2048 bit public/private key pair and an AES 256 bit key. The private key of the RSA 2048 pair is referred to as the **Master Key**, while the AES 256 key is referred to as the Data Key. The **Master Key** is presented to the installing administrator for safekeeping in a physically secure location off system. The public key is used to encrypt the Data Key. Both the public key and the encrypted Data Key are then stored in the database. When in use, all keys and encrypted data are placed in encrypted secure memory using the Microsoft Data Protection API (DPAPI).



During Automation Anywhere Control Room startup or reboot, the administrator is prompted to supply the **Master Key**. The encrypted Data Key is retrieved from the database and decrypted using the **Master Key**. The Data Key is now ready for use. As the system stores and retrieves data from the Credential Vault, the Data Key is used to encrypt and decrypt that data.

vault is used to store all system managed credentials and critical system configuration data. It can also be used to store any other sensitive data used in an organization's automations. As a result, bot builders can avoid the insecure practice of hard-coding credentials and other sensitive data/arguments directly within their automations.

Multi-layer authentication and fine-grained access control are essential for a tightly controlled environment. So is end-to-end data protection, which is also necessary to maintain the confidentiality and integrity of business-critical processes, sensitive data, and related credentials.

#### Master Key

This RSA-2048 bit key is managed and securely stored on a key management system. This key unlocks the Credential Vault. For On-Premises deployments, when the Credential Vault mode is set to manual and the Control Room cache service is restarted from all nodes, the administrator types the **Master Key** each time the Control Room is started. When the vault is open, the **Master Key** is immediately erased from memory and it is not stored anywhere in the Automation Anywhere platform.

---

#### Note:

- On-Premises: Customers own the **Master Key** and need to ensure that the key is securely stored and maintained.
- Cloud: Automation Anywhere owns the **Master Key** and ensures that the key is securely stored and maintained.

#### Data encryption key

This AES-256 bit key is stored in the Control Room database and is used to encrypt and decrypt the credentials at the time of storage or provisioning. This key is encrypted using the **Master Key**. The Data encryption key does not leave the Credential Vault at any time. Credential encryption and decryption are done at the Credential Vault.

## Protection of data at rest

In addition to encrypting local credentials and selecting runtime data used by bots, the Credential Vault provides secure storage for sensitive configuration parameters and details pertaining to the integral version control and email services.

## Credential storage

All sensitive data is stored in the Credential Vault using AES-256 encryption.

These credentials are encrypted by the Credential Vault service to conform to NIST SC-28 and to prevent unauthorized access or disclosure of credentials. Only encrypted credentials travel from the Control Room to the Database server and are stored in the database in an encrypted form. The data encryption key encrypts all credentials using an AES 256-bit key generated by a FIPS 140-2 Level 1 validated module to meet the NIST IA-7, SC-12, and 13 requirements for implementation of mechanisms for authentication to a cryptographic module that meets the requirements of applicable federal laws.

The data for user credentials for autologin to Bot Runners is also encrypted and securely stored in the Credential Vault with the bot credentials.

## Credential provisioning to bots

Credentials are provisioned only during the execution of automation.

Bot Runners or bots do not store credentials locally. Credentials are provisioned only during the execution of the automation. When the credentials are requested by Bot Runners, encoded (64 bit) credentials travel from the Control Room to Bot Runner over HTTPS protocol. When the bots finish execution, credentials are erased from the memory.

## Secure recording

You can enable or disable image captures of business applications by setting up secure recording in the Control Room.

### Overview

When secure recording is enabled, Bot Creators or Bot Runners cannot capture the application images, values, or texts. As a result, no sensitive data is (intentionally or unintentionally) stored in the bots in the form of images. The remaining automation data, for example, UI object details are captured, and they continue to be captured so that the automation can work seamlessly.

As an administrator, you can apply this setting from the Control Room for all Bot Creators and Bot Runners (for all users or for specific user roles).

### Set up secure recording

1. Log in to the Control Room as an administrator.
2. Navigate to **Administration > Settings > Bots**.
3. In the **Secure recording** section, click **Edit** to configure the settings.
4. Select **Enable**.

The default value is **Disable**.

5. In the **Recorder preview image** tab, select one of the following options:
  - **Enabled**: A preview of the image is shown in the Bot editor when the object is captured but discarded after you refresh the Bot editor. The image is stored in the Control Room and deleted after 60 minutes.
  - **Disabled**: Image is not captured and not stored in the Control Room.

**Secure recording**

When Secure Recording is on, images and control values will NOT be captured during business process recording by Bot creators. Recommended when you are automating secure applications (e.g. Bank accounts).

Enable  Disable

**Recorder preview image**

Enabled  
Preview image is available in the Bot Editor when objects are captured but discarded after save

Disabled  
Preview image is not available and will not be stored in Control Room

6. Choose the settings based on your requirements:

Option	Action
<b>All users</b>	Select this option to enable secure recording for all users who have access to the product.
<b>Users with selected roles</b>	To enable secure recording for users with specific roles: <ul style="list-style-type: none"> <li>a) From the <b>Available roles</b> column, search and select roles for which you want to enable secure recording.</li> <li>b) Move these roles to the <b>Selected</b> column.</li> </ul>

7. Save your changes.

## Authentication with Control Room

When a Bot Creator or Bot Runner tries to connect to Control Room, the credentials are encrypted using AES (256 bits key length) and RSA (2048 bits key length) and then transmitted on top of the existing layer of Transport Layer Security (TLS).

This extra layer of message level encryption provides protection against network stack issues (such as Heartbleed where OpenSSL was leaking sensitive data from memory) and also adds protection to the last hop of the connection when TLS is terminated at the load balancer. These credentials are decrypted by Control Room and authenticated against the hashed (PBKDF2 and HMAC SHA512 algorithm) user passwords or against via Lightweight Directory Access Protocol (LDAP).

## Supported authentication methods for On-Premises Control Room

Review the authentication methods supported for an On-Premises Control Room.

### Supported authentication methods

**Note:** Integration of LDAP with a load balancer for Active Directory using Kerberos authentication is not supported.

- Active Directory using LDAP

- Active Directory using Kerberos
- SAML
- Local authentication using a database

The benefits of integrating with Active Directory are as follows:

Easier adoption	Integrates with an existing authentication solution, compliant with the standards.
Maintenance	All passwords and password policies are centrally administered.
Better user experience	Fewer passwords to remember.

Kerberos provides additional benefits over NTLM pass-through authentication.

- Open standard versus closed proprietary standard
- Mutual authentication of client and server
- Integration with smart cards for 2FA

Local authentication manages user passwords through the Credential Vault. Passwords are hashed using the HMACSHA512 algorithm, which is keyed by the output of the Password-Based Key Derivation Function (PBKDF2). User passwords are encrypted in transit through TLS 1.2.

All authentication and session management is handled through the well-tested Spring Security framework. Kerberos integration is provided through the well-tested Waffle framework. SAML integration is provided through the well-tested OneLogin framework.

## Active Directory integration for authentication

Automation 360 offers seamless integration with Microsoft Windows Active Directory for access to the Control Room, Bot Creators, and Bot Runners.

When the Control Room is integrated with Active Directory, all the Active Directory users with basic details are directly available in the Control Room without any extra configuration. For Active Directory integration, user passwords stay only in the Active Directory and are not saved in the platform.

In addition to Active Directory authentication, the Control Room has its own controls to prevent unauthorized access to any automation data. See [Dynamic access token authentication of Bot Runners](#) on page 1048.

Bot Runner users can also configure their Active Directory credentials for Bot Runner machine autologin. These credentials are saved in the centralized Credential Vault.

## Multi-domain Active Directory support

The Automation 360 platform architecture supports multi-forest, multi-domain Active Directory integration. Multi-forest, multi-domain integration requires trust relationships between the forests and the domains. See [Configure Control Room for Active Directory: auto mode](#) for details.

Automation 360 On-Premises can be configured with an Active Directory global catalog server in a way that the Control Room, Bot Creators, and Bot Runners can all be in the same or different Active Directory forests and domains. This gives added flexibility and control for large-scale complex deployment where users are spread across geographies.

Multi-domain support is provided out-of-the-box and no additional configuration is required. User provisioning in an On-Premises Control Room from different Active Directory domains is also seamless. It enables the On-Premises admin to centrally orchestrate the digital workforce running across the globe.

## Support for secure protocols

The Automation Anywhere platform supports secure protocols (TLS 1.2 and TLS 1.3).

- Deployment of bots from the Control Room to remote Bot Runners is done over secure communication.
- Upload and download of bots from the Bot Creator to the Control Room is done over HTTPS.
- Transfer of any information from the Control Room to the database and vice versa is done over secure communication.
- Transfer of encoded credentials from the Control Room to Bot Runners is done over HTTPS.
- WebSocket communication with the real-time data service in the Control Room is done over HTTPS.

## Network security overview

All communication between the Control Room, Bot Creator, and Bot Runners is done using outbound communications WCF TLS 1.2 or later versions and inbound communications HTTPS TLS 1.2 or later versions.

Bot deployment to remote bot runners, provisioning of credentials, automation scheduling, and event capture are done exclusively through the Control Room. Use only HTTPS in the production environment.

- The REST APIs use Distributed Cache Service to get shared cached data required for specific functionality.
- The Scheduler Service makes REST API calls to run a task on a specific client machine at a specific time.
- Real-time Data Service makes REST API calls to authenticate incoming connection requests. It receives task execution progress updates by Bot Runners and sends that information to all connected browser clients using WebSocket Secure (WSS) protocol.
- The Control Room makes REST calls for user authentication and repository operations, for example, upload a task, download a task, or compare two tasks.
- The Control Room makes REST calls to the validate user session at regular intervals. The Control Room deploys and runs a task on a specific device using Bot Agent. It uses a TCP/IP channel.
- The Scheduler Service makes REST calls for autologin credentials. It also communicates to the Control Room to get a license and user session-related information.
- The Control Room makes REST calls to get autologin credentials for a logged-in device. It also communicates to the Control Room to get the license and user session-related information.

## Change management

Access restrictions for configuration management.

### Baseline inventory controls for Bot Creators, Bot Runners and bots

The Control Room provides a single-pane-of-glass on all automation operations and infrastructure, providing a way to baseline the configuration of the environment. Inventory controls are maintained through the application of RBAC and the use of the Bot Repository, Operations Room, and License Management to establish a single point of control for Base Line Configurations (NIST CM 2) access restrictions for configuration management (NIST CM 5 and 6). Configure automated baseline reporting using the auditing and reporting systems in the Control Room.

### Change control and documentation RBAC

The Control Room RBAC provides a point of access control and management for all changes to the Control Room, Credential Vault, Bot Creators, bots, and Bot Runners with an automated mechanism to prohibit changes and report on any attempts to make unauthorized changes. The logging and auditing system on the Control Room provides the reporting mechanism for change management to conform to best practices as described in NIST CM-3 through 5.

### Software usage and license management

The Control Room provides an automated mechanism for tracking and controlling the use of licensed software across Bot Creators and Bot Runners, addressing NIST Change Management CM 10.

### Dual authorization change management

Separation of duties is implemented at multiple levels. Dual authorization is achieved through separation of control planes for the Bot Creators and Bot Runners. Only bots created by an authorized Bot Creator can be executed by a separately authorized Bot Runner and only by a user who has been given the privileges to do so by an administrator.

### Identity and authentication

All automation actions, for example, create, view, update, deploy, and delete, across Automation 360 are done only after Control Room authentication is successfully completed.

After authentication is successful, the platform applies a second mandatory level of access control enforcement in the form of fine-grained Role-Based Access Control (RBAC).

The Control Room has its own controls to prevent unauthorized access to any automation data.

### Password hashing

Password hashing does a one-way, permanent transformation of the passwords of the Control Room users, inline with standard password management practices.

Control Room passwords are concatenated with a salt and then hashed using the PBKDF2WithHmacSHA512 algorithm before being stored in the database.

- The salt is 256 bits in size and is randomly generated by a cryptographically secure PRNG.
- The HMAC SHA512 algorithm is used for hashing and provides additional security over traditional approaches.
  - A keyed hash provides protection against hash length extension attacks.
  - SHA 512 bit key is larger than the commonly used SHA 256 bit key.
- The key used for the HMAC is from the secure Password-Based Key Derivation Function (PBKDF2).
- Hashing is done for 100,000 rounds (based on NIST recommendations).

Every time a Bot Creator or Bot Runner authenticates against Control Room, its credentials are authenticated against the hashed credentials.

### Secure authentication

If an authentication attempt fails, the Automation 360 platform does not specifically state if the username or password is incorrect. It only states that the supplied credentials are incorrect.

This is one critical information security requirement for Automation Anywhere customers and defends the system against a brute force attack.

This authentication involves the following:

- Bot Creator, Bot Runner connection to Control Room
- User log in to the Control Room from the browser
- Connection from the Control Room to the SQL Server

All failed authentication attempts are logged. See [Audit log](#) on page 2143. Audit Log access is provided as per RBAC and audit logs are made available on a read-only basis for all users.

### Authentication for Bot Runners

Two layers of authentication are present for deploying the bots on remote Bot Runners.

The Bot Runner is logged on/connected/unlocked using the configured credentials. These credentials are fetched from the centralized Credential Vault over HTTPS. This first level of authentication is done against the domain automatically, on behalf of the user and is called Bot Runner autologin.

After being authenticated, Bot Runners can be authorized to execute bots independently and asynchronously.

The following table shows what happens to the user session on the Bot Runner after bot deployment.

User session status before bot deployment	During deployment	User session after bot execution finishes
No session exists	Create a new session and deploy the bot	Log off
Unlocked	Deploy the bot	Session remains unlocked
Locked	Unlock the session and deploy the bot	Session is relocked

User session status before bot deployment	During deployment	User session after bot execution finishes
Disconnected	Unlock the session and deploy the bot	Log off

### Dynamic access token authentication of Bot Runners

The Control Room implements and enforces a Trusted Path for registration and authentication of Bot Creators and Bot Runners in accordance with NIST SC-11.

The Automation 360 platform protects the automation data against any attempt to subvert the path. The Control Room issues new client access tokens, or identifiers, after a predefined time period. These tokens are protected to conform to NIST IA-5 by being signed by the Control Room and sent to Bot Creators and Bot Runners over HTTPS. Every subsequent communication between the Control Room and Bot Creator/Bot Runner is serviced by the Control Room only after validation of the signature of the latest access token sent by the Bot Creator/Runner.

The access token is unique to every Bot Creator/Bot Runner. This protects the system from an unauthorized attempt to bypass security and execute an unauthorized bot, and is consistent with the best practices to conform to NIST IA-9 Service Identification and Authorization. These controls implement IA-3 for cryptographically based bidirectional authentication and attestation of Bot Runners and Bot Creators before establishing connections. This also addresses requirements around unique, automated, identifier management IA-4 for multiple forms of authorization and identification. Identifiers are dynamically managed for audit and control purposes. Identifiers are used as authenticators and managed for verification on initial deployment, revoke, and prevent reuse. There are no static, unencrypted, identifiers in use by Bot Creators or Bot Runners and cached tokens are cleared periodically.

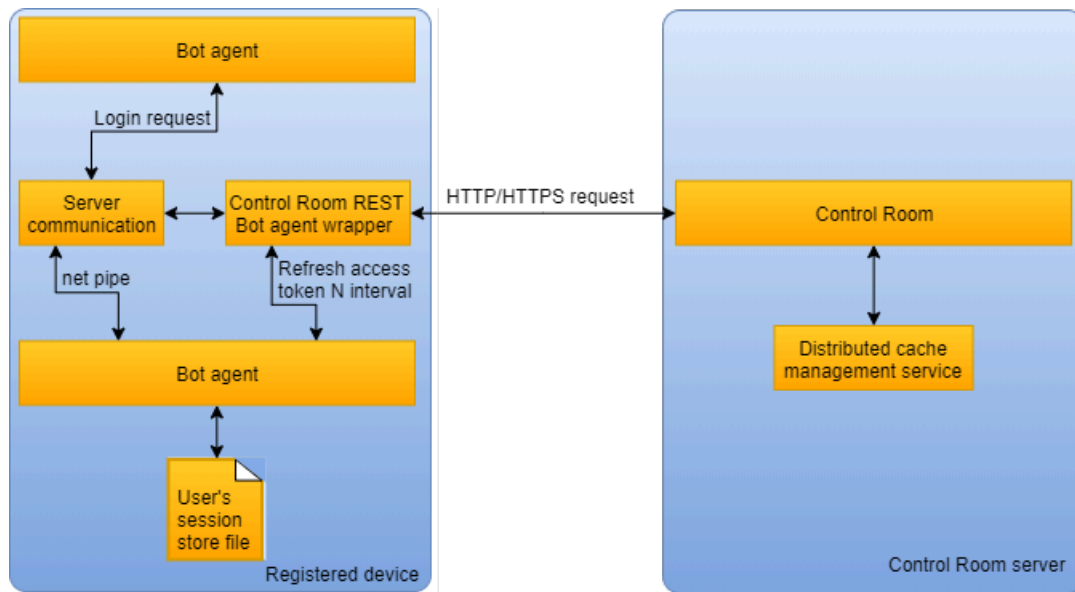

### Defenses against common vulnerabilities

The Automation 360 platform provides some defenses against common attacks on applications.

The list below contains several examples of these attacks and the security controls in place to prevent them.



## SQL Injection (SQLi)

SQL injection is a high-risk vulnerability that can seriously impact the confidentiality, integrity, and availability of a database. It enables an attacker to execute any SQL of his or her choosing inside the DB, thus allowing them to read sensitive data, modify/insert data, and execute various operations.

The Control Room prevents SQL injection using query provided by the Hibernate framework.

## Cross Site Scripting (XSS)

Cross-site scripting is a high-risk vulnerability that can seriously impact the confidentiality, integrity, and availability of any user web session. It enables an attacker to execute any JavaScript inside the victim's browser, allowing them to spy on the user's input/output or take unauthorized actions on behalf of the user. They could also redirect the user offsite to a malicious malware download or a credential phishing page.

The Control Room prevents cross-site scripting using automatic output encoding provided by the ReactJS framework.

## OWASP Top 10

Automation Anywhere provides the following controls to protect against the OWASP Top 10:

Risk	Control
A1: Injection	All input is escaped before commands or queries are executed.
A2: Broken authentication and session management	See the identification and authentication section.
A3: Cross-site scripting	All output is encoded before being returned.
A4: Insecure direct object references	Centralized authorization via Spring Security.
A5: Security misconfiguration	No default passwords, stack traces hidden, secure server configuration
A6: Sensitive data exposure	See the Security at rest and Security in motion sections
A7: Missing function level access control	Centralized authorization via Spring Security
A8: Cross-site request forgery	Using authorization HTTP header
A9: Using components with known vulnerabilities	Black Duck software composition analysis tool
A10: Unvalidated redirects and forwards	N/A - No redirect functionality present

## Compliance and vulnerability scanning

Review details about Automation Anywhere compliance and vulnerability scanning.

### Secure software development life cycle (S-SDLC)

Automation Anywhere has implemented a development security plan and protocol that defines a specific depth of testing and evaluation to be done by the Engineering team on each release, conforming with best practices as defined by NIST SA-11 Developer Security Testing and Evaluation and NIST SA-15, Development Process, Standards, and Tools. This plan has been documented and shared with the Automation Anywhere Engineering teams.

### Veracode vulnerability scanning for static and dynamic code analysis

In each weekly build, during the development process and before every release, all Automation Anywhere software is scanned for flaws using the Veracode tool. Automation Anywhere Enterprise meets the requirements for the strictest security policy available in the tool, Veracode Level 5, which is defined as no Very High, High, or Medium severity vulnerabilities. Analysis reports are available with each release.

### Dependency analysis

In each weekly build, during the development process and before every release, all of the third-party libraries and dependencies in Automation Anywhere software are scanned for known vulnerabilities using the Black Duck tool. Automation Anywhere upgrades vulnerable libraries when new versions become available. Analysis reports are available with each release.

All Critical/High vulnerabilities are fixed for each release. Medium vulnerabilities will be considered for fixes in future releases depending on the scope of the Automation Anywhere releases. The list of OSS used by the application is published for each release.

### Penetration testing

- Automation Anywhere gets a penetration (PEN) test performed by a third-party external vendor for detecting security vulnerabilities in the product at least once a year. The frequency of the penetration test can be more than once a year and depends on the scope and product design changes.

Automation Anywhere publishes the test report and summary of the observation status on the Automation Anywhere compliance portal. See [Compliance Portal](#).

- Automation Anywhere does internal penetration test of the product for every release by in-house security penetration experts to keep a track of the security risk in the product.

## Cryptographic providers

Use only the listed supported cryptographic providers.

### Control Room

Cryptographic Provider	Supported Version
AES-256	All Bouncy Castle FIPS versions mentioned in the Automation Anywhere Open Source Software (OSS) Notice
AES/CBC/PKCS5Padding	
ECDH/AES/GCM/NoPadding	
HMAC-SHA256	
PBKDF2 with HMAC-SHA512	
RSA-2048	
RSA/ECB/OAEP with SHA-256 and MGF1 Padding	

See: [Compliance and vulnerability scanning](#) .

## Cryptographic ciphers

Cryptographic ciphers are used to encrypt data to protect the confidentiality, integrity, and availability of the data.

Use only the listed supported cryptographic ciphers.

**Note:** Cloud deployments support TLS 1.2 and later versions.

- AWS supports only TLS 1.2 version.
- Google Cloud Platform (GCP) supports TLS 1.2 and later versions.

The following table provides the list of cryptographic ciphers supported on Cloud:

Cloud providers	Ciphers supported	TLS version supported
AWS	<ul style="list-style-type: none"> <li>• ECDHE-ECDSA-AES128-GCM-SHA256</li> <li>• ECDHE-RSA-AES128-GCM-SHA256</li> <li>• ECDHE-ECDSA-AES256-GCM-SHA384</li> <li>• ECDHE-RSA-AES256-GCM-SHA384</li> </ul>	TLS 1.2

Cloud providers	Ciphers supported	TLS version supported
GCP	<ul style="list-style-type: none"> <li>• TLS_ECDHE_ECDSA_WITH_AES_128_GCM_SHA256</li> <li>• TLS_ECDHE_ECDSA_WITH_AES_256_GCM_SHA384</li> <li>• TLS_ECDHE_ECDSA_WITH_CHACHA20_POLY1305_SHA256</li> <li>• TLS_ECDHE_RSA_WITH_AES_128_GCM_SHA256</li> <li>• TLS_ECDHE_RSA_WITH_AES_256_GCM_SHA384</li> <li>• TLS_ECDHE_RSA_WITH_CHACHA20_POLY1305_SHA256</li> </ul>	TLS 1.2 and later versions

The following table provides the list of cryptographic ciphers supported on On-Premises:

Ciphers supported	TLS version supported
<ul style="list-style-type: none"> <li>• TLS_ECDHE_RSA_WITH_AES_128_GCM_SHA256</li> <li>• TLS_ECDHE_RSA_WITH_AES_256_GCM_SHA384</li> <li>• TLS_ECDHE_RSA_WITH_CHACHA20_POLY1305</li> </ul>	TLS 1.2 and later versions

## Additional security controls

Automation Anywhere Control Room restricts the database connection configuration with the system administrator account.

### Restrict installation from database system administrator account

All the database level transactions are done with a nonsystem administrator account. The Control Room installer passes the SQL Server 2012 certification test.

### Autolock the device

When Automation Anywhere bots are deployed from the Control Room to remote Bot Runners, they revert the Bot Runner system to its original state. For example, if the Bot Runner machine was logged off and our bot logged into the machine, it logs it off after the automation execution finishes. This ensures that system level security is not compromised.

### Using SHgetKnownFolderPath function

Automation Anywhere software uses the SHGetKnownFolderPath function and Knownfolder\_ID to determine the full path to the special folders. This is a recommended practice from Microsoft and use of this function ensures that system will never redirect automation data to any other folder, even if someone attempts to hack the function call. This is also one of the InfoSec requirements of Automation Anywhere customers.

## **API level security**

Automation Anywhere software does authentication and authorization level checks at the API level. API calls are serviced only for those users who have permission on the automation data. Unauthorized users cannot bypass system security through rogue API calls.

## **Clean uninstall**

When Automation Anywhere Enterprise Client software is uninstalled, it leaves no trailing files or folders behind. This clean uninstall of the Enterprise Client software complies with InfoSec policies.

## **Store data in Program Data folder**

Automation Anywhere software allows storing of automation data in the Program Data folder, for the files which must be edited by end users. Permissions are also set on the directory during the installation so that the user can edit the content of the folder. This complies with the InfoSec requirements of Automation Anywhere customers.

## **Protected handling of MSVC DLL files**

Automation Anywhere Enterprise Client software uses MSVCxxx.dll files for automation purposes, but it does not install these files by itself. Client software directly uses the DLL files installed by only the Microsoft operating system. This ensures that client software does not overwrite the DLL files installed by Microsoft and our customers do not have to worry about doing one more cycle of checking for any introduced vulnerabilities.

## **Assembly manifest**

All the executables (.exe file) of the Automation Anywhere Control Room and Enterprise Client software contain the manifest files which describe assembly metadata, for example, filename, version number, and culture. This makes our platform comply with organizational InfoSec policies.

## **Application path on network**

Automation Anywhere supports configuration of reading and writing automation data to a location on a network drive. This enables users to keep all automation data at one place.

## **Autologin without disabling legal disclaimer**

When Automation Anywhere bots are deployed from the Control Room to remote Bot Runners, our customers do not need to change security settings, for example, disable login page or disable legal disclaimer. Automation deployment works seamlessly without disabling these settings.

## Secure Java automation

The Automation Anywhere platform can securely automate even those difficult-to-automate business applications which download the Java runtime environment (jre) during automation execution. Whenever these applications are started, an Automation Anywhere agent gets associated with Java executable noninvasive and automates the business application. After the automation finishes, the Automation Anywhere agent is automatically terminated.

## Automation in nonEnglish languages

Users can securely use German, French, Italian, and Spanish language keyboard characters through the embedded automation commands in Bot Creators. This enables users to write data into these languages. Automation Anywhere customers do not need to depend on less secure third-party libraries for this automation.

## General Data Protection Regulation compliance

The General Data Protection Regulation (GDPR) is one of the strictest compliance frameworks for maintaining privacy of personal data. The GDPR defines personal data as any data that can be used to identify a natural person (Data Subject).

To generate a GDPR compliance report for a user, see [Compliance reporting](#).

For the most current description of Automation Anywhere GDPR compliance statement, see [Cloud Automation Agreement](#) and [Privacy Policy for Automation Anywhere](#).

# Automation 360 Cloud for secure access and connectivity

You can develop and run bots securely using the Automation 360 Cloud access security.

## High-level architecture of Cloud deployment

The following information provides a high-level workflow of the Automation 360 Cloud deployment:

1. Using a browser, you log into the Control Room and create users and roles. You perform this process on the Automation 360 Cloud.
2. You install the Bot Agent on your Windows device to run bots locally. You perform this process on your infrastructure.
3. Data flow between the Automation 360 Cloud and the Bot Agent on your Windows device on your infrastructure is encrypted using TLS 1.2 (outbound port 443 only).

The following image shows the Automation 360 Cloud architecture:

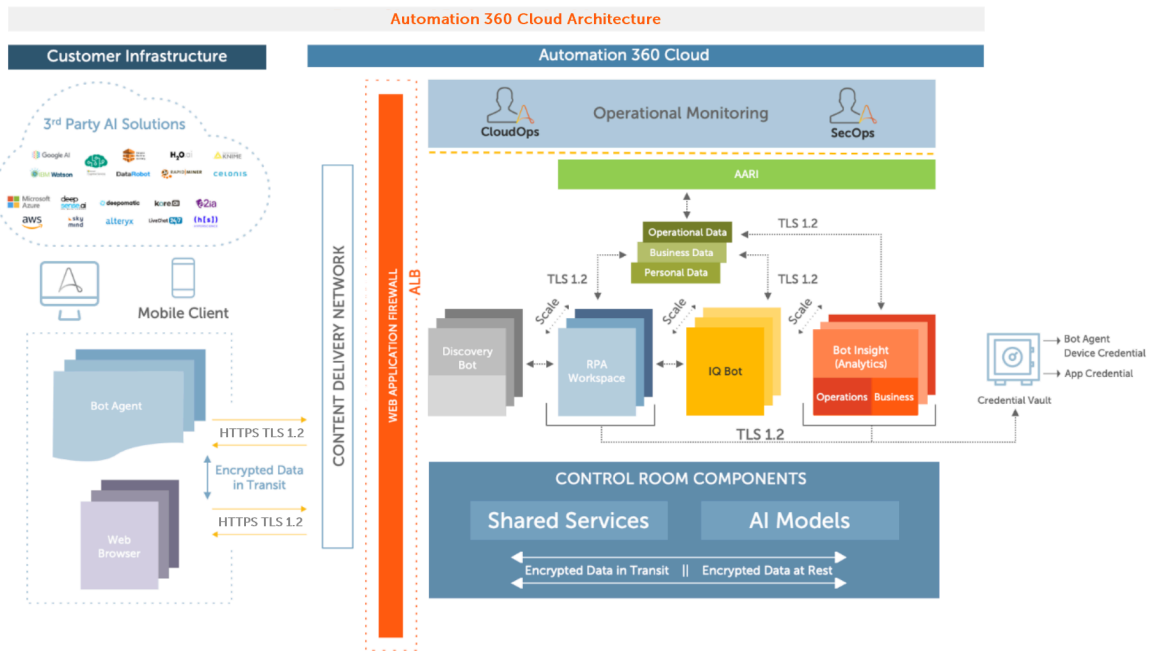

## Identity and Access Management (IAM) security for user system

- When an admin user logs into the Automation 360 Control Room for the first time, the admin can configure SAML 2.0 to connect the Automation 360 Cloud Control Room to their own Identity Provider (IdP) so that their users can log in to the Control Room using MFA (multi-factor authentication).
- The admin can then create the required users and roles or permissions to perform certain activities (such as developing and running bots) in the Control Room.
- The Automation 360 Control Room users can then log in through MFA and start creating and running bots.
- Additionally, the admin can configure an allowed IP address range to manage user logins through the Administrator settings in the Control Room.

To learn more about Automation 360 Cloud, see [Get started with Automation 360 Cloud](#) on page 1165.

## Secure connectivity to run bots

You run bots locally on a Windows machine on which the Bot Agent is deployed. You can download and install the Bot Agent on your devices or deploy to a pool of virtual machines.

Before you install the Bot Agent, the following criteria must be met:

- The integrity of the device on which the Bot Agent is installed is not compromised.
- The user organization has instituted security safeguards and controls to prevent Bot Agent takeover and system-level user breaches.
- The user environment is safe from network-based attacks such as Domain Name System (DNS) cache poisoning, Address Resolution Protocol (ARP) spoofing, and so on.

**Note:** Automation 360 Cloud includes security operation controls to check for man in the middle (MITM) attacks and malicious intercepts.

---

#### Bot Agent installation and registration

When you register your device, the Bot Agent device is provided a JSON Web Token (JWT) to start the registration process with the Control Room. If the token provided by the Bot Agent device does not match the token provided by the Control Room, the registration process will fail. This authenticates the client Bot Agent device to the Control Room.

In the bulk installation and registration mode of the Bot Agent, the Bot Agent device comes online preregistered with the Control Room URL specified in the `autoregistration.properties` file. When using the bulk registration settings, one cannot enter or specify a fake Control Room URL without administrator privileges on that device. When the Bot Agent starts for the first time, it will read the `autoregistration.properties` file and register itself to the Control Room URL specified in the properties file. By default, the option to switch the Bot Agent registration from one Control Room to another is disabled. Only the Control Room administrators can enable this option. If someone tries to register another URL when this option is disabled, the registration would fail immediately and generate an error mentioning that says Control Room is already registered and switching of the Control Room URL is not allowed.

By providing write access to a cache folder for the admin only and read permissions to all other users who can run bots, we can assure that when a bot is downloaded to the device cache, it cannot be manipulated to perform potentially harmful things.

#### Communication between Bot Agent and Control Room

The Bot Agent device establishes a websocket connection to the Control Room using HTTPS (outbound port 443) and no inbound connection is required.

- **Server authentication:** The Transport Layer Security (TLS) handshake ensures that the Common Name (CN) in the server certificate issued by the well-known certification authority (CA) matches the legitimate hostname as included in the certificate chain of trust.



- Client authentication: After registration, a valid token key is always required from the Bot Agent to establish a connection to the Control Room. The token is encrypted using the Bot Agent private key and can only be decrypted by using the Bot Agent public key that was used when the Bot Agent device was registered to the Control Room. The token also authenticates the Bot Agent device every time the Bot Agent connects to the Control Room.

Data connection between a customer's network and the Cloud service is protected with a strong TLS connection that leverages at least 2048-bit RSA server certificates, 128-bit symmetric encryption keys, and stronger TLS protocols. This secure connection makes it virtually impossible to breach the established TLS connection.

After the websocket connection is established, the communication between a customer's network and the Cloud service is secured and bidirectional. The connection between the Bot Agent device and the Automation 360 Cloud hosted Control Room is permanent and automatically reestablished if connectivity is lost. This connection is used to download the bots to run and send operational status information to the Control Room.

---

**Note:** The connectivity is established only one time and not for each bot.

---

Schedule bots to run

Control Room users can schedule bots to run. Compiled bots are downloaded to run on the Bot Agent devices and operational logs are sent from the Bot Agent devices to the Control Room.

For the bots to run, the Bot Agent establishes an active Windows session by authenticating as the licensed Bot Runner user on the Bot Agent device.

Secure credentials for bots

Bots that run on the Bot Agent devices need to log in to the device using credentials. You can store credentials securely in the Automation 360 Cloud Control Room credential vault. Alternatively, you can store credentials in a customer-hosted key management system (for example, CyberArk). When you store credentials in the customer-hosted key management system, you must have connectivity between

the Control Room and the customer's key management system. To provide connectivity and allow access, you must configure the Automation 360 Cloud IP addresses for the specific Automation 360 Cloud region that is hosting the Control Room in their firewall. For more information, see [Control Room IP addresses for external integrations](#) on page 1829.

## Secure operations in Automation 360 Cloud

Automation 360 Cloud is run securely and meets compliance standards for: SOC 1, SOC 2, ISO 27001, and HITRUST.

- For information about Automation 360 Cloud deployment and operational models, see [Automation 360 Cloud Security and Data Privacy](#).
- For Automation 360 Cloud compliance reports, see [Compliance Portal](#).

## Automation 360 Cloud FAQ

Answers to frequently asked questions (FAQ) and related information provide insight into various aspects related to Automation 360 Cloud.

Where can I find an overview of Automation 360 Cloud security?

An overview and details about Automation 360 Cloud security can be found in this document: [Automation 360 Cloud Security and Data Privacy](#).

As a customer, how can I start using Automation 360 Cloud?

The prerequisites and additional, optional steps for getting started can be found on the Automation Anywhere documentation portal at the following location: [Get started with Automation 360 Cloud](#) on page 1165.

For most customers, the basic requirement is to allow secure access, using HTTPS, to their new Control Room environment hosted on Automation 360 Cloud. If this is not already enabled, you need to open port 443 in your firewall to allow outward HTTPS communication from your browser and the Bot Agent to the Control Room. After the Bot Agent is installed, it establishes a web socket connection to the Control Room. No ports need to be open on the customer site for these inbound connections.

Does Automation 360 Cloud provide a service-level agreement (SLA) for service availability?

Yes, an SLA for 99.9 percent monthly availability is provided for the customer's access to their production Control Room environment. The

SLA does not include planned downtime for maintenance and updates to the service. If a customer believes that the SLA has not been met, a service credit can be claimed through Support. Details can be found in our [Availability Service Level Terms](#).

How does Automation 360 Cloud support high availability (HA)?

Each customer's Automation 360 environment is deployed using application load balancing across highly available public Cloud infrastructure services. The infrastructure services support both microservices running on Docker containers in Kubernetes clusters and datastores (database, cache, logging, file system, storage) supporting HA across multiple zones within a region. Both AWS and GCP public clouds are used.

Does Automation 360 Cloud support disaster recovery (DR)?

Yes, Automation 360 Cloud supports DR. Under a disaster recovery scenario the customer's tenants will be brought up in another region using the same URL and their Bot Agent will reconnect automatically. In case of major incidents, where imminent resolution seems unavailable, a disaster situation is declared and all the tenants within the region affected by the incident are failed over to another, remote region. The current objectives for this recovery are as follows:

Recovery Time Objective (RTO)	The time taken to get a new region up and running with the last backup data restored is 4 hours.
Recovery Point Objective (RPO)	The maximum duration for data loss during a restore is 4 hours.

---

**Note:** RPO is based on backups taken and pushed to another backup region.

---

Do all customers receive notifications about upcoming general releases from Automation Anywhere via email?

All Cloud and On-Premises customers receive general release announcements from Automation Anywhere via email. The release announcements are sent two weeks before the release date. Additionally for Cloud customers, the announcement is also sent to

	<p>the administrators who registered when first provisioning the Control Room.</p>
<p>How do customers determine what region their Control Room is in?</p>	<p>A Customer License User (CLU) can log in to the Control Room and find the region where Control Room is hosted. To find the region, navigate to the <b>License and Cloud Services</b> portal on the A-People site and click the <b>Cloud Control Room Instances</b> tab. For more information, see <a href="#">Licenses and cloud services</a> on page 1404.</p>
<p>Are there maintenance windows for the Automation 360 Cloud?</p>	<p>Yes, Automation Anywhere updates Automation 360 Cloud every 3 months so that customers will receive automatic and regular updates to the latest software version. For more information, see <a href="#">Automation 360 software lifecycle policy</a> on page 1076.</p> <p>The primary channel for communicating the timing of Cloud status and maintenance windows is the <a href="#">Automation 360 Cloud Service Status site</a>. You can subscribe to this website and receive the updates. Note that you cannot choose when the updates are rolled out across the multitenant Cloud. The Automation 360 architecture is designed to allow these timeless updates to roll out without affecting customers' bot development lifecycles.</p>
<p>As a customer, what actions should I take to plan for an Automation 360 maintenance window?</p>	<p>A customer's bot operations should take account of scheduling bots to run outside of the published maintenance windows. These updates are scheduled to run outside of normal business hours on the same day and time per region, and focuses on mid-month, avoiding month ends. More details guiding customers on planning around maintenance windows can be found on this KB article: <a href="#">Automation 360 Cloud updates</a> on page 1072.</p>
<p>Is customer data stored on the Automation 360 Cloud?</p>	<p>Yes, basic automation processes allow customers to keep customer business data on their own infrastructure using careful bot design. However, Automation 360 applications increasingly store customer data on the Cloud. Several Automation Anywhere products store customer data as part of customer-defined automations, although typically only temporarily, that is, during the automation process defined by the customer.</p>

For example:

- IQ Bot use typically involves uploading images for processing.
- Recorder and AISense Recorder store recorded screenshots.

---

**Note:** Secure recording can be enabled by administrators to ensure that these are not stored.

---

- AARI stores data processed by attended forms.
- Bot Insight can be used to create dashboards made from tagged business data being processed by a bot.
- WLM stores Work Items in its queues.

The customer has control over what business data is stored on the Automation 360 Cloud. Note that the source data remains with the customer, and the customer is in control of deleting the data on the Automation 360 Cloud. In general, the business data a customer keeps in our Cloud through the use of bots is for automation purposes only and can then be deleted. The primary storage for the data is not on our Cloud. Customers might need to keep audit logs and dashboard data. Both of these can be exported.

What is the Automation 360 Cloud Data Retention Policy?

During a customer's subscription period, data on the Automation 360 Cloud is in their control. Audit logs have a retention policy maximum of 270 days.

Backups are taken every 4 hours and kept for seven days. After a subscription ends, according to our retention policy, data is held for another 30 days, to allow for renewal or recovery of bots and reports, and is deleted after that. After 60 days, the entire tenant environment is deleted.

Is data stored on the Automation 360 Cloud using common storage infrastructure?

Yes. The data storage services used by Automation 360 Cloud are shared across customers as part of the multitenant design. In this way, the infrastructure and operational costs are not passed on to our customers. Automation Anywhere applications use a unique tenant ID to ensure that data access is logically segregated by tenant. No data processing or storage operations can expose the data of one customer to another customer.

Can Automation Anywhere personnel access customer data stored on the Automation 360 Cloud?

Yes. However, operational controls governed by Automation Anywhere compliance certifications ensure that such access is limited to a well-defined set of individuals in CloudOps, SecOps, and Support organizations under strict separation of duties. Customer data will be accessed only based on a customer granting permission in order to resolve a support case.

What compliance covers Automation 360 Cloud?

CloudOps is governed by the following certifications based on third-party audits: SOC 1 Type 2, SOC 2 Type 2, ISO 27001, and HITRUST

The Automation Anywhere Business Continuity Management system is also certified with ISO 22301.

Customers rely on industry standard certifications for regulatory and compliance reasons. SOC 2 is created by the American Institute of CPAs (AICPA), and it measures IT security controls. The SOC 2 Type 2 certification verifies that Automation Anywhere CloudOps and SecOps teams have taken the appropriate controls and have put operational processes in place to meet industry standards for secure Cloud operations.

What is the timeline and validity for the Service Organization Controls (SOC) attestation reports?

Automation Anywhere conducts SOC 1 and SOC 2 audits annually inline with Trusted Service Criteria (TSC) defined in the SSAE 16 standard. The SOC 1 and SOC 2 reports cover the audit period from November 1st to October 31st.

---

**Note:**

- SOC reports are evidence-based and backward-looking for the audit period. That is, auditors collect evidences on how the controls performed over the duration of the audit period to provide their opinion.
- A SOC report is valid for one year time period.
- Automation Anywhere maintains a Type 2 report that provides reasonable assurance of the operating effectiveness of our internal control structure.

- SOC 1 and SOC 2 reports are issued approximately two months after the end of the audit period.

Are the compliance certifications and summary reports for the certifications available for customers to review?

Yes, customers can now access the various summary reports and certifications on the [Compliance Portal](#) under NDA.

How does Automation 360 Cloud support GDPR and an individual's privacy?

Automation Anywhere has put processes in place to handle individuals' data privacy rights, and reviews them on a regular basis to ensure GDPR compliance. For more information, see our [Privacy Policy](#).

Do Automation Anywhere personnel monitor an Automation 360 Cloud tenant's environment?

Yes. All infrastructure and application-level audit logs are monitored to ensure the correct operation of the environment under load. This way, when load thresholds are reached, additional resources can be applied to ensure service availability and performance.

Does Automation Anywhere report unsuccessful data breaches to a customer?

No, Automation Anywhere reports only successful breaches to a customer when that customer's data has been compromised and on a timeline determined by local law.

What data does Automation Anywhere collect to improve the Automation 360 Cloud service?

To operate and support the service, Automation Anywhere captures logs that can include usernames from the system. These rotate and are overwritten every 30 days. Automation Anywhere collects and uses telemetry data only for purposes of improving the service. Collected telemetry data includes the following:

- Audit logs: These reflect user activities in the Control Room and applications, for example, a bot was run successfully or a user created a bot.

---

**Note:** The actual username is masked. Logs might include IP addresses, device names, and bot names.

---

- User clicks on a UX feature: Helps in providing user-specific help and guidance options to the user in the UI based on their experience.
- Where documents are uploaded for processing (for example, when using IQ Bot or AISense), Automation Anywhere may reconstruct the format of the document, without the customer's data, for the purpose of further training the Automation Anywhere

AI/ML models to recognize document fields that might contain data for extraction. This aids in improving the application's data extraction accuracy.

This telemetry data can be used to monitor the service and is visible per tenant Control Room, and in aggregate, so that feature usage and adoption can be estimated. This can be used by product management to determine which features to prioritize for improvement and to identify features or applications not being adopted. This data can also help CSMs to advise customers on unused features that they could start using and benefit from.

In which geographical region is a customer's data stored when using Automation 360 Cloud?

In general, for the pure Cloud deployment model, a customer specifies the regional location at the time of provisioning their Control Room instances, for example, US East or Japan.

Note that we cannot provide the detailed address or location of the physical data center because we use public Cloud providers, who reserve the right to move and do not disclose locations for safety and security reasons. We provide this regional capability to ensure that the Control Room is located in the same region where the customer will perform most of their operations to ensure high performance and usability and to reduce latency. For most locations, for business continuity, the disaster recovery element of the service sends data backups every six hours to another region. The other region is usually in another country.

Which regional locations does Automation 360 Cloud support?

Automation Anywhere Control Room environments can be hosted in the following regions:

Primary	Backup/DR
US West	US East
US East	US West
EU-West	EU-Central
Japan	Singapore
Singapore	Japan
Brazil	US East
Bahrain	EU-West
India	Singapore



Primary	Backup/DR
Australia	-
South Africa	EU-West
US Central	US East
EU-West4	EU-Central
Canada	-

What if the customer is concerned about data sovereignty (that is, maintaining data in a specified region)?

For customers concerned about data sovereignty, the Pure Cloud model can only guarantee that data is stored in the US, EU, and in Australia. This does not prevent the data from being accessed from outside those regions (for example, for support purposes). For the US, the DR region is kept within the US.

---

**Note:**

1. The DR service is not supported in Canada and Australia (specifically because most customers in Canada and Australia are conscious of data sovereignty).
2. For EU, we cannot guarantee that data is kept within a specific country within the EU.

Which public Cloud providers are used to deliver Automation 360 Cloud services?

Automation 360 Cloud uses Amazon Web Services (AWS) and Google Cloud Platform (GCP) to deliver Automation 360 Cloud services. Automation Anywhere decides on the default provider to use. However, if you have a strong preference for AWS or GCP, you should work with your account team to choose the preferred Cloud service at the time of closing the sales transaction. For existing customers in the US and EU who provision for a new Control Room, the new tenants are created in the same region where your other tenants are located.

---

**Note:**

- IQ Bot classic is not supported on GCP.
  - Migration of Enterprise 11 On-Premises Control Room to Automation 360 Cloud service on GCP using the Cloud Migration Utility is not supported.
-

What is a sandbox Control Room?

A sandbox is a fully functional and supported Control Room that receives new release updates at least 3 weeks prior to a customer's main Control Room for Bot Lifecycle Management (Dev/Test/Prod). The sandbox environment primarily allows customers to try out new releases and sanity-test their production bots.

---

**Note:** IQ Bot and DR are not supported on sandbox environments.

---

Is the sandbox the same as a trial environment?

No. Unlike a sandbox, a trial or proof-of-concept Control Room is provided free of charge for 30 days ahead of a sale, as part of the selling motion with customers.

## Automation 360 Cloud Service Status site

The Automation 360 Cloud Service Status site displays real-time operational status, historical operational status, maintenance information, and incident history for all Automation 360 Cloud services worldwide, across all hosting regions.

[Automation 360 Cloud Service Status site](#)

### How you can use the site

You can use the Automation 360 Cloud Service Status site to view various updates:

---

**Note:** In addition to viewing updates, you can also receive updates regarding ongoing incidents and upcoming scheduled maintenance by email or RSS feed by using the **Subscribe** option on the top-right corner.

---

- Use the **Component Summary** section to view the real-time operational status of all the Cloud services hosted from all regions worldwide.
- Use the **Component Status History** section to view the historical operational status of all Automation 360 Cloud services hosted across all regions worldwide.

---

**Note:** This historical information can be traced back for a maximum of three months.

---

- Use the **Upcoming Maintenance - Next 14 days** section to view maintenance information about ongoing and upcoming incidents for the next 14 days.
- Use the **Incident History** section to view information about incidents that are resolved and scheduled maintenance events that are completed .

---

**Note:** In the Automation 360 Cloud Service Status site and in this documentation, the term "component" refers to the Automation Anywhere service within a hosting region.

---

## Real-time operational status

Automation Anywhere frequently monitors the accessibility and health of components from various geographical regions across the world to report on the operational statuses of components in real time. The **Component Summary** section provides a real-time view of the operational status of various components.

The following table provides a list of operational statuses along with definitions and examples:

Component statuses along with definitions and examples

Component status	Definition	Example
Operational	All the services in the region are operational and available.	All the Control Room URLs are accessible, and customers can log in to their Control Room instances.
Informational	All the services in the region are operational but have an incident that does not affect customers.	
Under Maintenance	The services in the region are currently unavailable.	The service is undergoing a planned maintenance event.
Degraded Performance	There is an incident that affects performance significantly.	<ul style="list-style-type: none"> <li>The service is available, but one or more capabilities of the service are not performing optimally.</li> <li>Services in the region are occasionally inaccessible or interrupted.</li> <li>Bots in the region occasionally fail for some customers.</li> </ul>
Partial Outage	There is a major incident that affects a few customers significantly.	<ul style="list-style-type: none"> <li>Services in the region are inaccessible, or some customers (more than 25 percent of customers in the region) cannot log in to their Control Room instances.</li> <li>Bots in the region fail for some customers.</li> <li>A security or data breach has occurred for some customers in the region.</li> </ul>

Component status	Definition	Example
Major Outage	There is a critical incident with very high impact across the region.	<ul style="list-style-type: none"> <li>• Services in the region are inaccessible, and customers cannot log in to their Control Room instances.</li> <li>• Bots fail to run successfully on the Control Room instances in the region.</li> <li>• A security or data breach has occurred for all the customers in the region.</li> <li>• A Cloud region has completely failed, triggering a disaster recovery event.</li> </ul>

## Historical operational status

The **Component Status History** section provides a historical view of the availability status of all the components over the preceding seven days. You can use the **Search Components** option at the top-left corner of the section to search for the historical operational status of a specific component. You can use the arrows on the top-right corner of the section to view the historical operational status of components, one week at a time, for the preceding three months.

This section also provides an aggregated incident status for all the incidents for any given day. Click the days with incidents to view a summary of uptime details along with a list of incidents reported for that day.

---

**Note:** Planned maintenance windows are reported as incidents.

---

## Maintenance information

Two types of incidents are monitored for and reported on the Automation 360 Cloud Service Status site:

- **Planned incidents:** Incidents that are primarily related to planned maintenance windows for software updates, such as patch updates, security updates, and infrastructure updates.
- **Unplanned incidents:** Unplanned interruptions that result in reduced or degraded service performance or total interruption to service availability for some or all customers.

### Planned maintenance events

The planned maintenance window is published well in advance of scheduled events and is conducted to improve multiple aspects of a service. A planned maintenance event is scheduled to deploy a software update, a patch to fix an existing issue, a security patch to resolve a security vulnerability, or an infrastructure component update to improve the reliability, resiliency, and

availability of the service. Users who are subscribed to incident notifications receive an email notification about the details of maintenance windows.

Planned maintenance events typically last for four to six hours per geographical region when updates are rolled out. Although the actual downtime during the update varies, completion is typically within 10 to 15 minutes. If IQ Bot is in use, completion time is typically 20 to 30 minutes.

The Automation 360 Cloud Service Status site provides information about the following types of planned maintenance events:

Planned maintenance event for deploying Automation 360 release update	This planned maintenance event deploys new Automation 360 software release update to the Automation 360 Cloud. Here are the notification fields for this software release update:				
	<table border="0"> <tr> <td data-bbox="846 638 1133 743">Title</td> <td data-bbox="1138 638 1401 743">Planned update for Automation 360 Cloud for a region</td> </tr> <tr> <td data-bbox="846 749 1133 978">Description</td> <td data-bbox="1138 749 1401 978">Planned update for Automation 360 to the Automation 360 Cloud, which results in minor interruptions to the service during this period.</td> </tr> </table> <hr/> <p data-bbox="1138 1005 1401 1136"><b>Note:</b> We recommend that you do not run bots during this period.</p> <hr/>	Title	Planned update for Automation 360 Cloud for a region	Description	Planned update for Automation 360 to the Automation 360 Cloud, which results in minor interruptions to the service during this period.
Title	Planned update for Automation 360 Cloud for a region				
Description	Planned update for Automation 360 to the Automation 360 Cloud, which results in minor interruptions to the service during this period.				
	<table border="0"> <tr> <td data-bbox="846 1171 1133 1528">Advance Notice</td> <td data-bbox="1138 1171 1401 1528">The notification announcing this maintenance window is published at least two weeks in advance on the Automation 360 Service Status site. The release notes are published in advance of the update.</td> </tr> </table>	Advance Notice	The notification announcing this maintenance window is published at least two weeks in advance on the Automation 360 Service Status site. The release notes are published in advance of the update.		
Advance Notice	The notification announcing this maintenance window is published at least two weeks in advance on the Automation 360 Service Status site. The release notes are published in advance of the update.				
Planned maintenance event for deploying patch (non-security) release for Control Room	This planned maintenance event deploys Automation 360 software patches to Automation 360 Cloud to fix existing or unknown issues. Here are the notification fields for this patch release update:				
	<table border="0"> <tr> <td data-bbox="846 1730 1133 1831">Title</td> <td data-bbox="1138 1730 1401 1831">Critical update for Automation 360 Cloud for a region</td> </tr> </table>	Title	Critical update for Automation 360 Cloud for a region		
Title	Critical update for Automation 360 Cloud for a region				

	Description	This is a critical, non-security patch update for Automation 360 to the Automation 360 Cloud, which results in minor interruptions to the service during this period. <hr/> <b>Note:</b> We recommend that you do not run bots during this period. <hr/>
	Advance Notice	The notification announcing this maintenance window is published with best effort, in advance, on the Automation 360 Service Status site. The release notes are published in advance of the update.
Planned maintenance event for deploying patch (security) release for Control Room		This planned maintenance event deploys Automation 360 security fixes to Automation 360 Cloud to fix existing vulnerabilities, known security issues, and Cloud component updates to resolve vulnerabilities. Here are the notification fields for this update:
	Title	Critical security update for a region
	Description	This is a critical security patch update for Automation 360 to the Automation 360 Cloud, which results in minor interruptions to the service during this period. <hr/> <b>Note:</b> We recommend that you do not run bots during this period. <hr/>
	Advance Notice	The notification announcing this maintenance window is published with best effort, in advance, on

		the Automation 360 Service Status site depending on how critical the security issue is. The release notes are published in advance of the update.
Planned maintenance event for Automation 360 infrastructure updates	This planned maintenance event deploys updates related to the Automation 360 Cloud infrastructure. Here are the notification fields for this update:	
	Title	Planned infrastructure update for Automation 360 Cloud for a region
	Description	This is a planned infrastructure update for Automation 360 Cloud, which results in minor interruptions to the service during this period.
		<hr/> <b>Note:</b> We recommend that you do not run bots during this period. <hr/>
	Advance Notice	The notification announcing this maintenance window is published at least two weeks in advance on the Automation 360 Service Status site. The release notes are published in advance of the update.
Planned maintenance event for patch (security) release for IQ Bot Hybrid	Title	Planned update for Automation 360 Cloud for IQ Bot Cloud servers for a region
	Description	This is a critical patch update for IQ Bot on the Automation 360 Cloud, which results

in interruptions to the IQ Bot service during this period. #Access to the main Automation 360 Cloud Control Room and other services are not affected.

---

**Note:** We recommend that you do not schedule bots that use IQ Bot capabilities to start during this period.

---

#### Advance Notice

The notification announcing this maintenance window is published at least two weeks in advance on the Automation 360 Service Status site. The release notes are published in advance of the update.

## Incident history

The **Incident History** section shows a detailed list of resolved incidents and completed scheduled maintenance events for the preceding seven days.

The list includes the following details about each incident:

- Incident description
- Incident duration (start time, end time, and duration of the outage)
- Affected components
- Incident status updates
- Information in cases of unplanned service outages

## Automation 360 Cloud updates

Automation 360 Cloud is a multitenant cloud service that leverages the latest best practices in delivering web-scale SaaS to rolling out incremental updates globally using a continuous deployment pipeline.

Automation 360 Cloud provides updates to the Bot Agent instances running on your infrastructure. The Bot Agent is a lightweight, Java-based, modular application that handles particular bots and their packages when they are scheduled to run.



Bot Agent updates are transparent to active Bot Creator users. For operations, the Bot Agent updates are carried out automatically, by default, without requiring administrative privileges (much like browser updates).

---

**Note:** This is regardless of whether the Bot Agent was installed as a system user or local user.

---

With each update, products such as Automation Workspace, Control Room, IQ Bot, Bot Insight, Discovery Bot, and Automation Co-Pilot have improved security and enhanced features. Application command packages can also be enhanced and made available for inclusion into bots on your release cycle.

Updates are rolled out over a 3-hour maintenance window per geographical region. These maintenance windows are posted on the Automation 360 Cloud Service Status site. Although the actual downtime during the update varies, completion is typically within 10-15 minutes. If IQ Bot is in use, completion time is typically 20 - 30 minutes. In general, bots run to completion during updates, with the following scenarios being exceptions:

- The bot tags data for Bot Insight.
- Bots that run WLM.
- Credentials directly entered as command input are pulled from the Control Room at execution time. Instead, use credential type variables.
- Child bots: Parent/child bots run to completion because the child bots are downloaded when the parent bot starts its run.

Exceptions:

- If a child bot is referenced using a variable parameter because the child bot requires the Control Room to be available when the parent bot runs.
- If a child bot does not use the same global variables as the parent bot.
- If a child bot is using credential type variables.

After the Bot Agent has reconnected to the Control Room, the bot status is updated in the bot run activity logs.

Automated Bot Agent update takes place after an agent completes any current bot run and the Bot Agent reconnects to the Control Room.

During this short downtime, any bots scheduled to run will not be run. It is therefore recommended that bots are not scheduled to start to run during the planned maintenance window.

The following table provides a list of regions and the day and time of their maintenance windows. The upgrade occurs sequentially over a three week period:

- Week 1 - First rollout will begins in the AP-AUS and AP-Sing regions
- Week 2 - Second rollout begins in the EU-West1, EU-West4, LATAM, ME, S, Africa, US-East, US-Central, and India regions
- Week 3 - Third and final rollout begins in the US-West, Canada, and Japan

---

**Important:**

Times mentioned below are in UTC (Coordinated Universal Time). To convert to your local time, refer to a universally recognized online resource such as <https://www.worldtimezone.com/>.

---

Region	Day and time in UTC
AP-AUS	Wednesday, 12:00 to 15:00
AP-Sing	Wednesday, 16:00 to 19:00
EU-West1	Tuesday, 20:00 to 23:00
EU-West4	Tuesday, 20:00 to 23:00
LATAM	Thursday, 02:00 to 05:00
ME	Thursday, 20:00 to 23:00
S. Africa	Thursday, 20:00 to 23:00
US-East	Friday, 02:00 to 05:00
US-Central	Friday, 02:00 to 05:00
India	Friday, 20:00 to 23:00
US-West	Monday, 02:00 to 05:00
Canada	Monday, 02:00 to 05:00
Japan	Monday, 16:00 to 19:00

---

**Note:** A small interim update might be planned to address urgent, priority updates mid-cycle between the primary quarterly updates. These will occur on the same day of the week and time as the schedule mentioned previously.

---

## Regular updates

Regular updates are planned approximately every 3 months and are scheduled to occur during non-business hours and not close to the beginning or end of a month. Notifications are posted to the Service Status site 2 weeks in advance of the update. A notification message is also pushed to administrators in the Control Room in advance.

You can review changes in the release notes that are made available 3 weeks before each update.

---

**Note:** As a customer, you can use a sandbox Control Room environment to try out the next update at least 3 weeks before the main Dev/UAT/Prod environments are updated.

---

Command packages might be updated and made the default for creating new bots. Existing bots continue to use their existing package versions. New bots use the new default package version. However, as a user, you can also choose to revert to the previous version.

## Cloud infrastructure updates

Cloud infrastructure updates are carried out typically once every 3-month period. These updates do not involve interruptions to the services, so no maintenance window is published, and no action is required on the customer side.

## Critical patch updates

Patch updates might be required for either critical security updates or where serious issues with an update affect the majority of Cloud customers.

Most patches will not require a maintenance window and they typically do not require a Bot Agent update.

**Note:** Some patch updates (for example, when a database schema change is required) might continue to require a maintenance window and a notice will be provided in advance on the Service Status site.

## Planned maintenance windows

Automation Anywhere offers planned update maintenance windows to enable customer operations to support Bot Lifecycle Management. Outside of planned maintenance windows for the updates mentioned previously, the Automation 360 Cloud availability SLA is 99.9 percent per month.

**Note:** For more information, see [Cloud Automation Agreement](#).

The following table provides information such as frequency, time expectation, and client action for different types of updates:

Type of update	Frequency	Time expectation	Client action
Regular Automation 360 Control Room and Bot Agent	3 - 4 months	3-hour window Around 10 minutes of downtime	Bots can run to completion. Do not schedule bots to start during this 3-hour window.
Sandbox	At least 3 weeks prior to regular Cloud updates		Try new features out after the window. Sanity-test production bots.
Cloud infrastructure	As needed	Not Applicable	No interruptions to services and no action required on customer side.
Critical patch	As needed	Notice provided in advance	No interruptions to services and no action required on customer side.

## Subscribing to notifications

In the [Automation 360 Cloud Service Status site](#), subscribe to email notifications about planned maintenance events and unplanned incidents that affect service availability.

To subscribe to email notifications from the Automation 360 Cloud Service Status site about planned maintenance events and unplanned incidents that affect service availability, click **Subscribe** on the top-right corner of the Service Status site.

Provide your name and email address when subscribing to notifications.

You can manage your subscription by clicking **Manage Existing Subscription**. The system sends you a link, by email, with which you can manage your incident notification subscription. You can select the service and the region for which you want to receive status notifications.

To subscribe to incident notifications for the Cloud region where your services are hosted, open an Automation Anywhere support ticket.

## Personalizing the Service Status site

You can personalize the Automation 360 Cloud Service Status site by selecting the language and time zone of your choice for showing incidents. To select language and time zone, click the gear icon on the top-right corner.

Language

You can select a language from among seven supported languages.

Time zone

When you select a time zone, the incidents from the selected time zone will be shown.

## Automation 360 software lifecycle policy

Automation Anywhere software lifecycle policy aims to make innovations and enhancements available to you quickly. Through this policy, we provide you predictability, quality, and importantly nondisruptive access to the latest innovations and enhancements so that you can control when and how you want to adopt these enhancements.

---

**Note:** The policies mentioned on this page apply to both Automation 360 Cloud and On-Premises deployments unless where the differences are called out explicitly.

---

### Overview

The software lifecycle policy helps you with change management while providing you the latest software updates with enhancements in the Control Room, Bot Agent, and packages.

Our policy aims to provide faster access to features, bug fixes, and other enhancements for a better customer experience:

- **Predictability:** With frequent, regular deployment cycles, you can get access to new and enhanced packages sooner than before with predictable release cadence.
- **Deploy new features:** With control over introducing changes to your bots, you can test new features and deploy them at your own pace.

- Quality: With automated deployments from Automation 360 Cloud, you can use new packages that include critical bug and security fixes.
- Nondisruptive access: You can update packages without disrupting your existing configurations.
- Backward compatibility: You now have the option to safely update bots while still having the option to change back to a previous version of a package.

The following image shows the advantages of this lifecycle policy:



### Bot Agent updates

When a new version of Bot Agent is available, by default, the Bot Agent is deployed automatically across a customer's pool of devices without impacting existing bot functionality. However, Control Room administrators can disable this default update capability and choose to update the Bot Agent manually. In case of manual updates and in the event of a mandatory update, users will be notified that the Bot Agent must be updated and all bot execution on these devices will stop until the Bot Agent is updated.

For larger deployments where device pools are deployed using standard device Amazon Machine Images (AMI) on separate schedules, these updates will require coordination, change

management processes, and approvals in the customer environment. Therefore, Automation 360 will support backward-compatible Bot Agent for a release every 6 months.

Starting with Automation 360 v.24 release, 4 Bot Agent updates will be released each year with 2 optional and 2 updates that might be declared mandatory. You can skip the optional update and update to the next mandatory Bot Agent update.

Our Q2 and Q4 releases will have optional Bot Agent updates and you can choose to skip the Bot Agent update. However, the Q1 and Q3 updates might have mandatory Bot Agent updates. We will notify customers 3 months in advance if a mandatory Bot Agent update is required with a Control Room release.

## Package updates

Starting with Automation 360 v.24 release, delivery of packages is developed to be separate from the main platform updates. This will help us respond quickly to changes and fixes required and provide the flexibility to deliver updates in packages, going forward.

With this capability, new packages and new package versions can now be automatically downloaded from Automation Anywhere Cloud when they are predictably released on a quarterly release cadence. These downloaded packages become the default package so that customers can start using these package versions on an ongoing basis as they become available.

This capability is enabled differently for Cloud and On-Premises Control Room instances, as listed in the following table:

Seamless package update capability	Cloud Control Room	On-Premises Control Room
Download packages from Automation Anywhere Cloud	Enabled by default and cannot be disabled.	Disabled by default and can be enabled.
Set downloaded package to default version	Enabled by default and can be disabled.	Enabled by default and can be disabled.

- Cloud users: Automatic package download capability is now enabled across all Control Room instances in all regions at the same time.

You can start using the latest packages on your current Control Room version before the Control Room update is made available in your region.

- On-Premises users: This capability is disabled by default but it can be enabled by package administrators.

We recommend that bot developers always use the latest version of the packages because that version provides the latest innovations and all the code and security fixes from previous versions. However, administrators can change this default behavior at any time and roll out the packages to developers after verifying them. These new package versions are also backward-compatible with the existing platform version.

Note that this capability has no impact on existing bots, which continue to run unchanged. Bots that are developed with a particular package version will always continue to do so unless explicitly changed by the bot developer. This provides bot developers the flexibility to adopt new package versions when they are ready for it. Bot developers must explicitly edit the bots in the Bot editor view and use the new package version.

## Support and deprecation policy for packages

Support and deprecation policy for packages aims to provide bot longevity and reduce overall maintenance efforts to keep bots updated. The design consideration is to minimize the bot changes required to keep the bot functioning.

---

**Note:** This policy is in effect from Control Room release v.23.

---

Package versions supported for a minimum of 2 years	<p>Package versions that are released will continue to be supported for a minimum of 2 years after the release. Even after 2 years, a package version will continue to be supported unless it is deprecated.</p> <p>Typically, a new version of the package will be made available if a package is deprecated. All issues and security fixes reported for the package will be fixed in the latest version, with no backporting.</p> <p>You will be notified 3 months in advance when a package version is planned for deprecation. If there is a critical security vulnerability, we will make the best effort to send an advanced notification.</p>
Packages version compatibility with Bot Agent and Control Room	<p>Package versions and bots that use these versions will be compatible with all the Control Room and Bot Agent versions released within the 2 years after the package version release. Bots that use these supported package versions do not have to be configured to be compatible with the Control Room and Bot Agent versions.</p>
Deprecation policy on package version	<p>Package versions will not be deprecated within the 2 years after their release unless there is a critical security vulnerability that has to be fixed. In such a case, a new package version will be made available with the fix.</p>
Minimal bot changes	<p>The package version support policy aim is to minimize the effort required to change existing bots and to keep them functioning.</p> <p>Bots using a specific package version do not have to be updated to use the package versions if the existing package version is supported. However, we recommend that you use the latest version of the package when developing the bot to increase the longevity of the bot. The package versions used in a bot will have to be updated before they are deprecated for the bot to remain supported.</p>

## Bot lifecycle

The design assumption for bots is that the version of the package used in the bots is present in the Control Room that is used to run the bots. Before developers promote bots, we recommend that the developers verify that the package version used in the bots matches the package version in the higher environments.

When promoting bots to higher environments (for example, testing and production) that are on a lower software version, ensure that you include the dependent packages for bots. This will ensure that the target environment has all the package versions required by the bot.

---

**Note:** Some package versions will not be backward compatible with an earlier version of the Control Room or Bot Agent. Therefore, refrain from using such incompatible package versions during the Control Room environment update phase.

---

See also: [Automatic package updates for On-Premises Control Room](#).

Related concepts

[Feature deprecations affecting Automation Anywhere products](#) on page 1086

Review the features and capabilities (from Automation Anywhere or third party) that are deprecated or nearing deprecation to understand how they affect your automation and what action is required.

Related reference

[Automation 360 Cloud FAQ](#) on page 1058

Answers to frequently asked questions (FAQ) and related information provide insight into various aspects related to Automation 360 Cloud.

[Automation 360 Cloud updates](#) on page 1072

Automation 360 Cloud is a multitenant cloud service that leverages the latest best practices in delivering web-scale SaaS to rolling out incremental updates globally using a continuous deployment pipeline.

## Automation and generative AI

Combine the power of generative AI and automation to unlock productivity across each system, team, and process in your business.

Our automation platform provides these generative AI powered offerings:

Automation Co-Pilot for Business Users

An on-demand, Intelligent Automation assistant powered by generative AI. Embedded in any business application, Automation Co-Pilot helps knowledge workers and customer service agents accelerate routine business tasks, such as processing emails, summarizing applications, and generating reports. Learn more: [Automation Co-Pilot for Business Users](#) on page 3296.

Document extraction using generative AI

Document Automation has been a leading technology for processing critical business information. With the power of generative AI, it can now ingest, comprehend, and extract



data from any unstructured document type in the flow of work. This capability opens up a whole new world of data that was historically challenging and costly to extract for process automation. Learn more: [Document Automation data extraction using Generative AI](#) on page 3709.

#### Generative AI packages

Use our new generative AI packages containing native integrations with hyperscaler LLMs to easily build out automations. Supported LLMs include Google Vertex AI, Azure OpenAI, and OpenAI. Learn more: [Generative AI packages](#) on page 2626.

Watch the following video on how to put generative AI to work with our automation platform:

## Data security for generative AI - FAQ

We have introduced generative AI (GenAI) infused features to help our customers realize productivity gains by building better and smarter automations. Our customers can realize the power of GenAI with features such as Automation Co-Pilot for Business Users and Document Automation.

Automation Anywhere supports command packages for customers using their own licenses for the large language models (LLMs). Some Automation Anywhere products contain embedded third party LLMs. This document intends to provide answers to frequently asked questions around data and security measures we have put in place for safely using the GenAI infused features. It is important to understand the two categories of data as we refer to them in this document.

#### Customer Data

Refers to data submitted by customers through Automation Anywhere hosted systems such as Automation Success Platform. This data is required to operate and deliver services. For example, user text prompts are treated as Customer Data.

#### Usage Data

Refers to data generated from the use of the platform services and features. This data is anonymized and aggregated data for metrics and other telemetry, such as standard package names and sequencing of steps gathered by Automation Anywhere to improve the services and product performance.

How does Automation Anywhere enable customers to automate against their own LLM subscription?

Automation Anywhere supports customers bringing their own license for their preferred foundation models when using Automation Anywhere provided command packages, for example, Automation Co-Pilot for Business Users. These foundation models hosted on hyperscaler platforms can be accessed using the Automation 360 native integrations through our command packages, which include

	<p>Microsoft Azure OpenAI, OpenAI, and Google Vertex AI.</p> <p>To know if you can integrate with your chosen LLM, see the <a href="#">product documentation</a>.</p>
<p>Which products use GenAI models provided by Automation Anywhere?</p>	<p>We use GenAI models provided by well-known providers in the following products:</p> <ul style="list-style-type: none"><li>• Automation Co-Pilot for Automators (Beta)</li><li>• Resilient Recorder (Beta)</li></ul> <p>For more information, see:</p> <ul style="list-style-type: none"><li>• <a href="#">Document Automation data extraction using Generative AI</a> on page 3709</li><li>• <a href="#">Generative AI packages</a> on page 2626</li></ul>
<p>What data will be used to train the Automation Anywhere provided models?</p>	<p>No Customer Data is used to train the LLMs embedded in our products. For Automation Anywhere provided models in the Automation Anywhere controlled environments, only the Usage Data is used to train the Automation Anywhere provided models. This data contains no Customer Data.</p>
<p>What measures are in place to ensure that Customer Data is not utilized for training the large language model (LLM) libraries?</p>	<p>No Customer Data is used to train the models, nor is Customer Data stored outside customer-tenant production environments within the Automation Success Platform.</p> <p>We have gone through vendor reviews to ensure that third-party LLMs are not using Customer Data for training their models.</p>
<p>What measures are in place to prevent unauthorized access or data breaches?</p>	<p>We have put in place security measures, such as preventing Customer Data from being stored externally as well as providing guardrails, redaction, or masking in certain products. Automation Success Platform ensures that Customer Data is always protected by using industry-standard encryption for data at rest and in transit. These systems storing Customer Data are monitored 24x7 and access controlled to ensure safe operations in compliance with SOC 2, ISO 27001, and HITRUST. We have implemented appropriate security measures, such as web application firewall, encryption (AES 256 at rest, TLS in transit), and industry-standard authentication and authorizations for RBAC. Our platform designs have considered protection against threats as laid out in the <a href="#">OWASP Top10 for LLMs</a>.</p>
<p>How does Automation Anywhere protect Customer Data when using GenAI?</p>	<p>Our products using GenAI are on the same platform as our current products and are</p>

What are some best practices customers can leverage to benefit from GenAI products?

covered by the same security certifications (SOC1, SOC2, ISO, and COBIT) and standards as our other products. A dedicated cloud security team is responsible for ensuring compliance and supporting audits conducted by external, professional auditors for our security certifications. Our security certifications and reports can be found on our [Compliance Portal](#).

Here are some best practices to leverage when using GenAI infused product features:

Know where your data is and how it is being used

When using your own LLM providers, only use model providers that are vetted and those with whom you have clarity on your data and its usage. Ensure that no sensitive data is used to train the shared models and understand if/ where your data is stored and who has access to it.

Use guardrails on model inputs and outputs

GenAI models are sensitive to variations in the inputs they received and can occasionally be unpredictable in the output generated as it is free-form text. By designing workflows that use GenAI models for approved tasks with pre-designed prompts and output validation steps, you can further ensure that the model will work with a high degree of confidence in production environments. Designing a prompt that is explicit and controlled for a task like summarization translates to your users getting a higher quality and more consistent output from the models to use in their workflows. Ensure users do not submit sensitive information in their prompts.

Keep a human-in-the-loop for generated content

When generating content such as personalized customer emails or patient summaries, it is critical to ensure that a human validation step is present in your process before sharing anything externally. It is important to understand that GenAI models can occasionally be unpredictable in the output generated, especially when generating new content. Use notifications to push users' work requiring reviews in real time and track the overall workflow status.

Use code analysis

Automation Anywhere code analysis is a built-in security feature for identifying violations of best practices. The feature has been designed to promote and enforce coding best practices that will help to identify and fix deviations from best practices proactively through stronger security and compliance of automations by enforcing secure coding practices, and better code readability and quality.

Related concepts

[Automation Co-Pilot for Business Users](#) on page 3296

Automation Co-Pilot for Business Users provides a simple, front-end interface for users to execute and interact with bots and applications.

[Document Automation data extraction using Generative AI](#) on page 3709

Document Automation for Cloud provides generative AI (GenAI) capability to extract data seamlessly from unstructured and semi-structured documents. Create learning instance with GenAI capability to process documents in English, using a large language model (LLM). Note: This capability is available only in Cloud deployments from Automation 360 v.30 release.

Related reference

[Generative AI packages](#) on page 2626

Generative AI models use deep learning techniques, particularly generative models such as Large Language Models (LLMs). LLMs are deep learning models trained on massive datasets of text to generate human-like text or language-based content. With Automation Anywhere's Generative AI packages, you can select the model that best fits your automation needs.

## Automation resiliency

Automation (bot) resiliency enables bot executions to complete without any interruptions from other background applications, thereby making the bots more resistant to events that occur during runtime.

Any window that is external to the target application is considered a pop-up. For example, if you are using the Google Chrome browser, a Microsoft Windows Update notification is considered a pop-up. A pop-up window is detected by comparing the point or area of action window with the target application window. The detected window is marked as pop-up and handled if it is different from the target window.

System pop-ups such as anti-virus alerts, Windows update notifications, or notifications from other applications (such as Teams) might interrupt and even stop bot execution. With regular error handling logic, it can be difficult to block these pop-ups during bot runtime. Resilient automation can detect and triage these pop-ups to ensure a seamless bot execution.

SAP and HTML are the currently supported technologies.

---

**Note:** In Automation 360 v.30, the handle unexpected pop-ups functionality is available by default only for Cloud users.

On-Premises users can contact your Automation Anywhere Customer Support for assistance on enabling this feature.

---

The following diagram shows how a resilient and non-resilient bot handles pop-ups:

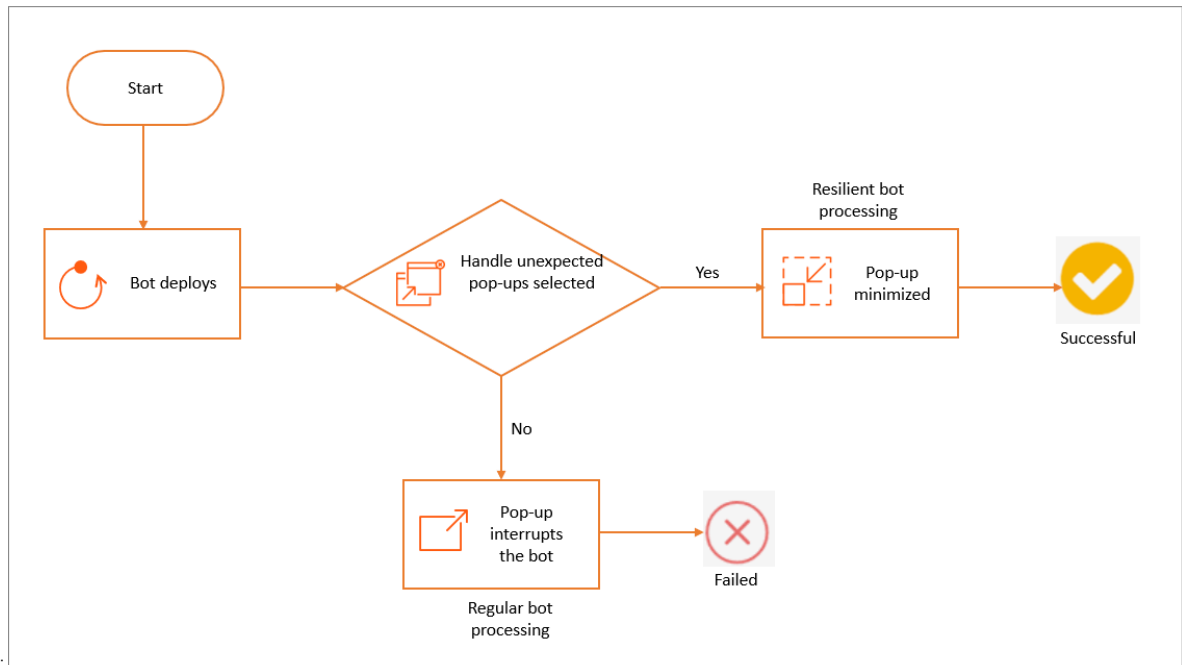

ups:

Automation resiliency provides the following benefits:

- Makes bots more resilient to changes from underlying applications.
- Leverages the enhanced performance of bots to increase the automated tasks.
- Enables automation scaling on demand.
- Conforms to security standards for stronger protections against unauthorized access.

## Supported packages

The handle unexpected pop-ups functionality is currently supported for the following packages:

- Image Recognition (version 3.15.2 or later)
- Mouse (version 2.14..0 or later)
- OCR (version 2.12.1 or later)
- Recorder (version 2.11.5 or later)
- Screen (version 2.9.2 or later)

## Manage unexpected pop-ups

Manage or handle unexpected pop-ups in Automation 360 so that your bots can complete without any runtime interruptions.

When a pop-up is detected, the system attempts to set the target application window at the top (topmost) of all other windows. If the pop-up window persists, then it is minimized and the automation is attempted. However, the automation might fail if the system is unable to minimize the pop-up window.

**Note:** In Automation 360 v.30, the **Handle unexpected pop-ups** is available by default for only Cloud users.

On-Premises users can contact your Automation Anywhere Customer Support for assistance on enabling this feature.

---

To review the list of the packages that support the handle unexpected pop-ups functionality, see [Supported packages](#) on page 1085.

## Limitations for handling pop-ups

The automation might fail if the system is unable to handle pop-ups in the following scenarios:

- The pop-up is from an application that is running with administrator privileges.

---

**Note:** As a workaround, you can run the automation with administrator privileges by selecting the **Run with administrative privileges** check box in the **Run bot now** window.

- The pop-up application has any of the defensive programming such as pop-up should not be minimized or cannot change its z-order.
- Commands cannot handle the pop-ups that contain one of the following options:
  - Currently active window - the window that is active when the bot run starts.
  - Desktop window - the default window or space behind all the open windows.
  - Screen - the visible screen.

1. Log in to Control Room and click **Automation** on the left pane.  
A list of available bots and forms is displayed.
2. For the bot that you want to enable the pop-up handler, click the actions menu (vertical ellipsis).
3. Click **Run Task Bot**.  
The **Run bot now** screen is displayed.
4. In the **General** tab, select the **Handle unexpected pop-ups** check box.  
The following video shows how to enable the functionality:
5. Click the **Run bot now** button.  
The selected bot is deployed with the capability to manage pop-ups. Any unexpected pop-ups that occur during the bot run are now handled to ensure the bot execution is successful.

## Feature deprecations affecting Automation Anywhere products

Review the features and capabilities (from Automation Anywhere or third party) that are deprecated or nearing deprecation to understand how they affect your automation and what action is required.

---

**Definition:** Deprecation refers to features or capabilities available in the current (latest) release that are planned to be removed or unsupported in a future release.

You can use the specified alternatives or updated versions when they are made available.

### Third-party feature deprecations

Upcoming: The following table lists third-party features that will be deprecated by the date mentioned:

Feature or capability	Deprecation date	Customer impact and recommendation	Resources
EWS API See <a href="#">Upcoming API Deprecations in Exchange Web Services for Exchange Online</a>	Ongoing deprecation	Automation 360 currently uses EWS API in Email package and Email trigger for the EWS option to connect to Exchange Online hosted on Azure Cloud and access emails from Microsoft 365.  Microsoft has recommended that customers move to a REST-based Graph API, which is more secure and scalable compared with the legacy SOAP-based EWS API. Therefore Automation 360 will provide support for Microsoft 365 Outlook package based on Graph APIs which will enable you to switch from EWS API to Graph API from an upcoming release.  This deprecation by Microsoft might impact bots for email automations (Email package and Email trigger) that connect to Exchange Online using EWS API. Note that there is no immediate impact on your existing bots and they continue to run properly.  Recommended: Update the impacted bots by replacing each email-related action with the equivalent new actions in the Microsoft 365 Outlook package, planned in the upcoming release if your bots are impacted by the deprecation.	--

Completed: The following table lists third-party features that are already deprecated:

Feature or capability	Deprecation date	Customer impact and recommendation	Resources
Manifest V2 based extensions (Automation 360 v.26 and later releases)	October 23, 2023	<p>From Automation 360 v.26 and later releases, we have published new Google Chrome and Microsoft Edge Manifest V3 extensions.</p> <p>Starting on October 23, 2023, we will deprecate support for Manifest V2 extensions on Automation 360 v.26 and later releases. After this date, we will not address any issues relating to Manifest v2 extensions. If you are on Automation 360 v.26 or a later release and still using Manifest V2 extensions for Google Chrome and Microsoft Edge, we recommend that you update your Google Chrome and Microsoft Edge browser extensions to Manifest V3 extensions before October 23, 2023.</p>	
Tegaki API OCR engine	October 3, 2023	From Automation 360v.30, we have deprecated use of Tegaki API OCR engine for data extraction in Automation 360 IQ Bot. We recommend using the Google Vision OCR engine instead.	<p>Deprecation note added to:</p> <ul style="list-style-type: none"> <li>Automation 360v.30 Release Notes: <a href="#">Document Automation and IQ Bot v.30 release</a></li> <li><a href="#">Use Tegaki API OCR engine</a></li> </ul>



Feature or capability	Deprecation date	Customer impact and recommendation	Resources
Transport Layer Security (TLS) 1.0 and TLS 1.1	April 2023	<p>Automation 360 Cloud deployments currently support the following TLS protocol versions:</p> <ul style="list-style-type: none"><li>• TLS 1.0</li><li>• TLS 1.1</li><li>• TLS 1.2</li><li>• TLS 1.3</li></ul> <p>However, the TLS 1.0 and TLS 1.1 protocol versions have security vulnerabilities as per the industry security standards. Therefore, Automation 360 Cloud deployments for Amazon Web Services and <a href="#">Google Cloud Project</a> will support only the TLS 1.2 and TLS 1.3 protocol versions.</p> <hr/> <p><b>Note:</b> For Automation 360 Cloud deployments, the changes will be effective as part of the Cloud deployment configurations, not as part of the Automation 360 release.</p> <hr/>	<a href="#">Deprecating TLS 1.0 and TLS 1.1</a>

Feature or capability	Deprecation date	Customer impact and recommendation	Resources
<p>Manifest V2 based extensions by Google</p> <p>See also: <a href="#">Overview and timelines for migrating to Manifest V3</a></p>	January 2023	<p>Automations that use Google Chrome Manifest V2 based extensions will stop working sometime after June 2023. The deprecation timelines of Manifest V2 based extensions are currently under review and subject to change by Google.</p> <ul style="list-style-type: none"> <li>For Google Chrome Manifest V2 extensions timelines, see <a href="#">Manifest V2 support timeline</a>.</li> <li>For Microsoft Edge Manifest V2 extensions timelines, see <a href="#">Overview and timelines for migrating to Manifest V3</a>.</li> </ul> <p>This might impact customer bots that automate web applications over Google Chrome and Microsoft Edge.</p> <p>Recommended: Switch to Manifest V3 based extensions for Google Chrome and Microsoft Edge.</p> <p>Releases:</p> <ul style="list-style-type: none"> <li>Automation 360 v.26</li> <li>Version 11.3.5.8</li> </ul>	<ul style="list-style-type: none"> <li><a href="#">Chrome and Edge Manifest V3 extensions</a> on page 1138</li> <li><a href="#">Enterprise 11: Deprecation of Basic authentication and MV2 extensions</a></li> <li><a href="#">Version 11.3.5.8 Release Notes</a></li> </ul>
<p><a href="#">Basic authentication in Exchange Online</a></p>	October 2022	<p>Bots for email automations (Email package and trigger) that connect to Exchange Online by using IMAP, POP3, or EWS protocols with Basic authentication will be impacted.</p> <p>Recommended: Update the impacted bots by replacing each email-related action with OAuth 2.0.</p> <p>Released:</p> <ul style="list-style-type: none"> <li>A package only release for Automation 360 v.25</li> <li>Version 11.3.5.7 client patch</li> </ul>	<ul style="list-style-type: none"> <li><a href="#">Deprecation of Basic authentication in Exchange Online</a> on page 1123</li> <li><a href="#">Enterprise 11: Deprecation of Basic authentication and MV2 extensions</a></li> </ul>

Feature or capability	Deprecation date	Customer impact and recommendation	Resources
<a href="#">Internet Explorer EOL</a>	June 2022	<p>Customers who are running IE-based bots on Windows 10 Semi-Annual Channel are impacted.</p> <p>Releases with tools to convert IE-based bots to Microsoft Edge with IE mode:</p> <ul style="list-style-type: none"> <li>Automation 360 v.24R2</li> <li>Version 11.3.5.6</li> </ul>	<p><a href="#">Microsoft Internet Explorer EOL overview</a> on page 1097</p> <p><a href="#">Microsoft Internet Explorer 11 EOL FAQ</a> on page 1100</p>

## Automation Anywhere feature deprecations

Upcoming: The following table lists Automation Anywhere features that will be deprecated by the date mentioned:

Feature or capability	Deprecation date	Customer impact and recommendation	Resources
v1 Authentication API	December 2023	<p>From Automation 360 v.31, the Authentication API (v1/authentication and v1/authentication/token) will be deprecated.</p> <p>Recommended: You can use the v2/authentication and v2/authentication/token</p>	<p>New API: Authentication API v2/authentication and v2/authentication/token</p> <p>Deprecated API: v1/authentication and v1/authentication/token</p>
v1 User Management API	December 2023	<p>From Automation 360 v.31, the User Management APIs (v1/usermanagement) will be deprecated.</p> <p>Recommended: You can use the v2/usermanagement</p>	<p>New API: User Management APIs v2/usermanagement</p> <p>Deprecated APIs: v1/usermanagement</p>
v3 Migration API	December 2023	<p>From Automation 360 v.31, the v3 Migration APIs (v3/migration) will be deprecated.</p> <p>Recommended: You can use the v4/migration</p>	<p>New API: Migration APIs v4/migration</p> <p>Deprecated APIs: v3/migration</p>

Feature or capability	Deprecation date	Customer impact and recommendation	Resources
Cloud-enabled deployment model	April 2024	This deprecation will impact customers who are on a Cloud-enabled deployment model. We recommend that such customers move to Automation 360 Cloud or On-Premises before the deprecation.	For assistance, contact Automation Anywhere support: <a href="#">Open a support case (A-People login required)</a> .

Completed: The following table lists Automation Anywhere features that are already deprecated:

Feature or capability	Deprecation date	Customer impact and recommendation	Resources
Automation 360 IQ Bot Community Edition	November 28, 2023	Automation 360 IQ Bot Community Edition will no longer be available from November 28, 2023. Use the Document Automation Community Edition for enhanced intelligent document processing.  Users who have created automations using Automation 360 IQ Bot will need to rewrite them using Document Automation.	To learn more, refer to <a href="#">Document Automation</a> .
Descoped language support	June/July 2023	Beginning with Automation 360 v.29, the User Interface for Automation Anywhere product will no longer support Italian, Russian, and Simplified Chinese languages. In addition, updated release documentation will no longer be available in these three languages though older documentation will be accessible.	--
IQ Bot Extraction package		This package is deprecated from Automation 360 v.26. Document Automation provides all the capabilities provided by the IQ Bot Extraction package. To move your bots from the IQ Bot Extraction package to Document Automation, see <a href="#">Move from IQ Bot Extraction package to Document Automation</a> .	Archived Documentation (PDF):

Feature or capability	Deprecation date	Customer impact and recommendation	Resources
IQ Bot Extraction package	October 2022	<p>From Automation 360 v.25, the IQ Bot Extraction package no longer supports pre-trained machine learning model for invoice data extraction but will continue to support learning instance group based-training extraction.</p> <p>Recommended: Use the new command package called Document Extraction, released in v.25 as part of Document Automation.</p> <p>Released: Automation 360 v.25</p>	<p><a href="#">Move from IQ Bot Extraction package to Document Automation</a> on page 2752</p>
IQ Bot - Tesseract OCR v3	October 2022	<p>For all existing learning instances trained using Tesseract OCR v3, we recommend that you plan to train them with alternative OCRs (including Tesseract4 OCR) before you update to v.26. Note that Automation 360 IQ Bot Cloud customers will receive the v.26 release by default from October 2022.</p> <p>Released: Automation 360 v.26</p>	--
G-Suite Apps	September 2022	<p>From Automation 360 v.26, the GSuite Apps package no longer supports using the <b>Connect</b> and <b>Disconnect</b> actions to establish a connection with the Google server and automate tasks.</p> <p>Recommended: For specific G-Suite applications, the functionality of the G-Suite Apps package is available in the following G-Suite packages:</p> <ul style="list-style-type: none"> <li>• Google Drive</li> <li>• Google Calendar</li> <li>• Google Sheets</li> </ul> <p>To automate tasks, in the appropriate G-suite package, use the corresponding <b>Connect</b> and <b>Disconnect</b> actions.</p>	<p><a href="#">Connect action for Google packages</a> on page 2717</p>

Feature or capability	Deprecation date	Customer impact and recommendation	Resources
Automation Anywhere Mobile app	July 2022	The Automation Anywhere Mobile app is deprecated and will not be updated to subsequent versions of iOS and Android. The mobile app is no longer available and no further support will be offered. A replacement product is currently not available.	Archived Documentation (PDF): <a href="#">EN-US</a>
V2 Activity List API	June 2022	<p>From Automation 360 v.25, the Activity List API (<code>v2/activity/list</code>) is deprecated.</p> <p>Recommended: With the newly implemented Activity List API (<code>v3/activity/list</code>), you can return the job executions without call back and bot output information.</p> <hr/> <p><b>Note:</b> If you want to get the <code>botOutVariables</code> or <code>callbackInfo</code>, use <code>/v3/activity/execution/{id}</code> <a href="#">Bot Execution Orchestrator API</a> .</p> <hr/>	<p>New API: Activity List <code>v3/activity/list</code> <a href="#">Bot Execution Orchestrator API</a></p> <p>Deprecated API: <code>v2/activity/list</code></p>
Automation Anywhere for Excel	January 2022	<p>Automation Anywhere for Excel has been deprecated. The plug-in is no longer available to download as a product. However, support will be offered to current customers already using the product.</p> <p>A replacement product as a plug-in for Microsoft Excel is not available. However, as an alternative, new customers can develop bots for Excel within the Automation 360 Automation Workspace and use input variables to allow specifying file names, worksheets, and ranges for bots to operate on. In Automation Anywhere for Excel, this action was triggered from within the Excel application, whereas now, this action is taken from the Automation Anywhere Control Room.</p>	Documentation: <a href="#">Archived docs for RPA Bots for Excel v2.0</a>

Feature or capability	Deprecation date	Customer impact and recommendation	Resources
IQ Bot [Local Device] package	September 2021	This package is deprecated from Automation 360 v.22 (Build 10526). We recommend using Document Automation with the Document Extraction package that provides all the capabilities provided by the IQ Bot [Local Device] package along with some improvements.	Archived Documentation (PDF): <a href="#">IQ Bot [Local Device] package (Archived PDF)</a>
Process package	January 2021	The Process package is no longer supported with the Create a Request action as this has been replaced by the AARI web package (now renamed to Process Composer package) in Enterprise A2019.18.  Recommended: Use the Create a Request action in Process Composer package.	New: <a href="#">Process Composer package</a> on page 2893  Deprecated: <a href="#">Process package</a> on page 2904
Human-Bot Collaboration 11.3.x	August 2020	Human-Bot Collaboration (HBC) 11.3.x was deprecated from August 2020 with the release of Enterprise A2019.15.  Recommended: Migrate to Automation 360 to use the Automation Co-Pilot for Business Users (Automation Co-Pilot) that includes Desktop and Web.  <b>Note:</b> For this migration, there is no automated migration path between HBC 11.3.x and Automation Co-Pilot because of an absence of parity between the two products (including sets of features).	New: <a href="#">Automation Co-Pilot for Business Users</a> on page 3296  Deprecated: :

See also: [Automation 360 software lifecycle policy](#) on page 1076

Related concepts

[Automation 360 software lifecycle policy](#) on page 1076

Automation Anywhere software lifecycle policy aims to make innovations and enhancements available to you quickly. Through this policy, we provide you predictability, quality, and importantly nondisruptive access to the latest innovations and enhancements so that you can control when and how you want to adopt these enhancements.

[Deprecation of Basic authentication in Exchange Online](#) on page 1123

Microsoft will permanently disable Basic authentication for specific protocols in Exchange Online starting from October 1, 2022. This impacts customers running bot for email automation that connect to Exchange Online using IMAP, POP3, or EWS protocols with Basic authentication.

[Chrome and Edge Manifest V3 extensions](#) on page 1138

As Google will deprecate Manifest V2 extensions, this might impact your existing automations that use the current Manifest V2 extensions for Google Chrome and Microsoft Edge browsers. We have published Manifest V3 extensions with the Automation 360 v.26 release to help you start switching to Manifest V3 extensions.

[Microsoft Internet Explorer EOL overview](#) on page 1097

Microsoft has announced retiring Internet Explorer (IE) for certain versions of Windows operating systems and recommends impacted users to move their apps or websites running on IE to Microsoft Edge with IE mode.

Related reference

[Microsoft 365 Outlook package updates](#) on page 917

Review the updates in released versions of Microsoft 365 Outlook package such as new and enhanced features as well as fixes and limitations. The page also lists the release dates of each version, and the compatible Control Room and Bot Agent versions.

## Bot Scanner for EOL features

Verify if your automations include EOL features such as EWS API, basic authentication, and Internet Explorer by using the Bot Scanner. Review the report generated by the scanner and take the required next steps to ensure your automations continue to run successfully.

---

**Note:** The contents on this page apply only to Bot Scanner for EOL features. For information about Bot Scanner used for migration (from Enterprise 11 to Automation 360), see [Bot Scanner for migration](#) on page 1529.

---

### Scanning bots that use EWS API

You can use Bot Scanner to scan bots that are using EWS APIs in the Email package and Email trigger.

Bot Scanner scans all bots and identifies those that use EWS API so that you do not have to identify them manually. The Bot Scanner then generates a report that provides details on the number of bots that can be updated, along with review messages.

For more information, see [Scan bots for Basic authentication](#) on page 1134.

### Scanning bots that use basic authentication

You can use Bot Scanner to scan bots that are using basic authentication in the Email package and Email trigger.

Bot Scanner scans all bots and identifies those that use basic authentication so that you do not have to identify them manually. The Bot Scanner then generates a report that provides details on the number of bots that can be updated, along with review messages.

For more information, see [Scan bots for Basic authentication](#) on page 1134 and [Basic authentication scanning messages](#) on page 1137.



## Scanning bots that use Internet Explorer

You can use Bot Scanner to scan Internet Explorer bots that have to be converted to a supported browser.

To help convert bots that use Internet Explorer, Bot Scanner scans all bots and identifies those that use Internet Explorer so that you do not have to identify them manually. The Bot Scanner then generates a report that provides details on the number of bots that can be converted and the number of bots that cannot be converted, along with review messages.

For more information, see the following topics:

- [Scan Automation 360 bots for Internet Explorer usage](#) on page 1113
- [Analyze report for Internet Explorer bots](#) on page 1115
- [Internet Explorer conversion or scanning messages](#) on page 1715

## Microsoft Internet Explorer EOL overview

Microsoft has announced retiring Internet Explorer (IE) for certain versions of Windows operating systems and recommends impacted users to move their apps or websites running on IE to Microsoft Edge with IE mode.

While support for the Control Room (Automation 360 v.25) on IE will end, new and advanced features will be added to Automation 360 v.24R2 patch that will be supported on alternative browsers.

To ensure your existing IE bots are supported on Microsoft recommended browsers, such as Microsoft Edge with IE mode, based on the release you have installed, we recommend that you update to Automation 360 v.24R2 patch. To support conversion of IE bots to Microsoft Edge with IE mode, the following tools are available in this patch:

- Bot Scanner to scan Enterprise 11 bots for IE usage. This helps you to plan your efforts in the IE bot conversion process whether you continue on Enterprise 11 or migrate to Automation 360.  
[Bot Scanner for migration](#) on page 1529 | [Scan Enterprise 11 or 10 bots using Bot Scanner](#) on page 1531
- Bot Migration Wizard to support conversion of IE bots to Microsoft Edge with IE mode. This will help Enterprise 10 or Enterprise 11 users to migrate bots to Automation 360 and convert the IE bots at the same time.  
[Bot Migration Wizard](#) on page 1587
- Update Bot wizard to help Automation 360 new users as users who have migrated from Enterprise 10 or Enterprise 11 and want to convert their IE bots to Microsoft Edge with IE mode.  
[Update Bot wizard for converting IE bots](#) on page 1118

See the following video on preparing your automations for IE EOL:

## Update scenarios

- If you are using Enterprise 10, to update your IE bots to Microsoft Edge with IE mode, you can choose one of the following methods:

- Upgrade to Automation Anywhere Enterprise Version 11.3.5.6 that supports IE bot conversion to Microsoft Edgewith IE mode, convert your IE bots to Microsoft Edge with IE mode, and later migrate to the latest Automation 360 release.
- Upgrade to Automation 360 v.24R2 patch, migrate your IE bots and update the IE bots to Microsoft Edge with IE mode.
- If you are using Enterprise 11 and are yet to migrate to Automation 360, update to Automation Anywhere Enterprise Version 11.3.5.6, which supports Microsoft Edge with IE mode. You can then migrate to Automation 360.

[Supported Control Room versions for migration](#) on page 1506

- If you are using Enterprise 11 and plan to complete migration to Automation 360 before IE EOL, you can migrate to the latest Automation 360 v.24R2 patch, which supports Microsoft Edge with IE mode.
- If you are using Enterprise 11 and plan to complete migration to Automation 360 after IE EOL, you can use one of the following methods:
  - Update to the latest Automation 360 release, convert the migrated bots created in IE to Microsoft Edge with IE mode.
  - Update to the latest Enterprise Client version that supports Microsoft Edge with IE mode and convert the pending bots created in IE to Microsoft Edge with IE mode in Enterprise 11, and later migrate these bots to the latest Automation 360 release.
- If you are using Automation 360 v.24 On-Premises or earlier and have created IE bots, you can update to Automation 360 v.24R2 patch to convert your IE bots to Microsoft Edge with IE mode.

**Note:** To ensure that your bots continue to run on Internet Explorer after EOL, Microsoft recommends that you register your site or application running on Internet Explorer to the Microsoft Site List manager. See [Enterprise Mode and the Enterprise Mode Site List](#).

For additional information on different upgrade scenarios, see [Enterprise 11 and upcoming Internet Explorer 11 EOL FAQ](#) | [Microsoft Internet Explorer 11 EOL FAQ](#) on page 1100

## IE bot update workflow

Update from Automation 360 to Automation 360 On-Premises

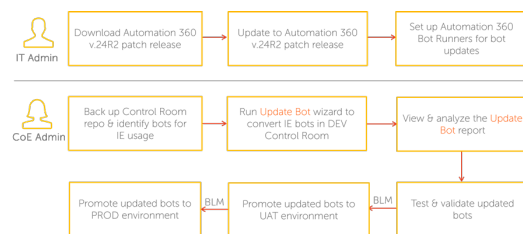

1. Update to the latest Automation 360 release.

[Update Automation 360 to latest version](#) on page 1423

2. Set up Automation 360 Bot Runners for bot updates.

[Install Bot Agent and register device](#) on page 1347

3. Back up the Control Room repository.

[Restore bots from Git repository](#) on page 1832

4. Identify bots created in Internet Explorer using the Bot Scanner.

[Scan Enterprise 11 or 10 bots using Bot Scanner](#) on page 1531

5. Convert the bots created in IE to Microsoft Edge with IE mode using the Update Bot wizard.

[Update Bot wizard for converting IE bots](#) on page 1118

6. Analyze the updated bots report using the Update Bot wizard.

[Viewing conversion details for Internet Explorer bots](#) on page 1120

7. Verify that the updated bots can run or be deployed.

[Schedule a bot](#) on page 2129 | [Run a bot](#) on page 2282

---

**Important:** Before you deploy your bots, register your site or application running on Internet Explorer to the Microsoft Site List manager. For details, see [Enterprise Mode and the Enterprise Mode Site List](#).

---

Note that you can convert your IE bots to Microsoft Edge with IE mode in one environment (for example, DEV) and then move these bots to another environment (for example, UAT and PROD) without updating the bots in each environment.

### Upgrade from Enterprise 11 to latest Automation 360 On-Premises

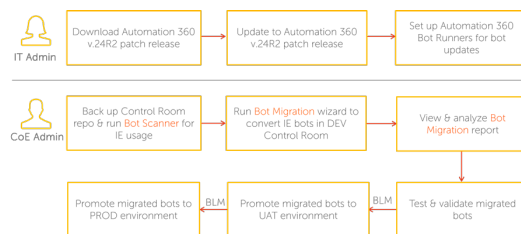

1. Upgrade from Enterprise 11 to the latest Automation 360 release that supports Microsoft Edge with IE mode.

[Prepare for Enterprise 11 to Automation 360 On-Premises migration](#) on page 1563

2. Set up Automation 360 Bot Runners for bot updates.

[Install Bot Agent and register device](#) on page 1347

3. Back up the Control Room repository.

[Restore bots from Git repository](#) on page 1832

4. Identify the bots created in Internet Explorer using the Bot Scanner.

[Scan Enterprise 11 or 10 bots using Bot Scanner](#) on page 1531

5. Migrate Bot Runners and IE bots from Enterprise 11 to Automation 360.

[Bot Migration Wizard](#) on page 1587

6. View the bot migration report.

[View migration reports](#) on page 1675

7. Verify that the migrated bots can run or be deployed.

[Schedule a bot](#) on page 2129 | [Run a bot](#) on page 2282

#### Related concepts

[Microsoft Internet Explorer 11 EOL FAQ](#) on page 1100

Microsoft has announced end-of-life (EOL) for Internet Explorer beginning June 2022 and recommends using Microsoft Edge or Microsoft Edge in Internet Explorer (IE) mode. This will impact automations (bots) based on the operating system currently in use where the bots are run.

[Microsoft Internet Explorer 11 EOL FAQ](#) on page 1100

Microsoft has announced end-of-life (EOL) for Internet Explorer beginning June 2022 and recommends using Microsoft Edge or Microsoft Edge in Internet Explorer (IE) mode. This will impact automations (bots) based on the operating system currently in use where the bots are run.

#### Related reference

[Automation 360 v.24R2 Release Notes for Internet Explorer 11 EOL](#) on page 347

#### Related information

[Enterprise 11 and upcoming Internet Explorer 11 EOL FAQ](#)

## Microsoft Internet Explorer 11 EOL FAQ

Microsoft has announced end-of-life (EOL) for Internet Explorer beginning June 2022 and recommends using Microsoft Edge or Microsoft Edge in Internet Explorer (IE) mode. This will impact automations (bots) based on the operating system currently in use where the bots are run.

For details, see the following table:

Microsoft operating system	Automation 360 and Enterprise 11 bots
Windows 10 Semi-Annual Channel	Update bots to use a compatible browser.  For a list of supported browsers, see <a href="#">Browser requirements for Automation Workspace</a> on page 1210.
All other supported operating systems	No immediate impact

Starting from the Automation 360 v.25 release, you will be prompted to access the Control Room through an alternative supported browser, such as Google Chrome or Microsoft Edge (Chromium) instead of Internet Explorer. Your Control Room will no longer be accessible on Internet Explorer. By aligning with the Microsoft strategy for browser support, we can provide you with enhanced functionality that latest browsers such as Google Chrome and Microsoft Edge make technologically possible.

## General FAQ

How do I know if I am going to be impacted by the Internet Explorer EOL? To assess whether you are actually impacted by the Internet Explorer EOL, you need to do the following:

- Check whether the underlying legacy application or website can run only on Internet Explorer and is not moved to any other browser.
- Check whether the device on which the bot is running has Windows 10 version using Semi-Annual Channel (SAC) license.

If the answer to both of the above is Yes, you are impacted by the Internet Explorer EOL.

Why this change?

Microsoft recently announced that Internet Explorer will be retired on June 15, 2022 for certain versions of Windows operating systems.

While we will end support for the Control Room on Internet Explorer, we will continue to add new and advanced features that will be supported on alternative browsers.

[Browser requirements for Automation Workspace](#) on page 1210 | [Internet Explorer EOL](#)

When will the support end?

Starting from the upcoming Automation 360 v.25 release, any user trying to access the Control Room through Internet Explorer will be prompted to use alternative browsers such as Google Chrome or Microsoft Edge (Chromium).

Can I connect to Enterprise 11 or Enterprise 10 Control Room?

You can continue to use Internet Explorer to connect to the Enterprise 11 Control Room.

What about the automations that I have already built using Internet Explorer?

Microsoft is planning to discontinue support for Internet Explorer from June 2022 on certain operating systems. If this change impacts you, you should start planning to update your automations to use other browsers, such as Microsoft Edge (Chromium).

See [Internet Explorer EOL](#) for list of Windows operating systems supporting Internet Explorer.

For information about scenario-based automation updates, see [Migration FAQ](#) on page 1103.

Does the EOL impact my running automations if they are running on OS versions other than Windows 10 Professional or Enterprise licensed through the Semi-Annual Channel (SAC)?

No, your automations will not be impacted if they are running on OS versions other than Windows 10 Professional or Enterprise licensed through SAC. For more information, see the FAQ available from Microsoft.

[Internet Explorer EOL](#)

My organization has legacy apps and websites based on Internet Explorer 11 that are automated using Automation 360. We plan to move our legacy apps to Microsoft Edge with Internet Explorer mode before the EOL date. What will happen to my existing automations built on Internet Explorer 11?

After you move your legacy apps to Microsoft Edge with Internet Explorer mode, the automations that you previously built on Internet Explorer 11 will run only after you edit them and make them work for Microsoft Edge with Internet Explorer mode.

You might have to capture the objects again and update the corresponding actions on these objects so that the automations can run successfully on Microsoft Edge with Internet Explorer mode.

My application is running on Microsoft Edge with Internet Explorer mode. Can I create and run object-based automations on Microsoft Edge with Internet Explorer mode using Automation 360?

Yes, starting from Automation 360 v.23, object-based automations are supported for Microsoft Edge with Internet Explorer mode. You can record objects and perform various actions by using Universal Recorder to automate your applications that run on Microsoft Edge with Internet Explorer mode.

---

**Note:** A separate plug-in extension is not required. You can use the Microsoft Edge plug-in extension for your Microsoft Edge browser with Internet Explorer mode as well.

---

Will Automation Anywhere provide any tool to convert automations that use Internet Explorer to Microsoft Edge?

Microsoft recommends users to use Microsoft Edge in Internet Explorer Compatibility mode. We will be providing a utility to convert automations that use Internet Explorer to

use Microsoft Edge in Internet Explorer Compatibility mode.

## Migration FAQ

What is the guidance for Automation 360 users on the general availability of a conversion tool?

For Automation 360 users, we are planning a patch release on Automation 360 v.24 for On-Premises and Cloud users. You must apply this patch to take advantage of the support for Microsoft Edge with Internet Explorer mode. This patch contains packages that are certified on Microsoft Edge in Internet Explorer mode and a bot update wizard. You can either manually update your bots or use the bot update wizard to update your bots in bulk so that they work with Microsoft Edge in Internet Explorer mode.

---

**Note:** On-Premises users can get early access to this patch to test it in the dev environment.

---

What is the guidance for Enterprise 11 users on the general availability of a conversion tool?

For Enterprise 11 users, we are planning to release a patch on the Version 11.3.5.x trail to support Microsoft Edge in Internet Explorer mode. You must update to the latest version to take advantage of this patch. Along with this patch, a conversion utility and an enhanced Bot Scanner will also be released. With the enhanced Bot Scanner, you can get statistics on the usage of Internet Explorer in your bots so that you can plan and devise an overall conversion strategy. You can either manually update your bots or use the conversion utility to convert your bots in bulk to work with Microsoft Edge in Internet Explorer mode.

---

**Note:** You can get early access to this patch to test it in the development (dev) environment.

---

If you are migrating from Enterprise 11 to Automation 360, you can combine the migration and conversion of your bots to use Microsoft Edge in Internet Explorer mode in a single operation after updating to the Automation 360 v.24 patch.

What options are available for users to maintain business continuity if their automations are being affected by the Internet Explorer EOL?

You can maintain business continuity by choosing one of the following options:

1. Change the license of your Windows version from Semi-Annual Channel (SAC) to Long-Term Servicing Channel (LTSC).

For details, see [Internet Explorer EOL](#).

2. Upgrade the Windows operating system version for your device that is running automations to a version other than Windows 10 SAC.

For details, see [Internet Explorer EOL](#).

3. Manually edit the affected bots by recapturing the application objects by using supported browsers (other than Internet Explorer) and change the window titles, variables, or any of the corresponding actions that are browser-specific. Validate your automation and run the updated bots on target applications in the selected browser.

---

**Note:** This is not applicable to migrated Enterprise 11 or Enterprise 10 bots that use the Web Recorder command.

---

4. Recreate the bots, replacing the old ones by using any of the supported browsers, such as Microsoft Edge or Google Chrome.
5. Use the conversion tool provided by Automation Anywhere to convert your bots based on Internet Explorer to Microsoft Edge with Internet Explorer mode.

---

**Note:** The tool cannot be used to convert bots built in Internet Explorer to other supported browsers, such as Google Chrome, Microsoft Edge (Standard mode), or Mozilla Firefox.

---

After the Windows update, Internet Explorer requests are redirected to Microsoft Edge. Will the IE mode be set automatically or need to be set manually?

- The approach recommended by Microsoft is to register your site or application running on Internet Explorer to the Microsoft Site List manager.

For details, see [Enterprise Mode and the Enterprise Mode Site List](#).

- Alternatively, you can list certain websites to open only in IE mode by using the Microsoft Edge IE mode compatibility settings in Microsoft Edge. Note that these settings need to be updated every 30 days.



Migration scenario A: If you are new to Automation 360 and have bots built using Internet Explorer, or if you have migrated from Enterprise 11 or Enterprise 10 to Automation 360 and have bots built using Internet Explorer, review the following information.

What do I need to do to ensure that my automations built on Internet Explorer continue to run after Internet Explorer reaches EOL?

To ensure that your automations continue to run on Internet Explorer after EOL, you need to do the following:

- Register your site or application running on Internet Explorer to the Microsoft Site List manager. For details, see [Enterprise Mode and the Enterprise Mode Site List](#).
- Update Automation 360 to the latest patch on Automation 360 v.24 release with support for Microsoft Edge with Internet Explorer mode.
- Use the Update bot wizard to convert each bot running on Internet Explorer to Microsoft Edge with Internet Explorer mode.
  - Bots that do not use commands related to Internet Explorer will not be converted.
  - If the bot update is completed without any errors, a new version of the bot will be created in the Control Room public repository.
- Check the update bot report to see whether you need to review the updated bot or take any action.
- Run the updated bot to validate that the bot runs fine in Microsoft Edge with Internet Explorer mode.

I am using an earlier version of Automation 360 On-Premises. Can I directly update to Automation 360 v.24 patch release or should I manually uninstall the previous version and install the new patch version?

Yes, you can directly update your existing Automation 360 version to the latest Automation 360 v.24 patch release.

Note that we support directly updating from n-3 releases (where n is the latest release). For updating from a version of Automation 360 earlier than that, you must perform a multistep update. For example, if you are on Automation 360 v.19, you must first update to Automation 360 v.22 and then to Automation 360 v.24.

Do I need to update my Automation 360 Bot Agent?

Yes, the Bot Agent needs to be updated.

Starting from the Automation 360 v.24 release, Bot Agent update is optional with some releases.

Migration scenario B: If you are currently on Enterprise 11 or Enterprise 10 and plan to migrate to Automation 360, review the following information.

I have not started the migration to Automation 360 yet. What is your recommendation for planning the migration?

Migration to Automation 360 involves the conversion of the Enterprise 11 or Enterprise 10 bots to Automation 360 compatible format so that the converted bot runs successfully in Automation 360.

If these bots are automated using Internet Explorer 11, then you will have to include the efforts involved in further converting these bots to Microsoft Edge with Internet Explorer mode and validate the bots in the new browser.

If you are on Enterprise 11 and are impacted by Internet Explorer EOL, our recommendation is that you continue on Enterprise 11 and convert the bots related to Internet Explorer to Microsoft Edge with Internet Explorer mode so that you can test and validate the bots before the EOL date.

For details on the conversion tool, see [Enterprise 11 and upcoming Internet Explorer 11 EOL FAQ](#). Migration to Automation 360 can be planned at a later date according to your convenience.

If you are on Enterprise 10 and are impacted by Internet Explorer EOL, we recommend that you migrate to Enterprise 11 first and convert the bots related to Internet Explorer to Microsoft Edge with Internet Explorer mode so that you can test and validate the bots before the EOL date.

For details on the conversion tool, see [Enterprise 11 and upcoming Internet Explorer 11 EOL FAQ](#). Migration to Automation 360 can be planned at a later date according to your convenience.

For any new bots that you plan to build in Enterprise 11 or Enterprise 10, we recommend that you build them in Automation 360 by using any of the supported browsers to minimize the impact of the Internet Explorer EOL.

Migration scenario C: If you are currently on Enterprise 11 or Enterprise 10 and are in the middle of migration to Automation 360, review the following information.

I have migrated a few bots to Automation 360, which use Internet Explorer, and have a few bots that are pending migration in Enterprise 11, which use Internet Explorer. What is the your

If you are in the middle of your migration journey, maintaining two parallel environments where there are bots based on Internet Explorer on both Enterprise 11 and Automation 360 versions, then you need to ensure that these

recommendation regarding maintaining two parallel environments?

bots are converted to Microsoft Edge in Internet Explorer mode in their respective environments in case you cannot complete migration of your pending Enterprise 11 bots to Automation 360 before the Internet Explorer EOL.

For Enterprise 11 bots based on Internet Explorer, upgrade your Enterprise 11 to the latest Version 11.3.5.x patch release, which supports Microsoft Edge with Internet Explorer mode. After the upgrade, use the Enterprise 11 conversion utility to convert these bots in Microsoft Edge with Internet Explorer mode so that these bots continue to run in Enterprise 11 even after the Internet Explorer EOL.

Similarly, for Automation 360 bots based on Internet Explorer, update to the latest Automation 360 v.24 patch release, which supports Microsoft Edge with Internet Explorer mode. After the update, use the Automation 360 bot update wizard to convert these bots in Microsoft Edge with Internet Explorer mode so that these bots continue to run in Automation 360 even after Internet Explorer EOL.

You can later decide when to migrate the Enterprise 11 bots converted to Microsoft Edge with Internet Explorer mode to Automation 360. When you decide to do so, note that you can use the Automation 360 Bot migration wizard without the **Convert bots built using IE to Edge with IE mode** option.

For details, see [Bot Migration Wizard](#) on page 1587.

---

**Note:** For Enterprise 10 bots based on Internet Explorer, we do not plan to release a patch on Enterprise 10 that supports Microsoft Edge with Internet Explorer mode. Hence, Enterprise 10 users must ensure that their bots based on Internet Explorer are migrated to Automation 360 v.24 patch release.

---

How can I determine which bots use commands or actions related to Internet Explorer and hence require conversion to Microsoft Edge with Internet Explorer mode?

For Enterprise 11 bots, you can run the Bot Scanner utility with an option to scan bots for Internet Explorer usage. This utility generates a report that lists all the bots that use commands related to Internet Explorer.

For Automation 360 bots, the tool to scan bots and generate Internet Explorer usage report is currently not available.

Do I need to manually change the bot after it is migrated to Automation 360 using the Bot Migration Wizard along with the Convert bots built using IE to Edge with IE mode option?

Yes, only for bots that are migrated to Automation 360 with **Action Required** or **Review Required** messages. Review the messages in the Migration Report that suggest that the user edit the bot, for example, if the bot uses a reference of Internet Explorer in the window title through a variable, file, and so on.

Contact your assigned CSM or Support for any further questions about this change.

## Known behavior and limitations

The following table lists known behavior and limitations that apply to bots migrated from Enterprise 11 to Automation 360 and to Automation 360 bots that run on Microsoft Internet Explorer and are converted to Microsoft Edge with IE mode.

Description	Applies to Enterprise 11 to Automation 360 (migration)	Applies to Automation 360 to Automation 360 (updating)
The bot conversion utility updates only bots that use Internet Explorer for automations and does not update bots that use other browsers.	Yes	Yes
For web pages or URLs to open in Microsoft Edge with Internet Explorer mode, you must register your site or application running on Internet Explorer to <b>Microsoft Site List Manager</b> or Group Policy within your organization. <a href="#">Enterprise Mode and the Enterprise Mode Site List</a>	Yes	Yes
The Open Program/File command that contains a variable to store the location of the program or file property is not migrated or converted to use Microsoft Edge with Internet Explorer mode. If the variable is pointing to Internet Explorer, update it to point to Microsoft Edge browser instead.	Yes	Yes

Description	Applies to Enterprise 11 to Automation 360 (migration)	Applies to Automation 360 to Automation 360 (updating)
<p>The following commands are not migrated or converted because browser components such as the menu bar, status bar, favorites bar, command bar, and other non-web page components differ in each browser. This can potentially impact captured screens or properties of the actions. We recommend that you review and recapture the screen or update the properties if required.</p> <ul style="list-style-type: none"> <li>• Image Recognition</li> <li>• OCR</li> <li>• Mouse</li> <li>• Wait &gt; <b>Wait for screen</b> (Menu/Non-HTML objects)</li> <li>• Screen</li> <li>• Recorder</li> <li>• App Integration &gt; <b>Capture area</b></li> </ul>	Yes	Yes
Keystroke action that is based on the menu bar of a browser is not migrated or converted.	Yes	Yes
<p>For Mouse commands such as <b>Click, Move</b> or <b>Scroll</b>, due to the difference in header bar height in Internet Explorer and Microsoft Edge with Internet Explorer mode, there might be an incorrect Y-axis after the migration or conversion.</p> <hr/> <p><b>Note:</b> This difference applies only to the Y-axis and not X-axis.</p> <hr/>	Yes	Yes
<p>In the Image Recognition command, when the target image is on the lower and upper boundaries of the source image, the command is not migrated or converted because of the difference in the height of the header bar in Internet Explorer and Microsoft Edge browsers. The following target actions are impacted: <b>Right click, Left click, and Double click.</b></p>	Yes	Yes
<p>Review and recapture all commands, except Image Recognition that captures window coordinates with negative values, after migration or conversion.</p> <hr/> <p><b>Note:</b> In Enterprise 11, the coordinates are captured the top-left of the screen at 0, 0. In Automation 360, the coordinates are captured as negative values.</p> <hr/>	Yes	Yes

Description	Applies to Enterprise 11 to Automation 360 (migration)	Applies to Automation 360 to Automation 360 (updating)
<p>Due to differences in the height of the header bar in Internet Explorer and Microsoft Edge with Internet Explorer mode, the output of the actions might not be as expected. The following commands are impacted:</p> <ul style="list-style-type: none"> <li>• OCR&gt; <b>Capture area</b></li> <li>• Mouse <ul style="list-style-type: none"> <li>• Button: Left button, Middle button, Right button</li> <li>• Event: Click, Double click, Button down, Button up</li> </ul> </li> <li>• Screen&gt; <b>Capture area</b></li> </ul>	Yes	Yes
<p>Window titles with regular expression variables containing partial text from Internet Explorer might be converted to the corresponding title in Microsoft Edge. However, sometimes the conversion might not happen. For example:</p> <ul style="list-style-type: none"> <li>• Internet</li> <li>• .Int,</li> <li>• Int</li> <li>• Expl*</li> <li>• .Expl</li> <li>• Internet Exp</li> </ul>	Yes	Yes
<p>Using the Microsoft registry setting, if you have changed the default text of the Internet Explorer window title bar to your preferred text, the changes applied on the title bar are not available after conversion.</p>	Yes	Yes
<p>In the Open Program/File, if you have used the <code>taskkill /F /IM iexplore.exe</code> command to terminate Internet Explorer, then after conversion, when you run the bot, it will forcefully terminate <code>msedge.exe</code>. But when you run the bot for the second time, it will display a <code>Microsoft Edge Closed Unexpectedly</code> error message. We recommend that you avoid the use of <code>/F</code> so that the bots run seamlessly.</p>	Yes	Yes

Description	Applies to Enterprise 11 to Automation 360 (migration)	Applies to Automation 360 to Automation 360 (updating)
<p>Local HTML files are not supported for loading in Microsoft Edge with Internet Explorer mode through <b>Enterprise Site List Manager</b>.</p> <p>Workaround: You can deploy the local HTML file in localhost.</p> <p>Example: The <code>file:///C:/SampleHTML/sample.html</code> URL will be replaced with <code>https://localhost/SampleHTML/sample.html</code></p>	Yes	Yes
<p>The wait for the browser does not work for Microsoft Edge with Internet Explorer mode for commands such as Mouse, Insert Keystrokes, or Recorder. After conversion, the User32 API does not return the child window list. As a result, it cannot find the page Microsoft Edge with Internet Explorer mode.</p>	Yes	Yes
<p>Object Cloning commands developed on a Citrix environment with Xen App Remote Agent and Microsoft Edge with Internet Explorer mode are not supported.</p> <p>Object Cloning commands developed on Silverlight and Flash technologies and Microsoft Edge with Internet Explorer mode are not supported.</p>	Yes	Not applicable
<ul style="list-style-type: none"> <li>• Object Cloning commands (with coordinates play mode) where Internet Explorer based toolbar is enabled and locked are not migrated or converted.</li> <li>• Object Cloning commands (with coordinates play mode) are not migrated or converted because browser components such as menu bar, status bar, favorites bar, command bar, and other non-web page components differ in each browser. This can potentially impact the captured screens or the properties of the actions. We recommend that you review and recapture the screen or update the properties if required.</li> <li>• Due to the difference in the height of the header bar in Internet Explorer and Microsoft Edge with Internet Explorer mode, an incorrect Y-axis might occur after the migration or conversion. This difference can be seen in <b>Get text, Set text, Left click, Right click, Middle click, Double click</b> of the coordinates play mode.</li> </ul> <hr/> <p><b>Note:</b> This difference applies only to the Y-axis and not X-axis.</p> <hr/>	Yes	No

Description	Applies to Enterprise 11 to Automation 360 (migration)	Applies to Automation 360 to Automation 360 (updating)
Migrated bots with Mouse <b>Click</b> command might not work as expected when the <b>Relative to</b> property is Screen. This is because of the difference in the offset of the address bar between Internet Explorer and Microsoft Edge.	Yes	Yes
Objects captured on Internet Explorer using <b>Standard</b> or <b>Legacy</b> technology in the Object Cloning command will not work after migration or conversion.	Yes	No
The commands that store window titles with wildcard characters such as *Applet* are based on the Internet Explorer browser window with Web Java technology. If you have selected the <b>None of the above</b> option for such commands, note that the commands will not work in Microsoft Edge with IE mode as these are not migrated to Edge.	Yes	No
Bot Scanner does not count the commands that use variables to store the window title as part of the statistics. However, these commands are displayed in the <b>Review Required</b> tab so you can review these commands manually to verify if the window title is based on the Internet Explorer browser window.	No	Yes
User Interface (UI) based and window triggers with Internet Explorer based window title are not migrated or converted.	No	Yes
Recorder developed on a Citrix environment with Xen App Remote Agent, and Microsoft Edge with Internet Explorer mode is not supported.  Recorder actions developed on Silverlight and Flash technologies and Microsoft Edge with Internet Explorer mode is not supported.	Not applicable	Yes
For the Bot Migration Wizard and Update Bot wizard, when you select the <b>Bot Assistant</b> screen to view the migration review and action messages, the review message is not displayed based on the version. In the <b>Update Bot Assistance</b> menu, the review message is overridden by the migration review message.	No	Yes



Description	Applies to Enterprise 11 to Automation 360 (migration)	Applies to Automation 360 to Automation 360 (updating)
<p>When you use the Update Bot wizard to convert Automation 360 bots that run on Microsoft Internet Explorer to Microsoft Edge, the <b>In progress</b> status will be shown indefinitely for the following scenarios:</p> <ul style="list-style-type: none"> <li>• When the bot fails to compile</li> <li>• When the bot fails to deploy</li> <li>• When the Bot Agent service stops or fails</li> <li>• When the Bot Runner user is not assigned the Allow a Bot user to update bots permission</li> </ul>	Not applicable	Yes

Related concepts

[Microsoft Internet Explorer EOL overview](#) on page 1097

Microsoft has announced retiring Internet Explorer (IE) for certain versions of Windows operating systems and recommends impacted users to move their apps or websites running on IE to Microsoft Edge with IE mode.

[Microsoft Internet Explorer EOL overview](#) on page 1097

Microsoft has announced retiring Internet Explorer (IE) for certain versions of Windows operating systems and recommends impacted users to move their apps or websites running on IE to Microsoft Edge with IE mode.

Related reference

[Automation 360 v.24R2 Release Notes for Internet Explorer 11 EOL](#) on page 347

Related information

[Enterprise 11 and upcoming Internet Explorer 11 EOL FAQ](#)

## Scan Automation 360 bots for Internet Explorer usage

Microsoft Internet Explorer end of life (EOL) is in June 2022, and Microsoft recommends that you to move your legacy applications and websites running on Internet Explorer to Microsoft Edge with IE mode. Use the Automation 360 Bot Scanner for IE utility to scan your Automation 360 bots for Internet Explorer usage.

- Ensure that your Control Room user has the **View content** permission on the Bots folder.
- Ensure that you meet the following system requirements for using the Bot Scanner:
  - Hardware requirements

Processor	2.66 GHz or higher (64-bit)
RAM	2 GB or higher
Disc space	200 MB

- Software requirements

Operating systems: Windows 7 or later (32-bit or 64-bit)

1. Navigate to [A-People Downloads page \(Login required\)](#).
2. Download `automation-360-bot-scanner-for-ie-1.0.zip` from **Automation 360 v.24 R2 (13343) > Installation Setup**.
3. Extract the files from the zip file you have downloaded and double-click the executable file to run the utility.
4. Click **Get started**.
5. Enter the Control Room URL of Automation 360 (On-Premises or Cloud) that you want to connect to, and access the `Bots` repository that contains the Internet Explorer bots that you want to scan.

---

**Note:** The Bot Scanner for IE utility does not support a proxy server. If you use a proxy to provide the Control Room URL, you will not be able to establish the connection.

---

6. Based on the authentication type configured in your Control Room, choose one of the following authentication methods in the **Authentication Type** field:

Authentication type	Steps
Database	<ol style="list-style-type: none"> <li>a) Enter the <b>Username</b> (Control Room database username).</li> <li>b) Enter the <b>Password</b> (Control Room database user password).</li> </ol>
Active Directory (default)	<ol style="list-style-type: none"> <li>a) Enter the <b>Username</b> (Domain\username).</li> <li>b) Enter the <b>Password</b> (domain user password).</li> </ol>
Single Sign-On	<ol style="list-style-type: none"> <li>a) Enter the <b>Username</b>.</li> <li>b) Enter the <b>API Key</b>.</li> </ol>

7. Click **Test connection**.  
A connection success or failure message is displayed. Recheck your credentials if the connection fails.
8. In the **Select destination path** field, enter the location where you want to save the generated report.
9. Click **Scan bots**.  
The scanner scans all the bots in the Control Room repository for Internet Explorer usage. After the scan is complete, a report is generated (.CSV file) containing all the details. If a .CSV file already exists in the output folder, you are prompted with a message indicating that the old .CSV file will be deleted, and after you click **Continue**, a new .CSV file is generated. If the old .CSV file is in use, a message is displayed indicating that the file cannot be deleted. Close the file and try again.
10. Click **Open report** to analyze the report generated by the scanner to get usage statistics about Internet Explorer in your bots.

The report contains the following details:

- Task Bot name: Name of the Task Bot
- Line number: The line number of the bot where the Internet Explorer browser is used
- Package and action name: The package and action name where the Internet Explorer browser is used
- Searched text: Provides the window or browser title
- Action and review message: Contains the reviews or action required by the user after conversion
- Task Bot path: The path to the repository where the bot resides

---

**Note:** Based on the report generated by the scanner, you can plan and implement a strategy to convert bots that use Internet Explorer to Microsoft Edge with IE mode. Using the report you can identify the following:

- Unique Task Bot names that use Internet Explorer
  - The action in each bot that uses Internet Explorer
  - Whether an action can be converted or not
  - Whether an action needs review after conversion
- 

See the following video on how to scan Automation 360 bots for Internet Explorer usage:

The Bot Scanner does not convert your bots from Internet Explorer to Microsoft Edge with IE mode. For conversion, you must use the Update Bot wizard. See [Update Bot wizard for converting IE bots](#) on page 1118.

## Analyze report for Internet Explorer bots

You can analyze the report generated by the Bot Scanner to get usage statistics about Internet Explorer used in your bots.

Based on the report that Bot Scanner generates, you can plan and implement a strategy to convert bots that use Internet Explorer to Microsoft Edge with IE mode.

Bot Scanner provides the following information about these bots:

- Number of bots analyzed
- Number of bots scanned for Internet Explorer usage and those that were not scanned
- Internet Explorer usage statistics on the percentage and number of bots using Internet Explorer
- Reasons for bots that were not scanned
- Reviews required by users after conversion

The Bot Scanner is designed to scan bots (Task Bots and MetaBots) created using both Enterprise 10 and Enterprise 11 versions of Enterprise Client. The total file count includes the number of files that were skipped and not scanned.

## Folder location and reports

The reports are available at the output location you specified in the **Select destination folder** field in the **Automation Anywhere Bot Scanner** dialog box. The Bot Scanner generates a summary report and a separate report for each bot that it scanned. It creates a separate report for each logic available in a MetaBot.

A `raw-data` folder is created that contains the reports (in XML format) for each bot scanned. It helps our developers to further analyze the scanning process and take corrective actions, if required. No personally identifiable information (PII) is included in the summary report or the individual reports of the scanned bots.

If you choose to share the reports with us to help improve the product, compress the files in the `rawdata` folder and coordinate with your Customer Success Manager (CSM) or Partner Enablement Manager (PEM). No data is automatically shared with Automation Anywhere.

The system creates three folders within the `raw-data` folder that contain various reports:

- `Migratable_Bots`: Contains reports of bots that are possibly using Internet Explorer.
- `Failed_to_Analyze`: Contains reports of bots that Bot Scanner failed to analyze.
- `MetaBots`: Contains reports of MetaBots that can and cannot be migrated to Automation 360 and the ones that the Bot Scanner failed to analyze.

## Summary report for all bots

The summary report provides information about the total number of bots scanned, the number of bots scanned for Internet Explorer usage, the number bots that could not be scanned. It also provides Internet Explorer usage statistics about the percentage and number of bots using Internet Explorer.

For example, consider the Bot Scanner has scanned 31 bots. Of the 31 bots, consider 26 bots are scanned for Internet Explorer usage, and 0 bots could not be scanned. The percentage of bots using Internet Explorer is 84%.

Reviewing the Bot Scanner report

Consider a scenario where you have scanned a total of 72 bots, of which 22 bots are scanned for Internet Explorer usage and 3 bots could not be scanned. In such a scenario, the report enables you to perform the following actions:

- Identify bots (8) that require review after conversion and take action if required.
- Identify bots (14) that do not require any review after conversion.
- Identify the reason why the bots (3) cannot be currently scanned for Internet Explorer usage. The reason might be that the bot is built using a version earlier to Enterprise 10 such as Enterprise 8.

The following image is a sample report from the Bot Scanner:

**Internet Explorer Usage Statistics:**

- 31% of bots are using Internet Explorer (22 Bots)
- 20 distinct command(s) use Internet Explorer

Each metabot is counted as the number of logics that it holds, in the Bot Scanner report.

22 Bots scanned for IE usage | 3 Bots that can't be scanned now | 72 Bots scanned total

1 Review required | 2 No review required | 4 Download.csv

Bot name	Path
1 AppInt IE Regex Variable Review	C:\Work\Scanner\Source\Scanner test data\Test data\action\IE\All IE Cases\AppInt Regex\
2 Elseif All Conditions	C:\Work\Scanner\Source\Scanner test data\Test data\action\IE\All IE Cases\Elseif\
3 IF Condition all	C:\Work\Scanner\Source\Scanner test data\Test data\action\IE\All IE Cases\IF\
4 IR Review Positive Coord	C:\Work\Scanner\Source\Scanner test data\Test data\action\IE\All IE Cases\IR, OCR, Mouse,Screen, Wait\
5 Wait Review	C:\Work\Scanner\Source\Scanner test data\Test data\action\IE\All IE Cases\IR, OCR, Mouse,Screen, Wait\
6 Loop Conditions	C:\Work\Scanner\Source\Scanner test data\Test data\action\IE\All IE Cases\Loop\
7 OPF Review IE Var	C:\Work\Scanner\Source\Scanner test data\Test data\action\IE\All IE Cases\OpenPrgFile\
8 OPF Review Non IE Var	C:\Work\Scanner\Source\Scanner test data\Test data\action\IE\All IE Cases\OpenPrgFile\

The following table describes the various fields in the sample Bot Scanner report (as numbered in the previous image):

Field/option	Description
1	<ul style="list-style-type: none"> <li><b>Bots scanned for IE usage &gt; Review required &gt; Bots:</b> Go to this view for a list of bots (8 in this scenario) that should be reviewed after conversion.</li> <li>To view the review required message for a specific bot, click the bot name. The message provides information about changes if any are required in the bot after conversion.</li> </ul>
2	<p><b>Bots scanned for IE usage &gt; No review required &gt; Bots:</b> Go to this view for a list of bots (14 in this scenario) that do not require any review after conversion. Click any bot name in this list to view the XML report offline.</p>
3	<ul style="list-style-type: none"> <li><b>Bots that can't be scanned now &gt; Bots:</b> Go to this view for a list of bots (3 in this scenario) that cannot be currently scanned.</li> <li>To view the error message for a specific bot, click the bot name. An XML report opens in a new tab where you can view the error due to which the bot cannot be scanned.</li> </ul>
4	<p>Download (as a CSV file) the list of bots or commands that can or cannot be scanned so that you can review the file offline or share the file with others.</p>

### Report validity

The report is valid until the next version of Bot Scanner is available. When the next version is available, a report expiry message is displayed. You must download the latest version of Bot Scanner and use that version to scan the bots again.

## Update Bot wizard for converting IE bots

Use the Update Bot wizard to convert Internet Explorer bots created in Automation 360 to Microsoft Edge with IE mode.

- Ensure you are logged in as an administrator or have given the following permissions to the user performing the bot update and to the Bot Runners you have selected:
  - Users performing the bot update:
    - **View bot update**
    - **Manage bot update**
    - **View Users and Roles basic information**
    - **View everyone's audit log actions**
    - **View packages**
    - **View my bots**
    - **Run my bots**
    - You must have the below-mentioned permissions for Bots, Sample bots, and the folders containing the bots you want to update:
      - **Run**
      - **Check in**
      - **Check out**
      - **View content**
    - A role that has access to Bot Runners that you want to select for running the update (on the **Administration > Bot update > Bot Runners** page)
  - Bot Runners:
    - An unattended Bot Runner license
    - **Autologin Set** status
    - **Allow a bot-runner user to update bots**
    - **Create folders**
    - **View packages**
    - **Register device**
    - **View my bots**
    - **Run my bots**
    - Below permissions for the folders containing the bots you want to update,
      - **Check in**
      - **Check out**
    - **Default device** settings

For more information on creating users and roles, see [Create a user](#) on page 1739 and [Create a role](#) on page 1748.

- The Internet Explorer bots should already be identified for conversion.
- The bots must be **Checked in** and available in the **Public** workspace.

---

**Note:** You cannot use the Update Bot wizard to convert Enterprise 10 and Enterprise 11 bots created using Internet Explorer. For details, see [Bot Migration Wizard](#) on page 1587.

---

See the following video for an overview of the Bot update wizard:

1. Navigate to **Administration > Bot update** in the Control Room.  
If you have not performed any bot updates previously, the **Bot update list** on the **Bot update** page will not display bot updates.
2. Click **Update bots** to open the Update Bot wizard.
3. In the **Settings** tab, add details such as the name and description to update bots.
4. Click **Next**.
5. On the **Bots** tab, navigate to the Bots folder that contains the Internet Explorer bots.
6. Select bots from the list of available files and add the bots to the list of selected files.  
You can choose from the latest or production version bots.

---

**Note:** You do not have to select the dependent bots because the dependent bots are selected automatically.

---

7. Click **Next**.
8. Select Bot Runner devices from the list of Bot Runners to run the bot update.
9. Click **Next**.
10. Verify details such as the bot type, name, version, and folder path on the Bot and Dependent Bots tab.
11. Click **Update bots**.

The selected bots and dependent bots are deployed on the selected Bot Runners for conversion from IE to Microsoft Edge with IE mode. The bots are converted one at a time and a new version of the bots is uploaded to the Control Room public repository. A new entry for updated bots is created during the bot conversion process on the **Bot update list** page.

The page shows the status and summary of the bots updated for conversion. You can refresh the page to view the current bot conversion status.

**Bot update list**

Before you update bots

1. Make sure Bots are not checked out till the process is complete.  
2. You have the appropriate permissions for the bots

For more information, [Go to Documentation](#)

Name Search

**Bot updates (43)**

Status	Name	Start time	End time	Duration	Completed...	Failed...	Skipped...	Total...	Last modified	Modified by
In progress	Updatebots.admin.22.04.22.13.10.34	9 minutes ago	N/A	0 sec	0	0	0	1	9 minutes ago	A admin
Completed	Updatebots.22.04.21.18.50.52	18 hours ago	18 hours ago	42 sec	1	0	30	31	18 hours ago	M
Completed	Updatebots.22.04.21.17.00.40	20 hours ago	20 hours ago	28 sec	9	0	0	9	20 hours ago	J
Completed	Updatebots.22.04.21.11.59.19	1 day ago	1 day ago	38 sec	13	0	0	13	1 day ago	M
Completed	Updatebots.22.04.20.22.50.20	1 day ago	1 day ago	14 sec	2	0	1	3	1 day ago	J
Completed	Updatebots.22.04.20.20.46.27	1 day ago	1 day ago	10 sec	0	0	1	1	1 day ago	J
Completed	Updatebots.22.04.20.20.33.50	1 day ago	1 day ago	15 sec	2	0	0	2	1 day ago	J
Completed	Updatebots.22.04.20.15.24.20	1 day ago	1 day ago	13 sec	2	0	0	2	1 day ago	J
Completed	Updatebots.22.04.20.15.02.42	1 day ago	1 day ago	12 sec	2	0	0	2	1 day ago	J

A list of the different bot conversion status during the conversion process is as follows:

- **In progress:** Indicates that the bot conversion has started.
- **Completed:** Indicates that the bot conversion process is completed.
- **Failed:** Indicates that the conversion of one or more bots has failed.

12. Select **View update bots details** from the actions menu (🔑) to view the bot conversion details of each bot.  
See [Conversion report for IE bots](#).

See the following video on how to run the Bot update wizard:

Related concepts

[Bot permissions for a role](#) on page 1763

Assign bot permissions when creating a role with the View my bots feature permission.

Related tasks

[Update bots to default package version](#) on page 1910

You can quickly update bots to a secure, stable, and default package version across multiple bots.

Related reference

[Feature permissions for a role](#) on page 1749

A user with the **Manage roles** permission can create and assign roles to users to provide them with access to features and operations.

## Viewing conversion details for Internet Explorer bots

For each update bot action, you can view details about the overall summary and status of individual bot conversion that is converted from Internet Explorer to Microsoft Edge with IE mode.

### Viewing bot details

1. In the Control Room, go to **Administration > Bot update**.
2. Select an instance of the bot conversion from the list and click **View update bot details** action from the action menu for that instance.

The **Update details** page opens with detailed information about the name of the instance and the overall status of the bot conversion (at the top of the page). For more information, you can navigate to different tabs on this page: Summary, Settings, Bot Runners, and Results.

### Summary details

You can view the following details in the **Summary** tab:

- Start time: Indicates the time when the bot conversion started
- End time: Indicates the time when the bot conversion completed
- Duration: Total duration taken for bot conversion to complete
- Completed items: Total list of items that are converted with completed status
- Failed items: Total list of items that failed to convert
- Skipped items: Total list of skipped items during conversion based on appropriate reasons
- Details of the selected bots and dependencies, listed in a table

The data is listed by file name by default. You can search for specific bots and dependencies by file name.



## Settings

The **Settings** tab displays the following fields:

- Description: Displays any description you might have added before running the Update Bot wizard
- Update the bots built using Internet Explorer to Microsoft Edge Internet Explorer mode. By default, this field is set to **Yes**

## Bot Runners

This tab displays the list of Bot Runners on which the bot conversion is done.

## Results

View the status of individual bot conversion on this tab:

- Status: Status of the individual bot conversion (completed, skipped, failed)
- Type: Type of the bot, for example Task Bot
- File name: Name of the bot
- Folder path: Path where the bot resides in the public workspace
- Bot Runner: The Bot Runner machine used to perform the bot conversion
- Reason: Reason why the bot conversion is in either failed, skipped, completed with review required, or completed with action required status

When you click the **View Bot update** for an individual bot status entry in this tab, the following reason and action values for the bots are shown.

Status	Reason	Action
Pending	-	-
Completed	-	-

Status	Reason	Action
Skipped	The bot is not updated as it does not use actions based on Internet Explorer	-
Completed with Review Required	The bot has some actions updated that requires your review	View bot update issues
Completed with Action Required	The bot has some actions updated that requires your action	View bot update issues
Failed	The bot uses some actions that are not supported for update to Microsoft Edge with IE mode	View bot update issues

The view bot update page displays the following columns:

- Line number
- Action name
- Reason for Recommendation

You can view the information listed in the reason column for the line number and open the corresponding bot, go to the line number and review based on the information provided in the window or take action as required.

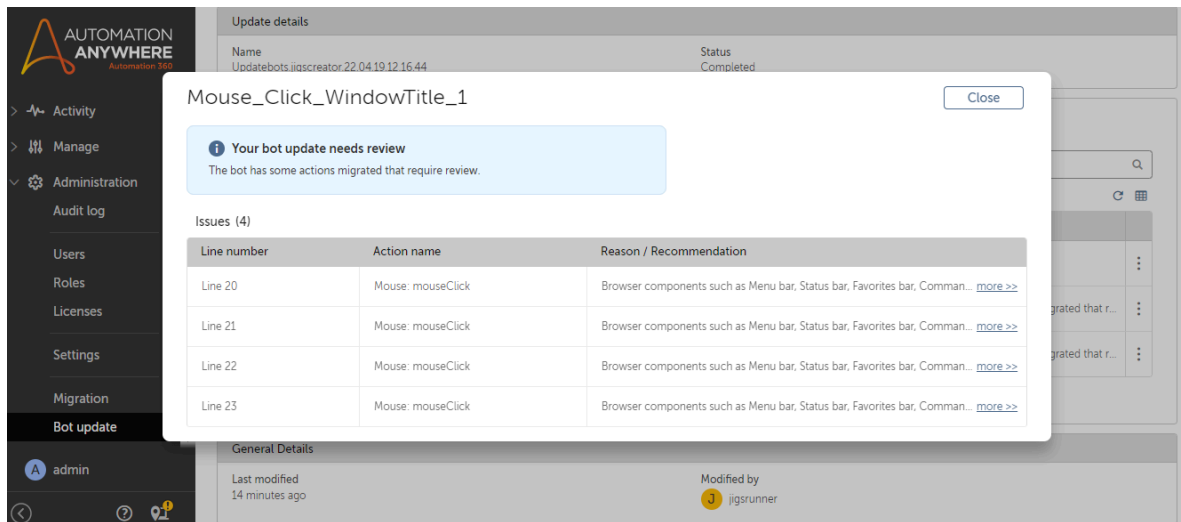

## Deprecation of Basic authentication in Exchange Online

Microsoft will permanently disable Basic authentication for specific protocols in Exchange Online starting from October 1, 2022. This impacts customers running bot for email automation that connect to Exchange Online using IMAP, POP3, or EWS protocols with Basic authentication.

**Important:** We have updated the Email package and Email trigger with newer versions as mentioned below:

Package or trigger	New version	Old version
Email package	<ul style="list-style-type: none"> <li>Version: 3.14.3-20220923-220748</li> <li>Filename: bot-command-email-3.14.3.jar</li> </ul>	<ul style="list-style-type: none"> <li>Version: 3.14.1-20220831-084727</li> <li>Filename: bot-command-email-3.14.1.jar</li> </ul>
Email trigger	<ul style="list-style-type: none"> <li>Version: 2.8.3-20220923-171042</li> <li>Filename: bot-trigger-email-2.8.3.jar</li> </ul>	<ul style="list-style-type: none"> <li>Version: 2.8.1-20220831-123116</li> <li>Filename: bot-trigger-email-2.8.1.jar</li> </ul>

We recommend that you update your impacted bots with the new versions as they are compatible with the upcoming Automation 360 v.27 release. If you continue to use the old versions and update to Automation 360 v.27 release, you might encounter issues when importing or exporting of bots or when uploading the old versions of the Email package or trigger to Automation 360 v.27. To resolve this issue, see the workaround provided in [Everything about Basic Authentication deprecation in Microsoft Exchange online \(A-People login required\)](#).

We will provide a new version of the Email package with OAuth 2.0 support in an upcoming Automation 360 package-only release by the week of August 29, 2022.

To ensure that your existing bots that are using Basic authentication in Exchange Online are supported after Basic authentication is deprecated, we recommend that you update the bots to use OAuth 2.0. To identify the Automation 360 bots that are using Basic authentication in the Email package or Email trigger, use the Bot Scanner to scan bots. This helps you to plan your efforts to update your existing bots to OAuth 2.0 in Automation 360.

- [Bot Scanner for migration](#) on page 1529
- [Scan bots for Basic authentication](#) on page 1134

## Update Automation 360 bots to use OAuth 2.0

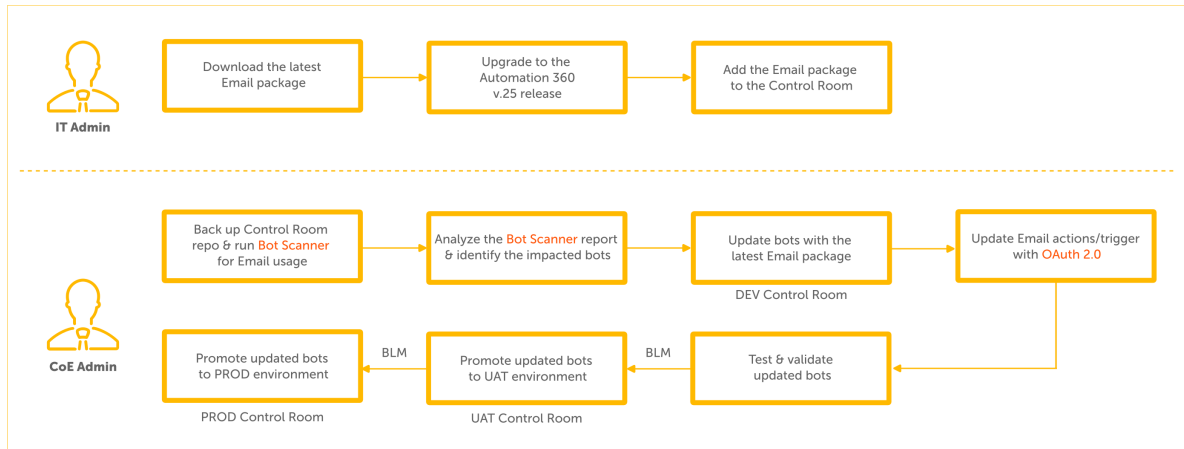

1. Update to the latest Automation 360 release.  
[Update Automation 360 to latest version](#) on page 1423
2. Back up the Control Room repository.  
[Integrating Control Room with Git repositories](#) on page 1824
3. Identify bots that are using Basic authentication using the Bot Scanner.  
[Scan bots for Basic authentication](#) on page 1134
4. Download the latest version of the Email package and add it to your Control Room.  
[Add packages to the Control Room](#) on page 1908
5. Update the bots that are using Basic authentication in the **Connect, Send, Forward, or Reply** actions or Email trigger to use OAuth 2.0.  
[Update bots using Basic authentication to OAuth 2.0](#) on page 1125
6. Verify that the updated bots can be deployed.  
[Run a bot](#) on page 2282

**Note:** You can update your bots to use OAuth 2.0 in one environment (for example, development or DEV) and then move these bots to another environment (for example, UAT and production or PROD) without updating the bots in each environment.

## Protocols impacted for Basic authentication deprecation

Microsoft is removing the capability to use basic authentication in Exchange Online for these specific protocols: MAPI, RPC, Offline Address Book (OAB), Exchange Web Services (EWS), POP, IMAP, Exchange ActiveSync (EAS), and Remote PowerShell.

**Note:** SMTP AUTH is excluded from this deprecation.

Any client (for example, user app, script, or integration) using Basic authentication for one of the affected protocols will not be able to connect to Exchange server starting October 1, 2022. An HTTP 401 error (`bad username or password`) will be displayed.

---

**Note:** Any app using OAuth 2.0 for these same protocols will not be impacted.

---

For more information, see [Basic authentication deprecation in Exchange Online – Updates](#).

## Update bots using Basic authentication to OAuth 2.0

You should update your bots that are using Basic authentication to OAuth 2.0 in the **Connect**, **Forward**, **Reply**, and **Send** actions of the Email package and Email trigger before Basic authentication is deprecated.

---

**Note:** This procedure is applicable to both Automation 360 Cloud and On-Premises customers.

---

### Prerequisites

- The `Installation Setup` folder in the `Automation 360 v.25 Basic Authentication MS Online – Deprecation` downloads folder contains the following JAR files:
  - Email package (`bot-command-email-3.14.1.jar`)  
Ensure that you download this package and add it to your Control Room in Automation 360.
  - Email trigger (`bot-trigger-email-2.8.1.jar`)  
Ensure that you download this package and add it to your Control Room in Automation 360
  - Trigger listener (`triggerlistener.jar`)  
If you are on Automation 360 v.25 release, ensure that you download and install the trigger listener file. See [Install the trigger listener file](#) on page 1128.

For information on adding packages to the Control Room, see [Add packages to the Control Room](#) on page 1908.

To download these JAR files, see [Everything about Basic Authentication deprecation in Microsoft Exchange online \(A-People login required\)](#).

- Ensure that you have run the Bot Scanner utility for the deprecated features to identify the bots that are using Basic authentication in your Control Room repository.

See [Scan bots for Basic authentication](#) on page 1134.

- Ensure that you have registered your application on the [Azure portal](#) and performed the following configurations for Client credentials flow:
  - IMAP/POP3
    1. [Register an application](#)
    2. [Authenticate an IMAP, POP or SMTP connection using OAuth](#)
  - EWS
    1. [Register an application](#)
    2. [EWS OAuth authentication](#)

### 3. Configure application access policy

#### Procedure

1. Log in to your Control Room as Bot Creator.
2. Select the bot that was identified in the Bot Scanner report for updating.
3. Check out the bot to edit it.
4. In the Bot editor, click the vertical ellipsis in the top right-corner and click **Packages**.
5. Expand the row for the Email package.
6. From the drop-down list of package versions, select the **Default** version.

---

**Note:** For Email package, ensure that the package version is **3.14.1-20220831-084727** or later. For Email trigger, ensure that the package version is **2.8.1-20220831-123116** or later.

---

7. Click **Change Version** and **Save**.
8. Click **Return to editor**.
9. Click the Email action or Email trigger that is using the **Basic** authentication mode.
10. Click the **Email server** or **EWS server** option.
11. In the **Authentication mode** drop-down list, choose the required OAuth 2.0 mode.

---

**Note:** For unattended Email automation, use Client credentials or ROPC flows, and for attended Email automation, use Implicit or PKCE flows. Microsoft does not recommend the use of ROPC and Implicit legacy flows. Therefore, we recommend that you either use the Client credentials or PKCE flow.

---

The following table provides information about the OAuth 2.0 authentication modes that are available for Email action in the Email server and EWS server options:

Email actions	Email server	EWS server
Connect	<ul style="list-style-type: none"> <li>• OAuth2 – Authorization code with PKCE</li> <li>• OAuth2 – Client credentials</li> </ul>	<ul style="list-style-type: none"> <li>• OAuth2 – ROPC</li> <li>• OAuth2 – Implicit</li> <li>• OAuth2 – Authorization code with PKCE</li> <li>• OAuth2 – Client credentials</li> </ul>
Send	OAuth2 – Authorization code with PKCE	<ul style="list-style-type: none"> <li>• OAuth2 – ROPC</li> <li>• OAuth2 – Implicit</li> <li>• OAuth2 – Authorization code with PKCE</li> <li>• OAuth2 – Client credentials</li> </ul>

Email actions	Email server	EWS server
Forward	OAuth2 – Authorization code with PKCE	--
Reply	OAuth2 – Authorization code with PKCE	--

The following table provides information about the OAuth 2.0 authentication modes that are available for Email trigger in the Email server and EWS server options:

Triggers	Email server	EWS server
Email trigger	OAuth2 – Client credentials	OAuth2 – Client credentials

- **OAuth2 – ROPC:** Uses Resource Owner Password flow ([Microsoft identity platform and OAuth 2.0 Resource Owner Password Credentials](#))

---

**Note:** The existing Silent flow has been renamed to ROPC.

- **OAuth2 – Implicit:** Uses implicit grant flow ([Microsoft identity platform and implicit grant flow](#))

---

**Note:** The existing Interactive flow has been renamed to Implicit.

- **OAuth2 – Authorization code with PKCE:** Uses authorization code with PKCE grant flow ([Microsoft identity platform and OAuth 2.0 authorization code flow](#))
- **OAuth2 – Client credentials:** Uses client credentials flow ([Microsoft identity platform and the OAuth 2.0 client credentials flow](#))

12. Depending on the authentication mode that you selected, you might have to update some of the following fields:

- **Username:** Enter the username that you want to use to access the mail server.  
For example, john.smith@myCompanyName.com
- **Password:** Enter the password for the username you provided.
- **Email provider:** Select the email provider from the drop-down list.

---

**Note:** For **Client ID**, **Tenant ID**, **Redirect URI**, and **Client secret** options, use the information that is provided for your account on your [Azure portal](#).

---

See [Email package](#) on page 2517 and [Add an email trigger](#) on page 2287.

13. For **EWS server**, click **Test connection** to sign in to your account, accept the permissions requested to authenticate, and establish a connection with the server.

---

**Note:** In the Microsoft Azure app registrations portal, in **Manage > Authentication**, ensure that the URI you have added is either <https://outlook.office365.com> or <https://outlook.office365.us> for the connection to work properly.

14. Click **Save**.

Repeat these steps for all the impacted bots and run the bots to ensure that they can connect to Exchange Online using OAuth 2.0 successfully.

## Install the trigger listener file

To use the Email trigger with OAuth 2.0, you have to update the `triggerlistener.jar` in the Bot Agent.

1. In the Windows Task Manager, stop the **Automation Anywhere Bot Agent** service.
2. Go to the folder where the Bot Agent is installed (`C:\Program Files\Automation Anywhere\Bot Agent`).
3. Locate the `triggerlistener.jar` file and rename the file to `triggerlistener.jar_old`.
4. Copy the downloaded `triggerlistener.jar`.
5. In the Windows Task Manager, start the **Automation Anywhere Bot Agent** service.

## Other resources

- [Automation 360 and Basic authentication deprecation FAQ](#) on page 1128
- [Scan bots for Basic authentication](#) on page 1134
- [Everything about Basic Authentication deprecation in Microsoft Exchange online \(A-People login required\)](#)

## Automation 360 and Basic authentication deprecation FAQ

Microsoft has announced EOL for Basic authentication that is used to connect to Exchange Online. This will impact automations (bots) using Email package or Email trigger that uses Basic authentication. Review the FAQ for details about the deprecation of Basic authentication.

What is Basic authentication deprecation?

Microsoft has announced that starting October 1, 2022, Basic authentication will be permanently turned off (disabled) for specific protocols in Exchange Online for MAPI, RPC, Offline Address Book (OAB), Exchange Web Services (EWS), POP, IMAP, Exchange ActiveSync (EAS), and Remote PowerShell.

Exclusion: SMTP AUTH is excluded from this deprecation for tenants which are already using it

Any client (user app, script, integration, and so on) using Basic authentication for one of the affected protocols will be unable to connect after that specified date. The app will display an HTTP 401 error: `bad_username_or_password`. Any app using OAuth 2.0 for these protocols will be unaffected.



### [Basic authentication in Exchange Online](#)

What is Microsoft's recommendation to mitigate Basic authentication deprecation?

Per Microsoft's recommendation, you are requested to switch from Basic authentication to OAuth 2.0 if your clients or apps are using Basic authentication with any of the affected protocols to connect to Exchange server via Exchange Online.

---

**Note:** The Basic authentication deprecation applies to Exchange Online only and not to Exchange on-premises version.

---

Why this change?

Basic authentication is an outdated industry standard, less secure, and poses high risks to accessing customers' sensitive data. The latest industry standard is OAuth 2.0 which is more secure and less vulnerable to cyber attacks.

What if I am not ready for this change?

If you are not ready to switch to OAuth 2.0 by October 1, 2022, Microsoft has provided a one-time re-enablement option that will allow you to continue to use Basic authentication for specific protocols until end of December 2022. Per the Microsoft announcement, customers will be able to use the self-service diagnostic to re-enable Basic authentication for any protocols they need, once per protocol. After the diagnostic is run, Basic authentication will be re-enabled for the specified protocols and will stay enabled until the end of December 2022.

---

**Note:** During the first week of calendar year 2023, the specified protocols will be disabled for Basic authentication use permanently.

---

### [Basic Authentication Deprecation in Exchange Online – September 2022 Update](#)

Where is Basic authentication used in Automation 360 product?

In Automation 360, the Basic authentication feature is available in the **Connect**, **Send**, **Forward**, and **Reply** actions of the Email package and in Email trigger where you configure connection parameters using any of the IMAP, POP3, SMTP, or EWS protocols.

How do I know if I am going to be impacted by Basic authentication deprecation?

Basic authentication deprecation will impact you for the following cases:

- If you are automating email using Email package or Email trigger
- If you are using Basic authentication to connect to Exchange Online

- If you are using the IMAP, POP3, or EWS protocol

When Basic authentication will be disabled by Microsoft starting October 1, 2022, then all the Automation 360 bots for Email automation that meets the previously mentioned criteria will fail because the bot cannot connect to the Email server.

When will the support end?

Basic authentication will be disabled by Microsoft starting October 1, 2022.

How can I identify Automation 360 bots in my repository that are using Basic authentication with Email package or Email trigger?

For Automation 360 bots, you can run the Bot Scanner utility for EOL features.

[Scan bots for Basic authentication](#) on page 1134

- The scanner will scan all the bots that are using Basic authentication with Email package or Email trigger and having IMAP, POP3, or EWS protocols.
- The scanner will then generate a CSV output listing all the impacted bots, including the specific line numbers and the specific actions to be performed.

Which feature will be provided in Automation 360 to mitigate the risk of Basic authentication deprecation?

The OAuth 2.0 feature will be available in Automation 360 in the Email package for the **Connect**, **Send**, **Forward**, and **Reply** actions and Email trigger for IMAP, POP3, and EWS protocols so that you can use this feature to switch from Basic authentication to OAuth 2.0.

What is the schedule and release version for introducing the OAuth 2.0 feature in Automation 360?

The OAuth 2.0 feature will be delivered as a package only release in the week of August 29, 2022. This release will include the following:

- Bot Scanner utility
- Updated versions of Email package, Email trigger, and trigger listener

Where can I download the Email package?

You can download the Email package from the link in the following article: [Everything about Basic Authentication deprecation in Microsoft Exchange online \(A-People login required\)](#).

Is the OAuth 2.0 feature backward-compatible with any of the previous releases of Automation 360?

No. The OAuth 2.0 feature is not backward-compatible with previous Automation 360 releases. Therefore, you are requested to manually update the package released with Automation 360 v.25.

What are the steps involved to update my impacted bots to switch to OAuth 2.0?

See to the following documentation page for the steps to update your impacted bots and

What are the different grant types or flows supported for OAuth 2.0 in Automation 360?

switching from Basic authentication to OAuth 2.0: [Deprecation of Basic authentication in Exchange Online](#) on page 1123.

In Automation 360, there are two primary grant types that are supported for OAuth 2.0 across Email package and Email trigger:

- Client credentials: Email package and Email trigger
- Authorization code with PKCE: Email package

Within Email package, the individual **Connect**, **Send**, **Forward**, and **Reply** actions support each of these grant types as listed in the following table:

Action name	Email Server option	EWS option
<b>Email &gt; Connect</b>	Client credentials	Client credentials
	Authorization code with PKCE	Authorization code with PKCE
	—	ROPC or Silent
	—	Implicit or Interactive
<b>Email &gt; Send</b>	—	Client credentials
	Authorization code with PKCE	Authorization code with PKCE
	—	ROPC or Silent
	—	Implicit or Interactive
<b>Email &gt; Forward</b>	Authorization code with PKCE	—
<b>Email &gt; Reply</b>	Authorization code with PKCE	—
<b>Email Trigger</b>	Client credentials	Client credentials

**Note:**

- The existing Silent flow has been renamed as ROPC (Resource Owner Password Credentials) and the existing Interactive flow has been renamed to Implicit.
- Both ROPC and Implicit grant flows are legacy flows, less secure, and are not recommended by Microsoft.
- The Client credentials flow for SMTP protocol is currently not supported by Microsoft to access Exchange Online.

- 
- [OAuth grant types](#)
  - [Authentication flow support in MSAL](#)
  - [OAuth 2.0 Client Credentials Flow support for POP and IMAP protocols in Exchange Online](#)

What will happen to my existing bots that use email automation when I update to the Automation 360 v.25 to update the default version of the Email package or Email trigger to the latest version?

When you update to the latest version of the Email package or Email trigger, the existing bots that use email automation will include the following changes:

- If your bots are using the **Email server** option with IMAP or POP3 protocol, the **Authentication mode** option will be set to **Basic** by default to indicate that the action uses Basic authentication.

If the **Host** field in the **Email server** option uses a variable, the **Authentication mode** option will be set to **Basic**.

- If your bots are using the **EWS server** option with the **Authentication mode** option set to **Basic**, there is no change in the bots.

---

**Note:** This is the default scenario when you update the Email package.

- 
- If your bots are using the **EWS server** option with the **Authentication mode** option set to **OAuth2-Silent**, the **Authentication mode** option will be set to **OAuth2 - ROPC** to indicate that the action uses the ROPC grant flow.
  - If your bots are using the **EWS server** option with the **Authentication mode** option set to **OAuth2-Interactive**, the **Authentication mode** option will be set to **OAuth2 - Implicit** to indicate that the action uses the implicit grant flow.

Why is the Send Email action marked as **Deprecated** in my existing bots?

When you update your bots with the latest version of the Email package, you will notice that the Send Email action used in your bots are marked as **Deprecated** due to the following reasons:

- We have created a new version of the Send Email action which provides support for OAuth 2.0 mode of authentication.
- The new Send Email action is available in the Email package version 3.14.1-20220831-084727 or later.
- The **Deprecated** message will help you differentiate the old Send Email action from the new Send Email action.

---

**Note:** The Send Email action that is marked as **Deprecated** will continue to work the same way as earlier without any changes. However, if you want to switch from Basic authentication to OAuth 2.0, you must replace the deprecated Send Email action with the new Send Email action and configure the required OAuth 2.0 parameters.

---

Will Automation Anywhere provide any tool for Automation 360 customers to update their bots from Basic authentication to OAuth 2.0?

No. You will have to manually update your impacted bots to switch to OAuth 2.0.

What is the guidance for Enterprise 11 customers if their bots are impacted by Basic authentication deprecation?

Enterprise 11 customers are recommended to migrate their Email automation bots to Automation 360 and leverage the OAuth 2.0 support. After migration, you can perform the following:

- Upload the new version of the Email package or Email trigger to Automation 360.
- Edit the impacted bots and set the latest version of Email package or Email trigger as default.
- Manually update your bots by switching from Basic authentication to OAuth 2.0.

---

**Note:** This guidance is applicable to both Cloud and On-Premises customers who are migrating to Automation 360.

---

Are there any limitations when you update the Email package?

We recommend that you do not perform a bulk update of bots to change Basic authentication to OAuth 2.0. You must manually edit the bots and update to OAuth 2.0.

[Deprecation of Basic authentication in Exchange Online](#) on page 1123

## Scan bots for Basic authentication

Automatically identify Automation 360 bots that are using Basic authentication mode in the Connect, Send, Forward, and Reply actions in the Email package and Email trigger, which are using IMAP, POP3, or EWS protocols.

- Ensure that the user credentials used to connect to the Control Room has the **View content** permission on the Bots folder.

The Bot Scanner utility connects to your Control Room using these credentials.

- Ensure that you meet the software and hardware requirements for using the Bot Scanner.

See [Scan Enterprise 11 or 10 bots using Bot Scanner](#) on page 1531.

1. Download the Bot Scanner utility using the link provided in the following article: [Automation 360 Bot Scanner for EOL Features](#).
2. Extract the files from the zip file that you have downloaded and double-click the `Automation_360_Bot_Scanner_For_EOL_Features.exe` executable file to run the utility.
3. In the **Bot Scanner** page, click the drop-down and select one of the following:
  - **Bots using Email action with Basic authentication:** To select the bots that have used the **Authentication type** as **Basic** for both IMAP and POP3 protocols.
  - **Bots using Internet Explorer:** To get the bots that have used Internet Explorer.

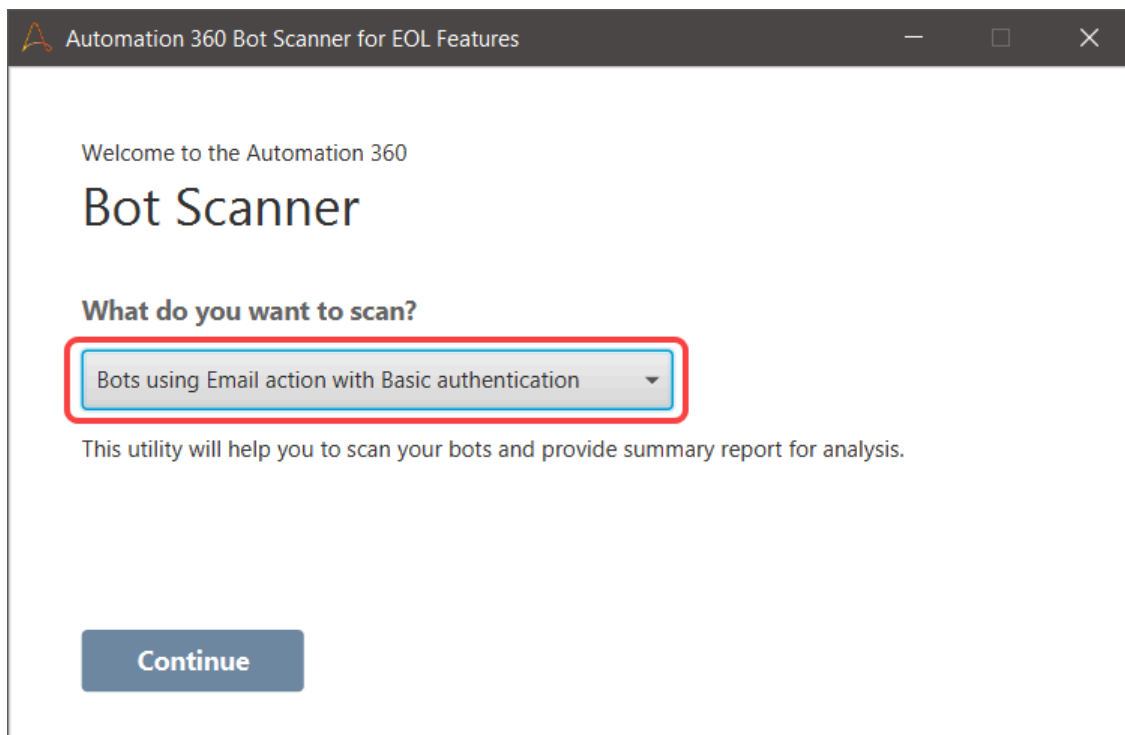

4. Click **Continue**.
5. In the **Automation 360 Bot Scanner EOL features page**, perform these steps:

- a) Enter the Control Room URL that you want to connect to
- b) Based on the authentication type configured in your Control Room, choose one of the following authentication methods in the **Authentication Type** field:

Authentication type	Steps
Active Directory	<ol style="list-style-type: none"><li>1. Enter the <b>Username</b> (Domain\\username).</li><li>2. Enter the <b>Password</b> (domain user password).</li></ol>
Database	<ol style="list-style-type: none"><li>1. Enter the <b>Username</b> (Control Room database username).</li><li>2. Enter the <b>Password</b> (Control Room database user password).</li></ol>
Single Sign-On	<ol style="list-style-type: none"><li>1. Enter the <b>Username</b>.</li><li>2. Enter the <b>API Key</b>.</li></ol>

- c) Click **Test connection**.  
A connection success or failure message is displayed. Validate your credentials if the connection fails.
- d) In the **Select destination path** field, enter the location where you want to save the generated report.
- e) Click **Scan bots**.

**Automation 360 Bot Scanner for EOL Features**

**Control Room URL**

e.g. `https:\\Automation Anywhere\\acmehealth.com\\CR23CN`

---

**Authentication Type**

Database

**Username**

**Password**

[Test connection](#)

---

**Select destination path**

**Browse...**

Choose where to save report

**Scan bots** **Cancel**

The scanner scans all the bots in your Control Room repository for Basic authentication mode usage in the **Connect**, **Send**, **Forward**, and **Reply** actions in the Email package and Email trigger. After the scan is complete, a report (.CSV file) is available in the destination path you selected for your review.

- If a .CSV file already exists in the output folder, a message is displayed that the previous .CSV file will be deleted. When you click **Continue**, a new .CSV file is generated.
- If the previous .CSV file is in use, a message is displayed that the file cannot be deleted. Close the file and click **Scan bots**.

6. Click **Open report** to analyze the report.  
The report contains the following details:

- Task Bot name: Name of the Task Bot.
- Line number: The line number of the **Connect**, **Send**, **Forward**, or **Reply** actions that are using Basic authentication.

For **Email trigger**, the line number will be empty.

- Package and action name: The Email package and action that is using Basic authentication.



- Searched text: The hostname of the Email server or the domain name of the EWS server for the respective action.
- Action and review message: Use this information to understand the action that you have to perform or the information that you have to review for the corresponding action containing Basic authentication.  
See [Basic authentication scanning messages](#) on page 1137.
- Task Bot path: The path to the repository where the bot resides.

After you identify the bots that are impacted due to Basic authentication, you can plan to update these bots in the Control Room repository to switch to OAuth 2.0 authentication. For more information on how to switch to OAuth 2.0, see [Deprecation of Basic authentication in Exchange Online](#) on page 1123.

## Basic authentication scanning messages

The Bot Scanner report might display some messages for your review or action for updating bots that are using Basic authentication to OAuth 2.0 in the Email package or Email trigger. Messages provide detailed information about the action, error, or review required to update the bots.

Code	A1001
Message	<p>The Basic authentication mode that is used to connect to the email server is deprecated by Microsoft.</p> <p>For the bot to run, update the authentication mode by selecting OAuth 2.0 and configuring the required parameters. Otherwise, a connection error will occur.</p>

Code	A1002
Message	<p>The Basic authentication mode that is used to connect to the EWS server is deprecated by Microsoft.</p> <p>For the bot to run, update the authentication mode by selecting OAuth 2.0 and configuring the required parameters. Otherwise, a connection error will occur.</p>

Code	R1004
Message	<p>A variable is used in the 'Host' property of this bot. If the variable is pointing to 'office365.com', this can potentially have an impact on the action since the Basic authentication mode that is used to connect to the email server is deprecated by Microsoft.</p> <p>You are advised to review the variable and update the authentication mode by selecting OAuth 2.0 and configuring the required parameters.</p>

## Chrome and Edge Manifest V3 extensions

As Google will deprecate Manifest V2 extensions, this might impact your existing automations that use the current Manifest V2 extensions for Google Chrome and Microsoft Edge browsers. We have published Manifest V3 extensions with the Automation 360 v.26 release to help you start switching to Manifest V3 extensions.

### Manifest V2 based deprecation

A manifest is a specification that is used to build browser extensions. As Google is deprecating Manifest V2 based extensions, we recommend that you update to Manifest V3 based extensions, which provides an enhanced security, privacy, and performance.

Impact to our customers: Automations that use Google Chrome Manifest V2 based extensions will stop working sometime after June 2023. The deprecation timelines of Manifest V2 based extensions are currently under review and subject to change by Google.

- For Google Chrome Manifest V2 extensions timelines, see [Manifest V2 support timeline](#).
- For Microsoft Edge Manifest V2 extensions timelines, see [Overview and timelines for migrating to Manifest V3](#).

Post the given date, you must switch to Manifest V3 extensions for your automations to work. You can choose to use the enterprise group policy for both Google Chrome and Microsoft Edge to continue to use Manifest V2 based extensions. For more information on Manifest extensions support and timelines, see, [Manifest V3 transition timeline](#).

### Manifest V2 deprecation for Automation 360 v.26 and later releases

From Automation 360 v.26 and later releases, we have published new Google Chrome and Microsoft Edge Manifest V3 extensions. Starting on October 23, 2023, we will deprecate support for Manifest V2 extensions on Automation 360 v.26 and later releases. After this date, we will not address any issues relating to Manifest v2 extensions. If you are on Automation 360 v.26 or a later release and still using Manifest V2 extensions for Google Chrome and Microsoft Edge, we recommend that you upgrade your Google Chrome and Microsoft Edge browser extensions to Manifest V3 extensions before October 23, 2023.

### Automation 360 features that use browser extensions

The following Automation 360 features use the Google Chrome or Microsoft Edge browser extension for web applications running on Google Chrome or Microsoft Edge:

- Bot Agent device registration with the Control Room (uses Chrome extension only)
- Automation of web applications through Universal Recorder or Browser package
- User interface based triggers
- Packages that use window titles, for example, OCR and Mouse Click

## Plan the switch to Manifest V3 extensions

---

**Note:** Manifest V3 extension is supported on Google Chrome and Microsoft Edge browsers version 91 and later only.

---

Automation 360 customers:

We have published new Google Chrome and Microsoft Edge Manifest V3 extensions with the Automation 360 v.26 release. We will also continue to support Manifest V2 extensions until June 2023 to provide you time to switch to Manifest V3 extensions before Jan 2024 for Google Chrome. To know about Microsoft Edge Manifest V2 extensions timelines, see [Overview and timelines for migrating to Manifest V3](#).

You have the following options to switch to Manifest V3 extensions:

- New customers: Users starting with Automation 360 v.26 will directly use Manifest V3 extensions. You will not be impacted by the deprecation of Manifest V2 extensions.
- Cloud customers: Our Cloud deployments is updated to Automation 360 v.26 in October, and customers can switch to Manifest V3 extensions when they update their Bot Agent.
- On-Premises customers:
  - Updating to v.26: Customers updating from an earlier version to Automation 360 v.26 will switch to Manifest V3 extensions when they update their Bot Agent.
  - v.25: We have provided a Control Room patch with Automation 360 v.25. After installing the patch, the V2 extensions is switched to Manifest V3 extensions when you update the Bot Agent.
  - v.24, v.23, and v.22: For customers on Automation 360 v.24 or earlier, we strongly recommend that you update to Automation 360 v.26 or later releases. If you choose not to update, we will provide a set of steps to perform on all Bot Agent and Bot Runner devices to switch to Manifest V3 extensions. See [Manifest extension manual upgrade](#).
  - v.21 and earlier: We strongly recommend that you update to the latest version of Automation 360.

**Note:** You can choose to delay switching to MV3 extensions by using a Chrome group policy that extends support for Manifest V2 extensions until Jan 2024 for Google Chrome, see [Manifest V3 transition timeline](#). To know about Microsoft Edge Manifest V2 extensions timelines, see [Overview and timelines for migrating to Manifest V3](#).

---

Customers migrating to Automation 360

We recommend that you migrate to Automation 360 v.26, which uses Manifest V3 extensions by default. If you are migrating to Automation 360 v.25, install the Control Room patch, that we released in October.

Enterprise 11 customers

For details, see [Enterprise 11: Deprecation of Basic authentication and MV2 extensions](#).

## Extend Manifest V2 extensions usage through group policy

You can choose to use the enterprise group policy for both Google Chrome and Microsoft Edge to continue to use Manifest V2 extensions till Jan 2024 .

For information about Manifest V2 extension timelines for Google Chrome, see [Manifest V3 transition timeline](#). For Microsoft Edge, see [Overview and timelines for migrating to Manifest V3](#).

You can extend the Manifest V2 deprecation only using the group policy. This extension provides you adequate time to plan upgrading to Manifest V3 extensions. You can use any extension group policy to extend the use of Manifest V2 extensions.

To update the policy, perform these steps:

1. Copy the following entries to a `.txt` file and save the file as a `.reg` file.

- Chrome:

```
Windows Registry Editor Version 5.00
[HKEY_LOCAL_MACHINE\SOFTWARE\Policies\Google\Chrome
\ExtensionInstallForcelist]
"ExtensionSettings"="{\"kammdlphdfejlopponbapgbgagakimokm\":
{\"installation_mode\": \"normal_installed\", \"update_url\":
\"http://clients2.google.com/service/update2/crx\"}}"
```

- Edge:

```
Windows Registry Editor Version 5.00
[HKEY_LOCAL_MACHINE\SOFTWARE\Policies\Microsoft\Edge
\ExtensionInstallForcelist]
"ExtensionSettings"="{\"dbmodiepejcgijlbmeebedkmegndokbk\":
{\"installation_mode\": \"normal_installed\", \"update_url\":
\"https://edge.microsoft.com/extensionwebstorebase/v1/crx\"}}"
```

2. Run the `.reg` file.

3. Restart the browser for the changes to take effect.

Related concepts

[Manifest V3 extensions FAQ](#) on page 1141

As Google will deprecate Manifest V2 extensions by June 2024, this might impact your existing automation that use the current Manifest V2 extensions for Google Chrome and Microsoft Edge browsers.

[Manually upgrade from Manifest V2 to V3 extensions for Chrome and Edge](#)

[Feature deprecations affecting Automation Anywhere products](#) on page 1086

Review the features and capabilities (from Automation Anywhere or third party) that are deprecated or nearing deprecation to understand how they affect your automation and what action is required.

Related tasks

[Manage multiple browser profiles for Manifest V3 extension](#) on page 1147

Automation 360 v.26 automatically includes Manifest V3 extensions to support browser-based automation. However, these V3 extensions in v.26 are by default for a single browser profile only.

## Manifest V3 extensions FAQ

As Google will deprecate Manifest V2 extensions by June 2024, this might impact your existing automation that use the current Manifest V2 extensions for Google Chrome and Microsoft Edge browsers.

We have published Manifest V3 extensions with the Automation 360 v.26 release to help you start switching to Manifest V3 extensions.

What is Manifest V2 extension deprecation?

A manifest is a specification using which browser extensions are built. Google is deprecating Manifest V2 extensions by June 2024 for Google Chrome. To know about Microsoft Edge Manifest V2 extensions timelines, see [Overview and timelines for migrating to Manifest V3](#). The deprecation might impact your existing automation that use Manifest V2 extensions for Google Chrome and Microsoft Edge browsers. So, we recommend that you plan to switch to Manifest V3 extensions, which provide enhanced security, privacy, and performance.

See the following resources for information on Manifest V2 extensions deprecation timelines: :

- Google Chrome: [Manifest V2 support timeline](#)
- Microsoft Edge: [Overview and timelines for migrating to Manifest V3](#)

When will the Manifest V2 support end?

In June 2024, Manifest V2 extensions for Google Chrome will stop functioning. Starting on October 23, 2023, we will deprecate support for Manifest V2 extensions on Automation 360 v.26 and later releases. After

this date, we will not address any issues relating to Manifest v2 extensions. For Microsoft Edge Manifest V2 extension timelines, see [Overview and timelines for migrating to Manifest V3](#) for more information.

Support for Manifest V2 for Google Chrome ends in Jan 2024 (see [Manifest V3 transition timeline](#)). To know about Microsoft Edge Manifest V2 extensions timelines, see [Overview and timelines for migrating to Manifest V3](#). You must switch to Manifest V3 based Google Chrome and Microsoft Edge browser extensions by then.

How do I know if I am going to be impacted by the deprecation?

If you are using any or all of the following features on Google Chrome or Microsoft Edge browsers, you will be impacted by the Manifest V2 deprecation.

- Automation of web applications through Universal Recorder or Browser package
- User interface based triggers
- Bot Agent device registration with the Control Room
- Packages that use Browser variables, for example, Recorder, OCR and Mouse Click

Do I have to do anything in advance of the deprecation?

To avoid being affected by the deprecation, you can choose one of the following options:

- Update to Automation 360 v.26, which includes the latest Manifest V3 extensions.
- Switch to Manifest V3 extensions before June 2023 if you are using Google Chrome. For Microsoft Edge Manifest V2 extensions timelines, see [Overview and timelines for migrating to Manifest V3](#).

Will the Manifest V2 extensions be automatically updated to V3 or do I have to manually add V3 extensions to the browser?

- If you are on Automation 360 v.26 or later, and if you have updated to Bot Agent 21.222 or later, you will be automatically updated to Manifest V3.
- If you are on Automation 360 v.25 and earlier, you must manually update the Manifest V2 to V3. See [Manifest extension manual upgrade](#).

Which Automation 360 versions are certified for updating from Manifest V2 to V3 extensions?

The following versions are certified for the update:

- v.25
- v.24
- v.23

- v.22

I plan to continue with Automation 360 v.25, so what should I do to continue using MV2 extensions?

You can continue to use Manifest V2 extension only till Jan 2024 for Google Chrome (see [Manifest V3 transition timeline](#)). To know about Microsoft Edge Manifest V2 extensions timelines, see [Overview and timelines for migrating to Manifest V3](#).

What about the automations that I have already built using Chrome or Edge?

If your automations are dependent on browser extensions, you must update to Manifest V3 extensions.

Do I need to update the Recorder package in the bots, or will they continue to work with the earlier versions?

The Recorder package will work as intended, so there is no need to update the package.

I am using Automation 360 Cloud, so will my automations be impacted by the deprecation?

Cloud deployments are automatically updated to the Automation 360 v.26 release, which includes Manifest V3 extensions. The Bot Agent in v.26 refers to Manifest V3 extensions.

---

**Note:** If the **Automatically update all bot agents** option in your Control Room settings is disabled on your device, you will not be automatically updated to Manifest V3 extensions. So ensure that this option is enabled to receive automatic updates. Alternatively, you have to install the Bot Agent manually on all the Bot Runner devices.

---

How does the deprecation impact my migration?

We recommend that you migrate to Automation 360 v.26, which uses Manifest V3 extensions by default.

If you are using Automation 360 v.25 or earlier, you must update to Manifest V3 extensions before you migrate browser-based automations.

Will the URL for the extensions change? Will the URLs that I have added in the trusted list for proxy settings be impacted?

Yes, the URLs for the extensions are different for Manifest V2 and V3. Use the following URLs for Manifest V3:

- Chrome: [Google Chrome extension for Automation 360](#)
- Edge: [Microsoft Edge extension for Automation 360](#)

Will Manifest V2 extensions be retained after I update to Manifest V3?

MV2 extensions will be retained for Google Chrome and Microsoft Edge browsers. However, these extensions cannot be modified after December 2022. Ensure that you continue using MV3 extensions. See also: [Manifest V3 transition timeline](#).

**Note:** If you are on Automation 360 v.26 release and using Bot Agent 21.222, you will see both Manifest V2 and Manifest V3 registry entries in the Windows Registry.

- You can remove the Manifest V2 entry from Windows Registry by uninstalling the existing Bot Agent 21.222 and installing the Bot Agent 21.222 again.
- You can remove the Manifest V2 extension from the **Extensions** page.

Uninstalling the Bot Agent will remove both Manifest V2 and Manifest V3 extensions.

See [Uninstall or remove apps and programs in Windows](#).

---

If Enterprise 11 and Automation 360 are running on the same device, will there be any conflicts due to the Manifest V2 deprecation?

There will be no impact in such scenarios because the Manifest V3 extensions IDs are different for Enterprise 11 and Automation 360.

Do I have an option to update my devices in a phased or staggered manner?

Yes, you can update your devices in a staggered manner to Manifest V3. You can disable the **Automatically update all bot agents** option for all devices and then select the devices individually for which you want to update the Bot Agent.

I had switched from Manifest V3 to V2 extensions for Automation 360 v.26. Can I now update to Manifest V3 extensions when I update Automation 360 to v.27?

When you update to Automation 360 v.27, the corresponding Bot Agent is also updated. Manifest V3 extensions are installed with the latest version of Bot Agent.

Additionally, ensure that you select the **Enable Automation 360 extension for this browser profile** option on Google Chrome and Microsoft Edge browsers. See [Manage multiple browser profiles for Manifest V3 extension](#) on page 1147.

---

**Note:** If you are currently using Manifest V2 extensions or earlier versions, we recommend that you update and use the Manifest V3 extension.

---

My bot uses a Recorder package from an earlier Automation 360 version and has a hard-coded Manifest V2 extension ID in it. How do I change the extension ID?

When you update to Automation 360 v.26, the extension ID for Manifest V3 is updated automatically.

My application has IFrame with Content Security Policy enabled. Will the **Run JavaScript** action run the JavaScript inside the IFrame?

With Manifest V3, Google has restricted access to IFrame where Content Security Policy (CSP) is enabled in target page. If your business application does not have CSP enabled, you



<p>What version of the browsers are supported for Manifest V3?</p>	<p>will be able to run JavaScript inside the IFrame. If your business application has CSP enabled, you will not be able to run JavaScript inside the IFrame and the <b>Run JavaScript</b> action will timeout or fail.</p>
<p>I am currently on Automation 360 v.26. Are there any settings that I have to configure to continue to avail the latest browser extension versions?</p>	<p>If you have an internet connection, you will continue to receive the updates through automatic updates.</p>
<p>Can I use MV3 extension offline or without internet connection?</p>	<p>MV3 extensions are automatically installed when you update the Bot Agent to the latest version. MV3 based offline extensions are available for:</p> <ul style="list-style-type: none"> <li>• Google Chrome from Automation 360 v.26. See <a href="#">Install Chrome Plugin offline or without internet access in Automation 360</a>.</li> <li>• Microsoft Edge from Automation 360 v.27.</li> </ul>
<p>Will there be any impact to the remote agent that I have been using?</p>	<p>For additional help, contact Automation Anywhere Support.</p> <p>The remote agent installed with Automation 360 v.25 or earlier is not compatible with the Manifest V3 extension. You must install the latest Automation Anywhere remote agent and use the latest Recorder package.</p> <p>See <a href="#">Install Automation Anywhere remote agent for Citrix 2.0: Recorder package version 2.8.6</a> on page 1227.</p>
<p>What are the prerequisites to configure the browser extension settings?</p>	<p>Following are the prerequisites to configure the browser extension settings:</p> <ul style="list-style-type: none"> <li>• Bot Agent version 21.222 or later.</li> <li>• You must have installed the Bot Agent with installation type as system-wide.</li> </ul>
<p>How do I remove the Manifest V3 group policy?</p>	<p>For Google Chrome: Navigate to [HKEY_LOCAL_MACHINE\SOFTWARE\Policies\Google\Chrome\ExtensionInstallForcelist] and remove the entries that contain bboccnojhhogefffpcllbeigipedjedf as the extension ID.</p> <p>For Microsoft Edge: Navigate to [HKEY_LOCAL_MACHINE\SOFTWARE\Policies\Microsoft\Edge\ExtensionInstallForcelist] and remove the entries that contain</p>

<p>After updating to Automation 360 v.26, do I have to disable Manifest V2 extensions?</p>	<p>fnmjcda jlonpigpcfnemeikipmolbfii as the extension ID. Restart the browser for the changes to take effect.</p>
<p>How do I remove the MV2 extension?</p>	<p>When you update to Automation 360 v.26, Manifest V3 extension is installed automatically, without impacting the already installed Manifest V2 extension. Both Manifest V2 and V3 extensions can coexist. The Manifest V3 extension does not interfere with Manifest V2 extensions. You can remove the Manifest V2-based extensions as needed.</p> <p>For Google Chrome: Navigate to HKEY_LOCAL_MACHINE\SOFTWARE\WOW6432Node\Google\Chrome\ . Expand <b>Extensions</b> folder and remove the folder by name kammdlphdfejlopbonbapppbgakimokm.</p> <p>For Microsoft Edge: Navigate to HKEY_LOCAL_MACHINE\SOFTWARE\WOW6432Node\Microsoft\Edge. Expand <b>Extensions</b> folder and remove the folder by name dbmodiepejcgijlbmeebedkmegndokbk.</p> <p>Alternatively, go to the <b>Extensions</b> page of your respective browser and remove the entry related to Manifest V2.</p>
<p>How do I remove the MV3 extension?</p>	<p>For Google Chrome: Navigate to HKEY_LOCAL_MACHINE\SOFTWARE\WOW6432Node\Google\Chrome\ . Expand <b>Extensions</b> folder and remove the folder by name bboccnjhhogfffpcllbeigipedjedf.</p> <p>For : Navigate to HKEY_LOCAL_MACHINE\SOFTWARE\WOW6432Node\Microsoft\Edge. Expand <b>Extensions</b> folder and remove the folder by name bboccnjhhogfffpcllbeigipedjedf.</p> <p>Alternatively, go to the <b>Extensions</b> page of your respective browser and remove the entry related to Manifest V3.</p>
<p>How do I force-enable Google Chrome or Microsoft Edge extension for user-specific Bot Agent instances?</p>	<p>You can force-enable the Manifest V3 extension on Google Chrome or Microsoft Edge by running the .reg files for Manifest V3. See <a href="#">Manifest extension manual upgrade</a>.</p>
<p>How do I add an extension force group policy if another extension policy has already been added by my IT team?</p>	<p>If a key by name <b>1</b> is already present, create a key name with the subsequent number, in this case, <b>2</b>. See the following articles:</p> <ul style="list-style-type: none"> <li>• <a href="#">ExtensionInstallForcelist</a> for Google Chrome</li> </ul>

- [ExtensionInstallForcelist](#) for Microsoft Edge

I have installed the latest Bot Agent and am currently on Automation 360. However, I ignored the browser extension pop-up dialog box. What do I do?

If you updated the Bot Agent when you launched a browser, you will be prompted to add or remove the Manifest V3 extension through a pop-up dialog box. To enable the Manifest V3 extension, you must select the **Add Extension** option. If you ignore the pop-up dialog box, the Manifest V3 extension is disabled. To enable the extension and apply the group policy, you must restart your browser.

What is the Automation 360 started debugging this browser pop-up message and how do I disable it?

Google Chrome displays the Automation 360 started debugging this browser pop-up message for the **Browser > Run JavaScript** or for the inline JavaScript click action. Google has restricted software providers to add JavaScript in the page content that restricts execution of any inline JavaScript click. In Manifest V3, Google has updated the security to ensure that the Google Chrome browser is not compromised.

You can disable the message by creating a new registry with Data value as browser extension ID. See [A360 | Getting pop-up while running the bots "Automation 360" started debugging this browser.](#)

Related concepts

[Chrome and Edge Manifest V3 extensions](#) on page 1138

As Google will deprecate Manifest V2 extensions, this might impact your existing automations that use the current Manifest V2 extensions for Google Chrome and Microsoft Edge browsers. We have published Manifest V3 extensions with the Automation 360 v.26 release to help you start switching to Manifest V3 extensions.

[Manually upgrade from Manifest V2 to V3 extensions for Chrome and Edge](#)

[Feature deprecations affecting Automation Anywhere products](#) on page 1086

Review the features and capabilities (from Automation Anywhere or third party) that are deprecated or nearing deprecation to understand how they affect your automation and what action is required.

## Manage multiple browser profiles for Manifest V3 extension

Automation 360 v.26 automatically includes Manifest V3 extensions to support browser-based automation. However, these V3 extensions in v.26 are by default for a single browser profile only.

You can enable browser extension for only one browser profile at a time. If you have multiple browser profiles, you must enable browser extension only from the profile that is used to run the bots. You must disable the Automation 360 browser extension from all other browser profiles. You also have the option to debug logging, for troubleshooting purposes.

**Note:** This procedure is applicable only if your browser is using Manifest V3 extension.

To enable or disable the browser extension individually for each browser profile, perform these steps:

1. Open the Google Chrome or Microsoft Edge browser:
  - On Microsoft Edge, navigate to **Extensions > Automation 360 > Extension Options**.
  - On Google Chrome, navigate to `chrome://extensions/` and select **Details** in Automation 360 and select **Extension options**.

The following page is displayed:

**Enable Extension Functionality**

Enable Automation 360 extension for this browser profile

Only one profile per browser is supported.  
Enable this option only on the profile which will be used for automation.

**Debug Logging Options**

Enable debug logging

Displays extension activity messages on the developer console. Enable this option for troubleshooting issues with the extension.

Enable ALL logging

Enable native messenger logging

Enable script execution logging

Save

2. Select or deselect the **Enable Automation 360 extension for this browser profile** option.

**Note:** When you enable this option, only the current active profile is used for communication with the Bot Agent.

3. Select the **Enable debug logging** option to troubleshoot any browser extension issues.
4. Click **Save** and then restart the browser for the changes to take effect.
5. Verify that the debugging option is enabled for this browser profile by performing these steps:
  - a) Press **F12** key or **Ctrl+Shft+I** keys on an active browser window.
  - b) In the **Developer** console, select the **Application** tab and then select **Service Workers**.
  - c) Click **See all registrations**.  
In the **Service Workers** window, the extension ID in `chrome://extensions` and the ID in the **ServiceWorker** window will be the same. Also, the **Log** field displays the logs continuously.

Related concepts

[Manifest V3 extensions FAQ](#) on page 1141

As Google will deprecate Manifest V2 extensions by June 2024, this might impact your existing automation that use the current Manifest V2 extensions for Google Chrome and Microsoft Edge browsers.

[Manually upgrade from Manifest V2 to V3 extensions for Chrome and Edge](#)

## Deprecation of Tesseract OCR v3

IQ Bot will permanently discontinue Tesseract OCR v3 starting from Automation 360 v.26. This affects customers who have created learning instances using Tesseract OCR v3. We recommend that you plan to train your learning instances with alternative OCRs (including Tesseract OCR) before you update to Automation 360 v.26.

Removal of Tesseract OCR will affect the following product areas:

- My Learning Instances page:

Instance name	ID	Provider	# of IQ Bots	# of Files	Training %	Actions
20-5815-Smoke-Invoice-T4		Tesseract3 OCR	8	0	38%	Set to Production (disabled), Launch Validator (disabled)
25		Tesseract4 OCR	0	1	0%	Set to Production (enabled), Launch Validator (disabled)
25Shiva		Tesseract4 OCR	0	1	0%	Set to Production (enabled), Launch Validator (disabled)
29www		Tesseract4 OCR	3	18	0%	Set to Production (enabled), Launch Validator (disabled)
CheckValidationIssue		Abbyy OCR	0	2	0%	Set to Production (enabled), Launch Validator (disabled), Train (enabled)
checkvalidations		Tesseract4 OCR	2	2	0%	Set to Production (enabled), Launch Validator (disabled), Train (enabled)

For all Tesseract3 OCR learning instances, the **Set the instance to Production** button and **Launch Validator** button are unavailable.

- My Learning Instance details page:
  - Select the Tesseract OCR v3 learning instance and go to the **Learning Instance details** page.
  - The **Set to staging**, **Add group**, **Validate**, **Edit**, and **Train** buttons are unavailable.

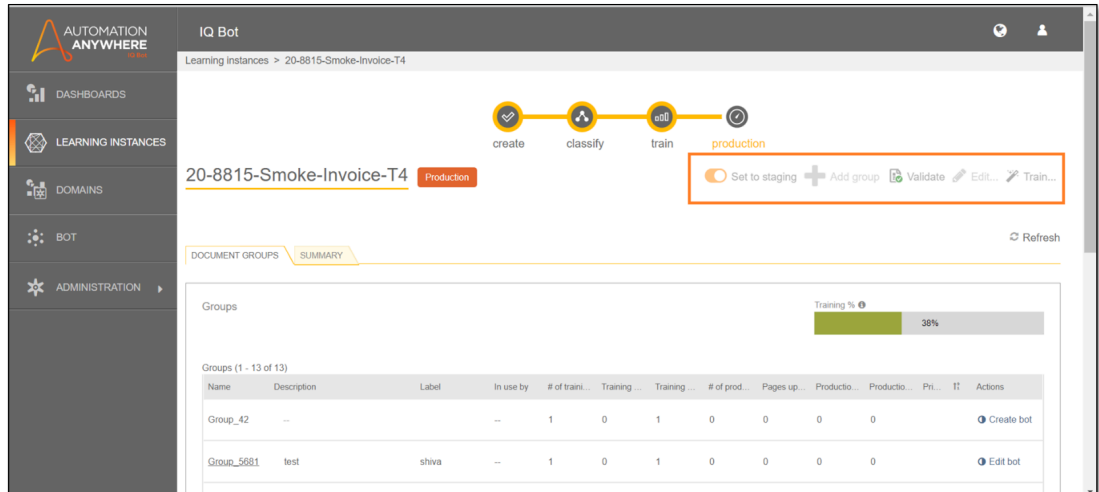

- Edit Bot page:
  - In the **My Learning Instance** page, click the **Edit bot** button of any existing bot.

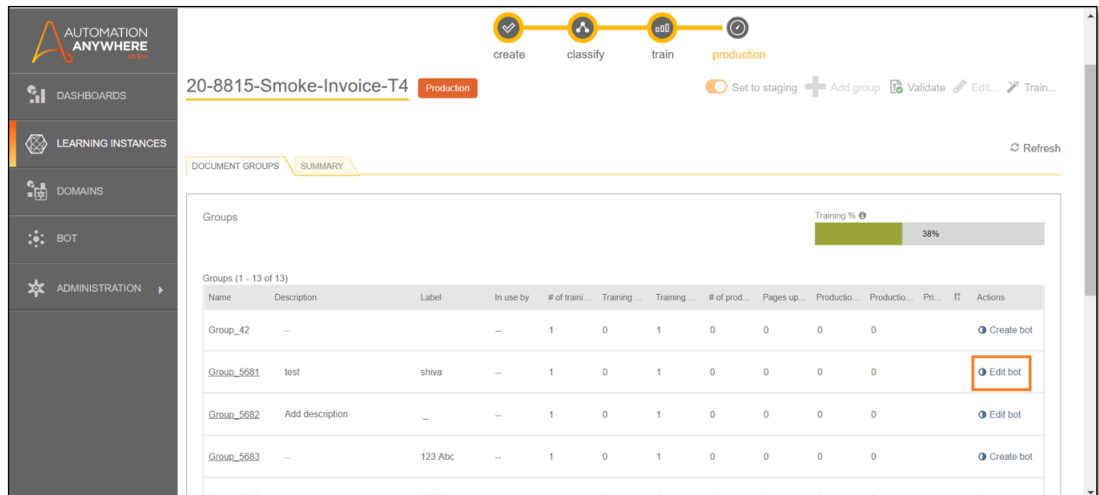

- The **See extraction result**, **Save and close**, **Save and go to next group**, and **Delete Bot** buttons are unavailable.

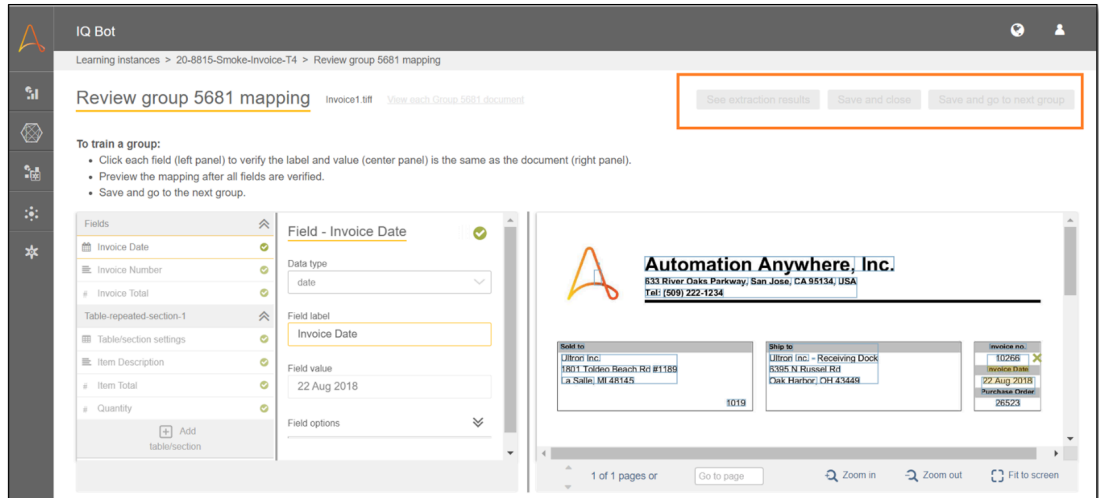

- Bot page:
- Go to Bot page.

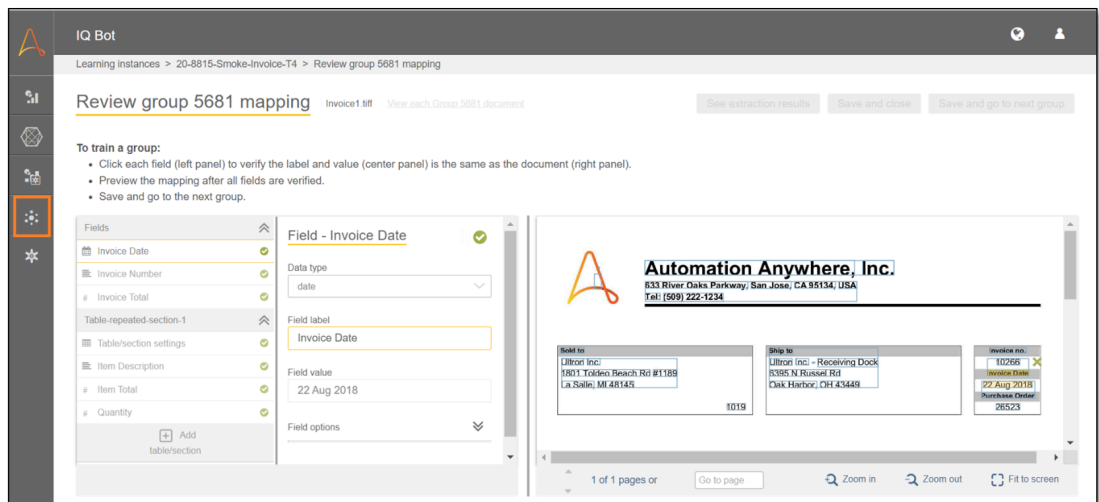

- Click **Test**.

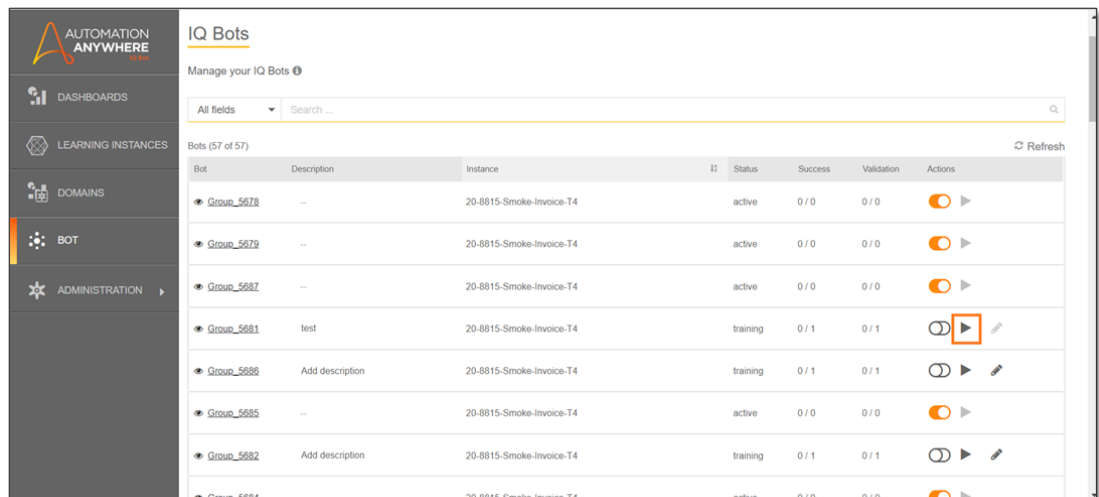

- The following error message is displayed:

The learning instance references OCR version which is not available - Tesseract 3

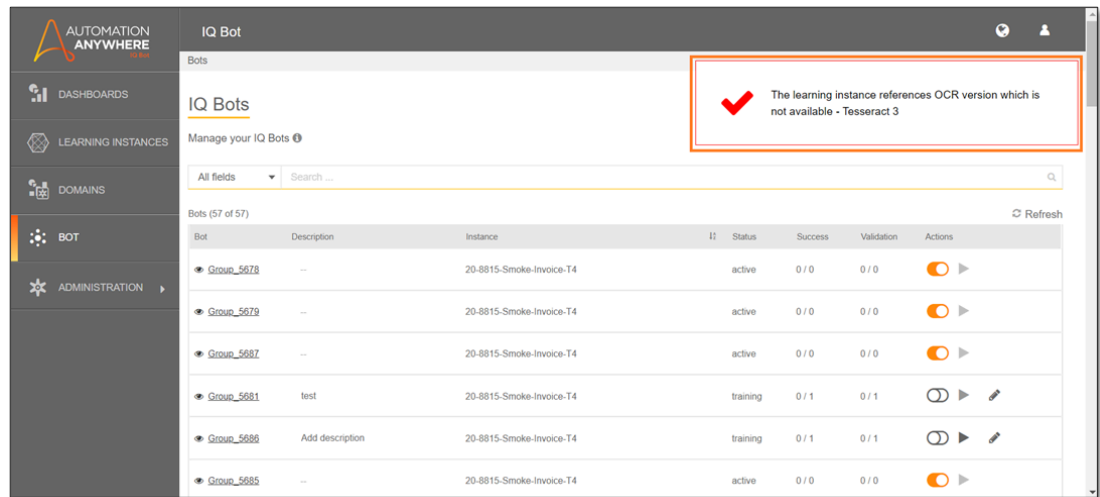

- There is no change in the **Dashboard** page, and it continues to show Tesseract 3 metrics.

## Deprecation of EWS APIs in Exchange Online

Microsoft has announced End-of-life of EWS APIs that is used to connect to Exchange Online. This is an ongoing deprecation and Microsoft will continue deprecating the least used EWS API. This impacts customers running bot for email automation that connect to Exchange Online using EWS API.

To know more about EWS API deprecation, see [Upcoming API Deprecations in Exchange Web Services for Exchange Online](#).

We have released a new Microsoft 365 Outlook package with Automation 360 v.29 release which is based on the latest version of Graph API and will enhance Microsoft 365 package suite capabilities, see [Microsoft 365 Outlook package](#) on page 2851.

To ensure that your existing bots that are using the existing Email package with the EWS option are supported after the EWS APIs are deprecated, we recommend that you replace the actions from the Email package with the actions from the new Microsoft 365 Outlook package to automate Outlook emails for Exchange Online. This package contains all actions similar to those available in the Email package. You can use the Microsoft 365 Outlook package instead of the Email package with EWS option to change from EWS API to Graph API, see [EWS API deprecation FAQ](#) on page 1153.



## Update bots using Email EWS option to Microsoft 365 Outlook package

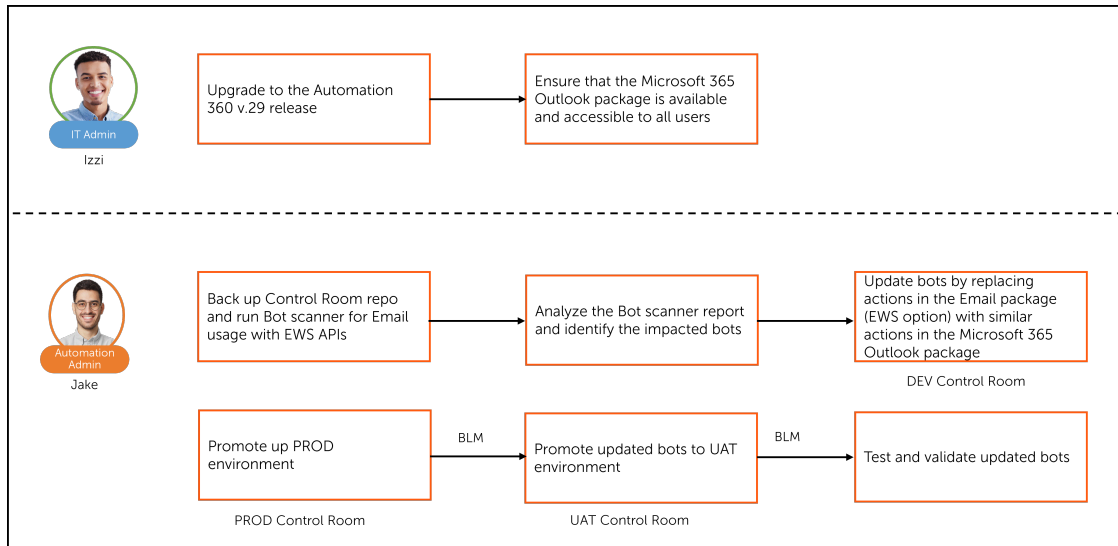

You must update your bots that are using EWS API in the actions of the Email package and Email trigger before EWS API is deprecated.

**Note:** Ensure that you update your Bot Agent version to 21.250 (which was released with Automation 360 v.29) on your system.

To update the bots, perform the following steps:

1. Run Bot Scanner to scan bots having Email action with EWS option. See [Scan bots for Basic authentication](#) on page 1134.
2. Edit the impacted bot by replacing each Email action with EWS option with the equivalent actions in the Microsoft 365 Outlook package. See [Microsoft 365 Outlook package](#) on page 2851.
3. Test the bot and ensure the result is same.

## EWS API deprecation FAQ

Microsoft has announced EOL for EWS APIs that are used to connect to Exchange Online. This deprecation might impact automations (bots) that use the Email package or Email trigger with EWS option. Review the FAQ for details about the EWS API deprecation.

What is EWS API deprecation?

Microsoft has deprecated 25 least used EWS APIs since March 31, 2022. This is an ongoing deprecation and Microsoft will continue deprecating additional EWS APIs as and when the equivalent Graph APIs are available.

Why this change?

To know more about EWS API deprecation, see [Upcoming API Deprecations in Exchange Web Services for Exchange Online](#).

EWS is a legacy API, which is less secure and does not meet the security and manageability needs of modern application development. Per Microsoft, you are requested to switch from SOAP-based EWS APIs to REST-based Graph API if your clients or applications are using EWS APIs to connect to Exchange server via Exchange Online.

Microsoft Graph offers the following advantages compared to EWS:

- **Security:** Microsoft Graph is more secure and has stricter governance policies with OAuth and enables you to limit data access in a mailbox compared to the all or none access model in EWS.
- **Simplicity:** Microsoft Graph provides Graph Explorer to discover and test APIs easily and quickly, SDKs in different programming languages, and an active developer community.
- **Efficiency:** Microsoft Graph APIs are REST-based, where EWS APIs are SOAP-based. The advantage of using REST-based protocols include faster JSON serialization and lower network usage.

---

**Note:** The EWS API deprecation applies to Exchange Online only and not the Exchange on-premises version.

---

How will this deprecation impact me?

For now you will not be impacted because Automation 360 does not use any of the EWS APIs that were deprecated by Microsoft. Per Microsoft, the non-deprecated EWS APIs will continue to be supported for use in production environments and we do not have a fixed timeline when these APIs will get deprecated in future.

In case, specific EWS APIs which are used in Automation 360 gets deprecated in future, and if you have automated email using Email package and Email Trigger actions with EWS

option then such automations will break due to connection failure with Exchange Online.

Where does Automation 360 use EWS API?

Automation 360 uses EWS API in Email package and Email trigger for EWS option, which allows you to connect to Exchange Online hosted on Azure Cloud and access emails from Microsoft 365.

How can I identify impacted bots which uses Email EWS option?

You can use the Automation 360 Bot Scanner utility for EOL feature to scan and identify the impacted bots that use EWS. See [Scan bots for Basic authentication](#) on page 1134.

What is the guidance for Automation 360 customers to switch from EWS API to Graph API?

We have released a new Microsoft 365 Outlook package with Automation 360 v.29 release which is based on the latest version of Graph API. You can use this package to automate Outlook emails for Exchange Online. This package contains all actions similar to those available in the Email package. You can use the Microsoft 365 Outlook package instead of the Email package with EWS option to switch from EWS API to Graph API.

How do I update my existing bots to Microsoft 365 Outlook package?

To update your existing impacted bots to Microsoft 365 Outlook package, see [Deprecation of EWS APIs in Exchange Online](#) on page 1152.

Will Automation Anywhere provide any tool for Automation 360 customers to update their bots from EWS API to Graph API?

No. You must manually update your impacted bots to switch to Graph API (Microsoft 365 Outlook package).

Is there a one to one mapping between Email and Microsoft 365 Outlook packages or are there any differences?

All the actions available in the Email package are also available in the Microsoft 365 Outlook package. However you must consider the following differences when you build a bot with the new Microsoft 365 Outlook package:

- In the Email package, the **Send**, **Forward**, **Reply**, and **Reply All** actions have connection parameters and therefore when you create an automation, you can use these actions independent of the **Connect** action. However, in case of Microsoft 365 Outlook package, you must use the **Connect** action before each of these actions since they refer to the session created by the **Connect** action, see [Microsoft 365 Outlook package](#) on page 2851
- The new Microsoft 365 Outlook package supports two authentication modes:

Authorization code with PKCE and Client Credentials. The Email package with EWS option supports four authentication modes: ROPC, Implicit, authorization code with PKCE, and Client Credentials.

---

**Note:** ROPC and Implicit authentication modes are deprecated and hence not supported in Microsoft 365 Outlook package. You must use the more secure authorization code with PKCE flow for attended automation and Client Credentials flow for unattended automation.

---

## Scan bots that use email action with EWS option

You can use the Automation 360 Bot Scanner for EOL Features to scan and identify bots that are using EWS.

- Ensure that the user credentials used to connect to the Control Room has the **View content** permission on the `Bots` folder.

The Bot Scanner utility connects to your Control Room using these credentials.

- Ensure that you meet the following system requirements for using the Bot Scanner:
  - Hardware requirements

Processor	2.66 GHz or higher (64-bit)
RAM	2 GB or higher
Disc space	200 MB

- Software requirements

Operating systems: Windows 7 or later (32-bit or 64-bit)

---

**Note:** Microsoft has deprecated EWS API for Exchange Online and has recommended that users move to Graph API. See [Upcoming API Deprecations in Exchange Web Services for Exchange Online](#).

We recommend that you replace each email-related action with the equivalent new action in the Microsoft 365 Outlook package (based on Graph API) if your bots are impacted by the deprecation. See [Microsoft 365 Outlook package](#) on page 2851.

- 
1. Download the latest version of Bot Scanner from the Automation Anywhere Support site:
    - a) Navigate to the [A-People Downloads page \(Login required\)](#).
    - b) Click the Automation 360 v.xx <Build\_number> link.  
The xx in the link refers to the release number. For example, Automation 360 v.29.
    - c) Click the `Installation Setup` folder.

- d) Click the AAE Bot Scanner zip file, and then click **Download** on the toolbar.

**Note:** Ensure that you use the .exe file made available with Automation 360 v.29 and later releases.

2. Extract the files from the zip file you have downloaded and double-click the executable file to run the utility.
3. In the **Bot Scanner** page, click the drop-down list and select **Bots using Email action with EWS option** to select bots that use the EWS protocols.

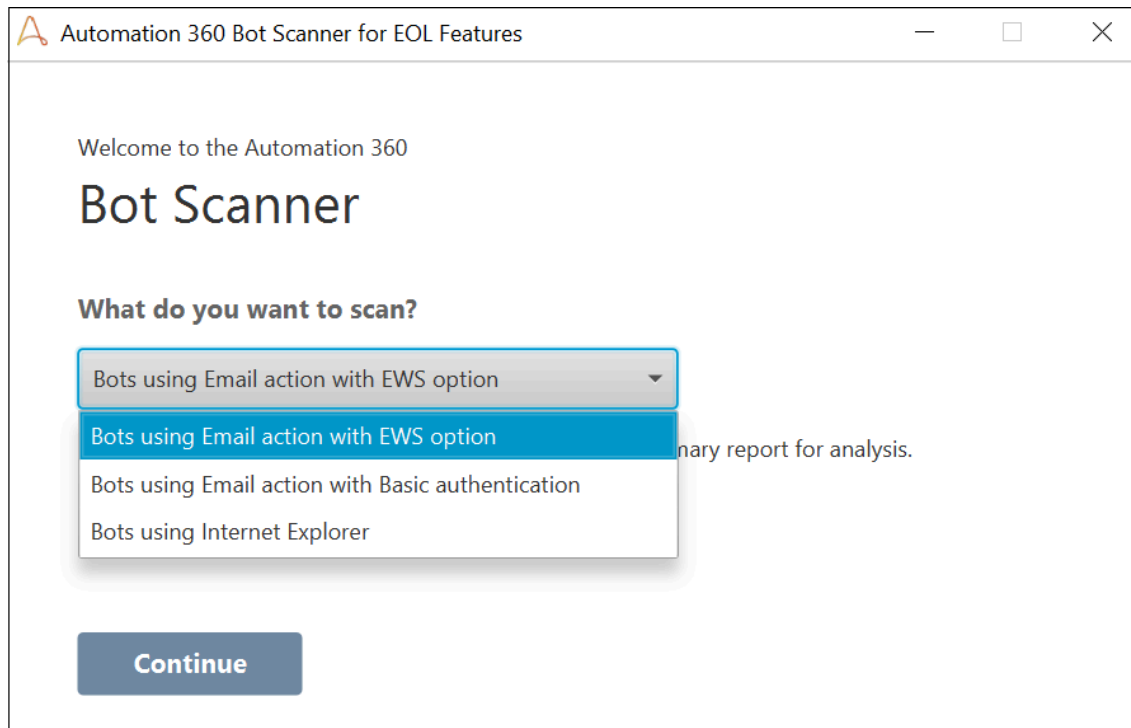

4. Click **Continue**.
5. In the **Automation 360 Bot Scanner EOL features page**, perform these steps:
  - a) Enter the Control Room URL that you want to connect to
  - b) Based on the authentication type configured in your Control Room, choose one of the following authentication methods in the **Authentication Type** field:

Authentication type	Steps
Active Directory	<ol style="list-style-type: none"> <li>1. Enter the <b>Username</b> (Domain\username).</li> <li>2. Enter the <b>Password</b> (domain user password).</li> </ol>
Database	<ol style="list-style-type: none"> <li>1. Enter the <b>Username</b> (Control Room database username).</li> <li>2. Enter the <b>Password</b> (Control Room database user password).</li> </ol>

Authentication type	Steps
Single Sign-On	<ol style="list-style-type: none"> <li>1. Enter the <b>Username</b>.</li> <li>2. Enter the <b>API Key</b>.</li> </ol>

- c) Click **Test connection**.  
A connection success or failure message is displayed. Validate your credentials if the connection fails.
- d) In the **Select destination path** field, enter the location where you want to save the generated report.
- e) Click **Scan bots**.

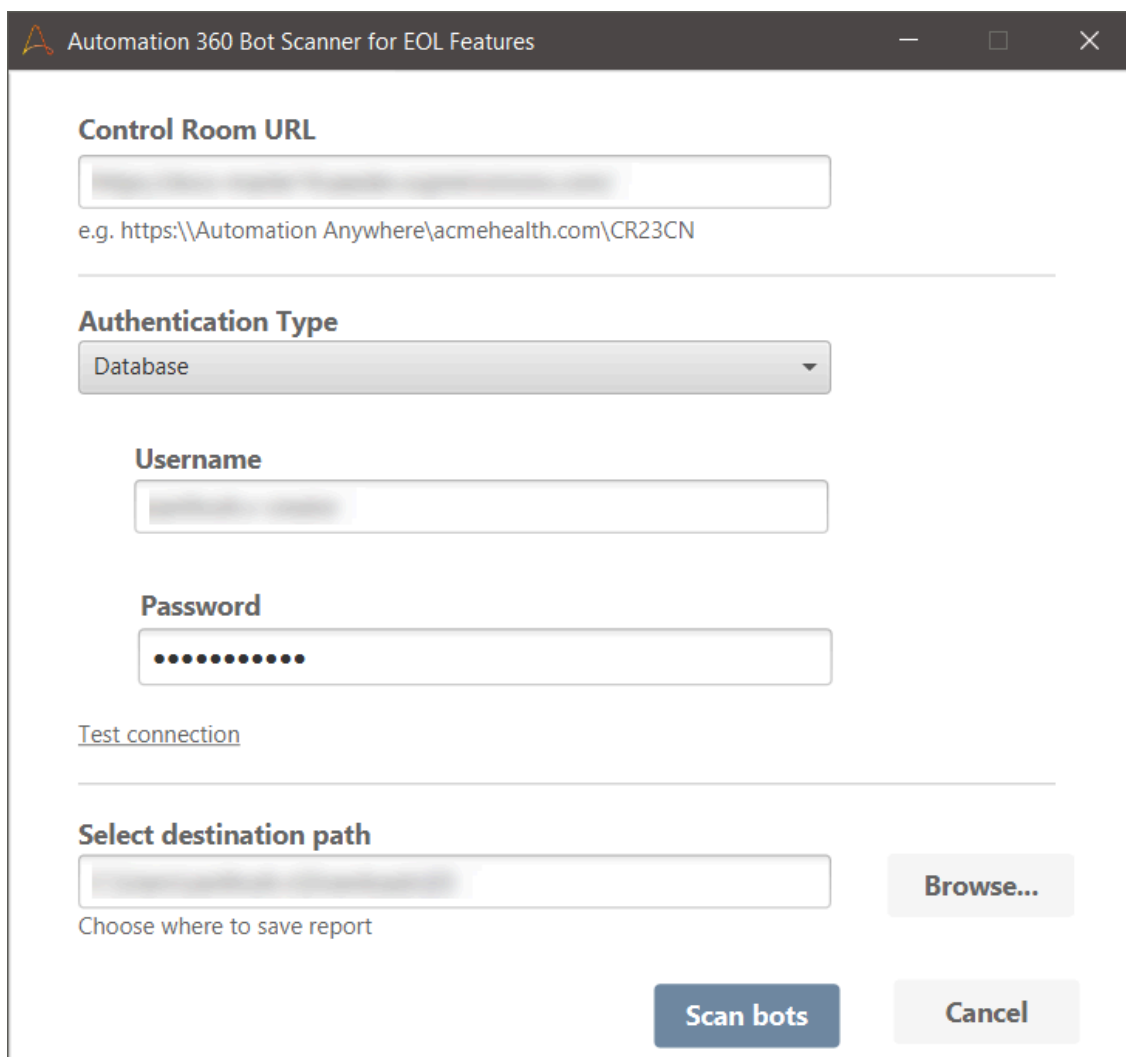

The scanner scans all the bots in your Control Room repository. After the scan is complete, a report (.CSV file) is available in the destination path you selected for your review.

- If a .CSV file already exists in the output folder, a message is displayed that the previous .CSV file will be deleted. When you click **Continue**, a new .CSV file is generated.

- If the previous .CSV file is in use, a message is displayed that the file cannot be deleted. Close the file and click **Scan bots**.
6. Click **Open report** to analyze the report.  
The report contains the following details:
- Task Bot name: Name of the Task Bot.
  - Line number: The line number of the actions that are using the EWS option.
  - Package and action name: The Email package and action that is using EWS.
  - Searched text: The hostname of the Email server or the domain name of the EWS server for the respective action.
  - Action and review message: Use this information to understand the action that you have to perform or the information that you have to review for the corresponding action that is using the EWS option.
  - Task Bot path: The path to the repository where the bot resides.

After you identify the bots that are impacted, edit the impacted bot by replacing each action using the EWS option with the equivalent actions in the Microsoft 365 Outlook package. Test the bot and ensure the result is same.

## In-product user assistance

Automation 360 provides in-product assistance through the Resource center widget. The in-product help and guide provides on-demand access to product documentation, walkthroughs, and other guides to help you familiarize with the interface and learn more about the capabilities in the product.

### Help center (in-product help)

The Help center (a part of the Resource center widget in Automation 360) provides contextual assistance to access real-time documentation within the product when you use the interface and build automations.

---

**Important:** The Help center is available only on Cloud Control Room instances and can be accessed only from the **Home** page and the Bot editor. Administrators cannot disable this feature for any of the users.

---

When you log in to the Control Room, the Help center shows content related to the features or settings in the **Home** page and in the Bot editor page. The Help center is located at the bottom-right of these pages. In the Help center, you can search for content from the documentation portal or click the suggested topic links to open and view related content within the Help center.

Professional developers can use the suggested topics or search for specific packages, actions, or other information for bot development. Additionally, the documentation link in the contextual help loads the content directly in the Help center. This feature helps developers eliminate the need to switch between the Bot editor and the documentation portal, thus providing a better user experience.

The Help center provides quick assistance for developers when they create bots in the Bot editor. Developers can search for contextual information about actions and packages by clicking the document help icons. The Help center updates to show content relevant to the selected action

without the user having to navigate outside the Bot editor. Depending on your preference, you can view the content in **Theater** or **Full screen** mode.

View how to access the Help center and its features in the following video:

## In-product guide

Automation 360 uses a digital adoption platform to provide in-product user assistance (guides and walkthroughs) and anonymously analyze product usage such as page views and feature clicks. This data is used to inform user research and improve the overall experience of Automation Anywhere solutions.

### Services performed

- In-product guides and user notifications
- In-product educational spotlights
- Informational tips and other contextual user assistance elements within the product to help onboard users
- Anonymized user analytics to understand usage patterns of Automation Anywhere products

### Data processed

- Clicks on user interface elements within Automation Anywhere products
- User ID in a form that does not disclose the identity of the user (for example, 159:0a664495-7f3e-126a-817f-513aeedf003e)
- Web-browser type, web-browser version
- Server Control Room URL
- Language selected (English, Japanese, and so on)
- User's first visit and last visit
- User's permissions settings
- List of features to which the user has access
- Product features that are used
- Automation Anywhere license type (Developer, Attended User, and so on)
- Automation Anywhere product version number
- User provided ratings and feedback comments on product features and functionality

---

**Note:** The digital adoption platform does not receive the user's IP address or bot information such as which bot was run and what the bot does.

---

### Types of data captured

Automation Anywhere captures the following three types of data when using the digital adoption platform:



- Event data

Includes click and focus events providing usage metrics. This enables us to understand the adoption of features and usage patterns to inform future improvements to the experience of our products.

For example:

- Clicking the **Run Bot** option
- Clicking the paths to open a bot in the Bot editor
- Tabbing into a search input

---

**Note:** The platform does not collect any user-entered text.

---

- Page load data

Includes data captured as users navigate to various parts of the web application, such as root paths of links and page titles

---

**Note:** The platform does not collect any input parameters sent through a link.

---

- Metadata

Includes metadata that is associated with clicks and page loads when a user logs in to Automation Anywhere products.

Metadata that is sent to the digital adoption platform includes the following types of information:

- Pseudonymized user ID
- Pseudonymized account ID
- Selected language
- Build number
- Browser version

---

**Note:** The platform explicitly does not:

- Record the screen
  - Perform any sort of screen-scraping
  - Capture data entered in any input field
- 

Blocking the platform

Blocking the digital adoption platform will block in-product user assistance and important system messages such as the following:

- Productivity boosts through targeted user tutorials
- Targeted important announcements and direct communications
- Opportunity for in-app direct feedback, requests, and support
- In-app integration to Automation Anywhere documentation and support
- Ability to see user behavior so that we can proactively make improvements to the product

# Set up Automation 360

Automation 360 provides a web-based, cloud-native RPA platform for users of all types. Review the tasks involved in setting up Automation 360.

**Legal disclaimer:** The information provided in this workflow might vary depending on which offering you use. Administrator steps might not be applicable to Cloud or Community Edition.

1. Choose your Automation 360 deployment model.

[Deployment models](#) on page 1017

2. Verify the system prerequisites based on your deployment model:

- Cloud: [Automation 360 Cloud prerequisites](#) on page 1166
- On-Premises: [Automation 360 On-Premises prerequisites](#) on page 1180
- Community Edition: [Set up Community Edition](#) on page 1326

3. Administrators: Set up bot users.

Bot users, skip this step and proceed to Step 4.

- a) Receive your administrator credentials.

- Cloud administrators: Receive your login credentials with administrator privileges and your Automation 360 dedicated URL from Automation Anywhere.
- On-Premises administrators: Receive your licensing information from Automation Anywhere and install Automation 360.

The installation user is assigned administrator privileges.

Installation type	Go here
Windows	<a href="#">Installing Control Room On-Premises</a> on page 1177  To view this installation task in an interactive visual format, see <a href="#">Install Control Room On-Premises (custom mode)</a> .
Linux	<a href="#">Installing Control Room on Linux</a> on page 1293
Amazon Web Services	<a href="#">Installing Control Room on Amazon Web Services</a> on page 1272
Microsoft Azure	<a href="#">Installing Control Room on Microsoft Azure</a> on page 1279
Google Cloud Platform	<a href="#">Installing Control Room on Google Cloud Platform</a> on page 1288

- b)** Log in to a supported device, open a supported web browser, and log in to your Control Room using the dedicated URL.
    - [Bot Runner device requirements](#) on page 1167
    - [Log in to Automation Anywhere Control Room](#) on page 1488
  - c)** Create your bot users by assigning a role and device license.
    - [Create a user](#) on page 1739
    - [Create an Active Directory user](#) on page 1740
  - d)** Set up email notifications to Control Room users when events affect them, such as changes to passwords or user information, and account activation or deactivation.
- 4.** Bot users: Perform these steps to get started with Automation 360.
- a)** Receive your user login credentials and the Control Room dedicated URL.  
Credentials are sent to you from your company's Automation Anywhere administrator or from Automation Anywhere.  
Community Edition users: If you do not have an Automation 360 account, register for a free Community Edition account by visiting [Automation Anywhere Community Edition](#).
  - b)** Log in to your Automation 360 account.  
Log in to a supported device, open a supported web browser, and log in to your Control Room.
    - [Bot Runner device requirements](#) on page 1167
    - [Log in to Automation Anywhere Control Room](#) on page 1488
  - c)** [Install Bot Agent and register device](#) on page 1347.

---

**Note:** The Bot Agent is installed only on devices running supported Windows operating systems. See [Bot Runner device requirements](#) on page 1167. You can create bots using the Bot editor in the Control Room, but to run the bots you must install the Bot Agent on your device.

---
  - d)** Start creating bots:
    - [Create your first bot](#) on page 1489
    - [Build a Go be Great bot](#) on page 3198

---

**Update Automation 360:** See [Update Automation 360 to latest version](#) on page 1423.

Cloud and the Community Edition are updated automatically.

---

Related tasks

[Log in to Automation Anywhere Control Room](#) on page 1488

To log in to Automation 360, open the Control Room URL in your browser, enter your credentials in the login screen, and click **Log in**.

[Set up Community Edition](#) on page 1326

Community Edition is a free web-based option for you to experience a wide range of bot creation capabilities available in Automation 360. Use these tasks to register for, and start creating and using bots with the Community Edition.

Related reference

[Bot Runner device requirements](#) on page 1167

Review the hardware requirements, operating system versions, and browser types supported for creating and running bots on a device. The same requirements are also valid for Automation 360 Community Edition.

[Browser requirements for Automation Workspace](#) on page 1210

Access the Automation Workspace interface from a browser. After you have installed and enabled extensions in the browser, perform several tasks through the Automation Workspace interface based on your user role and automation requirements.

Related information

[Install and update Automation 360 IQ Bot Enterprise v11 Client installation](#)

## Get started with Automation 360 Cloud

Use these tasks to start creating and using bots with Automation 360 Cloud.

1. Complete the prerequisites for Cloud.

[Automation 360 Cloud prerequisites](#) on page 1166

Use the checklist to determine whether your device fulfills the requirements for registering with Automation 360 Cloud.

2. [Provision Cloud Control Room instances](#) on page 1416.

Use the Licenses and Cloud Services portal to provision Cloud Control Room and Cloud sandbox Control Room instances on demand.

3. Receive your Control Room URL and login credentials. The URL points to your Automation 360 instance.

If you are your company's principal administrator and ordered cloud-deployed Automation 360, you receive an email from Automation Anywhere with your URL and credentials.

4. [Log in to Automation Anywhere Control Room](#) on page 1488.

To log in to Automation 360, open the Control Room URL in your browser, enter your credentials in the login screen, and click **Log in**.

5. Install Bot Agent, register your device, and set user device credentials.

[Install Bot Agent and register device](#) on page 1347 | [Set user device credentials](#) on page 1353

The Bot Agent is a lightweight application that enables you to run bots on your device by connecting the device to the Control Room. To run bots on a local machine, install the Bot Agent and add the local device to the list of enabled host devices.

To enable a device for running bots, set the local device credentials.

If you are using an operating system other than Windows, you will not be able to install the Bot Agent at this time. See [system requirements](#). However, you can still build bots using the [Bot editor](#).

**6. [Create your first bot](#)** on page 1489.

Follow these steps to create your first bot that prints the message, `Go be great!`, the Automation Anywhere version of `Hello World!`

**7. [Run your first bot](#)** on page 1493.

Run a bot from the same device that you used to create the bot.

## Video resources

- [Introduction to Automation 360](#)
- [Installing the Bot Agent in Automation 360:](#)
- [Building your first bot:](#)
- [Running your first bot in the Community Edition:](#)

Related information

[Cloud RPA](#)

## Automation 360 Cloud prerequisites

Use the checklist to determine whether your device fulfills the requirements for registering with Automation 360 Cloud.

- Verify the device software and hardware requirements.  
[Bot Runner device requirements](#) on page 1167
- Access the Control Room URL from your browser.  
[Log in to Automation Anywhere Control Room](#) on page 1488
- Add the Automation Anywhere Domain Name System (DNS) to the safe recipients or allowed list to ensure secure access to Automation 360 cloud services.  
[Add service URLs to trusted list for Cloud](#) on page 1170
- Allow Automation Anywhere communications ports and protocols.  
[Allow Automation Anywhere communications ports](#) on page 1172
- Add devices to the allowed list within the corporate network for granular security.  
[Add access public IP addresses](#) on page 1808
- Add or update the authenticating proxy credentials to connect your device.  
[Connect Bot Agent to a device with a proxy](#) on page 1351
- Set up SAML authentication identity provider if you are using single sign-on (SSO).  
[Set up SAML authentication](#) on page 1390
- Configure your network firewall to add the outbound NAT Gateway IP addresses to the allowed list.  
[Control Room IP addresses for external integrations](#) on page 1829
- When configuring your domain and subdomain Control Room URLs, you must follow the Domain Name System (DNS) guidelines.

[Naming guidelines for Control Room URLs](#) on page 1370

- To ensure seamless connectivity of your IQ Bot cloud servers with the Cloud Control Room, specify a list or range of IP addresses that are allowed to access the Cloud Control Room URL.

[Add IQ Bot cloud server IP addresses to allowed list](#) on page 1174

## Bot Runner device requirements

Review the hardware requirements, operating system versions, and browser types supported for creating and running bots on a device. The same requirements are also valid for Automation 360 Community Edition.

### Hardware requirements for registered devices

You communicate with the Control Room through a registered local machine (device). Bot Creators and Bot Runners use the registered devices to create and run bots. Part of registering a device with Automation 360 is installing a Bot Agent.

The Bot Agent can be installed on devices that meet or are equivalent to the following hardware requirements:

Device	Processor	RAM	Storage (free disk space)	Network
Single user machine	Intel Core i3 2.6 GHz with 4 multi-cores or higher 64-bit	<ul style="list-style-type: none"> <li>4 GB (Minimum)</li> <li>8 GB (Recommended)</li> </ul>	<ul style="list-style-type: none"> <li>32 GB</li> <li>Add 100 through 150 KB per Automation Anywhere script</li> </ul>	<ul style="list-style-type: none"> <li>5Mbps (Minimum)</li> <li>20Mbps or higher (Recommended)</li> </ul>
Multi-user machine	2 CPU per additional user	4 GB per additional user	<ul style="list-style-type: none"> <li>Add 40 through 50 GB per long-term project</li> </ul>	

**Note:** If you have more than 10 users for a multi-user machine, ensure that you double the storage space and network bandwidth as well. For example, if you have 20 users, the storage space must be a minimum of 64 GB and the network bandwidth must be 40 Mbps or higher.

Additional RAM requirements for the registered devices

Add additional RAM to account for applications and services running on the registered devices, for example:

- Microsoft Office applications (example: Excel)
- Browsers (example: Google Chrome)
- Enterprise applications (example: CRM, Oracle EBS, and SAP)

- VDI infrastructure applications
- Anti-virus software
- AISense Recorder

Additional disk space on registered devices

- Automation 360 scripts average approximately 100-150 KB. Additional free disk space is required to develop automation projects because temporary files such as screenshots, server logs, and audit files are created during the execution of the automation scripts.
- Free space required increases with the project size. Recommendation: Have at least 40-50 GB of free disk space for each long-term project.
- Increase storage space configuration after installation, as needed, depending on product usage. For example, depending upon the complexity of your bot, generating log files and logic creation require additional disk space later.

### Additional CPU or processor on registered devices

AISense Recorder: Additional CPU or processor is required on a device if the existing CPUs are utilized by customer applications. It is also required in case of a VDI infrastructure where CPU or processors are shared across the infrastructure.

### Platform compatibility for registered devices

A device used to connect to the Control Room and perform bot tasks must meet the platform requirements.

---

**Note:** Platform requirements are different for Control Room and Bot Agent.

---

Registered devices	Physical machines that you want to use for creating bots or deploying bots and running any of the supported operating systems.
Terminal servers	Using remote desktop (RDP), running any of the supported operating systems is supported on Automation 360 Version A2019.11 or later.
Virtual machines	Bot Agent is supported on all VMs where the supported Windows OS has been hosted on Version A2019.09 or later. For example, Virtual Desktop Infrastructure (VDI) are supported on Amazon Web Services, Microsoft Azure, Google



Cloud Platform, VMware virtual machines, and Oracle Virtual Box.

## Supported operating systems for registered devices

A device used to run the Bot Agent, connect to the Control Room, and perform bot tasks as a Bot Creator and Bot Runner must meet the operating system requirements.

### Note:

- Only 64-bit operating system version supported.
- Bot Creator tasks are supported with all the listed operating systems.
- You cannot register a device that is running on a Linux system. The Bot Agent cannot be installed on Linux systems. However, you can use a registered device running on a Windows system to access a Control Room that is installed on a Linux system.

Windows version	Windows edition	Attended Bot Runner	Unattended Bot Runner	Bot Creator
Windows Server 2022	Datacenter	Supported	Supported <sup>1</sup>	Supported
Windows Server 2019	Datacenter and Standard	Supported	Supported <sup>1</sup>	Supported
Windows Server 2016	Datacenter and Standard	Supported	Supported <sup>1</sup>	Supported
Windows Server 2012	Datacenter and Standard	Supported	Supported <sup>1</sup>	Supported
Windows 11	Enterprise	Supported	Supported <sup>1</sup>	Supported
Windows 10	Professional and Enterprise	Supported	Supported <sup>1</sup>	Supported
Windows 8 <sup>2</sup>	Professional and Enterprise	Supported	Supported	Supported
Windows 7 <sup>2</sup>	Professional and Enterprise	Supported	Supported	Supported

(1) Auto-login

Auto-login is only supported on 64-bit systems.

(2) Supported OS

Windows 11 (64-bit) supported on Automation 360 Build 15459 or later.

Windows 8 (64-bit) supported on Enterprise A2019 (Builds 1598 and 1610) or earlier.

Windows 7 (64-bit) supported on Enterprise A2019.12 or later.

## Add service URLs to trusted list for Cloud

For Cloud deployment, to ensure secure access to Automation 360 online services, add the service URL list to the safe recipients or trusted list.

### URLs list

Online service hosting uses dynamic IP addresses, therefore we recommend that you add to the safe recipients or trusted list, the complete URL instead of an IP address for the Automation Anywhere online services.

**Note:** See your device documentation for information about how to add URLs to trusted list on your device.

Service	URL	Port	Device
Automation Anywhere	www.automationanywhere.com	TCP 443 (HTTPS)	All devices
Automation Anywhere Cloud customer tenant  Includes Automation Anywhere Control Room and IQ Bot	crdomainname-X.my.automationanywhere.com  <b>Note:</b> <ul style="list-style-type: none"> <li>crdomainname-X refers to your specific tenant name.</li> <li>The tenant name does not support the underscore ( _ ) character. So an underscore is used in the tenant name, the specified URL will not be created.</li> </ul>	TCP 443 (HTTPS)	All devices that access Automation 360
Automation Anywhere Bot Agent download link	aai-artifacts.my.automationanywhere.com	TCP 443 (HTTPS)	All devices that access Automation 360
Automation Anywhere community (A-People)	apeople.automationanywhere.com	TCP 443 (HTTPS)	All devices
Automation Anywhere documentation	docs.automationanywhere.com	TCP 443 (HTTPS)	All devices
Bot Store	botstore.automationanywhere.com	TCP 443 (HTTPS)	All devices

Service	URL	Port	Device
<p>Content delivery network (CDN)</p> <p>Enables your platform to perform faster as it geographically distributes common static content for cloud tenants.</p>	<p>aai-artifacts.my.automationanywhere.digitalaccess</p>	<p>TCP 443 (HTTPS)</p>	<p>All devices Automation 360</p>
<p>Telemetry</p> <p>Allows performance and usage information to be gathered anonymously in order to improve product quality.</p>	<ul style="list-style-type: none"> <li>cdn.pendo.io/</li> <li>app.pendo.io/</li> <li>data.pendo.io/</li> <li>https://pendo-static-5673999629942784.storage.googleapis.com/</li> </ul>	<p>TCP 443 (HTTPS)</p>	<p>All devices</p>
<p>Automation Anywhere Google Chrome extension</p> <p>Enables you to automate using the Google Chrome browser.</p>	<p>MV3 extension</p> <p>https://chrome.google.com/webstore/detail/automation-360/bbocnojhhoegffpcllbeigipedjedf</p> <p>MV2 extension</p> <p>https://chrome.google.com/webstore/detail/automation-360/kammdlphdfejlopbonbapgpbgakimokm</p>	<p>TCP 443 (HTTPS)</p>	<p>Bot Creator and Bot Runner devices</p>
<p>Automation Anywhere Microsoft Edge extension</p> <p>Enables you to automate using the Microsoft Edge browser.</p>	<p>MV3 extension</p> <p>https://microsoftedge.microsoft.com/addons/detail/automation-360-beta/fnmjcdajlonpigpcfnemeikipmolbfii</p> <p>MV2 extension</p> <p>https://microsoftedge.microsoft.com/addons/detail/automation-360/dbmodiepejcgijlbmeebedkmegndokbk</p>	<p>TCP 443 (HTTPS)</p>	<p>Bot Creator and Bot Runner devices</p>

Service	URL	Port	Device
Automation Anywhere Mozilla Firefox extension Enables you to automate using Mozilla Firefox browser.	<a href="https://addons.mozilla.org/en-US/firefox/addon/automation-360">https:// addons.mozilla.org/ en-US/ firefox/addon/ automation-360</a>	TCP 443 (HTTPS)	Bot Creator and Bot Runner devices

## Files and folders

For information on files and folders to add to the safe list and to the antivirus exception list, see these articles:

- [Files and URLs to add to safe list for Automation 360 \(A-People login required\)](#)
- [List of files to add to antivirus exception list for Automation 360 \(A-People login required\)](#)

### Related tasks

[Add access public IP addresses](#) on page 1808

Use this setting to limit user login access to the Control Room URL based on IP addresses or subnets that you specify in a list. You add IP address ranges using the Classless Inter-Domain Routing (CIDR) format, and you can add multiple CIDR ranges.

### Related reference

[Ports, protocols, and firewall requirements](#) on page 1203

View the default and configurable firewall, port, and protocol requirements for Automation Anywhere deployment. View the default ports and protocols that are required to be allowed on customer's firewall for Automation Anywhere deployment. The default ports that are used for HTTP/HTTPS are configurable.

[Add service URLs to trusted list for On-Premises](#) on page 1322

For On-Premises deployment, to ensure secure access to Automation 360 online services, add service URL list to the safe recipients or trusted list.

[Add IQ Bot cloud server IP addresses to allowed list](#) on page 1174

To ensure seamless connectivity of your IQ Bot cloud servers with the Cloud Control Room, specify a list or range of IP addresses that are allowed to access the Cloud Control Room URL.

[Control Room IP addresses for external integrations](#) on page 1829

To ensure seamless connectivity to your Git instance, On-Premises key vault, or SIEM with the Cloud Control Room, configure your network firewall to include Automation Anywhere outbound Automation 360 IP addresses to the allowed list.

## Allow Automation Anywhere communications ports

As part of the Automation 360 Cloud prerequisites, you must allow Automation Anywhere communications ports and protocols from the customer network.

### Cloud communications ports

You can set the following connection modes between the customer network and the Control Room:

- Outbound: The traffic flows from the customer network to the Control Room.
- Inbound: The traffic flows from the Control Room to the customer network.

**Note:**

- The Bot Agent workflow works only with outbound connection and the connection requests are initiated only from the Bot Agent; no connection requests are initiated from the Control Room. The inbound connection is only required when you have configured any integrations to: Git repository, On-Premises external key vault, or SIEM server with your cloud-hosted Control Room.
- You must open the Cloud communications ports to unidirectional (outbound connection) to transmit traffic from the customer network to the cloud-hosted Control Room.

The following table describes the required Cloud communications ports:

Automation 360 Cloud communications ports				
From	To	Port	Protocol	Connection type
Bot Agent (customer hosted)	Control Room (Automation Anywhere hosted)	443	HTTPS	Outbound
Bot Agent (customer hosted)	Control Room (Automation Anywhere hosted)	443	WebSocket	Outbound
Access to Control Room through browser	Control Room (Automation Anywhere hosted)	443	HTTPS	Outbound
Control Room (Automation Anywhere hosted) where Control Room connects from these <a href="#">Control Room IP addresses for external integrations</a> on page 1829	Third-party Keystore (customer hosted and optional)	443	HTTPS	Inbound

Automation 360 Cloud communications ports				
From	To	Port	Protocol	Connection type
Control Room (Automation Anywhere hosted) where Control Room connects from these <a href="#">Control Room IP addresses for external integrations</a> on page 1829	Git Repository (customer hosted and optional)	443	HTTPS	Inbound
Control Room (Automation Anywhere hosted) where Control Room connects from these <a href="#">Control Room IP addresses for external integrations</a> on page 1829	SIEM server (customer hosted and optional)	443	HTTPS	Inbound

## Add IQ Bot cloud server IP addresses to allowed list

To ensure seamless connectivity of your IQ Bot cloud servers with the Cloud Control Room, specify a list or range of IP addresses that are allowed to access the Cloud Control Room URL.

Based on your region, add the following outbound NAT IP addresses to the allowed list in the Cloud Control Room network settings:

Region	IP addresses
- Africa	<ul style="list-style-type: none"> <li>• 13.244.57.44</li> <li>• 13.244.197.159</li> <li>• 13.244.185.72</li> <li>• 54.228.5.1</li> <li>• 54.228.48.30</li> <li>• 54.217.103.248</li> </ul>
- Australia	<ul style="list-style-type: none"> <li>• 54.153.153.175</li> <li>• 52.65.8.56</li> <li>• 3.106.147.142</li> </ul>

Region	IP addresses
- Canada	<ul style="list-style-type: none"> <li>• 35.203.94.19</li> <li>• 34.152.28.44</li> </ul>
- EU West 1	<ul style="list-style-type: none"> <li>• 108.128.188.103</li> <li>• 63.34.200.237</li> <li>• 52.30.160.238</li> <li>• 18.197.15.181</li> <li>• 18.195.27.35</li> <li>• 3.123.208.13</li> </ul>
- EU West 4	<ul style="list-style-type: none"> <li>• 35.204.101.230</li> <li>• 34.141.232.185</li> <li>• 34.141.55.27</li> <li>• 34.141.57.227</li> </ul>
India	<ul style="list-style-type: none"> <li>• 3.7.60.137</li> <li>• 3.6.235.61</li> <li>• 13.232.116.48</li> <li>• 18.136.73.65</li> <li>• 52.77.203.34</li> <li>• 18.136.8.15</li> </ul>
- Japan	<ul style="list-style-type: none"> <li>• 18.177.157.130</li> <li>• 18.176.174.19</li> <li>• 3.114.196.205</li> <li>• 54.169.202.27</li> <li>• 52.221.25.42</li> <li>• 18.140.96.19</li> </ul>
- LATAM	<ul style="list-style-type: none"> <li>• 54.94.241.48</li> <li>• 18.229.39.93</li> <li>• 52.67.153.170</li> <li>• 34.195.218.48</li> <li>• 3.211.67.78</li> <li>• 3.228.163.41</li> </ul>
- Middle East	<ul style="list-style-type: none"> <li>• 15.185.153.52</li> <li>• 15.185.181.122</li> <li>• 157.175.32.98</li> <li>• 52.213.112.204</li> <li>• 54.154.112.221</li> <li>• 34.242.58.85</li> </ul>

Region	IP addresses
- Sandbox Australia	<ul style="list-style-type: none"> <li>• 34.151.71.179</li> <li>• 35.189.24.10</li> </ul>
- Sandbox EU West	<ul style="list-style-type: none"> <li>• 54.228.82.108</li> <li>• 54.73.17.42</li> <li>• 54.228.85.241</li> <li>• 3.122.33.207</li> <li>• 35.156.216.8</li> <li>• 18.159.235.149</li> </ul>
- Sandbox US West	<ul style="list-style-type: none"> <li>• 35.164.189.142</li> <li>• 35.166.154.241</li> <li>• 35.160.254.91</li> <li>• 35.168.234.8</li> <li>• 34.204.215.165</li> <li>• 54.92.237.118</li> </ul>
- Singapore	<ul style="list-style-type: none"> <li>• 18.141.71.43</li> <li>• 54.251.139.55</li> <li>• 18.136.253.184</li> <li>• 18.176.165.62</li> <li>• 52.68.115.49</li> <li>• 54.168.135.182</li> </ul>
- US Central	<ul style="list-style-type: none"> <li>• 34.85.131.101</li> <li>• 35.245.151.203</li> <li>• 34.68.252.217</li> <li>• 34.123.71.95</li> </ul>
- US East	<ul style="list-style-type: none"> <li>• 50.16.245.134</li> <li>• 35.174.84.76</li> <li>• 3.210.114.16</li> <li>• 54.244.136.23</li> <li>• 54.185.77.190</li> <li>• 44.234.224.213</li> </ul>
- US East 2	<ul style="list-style-type: none"> <li>• 18.222.104.223</li> <li>• 3.20.77.240</li> <li>• 3.138.227.220</li> </ul>



Region	IP addresses
- US West	<ul style="list-style-type: none"> <li>• 54.213.119.159</li> <li>• 34.218.159.79</li> <li>• 52.33.16.117</li> <li>• 3.225.222.13</li> <li>• 34.197.160.162</li> <li>• 3.213.188.29</li> </ul>
- Sandbox US Central	<ul style="list-style-type: none"> <li>• 35.223.219.53</li> <li>• 34.133.80.165</li> <li>• 34.150.165.212</li> <li>• 35.245.150.192</li> </ul>
- Sandbox Singapore	<ul style="list-style-type: none"> <li>• 13.251.176.239</li> <li>• 54.169.33.175</li> <li>• 46.137.201.87</li> </ul>

#### Related tasks

[Add access public IP addresses](#) on page 1808

Use this setting to limit user login access to the Control Room URL based on IP addresses or subnets that you specify in a list. You add IP address ranges using the Classless Inter-Domain Routing (CIDR) format, and you can add multiple CIDR ranges.

#### Related reference

[Add service URLs to trusted list for Cloud](#) on page 1170

For Cloud deployment, to ensure secure access to Automation 360 online services, add the service URL list to the safe recipients or trusted list.

## Installing Control Room On-Premises

Review the installation core tasks and topics for installing the Automation 360 Control Room in a data center on an On-Premises server or a cloud service provider server instance.

The Control Room provides centralized management for a digital workforce and an interface for Bot Insight. It is deployed on a server in a data center.

---

#### Note:

- For instructions on installing Control Room on Linux, see [Installing Control Room on Linux](#) on page 1293.
  - Linux is not supported for Cloud-enabled On-Premises installations.
  - During On-Premises installation, the Control Room tries to connect to `http://async-io.org/`. You need not allow this connection, or you can ignore if the connection fails. Because this connection is not required, we plan to disable the request for this connection in a future release.
-

## Control Room installation core tasks

### Prerequisites

Before you begin, download the appropriate installer for your operating system and version from [A-People Downloads page \(Login required\)](#).

#### Step 1: Pre-installation

[Automation 360 On-Premises prerequisites](#) on page 1180 Determine whether the system has the required hardware and software to install Control Room for On-Premises.

#### Step 2: Installation

The Control Room installer allows you to select installation modes (Express or Custom), and during the installation process, it also installs missing software dependencies.

---

**Note:** The Control Room installer is available only in English.

---

Use Custom mode to install on a cloud-based platform such as Amazon Web Services.

[Installing Control Room using Express mode](#) on page 1270 Log in to the servers as an Administrator and install Automation Anywhere Control Room in Express Mode using the default settings.

[Installing Control Room using Custom mode](#) on page 1245 Log in to the server as an administrator and install Automation Anywhere Control Room in Custom mode to select installation and configuration options, including installing non-default requirements. Select this mode for a data center deployment.

To view this installation task in an interactive visual format, see [Install Control Room On-Premises \(custom mode\)](#).

	<a href="#">Installing Control Room on Microsoft Windows Server using scripts</a> on page 1308	Silent Control Room installation, also known as unattended installation, uses a customized script for a full setup or the command line for a hot fix patch. Silent install runs the entire installation process in the background without requiring user interaction or displaying messages.
Step 3: Post-installation	<a href="#">Configuring post-installation settings</a> on page 1315	The options for launching the Control Room for the first time and the authentication method depend on the installation mode and deployment type.
	<a href="#">Verifying Automation Anywhere services</a> on page 1317	Automation Anywhere specific services are installed on the Control Room server.
Step 4: Validation	<a href="#">Configure Control Room authentication options</a> on page 1373	The options for launching the Control Room for the first time and the authentication method depend on the installation mode and deployment type.
	<a href="#">Managing Cloud and file licenses</a> on page 1406	Follow the instructions to install a valid license key or license file on your On-Premises Control Room. <ul style="list-style-type: none"><li>• For the license key, install a license GUID from the Licenses and Cloud Services portal on your On-Premises Control Room.</li></ul>

- For file-based licensing, generate a license file from the Licenses and Cloud Services portal and install it on your On-Premises Control Room.

## Automation 360 On-Premises prerequisites

Determine whether the system has the required hardware and software to install Control Room for Automation 360 On-Premises.

### Hardware requirements

[Control Room server requirements](#) on page 1187

The Control Room is deployed on servers in data centers. The minimum Automation Anywhere hardware requirements include: server type, machine type, processor, RAM, disk storage, and network requirements.

[Operating system, environment, and platform supported for Control Room](#) on page 1194

Automation 360 can be hosted on AWS, Microsoft Azure, Google Cloud Platform, IBM, and any public, private, or hybrid cloud service that meets the Control Room and Bot Agent hardware and software requirements.

[Bot Agent compatibility](#) on page 1332

Bot Agent is the Automation 360 plug-in that enables you to create and run bots. The agent is installed on devices used to access the Control Room. Installing the Bot Agent is part of registering a device.

[Credential requirements](#) on page 1197

Login credentials are required at different stages of Automation Anywhere deployment and use. Credentials are required for installation and data center servers, access to Automation Anywhere components, and to run tools in bots.

[Supported cloud platforms](#) on page 1197

Review the supported cloud platforms for various Automation 360 features.

### Data center requirements

[Database requirements](#) on page 1188

[Working with SQL Servers](#) on page 1192    Configure Microsoft SQL Servers before

		setting up the Control Room database.
	<a href="#">Working with Azure SQL PaaS on page 1193</a>	Using PaaS SQL database with Azure requires configuration from the Azure instance.
<a href="#">Load balancer requirements on page 1201</a>		View the load balancer requirements for Automation Anywhere installation. This includes load balancer minimum requirements, and both TCP and HTTPS layer load balancing requirements.
<a href="#">Ports, protocols, and firewall requirements on page 1203</a>		View the default and configurable firewall, port, and protocol requirements for Automation Anywhere deployment.
<a href="#">Browser requirements for Automation Workspace on page 1210</a>		The user interface for Automation 360 (On-Premises or Cloud deployed) and for Community Edition is accessible through a browser.
<a href="#">HA and DR deployment models on page 1230</a>	<a href="#">High availability deployment on page 1235</a>	The high availability (HA) deployment model provides failure tolerance for the Control Room servers, services, and databases using a distributed load balancer.
	<a href="#">Disaster recovery deployment on page 1237</a>	The disaster recovery (DR) deployment model uses high availability (HA) clusters distributed across separate geographic areas.
	<a href="#">Single-node deployment on page 1231</a>	A single-node deployment hosts the Control Room only on one server or machine.

## Trusted URLs

To ensure secure access to Automation 360 online services for On-Premises deployments, add the service-specific URL to the safe recipients or trusted list.

[Add service URLs to trusted list for On-Premises on page 1322.](#)

## Additional requirements

[Configure application Transport Layer Security on page 1249](#)

Use the **Transport Layer Security (TLS) configuration** wizard page from the Automation 360 installer to generate a self-signed certificate or import a security certificate to set up a highly secure Control Room instance.

[Naming guidelines for Control Room URLs on page 1370](#)

When configuring your domain and subdomain Control Room URLs, you must follow the Domain Name System (DNS) guidelines.

See also this article on the Automation Anywhere support site: [Automation 360 On-Premises prerequisites \(A-People login required\)](#).

Related concepts

[Installing Control Room on Microsoft Azure on page 1279](#)

Installing Control Room on Microsoft Azure begins in the Azure environment and ends with configurations in the Control Room.

[Installing Control Room on Amazon Web Services on page 1272](#)

Log in to an Amazon Web Services (AWS) server instance as Administrator. Then, download and start the Control Room installer and select **Custom** mode.

[Installing Control Room using Custom mode on page 1245](#)

Log in to the server as an administrator and install Automation Anywhere Control Room in Custom mode to select installation and configuration options, including installing non-default requirements. Select this mode for a data center deployment.

Related tasks

[Installing Control Room using Express mode on page 1270](#)

[Installing Control Room on Microsoft Windows Server using scripts on page 1308](#)

Silent Control Room installation, also known as unattended installation, uses a customized script for a full setup or an update setup. Silent installation runs the entire installation process in the background, without requiring user interaction or displaying messages.

## Capacity and performance planning

Scale your automation by planning for capacity and performance requirements. To plan your capacity and performance for Control Room On-Premises, review the requirements, limits, and defaults that determine the number of simultaneous bots, user sessions, and processing rates.

Keep in mind concurrency requirements for your automations when you plan capacity.

## Concurrent bot deployments

Concurrent bot deployments refer to bot runs that occur at the same time. Deployments can be from any of the deployment models, such as schedules, run bot now, WLM, trigger, Automation Co-Pilot for Business Users, or API.

Bots can be deployed in the following ways:

- Same bot deployed on multiple devices
- Different bots deployed on different devices
- Multiple bots deployed on the same device (depending on the configuration at the device level in a scenario where a multi-user device used is used)

## Concurrent users

Concurrent users refer to multiple Control Room users using the same device simultaneously. These users can perform the same tasks or different tasks. The users can be either Bot Creators or attended or unattended Bot Runners.

## Concurrent schedules

Concurrent schedules refer to one or more schedules planned for the next deployment at the same time. These schedules are triggered to deploy bots on different machines but at the same time.

Review capacity planning based on your requirements.

- [Attended automation capacity planning](#) on page 1183
- [Unattended automation capacity planning](#) on page 1185

## Attended automation capacity planning

To plan capacity and performance for your Control Room On-Premises, review an example use case to understand the requirements, limits, and defaults that determine the number of simultaneous (concurrent) bots, user sessions, and processing rates.

## Overview

Attended automation is a collaboration between humans and bots. Attended automations are run on devices that have users logged in and interacting with the automations and applications that are active and running on their desktop. The devices can be physical, virtual, single user, or multi-user devices.

Attended automations are initiated and concluded in a single user session. Only one active automation can run at a time. Attended automations usually require human intervention to finish automations, by either inputting data into forms or performing data verification.

For more information, see [Attended and unattended automation](#) on page 3291 | [Using Automation Co-Pilot for Business Users on desktop](#) on page 3360.

## Example scenario

Let us understand the scaling of automation with the help of an example scenario. Consider an insurance company that is looking to automate some of its repetitive business processes and improve efficiency. For this example, we will consider claims processing.

The following image illustrates this example scenario.

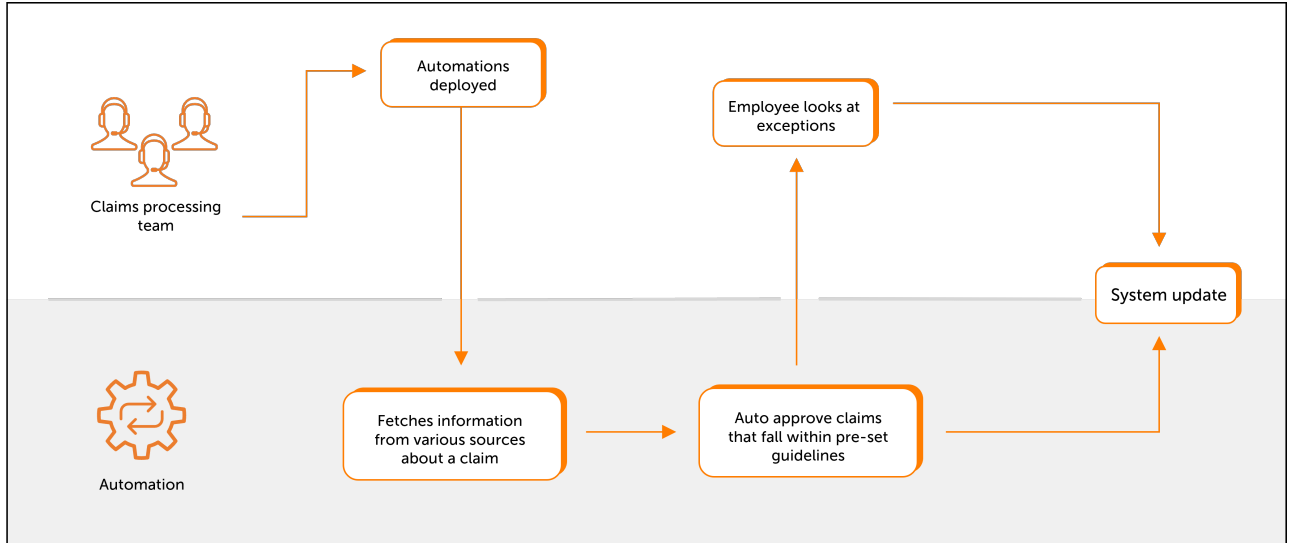

Company name

Acme Insurance

Contact center use case

Claims processing

Concurrent users

1000 agents

Shifts

3 shifts of 8 hours duration

Contact center production environment

- Users are assigned attended Bot Runner licenses
- Agents use Automation Co-Pilot to access automations
- Agents trigger automation deployment
- Agents pause, stop, and resume automations
- Agents access and control queued automations

Daily operations

- The contact center receives a high volume of incoming calls from policyholders reporting insurance claims. These claims can range from automotive accidents to property damage, and the contact center agents handle the initial intake process.
- 1000 agents log in and access the Control Room at the same time.
- The agents run automations on their local devices where user interaction is required.
- User authentication is the first step. Once they have authenticated, agents can access automations available to them.
- When a policyholder calls in to report a claim, the agents go through the automated claims processing workflow, following a step-by-step process with prompts for required actions.



- Agents access automations available to them and run automations to perform their tasks.
- When an automation is complete, agents either move on to next automation or rerun the same automation depending on the next assigned call, activity, or ticket.
- This process continues with the agents running a set of automations repeatedly to address customer cases.

Based on the number of concurrent users, review the infrastructure recommendations for your automation requirements in Acme insurance company.

Maximum number of concurrent users	Number of nodes	Configuration	Database server specifications (minimum)
100	Single node	16 CPUs 32-GB RAM	8 CPUs and 16-GB RAM with SSD hard drive. For example, AWS instance type m5d.2xlarge.
750	3-node cluster	16 CPUs 32-GB RAM	
1500	5-node cluster	16 CPUs 32-GB RAM	

## Unattended automation capacity planning

Plan your capacity and performance for Control Room On-Premises, understand the requirements, limits, and defaults that determine the number of simultaneous bots, user sessions, and processing rates for unattended automations.

### Overview

Review the information on the maximum number of concurrent bot deployments and executions for On-Premises deployment.

The entity count in the following list provides information only about the maximum number of entities that the Control Room can support irrespective of the machine resources. Deploying additional machine resources does not increase the entity count.

Control Room supports either of the following, for maximum number of concurrent bot deployments and executions:

- 1000 concurrent bot deployments and executions on Bot Runner sessions (typically in a production Control Room)
- 700 concurrent bot deployments and executions on Bot Creator sessions (typically in a development Control Room)

Entity Type	Count
Users	10,000*
Roles	5000*

Entity Type	Count
Schedules	1500
Audit entries	10,000,000*
Lockers	100
Credentials	5000
Repository files (Including all file types in the Control Room <b>Public</b> workspace)	25,000*
<p><b>Note:</b> Repository files include dependent files that you check in to the <b>Public</b> workspace (visible on the UI) such as Task Bots, .atmx, .dll, .txt, .csv, and so on, and the related files from the database (not visible on the UI). For example, .png files generated after an automation is recorded are stored in the database and are included in the repository files.</p>	
Repository folders	9000*
<p><b>Note:</b> Applies to the public workspace.</p>	
Queues	30
Device pools	10
Work Items	30 million

\* Applicable from Automation 360 v.21 and later.

## Concurrent bot deployments and executions

Control Room supports up to 1000 concurrent bot deployments and executions across the Control Room cluster. These 1000 bots can be a combination of the same or different bots.

**Note:** If you use different bots, because of the load, the compiler slows down the execution for the first-time deployment. For subsequent deployments, bot execution process might accelerate.

Control Room edition and configuration	Number of Run as users
One instance of On-Premises	Maximum 1000
Three instances of On-Premises with High Availability (HA) configuration	Maximum 1000

The bot deployment depends on the network quality and the size of data that needs to be transferred from Control Room to Bot Agent.

Therefore, in the above scenario when the network connectivity speed is increased for the three Control Room instances, the network throughput improves, so the completion time will become shorter but the maximum accepted concurrent bot deployments will remain the same.

## Bot concurrent schedules

Scheduling considerations when running bots repeatedly.

When configuring bots to run repeatedly on a schedule it is important to make sure that the time between runs does not drop below the total time for deployment and execution of the bot. Otherwise, sequential executions of the bot might overlap leading to unexpected behavior.

For example if it takes two (2) minutes to run a bot, do not schedule the bot to run every one (1) minute. The previous run cannot complete before the next run begins.

With the reference specification, it is possible to successfully configure concurrent schedules.

Activity	Schedule data
Concurrent schedules	100
<b>Run as</b> user per schedule	10
Total concurrent bots	1000

## Control Room server requirements

The Control Room is deployed on servers in data centers. The minimum hardware requirements for Control Room include server type, machine type, processor, RAM, disk storage, and network requirements.

---

**Note:** Automation Anywhere does not provide any monitoring functions for repository, such disk space usage, memory, or other alert mechanisms related to repository. There are commercial tools available from other third-party independent software vendors (ISV) who provide such tools.

---

The installation wizard requires the following:

- IP addresses: Identify all the nodes (servers) IP addresses in the data center cluster before installation. You provide these IP addresses during Control Room installation.
- Access hardware: To enable viewing the Automation Anywhere interface, provide:
  - keyboard
  - mouse or other pointing device
  - monitor with 1366 x 768 or higher resolution

---

**Note:** For IQ Bot server requirements, see [IQ Bot hardware and software requirements](#) .

---

Control Room must be installed on a 64-bit, server-level machine, and there can only be one instance of it on the machine. All previous Control Room versions must first be removed from the server machine before you begin the installation.

The following are server requirements for Windows and Linux.

Component server	Processor	RAM	Storage (free disk space)	Network
Control Room Servers	8 core Intel Xeon Processor or equivalent 64-bit Processor with 2.5 GHz plus speed	16 GB	500 GB	1 GbE <ul style="list-style-type: none"> <li>• IPv4</li> <li>• IPv6</li> </ul>

Memory utilization: A Control Room configured with the recommended 16 GB RAM utilizes 80 to 90 percent memory in idle condition and up to 95 percent memory under load, for example, concurrent bot deployments.

**Note:** Ensure that you do not install other applications on the same server where the Control Room is installed.

**Tip:** We recommend that you configure the Control Room network bandwidth to be above 1 GbE for all inter-cluster communication between or among the following:

- Control Room and database
- All Control Room nodes
- Control Room and Elasticsearch nodes
- Control Room and storage systems
- Database nodes for high availability (HA) and disaster recovery (DR) configuration

## Database requirements

View the list of supported databases, database server type, version, hardware, and operating system requirements, and database backup and recovery requirements.

Automation Anywhere installation creates a database to store bot data and metadata for the analytics dashboards.

**Note:** Automation Anywhere does not provide any monitoring functions for database activities, such as disk space usage, memory, or other alert mechanisms related to databases. There are commercial tools available from database vendors and other third-party independent software vendors (ISV) who provide such tools.

For latest updates, see [Microsoft SQL Server Hardware and Software requirements](#).

## Database server hardware requirements

Component server	Processor	RAM	Storage	Network
Database server	4-core Intel Xeon Processor with 2.5 GHz plus speed	8 GB	500 GB	1 GbE

**Note:** If you are hosting the Control Room databases along with other application databases, ensure that the hardware resources are increased proportionately.

## Database server version and operating system requirements

Database type	Database version	Database edition	Installed OS	Supported platforms	Configuration requirement
Microsoft SQL Server database	2019 2017 2016 2014	Enterprise Express Standard Developer (for 2019)	Windows Server 2008 R2 Standard or later Linux CentOS 7.7, 7.9 and 8.3 Red Hat Enterprise Linux 7.7 and 7.9	Amazon Web Services Relational Database Service (RDS)	Installed and configured.  Only option for Express installations.  Enable protocols for Named Pipes and TCP/IP.

Database type	Database version	Database edition	Installed OS	Supported platforms	Configuration requirement
Oracle Server database	Oracle 19c	<ul style="list-style-type: none"> <li>Standard</li> <li>Enterprise</li> </ul>	Windows Server 2012 R2 or later Linux CentOS 7.7, 7.9 and 8.3 Red Hat Enterprise Linux 7.7 and 7.9	Amazon Web Services Relational Database Service (RDS)	Installed and configured with <code>max_string_size</code> parameter set to EXTENDED. Supported only on non-container Database. Available only through an On-Premises custom installation.

- All database versions support all certified operating systems.
- We have certified Amazon RDS for SQL Server and Azure SQL single database for PaaS deployment.

Note that for Azure SQL, CPU or memory requirements are not applicable because it is a scalable and high performance Cloud database built on similar lines with SQL Server and certified for PaaS deployment in Automation 360.

- We recommend hosting the databases on separate hosts to take into account failover scenarios.
- We recommend Enterprise or Standard editions of Microsoft SQL Server database for production use and to ensure business continuity with HA and DR deployments.

You can configure the Express edition of Microsoft SQL Server for Automation 360 testing and proof of concept (POC) purposes based on considerations such as limit on data size, SQL agent unavailability, and DR capabilities.

For more information about scale limits, see [Microsoft SQL Server Express edition scale limits](#).

- Transparent Data Encryption (TDE) is a function of Microsoft SQL Server database. Additional configurations are not required on the Control Room as the TDE supportability is managed by Microsoft. For more information, see [Transparent data encryption \(TDE\)](#) and [Transparent data encryption for SQL Database](#).

## Required database information for Automation Anywhere installation

When you install Automation Anywhere, you are prompted to provide information specific to the database type you are using. The following table summarizes the required information.

Microsoft SQL Server database	
Required information	Description
Database (SQL Server) authentication <hr/> <b>Note:</b> Linux installations use this authentication method <hr/>	Provide credentials for a Microsoft SQL Server user who has permission to connect to the database.  Use only supported characters for the authentication user name and password. See <a href="#">Supported special characters</a> on page 1217. Do not use semicolons ( ; ) in the database password.  Linux example: SQL Database server Login ID: sa SQL Database password: Automation123 sa user authentication is mandatory.
Database names	Database names cannot be blank, have spaces, or include a percent ( % ). Restrict the names to alphanumeric, period ( . ), hyphen ( - ), and underscore ( _ ).  Default name: Automation360-Database
Database port	Default: 1433  Connection to this port is mandatory.
Secure connection (optional) and certificate	Provide a CA certificate. Ensure the certificate host name and database connection are the same.
Service credentials	Provide the user with <code>db_datareader</code> , <code>db_datawriter</code> , and <code>db_ddladmin</code> permissions to create databases during installation.  The preferred method is to use the Domain user account.
Windows authentication	The Windows credentials of the user logged in to the device to connect to the database server.
Database collation	Use the default database collation: <code>SQL_Latin1_General_CP1_CI_AS</code>

For Oracle Server database information, see [Installing Control Room using custom mode for Oracle installation](#) on page 1268.

Before installing Automation 360, ensure that you have configured additional firewall settings, verified the connection to the default port and an SQL query with SA user works as expected.

Related concepts

[Installing Control Room on Amazon Web Services](#) on page 1272

Log in to an Amazon Web Services (AWS) server instance as Administrator. Then, download and start the Control Room installer and select **Custom** mode.

[Installing Control Room on Microsoft Azure](#) on page 1279

Installing Control Room on Microsoft Azure begins in the Azure environment and ends with configurations in the Control Room.

Related tasks

[Installing Control Room on Linux](#) on page 1293

You start installing the Automation Anywhere Control Room in the Linux environment and complete the installation in the Control Room.

[Configure default database port](#) on page 1257

Configure and enable the TCP/IP in the SQL database server to use the default port 1433 when you install the Control Room.

Related reference

[Ports, protocols, and firewall requirements](#) on page 1203

View the default and configurable firewall, port, and protocol requirements for Automation Anywhere deployment. View the default ports and protocols that are required to be allowed on customer's firewall for Automation Anywhere deployment. The default ports that are used for HTTP/HTTPS are configurable.

## Working with SQL Servers

Configure Microsoft SQL Servers before setting up the Control Room database.

### Configuring SQL Server Settings

SQL Server settings can be configured in the SQL Server Configuration Manager.

1. Enable protocols for Named Pipes and TCP/IP in **SQL Server Network Configuration > Protocols for MSSQLSERVER**.
2. Double-click TCP/IP to open the properties window.
3. Input the default or custom port number for `IP11` in the IP Addresses tab of the TCP/IP Properties window.  
The default port number is 1433.
4. Click **OK**.
5. Restart the MSSQLSERVICE for the updates to take effect.

---

**Note:** Ensure the Control Room database uses `SQL_Latin1_General_CP1_CI_AS` as the default database collation.

---

### Database and Services Matrix

See [Database requirements](#) on page 1188 for a list of supported Microsoft SQL Server versions.



Service Credentials	Windows Authentication	SQL Authentication
Local System Account	<ul style="list-style-type: none"> <li>Current logged in user account is used to create: <ul style="list-style-type: none"> <li>Tables</li> </ul> </li> <li>Installer gives db_owner permission to NT AUTHORITY\SYSTEM account.</li> </ul>	SQL User account is used to create: <ul style="list-style-type: none"> <li>Databases</li> <li>Tables</li> </ul>
Domain User Account	<ul style="list-style-type: none"> <li>Current logged in user account is used to create database.</li> <li>Domain user account is used to create tables.</li> <li>Installer gives db_owner permission to domain user account.</li> </ul>	SQL User account is used to create: <ul style="list-style-type: none"> <li>Databases</li> <li>Tables</li> </ul>
Service User Account		For Microsoft Azure installations, the service account user needs to have read/write access to the remote Microsoft Azure repository share path.

Related reference

[Ports, protocols, and firewall requirements](#) on page 1203

View the default and configurable firewall, port, and protocol requirements for Automation Anywhere deployment. View the default ports and protocols that are required to be allowed on customer's firewall for Automation Anywhere deployment. The default ports that are used for HTTP/HTTPS are configurable.

## Working with Azure SQL PaaS

Using PaaS SQL database with Azure requires configuration from the Azure instance.

Configure the Azure instance before you install Automation 360.

1. Log in to your Azure account.
2. Navigate to the **Azure SQL** option.
3. Create a database based on your custom requirements.
4. Enable the firewall option.
5. Add the IP address to safe recipients list for accessing the database.

Install Automation 360 and point the database server to this instance of the SQL database. See [Customize Control Room installation on Microsoft Azure](#) on page 1283.

## Operating system, environment, and platform supported for Control Room

Automation 360 can be hosted on AWS, Microsoft Azure, Google Cloud Platform, IBM, and any public, private, or hybrid cloud service that meets the Control Room and Bot Agent hardware and software requirements.

Automation 360 is currently certified on AWS, Google Cloud Platform, and Microsoft Azure. For Bot Agent operating system and platform compatibility, see the Bot Agent compatibility matrices in [Bot Agent compatibility](#) on page 1332.

Automation 360 supports the 64-bit version of the Microsoft operating system.

---

**Recommendation:** Enable Desktop Experience when using the server or client operating system.

---

**Note:** When you install the Control Room on Microsoft Windows Server 2012 and 2012 R2 Datacenter, a warning message indicating installation prerequisites is displayed. However, you can still proceed with the installation without any issues.

---

**Note:** Before you install the Control Room for On-Premises, ensure that you have installed the Visual C++ Redistributable for Visual Studio 2015 package on the Control Room host machine. For more information about the package, see [Visual C++ Redistributable for Visual Studio 2015](#).

---

The following sections list the environment and deployment types with the release or build number applicable to each supported operating system:

### Microsoft Windows Server 2022 Datacenter

Environment	Deployment type with release and build
Amazon Web Services Elastic Compute Cloud (EC2)	On-Premises: Build 19526 or later
Microsoft Azure VM	On-Premises: Build xxxx (v.31) or later

---

**Note:** Keep in the mind the following about Microsoft Windows Server 2022 Datacenter:

- This version is not certified for the disaster recovery (DR) deployments.
  - If you are using any previous versions of Microsoft Windows Server Datacenter (for example 2012), updating to Microsoft Windows Server Datacenter 2022 is not certified.
- 

### Microsoft Windows Server 2019 Standard and Datacenter

Environment	Deployment type with release and build
Amazon WorkSpaces	Cloud: Build 17542 or later

Environment	Deployment type with release and build
Amazon Web Services Elastic Compute Cloud (EC2)	<ul style="list-style-type: none"> <li>On-Premises: Build 1089 or later</li> <li>Cloud: Build 1082 or later</li> </ul>
Google Compute Engine	On-Premises: Build 7103 (A2019.17) or later
Microsoft Azure VM	<ul style="list-style-type: none"> <li>On-Premises: Build 2079 or later</li> <li>Cloud: Build 2079 or later</li> </ul>

### Microsoft Windows Server 2016 Standard and Datacenter

Microsoft Windows Server 2016 is the minimum recommended operating system.

Environment	Deployment type with release and build
Amazon WorkSpaces	Cloud: Build 17542 or later
Microsoft Azure VM	<ul style="list-style-type: none"> <li>On-Premises: Build 2079 or later</li> <li>Cloud: Build 2079 or later</li> </ul>
Google Compute Engine	On-Premises: Build 7103 (A2019.17) or later
VMware VMs on ESXi 6.x	<ul style="list-style-type: none"> <li>On-Premises: Build 7103 (A2019.17) or later</li> <li>Cloud: Build 2079 or later</li> </ul>

### Microsoft Windows Server 2012 and 2012 R2 Datacenter

Environment	Automation 360 build (version)
Amazon Web Services Elastic Compute Cloud (EC2)	<ul style="list-style-type: none"> <li>On-Premises: Build 4105 (A2019.12) or later</li> <li>Cloud: Build 4111 (A2019.12) or later</li> </ul>
Microsoft Azure VM	<ul style="list-style-type: none"> <li>On-Premises: Build 4105 (A2019.12) or later</li> <li>Cloud: Build 4111 (A2019.12) or later</li> </ul>
Google Compute Engine	On-Premises: Build 7103 (A2019.17) or later

## Microsoft Windows 10

Environment	Deployment type with release and build
Amazon WorkSpaces	Cloud: Build 17542 or later
VMware VMs on ESXi 6.x	<ul style="list-style-type: none"> <li>On-Premises: Build 7103 (A2019.17) or later</li> <li>Cloud: Build 2079 or later</li> </ul>

## Linux CentOS

Environment	Deployment type with release and build
Amazon Web Services Elastic Compute Cloud (EC2)	<p>For Linux CentOS 7.7:</p> <ul style="list-style-type: none"> <li>On-Premises: From Build 2545 or later</li> <li>Cloud: From Build 2545 or later</li> </ul> <p>For Linux CentOS 7.9 and 8.3:</p> <ul style="list-style-type: none"> <li>On-Premises: From Build 9664 or later</li> <li>Cloud: From Build 9664 or later</li> </ul>

## Red Hat Enterprise Linux

Environment	Deployment type with release and build
Amazon Web Services Elastic Compute Cloud (EC2)	<p>For Red Hat Enterprise Linux 7.7:</p> <ul style="list-style-type: none"> <li>On-Premises: From Build 2545 or later</li> <li>Cloud: From Build 2545 or later</li> </ul> <p>For Red Hat Enterprise Linux 7.9:</p> <ul style="list-style-type: none"> <li>On-Premises: From Build 9664 or later</li> <li>Cloud: From Build 9664 or later</li> </ul>

## Amazon Linux 2

Environment	Deployment type with release and build
Amazon Web Services Elastic Compute Cloud (EC2)	Amazon Linux 2

Related reference

[Bot Agent compatibility](#) on page 1332

Before you install the Bot Agent, ensure that you review the compatible Automation 360 builds.

[Control Room server requirements](#) on page 1187

The Control Room is deployed on servers in data centers. The minimum hardware requirements for Control Room include server type, machine type, processor, RAM, disk storage, and network requirements.

## Supported cloud platforms

Review the supported cloud platforms for various Automation 360 features.

Automation 360 feature	Google Cloud Platform	AWS	Microsoft Azure
Control Room	Yes	Yes	Yes
Bot Agent	Yes	Yes	Yes
Bot Insight	Yes	Yes	Yes
IQ Bot	Yes	Yes	Yes
Discovery Bot	Yes	Yes	Yes
AI Sense Recorder	Yes	Yes	Yes

## Credential requirements

Login credentials are required at different stages of Automation 360 deployment and use. Credentials are required for installation and data center servers, access to Automation 360 components, and to run tools in bots.

Access point	Task	Type
Data center servers	Install Control Room.	User on the hosting server: <ul style="list-style-type: none"> <li>Windows - <code>system administrator</code></li> <li>Linux - superuser <code>sudo</code>, <code>root</code></li> </ul>
Data center servers	Manage (run, stop, restart) Control Room.	Administrator and <b>Logon as Service</b> permission for Windows services and the Domain or the VM technical user account.
Bot Agent devices	Install, setup, or update Bot Agent.	Administrator permission on the device.

Access point	Task	Type
Bot Agent devices	Start or stop Bot Agent service.	Administrator permission on the device. Write permission on Bot Agent device system paths: C:\ProgramData C:\Windows\System32\config\systemprofile C:\Users\ <loggedInUser>\AppData\Local\AutomationAnywhere
Local devices	Register device.	Windows login to open a browser and login into the Control Room and register the local device. Administrator permission not required.
Local devices	Download bots to local device. Run new bots or existing (downloaded) bots.	Windows login. Administrator permission not required.
Automation 360 login	Perform specific tasks, such as create a bot or run a bot.	License and role based permissions. Bot Creator and Bot Runner users do not require administrator privileges.
Bot task	Used by bots to perform bot tasks.	Credential Vault stores securely created credentials. Read permission on bot machine system path: C:\Windows\System32\config\systemprofile AppData\Local\AutomationAnywhere
Automation Anywhere Service	Run all Windows services created by Automation 360.	Local system account user or Domain user account The Interactive logon rights should be enabled for the service account.

Access point	Task	Type
Remote Desktop Protocol (RDP) to a Windows machine	Run bots on Bot Creators and unattended Bot Runners if RDP connection exists for the deployed user.	Administrator permission is not required. RDP access for the bot is not required. View the Control Room <b>Activity</b> page.
Remote Desktop Protocol (RDP) to a server OS or a hosted VM	Run bots on Bot Creators and unattended Bot Runners if RDP connection exists for the deployed user.	Administrator permission required. RDP access for the bot is required. For confirmation, view the Control Room <b>Activity</b> page.

Data center server credentials

Data center server credentials for Automation Anywhere hosting servers and integrated product servers are required to deploy Automation 360.

To install and deploy Automation 360 requires that users log in to the hosting servers. These users must have permissions to install and run Automation 360 components on the servers. Permissions levels need to be assigned to the user on selected data center applications and servers.

Automation 360 login

Log in toAutomation 360 requires a username and password. These credentials are linked to the machine you use to access the Automation 360 components. Your credentials are assigned roles that give you permission to perform specific tasks, such as create a bot or run a bot.

Bot task

As an automation expert, Credential Vault provisions you to securely create and store your credentials. This ensures that your credentials can be used in bots without compromising security with safe deployment of tasks. Any authorized user can create credentials.

Windows services

The Windows service credentials include a user name and password. The user specified needs to be:

- A member of the local system administrator group.
- Have permission to manage services, including Automation Anywhere services.

- If you use Windows authentication to connect to the SQL database, ensure you grant the db\_owner permission to the service credential user.

The service credentials are used to create database tables and allow the Control Room processes to access the database and repository.

The service credential choices are:

User role	Bot program folder	Bot data folder	Log folders or files	User type
Install user	<ul style="list-style-type: none"> <li>• Read</li> <li>• Write</li> <li>• Delete</li> </ul>	<ul style="list-style-type: none"> <li>• Read</li> <li>• Write</li> <li>• Delete</li> </ul>	<ul style="list-style-type: none"> <li>• Read</li> <li>• Write</li> <li>• Delete</li> </ul>	<ul style="list-style-type: none"> <li>• Admin</li> <li>• Non-Admin</li> </ul>
Service run user				<ul style="list-style-type: none"> <li>• Local system account</li> <li>• Domain user account</li> </ul>
Bot deployment user				<ul style="list-style-type: none"> <li>• Local system account</li> <li>• Domain user account</li> </ul>

The following are the different user types:

- Admin** A user who has administrator privileges.
- Non-Admin** A user who does not have administrator privileges.
- Local system account** The logged-on user performing the installation (default).
- Domain user account** A user that is not the local system account user.



Reasons and requirements for using a domain account user include:

- Use the Windows domain credentials
- PowerShell script restrictions

Enter credentials valid for running Automation Anywhere services.

Specify a user with permissions to launch PowerShell scripts, who is not a Windows domain user, or database table creation can fail.

[Install Bot Agent and register device](#) on page 1347

## Load balancer requirements

View the load balancer requirements for Automation 360 installation. This includes load balancer minimum requirements, and both TCP and HTTPS layer load balancing requirements.

### Load balancer minimum requirements

As a best practice, ensure the load balancer:

- (Required) Adheres to the Domain Name System (DNS) guidelines when configuring the domain and subdomain URLs in load balancer.  
[Naming guidelines for Control Room URLs](#) on page 1370
- (Required) Supports WebSocket protocol (RFC 6455)
- (Preferred) Uses round-robin host selection and is not configured to use persistent (sticky) sessions.
- (Preferred) Uses the appropriate TLS security layer:
  - TCP (layer 4) load balancing
  - HTTPS (layer 7) load balancing

With a Nginx load balancer, set HTTPS termination at nodes by changing `http://Backend` to `https://Backend`.

- (Preferred) Has idle timeout set to 120 seconds.

The timeout value depends on the process time of various actions in the Control Room such as the time required to check in and check out bots, import bots, and download bot dependencies.

If the idle timeout is less than the Control Room processing time, a browser request can time out. For example, if the configured idle timeout is not sufficient to complete a bot check-in action, you will have to refresh your browser to validate whether the bot check-in action is successful or not.

## Load balancer health check parameters

The load balancer health check parameters depend on various factors such as the type of load balancer used, network latency, and user interface responsiveness within and outside the load balancer.

## TCP (Layer 4) Load Balancing

When TCP is applied at layer 4 with the load balancer, the certificate is installed on every Control Room corresponding to the load balancer URL.

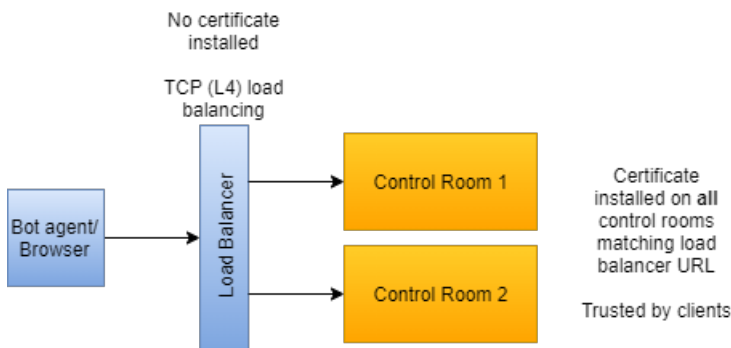

In the image, Control Room components are shown in orange and other components are shown in blue.

Pros	End-to-end encryption without the possibility of intercept at the load balancer.
	Single certificate required.
Cons	If audit logging is required, the load balancer cannot report the requests from clients.
	Does not use TLS hardware offloading, even if the load balancer supports it.

## HTTPS (Layer 7) Load balancing

When HTTPS is applied at layer 7 with the load balancer, the certificate corresponding to the load balancer URL is applied through the load balancer. The Control Room trusts the certificates received from the load balancer.

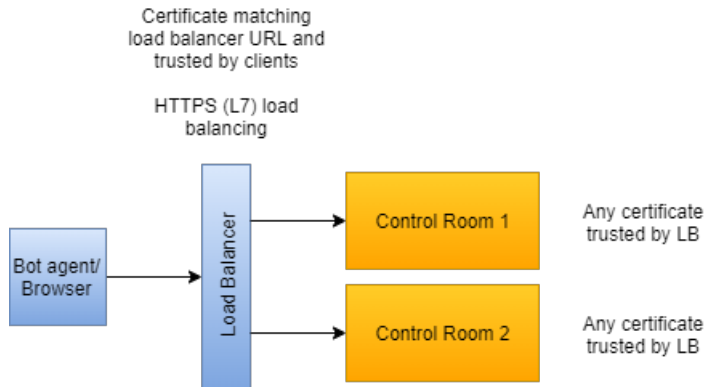

Pros	<p>Allows request logging, when supported by the load balancer.</p> <p>Reduces load from TLS handshake through hardware offloading, when supported by the load balancer.</p>
Cons	<p>Certificates must be managed both on the load balancer and on the control room nodes</p> <p>Possible interception of data at the load balancer hardware level, because TLS session is not end-to-end.</p>

For Automation 360 users on release Build 7560 and later, if SSL offloading is applied at load balancer level for communication between load balancer and application nodes, the `traefik.toml` file in application server needs to be re-configured.

See [SSL offloading for Automation 360 v.18 and later \(A-people login required\) | A360 | Device shows disconnected after registration with Load Balancer URL \(A-People login required\)](#)

## Ports, protocols, and firewall requirements

View the default and configurable firewall, port, and protocol requirements for Automation Anywhere deployment. View the default ports and protocols that are required to be allowed on customer's firewall for Automation Anywhere deployment. The default ports that are used for HTTP/HTTPS are configurable.

- Add Automation Anywhere to the Windows Firewall exception list. Follow the steps as directed by Microsoft for your Windows version.
- Allow communication from Automation Anywhere by adding it to the allowed list in firewall. Follow the steps in the firewall documentation of the operating system.
- Configure the firewall rules and add the Control Room URLs to safe recipients list.
- Configure the firewall rules to allow communication on the server or the firewall appliances that are configured in between, or add the Control Room URLs to the safe recipients list in firewall or end device browsers.

Refer to the following tables for lists of required ports and their use.

## Control Room

**Important:** It is critical that communication between the Control Room servers is properly protected. The communication between Control Room servers contain security sensitive information. Therefore, in addition to allowing all the required communication directly between the Control Room cluster servers, you should block all the inbound traffic from hosts except for HTTP/HTTPS ports to communicate with the Control Room servers.

Protocol	Port	Usage	Clients
HTTP	80	HTTP	Web browsers
HTTPS	443	HTTPS and Web Socket	Web browsers
TCP/UDP	1234	ActiveMQ	Automation 360 Services
TCP	5672	Cluster Messaging	Automation 360 Services
TCP	47100 - 47200	Cluster Messaging and Caching	Automation 360 Services
TCP	47500 - 47598	Cluster Messaging and Caching	Automation 360 Services
HTTP	47599	OpenSearch	Automation 360 Services
TCP	47600	OpenSearch	Automation 360 Services
HTTP	4567	Control Room	Automation 360 Services
HTTP	4569 - 4571	Automation Co-Pilot for Business Users	Automation 360 Services
TCP	5800 - 5900	Automation Co-Pilot for Business Users	Automation 360 Services

### Internal ports for localhost services

Note that the following internal ports are used for Automation 360 localhost services:

Port	Protocol
4567 - 4571	HTTPS REST
5678 - 5708	gRPC

### Data center ports and protocols for Automation 360

Configure each of the data center components that are required for Control Room integration.

**Note:** If you have not configured integration, you can choose to close port 443 for inbound connection on the Bot Agent side without impacting the bot execution.

In the image below, Control Room components are shown in orange and data center components provided by your organization are shown in blue.

**Note:** The arrows in the image indicates the combination of communicating hosts and does not indicate the direction of the establishing the

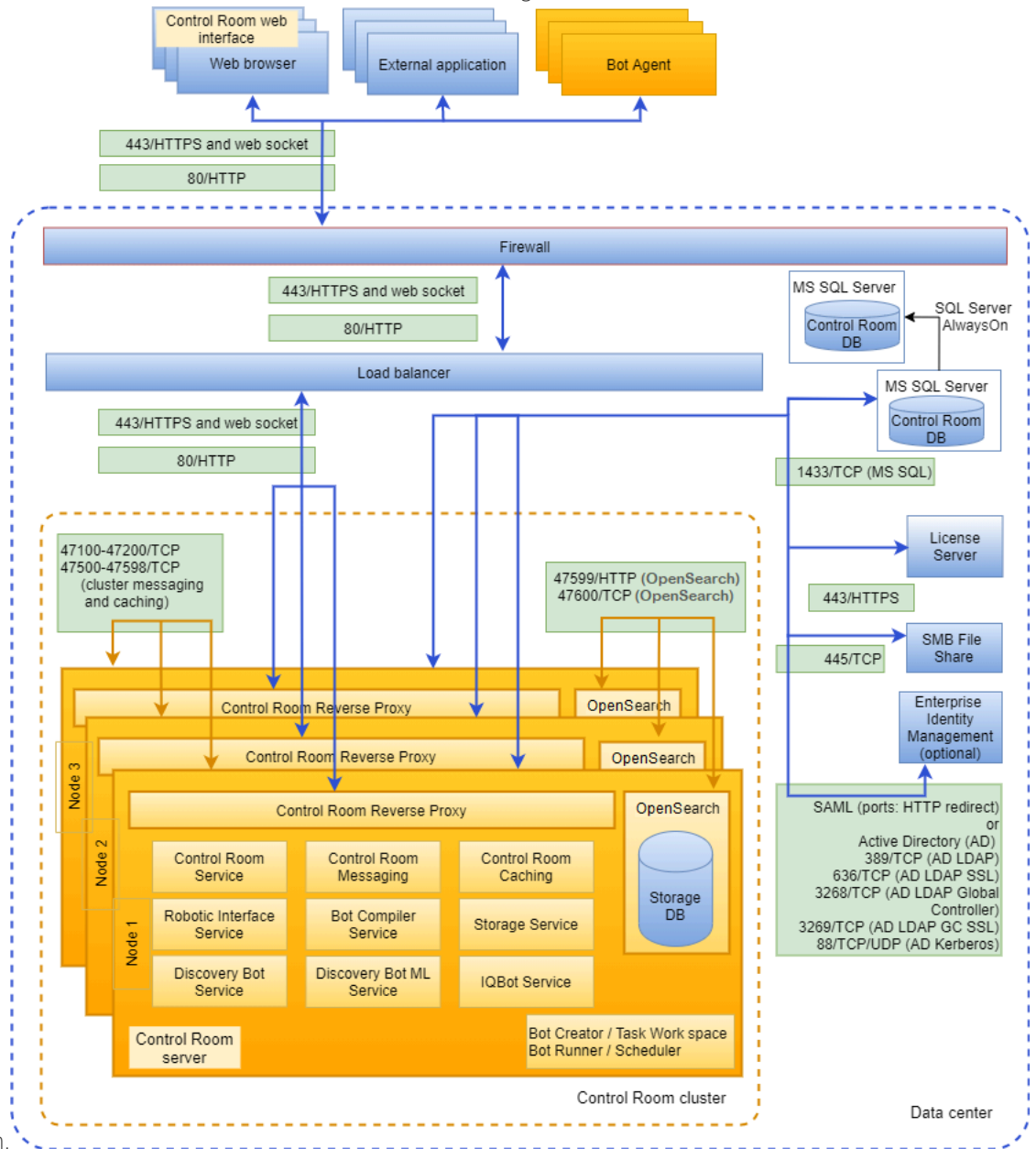

connection.

**Note:** Starting from Automation 360 v.28 release (Build 17593), the Elasticsearch service is replaced with OpenSearch service as the underlying technology for core product capabilities such as audit, Bot Insight, and so on.

Default ports are listed for illustration purposes. Some ports can have alternative port numbers specified during Control Room installation. Some port numbers can be modified after Control Room installation. Active Directory ports are listed as an example of an enterprise identity management.

After the HTTP/HTTPS connection is established between the Control Room and Bot Agent, the communication will be sent using the WebSocket.

All three objects, the web browser, Bot Agent, and external applications communicate directly with the Control Room. A user logs into the Control Room through a browser, to do tasks, such as creating users, or bot related tasks, such as creating, deploying, and scheduling bots. Bot Agent establishes a connection with the Control Room on registration and keeps it alive in order to receive bot deployments from the Control Room. External applications talk to the Control Room directly through the Control Room APIs to perform tasks such as creating users or running bots.

Connection from	Connection to	Protocol	Port	Usage
Bot Agent	Load balancer or firewall, or both	HTTP and WebSocket	80 (TCP) Default	HTTP and WebSocket
Bot Agent	Load balancer or firewall, or both	HTTP and WebSocket	443 (TCP)	HTTP and WebSocket
Web Browser	Load balancer or firewall, or both	HTTP and WebSocket	80 (TCP)	HTTP and WebSocket
Web Browser	Load balancer or firewall, or both	HTTP and WebSocket	443 (TCP)	HTTP and WebSocket
Control Room services	Enterprise identity management (for example, Active Directory)	LDAP	389 (TCP)	User authentication
		LDAP SSL	636 (TCP)	User authentication
		LDAP global controller	3268 (TCP)	User authentication
		LDAP global controller SSL	3269 (TCP)	User authentication
		Kerberos	88 (TCP and UDP)	User authentication
Control Room services	File share with Microsoft Server Message Block (SMB)	SMB 2.0 or SMB 3.0	445 (TCP)	Repository file share access
Control Room services	Microsoft SQL database server	SQL	1433 (TCP) Configurable	Database access

## Microsoft Azure supported data center elements

Data center object	Supported version	Configuration
Control Room operating system	<ul style="list-style-type: none"> <li>Microsoft Windows Server 2012 and 2012 R2 Datacenter</li> <li>Microsoft Windows Server 2016 Standard and Datacenter</li> <li>Microsoft Windows Server 2019 Standard and Datacenter</li> </ul>	IaaS
Identity management: Azure	Azure Active Directory	<ul style="list-style-type: none"> <li>IDaaS</li> <li>Windows 2016 for IaaS</li> </ul>
	Azure File Share with Server Message Block 2.0 and 3.0 (SMB) protocol	PaaS
	Azure Load Balancer (Not Application Gateway)	PaaS
	Azure SQL Database with single database (Microsoft SQL Azure (RTM) - 12.0.2000.8)	PaaS

## Microsoft Azure security policy recommended ports

Data center object	Port	Protocol
Control Room	<ul style="list-style-type: none"> <li>80</li> <li>443</li> </ul>	HTTP/HTTPS
LDAP	<ul style="list-style-type: none"> <li>3268</li> <li>3269</li> </ul>	TCP (LDAPS - Secure TCP)
email SMTP	587	SMTP
SSH	22	TCP
RDP	3389	TCP

## Google Cloud Platform security policy recommended ports

Data center object	Port	Protocol
Load balancer	<ul style="list-style-type: none"> <li>80</li> <li>443</li> </ul>	<ul style="list-style-type: none"> <li>HTTP</li> <li>HTTPS</li> </ul>
Firewall	<ul style="list-style-type: none"> <li>80</li> <li>443</li> <li>1433</li> </ul>	<ul style="list-style-type: none"> <li>HTTP</li> <li>HTTPS</li> <li>TCP</li> </ul>
Microsoft SQL Server database	1433	TCP

### Related tasks

[Prepare for installation on Amazon Web Services](#) on page 1274

Use these steps to prepare the Amazon Web Services (AWS) instances for the Control Room installation.

[Verify readiness for installation on Microsoft Azure](#) on page 1280

Use these steps to configure third-party products for the Control Room installation.

### Related reference

[Automation 360 On-Premises prerequisites](#) on page 1180

Determine whether the system has the required hardware and software to install Control Room for Automation 360 On-Premises.

[Add service URLs to trusted list for Cloud](#) on page 1170

For Cloud deployment, to ensure secure access to Automation 360 online services, add the service URL list to the safe recipients or trusted list.

## Control Room repository requirements

The repository location is configured in the Control Room after installation. All your automations are stored in this repository.

Before you configure the Control Room server repository, review the repository requirements for deploying Automation 360 On-Premises.

- For a single node Control Room deployment, the repository can be a local folder.  
For example, `C:\ProgramData\AutomationAnywhere\Server Files`.
- For a multiple-node Control Room deployment, the repository should be accessible from all Control Room nodes in the cluster over the network.

You can create a file share and access the repository from a local machine. For example, `\<fileserver>\AutomationAnywhere\Server Files`.

The Control Room repository contains server files, such as packages and resource files.



## Microsoft Windows: Control Room repository requirements

Review the following requirements for configuring the repository location of cluster nodes:

- The Control Room uses its service account to connect to the repository, you must have read/write permission to the repository location.
- The repository path must meet the Universal Naming Convention (UNC) requirements.

For details, see [UNC Path](#).

- The repository size depends on the user data.

For details about storage requirements, see [Control Room server requirements](#) on page 1187. For supported file and folder size, see [Capacity and performance planning](#) on page 1182.

For repository migration requirements, contact your Automation Anywhere representative.

- You can configure the repository using Network File System (NFS) protocols, such as Microsoft Windows, Microsoft Azure Files, and Amazon Elastic File System (EFS).
- Network-attached storage (NAS) uses Server Message Block version 3 (SMBv3) for supported platforms: Microsoft Windows, Amazon Web Services, Microsoft Azure, Google Cloud Platform, and Linux.

## Linux: Control Room configuration using the default repository path

- Ensure that the default path exists in the system and use this default path during the Linux installation.

After the installation, you can modify the repository path or copy files from one directory to another. Verify that all copied files and folders have the same permissions as before the installation.

- Ensure that permission for the path is `crkernel:controlroom`.
- If there is no permission, add the following permission.

```
sudo chmod -R 775 /opt/automationanywhere/enterprise/appdata
```

- Run the following command to allow users access to the `crkernel:controlroom` path:

```
sudo chown -R crkernel:controlroom /opt/automationanywhere/enterprise/appdata
```

## Linux: Control Room configuration with a user-defined repository path

- Ensure that the default path exists in the system.
- Ensure that permission for the path is `crkernel:controlroom`.
- If there is no permission, add the following permission.

```
sudo chmod -R 775 /CRRepo/AutomationAnywhere
```

- Run the command to allow users access the `crkernel:controlroom` path:

```
sudo chown -R crkernel:controlroom /CRRepo/AutomationAnywhere
```

The `crkernel:controlroom` user is created after the Control Room installation, so set the user permission to a specified repository before performing the final Control Room configuration.

## Browser requirements for Automation Workspace

Access the Automation Workspace interface from a browser. After you have installed and enabled extensions in the browser, perform several tasks through the Automation Workspace interface based on your user role and automation requirements.

### Important:

As of Automation 360 v.25 release in June 2022, Microsoft Internet Explorer 11 reached end-of-life (EOL) and Control Room is no longer supported on the browser.

The impact on your automation depends on the operating system that is currently used for your bot deployments. See the following table for details.

Microsoft operating system	Automation 360
Windows 10 Semi-Annual Channel	Upgrade bots to use one of the other compatible browsers. <a href="#">Supported browsers</a>
All other supported operating systems <a href="#">Bot Agent compatibility</a> on page 1332	No action required.

For more information, see [Microsoft Internet Explorer 11 EOL FAQ](#) on page 1100.

## Supported browsers

You can use a browser to perform a range of tasks from automation creation to automation management, such as the following:

- Control Room activities, such as creating users and roles, managing devices, configuring settings, creating and deploying bots, and maintaining audit logs.
- User activities, such as Bot Agent installation and device registration.
- Automation Co-Pilot for Business Users activities, such as creating users and roles and creating a human and bot tasks in the process editor.

Browser support for Control Room and Bot Agent and Automation Co-Pilot for Business Users

The following table shows supported browsers for Control Room activities, Bot Agent installation, Automation Co-Pilot for Business Users, and device registration:

Activity	Google Chrome (version 57 or later)	Internet Explorer (version 11)	Microsoft Edge based on Chromium (version 93.0.96 or later)	Mozilla Firefox (version 80 or later)	Safari (version 15.3 or later)
Control Room activities	Yes	No	Yes	No	No
Bot Agent installation and device registration	Yes <sup>1</sup>	No	Yes <sup>3</sup>	Yes	No
Automation Anywhere remote agent for Citrix	Yes <sup>2</sup>	Yes	No	No	No
Automation Anywhere Co-Pilot for Business Users	Yes	No	Yes	No	Yes
Bot Insight	Yes	No	Yes	Yes	No

1. If you have trouble registering your device from a browser, run the Bot Agent diagnostic utility.  
For details, see [Perform Bot Agent diagnostic checks](#) on page 1364
2. Automation Anywhere remote agent for Citrix supports Google Chrome (XenApp) automation with Automation Anywhere extension (version 11.2.0.0).  
[Chrome web store](#)
3. If you are using Microsoft Edge based on Chromium to register your Bot Agent and your device is unable to connect to the

Control Room due to proxy settings, add the authentication details.

Browser support for recording automation

The following table shows supported browsers for recording automation:

Activity	Google Chrome (version 57 or later)	Internet Explorer (version 11)	Microsoft Edge based on Chromium (version 79 or later)	Mozilla Firefox (version 80 or later)	Microsoft Edge (Chromium) with Internet Explorer compatibility (version 93.0.961.52 or later)
Record automation	Yes <sup>1</sup>	Yes	Yes	Yes	Yes <sup>2</sup>
	<ul style="list-style-type: none"> <li>Extensions must be enabled for recording.</li> <li>Supported from v.10.</li> </ul>	<ul style="list-style-type: none"> <li>Extensions must be enabled for recording.</li> <li>Supported from A2019.06.</li> </ul>	<ul style="list-style-type: none"> <li>Extensions must be enabled for recording.</li> <li>Supported from v.17.</li> </ul>	<ul style="list-style-type: none"> <li>Extensions must be enabled for recording.</li> <li>Supported from v.19.</li> </ul>	<ul style="list-style-type: none"> <li>Internet Explorer with compatibility mode must be enabled for recording.</li> <li>Supported from Automation 360 v.23.</li> </ul>

- Record automation refers to opening a target application for recording in a supported browser, and recording actions or capturing objects using the Automation Anywhere recorders.
  - For details on automation using Universal Recorder and Recorder capture action, see [Universal Recorder for object-based automation](#) on page 2239 | [Edit a task recorded with the Universal Recorder](#) on page 2242
  - If you have trouble recording automation using Google Chrome, see [Google Chrome extension troubleshooting](#) on page 2251

2. Microsoft Edge (Chromium) with Internet Explorer compatibility mode is supported for capturing objects from web applications based on HTML technology.

## Extensions for automation

When you install the Bot Agent from a browser, extensions for Automation 360 are installed. Extensions are required to record automation using a supported browser.

You can enable extensions on a device from supported browsers. For example, after you install a Bot Agent from a Google Chrome browser, click the enable extension option from the browser task bar. The Google Chrome extension will allow you to record automation using the Google Chrome browser.

When you connect your Bot Agent device to the Control Room, you can enable the following extensions from your browser to record automation:

Extension name	Link to extension
Google Chrome	<a href="#">Automation 360 extension for Chrome</a>
Microsoft Edge based on Chromium	<a href="#">Automation 360 extension for Microsoft Edge</a>
Mozilla Firefox	<a href="#">Automation 360 extension for Mozilla Firefox</a>

For updates to latest extension version, see [Browser extensions for Automation 360](#) on page 985

### Related tasks

[Perform Bot Agent diagnostic checks](#) on page 1364

Use the Bot Agent diagnostic utility for connectivity-related issues between the Bot Runner device and Control Room. The utility helps to diagnose issues either by providing solutions or suggestions to help resolve the issues.

### Related reference

[Universal Recorder supported applications and browsers](#) on page 2248

Use the Universal Recorder to record interactions with objects from the supported technologies.

[Bot Agent compatibility](#) on page 1332

Before you install the Bot Agent, ensure that you review the compatible Automation 360 builds.

[Google Chrome extension troubleshooting](#) on page 2251

If you encounter an error when recording or running a bot that automates tasks in a Google Chrome browser and you have installed Google Chrome, you must perform additional steps to configure your system.

[Browser extensions for Automation 360](#) on page 985

Create automation from supported browsers by using browser extensions. Extensions are periodically updated to support feature enhancements and fixes. Therefore, ensure that you have

the latest versions of extensions for the Google Chrome, Microsoft Edge, and Mozilla Firefox browsers.

## Internationalization, localization, and language support

Automation 360 provides internationalization and localization support for its user interface (UI), automation, and documentation.

Internationalization means that you can automate using supported languages. Localization means the user interfaces are translated to languages supported by Automation Anywhere. Also, these supported languages have been tested and certified to work in that language.

Internationalization	Perform automation in various languages to work with localized operating systems and keyboards.
Encoding format	UTF-8 is the default encoding format for Automation 360.
Product documentation	View the Automation Anywhere documentation in the supported language at <a href="https://docs.automationanywhere.com/">https://docs.automationanywhere.com/</a> . To view information in one of the supported languages, select the language from the drop-down menu at the top-right of the website. The default language is English for any topic that is not available in another language.
Interface	<p>View the user interface for Automation 360 components, including Control Room and IQ Bot, in the supported language.</p> <ul style="list-style-type: none"><li>• Automate applications (web and desktop) with the language UI, text, and controls values (for example, push-button with a language name and combo-box items in language text).</li><li>• Provide the language name to a bot, workflow, and report in Control Room.</li><li>• Provide the language name to bot schedules, automation name and description, role name and description, a user's first and last names, workload pools, and queues.</li><li>• Deploy bots with the language name on Bot Runners.</li><li>• View the language entities (names, description, and so on) across all the pages in Control Room.</li></ul>
Select a language in the user interface	From the Control Room interface, next to the user ID, click the language icon (globe icon) and select a language from the list.

Parts of the Control Room interfaces that are translated do not include the applications or tools that are used within the bots. For example, Microsoft Excel is not translated through the Control Room.

## Automation 360

**Note:** The language setting of the Control Room does not translate language in Bot Insight, due to the difference in applications. For alternative languages in Bot Insight, users should seek translation from either browser language options or an operating system, configured to their language of choice.

Language	Internationalization (operating system and character set)	Localization (user interface)	Product documentation
Arabic	Available	Not available	Not available
Chinese (Simplified)	Available	Not available	Not available
Chinese (Traditional)	Available	Available	Available
Danish	Available	Not available	Not available
Dutch (Netherlands)	Available	Not available	Not available
French	Available	Available	Available
German	Available	Available	Available
Hebrew	Available	Not available	Not available
Hungarian	Available	Not available	Not available
Italian	Available	Not available	Not available
Japanese	Available	Available	Available
Korean	Available	Available	Available
Polish	Available	Not available	Not available
Portuguese (Brazil)	Available	Available	Available
Russian	Available	Not available	Not available
Spanish	Available	Available	Available
Swedish	Available	Not available	Not available
Turkish	Available	Not available	Not available

## Automation 360 IQ Bot

Language	Internationalization (operating system and character set)	Localization (user interface)	Product documentation
Arabic	Available	Not available	Not available
Chinese (Simplified)	Available	Not available	Not available
Chinese (Traditional)	Available	Available	Available
French	Available	Available	Available
German	Available	Available	Available
Italian	Available	Not available	Not available
Japanese	Available	Available	Available
Korean	Available	Available	Available
Portuguese (Brazil)	Available	Available	Available
Russian	Available	Not available	Not available
Spanish	Available	Available	Available

## Components for Control Room and bot actions

Control Room and bots have additional requirements depending upon the Automation 360 deployment model you choose. Some third party applications are installed with Automation 360.

### Control Room supported platforms

View the listed supported platforms and components for Control Room.

Component	Supported Control Room option
Amazon Web Services Elastic Compute Cloud (EC2)	Required to install Control Room platform.
HTML	Required for Microsoft Azure: Use Load Balancer, not Application Gateway.
Java Database Connectivity (JBDC) driver	Required for Oracle Database.
Linux CentOS or Red Hat Enterprise Linux	Python 3.6 required for Build 6463 and later. Install Control Room platform.
Microsoft Active Directory	Required to configure as either IDaaS or IaaS. For IaaS use Windows 2016.
Microsoft Azure	Required to install Control Room platform.



## Third-party components for bot actions

View the listed third party components for the bot actions.

Component	Automation 360 Plug-in	Supported Bot action
ABBYY FineReader Engine version 12.2.27.12		Required for capturing images in the OCR, AISense, and IQ Bot packages.
Citrix Receiver Version 4.4 LTSR or later <hr/> <b>Note:</b> You can also use the Citrix Workspace app. All major releases of Automation 360 starting from v.22 (Build 10526) are certified with the Citrix Workspace.	Automation 360 Citrix remote agent	Prerequisite for bot actions on the Bot Agent installed on Citrix resident apps.
Citrix Virtual Apps version 6.5 or later	Automation 360 Citrix remote agent	Prerequisite for bot actions on business applications hosted on Citrix server resident apps. Supported with Universal Recorder.
IBM WebSEAL		For reverse proxy for Bot Runner.
Microsoft .NET Framework version 4.6.1 or later		For the Recorder package.

## Supported special characters

Use only supported special characters when creating user names and passwords. Supported characters vary depending upon where they are used.

In all of the below listed cases, the standard alphanumeric characters, a-z, A-Z, 0-9 are supported. The special characters allowed or specifically excluded from particular use are typical to standard English keyboards. The maximum number of characters supported is 256.

See the table below to verify the special characters that can be used in names or passwords.

TLS certificate	Do not use at sign ( @ ) in passwords
Wildcards	The asterisk ( * ) is supported.
Windows	Do not use the pipe (   ) or semicolon ( ; ) in user names or passwords.
Worksheet	Do not use the asterisk ( * ), question mark ( ? ), or bracket left or right ( [ ] ) in the worksheet name.

Database

Do not use percent ( %) or space ( ) in the database name.

Do not use semicolon ( ; ) in the database username or password.

## Supported characters

Characters supported for authentication are acceptable for both user names and passwords. In the table:

- Supported means the character is explicitly supported for that use.
- Do not use means the character is explicitly not supported for that use.
- Double dash (--) means results with using the character for that use are unknown.

Character	Windows authentication	Control Room authentication	Database name, username, or password	JSON Web Token authentication
ampersand ( & )	Supported	Supported	--	Supported
angle bracket, left or right ( < > )	Supported	--	--	--
apostrophe, straight single ( ' )	Supported	--	--	--
asterisk ( * )	Supported	--	--	--
at sign ( @ )	Supported	Supported	--	Supported
braces left or right ( { } )	Supported	--	--	--
bracket left or right ( [ ] )	Supported	--	--	--
caret ( ^ )	Supported	--	--	--
colon ( : )	Supported	--	--	--
dollar sign ( \$ )	Supported	Supported	--	Supported
equal sign ( = )	Supported	--	--	--
exclamation point ( ! )	Supported	Supported	--	Supported
hyphen ( - )	Supported	Supported	Supported	Supported
parenthesis, left or right ( ( ) )	Supported	--	--	--
percent ( % )	Supported	Supported	Do not use	Supported
period ( . )	Supported	Supported	Supported	Supported

Character	Windows authentication	Control Room authentication	Database name, username, or password	JSON Web Token authentication
pipe (   )	Do not use	--	--	--
plus sign ( + )	Supported	--	--	--
number sign ( # )	Supported	Supported	--	Supported
question mark ( ? )	Supported	--	--	--
semicolon ( ; )	Do not use	--	Do not use	--
slash, forward or backward ( / \ )	Supported	--	--	--
space	Supported	--	Do not use	--
underscore ( _ )	Supported	Supported	Supported	Supported

## Citrix integration on Cloud

Automation 360 integration with Citrix enables you to create bots that run tasks on remote Citrix Virtual Apps servers.

### Process overview

Ensure the following tasks are completed before you begin automating tasks in a Citrix environment:

Verify the Citrix component version

Following are the various Citrix components and its related versions that are supported for the Automation 360 integration with Citrix.

Citrix component version	Automation Anywhere Plug-in	Automation 360 client or Bot option
Citrix Receiver Version 4.9 LTSR or later	Automation Anywhere Citrix plug-in	For using Citrix server resident apps or installing Automation 360 client.
<p><b>Note:</b> You can also use the Citrix Workspace app. All major releases of Automation 360 starting from v.22 (Build 10526) are certified with the Citrix Workspace.</p>		
Citrix Virtual Apps version 7.15 LTSR		For using Citrix server resident apps.
Citrix XenDesktop Version 7.15 LTSR		For using Citrix server resident apps or installing Automation 360 client.

Verify credentials and licensing

- Ensure you have the credentials to access the Citrix server.

**Note:** We recommend you have different Citrix login credentials for each Bot Runner user.

- Ensure the appropriate Citrix license is available for the Automation Anywhere Enterprise system.

Install components

Specific Citrix and Automation Anywhere components are required on both the local user machine and the Citrix Virtual Apps server.

Local machine

1. Install Citrix Receiver.

2. Install the Bot Agent. This is automatically installed when you register the local machine with the Control Room.

The Bot Agent and Automation Anywhere plug-in for Citrix are installed at the same time if the Citrix Receiver is installed on the local machine.

3. Install the Automation Anywhere plug-in for Citrix.

If the Bot Agent is already installed, the Automation Anywhere plug-in for Citrix is automatically installed when the Universal Recorder is initiated.

Citrix server

1. Install the Automation Anywhere remote agent for Citrix.
2. Register the Automation Anywhere remote agent for Citrix as a Virtual App in the Citrix StoreFront.

Create a bot

1. From the Citrix StoreFront, run the **AARemoteAgent** and the target application.
2. From the Control Room, create the bot, start the **Recorder**, select the target

application, and record your actions on the Citrix server to build your bot.

## Using Citrix architecture with bots

To create and run bots using applications that reside on a Citrix server, see the following resources:

[Using the Recorder on Citrix Virtual Apps servers](#) on page 1222

The **Record: Capture** cloning action requires specific configurations to capture objects from applications available through the Citrix StoreFront on a remote Citrix Virtual Apps server. Ensure the required components are installed on the local machine and the remote Citrix Virtual Apps server.

Related concepts

[Installing Automation Anywhere remote agent on Citrix servers](#) on page 1227

Install the Automation Anywhere remote agent on the Citrix Virtual Apps server where the virtualized applications are installed.

Related tasks

[Using the Recorder on Citrix Virtual Apps servers](#) on page 1222

The **Record: Capture** cloning action requires specific configurations to capture objects from applications available through the Citrix StoreFront on a remote Citrix Virtual Apps server. Ensure the required components are installed on the local machine and the remote Citrix Virtual Apps server.

[Installing the Citrix required components on local machines](#) on page 1225

Install the Automation Anywhere components to enable you to use bots on Citrix Virtual Apps servers. Two components are installed: Bot Agent and Automation Anywhere plug-in for Citrix.

Related reference

[Browser requirements for Automation Workspace](#) on page 1210

Access the Automation Workspace interface from a browser. After you have installed and enabled extensions in the browser, perform several tasks through the Automation Workspace interface based on your user role and automation requirements.

## Using the Recorder on Citrix Virtual Apps servers

The **Record: Capture** cloning action requires specific configurations to capture objects from applications available through the Citrix StoreFront on a remote Citrix Virtual Apps server. Ensure the required components are installed on the local machine and the remote Citrix Virtual Apps server.

Complete the steps listed in the following tasks:

- [Installing the Citrix required components on local machines](#) on page 1225
- [Installing Automation Anywhere remote agent on Citrix servers](#) on page 1227

If you are using Google Chrome for automation, ensure the Automation Anywhere extension (version 11.2.0.0) for Automation Anywhere remote agent for Citrix is installed and enabled. For Automation 360 remote agent, ensure that the Automation Anywhere extension (version 3.0.0.0 or later) is installed and enabled.

## Chrome web store

Create bots with applications running on a remote Citrix Virtual Apps server using the Automation Anywhere remote agent for Citrix.

1. Log in to the Citrix Virtual Apps server StoreFront.

---

**Note:** You can also use the Citrix Workspace app. All major releases of Automation 360 starting from v.22 (Build 10526) are certified with the Citrix Workspace.

---

2. Depending on the Automation 360 release, select and run one of the following remote agents from the **Citrix StoreFront**.

- Select **Citrix server > Citrix StoreFront > AARemoteAgent**.

---

**Note:** **AARemoteAgent** is the Citrix name for the Automation Anywhere remote agent for Citrix.

---

- Select **Citrix server > Citrix StoreFront > A360 Remote agent**.

---

**Note:** **A360 Remote agent** is the Citrix name for the Automation 360 remote agent.

---

3. Run the target application from the Citrix StoreFront.
4. Log in to your registered local machine with the Bot Agent and Citrix Receiver installed.
5. Log in to the Control Room from your registered local machine.
6. Create a new bot or edit an existing bot.
7. Select the auto login feature to log in to a Citrix environment when it is locked or logged off.

---

**Note:** To ensure the auto login works, always log off the Citrix Receiver associated with the Citrix Virtual Apps server before you disconnect.

---

8. Start the **Recorder**.
9. From the **Automation Anywhere Record Application** selection window, select the target application from the drop-down list in the **Window or URL** field, and click **Start recording**.

---

**Note:** The remote application has `\\Remote` label at the end of the application name.

---

10. When the steps to record are completed, click **End recording**.

Related concepts

[Citrix integration on Cloud](#) on page 1219

Automation 360 integration with Citrix enables you to create bots that run tasks on remote Citrix Virtual Apps servers.

[Installing Automation Anywhere remote agent on Citrix servers](#) on page 1227

Install the Automation Anywhere remote agent on the Citrix Virtual Apps server where the virtualized applications are installed.

Related tasks

[Installing the Citrix required components on local machines](#) on page 1225

Install the Automation Anywhere components to enable you to use bots on Citrix Virtual Apps servers. Two components are installed: Bot Agent and Automation Anywhere plug-in for Citrix.

Related reference

[Browser requirements for Automation Workspace](#) on page 1210

Access the Automation Workspace interface from a browser. After you have installed and enabled extensions in the browser, perform several tasks through the Automation Workspace interface based on your user role and automation requirements.

## Using Citrix XenDesktop on Cloud

Install the Bot Agent on a Citrix XenDesktop virtual machine to create or run bots using applications that reside on that Citrix XenDesktop virtual machine.

Ensure the required components are installed on the local Bot Agent machine and the remote Citrix server. The required components are:

On the local machine

Citrix Receiver : Install this on every machine you use to connect to a Citrix server.

---

**Note:** You can also use the Citrix Workspace app. All major releases of Automation 360 starting from v.22 (Build 10526) are certified with the Citrix Workspace.

---

On the Citrix XenDesktop

Bot Agent : Install this on the Citrix XenDesktop virtual desktop.

Log in to the Control Room and launch the recorder. This triggers the Bot Agent installer.

The Citrix XenDesktop is a virtual machine sitting on a remote Citrix server. It contains the applications to be used for the bots.

The following figure shows the process flow when the Bot Agent is installed on a Citrix XenDesktop with the applications on the virtual desktop.



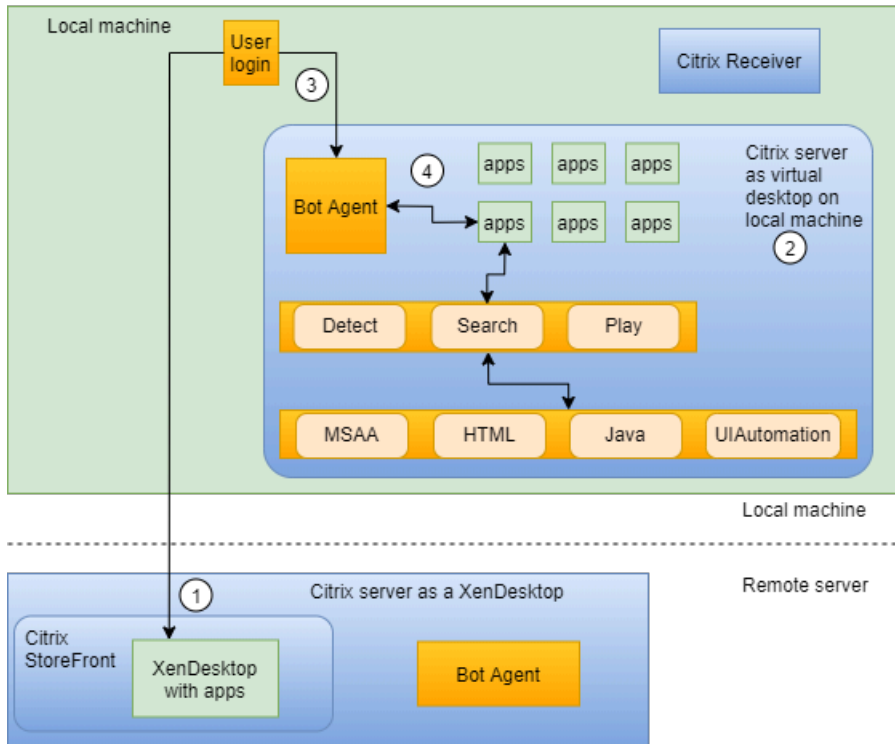

The Bot Agent can be installed on multiple platforms, which includes a Citrix XenDesktop virtual machine. Ensure the virtual desktop meets the requirements for any Bot Agent installation.

Create bots with Citrix XenDesktop.

1. Prepare for bot activities.
  - a) Install the Citrix Receiver on your local machine.
  - b) Install the Bot Agent on Citrix XenDesktop.
2. From your local machine with Citrix Receiver installed, log in and open **Citrix server > Citrix StoreFront**.
3. Select the Citrix XenDesktop virtual desktop with the Bot Agent.  
The whole Citrix XenDesktop is presented as a local virtual desktop on your local machine. This is automatic when you start the Citrix XenDesktop.
4. From the virtual desktop, launch the Enterprise Client that is installed on the Citrix XenDesktop, or launch a browser and log in to the Control Room.
5. From your Control Room, create the bot.

### Installing the Citrix required components on local machines

Install the Automation Anywhere components to enable you to use bots on Citrix Virtual Apps servers. Two components are installed: Bot Agent and Automation Anywhere plug-in for Citrix.

1. Log in to your local machine.
2. Install Citrix Receiver.

**Note:** You can also use the Citrix Workspace app. All major releases of Automation 360 starting from v.22 (Build 10526) are certified with the Citrix Workspace.

This Citrix component is required to communicate from a local machine to a Citrix virtual application server.

To install the Citrix Receiver, see the Citrix documentation.

3. Register your local machine with the Control Room. This installs the Bot Agent. The Bot Agent enables local machine communication with the Control Room.

To install the Bot Agent:

- a) Log in to the Control Room through your Automation Anywhere URL.
- b) Navigate to **Devices** in the **Manage** tab.
- c) From the action icons, click **Add local bot agent**.
- d) Click **Connect to my computer**.
- e) Follow the steps outlined in the wizard.
- f) Refresh the **Devices** page and verify that the local device is added.

4. Install Automation Anywhere plug-in for Citrix on your local machine.

The Automation Anywhere plug-in for Citrix provides the Citrix driver. This driver communicates with the Citrix server.

To install the Automation Anywhere plug-in for Citrix:

- a) Log in to the Control Room.
- b) Launch one of the designated events.  
Designated events include: launch **Recorder**, use the **Devices** tab or **Device Status** tab, or run a bot from **Editor**.
- c) Optional: Verify that the Automation Anywhere plug-in for Citrix is installed.  
Check for the file `C:\Program Files (x86)\Citrix\ICA Client\Automation.CitrixDriver.dll`.

Related concepts

[Citrix integration on Cloud](#) on page 1219

Automation 360 integration with Citrix enables you to create bots that run tasks on remote Citrix Virtual Apps servers.

[Installing Automation Anywhere remote agent on Citrix servers](#) on page 1227

Install the Automation Anywhere remote agent on the Citrix Virtual Apps server where the virtualized applications are installed.

Related tasks

[Using the Recorder on Citrix Virtual Apps servers](#) on page 1222

The **Record: Capture** cloning action requires specific configurations to capture objects from applications available through the Citrix StoreFront on a remote Citrix Virtual Apps server. Ensure

the required components are installed on the local machine and the remote Citrix Virtual Apps server.

## Installing Automation Anywhere remote agent on Citrix servers

Install the Automation Anywhere remote agent on the Citrix Virtual Apps server where the virtualized applications are installed.

Based on the version of the Recorder package that you are using, choose the appropriate remote agent for your environment:

- For bots that use 2.8.6-20220823-160834 version of the Recorder package, install the new Automation Anywhere remote agent for Citrix 2.0 available with Build v 2.0.0.7. For details on installing the Automation Anywhere remote agent for Citrix 2.0, see [Install Automation Anywhere remote agent for Citrix 2.0: Recorder package version 2.8.6](#) on page 1227
- For bots that use 2.7.3-20220527-004608 or earlier version of the Recorder package, install the Automation Anywhere remote agent for Citrix 1.0 available with Build v 1.0.0.0. For details on installing the Automation Anywhere remote agent for Citrix 1.0, see [Install Automation Anywhere remote agent for Citrix 1.0: Recorder package version 2.7.3 and earlier](#) on page 1229

Related concepts

[Citrix integration on Cloud](#) on page 1219

Automation 360 integration with Citrix enables you to create bots that run tasks on remote Citrix Virtual Apps servers.

Related tasks

[Using the Recorder on Citrix Virtual Apps servers](#) on page 1222

The **Record: Capture** cloning action requires specific configurations to capture objects from applications available through the Citrix StoreFront on a remote Citrix Virtual Apps server. Ensure the required components are installed on the local machine and the remote Citrix Virtual Apps server.

[Installing the Citrix required components on local machines](#) on page 1225

Install the Automation Anywhere components to enable you to use bots on Citrix Virtual Apps servers. Two components are installed: Bot Agent and Automation Anywhere plug-in for Citrix.

Related reference

[Components for Control Room and bot actions](#) on page 1216

Control Room and bots have additional requirements depending upon the Automation 360 deployment model you choose. Some third party applications are installed with Automation 360.

Install Automation Anywhere remote agent for Citrix 2.0: Recorder package version 2.8.6

Install the Automation Anywhere remote agent for Citrix 2.0 available with Build v 2.0.0.7 on the Citrix Virtual Apps server where the virtual applications are installed.

Keep the following considerations in mind when automating a task in the Citrix environment using the new Automation Anywhere remote agent for Citrix 2.0:

- If you are using Google Chrome for automation, ensure that the Automation Anywhere extension (version 3.0.0.0 or later) for Automation 360 remote agent is installed and enabled.

[Google Chrome extension for Automation 360](#)

- Both Automation Anywhere remote agent for Citrix 1.0 and 2.0 can run on Citrix environment at the same time.
- When you use the 2.8.6-20220823-160834 or later version of the Recorder package in your bots, we strongly recommend that you use the Automation Anywhere remote agent for Citrix 2.0. If you have not installed the Automation Anywhere remote agent for Citrix 2.0, then we

have support for an automatic fallback where the existing Automation Anywhere remote agent for Citrix 1.0 will be used.

---

**Note:**

- During fallback, the Automation Anywhere remote agent for Citrix 1.0 will work only with technologies and browsers that it supports.
  - Bots created using Recorder package (version 2.8 and later) will work with Manifest V3 extension. For Manifest V3 extensions, ensure that you connect to Automation Anywhere remote agent for Citrix 2.0.
- 
- For Citrix automation, bots created using Recorder package (versions earlier than 2.8.6) will not work with Automation Anywhere remote agent for Citrix 2.0. Ensure that you connect to Automation Anywhere remote agent for Citrix 1.0 instead.
  - If you are using Automation Anywhere remote agent for Citrix 2.0 and the Bot Agent over the same Citrix environment, ensure that you do not uninstall the Automation Anywhere remote agent for Citrix or Bot Agent without reinstalling the updated version of either of these. For example, if you uninstall Automation Anywhere remote agent for Citrix, then ensure that you either install the new version of Automation Anywhere remote agent for Citrix or you reinstall the Bot Agent so that the registry entries remain updated.
  - If you have bots that use 2.7.3-20220527-004608 or earlier version of the Recorder package, then the bots will use the existing Automation Anywhere remote agent for Citrix 1.0.
  - Automation Anywhere remote agent for Citrix 2.0 will not work if Citrix XenDesktop is also connected from the same Bot Creator or Bot Runner device.
  - Technology selection drop-down option for Recorder is not supported.
  - Microsoft UI automation (COM) is not supported.
  - SAP automation is not supported.

The following technologies and browsers are supported with Automation 360 remote agent for Citrix:

- Google Chrome
- Internet Explorer
- Microsoft Edge
- Microsoft Edge with IE mode
- Mozilla Firefox
- Java
- Electron apps
- Microsoft Active Accessibility (MSAA)
- Microsoft UI automation

1. Log in to the Citrix Virtual Apps server.
2. Download the latest version of the Automation Anywhere remote agent for Citrix 2.0 installer file to the Citrix Virtual Apps server. The Automation 360 remote agent running on the Citrix server interprets data received from Automation 360 and responds appropriately.
  - a) Go to [A-People Downloads page \(Login required\)](#).
  - b) Select and download the Automation Anywhere remote agent for Citrix 2.0.
3. Run the Automation Anywhere remote agent for Citrix 2.0 installer.

- a) Extract the AARemoteAgent\_2.0.zip file and double-click the A360RemoteAgent.exe file.
  - b) On the **Automation 360 Remote agent Setup** screen, click **Next**.
  - c) On the **Select Destination Folder** screen, click **Browse** to specify a non-default location for installing the remote agent. Click **Next**.  
The default location for installation is set to C:\Program Files (x86)\Automation Anywhere\A360 Remote Agent.
  - d) On the **Setup Status** screen, track the status of the installation process.
  - e) On the **Setup Wizard Complete** screen, click **Finish** to complete the setup.
4. From the Citrix interface, add the Automation Anywhere remote agent for Citrix 2.0 application to the Citrix **Delivery Controller**.  
This registers the Automation Anywhere remote agent for Citrix 2.0 as a Virtual App in the Citrix StoreFront.
  5. Verify that the Automation Anywhere remote agent for Citrix 2.0 is available from the Citrix StoreFront.  
The Citrix StoreFront name for the Automation Anywhere remote agent for Citrix 2.0 remote agent is **A360 Remote agent**.

Install Automation Anywhere remote agent for Citrix 1.0: Recorder package version 2.7.3 and earlier

Install the Automation Anywhere remote agent for Citrix 1.0 available with Build v 1.0.0.0 on the Citrix Virtual Apps server where the virtualized applications are installed.

Keep the following considerations in mind when automating a task in the Citrix environment using the Automation Anywhere remote agent for Citrix:

- If an application hosted on the Citrix environment runs in elevated mode, the Automation Anywhere remote agent for Citrix must also run in elevated mode.
- If some applications hosted on the Citrix environment run in elevated mode and some on non-elevated mode, you can install two instances of the Automation Anywhere remote agent for Citrix: One instance of the agent will run in elevated mode and the other instance in non-elevated mode.
- If you are using Google Chrome for automation, ensure the Automation Anywhere extension (version 11.2.0.0) for Automation Anywhere remote agent for Citrix is installed and enabled.

[Chrome web store](#)

1. Log in to the Citrix Virtual Apps server.
2. Download the latest version of the Automation Anywhere remote agent for Citrix installer file to the Citrix Virtual Apps server. The Automation Anywhere remote agent for Citrix running on the Citrix server interprets data received from Automation 360 and responds appropriately.
  - a) Go to [A-People Downloads page \(Login required\)](#).
  - b) Select and download the Automation Anywhere remote agent for Citrix.
3. Run the Automation Anywhere remote agent for Citrix installer.
  - a) Extract the AARemoteAgent\_1.0.zip file and double-click the AAE\_Remote\_Agent\_1.0.0.exe file.

- b) On the **Automation Anywhere Remote Agent Setup** screen, click **Next**.
- c) On the **License Agreement** screen, accept the license agreement, and click **Next**.
- d) On the **Select Destination Folder** screen, click **Browse** to specify a non-default location for installing the remote agent. Click **Next**.

The default location for installation is set to: C:\Program Files (X86)\Automation Anywhere\AARemoteAgent

- e) On the **Setup Status** screen, track the status of the installation process.
  - f) On the **Setup Wizard Complete** screen, click **Finish** to complete the setup.
4. From the Citrix interface, add the Automation Anywhere remote agent for Citrix application to the Citrix **Delivery Controller**.  
This registers the Automation Anywhere remote agent for Citrix as a Virtual App in the Citrix StoreFront.
  5. Verify that the Automation Anywhere remote agent for Citrix is available from the Citrix StoreFront.  
The Citrix StoreFront name for the Automation Anywhere remote agent for Citrix is **AARemoteAgent**.

## HA and DR deployment models

Automation 360 provides several deployment options to meet various levels of enterprise cost/price performance and resiliency requirements. The options include installation on single nodes and on multiple nodes. Multi-node deployments can be configured for highly available (HA) clusters and disaster recovery (DR) sites.

The deployment services are set up using the Automation 360 installer. A typical Automation 360 server node runs the following services:

- Automation Anywhere Automation Services
- Automation Anywhere Messaging Services
- Automation Anywhere Caching Services
- Automation Anywhere Search Services
- Repository storage
- (Optional) IQ Bot VM

The Automation 360 installer also supports the multi-node deployment configuration.

## Planning

Identify your requirements before selecting a deployment model. For best results, deploy the same operating systems across the Automation Workspace development, testing, and production environments. At minimum, have the same OS on both test and production environments.

## Deployment models

At a high level, there are two ways to deploy or install Automation 360 - single-node and multi-node. Choose the option that meets your business continuity requirements.

## Single-node deployment

As the name suggests, there is a single physical server node, on which all the services related to Automation 360 are run. By design, this configuration does not provide any redundancy and hence the availability depends on the services on this single node.

Database	<p>In single-node deployment, the database can be anywhere if the Control Room server is able to connect to the database server. This can involve network configurations.</p> <hr/> <p><b>Note:</b> You cannot host the database server on the same server as the Control Room server as it requires higher processing/memory configuration on the server.</p> <hr/>
Characteristics	<ul style="list-style-type: none"><li>• No disaster recovery (single point of failure): If the single node fails, RPA operation will be adversely affected.</li><li>• No high availability: If the server is taken offline for upgrade or maintenance, RPA operations will be affected.</li><li>• No RPA up-scaling: When RPA deployments scale up and users increase, the single node will have to manage the increased load. This might adversely affect the RPA performance.</li></ul>
Usage Recommendations	<p>Single-node deployments are typically recommended for small-scale usage in proof of concepts, demos, testing, and trials, to name a few.</p> <p>Single-node deployments are NOT RECOMMENDED for production usage because any downtime will impair RPA operation and business continuity.</p>
Advantages	<ul style="list-style-type: none"><li>• Quick and easy installation and setup</li><li>• Additional servers not required</li><li>• Load balancers and clustering configuration not required</li></ul>

The following image shows the Automation Anywhere and data center components for a single node. The Automation Anywhere components are shown in orange and components provided by your organization are shown in blue. Components that are centrally hosted on cloud and managed by Automation Anywhere such as license server are shown in light orange.

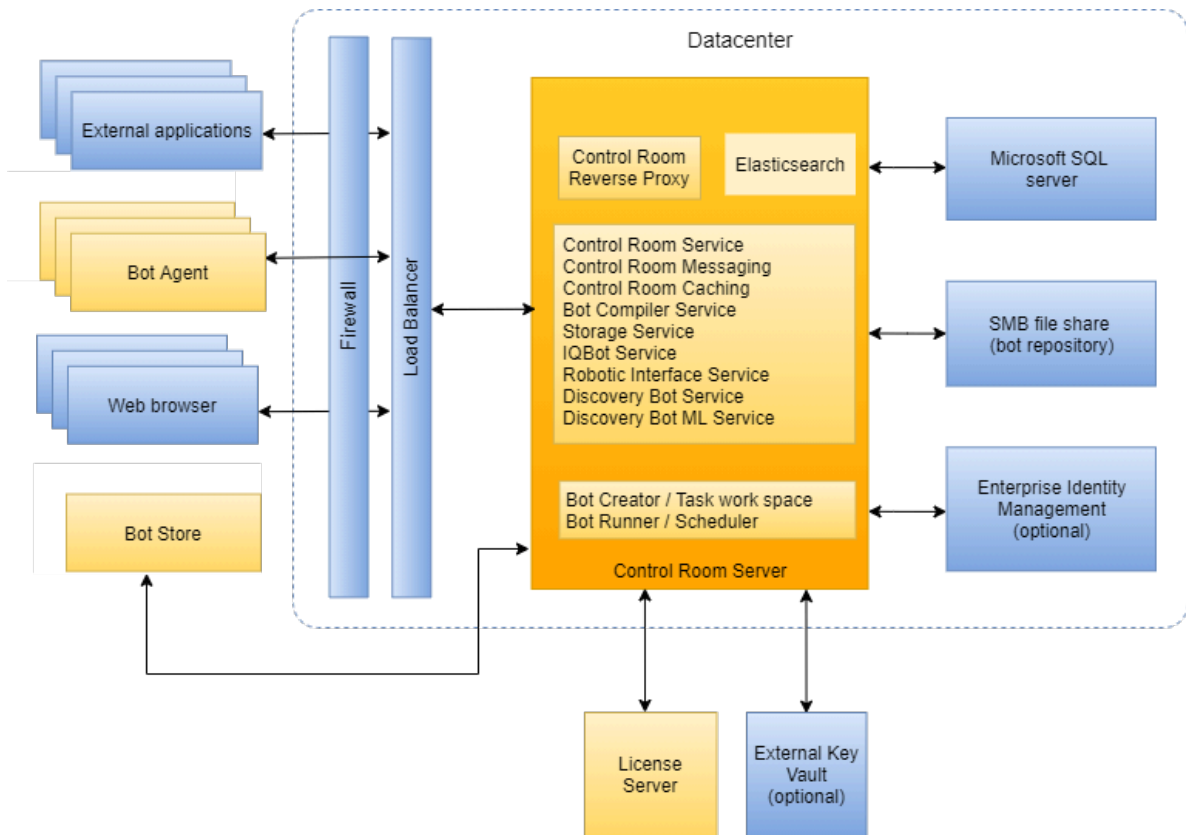

## Multi-node deployment

To achieve higher processing scale, higher availability in production setups, Automation 360 services are deployed across multiple server nodes. Installer enables you to setup multi-mode configuration. This involves additional configuration steps such as linking services to same database and so on.

Distributed approach

The Control Room provides the flexibility to process large number of requests in given time window.

Deploy multiple instances of Control Room on multiple physical or virtual servers as required. This also means configuring the cluster setup for the caching, search, and messaging services.

Load balancing

Performed by a load balancer, this is the process of distributing application or network traffic across multiple servers to protect service activities, allowing workloads to be distributed among multiple servers. This ensures automation activity is continued on clustered servers.

[Load balancer requirements](#) on page 1201



## Databases

In multi-node deployments, databases use their own built-in failover to protect the data. This ensures database data recovery.

If you use cloud-based database services like of AWS-RDS, the High Availability and Disaster Recovery as part of their service offerings, in which case no further database configurations are necessary.

For pure on-premises database scenarios, configure synchronous replication between the primary (active) and secondary (passive) clustered Microsoft SQL Server in the data center. This ensures consistency in the event of a database node failure.

For synchronous replication, configure the database using publisher and subscriber model in Microsoft SQL Server from the primary disaster recovery site to the secondary disaster recovery site that is at a geographically separated location from the primary site.

[Replicate data between primary and secondary sites](#) on page 1244

The following image shows the Automation Anywhere and data center components for three nodes in a data center cluster. The Automation Anywhere components are shown in orange and components provided by your organization are shown in blue. Components that are centrally hosted on cloud and managed by Automation Anywhere such as license server are shown in light orange.

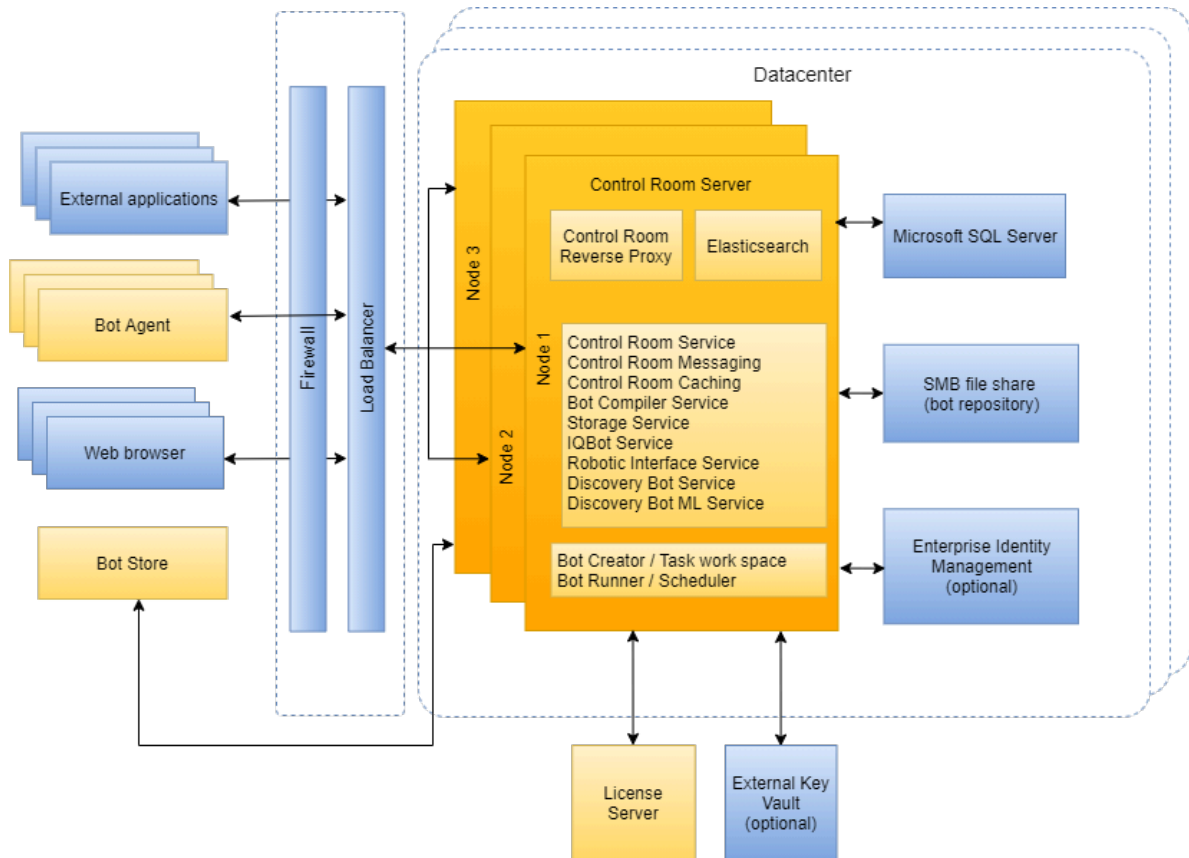

**Important:** Stretch clusters are not supported.

- Ensure that all the HA cluster nodes are configured in the same location. Do not configure the nodes in a single HA cluster that is located across various sites. Ensure that you configure one HA cluster at the primary site and the other HA cluster at the secondary site.
- The Control Room and IQ Bot must be configured in the same data center to ensure communication between both the applications.

Related concepts

[High availability deployment](#) on page 1235

To support Automation 360 in your data center, configure an high availability (HA) cluster. Follow your company methods and procedures for implementing your data center cluster.

## Convert single-node deployment to multi-node deployment

You can convert your single-node deployment into a multi-node deployment by editing the configuration files and restoring the data in the repository for the single-node setup.

The single-node deployment can run on one of several infrastructures, local machines, private data centers, and cloud providers.

To convert a single-node deployment running on AWS or other supported environment into a multi node-deployment, perform the following steps.

1. In the Task Manager, stop all Automation Anywhere services.
2. Stop the Control Room instance.

3. Create an Amazon Machine Images (AMI) instance using the Control Room instance.  
For information about how to create AMI in AWS, see [Create an AMI from an Amazon EC2 Instance](#).
4. Create a new instance using the AMI created in the previous step.
5. Edit the configuration files related to the database server, Ignite cluster, and Elasticsearch to form the clusters in the configuration directory on a standard installation.  
The files are located in `C:\Program Files\Automation Anywhere\Enterprise\config`
  - a) Edit the database server URL to point to the intended database server in `boot.db.properties`.  
Do not change the URL if the original server already refers to a non-localhost address.
  - b) Edit the following property in the `cluster.properties` file:  
Append the list with a new server IP in `ignite.discovery.static.ips=<existing list of ips>, <current server ip>`
  - c) Edit the following properties in the `elasticsearch.yaml` file:
    - Add the current server address in `node.name: "<local-ip>"`
    - Add the current server address in `network.host: "local-ip"`
    - Leave the existing values intact and append the IP of the current server in `discovery.zen.ping.unicast.hosts: ["ip1", "<local-ip>"]`
    - Leave the existing values intact in `cluster.initial_master_nodes: ["<master-ip>"]`
6. Restore and mount the repository to the respective path from the same timed snapshot as the selected Control Room snapshot.
7. Update the configuration tables to ensure TCP visibility between the nodes.
8. Start the services on the replicated node and wait for a couple of minutes for the clustering to establish.
9. Log in to the Control Room to verify whether the bots are available and the repository structure is intact.
10. Check Git integration for standard installations.  
If the installation has external Git configured, check the validity by exercising test check-in and confirm audit logs.

## High availability deployment

To support Automation 360 in your data center, configure an high availability (HA) cluster. Follow your company methods and procedures for implementing your data center cluster.

Why only odd number of nodes are supported	A cluster comprising even number of nodes can merge inconsistencies but can result in a split-brain condition where the cluster has no majority and cannot resolve transactions, which might result in data inconsistencies. Split-brain condition is a known limitation of clustering systems that can be caused by network issues including latency.
--	--

Deployment configurations with odd numbered nodes can help avoid split-brain issues and are recommended for Automation 360 deployments.

Quorum

The nodes determine which transaction can be processed through voting on each transaction. The number of votes constituting a majority of the nodes in the cluster is referred to as a quorum and determines how many nodes have to vote for or confirm a transaction before it can be processed.

Fault Tolerance

Fault tolerance in terms of node failure is determined by how many nodes can fail before a quorum or majority of nodes is not available to vote on the validity of any transaction. Fault tolerance is optimized with an odd number of nodes in the cluster because a majority in odd-numbered clusters is a lower number than in even-numbered clusters

Supported Configurations

A cluster with three or higher odd number of nodes prevents the split-brain condition or inconsistencies due to network issues, while giving the higher scale and availability.

Number of nodes in cluster	Majority (quorum)	Fault tolerance (node failures)	Support
3	2	1	Certified
5	3	2	Contact Automation Anywhere support
7 and so on	4 and so on	3 and so on	Contact Automation Anywhere support

Multi-availability Zone/Multi-datacenter Configurations

When going for a multi-zone deployment in further enhance the availability, say with 3 nodes deployment, we recommend that you have each Control Room in separate availability zones. Deployments with more than 3 nodes, spread these deployments across at least 3 availability zones. One thing we need to be concerned about in these setups is the latency between the zones/providers. The nodes in a high availability cluster must be deployed in the same region.

In terms of the cloud providers, we currently support 3 major cloud providers - Amazon Web Services, Google Cloud Platform, and Microsoft Azure.

---

**Note:** In a multi-node environment, if a node goes down, operations such as bot deployments and schedules, triggers, and work items in queues on that node will be adversely affected.

---

**Tip:** For information on how to backup and restore files to recover a Control Room High Availability cluster in case of failure, see [Backing up and restoring a Control Room High Availability Cluster \(A-People login required\)](#).

---

#### Related concepts

[Disaster recovery deployment](#) on page 1237

The disaster recovery (DR) deployment model uses high availability (HA) clusters distributed across separate geographic areas.

#### Related tasks

[Configure IP cluster](#) on page 1261

Use the **Cluster Configuration** wizard page under **Custom installation type** in Control Room installer to configure resiliency requirements. Select the **Enable Cluster setup** option and for high availability cluster, provide multiple (three or more) IP addresses from your cluster setup.

[Configure disaster recovery site for OpenSearch IP addresses](#) on page 1319

If you have configured the Control Room for high availability (HA) and disaster recovery (DR) and installed the Control Room on both the primary and secondary sites, configure OpenSearch IP addresses for the secondary site.

#### Related information

[Cluster coordination in ElasticSearch](#)

## Disaster recovery deployment

The disaster recovery (DR) deployment model uses high availability (HA) clusters distributed across separate geographic areas.

Disaster recovery (DR) is a method where the two high availability (HA) data center configurations are separated geographically. In the event of a localized disaster at the primary site, the physically removed data center on the secondary site can resume functions with minimum downtime.

If there were external systems used in the setup, it is essential to restore the network level connectivity. Some examples for these external systems include any external key vaults, Git, and so on. All the firewall rules, IP addresses added to trusted list, host-names referred in configurations are still intact and available to the restored services.

---

**Note:** The Control Room clusters in the primary and secondary disaster recovery sites are recommended to use a minimum of three nodes each because a three-node configuration can help avoid split-brain issues with two-node clusters and increase security by using node authentication and transport layer security (TLS) features.

---

The following image shows the Automation Anywhere and data center cluster components for three nodes in primary and secondary sites configured for disaster recovery. The Automation Anywhere components are shown in orange and components provided by your organization are shown in blue. Components that are centrally hosted on cloud and managed by Automation Anywhere such as license server are shown in white.

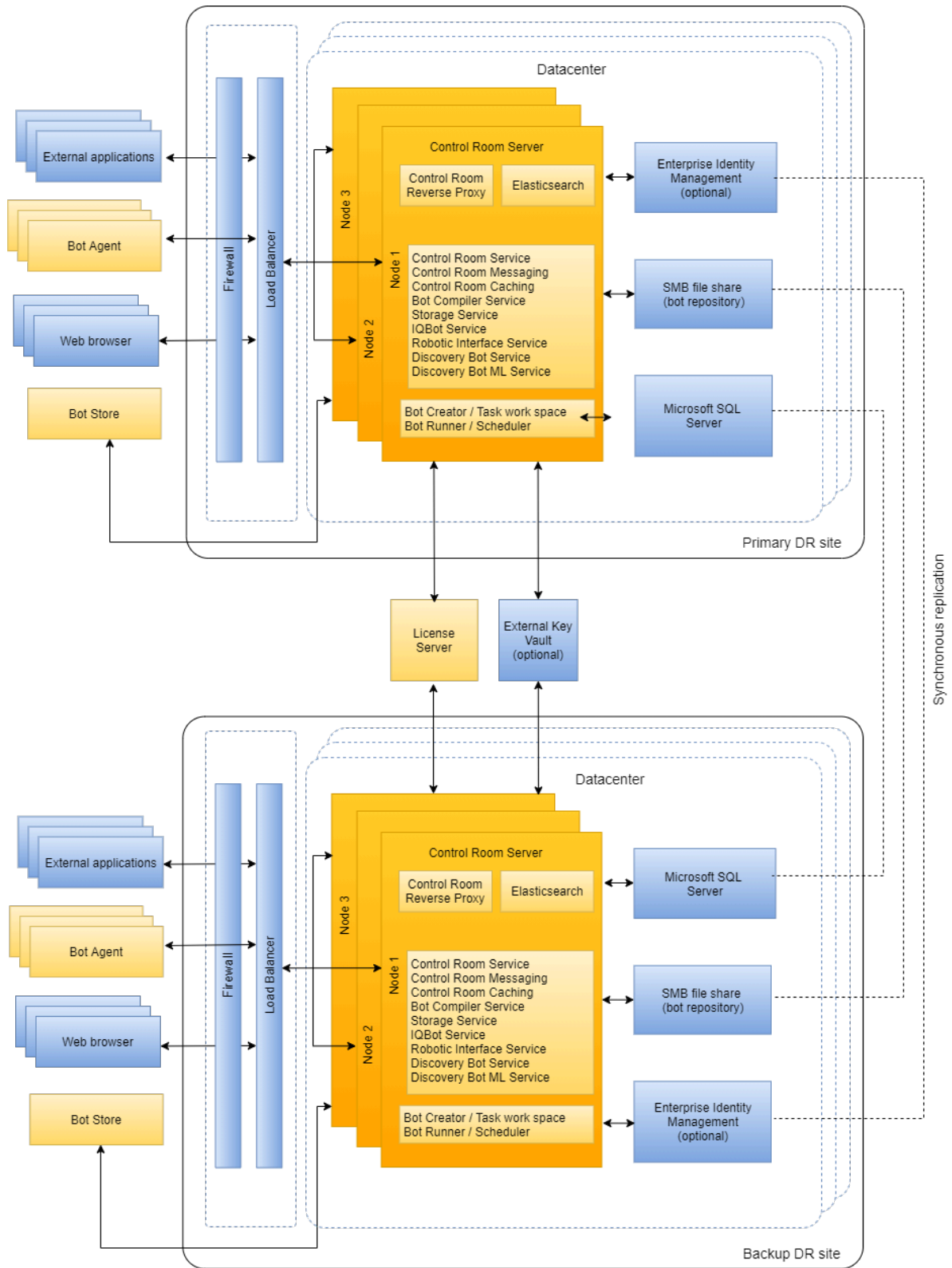

## Disaster recovery methods

There are two ways to perform disaster recovery - Image based replication and Warm standby. Choose the option that meets your business continuity requirements.

Related tasks

[Image based replication](#) on page 1239

The replication process is similar across environments and cloud providers. A scheduled way is used for creating and storing the snapshots. The snapshot interval is based on the tolerance of the customer for potential data loss.

[Replicate data between primary and secondary sites](#) on page 1244

The process of replicating the data between the primary and the secondary site involves database replication using publisher and subscriber models in Microsoft SQL Server Management Studio, server repository replication using Windows Distributed File System (DFS), and backing up Elasticsearch (audit log) data.

Related information

[Cluster coordination in ElasticSearch](#)

Image based replication

The replication process is similar across environments and cloud providers. A scheduled way is used for creating and storing the snapshots. The snapshot interval is based on the tolerance of the customer for potential data loss.

We recommend that the replication schedule should be at least 1 day (one snapshot daily).

The following describes the procedure for AWS as an example cloud provider.

As a first step in any image-based DR setup, create snapshots at fixed intervals. In case of the disaster, the setup would revert to the latest good image/snapshot and system would be back, up and fully functional in a short time, however with a data loss and short down time.

1. Decide on the snapshot interval based on potential data loss.
2. Stop the Automation Anywhere services on the server being imaged.
3. If on AWS, create AMI using standard image creation steps.  
[Create an AMI from an Amazon EC2 Instance](#)
4. After the image is created, start the Automation Anywhere services.
5. Run the repository backup mechanism on the same schedule.

The subsequent steps describe restoring data from an image.

6. Spin a new instance using the previously created AMI.  
Depending on the original setup, if the setup is spread across availability zones, you must do the same in all relevant availability zones.

The following steps are applicable to each instance being recovered.

7. Edit the configuration files related to the database server, Ignite cluster, and Elasticsearch to form the clusters in the configuration directory.

On a standard installation, the files are located in: `C:\Program Files\Automation Anywhere\Enterprise\config`

- a) Edit the database server URL to point to the intended database server in: `boot.db.properties`.  
Do not change the URL if the original server already refers to a non-localhost address.
- b) Edit the following property in the `cluster.properties` file:

Append the list with a new server IP in: `ignite.discovery.static.ips=<existing list of ips>, <current server ip>`

- c) Edit the following properties in the `elasticsearch.yaml` file:
- Add the current server address in: `node.name: "<local-ip>"`
  - Add the current server address in: `network.host: "local-ip"`
  - Leave the existing values intact and append the IP of the current server in: `discovery.zen.ping.unicast.hosts: ["ip1", "<local-ip>"]`
  - Leave the existing values intact in: `cluster.initial_master_nodes: ["<master-ip>"]`
8. Optional: If mounted, restore the repository from the same timed snapshot as the selected Control Room snapshot and mount to the respective path.
  9. Update configuration tables.
  10. Ensure Transmission Control Protocol (TCP) visibility between the nodes.
  11. Start the services on the replicated node and wait for couple of minutes the clustering to establish.
  12. Verify the following:
    - Login and check the bots are listed and visible.
    - If the installation has external Git configured, check the validity using functions such as check-in.
    - Verify the audit logs.
  13. Update the load balancer tier or DNS as needed if any host names/IPs change with corresponding current values.

#### Related tasks

[Replicate data between primary and secondary sites](#) on page 1244

The process of replicating the data between the primary and the secondary site involves database replication using publisher and subscriber models in Microsoft SQL Server Management Studio, server repository replication using Windows Distributed File System (DFS), and backing up Elasticsearch (audit log) data.

[Warm stand-by](#) on page 1240

Host two setups or sites - primary and backup for the warm stand-by DR procedure.

Warm stand-by

Host two setups or sites - primary and backup for the warm stand-by DR procedure.

Each setup would have following recommended configurations:

1. Automation 360 hosted in clustered mode (three nodes)
2. SQL instance
3. Repository storage (shared network drive)
4. Git repository

Synchronous replication of the data onto the backup node should be configured. The backup node should have the exact same configuration as Primary node; except for Control Room.

- To sync Git repository, back up Git repository path from primary to backup path.



- To sync SQL database, setup replication from primary to backup database.  
[Replicate data between primary and secondary sites](#) on page 1244

Once configured the setup scheme would look like this:

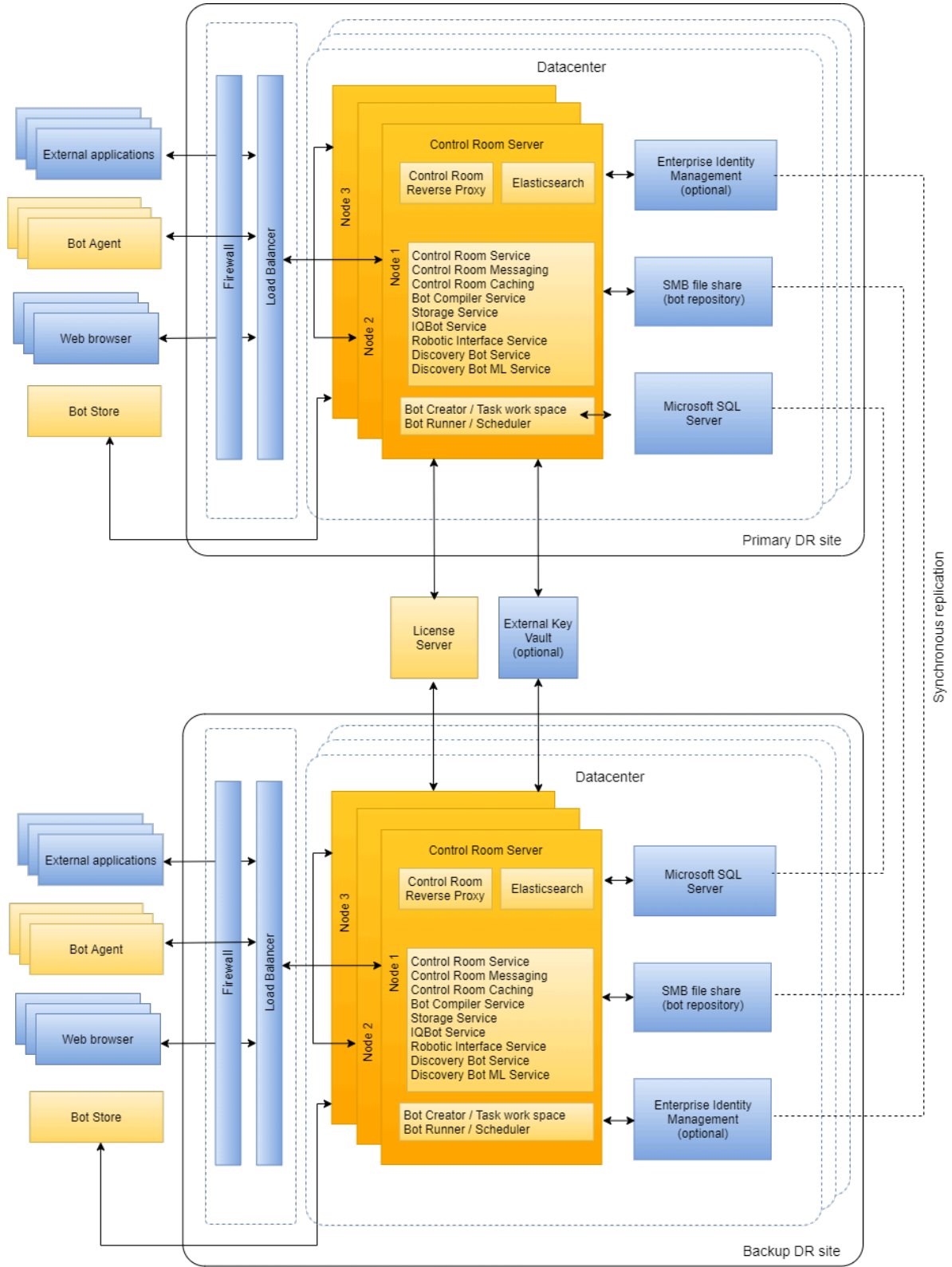

Complete the disaster recovery deployment on the two geographically separated sites, where one site is the primary (active) site and the other is the secondary (passive) site used for backup. If the primary site cluster fails, perform recovery on the secondary site.

---

**Note:** The secondary site should be set up as a passive configuration so that the failover procedure can be performed without delay.

---

The procedure is identical regardless of whether you are switching over from primary to secondary, or from the secondary to primary sites. Connect the Control Room to the replicated database and shared the repository on the secondary site.

These steps apply to all the servers in the Automation 360 cluster, including the Control Room servers, SQL server, and Elasticsearch server.

1. Install Automation 360 on the secondary site.  
Follow the steps for installation up to the database configuration.  
[Installing Control Room using Custom mode](#) on page 1245
2. In the **Database Configuration** window, add database details for the secondary site such as the database server IP address and default port number.  
[Configure Microsoft database type and server](#) on page 1254
3. Verify the Elasticsearch details in the **Provide Elasticsearch Credentials** window.  
Because the Elasticsearch data is already replicated from the primary database, you do not have to provide the Elasticsearch password.
4. After the installation is complete, verify that the Control Room URL and repository path is available in the Control Room **Welcome** page.  
You can change the Control Room URL and repository path after you log in to the Control Room as the next step.
5. Log in to the Control Room using your administrator credentials to change the **Configuration Settings** in **Administration > Settings**:
  - a) To allow users to access the Control Room using a public IP address, change the **Control Room Access URL** settings to point to the secondary site access URL in **General Settings > General**.
  - b) Change the **Repository path** to the secondary site repository path in **Control Room database and software > Control Room repository**.
6. Verify the data for the following:
  - Users, roles, schedule, triggers, credential information, and workload settings
  - Elasticsearch certificate and connectivity
  - Automation Co-Pilot for Business Users, Bot Insight, Discovery Bot, and IQ Bot

---

**Note:** Perform a byte-by-byte measurement of the recovered data and compare the primary and secondary site data. If you see any difference, verify the subscriber logs for any intermittent failure due to any network issue.

---

After the recovery site is operating as the primary site, configure a replacement secondary site. Using the database tools, set up replication from the recovery primary site to the replacement secondary site.

## Replicate data between primary and secondary sites

The process of replicating the data between the primary and the secondary site involves database replication using publisher and subscriber models in Microsoft SQL Server Management Studio, server repository replication using Windows Distributed File System (DFS), and backing up Elasticsearch (audit log) data.

- The DFS requires Automation 360 v.29 or later version.
- Ensure that you have set up your secondary site before installing Automation 360 installer.

Configure the database and shared repository in the secondary site that is used for disaster recovery. Back up your Elasticsearch data by setting up the backup cluster.

1. Replicate the database from the primary site to the secondary site using the publisher and subscriber models in Microsoft SQL Server Management Studio.

---

### Recommendations:

- Use the Microsoft SQL Server Developer or Enterprise edition for database replication.

The publisher and subscriber versions must be the same, or the gap between the two versions must not be more than two releases. For example, do not use Microsoft SQL Server 2012 publisher with Microsoft SQL Server 2019 subscriber.

- Configure the publisher and distributor on the same system to avoid latency in data sharing.

Use different systems only for load distribution, for example, for data larger than 200 GB.

- 
- a) Connect to the primary database to create a snapshot publication for your local publications.
  - b) Add the tables and views as articles.
  - c) Use the snapshot agent option to create a snapshot and keep the snapshot available to initialize subscriptions.
  - d) Schedule the snapshot agent to back up the data at regular intervals (for example, every 10 seconds from 12 AM to 11:59:59 PM).
  - e) To select the account to run the snapshot agent, configure the security and agent settings.
  - f) Add a publication option.
  - g) Run all agent and distributors after ensuring that the publisher and database names are correct.
  - h) To add subscribers to the local subscriptions, connect to the database server and provide connection details for the database at the secondary site.

For detailed steps, see [Database Mirroring and Replication \(SQL Server\)](#).

2. Replicate the repository (bots and data files) using the Windows DFS from the primary site to the secondary site.
  - a) Open the DFS on the machine where the shared repository is saved.
  - b) Create a new multipurpose replication group to add replication group members.

The group members include the source machine in the primary site and the destination machine in the secondary site to store the shared repository.

- c) Use the full mesh option for DFS replication groups composed of less than 10 servers.
- d) Use the full bandwidth option to replicate the data continuously.
- e) Add the machine where you are configuring the repository as a primary member.
- f) Add a backup folder for the shared repository from the destination machine.
- g) Verify that the data is replicated in the backup folder on the destination machine.

For detailed steps, see [Distributed File System Replication](#).

3. Back up the Elasticsearch (audit log) data by adding the secondary site cluster IP address in the Control Room on the primary site.

For detailed steps, see [Configure disaster recovery site for OpenSearch IP addresses](#) on page 1319.

Related tasks

[Warm stand-by](#) on page 1240

Host two setups or sites - primary and backup for the warm stand-by DR procedure.

## Installing Control Room using Custom mode

Log in to the server as an administrator and install Automation Anywhere Control Room in Custom mode to select installation and configuration options, including installing non-default requirements. Select this mode for a data center deployment.

---

**Linux users:** See [Installing Control Room on Linux](#) on page 1293.

---

### Procedure

1. Prepare for installation
  - Verify [Automation 360 On-Premises prerequisites](#) on page 1180.
  - Ensure that you have the following:
    - Automation Anywhere Control Room installation file
    - TLS certificate
    - License file

2. [Run Control Room installer](#) on page 1247

Run the installer to verify the operating system and hardware requirements, select the deployment option, accept the licensing agreement, and select the installation file path.

3. Select the database type that you want to use
  - Microsoft SQL Server
  - Oracle

4. Use the **External key vault integration** page to configure a connection to an external key vault such as CyberArk, HashiCorp, or AWS Secrets Manager, that is optionally used for retrieving credentials for either installation or runtime purposes. Configuring the key vault connection enables retrieval options for credentials during installation. Ensure that you have the follow information:
  - All necessary database and user credentials.
  - Any necessary credential requirements for the external key vault such as secret keys, vault URL, application IDs, server certificate. See the specific requirements for your external key vault on the External Key Vault integration configure page.
5. [Configure application Transport Layer Security](#) on page 1249  
Use the **Transport Layer Security (TLS) configuration** page to generate a self-signed certificate or import a security certificate to set up a highly secure Control Room instance.
6. [Configure service credentials](#) on page 1251  
Use the **Service Credentials** page to specify the account that will be used to run all Windows services that are created by the installer.
7. Configure database type and server  
Use the **Database type** page to configure the Microsoft SQL Server database, or Oracle Database for use with the Control Room.
  - [Configure Microsoft database type and server](#) on page 1254
  - [Configure Oracle database type and server](#) on page 1258
8. [Add OpenSearch credentials](#) on page 1259  
Add Elasticsearch credentials for enhanced monitoring and alerting in the Control Room.
9. [Configure IP cluster](#) on page 1261  
Use the **Cluster Configuration** page to configure resiliency requirements. Provide only one IP address to configure the Control Room on a single node. Provide multiple (three or more) IP addresses to configure the Control Room for high availability cluster.
10. [Review the installation summary](#)  
Use the **Ready to Install the Program** page to complete the installation wizard and monitor the installation progress.
11. Complete Control Room configuration and validation

<a href="#">Complete Control Room post-installation configuration</a> on page 1315	After installing the Control Room, complete the configuration settings to ensure timely Automation Anywhere communications are specified and confirm Automation Anywhere services are running.
<a href="#">Post-installation user management</a> on page 1371	After completing the post-installation tasks, validate the setup by logging in to the Control Room and installing a license. First-time access to the Control Room walks you through the configuration for your authentication method.
12. [Prepare for users](#)

As an administrator, you can create, view, edit, delete, and enable or disable a user. Creating users steps vary depending on whether the user is a non-Active Directory, Active Directory, or single sign-on (SSO) user from an IdP server.

Related concepts

[Migrate to Automation 360](#) on page 1496

Migration (upgrade) is the process of moving your data and bots from Enterprise 11 or Enterprise 10 to Automation 360. Migration includes but is not limited to replicating and updating your existing database and repository, converting your bots to the Automation 360 format, and migrating learning instances for IQ Bot and dashboards for Bot Insight.

## Run Control Room installer

Run the installer to verify the operating system and hardware requirements, select the deployment option, accept the licensing agreement, and select the installation file path.

To install Automation Anywhere Control Room in Custom Mode, follow these steps:

1. Start the installer wizard.
  - a) Extract all files from the Automation360\_Build\_<build-number>.zip file.
  - b) Right-click the Automation360.exe file and select **Run as administrator**.

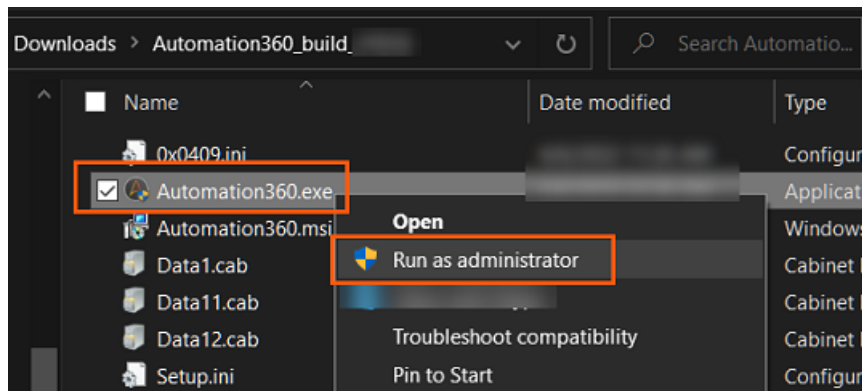

The installation process will create a Control Room database with the name Automation360-Database on your SQL database server instance.

However, if you are migrating from Enterprise 11 to Automation 360, the restored Enterprise 11 database will be used instead of the Automation 360 database.

---

**Note:** Ensure the SQL database server is installed on a different server than that of the Control Room.

---

The installation process checks for supported operating system and recommended hardware requirements. The following message appears if the requirements are not met:

```
This system does not meet all the installation prerequisites for
Automation Anywhere Enterprise.
Some features might not work as expected after installation. For
details, verify the Control Room Installation Prerequisite.
```

For more information, see [Automation 360 On-Premises prerequisites](#) on page 1180.

2. Select the **On-Premises** deployment type and click **Next**.

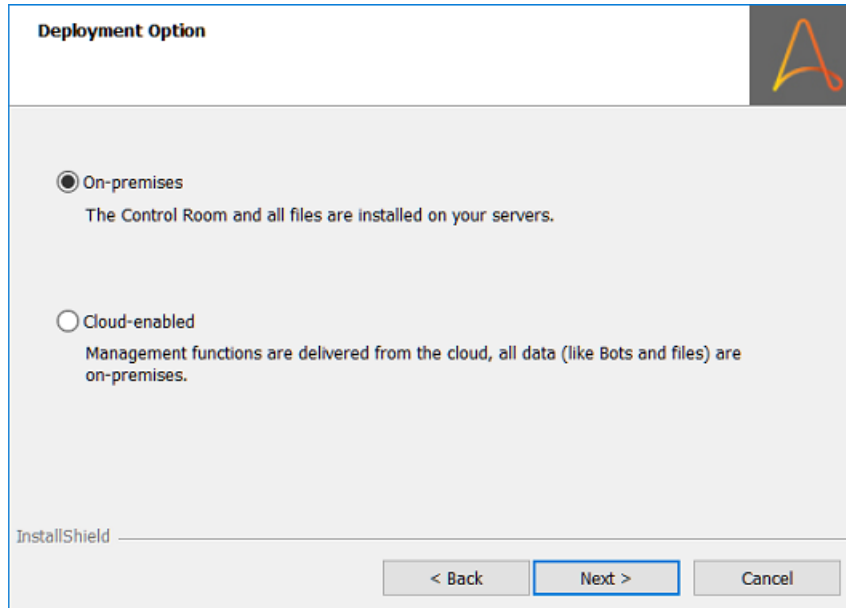

In On-Premises deployment type, the Control Room, Bots and files are installed on your servers.

In **Cloud-enabled** deployment type, all data such as bots and files are installed on your servers. The management functions of the Control Room are delivered through Cloud.

3. Accept the licensing agreement and click **Next**.
4. Select the **Custom** option and click **Next**.

The **Destination Folder** page appears. By default, the destination folder is C:\Program Files\Automation Anywhere\.

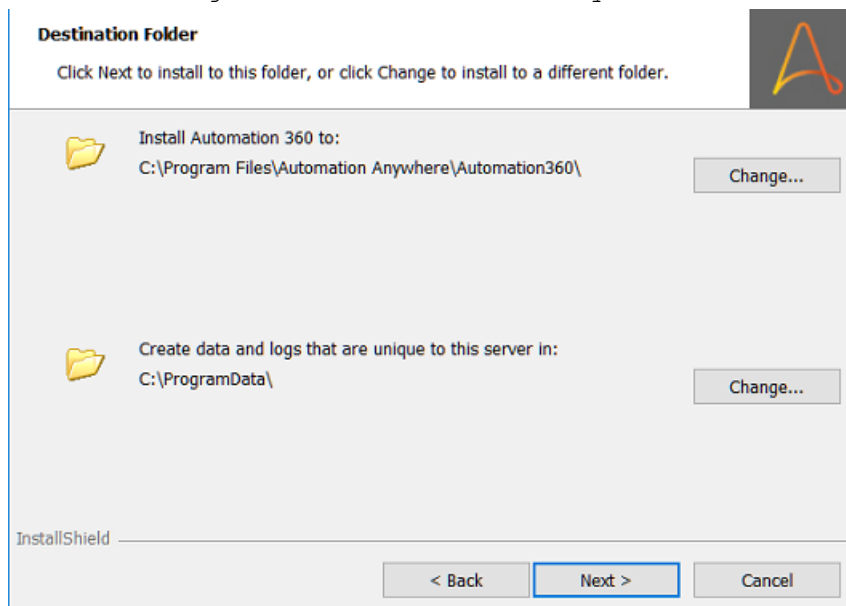

5. If you are upgrading from one Automation 360 version to another, confirm the upgrade and choose whether to use the existing installation parameters.

Existing installation parameters include, for example: the installation path, HTTPS ports, database names, IP addresses, and TLS configuration. The username and password have to be manually entered.



- **Yes**—all the installation parameters are pre-filled and disabled. You cannot change pre-filled fields.
- **No**—enter the same or different installation parameters through the installation prompts.

---

**Note:** Choose **No** if the previous installation did not use the default installation path `C:\Program Files`.

---

6. To make changes to the destination folder, click **Change**, enter a new destination folder name, and click **OK**.

---

**Note:** Do not install the application directly in the root directory (`C:\`). You should create a folder, for example, `C:\Program Files\Automation Anywhere\Automation360\`.

---

7. Click **Next**.

## Integrate external key vaults

You can integrate external key vaults to the Automation 360 On-Premises Control Room.

As part of your external key vault integration planning strategy, if you determined that you are using an Automation 360 On-Premises Control Room deployment (where the Control Room and external key vault are hosted at the customer's site and environment), then select from the following list of external key vaults to configure:

- CyberArk Password Vault – Customer On-Premises environment  
[On-Premises integration using CyberArk Password Vault](#) on page 1936
- Azure Key Vault – Customer Azure environment  
[On-Premises integration using Azure Key Vault](#) on page 1948
- AWS Secrets Manager – Customer AWS environment  
[On-Premises integration using AWS Secrets Manager](#)
- HashiCorp Vault – Customer On-Premises environment  
[On-Premises integration using HashiCorp Vault](#) on page 1984

## Configure application Transport Layer Security

Use the **Transport Layer Security (TLS) configuration** wizard page from the Automation 360 installer to generate a self-signed certificate or import a security certificate to set up a highly secure Control Room instance.

Automation Anywhere leverages TLS 1.2 and TLS 1.3 encryptions for HTTPS and TCP communications between our components. The TLS certificates are installed on the Automation Anywhere Control Room and IQ Bot servers. The certificates are installed in .PFX format and leveraged for communications.

---

**Note:** If your load balancer uses HTTP to forward traffic to the Control Room, do not use the **Enable Force HTTP traffic to HTTPS** option. We recommend that you use HTTPS to forward the load balancer traffic for enhanced security instead.

---

1. In the **TLS Configuration** page, configure the following:

- Generate a Self-Signed Certificate

Enabling the **Self-Signed Certificate** option allows the installer to generate a unique private key and a self-signed certificate for the Control Room.

- Import a Certificate

To import a custom certificate, clear the **Self Signed Certificate** check box. This setting allows you to import a certificate using the **Certificate Path** field.

---

**Note:** The certificate file must be a PKCS12 format.

---

Provide the following information:

- **Certificate Path:** Click **Browse** to import the certificate.
- **Private Key Password:** Enter the password for the private key.

---

**Password limitation:** Do not use the at sign (@) in passwords. Using the special character @ in the password causes the certificate file import to fail.

---

- **Intermediate certificates .zip File:** Click **Browse** to import the certificate.

The intermediate certificate file must be a single .zip file that includes the P12 or PKCS12 certificate file format and PEM certificate file format.

---

**Note:**

- Importing intermediate certificates is supported only on Windows.
- All the certificates in the zip file must be in the top-level folder and must not contain any subfolders.
- Password-protected intermediate certificates are not supported.

- 
- **Webserver Port:** Enter the web server port – either HTTP or HTTPS. If the port is already assigned, an error message is displayed.
- 

**Important:** The port validation message is also displayed when you add 8080 for the web server and if that port is already in use for a Control Room license service. Use a different unassigned port in these cases.

---

- **Enable Force HTTP traffic to HTTPS:** This option redirects all HTTP port requests to HTTPS. To access to the Control Room through HTTPS using the generated self-signed certificate, ensure the port numbers are different for HTTP and HTTPS.

To generate a custom certificate for HTTPS, ensure your custom certificate meets the following:

- Create a .pfx certificate with a pass code from a CA trusted authority.
- Combine Root, Intermediate, and Machine level certificates into a single certificate.
- Use the format [WS Machine Host Name].[DomainName].com for the private key.
- Include the host name as a fully qualified domain name (FQDN) in the certificate.

You provide the host name during Control Room installation.

- In multi-node HA clusters, issue certificates to the load balancer DNS name.
- Add individual URLs, which require access to all nodes, to the Subject **Alternative Name** field in the certificate.

For more information, see Automation Anywhere support site: [Automation 360 On-Premises prerequisites \(A-People login required\)](#).

The following sample illustration shows options for importing a custom certificate:

2. Click **Next** to configure service credentials.  
[Configure service credentials](#) on page 1251

Related tasks

[Change Control Room configuration to HTTPS from HTTP mode](#) on page 1386

If your Control Room is configured for HTTP mode, you can change the configuration to HTTPS mode. You must use a self-signed certificate either before or after performing a custom Control Room configuration.

[Import HTTPS, intermediate, and CA certificates](#) on page 1387

After you install the Control Room for an On-Premises deployment, you can use the Windows or Linux command prompt to import all or some of these certificates:

## Configure service credentials

Continue from the Control Room installer to the **Service Credentials** wizard page. Use this page to specify the account that will be used to run all Windows services that are created by the Automation Anywhere installer.

1. In the **Service Credentials** screen, choose from the listed options.  
The Windows Service credentials include a user name and password. The user specified must meet these requirements:

- Have permission to manage services, including Automation Anywhere services.
- If you use Windows authentication to connect to the SQL database, ensure you grant the `db_owner` permission to the service credential user.

These service credentials allow the Control Room processes to run the required services.

- **Local System Account**—(default) The logged-on user performing the installation.
  - **Use a Group Managed Service Account**—Specify to manage Automation 360 services.
    - a) Clear the **Local System Account** check box.
    - b) Select the **Use a Group Managed Service Account** option.
    - c) Enter the user name only. No password is required to use this option.

#### [Group Managed Service Accounts Overview](#)

- **Domain Account**—Specify a user that is not the local system account user
  - a) Clear the **Local System Account** check box.
  - b) Enter the user name and password for the domain account.

Use only supported characters for the user name and password. See [Supported special characters](#) on page 1217.
- Do not use the Windows domain credentials  
Enter credentials valid for running Automation Anywhere services. Without the valid credentials, the Control Room will fail to launch.
- PowerShell script restrictions  
Specify a user with permissions to launch PowerShell scripts who is not a Windows domain user. Without the relevant permissions, database table creation can fail.
- **Service Account (manually enter credential)**
  - a) Enter username.
  - b) Enter password.
- **Service Account (optionally retrieve service account credential from the previously configured external key vault )**
  - a) If using CyberArk, enter the safe name and object name for the credential.
  - b) If using AWS Secrets Manager, enter the secret name.
  - c) If using Azure, enter the vault URL.

The following example shows selection of a domain account:

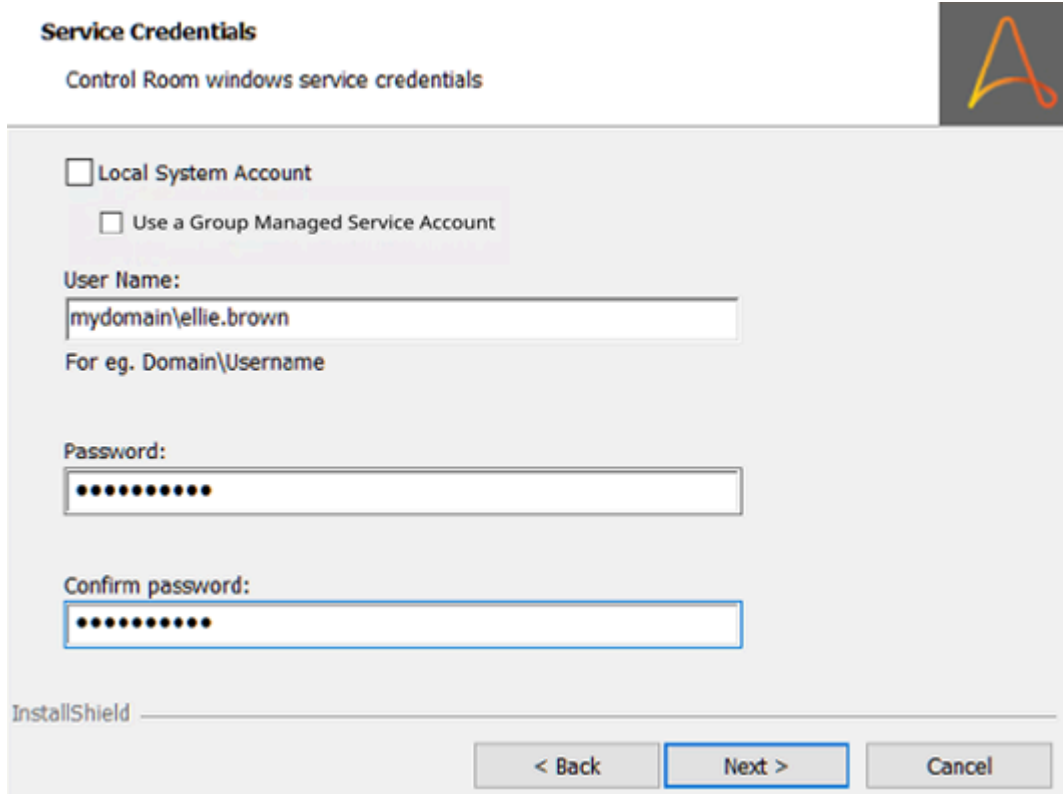

**Service Credentials**  
Control Room windows service credentials

Local System Account

Use a Group Managed Service Account

User Name:  
mydomain\ellie.brown  
For eg. Domain\Username

Password:  
●●●●●●●●

Confirm password:  
●●●●●●●●

InstallShield

< Back   Next >   Cancel

2. Click **Next**.

## Select Control Room services to automatically run at startup

Continue from the Control Room installer to the Control Room Service Startup Options wizard page. Use this page to select the Control Room services that you want to automatically run at startup.

All the services will be installed on the device. However, only the selected services will automatically run at startup. If required, you can manually start the unselected services from the Windows Services application.

1. In the **Control Room Service Startup Options** screen, select the services that you want to automatically run at startup.

---

### Note:

- To ensure effective utilization of computational resources, you can choose the Control Room services that are applicable to your environment. However, ensure that you do not exclude any of the dependent services.
- For those services that you do not include to run at startup when installing the Automation 360 On-Premises Control Room, a `products.notinstalled` file is created in the config files directory that you can open using a text editor. This file includes the name of the services that were not selected when installing the Automation 360 On-Premises Control Room. By default, all the services are selected and the `products.notinstalled` file

is not created. For information about the directory structure, see [Installed Control Room directories and files](#) on page 1398.

2. Click **Next**.

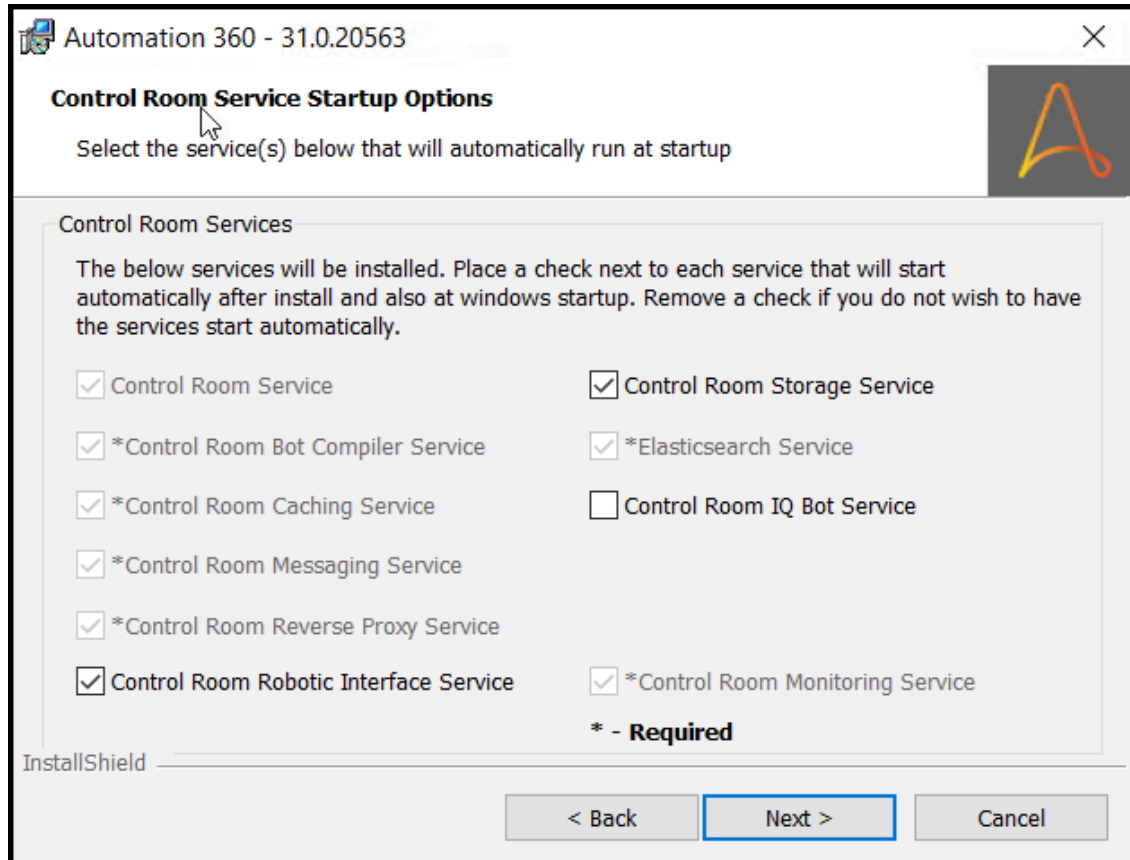

## Configure Microsoft database type and server

Continue from the Control Room installer to the **Database type** wizard page. Use this page to configure the Microsoft SQL Server database for use with the Control Room.

This procedure applies only to Microsoft Windows Server based installations.

**Linux users:** See [Installing Enterprise Control Room on Linux - Database configuration](#).

If you are installing Automation 360 as part of migration, this task includes the step to select the Enterprise 11 (cloned) database.

1. Select the **Microsoft SQL Server** database.  
An instance of the SQL Server should be already configured.
2. Click **Next**.  
The **Database Server** page is displayed (if you selected **SQL Server** for configuring your database).
3. Set the connection and authentication for the database server.

To configure the **Database Server** for the Control Room instance, use the default **Database Server** port 1433. If multiple instances are running on the same database host on different ports, you can use the corresponding custom port for that instance (for example, 1435 or 1437).

---

**Note:** The instance name is not supported in the **Database Server** field.

---

**Note:**

- If possible, do not set the value for **Database Server** as **localhost**. If you must use **localhost**, note that the **Secure Connection** to the database will not work.
- 
- Click **Browse** to select the SQL Server instance where the Control Room database will be created. Alternatively, enter a database server name or select one from the list.

---

Migration task: If you are migrating from Enterprise 11 to Automation 360, browse to the restored Enterprise 11 database.

Provide the following details:

- a) Database Port:** Use the default port (1433) or specify a custom value.  
[Configure default database port](#) on page 1257
- b) Use Secure Connection:** Select to use a CA certificate as specified.

---

**Note:** Use the same host name for certificate and database connections.

---

- c) Certificate:** This option is enabled when you select **Use Secure Connection**. Browse to select a CA certificate.

[Import HTTPS, intermediate, and CA certificates](#) on page 1387

- d)** Select one of the following for database authentication:

- **Windows authentication:** This option is selected by default and allows connection to the SQL Server using Windows authentication.

---

**Note:** If you select Windows authentication, then the user running the installer is used to test that the database exists, create it if required, and grant `db_owner` to the service account user (NT Authority/System).

---

- **SQL Server authentication:** (manually enter credential) Select this option to use SQL Server authentication to connect to the database. Provide the correct user name and password for SQL authentication.

1. Enter username.

2. Enter password.

- **SQL Server authentication:** (retrieve credential from external key vault) Select this option to use SQL Server authentication to connect to the database.

---

**Note:** SQL Server Authentication is required if you will retrieve the credentials for the database from an external key vault.

---

1. If using CyberArk, enter the safe name and object name.

2. If using AWS Secrets Manager, enter the secret name.
  3. If using HashiCorp Vault, enter the HashiCorp secret name.
- **AD Azure authentication:** Select this option to use Microsoft Azure Active Directory credentials to connect to the database when you install the Control Room on Microsoft Azure.

Use only supported characters for the user name and password. See [Supported special characters](#) on page 1217. Do not use semicolons ( ; ) in the database password.

- e) **Name of Control Room database:** Enter the name of the Control Room database.  
Migration task: If you are migrating from Enterprise 11 to Automation 360, enter the name of the restored database in the database field as shown in the following image:

**Database Server**  
Select authentication method and provide database names

Database Server: (local)\SQLEXPRESS Browse... Database Port: 1433

Use Secure Connection  
Certificate (Optional): Browse...

Windows authentication  Sql Server authentication  AD Azure authentication

Login ID: Password:

**Name of Control Room database:**  
Restored-11.x-Database

InstallShield

< Back Next > Cancel



The following sample illustration shows SQL Server authentication for database

connection:

4. Click **Next** to provide the Elasticsearch credentials.  
[Add OpenSearch credentials](#) on page 1259

## Configure default database port

Configure and enable the TCP/IP in the SQL database server to use the default port 1433 when you install the Control Room.

Enable TCP/IP from the Microsoft SQL Server Configuration Manager.

Transparent Data Encryption (TDE) is a function of Microsoft SQL Server database. Additional configurations are not required on the Control Room as the TDE supportability is managed by Microsoft. For more information, see [Transparent data encryption \(TDE\)](#) and [Transparent data encryption for SQL Database](#).

1. Ensure the SQL Server Browser service is running in the Task Manager.
2. To set the default port for the SQL database server, launch the Microsoft SQL Server Configuration Manager.
3. Select **SQL Server Network Configuration > Protocols for <SQL server instance>**.
4. Right-click **Protocols for <SQL server instance>** and select **Open** to show the available protocols.
5. Ensure **TCP/IP** is enabled.
6. Right-click **TCP/IP** and select **Properties**.  
 You can configure the default port for the SQL database from the **TCP/IP Properties** window that is displayed.
7. Select the **IP Addresses** tab to update the default **TCP Port** to **1433** in the **IPAll** node.  
 If provided, clear the value shown in the **TCP Dynamic Ports** field.
8. Click **OK** to confirm and exit the window.
9. Select the **SQL Server Services** option to **Restart** the **SQL Server <instance name>**.

The SQL database server is now configured and enabled to use the default port in the Control Room.

## Configure Oracle database type and server

Configure the Oracle Database Server for use with the Control Room by using the Database type wizard page.

This procedure applies only to installations based on Microsoft Windows Server.

Oracle must be installed on a machine that is accessible from the Automation 360 Control Room.

Create users for Automation Anywhere to access the Database.

This is supported only on non-container Database. Oracle installation is supported only for first-time setup of Automation Anywhere. Oracle installation does not support updates.

**Note:** Oracle database for Control Room installation is supported only in Custom mode and not in Express mode.

**1.** Select **Oracle** database.

An instance of the Oracle Server must be configured already. For more information, see [Installing Control Room using custom mode for Oracle installation](#) on page 1268.

**2.** Click **Next**.

The Oracle Database server page is displayed (if you selected Oracle for configuring your database).

The following sample illustration shows Oracle Database Server authentication for database connection:

The screenshot shows a Windows-style dialog box titled "Automation 360 - 26.0.0 - InstallShield Wizard" with a close button (X) in the top right corner. The main heading is "Oracle Database Server" and the subtitle is "Provide database server information and user credentials". There is an Automation Anywhere logo in the top right corner of the dialog.

The dialog contains the following fields and controls:

- Database Server:** A text box containing "localhost".
- Database Port:** A text box containing "1521".
- Connection Type:** Two radio buttons: "SID" (unselected) and "Service Name" (selected).
- Service Name:** A text box containing "ORCLPDB".
- Username:** An empty text box.
- Password:** An empty text box.
- Use Secure Connection:** An unchecked checkbox.
- Certificate:** A text box with a "Browse..." button to its right.
- Buttons:** At the bottom, there are three buttons: "< Back", "Next >" (highlighted with a blue border), and "Cancel".

3. Set the connection and authentication for the database server. Provide the following details:
  - a) **Database Server:** Enter the server name or IP address of the Oracle Database server.  
The **localhost** IP address can be used.
  - b) **Database Port:** Enter your database server port number. The default port is 1521.
  - c) For the connection, select one of the following options and enter the name of your Oracle instance in the text field:

Option	Action in text field (example)
SID	ORCL
Service name	ORCLPDB

**Note:** The SID and service name entered in the text field provided is unique to your Oracle database. The Oracle instance name entered in the text field is not case-sensitive.

4. In the **Username** field, enter your Oracle database user or schema name.
  5. In the **Password** field, enter the password for the user or schema name.
  6. **Use Secure Connection:** Select to use a CA certificate as specified.
- Note:** Use the same host name for certificate and database connections.
7. **Certificate:** This option is enabled when you select **Use Secure Connection**. Browse to select a CA certificate.  
[Import HTTPS, intermediate, and CA certificates](#) on page 1387
  8. Click **Next**.  
The database connection begins validating for the database server and the elastic search.
  9. Enter the Elasticsearch credentials in the fields provided.  
[Add OpenSearch credentials](#) on page 1259

## Add OpenSearch credentials

When installing Automation 360, add OpenSearch credentials for enhanced security.

**Note:** Starting from Automation 360 v.28 release (Build 17593), the Elasticsearch service is replaced with OpenSearch service as the underlying technology for core product capabilities such as audit, Bot Insight, and so on.

Based on whether you are performing a new installation, running the setup for the first time to update to a later version, or a subsequent re-installation, the options to add the OpenSearch credentials or select a backup OpenSearch server are enabled.

1. In the **Provide Elasticsearch Credentials** window, enter the credentials for OpenSearch in the **Elasticsearch password** field.

**Important:** Ensure the following for your Elasticsearch authentication password:

- The password cannot include a space, semicolon (;), percent (%), or backslash (\).
- The first character cannot be a minus sign (-) or forward slash (/).

- Include at least one alphabetical character.

This option is enabled only for the primary node of the cluster when you run the setup for the first time for an update or a new installation of the Control Room. When you enter the password, self-signed certificates are generated for encrypting the data traffic for inter-node and client communication.

The option is disabled for subsequent installations because the password and certificates are retrieved and reused from the second node onwards.

2. Repeat the credentials in the **Confirm Elasticsearch password** field.
3. Select the **Check only if installing on the first node of the backup Elasticsearch cluster** check box when you want to install the Control Room on the primary node that will be used as a backup for the OpenSearch cluster.  
This option is available only if you have provided the OpenSearch credentials for the primary node during a previous installation. The option enables you to use the database backup that is created from the OpenSearch settings table after the primary node of the cluster is installed. The option is disabled for subsequent installations.
4. Click **Next** to configure the IP cluster.

If you encounter errors when performing this task, see these resources:

- Error on storing OpenSearch certificate to database, see [Installation error storing Elasticsearch certificate to database \(A-People login required\)](#).
- Error restarting the Automation Anywhere Elastic Search Service, see [Automation 360 v.16 upgrade error: Elasticsearch Service fail to start during certificate retrieval process \(A-People login required\)](#).

[Configure IP cluster](#) on page 1261.

## Configure IP cluster

Use the **Cluster Configuration** wizard page under **Custom installation type** in Control Room installer to configure resiliency requirements. Select the **Enable Cluster setup** option and for high availability cluster, provide multiple (three or more) IP addresses from your cluster setup.

Before you install Control Room in cluster mode:

- Ensure that the default/custom and configurable firewall, port, and protocol requirements for Automation 360 deployment are configured. See [Ports, protocols, and firewall requirements](#) on page 1203.
- Ensure that the network location (UNC) path is configured to access the repository files from all Control Room nodes in the cluster.

Ensure that the Network Attached Storage (NAS) file sharing can be configured using Server Message Block (SMB) protocol.

- Ensure that all nodes that will be configured for the IP cluster are available for configuration before the installation. Also, while installing on each of the node, ensure that the list of IP addresses of all nodes are provided in the same order when configuring the **Cluster IP addresses** field in **Cluster Configuration** wizard page.
- Ensure to sign all the PowerShell files if the machine on which you are installing Automation 360 has MachinePolicy as AllSigned or UnRestricted. For example on how signing in a Windows PowerShell script, see [Signing in Windows PowerShell scripts](#).

To view the MachinePolicy on your machine, run the following command in PowerShell:

```
Get-ExecutionPolicy -List
```

You can find the following PowerShell files in the temp folder:

- servicecredsvalidate
- getsysip
- getfileprodversion
- ecertprocess
- createstorageables
- createpddtables
- createiqbottables
- createcrdbtables
- createaaridbtables

Example of a temp folder path: C:\Users\ADMINI~1\FD\AppData\Local\Temp\<GUID>.

---

**Note:** GUID is generated dynamically for each installer session.

---

A sample URL for reviewing the health of the cluster is:

```
https://<cr ip>:47599/_cat/health?pretty
```

You are prompted to enter the following credentials:

- Username: es\_client (default)
- Password: <your set\_ elastic\_search\_password>

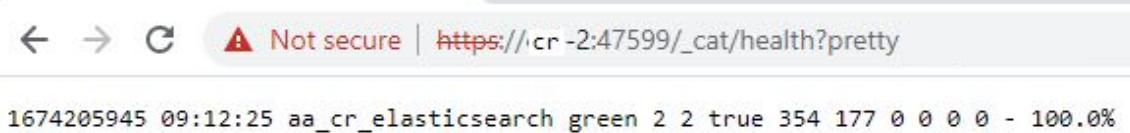

A green or yellow color icon is displayed for a healthy cluster.

1. Select the **Enable Cluster Setup** check box.
2. If the nodes in your network use IPv6 address, select the **IPv6** check box.
3. Enter the IP addresses of the nodes in the cluster.

Use a comma (,) to specify more than one IP address. For example, to specify three IP addresses in the cluster, enter: 192.0.2.1,192.0.2.2,192.0.2.3

**Note:** The first IP address in the list is used as the initial primary node. Ensure that you enter the IP addresses in the same order on all node configurations in subsequent installations.

You can install multiple nodes at the same time after the primary node is installed. After installation, you can add a new IP address to the cluster at the end of the list. However, you cannot change the IP address version (such as IPv4 to IPv6).

4. Select an IP address from the **Local IP Address** drop-down list.

If multiple local IP addresses are configured on the machine, ensure that you select an IP address (private IP address recommended) on which the Control Room is installed, as it will be used by other nodes internally to communicate with each other.

5. Click **Next** to complete the Control Room installation process.
6. Optional: To review or monitor the installation progress, see [Setup installation summary](#) on page 1267.

Related concepts

[High availability deployment](#) on page 1235

To support Automation 360 in your data center, configure an high availability (HA) cluster. Follow your company methods and procedures for implementing your data center cluster.

Related tasks

[Configure application Transport Layer Security](#) on page 1249

Use the **Transport Layer Security (TLS) configuration** wizard page from the Automation 360 installer to generate a self-signed certificate or import a security certificate to set up a highly secure Control Room instance.

Related reference

[Control Room repository requirements](#) on page 1208

The repository location is configured in the Control Room after installation. All your automations are stored in this repository.

[Ports, protocols, and firewall requirements](#) on page 1203

View the default and configurable firewall, port, and protocol requirements for Automation Anywhere deployment. View the default ports and protocols that are required to be allowed on customer's firewall for Automation Anywhere deployment. The default ports that are used for HTTP/HTTPS are configurable.

## Add nodes to a cluster setup

As an RPA platform administrator, you can add nodes to a cluster for better performance and better load distribution.

Ensure the following:

- Verify whether the prerequisites for on-premises installation are met.  
[Automation 360 On-Premises prerequisites](#) on page 1180
- Verify that all the primary nodes and databases have backups.
- You must have the IP addresses of all the cluster members for the Control Room server network interfaces used for Elasticsearch communications.

---

**Note:** The Control Room servers can have multiple network interfaces. The server IP addresses must be statically assigned and cannot use the Dynamic Host Configuration Protocol (DHCP).

---

- If any external load balancers are used in the environment, update them with IP addresses from the new server nodes.
- Ensure that you have administrator or root privileges on the Control Room servers. You must be familiar with installing Control Room in custom mode and also with the related configuration settings.

Adding nodes to a cluster helps you to update the configuration of the nodes in a cluster. You can add nodes to a Control Room cluster setup, change the IP addresses of nodes in the cluster, and monitor the health of the underlying cluster services.

---

**Note:** The minimal number of nodes supported within a Control Room cluster is three. The nodes in a cluster synchronize with each other over a local network. All the nodes in a cluster connect to the same database.

---

Perform the following steps to add three nodes (N4, N5, and N6) to a cluster that has three nodes (N1, N2, and N3).

1. On node N4, log in to the operating system as an administrator and run the Control Room installer.
2. Proceed through the installer to the cluster configuration.

- a) Select **Enable Cluster Setup**.
- b) In the **Cluster IP addresses** box, enter the IP addresses of all the nodes that you need to configure in the cluster.  
172.31.30.120, 172.31.21.216, 172.31.17.110, 172.31.20.242,  
172.31.17.149, 172.31.18.37
- c) Select or add your Local IP address.

---

**Note:** The IP addresses must be entered in the same sequence on every node.

---

3. Restart the nodes, one at a time.  
After you restart the nodes, each node will have six IP addresses.
4. Complete the remaining steps to install Control Room.  
[Installing Control Room On-Premises](#) on page 1177
5. Repeat the steps 1 on page 1263 through 4 on page 1264 for nodes N5 and N6.
6. Ensure that all the Control Room services have started for all the nodes.
7. To verify the health of the cluster, use the Elasticsearch API through a browser or API tool.
  - a) From a browser, navigate to the IP address of any node in the cluster by using the Elasticsearch port 47599 and use the `_cat/nodes` API.  
`https://172.31.30.120:47599/_cat/nodes`  
The primary node is indicated by an asterisk character (\*).
  - b) Verify that the IP address of the primary node is the same as the one mentioned in the `elasticsearch.yml` file for all the nodes.
  - c) From a browser, navigate to the IP address of any node in the cluster by using the Elasticsearch port 47599 and use the `_cat/health?pretty` API.  
`https://172.31.30.120:47599/_cat/health?pretty`

The replication status turns green when the cluster is fully synchronized.. You must wait until the replication status turns green. The replication time varies depending on the data load in the clusters.

## Update nodes in a cluster setup

In a multi-node cluster setup, when you update from Automation 360 v.27 and earlier versions to Automation 360 v.28 and later versions, the installation might fail if any Elasticsearch (ES) index created by ES 6.x is present.

- Ensure that all the Control Room services (except Elasticsearch service) are stopped in all the nodes in the three-node cluster.
- Ensure that the Automation Anywhere Elastic Search Service is up and running before you run the installer on the node.

---

**Note:** This procedure is applicable to Automation 360 v.28 and later versions.

---

You can update only ES indices created by ES v7.x and cannot update the ES v6.x indices. You must update all the ES indices from ES 6.x to ES 7.x before you update to Automation 360 v.28 and later versions.

Consider a scenario where you have to update three nodes cluster with the following IP addresses:



- N1: 10.239.178.41
- N2: 10.239.178.6
- N3: 10.239.180.39

To successfully update to Automation 360 v.28 and later versions, you must perform the following steps:

1. Identify the Elasticsearch (ES) primary node by running the below API from any browser on any one of the three Control Room nodes.

```
GET https://<ES_IP>:<ES_PORT>/_cat/nodes?v=true&h=id, ip,port,v,m
```

A prompt for the Elasticsearch username and password displays while running the API.

For example,

```
curl -k -X GET --user username: password
```

```
https://10.239.180.39:47599/_cat/nodes?v=true&h=id,ip,port,v,m
```

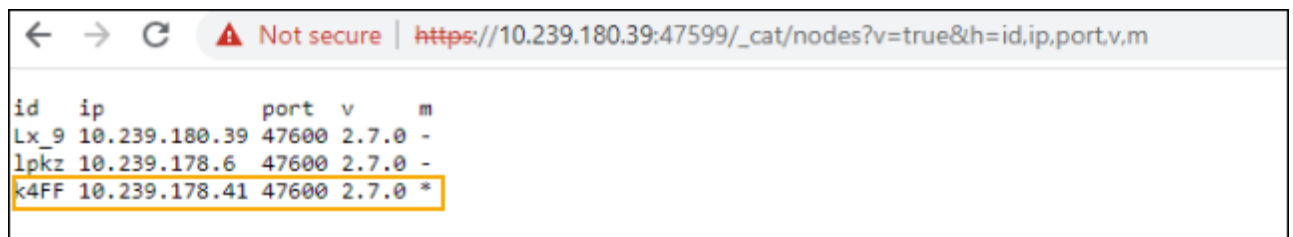

**Note:** The primary node is indicated by an asterisk character (\*)

In this example, N1(10.239.178.41) is the primary node when Automation Anywhere Elastic Search Service is running all three nodes.

2. Start with the current Elasticsearch primary node (N1), run the installer (v.28 or later) on N1(10.239.178.41) and complete the configuration.

The N1(10.239.178.41) is on Automation 360 v.28 or later version after the successful installation.

3. Stop the Automation Anywhere Elastic Search Service on N1(10.239.178.41).

4. Identify the next ES primary node by running the API request from any browser on N2(10.239.178.6) and N3(10.239.180.39).

If N2(10.239.178.6) is the next ES primary node, run the installer (v.28 or later) on N2(10.239.180.39) and complete the configuration. Otherwise, proceed with N3(10.239.180.39) ES primary node update.

In this example, N2(10.239.178.6) is the next ES primary node.

5. Run the installer (v.28 or later) on N2(10.239.178.6) and complete the configuration. After the successful installation, N1(10.239.178.41) and N2(10.239.178.6) are on Automation 360 v.28 or later version with the OpenSearch libraries.
6. Verify that N3(10.239.180.39) is still the current ES primary node by running the API request from any browser on N3(10.239.180.39).
7. Start the Automation Anywhere Elastic Search Service on N1(10.239.178.41).
8. Stop the Automation Anywhere Elastic Search Service on N3(10.239.180.39).

9. Identify the next ES primary node by running the API request from any browser on N1(10.239.178.41) and N2(10.239.178.6).
10. Start the Automation Anywhere Elastic Search Service on N3(10.239.180.39).
11. Run the installer (v.28 or later) on N3(10.239.180.39) and complete the configuration. All the cluster nodes, N1(10.239.178.41), N2(10.239.178.6), and N3(10.239.180.39) are updated to Automation 360 v.28 or later version with the OpenSearch libraries.

## Remove nodes from a cluster setup

As an RPA platform administrator, you can remove nodes from a Control Room cluster setup to replace or update them for enhanced performance.

Ensure the following:

- Verify that all the primary nodes and databases have backups.
- Ensure that you have administrator or root privileges on the Control Room servers.

---

**Note:** Starting from Automation 360 v.28 release (Build 17593), the Elasticsearch service is replaced with OpenSearch service as the underlying technology for core product capabilities such as audit, Bot Insight, and so on.

---

Perform the following steps to remove three nodes (N1, N2, and N3) from a cluster that has six nodes (N1, N2, N3, N4, N5, and N6).

1. Verify the primary node.  
Use the following OpenSearch API through a browser or API tool to identify the primary node:  
`https://172.31.18.37/_cat/nodes`
2. Log in to the server as an administrator and stop all the Control Room services by running the following command:  
`services.msc`  
Log in to one of the original nodes N2 or N3 and not the primary node N1.
3. Similarly, stop all the Control Room services for the primary node N1.
4. Before removing the nodes, verify the health of the cluster by using the following OpenSearch API through a browser or API tool:  
From a browser, navigate to the IP address of any node in the cluster by using the OpenSearch port 47599 and use the `_cat/nodes` API.  
`https://172.31.18.37/_cat/nodes`

---

**Note:** The primary node is indicated by an asterisk character (\*).

---

5. Edit the `cluster.properties` file located at `C:\Program Files\Automation Anywhere\Automation 360\config`.
6. Remove the IP addresses for the original three nodes from the `cluster.properties` attribute.

---

**Note:** Perform this action for all the nodes in the cluster. When you remove the IP addresses of the original three nodes, do not change their sequence.

---

7. Edit the `elasticsearch.yml` file at `C:\Program Files\Automation Anywhere\Automation 360\elasticsearch\config`.
8. Remove the IP addresses for the original three nodes from the `discovery.zen.ping.unicast.hosts` attribute.

**Note:** The `discovery.zen.ping.unicast.hosts` attribute must contain the IP addresses only for the new nodes and in the same sequence within the file on each node.

---

9. To verify the new primary node, use the following OpenSearch API through a browser or API tool:

```
https://172.31.18.37/_cat/nodes
```

10. Update the IP address of the new primary node in the `cluster.initial_master_nodes` attribute.
11. Run the following command to start the services on each node:

```
services.msc
```

You must start the services on the primary node at the end.

12. To verify the health of the cluster, use the OpenSearch API through a browser or API tool.

- a) From a browser, navigate to the IP address of any node in the cluster by using the OpenSearch port 47599 and use the `_cat/nodes` API.

```
https://172.31.30.120:47599/_cat/nodes
```

---

**Note:** The primary node is indicated by the asterisk character (\*).

---

- b) From a browser, navigate to the IP address of any node in the cluster by using the OpenSearch port 47599 and use the `_cat/health?pretty` API.

```
https://172.31.30.120:47599/_cat/health?pretty
```

The replication status turns `green` when the cluster is fully synchronized. You must wait until the replication status turns `green`. The replication time varies depending on the amount of data in the clusters.

## Setup installation summary

Continue from the Control Room installer to the **Ready to Install the Program** wizard page. From this stage of the installation wizard, you finish the installation wizard and monitor the installation progress.

1. Click **Next**.

The **Ready to Install the Program** screen appears.

2. Click **Install** and allow the installation process to complete.

The **InstallShield Wizard Completed** screen appears.

3. Click **Finish**.

Launch Automation Anywhere is enabled by default.

Enable **Show installer settings** to open the `aae-installsummary.html` file. By default, this is located at `C:\Program Files\Automation Anywhere\Enterprise\`. Use this file to view a summary of the installation.

Complete the Control Room configuration and validation.

- [Complete Control Room post-installation configuration](#) on page 1315

After installing the Control Room, complete the configuration settings to ensure timely Automation Anywhere communications are specified and confirm Automation Anywhere services are running.

- [Post-installation user management](#) on page 1371

After completing the post-installation tasks, validate the setup by logging in to the Control Room and installing a license. First time access to the Control Room walks you through the configuration for your authentication method.

- [Users](#) on page 1737

As a Cloud user with administrator permissions, you can create, view, edit, delete, and enable or disable a user. Creating users steps vary depending on whether the user is a non-Active Directory, Active Directory, or single sign-on (SSO) user from an IdP server.

Related tasks

[Installing Control Room using Express mode](#) on page 1270

## Installing Control Room using custom mode for Oracle installation

Install the Automation Anywhere Control Room using Oracle Database for On-Premises and complete the installation in the Control Room.

Ensure the following:

- Oracle Database is preconfigured in your environment before you complete the Control Room installation.
- Oracle 19c On-Premises or over AWS RDS Oracle is supported. Ensure that the following settings are enabled with version 19c:
  - The value of the Oracle instance `max_string_size` parameter is set to EXTENDED.
  - If you want to use the SSL/TLS connection for the database, it is required that you configure TLS on the Oracle Server.
  - Oracle credentials are created. Database credentials must be created and the following grants must be provided: CONNECT, RESOURCE, CREATE TABLE, CREATE VIEW.

---

**Note:** The QUOTA on tablespace USERS is UNLIMITED.

---

---

**Note:** **External vault integration** is not supported on Oracle-based Windows Control Room installation.

---

### Procedure

1. Prepare for installation
  - Verify [Automation 360 On-Premises prerequisites](#) on page 1180.
  - Ensure that you have the following:
    - Automation Anywhere Control Room installation file
    - TLS certificate
    - License file
2. [Run Control Room installer](#) on page 1247.

Run the installer to verify the operating system and hardware requirements, select the deployment option, accept the licensing agreement, and select the installation file path.

---

**Note:** Ensure that you select Oracle for **Database type**.

---

3. [Configure application Transport Layer Security](#) on page 1249.

Use the **Transport Layer Security (TLS) configuration** page to generate a self-signed certificate or import a security certificate to set up a highly secure Control Room instance.

4. [Configure service credentials](#) on page 1251.

Use the **Service Credentials** page to specify the account that will be used to run all Windows services that are created by the installer.

5. [Configure Oracle database type and server](#) on page 1258

Use the **Database type** page to configure the Oracle Database for use with the Control Room.

6. [Add OpenSearch credentials](#) on page 1259.

Add Elasticsearch credentials for enhanced monitoring and alerting in the Control Room.

7. [Configure IP cluster](#) on page 1261.

Use the **Cluster Configuration** page to configure resiliency requirements. Provide only one IP address to configure the Control Room on a single node. Provide multiple (three or more) IP addresses to configure the Control Room for high availability cluster.

8. [Review the installation summary](#).

Use the **Ready to Install the Program** page to complete the installation wizard and monitor the installation progress.

9. Complete Control Room configuration and validation.

[Complete Control Room post-installation configuration](#) on page 1315

After installing the Control Room, complete the configuration settings to ensure that timely Automation Anywhere communications are specified and confirm that Automation Anywhere services are running.

[Post-installation user management](#) on page 1371

After completing the post-installation tasks, validate the setup by logging in to the Control Room and installing a license. First-time access to the Control Room walks you through the configuration for your authentication method.

10. [Prepare for users](#).

As an administrator, you can create, view, edit, delete, and enable or disable a user. The steps for creating users can vary depending on whether the user is a non-Active Directory, Active Directory, or single sign-on (SSO) user from an IdP server.

## Installing Control Room using Express mode

Log in to the servers as an Administrator and install Automation Anywhere Control Room in Express Mode using the default settings.

**Note:** Linux users, see [Installing Control Room on Linux](#) on page 1293.

- Verify [Automation 360 On-Premises prerequisites](#) on page 1180.
- Ensure that you have the following:
  - Automation Anywhere Control Room installation file
  - TLS certificate
  - License file

**Important:** This installation mode is ideal for demo and training purposes. This installation mode is not recommended for the production environment.

The Express Mode installation quickly sets up the Control Room with default parameters for the various components.

Default parameters

Microsoft SQL Server is the default database for Control Room.

The following parameters are installed by default:

Parameter	Default value
SQL database instance	SQLEXPRESS
Authentication type	Windows authentication
Control Room database	Automation360-Database
Port	1433

To install Automation Anywhere Control Room in Express Mode, follow these steps:

1. Log in to the installation server.
2. Start the installer wizard.
  - a) Extract all files from the `Automation360_Build_<build-number>.zip` file.
  - b) Right-click the `Automation360.exe` file and select **Run as administrator**.

The installation process creates the Control Room database with the name Automation360-Database on your SQL database server instance.

**Note:** Ensure the SQL database server is installed on a different server than that of the Control Room.

The installation process checks for supported operating system and recommended hardware requirements. The following message appears if the requirements are not met:

```
This system does not meet all the installation prerequisites for
Automation Anywhere Enterprise.
```

Some features might not work as expected after installation. For details, verify the [Control Room Installation Prerequisite](#).

For more information, see [Automation 360 On-Premises prerequisites](#) on page 1180.

3. Click **Next** on the **Welcome to the Setup Wizard** page.
4. Select one of the following deployment types and click **Next**:

Deployment type	Description
On-Premises	The Control Room, Bots and files are installed on your servers.
Cloud-enabled	All data such as bots and files are installed on your servers. The management functions of the Control Room are delivered through Cloud.

5. Accept the licensing agreement and click **Next**.
6. On the **Installation Type** page, select the **Express** option and click **Next**.  
The **Database Server** configuration page appears.
  - a) Enter the port you want to use to connect to the database server in the **Port** field.  
The default port is 1433. The installer uses the first available port and checks the availability of each consecutive port.
  - b) Select any one of the following options to connect to the database server.

Option	Action
<b>Use Windows Authentication</b>	The system uses your Windows credentials. The <b>Login ID</b> and <b>Password</b> fields are disabled in the installer.
<b>Sql Server authentication</b>	Enter the <b>Login ID</b> and <b>Password</b> used for connecting to the database server.
<b>AD Azure authentication</b>	Enter the <b>Login ID</b> and <b>Password</b> used for connecting to the database server.  Select this option to use Microsoft Azure Active Directory credentials to connect to the database when you install the Control Room on Microsoft Azure.

---

**Note:** The user who connects to the database server must have database creator privileges.

---

- c) Enter the name of the database that you want to use for Control Room in the **Name of Control Room** database field.
7. Click **Next** on **Provide Elasticsearch credentials** page to configure Elasticsearch for enhanced monitoring and alerting in the Control Room.

**Important:** Ensure the following for your Elasticsearch authentication password:

- The password cannot include a space, semicolon (;), percent (%), or backslash (\).
  - The first character cannot be a minus sign (-) or forward slash (/).
  - Include at least one alphabetical character.
- 

This option is enabled only for the primary node of the cluster when you run the setup for the first time for a new installation or an upgrade of the Control Room. When you enter the password, self-signed certificates are generated for encrypting the data traffic for inter-node and client communication.

The option is disabled for subsequent installations because the password and certificates are retrieved and reused from the second node onwards.

- 8.** Optional: When you want to install the Control Room on the primary node that will be used as a backup for the Elasticsearch cluster, select the **Check only if installing on the first node of the backup Elasticsearch cluster** check box.

This option is available only if you have provided the Elasticsearch credentials for the primary node during a previous installation. The option enables you to use the database backup that is created from the Elasticsearch settings table after the primary node of the cluster is installed.

The option is disabled for subsequent installations.

- 9.** Click **Next**.

- 10.** On the **Ready to Install the Program**, click **Install** and allow the installation process to complete.

During this process, the Automation 360 services are started automatically.

- 11.** On the **InstallShield Wizard Completed** page, click **Finish**.

Launch Automation 360 is enabled by default.

Enable **Show installer settings** to open the `aae-installsummary.html` file. By default, this is located at `C:\Program Files\Automation Anywhere`. Use this file to view a summary of the installation.

The Control Room launches in your default browser with the **Configure Control Room settings** page displayed. Proceed to [Complete Control Room post-installation configuration](#) on page 1315.

Related concepts

[Installing Control Room using Custom mode](#) on page 1245

Log in to the server as an administrator and install Automation Anywhere Control Room in Custom mode to select installation and configuration options, including installing non-default requirements. Select this mode for a data center deployment.

## Installing Control Room on Amazon Web Services

Log in to an Amazon Web Services (AWS) server instance as Administrator. Then, download and start the Control Room installer and select **Custom** mode.

---

### Note:

- Many possible system configurations and requirements exist. These installation steps do not account for all those possibilities, so your specific setup and installation steps will vary, and



Automation Anywhere does not make any warranties that these steps conform to your specific configurations.

- For Automation 360 to work properly on Amazon Workspace, update the registry on all Workspace machines. For details, see [Device compatibility](#) on page 1341 .
- 

Step 1: Prepare for installation

- Verify [Automation 360 On-Premises prerequisites](#) on page 1180.
- Ensure that you have the following:
  - Automation Anywhere Control Room installation file
  - TLS certificate
  - License file

Step 2: [Prepare for installation on Amazon Web Services](#) on page 1274

Use these steps to prepare the Amazon Web Services (AWS) instances for the Control Room installation.

Step 3: [Customize Control Room installation on Amazon Web Services](#) on page 1275

Install and apply the customized configuration required for the Control Room cluster on Amazon Web Services (AWS) after completing initial preparations.

Step 4: Complete Control Room configuration and validation.

[Complete Control Room post-installation configuration](#) on page 1315

After installing the Control Room, complete the configuration settings to ensure timely Automation Anywhere communications are specified and confirm Automation Anywhere services are running.

[Post-installation user management](#) on page 1371

After completing the post-installation tasks, validate the setup by logging in to the Control Room and installing a license. First time access to the Control Room walks you through the configuration for your authentication method.

Step 5: Prepare for users.

[Users](#) on page 1737

As a Cloud user with administrator permissions, you can create, view, edit,

delete, and enable or disable a user. Creating users steps vary depending on whether the user is a non-Active Directory, Active Directory, or single sign-on (SSO) user from an IdP server.

## Prepare for installation on Amazon Web Services

Use these steps to prepare the Amazon Web Services (AWS) instances for the Control Room installation.

If you have not done so already, prepare your AWS Identity and Access Management (IAM) user account to login to the AWS Console.

Do the following:

1. Create AWS Elastic Compute Cloud (EC2) Instances for the Control Room Servers.
2. If you use RDS, create Relational Database Service (RDS) Instances for the SQL Server Enterprise 2014 Database server.
3. Configure the AWS Load Balancer.

---

**Note:** There are many possible system configurations and requirements. These installation steps do not account for all those possibilities so your specific setup and installation steps will vary and Automation Anywhere does not make any warranties that these steps conform with your specific configurations.

---

To prepare AWS instances, do the following:

1. Set up the on Amazon Web Services Elastic Compute Cloud (AWS EC2) or Relational Database Service (RDS).  
AAE supports both. For a comparison of the two, see [Microsoft SQL Server on AWS](#).
2. Test the database connection with the Microsoft SQL Server.
  - a) Install Microsoft SQL Management Studio on one of the AWS EC2 instances inside the Virtual Private Cloud (VPC).  
For more information, see [Download SQL Server Management Studio](#).
  - b) Connect to the Microsoft SQL Server.  
For configuration information, see [Working with SQL Servers](#) on page 1192.
  - c) (Skip this step if the primary database user installs the Control Room). Create the following empty database and assign `db_owner` privileges to the primary database user for the Automation360-Database.
3. Set up the shared repository.
  - a) Create an AWS EC2 instance as a Windows File Server with an additional volume of 100 GB.

- b) Join the Active Directory domain.
- c) Create a folder and set up the permissions for the repository.  
Assign the Control Room admin full access to this folder.

---

**Important:** Only the Control Room admin is to have full access to this folder because this is the account from which all Control Room services run.

---

- 4. Launch three AWS instances, one for each Control Room server.
  - a) Establish three AWS instances, each with the following configuration:
    - Type: c5.2xlarge or similar instance type (8 CPU, 16 GB RAM)
    - Storage: Root Device: 100 GB
    - Storage: Additional Device: D:\ 200 GB (For Automation Anywhere Install files)
    - Accidental Deletion Prevention: Enabled
  - b) Access the three instances through Remote Desktop Protocol.
  - c) Add the instances to the Active Directory domain.
  - d) For each instance, add the Control Room system admin as a local administrator on the computer and reboot the system.
- 5. Configure the firewall and port.  
See [Ports, protocols, and firewall requirements](#) on page 1203.
- 6. Set up the AWS Application Load Balancer.  
See [Details for Elastic Load Balancing Products](#).
  - Disable the stickiness attribute.
  - Set the idle time-out to 120 seconds.
- 7. Upload the SSL certificate to the Load Balancer.

Continue with [Customize Control Room installation on Amazon Web Services](#) on page 1275.

## Customize Control Room installation on Amazon Web Services

Install and apply the customized configuration required for the Control Room cluster on Amazon Web Services (AWS) after completing initial preparations.

Ensure that you complete the initial installation steps in [Prepare for installation on Amazon Web Services](#) on page 1274.

---

**Note:** There are many possible system configurations and requirements. These installation steps do not account for all those possibilities. Therefore your specific setup and installation steps will vary and Automation Anywhere does not make any warranties that these steps conform with your specific configurations.

---

To install the Control Room in a cluster setup, do the following steps:

- 1. Log in to the first AWS instance as an Administrator.
- 2. Download `Automation Anywhere_<version>.exe`.
- 3. Click **Next** on the **Welcome to the Setup Wizard** page.

4. Accept the license agreement and click **Next**.
5. Select the **Custom** option and click **Next**.  
The **Destination Folder** page appears. By default, the destination folder is C:\Program Files\Automation Anywhere\Enterprise\.
6. To make changes to the destination folder, click **Change**, enter a new destination folder name, and click **OK**.

---

**Note:** Do not install the application directly in the root directory (C:\). Ensure that you create a folder. For example, C:\Program Files\Automation Anywhere\Enterprise\.

---

7. Click **Next** to configure the IP cluster.
8. Select the **Enable Cluster Setup** check box.  
The check box is enabled by default if the machine on which the setup is being run has local IP address configured.  
To install the Control Room on a single node and not a cluster, clear the **Enable Cluster Setup** check box.
9. Enter the IP addresses of the nodes in the cluster.
  - Enter IPv6 addresses if all the nodes in the network are using IPv6.
  - Enter IPv4 addresses if some nodes in the network are using a combination of IPv4 and IPv6 addresses.
- a) Use a comma (,) to specify more than one IP address.  
For example, to specify three IP addresses in the cluster, enter:  
192.0.2.1,192.0.2.2,192.0.2.3

---

**Important:** The first IP address in the list is used as the primary node. Ensure that you enter the IP addresses in the same order on all node configurations in subsequent installations. An incorrect order causes the application to configure the IP addresses as separate clusters, which will result in data loss when the issue is fixed after installation.

---

You can install multiple nodes at the same time after installing the primary node.  
After installation, you can add a new IP address to the cluster at the end of the list.

- b) After you enter the cluster IP addresses correctly, select a valid address IP at the message prompt to provide network access to the machine.
10. Click **Next** to configure the application Transport Layer Security (TLS).
  11. In the **TLS Configuration** page, select one of the following:
    - Generate a Self-Signed Certificate  
Enabling the **Self-Signed Certificate** option allows the installer to generate a unique private key and a self-signed certificate for the Control Room.
    - Import a Certificate  
To import a custom certificate, clear the **Self Signed Certificate** check box. This setting allows you to import a certificate using the **Certificate Path** field.

---

**Note:** The certificate file must be a PKCS12 format.

---

Provide the following information:

- **Certificate Path:** Click **Browse** to import the certificate.

- **Private Key Password:** Enter the password for the private key.

---

**Password limitation:** Ensure that you do not use the special character (@) in the password as it can cause the certificate file import to fail.

---

- **Webserver Port:** Enter the web server port – either HTTP or HTTPS. If the port is already assigned, an error message is displayed.

---

**Important:** The port validation message is also displayed when you add 8080 for the web server and if that port is already in use for a Control Room license service. Use a different unassigned port in these cases.

---

- **Enable Force HTTP traffic to HTTPS:** This option redirects all HTTP port requests to HTTPS. To access to the Control Room through HTTPS using the generated self-signed certificate, ensure the port numbers are different for HTTP and HTTPS.

To generate a custom certificate for HTTPS, ensure your custom certificate meets the following:

- Create a .pfx certificate with a pass code from a CA trusted authority.
- Combine Root, Intermediate, and Machine level certificates into a single certificate.
- Use the format [WS Machine Host Name].[DomainName].com for the private key.
- Include the host name as a fully qualified domain name (FQDN) in the certificate.

You provide the host name during Control Room installation.

- In multi-node HA clusters, issue certificates to the load balancer DNS name.
- Add individual URLs, which require access to all nodes, to the Subject Alternative Name field in the certificate.

For more information, see Automation Anywhere support site: [Automation 360 On-Premises prerequisites \(A-People login required\)](#).

12. Click **Next** to configure the service credentials.

13. In the **Service Credentials** screen, choose from the listed options.

The Windows Service credentials include a user name and password. The user specified must meet these requirements:

- A member of the local system administrator group.
- Have permission to manage services, including Automation Anywhere services.
- If you use Windows authentication to connect to the SQL database, ensure you grant the db\_owner permission to the service credential user.

These service credentials allow the Control Room processes to run the required services.

- **Local System Account**—(default) The logged-on user performing the installation
- **Domain Account**—Specify a user that is not the local system account user

a) Clear the **Local System Account** check box.

b) Enter the user name and password for the domain account.

Use only supported characters for the user name and password. See [Supported special characters](#) on page 1217.

- Do not use the Windows domain credentials  
Enter credentials valid for running Automation Anywhere services. Without the valid credentials, the Control Room will fail to launch.
- PowerShell script restrictions  
Specify a user with permissions to launch PowerShell scripts who is not a Windows domain user. Without the relevant permissions, database table creation can fail.

**14.** Add the SQL Server and click **Next**.

Select Microsoft SQL Server, type the **Name**, and click **Next**.

**15.** On the **InstallShield Wizard Completed** page, click **Finish**.

Launch Automation Anywhere is enabled by default.

Enable **Show installer settings** to open the `aae-installsummary.html` file. By default, this is located at `C:\Program Files\Automation Anywhere\Enterprise\`. Use this file to view a summary of the installation.

The Control Room launches in your default browser with the Configure Control Room settings page shown. Continue with [Configure settings post-installation on Amazon Web Services](#) on page 1278.

## Configure settings post-installation on Amazon Web Services

After installation is complete, configure Control Room settings on Amazon Web Services.

If you have not done so already, complete the installation steps in [Customize Control Room installation on Amazon Web Services](#) on page 1275.

---

**Note:** There are many possible system configurations and requirements. These installation steps do not account for all those possibilities so your specific setup and installation steps will vary and Automation Anywhere does not make any warranties that these steps conform with your specific configurations.

---

To install Automation Anywhere on Amazon Web Services (AWS), do the following steps:

1. Configure the following Control Room settings:
  - a) Specify the host name URL by providing the AWS Load Balancer URL.  
This is the URL that users use to access your installation of Control Room.
  - b) Select the Active Directory authentication type. For more information, see [Configure Control Room for Active Directory: manual mode](#) on page 1375.
2. After you configure the Control Room, install product licenses.
3. Test Control Room access using the AWS Load Balancer URL.  
This completes the Control Room installation on AWS.

Complete the Control Room configuration and validation.

- [Complete Control Room post-installation configuration](#) on page 1315

After installing the Control Room, complete the configuration settings to ensure timely Automation Anywhere communications are specified and confirm Automation Anywhere services are running.

- [Post-installation user management](#) on page 1371

After completing the post-installation tasks, validate the setup by logging in to the Control Room and installing a license. First time access to the Control Room walks you through the configuration for your authentication method.

- [Users](#) on page 1737

As a Cloud user with administrator permissions, you can create, view, edit, delete, and enable or disable a user. Creating users steps vary depending on whether the user is a non-Active Directory, Active Directory, or single sign-on (SSO) user from an IdP server.

## Installing Control Room on Microsoft Azure

Installing Control Room on Microsoft Azure begins in the Azure environment and ends with configurations in the Control Room.

---

**Note:** There are many possible system configurations and requirements. These installation steps do not account for all those possibilities so your specific setup and installation steps will vary and Automation Anywhere does not make any warranties that these steps conform with your specific configurations.

---

Step 1: Prepare for installation.

- Verify [Automation 360 On-Premises prerequisites](#) on page 1180.
- Ensure that you have the following:
  - Automation Anywhere Control Room installation file
  - TLS certificate
  - License file

Step 2: [Verify readiness for installation on Microsoft Azure](#) on page 1280

Use these steps to configure third-party products for the Control Room installation.

Step 3: [Begin Control Room installation on Microsoft Azure](#) on page 1282

Initial steps for Control Room installation on Microsoft Azure.

Step 4: [Customize Control Room installation on Microsoft Azure](#) on page 1283

Install and apply the customized configuration required for the Control Room cluster on Microsoft Azure.

Step 5: Complete Control Room configuration and validation.

[Complete Control Room post-installation configuration](#) on page 1315

After installing the Control Room, complete the configuration settings to ensure timely Automation Anywhere communications are specified and confirm Automation Anywhere services are running.

[Post-installation user management](#) on page 1371 After completing the post-installation tasks, validate the setup by logging in to the Control Room and installing a license. First time access to the Control Room walks you through the configuration for your authentication method.

Step 6: Prepare for users.

[Users](#) on page 1737 As a Cloud user with administrator permissions, you can create, view, edit, delete, and enable or disable a user. Creating users steps vary depending on whether the user is a non-Active Directory, Active Directory, or single sign-on (SSO) user from an IdP server.

## Verify readiness for installation on Microsoft Azure

Use these steps to configure third-party products for the Control Room installation.

---

**Note:** There are many possible system configurations and requirements. These installation steps do not account for all those possibilities so your specific setup and installation steps will vary and Automation Anywhere does not make any warranties that these steps conform with your specific configurations.

---

To configure third-party products prior to installation, do the following steps:

1. Ensure the installation environment meets the data center requirements and collect the necessary information about the following components:
  - Load balancer - IP address
  - Microsoft SQL Server - port credentials
  - Azure SMB file share - address credentials
  - Enterprise identity management system (optional)
    - If you have Active Directory (AD) - AD server domain credentials
  - SMTP - host port HTTP/S ports for TLS (optional)
  - Control Room servers - Have Windows credential manager installed



Refer to [Supported data center component versions on Microsoft Azure](#) on page 1281 for configuration and version information.

2. Configure the Network Security Group as per the recommended security policies for Inbound Port rules:

Data center object	Port	Protocol
Control Room	<ul style="list-style-type: none"> <li>• 80</li> <li>• 443</li> </ul>	Any
LDAP	<ul style="list-style-type: none"> <li>• 3268</li> <li>• 3269</li> </ul>	Any
email SMTP	587	Any
SSH	22	Any
RDP	3389	TCP

3. Configure the AD server.

Ensure all users are part of the AD domain and the AD server is setup in IaaS mode for Azure cluster environment installations. To add user, navigate to **Active Directory Users and Computers > <domain> > Users** and add the necessary user.

To configure the AD server on Azure with IDaaS, refer to the [Microsoft Azure documentation](#).

4. Ensure the Control Room servers in the cluster can ping each other.

If the ping is not successful:

- a) In **Windows Defender Firewall with Advanced Security>Inbound rules**, set the following values for the file and printer sharing firewall rule:

- **Name:** File and Printer Sharing (Echo Request - ICMPv4-In)
- **Group:** File and Printer Sharing
- **Profile:**All
- **Enabled:** Yes
- **Action:** Allow
- **Override:** No
- **Program:** Any
- **Local address:** Any
- **Remote address:** Any
- **Protocol:** ICMPv4

- b) Ping the Control Room after enabling the firewall rule change.

When you have completed the pre-installation configurations, [Begin Control Room installation on Microsoft Azure](#) on page 1282.

## Supported data center component versions on Microsoft Azure

For installing Automation Anywhere on the Microsoft Azure cluster environment, the versions of data center components that are supported are identified for each component.

Data center object	Supported version	Configuration
Control Room operating system	<ul style="list-style-type: none"> <li>Microsoft Windows Server 2012 and 2012 R2 Datacenter</li> <li>Microsoft Windows Server 2016 Standard and Datacenter</li> <li>Microsoft Windows Server 2019 Standard and Datacenter</li> </ul>	IaaS
Identity management: Azure	Azure Active Directory	<ul style="list-style-type: none"> <li>IDaaS</li> <li>Windows 2016 for IaaS</li> </ul>
	Azure File Share with Server Message Block 2.0 and 3.0 (SMB) protocol	PaaS
	Azure Load Balancer	PaaS
	Azure Application Gateway	
	Azure SQL Database with single database (Microsoft SQL Azure (RTM) - 12.0.2000.8)	PaaS

## Begin Control Room installation on Microsoft Azure

Initial steps for Control Room installation on Microsoft Azure.

If you have not done so already, complete the pre-installation configuration in [Verify readiness for installation on Microsoft Azure](#) on page 1280.

**Note:** There are many possible system configurations and requirements. These installation steps do not account for all those possibilities so your specific setup and installation steps will vary and Automation Anywhere does not make any warranties that these steps conform with your specific configurations.

To begin the installation:

1. Use Remote Desktop Connection (RDC) to connect to the Control Room server, as an Administrator, and run the Control Room installer.
2. Click **Yes** to start the installer.
3. Click **Next** on the **Welcome to the Setup Wizard** page.
4. Accept the licensing agreement and click **Next**.
5. Select the **Custom** option and click **Next**.
6. Click **Next** to setup the system IPs.  
The **Cluster Configuration** window displays.

Continue with [Customize Control Room installation on Microsoft Azure](#) on page 1283.

## Customize Control Room installation on Microsoft Azure

Install and apply the customized configuration required for the Control Room cluster on Microsoft Azure.

If you have not done so already, complete the initial installation steps in [Begin Control Room installation on Microsoft Azure](#) on page 1282. This task requires the configuration information you gathered in the prerequisites stage. This includes IP addresses, certificates, and credentials for the the Control Room servers, datacenter servers, and databases.

---

**Note:** There are many possible system configurations and requirements. These installation steps do not account for all those possibilities so your specific setup and installation steps will vary and Automation Anywhere does not make any warranties that these steps conform with your specific configurations.

---

**Important:** Automation 360 software components are not compatible with Distributed Resource Scheduling (DRS) and Virtual Migration of Dynamic Processes across hosts. Ensure that you do not enable the corresponding properties of the host virtual machines.

---

To install the Control Room in a cluster setup, do the following steps:

1. Select the **Enable Cluster Setup** check box.  
The check box is enabled by default if the machine on which the setup is being run has local IP addresses configured.  
To install the Control Room on a single node and not a cluster, clear the **Enable Cluster Setup** check box.
2. Enter the IP addresses of the nodes in the cluster.
  - a) Use a comma (,) to specify more than one IP address.  
For example, to specify three IP addresses in the cluster, enter:  
192.0.2.1,192.0.2.2,192.0.2.3

---

**Important:** The first IP address in the list is used as the primary node. Ensure that you enter the IP addresses in the same order on all node configurations in subsequent installations. An incorrect order causes the application to configure the IP addresses as separate clusters, which will result in data loss when the issue is fixed after installation.

---

You can install multiple nodes at the same time after the primary node is initially installed. After installation, you can add a new IP address to the cluster at the end of the list.

- b) After you enter the cluster IP addresses correctly, select a valid address IP at the message prompt to provide network access to the machine.
3. Click **Next** to configure the application Transport Layer Security (TLS).
4. In the **TLS Configuration** page, configure the following:
  - Generate a Self-Signed Certificate  
Enabling the **Self-Signed Certificate** option allows the installer to generate a unique private key and a self-signed certificate for the Control Room.
  - Import a Certificate

To import a custom certificate, clear the **Self Signed Certificate** check box. This setting allows you to import a certificate using the **Certificate Path** field.

---

**Note:** The certificate file must be a PKCS12 format.

---

Provide the following information:

- **Certificate Path:** Click **Browse** to import the certificate.
  - **Private Key Password:** Enter the password for the private key.
- 

**Password limitation:** Do not use the special character (@) in the password as it causes the certificate file import to fail.

---

- **Webserver Port:** Enter the web server port – either HTTP or HTTPS. If the port is already assigned, an error message is displayed.
- 

**Important:** The port validation message is also displayed when you add 8080 for the web server and if that port is already in use for a Control Room license service. Use a different unassigned port in these cases.

---

- **Enable Force HTTP traffic to HTTPS:** This option redirects all HTTP port requests to HTTPS. To access to the Control Room through HTTPS using the generated self-signed certificate, ensure the port numbers are different for HTTP and HTTPS.

To generate a custom certificate for HTTPS, ensure your custom certificate meets the following:

- Create a `.pfx` certificate with a pass code from a CA trusted authority.
- Combine Root, Intermediate, and Machine level certificates into a single certificate.
- Use the format `[WS Machine Host Name].[DomainName].com` for the private key.
- Include the host name as a fully qualified domain name (FQDN) in the certificate.

You provide the host name during Control Room installation.

- In multi-node HA clusters, issue certificates to the load balancer DNS name.
- Add individual URLs, which require access to all nodes, to the `Subject Alternative Name` field in the certificate.

For more information, see Automation Anywhere support site: [Automation 360 On-Premises prerequisites \(A-People login required\)](#).

5. Click **Next** to configure the service credentials.
6. In the **Service Credentials** screen, choose from the listed options.

The Windows Service credentials include a user name and password. The user specified must meet these requirements:

- A member of the local system administrator group.
- Have permission to manage services, including Automation Anywhere services.
- If you use Windows authentication to connect to the SQL database, ensure you grant the `db_owner` permission to the service credential user.

These service credentials allow the Control Room processes to run the required services.

- **Local System Account**—(default) The logged-on user performing the installation

- **Domain Account**—Specify a user that is not the local system account user
    - a) Clear the **Local System Account** check box.
    - b) Enter the user name and password for the domain account.  
Use only supported characters for the user name and password. See [Supported special characters](#) on page 1217.
  - Do not use the Windows domain credentials  
Enter credentials valid for running Automation Anywhere services. Without the valid credentials, the Control Room will fail to launch.
  - PowerShell script restrictions  
Specify a user with permissions to launch PowerShell scripts who is not a Windows domain user. Without the relevant permissions, database table creation can fail.
7. Click **Next** to configure database type and server.
8. Set the connection and authentication for the database server.
- 

**Note:**

- If possible, do not set the value for **Database Server** as **localhost**. If you must use **localhost**, note that the **Secure Connection** to the database will not work.
  - Click **Browse** to select the SQL Server instance where the Control Room database will be created. Alternatively, enter a database server name or select one from the list.
- 

Migration task: If you are migrating from Enterprise 11 to Automation 360, browse to the restored Enterprise 11 database.

Provide the following details:

- a) **Database Port:** Use the default port (1433) or specify a custom value.  
[Configure default database port](#) on page 1257
  - b) **Use Secure Connection:** Select to use a CA certificate as specified.
- 

**Note:** Use the same host name for certificate and database connections.

---

- c) **Certificate:** This option is enabled when you select **Use Secure Connection**. Browse to select a CA certificate.  
[Import HTTPS, intermediate, and CA certificates](#) on page 1387
  - d) **Windows authentication:** This option is selected by default and allows connection to the SQL Server using Windows authentication.
- 

**Note:** If you select Windows authentication, then the user running the installer is used to test that the database exists, create it if required, and grant `db_owner` to the service account user (NT Authority/System).

---

- e) **SQL Server authentication:** Select this option to use SQL Server authentication to connect to the database. Provide the correct user name and password for SQL authentication.  
Use only supported characters for the user name and password. See [Supported special characters](#) on page 1217. Do not use semicolons ( ; ) in the database password.
-

- f) **AD Azure authentication:** Select this option to use Microsoft Azure Active Directory credentials to connect to the database when you install the Control Room on Microsoft Azure
- g) **Name of Control Room database:** Enter the name of the Control Room database.  
Migration task: If you are migrating from Enterprise 11 to Automation 360, enter the name of the restored database in the database field as shown in the following image:

9. Click **Next**.
10. On the **Ready to Install the Program**, click **Install** and allow the installation process to complete.
11. On the **InstallShield Wizard Completed** page, click **Finish**.

Launch Automation Anywhere is enabled by default.

Enable **Show installer settings** to open the `aae-installsummary.html` file. By default, this is located at `C:\Program Files\Automation Anywhere\Enterprise\`. Use this file to view a summary of the installation.

The Control Room launches in your default browser with the Configure Control Room settings page shown. Continue with [Configure settings post-installation on Microsoft Azure](#) on page 1286.

## Configure settings post-installation on Microsoft Azure

After Control Room installation is complete, use the Microsoft Azure Portal to configure the clusters. Use the Azure Portal to configure Windows credentials, Control Room settings for repository and URL, Master Key for Credential Vault, Active Directory authentication, and optionally SMTP settings.

- If you have not done so already, complete the installation steps in [Customize Control Room installation on Microsoft Azure](#) on page 1283.
- The service account user must have read and write access to the Azure data drive (SMB).

**Note:** There are many possible system configurations and requirements. These installation steps do not account for all those possibilities. Therefore, your specific setup and installation steps will vary and Automation Anywhere does not make any warranties that these steps conform with your specific configurations.

---

1. From the Azure Portal where SMB File Share is setup, get the Connection String to retrieve following parameters:
    - Internet or network address
    - User name
    - Password
  2. Locate the Window Credential Manager on the Control Room server and click **Add a Windows Credential**.
  3. Enter the credential information.
- 

**Note:** Adding a user under Windows Credential Manager must be repeated on all the servers used for testing in the cluster environment (Control Room, Clients/Devices).

---

4. Enter information and click **Save and Continue**.  
Repository path is extracted from SMB File Share and Control Room access URL in is a load balancer Public IP.
  5. **Copy** the Master Key and save it (it will be needed to restart the services).
  6. Select Express mode and click **Save and Continue**.
  7. Enter the Active Directory authentication configuration information, including URL, Domain username, and password, then click **Check Connection**. If settings are correct, click **Next**.
  8. Enter the AD user created previously and click **Check name in Active Directory**. Upon validation, click **Save and Log in**.  
Create additional users as needed and create corresponding users in the Control Room.
  9. Optional: Continue with installing other control room nodes in the cluster.
  10. Perform the SMTP registration.
- 

**Note:** A real SSL certificate is recommended for use with deployments.

---

This completes the Control Room installation on Microsoft Azure.

If you see a `Bad Gateway` error message after you install the Control Room in a three-node cluster setup with SO Azure SQL Database, see the following article for troubleshooting steps.

[Automation A360 - Bad Gateway error in a three node cluster setup \(A-people login required\)](#)

Complete the Control Room configuration and validation.

- [Complete Control Room post-installation configuration](#) on page 1315  
After installing the Control Room, complete the configuration settings to ensure timely Automation Anywhere communications are specified and confirm Automation Anywhere services are running.
- [Post-installation user management](#) on page 1371  
After completing the post-installation tasks, validate the setup by logging in to the Control Room and installing a license. First time access to the Control Room walks you through the configuration for your authentication method.

- [Users](#) on page 1737

As a Cloud user with administrator permissions, you can create, view, edit, delete, and enable or disable a user. Creating users steps vary depending on whether the user is a non-Active Directory, Active Directory, or single sign-on (SSO) user from an IdP server.

## Installing Control Room on Google Cloud Platform

Log in to a Google Cloud Platform (GCP) server instance as administrator. Then download and start the Control Room installer and install in Custom mode.

---

**Note:** There are many possible system configurations and requirements. These installation steps do not account for all those possibilities so your specific setup and installation steps will vary and Automation Anywhere does not make any warranties that these steps conform with your specific configurations.

---

1. Complete the prerequisites for installation:
  - Verify [Automation 360 On-Premises prerequisites](#) on page 1180.
  - Ensure that you have the following:
    - Automation Anywhere Control Room installation file
    - TLS certificate
    - License file
2. [Prepare to install Control Room on Google Cloud Platform](#) on page 1289  
Ensure that you complete the required steps to prepare the Google Cloud Platform instances for installing the Control Room.
3. [Perform custom installation of Control Room on Google Cloud Platform](#) on page 1290  
Install and apply the customized configuration required for the Control Room cluster on Google Cloud Platform after completing initial preparations.
4. [Configure Google Cloud Platform settings after installation](#) on page 1293  
After installing the Control Room, configure the required settings on Google Cloud Platform.
5. Complete the Control Room configuration and validation.
  - a) [Complete Control Room post-installation configuration](#) on page 1315  
After installing the Control Room, complete the configuration settings to ensure timely Automation Anywhere communications are specified and confirm Automation Anywhere services are running.
  - b) [Post-installation user management](#) on page 1371  
After completing the post-installation tasks, validate the setup by logging in to the Control Room and installing a license. First time access to the Control Room walks you through the configuration for your authentication method.
6. [Manage your users](#)  
As a Cloud user with administrator permissions, you can create, view, edit, delete, and enable or disable a user. Creating users steps vary depending on whether the user is a non-Active Directory, Active Directory, or single sign-on (SSO) user from an IdP server.



**Tip:** To ensure that the bots run properly in GCP, we recommend that you create a trusted list for the following APIs:

- /v2/repository/files/:id/content
  - /v2/repository/files/public/:id/content
  - /v2/blm/import
- 

## Prepare to install Control Room on Google Cloud Platform

Ensure that you complete the required steps to prepare the Google Cloud Platform instances for installing the Control Room.

1. Configure the Network Security Group of all the servers as specified in the following list:
    - Name: aarestrictedsecuritygroup
    - Type: Ingress
    - Targets: aarestrictedsecuritygroup
    - Filters: IP ranges: List of IP addresses provided by the IT security team
    - Protocols and ports: all
    - Action: Allow
    - Priority: 1000
    - Network: default
- 

**Note:** In the IP address ranges field, enter all the IP addresses of all the virtual machines (VMs) in the cluster environment.

---

2. Set up the F5 load balancer with the following configurations:
  - Select standard as the type option.
  - Enter 0.0.0.0/0 as the Source address in Host.
  - Enter F5-LB-Private IP as the Destination Address/Mask in Host.
  - Enter 80 as the Port and select **HTTP** as the Service Port.
  - Select the **Notify Status to Virtual Address** check box.
  - Enable the load balancer state.

To use SSL offload with the F5 load balancer, provide the SSL certificate at the load balancer level, and configure your Control Room application servers to use HTTP mode only.

---

**Note:** Your IT team should configure the F5 load balancer with the Control Room.

---

3. Set up pools and nodes with the following configurations:
    - a) Update the pool properties:
      - Choose a basic configuration.
      - Select ICMP as your gateway to monitor health.
    - b) Update the pool member options:
      - Choose the round-robin method for load balancing.
-

- Disable the priority group activation.
- c) Update the node properties:
- Change the state to enabled.
  - Select node-specific health monitors.
  - Select ICMP as your gateway to monitor health.
4. Configure the Active Directory server.  
Verify that all the VMs in the cluster can ping each other using private IP addresses.
5. Connect using RDP to one of the Control Room nodes or servers and run the Control Room installer.  
The Installation Prerequisite Check verifies that your system has the basic configurations required for Automation Anywhere. See [Automation 360 On-Premises prerequisites](#) on page 1180.

[Perform custom installation of Control Room on Google Cloud Platform](#) on page 1290

## Perform custom installation of Control Room on Google Cloud Platform

Install and apply the custom configurations required for the Control Room cluster on Google Cloud Platform after completing initial preparations.

Ensure that you complete the preliminary installation steps: [Prepare to install Control Room on Google Cloud Platform](#) on page 1289.

1. Log in to the first Google Cloud Platform instance as an administrator.
2. Download the `Automation Anywhere__<version>.exe` file.  
[A-People Downloads page \(Login required\)](#)
3. Run the installer file.
4. Click **Next** on the **Welcome to the Setup Wizard** page.
5. Accept the license agreement and click **Next**.
6. Select the **Custom** option and click **Next**.  
The **Destination Folder** page appears. By default, the destination folder is `C:\Program Files\Automation Anywhere\Enterprise\`.
7. Optional: To make changes to the destination folder, click **Change**, enter a new destination folder name, and click **OK**.

---

**Note:** Do not install the application directly in the root directory (C:\). Ensure that you create a folder. For example, `C:\Program Files\Automation Anywhere\Enterprise\`.

---

8. Click **Next** to configure the IP cluster.
9. Select the **Enable Cluster Setup** check box.  
The check box is enabled by default if the machine on which the setup is being run has local IP address configured.  
To install the Control Room on a single node and not a cluster, clear the **Enable Cluster Setup** check box.
10. Enter the IP addresses of the nodes in the cluster.

- Enter IPv6 addresses if all the nodes in the network are using IPv6.
- Enter IPv4 addresses if some nodes in the network are using a combination of IPv4 and IPv6 addresses.

- a)** Use a comma (,) to specify more than one IP address.  
For example, to specify three IP addresses in the cluster, enter:  
192.0.2.1,192.0.2.2,192.0.2.3
- 

**Important:** The first IP address in the list is used as the primary node. Ensure that you enter the IP addresses in the same order on all node configurations in subsequent installations. An incorrect order causes the application to configure the IP addresses as separate clusters, which will result in data loss when the issue is fixed after installation.

---

You can install multiple nodes at the same time after installing the primary node.  
After installation, you can add a new IP address to the cluster at the end of the list.

- b)** After you enter the cluster IP addresses correctly, select a valid address IP at the message prompt to provide network access to the machine.

**11.** Click **Next** to configure the application Transport Layer Security (TLS).

**12.** In the **TLS Configuration** page, select one of the following:

- Generate a Self-Signed Certificate

Enabling the **Self-Signed Certificate** option allows the installer to generate a unique private key and a self-signed certificate for the Control Room.

- Import a Certificate

To import a custom certificate, clear the **Self Signed Certificate** check box. This setting allows you to import a certificate using the **Certificate Path** field.

---

**Note:** The certificate file must be a PKCS12 format.

---

Provide the following information:

- **Certificate Path:** Click **Browse** to import the certificate.
  - **Private Key Password:** Enter the password for the private key.
- 

**Password limitation:** Do not use the at sign (@) in passwords. Using the special character @ in the password causes the certificate file import to fail.

---

- **Webserver Port:** Enter the web server port – either HTTP or HTTPS. If the port is already assigned, an error message is displayed.
- 

**Important:** The port validation message is also displayed when you add 8080 for the web server and if that port is already in use for a Control Room license service. Use a different unassigned port in these cases.

---

- **Enable Force HTTP traffic to HTTPS:** This option redirects all HTTP port requests to HTTPS. To access to the Control Room through HTTPS using the generated self-signed certificate, ensure the port numbers are different for HTTP and HTTPS.

To generate a custom certificate for HTTPS, ensure your custom certificate meets the following:

- Create a .pfx certificate with a pass code from a CA trusted authority.

- Combine Root, Intermediate, and Machine level certificates into a single certificate.
- Use the format [WS Machine Host Name].[DomainName].com for the private key.
- Include the host name as a fully qualified domain name (FQDN) in the certificate.  
You provide the host name during Control Room installation.
- In multi-node HA clusters, issue certificates to the load balancer DNS name.
- Add individual URLs, which require access to all nodes, to the Subject `Alternative Name` field in the certificate.

For more information, see Automation Anywhere support site: [Automation 360 On-Premises prerequisites \(A-People login required\)](#).

**13.** Click **Next** to configure the service credentials.

**14.** In the **Service Credentials** screen, choose from the listed options.

The Windows Service credentials include a user name and password. The user specified must meet these requirements:

- A member of the local system administrator group.
- Have permission to manage services, including Automation Anywhere services.
- If you use Windows authentication to connect to the SQL database, ensure you grant the `db_owner` permission to the service credential user.

These service credentials allow the Control Room processes to run the required services.

- **Local System Account**—(default) The logged-on user performing the installation
- **Domain Account**—Specify a user that is not the local system account user

**a)** Clear the **Local System Account** check box.

**b)** Enter the user name and password for the domain account.

Use only supported characters for the user name and password. See [Supported special characters](#) on page 1217.

- Do not use the Windows domain credentials

Enter credentials valid for running Automation Anywhere services. Without the valid credentials, the Control Room will fail to launch.

- PowerShell script restrictions

Specify a user with permissions to launch PowerShell scripts who is not a Windows domain user. Without the relevant permissions, database table creation can fail.

**15.** Add the SQL Server and click **Next**.

Select **Microsoft SQL Server**, enter the name, and click **Next**.

**16.** On the **InstallShield Wizard Completed** page, click **Finish**.

Launch Automation Anywhere is enabled by default.

Enable **Show installer settings** to open the `aae-installsummary.html` file. By default, this is located at `C:\Program Files\Automation Anywhere\Enterprise\`. Use this file to view a summary of the installation.

The Control Room is opened in your default browser and displays the Configure Control Room settings page.

[Configure Google Cloud Platform settings after installation](#) on page 1293

## Configure Google Cloud Platform settings after installation

After installing the Control Room, configure the required settings on Google Cloud Platform.

If you have not done so already, complete the installation steps: [Perform custom installation of Control Room on Google Cloud Platform](#) on page 1290.

1. Configure the following Control Room settings:
  - a) Specify the host name URL by providing the Google Cloud Platform load balancer URL. This is the URL that users use to access the Control Room.
  - b) Select the Active Directory authentication type. See [Configure Control Room for Active Directory: manual mode](#) on page 1375.
2. After you configure the Control Room, install product licenses.
3. Test access to the Control Room using the Google Cloud Platform load balancer URL.

Complete the Control Room configuration and validation.

- [Complete Control Room post-installation configuration](#) on page 1315

After installing the Control Room, complete the configuration settings to ensure timely Automation Anywhere communications are specified and confirm Automation Anywhere services are running.

- [Post-installation user management](#) on page 1371

After completing the post-installation tasks, validate the setup by logging in to the Control Room and installing a license. First time access to the Control Room walks you through the configuration for your authentication method.

- [Users](#) on page 1737

As a Cloud user with administrator permissions, you can create, view, edit, delete, and enable or disable a user. Creating users steps vary depending on whether the user is a non-Active Directory, Active Directory, or single sign-on (SSO) user from an IdP server.

## Installing Control Room on Linux

You start installing the Automation Anywhere Control Room in the Linux environment and complete the installation in the Control Room.

---

**Note:** The installation steps do not list any specific configurations or requirements and therefore your setup might be different. Automation Anywhere does not provide any warranties that the installation steps conform with your system configurations or requirements.

---

This task applies to first-time installation and updates of Automation 360 On-Premises.

---

**Note:** Linux external key vault is not supported on the Automation 360 On-Premises installation.

---

Ensure the following:

- The Microsoft SQL Server or Oracle Server database is installed and running.
- The Automation 360 installation server is connected to the Microsoft SQL Server or Oracle Server database.
- For Oracle Server, ensure that you have installed the appropriate JDBC driver for the Oracle version that is connected to the Control Room.
- From Automation 360 Build 6463, ensure that Python 3.6 is installed.
- For Oracle Server, only non-container database is supported.

**1.** Verify the installation prerequisites.

**a)** Verify the [Automation 360 On-Premises prerequisites](#) on page 1180.

**b)** Depending on the server you want to use, verify that the Microsoft SQL Server or Oracle Server is running, and execute the command:

```
$ sudo systemctl status mssql-server
```

If Microsoft SQL Server is not running, install it.

---

**Note:** The Microsoft SQL Server or Oracle Server installation instructions refer to Red Hat Enterprise Linux version 8. For version 7, change the paths to `/rhel/7` instead of `/rhel/8`.

---

See [Quickstart: Install SQL Server](#).

**c)** Ensure the following files are available:

- SSL certificate
- License file

**d)** Download the `Automation360_e17_Build_<build_number>.bin` installation file to the Linux server from [A-People Downloads page \(Login required\)](#)

---

**Note:** We do not support the patch updates (updating between builds in the same release) in Linux. When you are performing a patch update, we recommend that you always uninstall and do a fresh install of the patch release.

---

**e)** Verify that the installation server has internet access in order to update Linux kernel files and OS libraries using Yum updates.

Alternatively, configure `/etc/yum.conf` on the installation server to use a Yum repository local to its network. The Yum repository should be up to date before starting the installation.

**f)** Starting in Automation 360 Build 6463, Python 3.6 is required.

**2.** Log in to the installation server.

**3.** Run the installer command as a superuser from the Linux shell:

**a)** `$ sudo chmod +x Automation360_e17_Build_<build_number>.bin`

**b)** `$ sudo ./Automation360_e17_Build_<build_number>.bin`

The installation wizard verifies the installation requirements and proceeds with the installation.

---

**Tip:**

- Enter the `back` command to return to a previous command step.
- Press the **return key** to accept default values, or enter an alternate value and then press the **return key**.

- 
4. To accept the license agreement, enter `Y`.
  5. In the **Transport Layer Security (TLS)** screen, configure the following:
    - a) `Control Room HTTP Port` (Default: 80)
    - b) `Control Room HTTPS Port` (Default: 443)
    - c) To enable the `Self Signed Certificate`, enter 1 to enable or enter 2 to disable. When you disable this option, you can install custom certificates.
      1. `Enter Certificate Path`: Enter the certificate path.
      2. `Enter Certificate Password`: Enter the certificate password.
      3. `Use Intermediate Certificates`, enter 1 to enable or enter 2 to disable. When you enable this option, enter the intermediate certificates path in the `Enter path to Intermediate Certificates .zip File` option to install the intermediate certificates.
    - d) `To Force HTTP Traffic to HTTPS`, enter 1 to disable it or enter 2 to enable it.

[Configure application Transport Layer Security](#) on page 1249

6. In the **Cluster Configuration** screen, enter 1 to disable it or enter 2 to enable it.
  - If you choose to enable cluster configuration, enter the IP addresses of the cluster nodes. Use a comma (,) to specify more than one IP address. Do not add space between IP addresses. For example: `192.168.0.1,192.168.0.2,192.168.0.3`
  - The repository location should be a shared location accessible from all Control Room nodes in the cluster.
  - Ensure that you select the IP address that is used to communicate with other nodes of the Control Room.

[Configure IP cluster](#) on page 1261

7. In the **Database Type** screen, select one of the following servers:
  - Microsoft SQL Server
  - Oracle
8. In the **Service Startup Options** screen, select one of the following options:
  - **Default (Start All Services)**: Enables all Control Room services to automatically run at startup.
  - **Custom (Choose Startup Options)**: Enables you to select the Control Room services that you want to automatically run at startup. All the services will be installed on the device. However, only the selected services will automatically run at startup. If required, you can manually start the services that were set to **Manual**.For each service, select one of the following options:
  - **Automatic**: Enables to automatically run the selected service at startup.

- **Manual:** Enables to manually enable the selected service when required.

**Note:**

- Depending on the database type you selected, some services might not be available for selection as some of the services might not yet be supported for the selected database type.
- For those services that you do not include to run at startup when installing the Automation 360 On-Premises Control Room, a `products.notinstalled` file is created in the config files directory that you can open using a text editor. This file includes the name of the services that were not selected when installing the Automation 360 On-Premises Control Room. For information about the directory structure, see [Installed Control Room directories and files](#) on page 1398.

9. Depending on the database server you chose, configure the following settings the server:

Microsoft Database Configuration	Oracle Database Configuration
Database Server address (default: localhost)	Database Server (default: localhost)
Database port (default: 1433)	Database port (default: 1521)
Control Room Database (default: Automation360-Database) or enter a name.	Connect with SID or Service Name  <b>Note:</b> The SID and Service Name entered in the text field provided is unique to your Oracle database.
SQL Server Login credentials: provide the login ID and SQL Server password.	Database User/Schema Password: provide the password.
Password prompt for elasticsearch: Enter or define any password.	(Optional) Use Secure Connection: Enable to use a CA certificate as specified and select a CA certificate.  <b>Note:</b> Use the same host name for certificate and database connections.  <a href="#">Import HTTPS and CA certificates</a>

10. In the **Database Configuration** screen, configure the following:

- Database Server address (default: localhost)
- Database port (default: 1433)
- Control Room Database (default: Automation360-Database) or enter a name.
- SQL Server Login credentials: provide the login ID and SQL Server password.
- Password prompt for elasticsearch: Enter or define any password.



11. Review the pre-installation summary.
12. Press Enter to install Automation 360 in the default directory.

Linux installer	Version	Default directory path
Installation file path	Version .22 and earlier versions	/opt/ automationanywhere/ enterprise
	Updating from earlier versions to version .22	
	New installation of version .22 and later	/opt/ automationanywhere/ automation360

A message appears stating the installation is successfully completed. See [Installed Control Room directories and files](#) on page 1398 for the location of control room assets.

13. Configure the post-installation settings.  
[Configuring post-installation settings](#) on page 1315  
Post-installation, a Control Room group `controlroom` is automatically created. Following users are a part of this group which run the respective Control Room services:  
`crkernel, traefik, ignite, activemq, crelasticsearch, criqbot, crbotinsight, craari, crdiscoverybot, crstorage, crdiscoverybotml.`
14. Verify Automation 360 services started successfully.  
[Stop and start Control Room services on Linux](#) on page 1306
15. Set up Control Room access.  
[Configure Control Room database](#) on page 1384
16. Set up licenses.  
[Installing additional licenses](#) on page 1786
17. The log files for the Control Room installation are available at:

Linux installer	Version	Log file path
Log path	Version .22 and earlier versions	/var/log/ automationanywhere/ enterprise
	Updating from earlier versions to version .22	
	New installation of version .22 and later	/var/log/ automationanywhere/ automation360

After the Control Room installation and configuration is complete, users can register their devices to create and run bots.

[Install Bot Agent and register device](#) on page 1347

For more information on Out of Memory Management (OOM Killer), see [Linux Automation 360 Control Room service stopped \(A-People login required\)](#).

Related tasks

[Performing silent installation of Control Room on Linux](#) on page 1298

Silent Control Room installation, also known as unattended installation, uses a customized script with parameters specific to your business requirements. The entire installation process runs in the background without requiring user interaction or displaying messages.

[Uninstall Automation 360 On-Premises from Linux server](#) on page 1301

Uninstall the On-Premises Control Room from your Linux server.

Related reference

[Installing Control Room On-Premises](#) on page 1177

Review the installation core tasks and topics for installing the Automation 360 Control Room in a data center on an On-Premises server or a cloud service provider server instance.

[Control Room repository requirements](#) on page 1208

The repository location is configured in the Control Room after installation. All your automations are stored in this repository.

## Performing silent installation of Control Room on Linux

Silent Control Room installation, also known as unattended installation, uses a customized script with parameters specific to your business requirements. The entire installation process runs in the background without requiring user interaction or displaying messages.

- Verify you have completed the [Automation 360 On-Premises prerequisites](#) on page 1180.
- Ensure that you have the following:
  - Automation Anywhere Control Room installation file
  - SSL certificate
  - License file
- Verify the installation server has internet access in order to update Linux kernel files and OS libraries using Yum updates. Alternatively, configure `/etc/yum.conf` on the installation server to use a repository local to its network. The repository should be up to date before starting the installation.

Two scripts run the Linux silent installation:

- `LinuxInstaller.sh`: This script contains the installation parameters you want to apply during installation.
- `CallLinuxScript.sh`: This script executes the first script.

See the installation parameters and sample scripts.

Run the script in Linux shell.

1. Review the parameters and identify the settings you require.

Control Room installation parameters		
Installation parameter	Description	Script response options
Proceed with Installation	The installer analyzes your system and notifies you if it does not meet the prerequisites. In silent mode, set the value to 1.	1 = Continue 2 = Cancel

Control Room installation parameters		
Installation parameter	Description	Script response options
Continue setup wizard	The installer displays an introduction and offers options of <code>back</code> to return to a previous step and <code>quit</code> to cancel the installation.  Default is <code>Enter</code> .	<code>\n</code>
Advance to end of License Agreement	In console mode, you have the option to page through the license agreement. In silent mode, you advance to the end by selecting 0.	0
Accept License Agreement	Accept the license agreement to continue with the installation. In silent mode, set the value to Y.	Y = Yes N = No
Control Room HTTP Port	The web server port you will use to access the Control Room with HTTP. The default value is 80.  Replace the number 80 in the sample script to use a different port.	80 = Default port yy = your port number yy
Control Room HTTPS Port	The web server port you will use to access the Control Room with HTTPS. The default value is 443.  Replace the number 443 in the sample script to use a different port.	443 = Default port zzz = your port number zzz
TLS configuration: Self-Signed Certificate	Choose to enable or disable the self-signed certificate. The default is Enable, or 1.	1 = Default (Enable) 2 = Disable
TLS Configuration: Force HTTP traffic to HTTPS	Choose to disable or enable forcing traffic from HTTP to HTTPS. The default is Disable.	1 = Default (Disable) 2 = Enable
Cluster setup	Choose to disable or enable clustering. The default is Disable.	1 = Default (Disable) 2 = Enable

Control Room installation parameters		
Installation parameter	Description	Script response options
Database server URL	server1.yourcompany.com	Enter the URL of the server where the database resides.
Database server port	Default is 1433	1433
Database name	Default is localhost	Default is localhost. If database is on a separate server, enter the host name.
Database SA user name	Database system administrator login ID	Default is sa.
Database SA user password	Database system administrator login ID	The password to log in to your database as system administrator user.
Database Secure Connection	Choose to disable or enable the connection. Default is Disable (1).	1 = Default (Disable) 2 = Enable
Pre-Installation summary	If the output is directed to a console, the installer will show a summary of features selected and whether the prerequisites are met. Default is Enter	\n
Proceed	Confirm to proceed with the installation. Default is Enter.	\n

2. Create the script `LinuxInstaller.sh`, substituting values for your own environment.

**Important:** Be sure to test the connection to the SQL Server and enter verified values for database name, database administrator login ID, database administrator password. Invalid values cause the script to stall and fail.

Example script:

```
echo "Starting Installation"
#Change the next two lines to match the install filename you
downloaded
sudo chmod a+x AutomationAnywhereEnterprise_A2019_e17_4799.bin
sudo ./AutomationAnywhereEnterprise_A2019_e17_4799.bin << EOF
1
\n
0
Y
80
443
1
1
```

```

1
#Change the next line to your Automation Anywhere install server
mybotserver.mycompany.com
1433
#Replace next line with your database name
AAE-Database
#Change the next two lines to your SQL Server admin ID and password
admin
youradminpasswordhere
1
\n
\n
\n
EOF

```

3. Create the script `CallLinuxscript.sh` to execute `Linuxinstaller.sh`. This script writes the installation results to `/home/Installog`. Change the path to the install log file, if required.

```

echo "Starting Linux installation"
sudo ./LinuxInstaller.sh >> /home/Installog
echo "Installation Completed Successfully"

```

4. On the installation server, logged in as an Administrator, execute the scripts.
  - a) `$ sudo chmod a+x LinuxInstaller.sh`
  - b) `$ sudo chmod a+x CallLinuxscript.sh`
  - c) `$ sudo ./CallLinuxscript.sh`
5. Review the installation log to confirm there were no errors.

---

**Note:** The Control Room installation folder on Linux is located by default at `/opt/automationanywhere/enterprise`.

---

Continue from the step [Configure the post-installation settings in Installing Control Room on Linux](#) on page 1293.

## Uninstall Automation 360 On-Premises from Linux server

Uninstall the On-Premises Control Room from your Linux server.

Ensure that the Automation 360 installation server is disconnected from the Microsoft SQL Server database.

1. Log in to the installation server.
2. Run the uninstaller command as a superuser:

```

$ sudo /opt/automationanywhere/enterprise/_Automation\ Anywhere\
Enterprise_installation/Change\ Automation\ Anywhere\ Enterprise\
Installation

```

The installation wizard verifies the installation and proceeds with the uninstallation.

---

### Tip:

- Enter the back command to return to a previous command step.

- Press the **return key** to accept default values, or enter an alternate value then press the **return key**.

### 3. Confirm the uninstallation by entering `Y`.

The Automation 360 components are removed from the Linux system.

The databases with associated Automation 360 information about users and bots remains stored in the database and remain connected to any other Control Room in your cluster.

## Performing silent uninstallation of Control Room on Linux

Use the sample script to perform an unattended uninstallation of Control Room.

Ensure that the Automation 360 installation server is disconnected from the Microsoft SQL Server database.

1. Log in to the installation server.
2. Create a shell script named `LinuxUninstall.sh` that will run the uninstallation process and automatically respond to prompts:

```
sudo /opt/automationanywhere/enterprise/_Automation\ Anywhere\
Enterprise_installation/Change\ Automation\ Anywhere\ Enterprise\
Installation << EOF
\n
1
\n
EOF
```

### 3. Mark the script as executable and run the uninstallation process.

a) `$ sudo chmod a+x LinuxUninstall.sh`

b) `$ sudo ./LinuxUninstall.sh`

The script is executed:

```
=====
Automation Anywhere Enterprise                      (created with
  InstallAnywhere)
-----
Preparing CONSOLE Mode Uninstallation...
=====
Uninstall Automation Anywhere Enterprise
-----
About to uninstall...
```

### 4. When the uninstallation is complete, manually remove any remaining files.

## Configure Control Room in cluster setup with shared repository for Linux

As an RPA platform administrator, you can configure the Control Room in a cluster setup across a shared repository to achieve high availability, load balancing, and disaster recovery.

- Verify whether the prerequisites for on-premises installation are met.  
[Automation 360 On-Premises prerequisites](#) on page 1180
- Ensure that you have the following:
  - Three Linux VMs with RHEL 7.9
  - One Linux VM with Microsoft SQL 2019 connected to a database
  - One load balancer with access to all the nodes
  - One AWS NFS

If one of the Control Room nodes is down, the other nodes maintain continuity of service and manage the load on the server. If a specific node fails, data can be recovered from the other shared nodes on the server.

Perform the following steps to configure the Control Room in a cluster that has three nodes (N1, N2, and N3) using a shared repository.

1. Set up the NFS in AWS.
2. Create a directory in the nodes N1, N2, and N3.  
`/CRRepo/AutomationAnywhere`
3. Run the following commands to grant the read and write permissions to the new directory across all the nodes:
  - a) `sudo chown -R crkernel:controlroom /CRRepo/AutomationAnywhere`
  - b) `sudo chmod -R 775 /CRRepo/AutomationAnywhere`
4. Run the following command in all the three nodes to edit the `fstab` file to mount and map the new directory with NFS.  
`fs-eec88e3f.efs.ap-south-1.amazonaws.com:/ /CRRepo/AutomationAnywhere  
nfs rw,hard,intr,rsize=1048576,wsiz=1048576,timeo=14 0 0`
5. To verify that the remote NFS volume is successfully mounted, reboot nodes N1, N2, and N3, and run the `df -h` command.  
After the share is mounted, the mount point becomes the root directory of the mounted file system.
6. To verify that the NFS is working across the shared repository, create a text file in the `/CRRepo/AutomationAnywhere` directory of node N1.  
You can view the same file in the nodes N2 and N3 directory.
7. Install Control Room in the nodes N1, N2, and N3.  
[Installing Control Room on Linux](#) on page 1293

After Control Room is configured across the shared repository, perform the following steps:

1. Access Control Room through the load balancer URL.
2. Continue with the following steps after the Control Room configuration steps.
  - a) In the Control Room repository path, enter `/CRRepo/AutomationAnywhere`.

- b) In the URL field, enter the load balancer server URL.
  - c) Complete steps required to create an admin user.
3. Verify the Control Room on all the three nodes by navigating to the **Administration > Settings > General tab**.

## Add nodes to a cluster setup for Linux

As an RPA platform administrator, you can add nodes to a cluster for better performance and better load distribution.

Ensure the following:

- Verify the prerequisites for On-Premises installation.  
[Automation 360 On-Premises prerequisites](#) on page 1180
- Ensure that all the primary nodes and databases have backups.
- You must have the IP addresses of all the cluster members for the Control Room server network interfaces used for Elasticsearch communications.

---

**Note:** The Control Room servers can have multiple network interfaces. The server IP addresses must be statically assigned and cannot use the Dynamic Host Configuration Protocol (DHCP).

- If any external load balancers are used in the environment, update them with IP addresses from the new server nodes.
- Ensure that you have administrator or root privileges on the Control Room servers. You must be familiar with installing Control Room in custom mode and also with the related configuration settings.

Adding nodes to a cluster helps you to update the configuration of the nodes in a cluster. You can add nodes to a Control Room cluster setup, change the IP addresses of nodes in the cluster, and monitor the health of the underlying cluster services.

---

**Note:** The minimal number of nodes supported within a Control Room cluster is three. The nodes in a cluster synchronize with each other over a local network. All the nodes in a cluster connect to the same database.

---

Perform the following steps to add three nodes (N4, N5, and N6) to a cluster that has three nodes (N1, N2, and N3).

1. On node N4, run the installer command as a superuser from the Linux shell:  

```
$ sudo ./Automation360_e17_Build_<build_number>.bin
```
2. Proceed through the installer to the cluster configuration.
  - a) Select **Enable Cluster Setup**.
  - b) In the **Cluster IP addresses** box, enter the IP addresses of all the nodes that you need to configure in the cluster.

```
172.31.30.120, 172.31.21.216, 172.31.17.110, 172.31.20.242,  
172.31.17.149, 172.31.18.37
```

---

**Note:** The IP addresses must be entered in the same sequence on every node.

3. Complete the remaining steps to install Control Room.



[Installing Control Room on Linux](#) on page 1293

4. Repeat the steps 1 on page 1304 through 3 on page 1304 for nodes N5 and N6.
5. Add the complete set of IP addresses for all the nodes in the older nodes N1, N2, and N3.  
Restart the nodes, one at a time.
6. To verify the health of the cluster, run the following commands in the command line:
  - a) `curl -k --user es_client:<es password> https://172.31.30.120:47599/_cat/nodes`  
The primary node is indicated by an asterisk character (\*).
  - b) Verify that the IP address of the primary node is the same as the one mentioned in the `elasticsearch.yml` file for all the nodes.
  - c) `curl -k --user es_client:<es password> https://172.31.30.120:47599/_cat/health?pretty`

You must wait until the replication status turns green. The replication time varies depending on the data load in the clusters. The replication status turns green when the cluster is fully synchronized.

## Remove nodes from a cluster setup for Linux

As an RPA platform administrator, you can remove nodes from a Control Room cluster setup to replace or update them for enhanced performance.

Ensure the following:

- Verify that all the primary nodes and databases have backups.
- Ensure that you have administrator or root privileges on the Control Room servers.

Perform the following steps to remove three nodes (N1, N2, and N3) from a cluster that has six nodes (N1, N2, N3, N4, N5, and N6).

1. Run the following command in the Linux shell to identify the primary node.  
`curl -k --user es_client:Automation123 https://172.31.46.2:47599/_cat/nodes`
2. Remove the non-primary nodes N2 and N3 from the cluster.
  - a) Log in to the server as an administrator and run the following command to stop all the Control Room services.  
`sudo systemctl stop controlroom*`
  - b) Log in to any of the non-primary nodes.
  - c) Edit the `cluster.properties` file located at `/opt/automationanywhere/automation360/config`.
  - d) Remove the IP addresses for the original three nodes.

---

**Note:** Perform this action for all the nodes in the cluster. When you remove the IP addresses of the original three nodes, do not change their sequence.

---

- e) Edit the `elasticsearch.yml` file at `/opt/automationanywhere/automation360/elasticsearch/config`.
- f) Remove the old IP addresses from the list in the `discovery.zen.ping.unicast.hosts` attribute.



This sample script lists the Control Room services that need to be restarted. You can restart the services in any sequence.

The `sleep` commands allow each service to complete startup before the next service is started.

---

**Note:** `controlroomdiscoverybot.service` is only installed by default starting in Automation 360 version 16.

---

```
echo Starting elasticsearch
sudo systemctl start controlroomelasticsearch.service
sleep 30
echo Starting botcompiler
sudo systemctl start controlroombotcompiler.service
sleep 30
echo Starting control room caching
sudo systemctl start controlroomcaching.service
sleep 30
echo Starting backend service
sudo systemctl start controlroombackend.service
sleep 30
echo Starting reverse proxy
sudo systemctl start controlroomreverseproxy.service
sleep 30
echo Starting messaging
sudo systemctl start controlroommessaging.service
sleep 30
echo Starting iq bot
sudo systemctl start controlroomiqbot.service
sleep 30
echo Starting discovery bot
sudo systemctl start controlroomdiscoverybot.service
sleep 30
echo Starting aari
sudo systemctl start controlroomaari.service
sleep 30
echo Starting storage
sudo systemctl start controlroomstorage.service
sleep 30
echo Starting ml services
sudo systemctl start controlroomdiscoverybotml.service
sleep 30
```

Assign execute permission to the script and run it: `sudo ./startallaae.sh`

3. To stop a single service, use the following command: `sudo systemctl stop <servicename>`.

Optional: To stop all services for maintenance or other requirements, create a script, such as `stopallaae.sh`, to stop the Control Room services.

```
sudo systemctl stop controlroommessaging.service
sudo systemctl stop controlroomreverseproxy.service
sudo systemctl stop controlroombackend.service
sudo systemctl stop controlroomcaching.service
sudo systemctl stop controlroombotcompiler.service
sudo systemctl stop controlroomelasticsearch.service
sudo systemctl stop controlroomiqbot.service
sudo systemctl stop controlroomdiscoverybot.service
```

```
sudo systemctl stop controlroomaari.service
sudo systemctl stop controlroomstorage.service
sudo systemctl stop controlroomdiscoverybotml.service
```

Assign execute permissions to the script and run it: `sudo ./stopallaae.sh`

## Installing Control Room on Microsoft Windows Server using scripts

Silent Control Room installation, also known as unattended installation, uses a customized script for a full setup or an update setup. Silent installation runs the entire installation process in the background, without requiring user interaction or displaying messages.

To perform the task, you must have a administrator account with the required rights and permissions.

- Disable the User Access Control (UAC) on host VM for Control Room.
- Verify [Automation 360 On-Premises prerequisites](#) on page 1180.
- Ensure that you have the following:
  - Automation Anywhere Control Room installation file
  - TLS certificate
  - License file
- Create a Powershell script.
  - See the installation parameters and sample scripts.
- Run the script in Powershell.

**Note:** For instructions on performing silent install and configuration of Automation 360 separately, see [.Silent installation and configuration of Automation 360 using scripts \(A-People login required\)](#).

1. Review the parameters and identify the settings you require.
  - Control Room installation parameters

Variable name	Description
AA_CRCLUSTERCONFIG	if AA_SETCLUSTERMODE=1 then cluster IP comma separated
AA_CRDBPORT	Control Room database port. Default value is 1433
AA_CRDBSSLMODE	Secure SQL connection
AA_CRFORCEHTTPSCONFIG=" "	--
AA_CRFORCETOHTTPS="1"	Force traffic from HTTP to HTTPS
AA_CRHTTPPORT	Control Room HTTP port. Default is 5432

Variable name	Description
AA_CRHTTPSPT	Control Room HTTPS port
AA_CRLISTENPORT	Web server port. Default value is 80
AA_CRSERVICECONFIRMPASSWD	If AA_CRSETLOCALSERVICECRED=0, then confirm password
AA_CRSERVICEPASSWD	If AA_CRSETLOCALSERVICECRED=0, then confirm password
AA_CRSERVICEUSERNAME	if AA_CRSETLOCALSERVICECRED=0, then add domain\user name
AA_CRSETLOCALSERVICECRED	<ul style="list-style-type: none"> <li>1 if service logon as System</li> <li>0 if service logon as specific user</li> </ul>
AA_CRWCCERTPASSWD	Certificate password
AA_CRSELFSIGNCERT	1 for self-signed certificate
AA_CRWCCERTPATH	Certificate path
AA_SDSFEATURE	<ul style="list-style-type: none"> <li>true=Cloud deployment type</li> <li>false=On-Premises deployment type</li> </ul>
AA_SETCLUSTERMODE	For cluster set 1, otherwise 0
AA_SETUPTYPE	Setup type Custom or Express
INSTALLDIR	Installation Directory
IS_SQLSERVER_AUTHENTICATION	<ul style="list-style-type: none"> <li>0 for Windows authentication</li> <li>1 for SQL authentication</li> <li>2 for Azure AD authentication</li> </ul>
IS_SQLSERVER_DATABASE	SQL database name
IS_SQLSERVER_SERVER	SQL server name (host name)

**Note:** These are optional Control Room service parameters that can be used based on your requirement:

- AA\_STARTSERVICE\_AARI
- AA\_STARTSERVICE\_STORAGE
- AA\_STARTSERVICE\_IQBOT
- AA\_STARTSERVICE\_DISCOVERYBOT
- AA\_STARTSERVICE\_DISCOVERYBOTML

For information on selecting the services to run at startup, see [Select Control Room services to automatically run at startup](#) on page 1253.

- OpenSearch related parameters

**Note:** Starting from Automation 360 v.28 release (Build 17593), the Elasticsearch service is replaced with OpenSearch service as the underlying technology for core product capabilities such as audit, Bot Insight, and so on.

Parameter	Description
AA_ELASTICSEARCH_BACKUP	Used only if installing on the first node of a backup server. Enter 1 if yes.  <b>Note:</b> The AA_ELASTICSEARCH_BACKUP parameter is used when you install an Control Room as backup server for audit.
AA_ELASTICSEARCHSYSIP	Valid IP address
AA_ESPASSWD	Password for Elasticsearch  <b>Note:</b> An additional parameter for confirming the password is not available. The password must have a minimum of 6 characters.

- Key-vault related parameters

Parameter	Description
AA_KEYVAULTTYPE	Enter any of the following: <ul style="list-style-type: none"> <li>• NONE if you do not want to define a key vault</li> <li>• AWSS for AWS Secrets Manager</li> <li>• CARK for CyberArk</li> </ul>
IS_SQLSERVER_AUTHENTICATION	Enter any of the following: <ul style="list-style-type: none"> <li>• 0 if SQL server authentication is not set</li> <li>• 1 if SQL server authentication is set</li> </ul>

Parameter	Description
IS_SQLSERVER_EKVAUTHENTICATION	Use this if the SQL server authentication is configured for an external key vault. Enter any of the following: <ul style="list-style-type: none"> <li>0 if SQL server authentication does not use an external key vault</li> <li>1 if SQL server authentication for a key vault is configured for CyberArk</li> <li>2 if SQL server authentication for a key vault is configured for AWS Secrets Manager</li> </ul>
AA_CRSERVICECREDTYPE	Enter any of the following: <ul style="list-style-type: none"> <li>LOCAL if the Control Room database uses local authentication.</li> <li>SERVICE if the Control Room database uses custom authentication.</li> <li>SERVICEEKV if the Control Room database uses external key vault for authentication.</li> </ul>
AWS Secrets Manager key vault parameters	
AA_AWSSREGION	AWS region
AA_DBAUTHAWSSECRET	AWS sqllogin secret
AA_CRSEVAWSSECRET	AWS service secret
CyberArk key vault parameters	
AA_CARKAPPID	CyberArk app ID
AA_CARKCERTIFICATE	Full certificate filename with path
AA_CARKOPTIONALCERT	Optional certificate filename with path
AA_CARKCERTPASSPHRASE	Certificate passphrase
AA_CARKVAULTURL	CyberArk URL
AA_DBAUTHCARKOBJECTNAME	CyberArk sqllogin object name
AA_DBAUTHCARKSAFENAME	CyberArk sqllogin safe name
AA_CRSEVRCARKOBJECTNAME	CyberArk service credential
AA_CRSEVRCARKSAFENAME	CyberArk service locker

- IPv6-related parameters

Parameter	Description
AA_IPV6ENABLED	Enter 1 to enable IPv6 addresses To disable IPv6 addresses, do not enter the parameter.

**2.** Optional: Edit the sample script to use a Microsoft SQL Server database.

Use the script to install the Control Room with the configuration options available in the installer.

- a) Correct values for variables such as `$service_username`, `$service_pwd`, `$db_server`, `$cr_port`.
- b) Run the script with Credentials in Service logon, and a non-secure connection using Microsoft SQL Server authentication with a new database.

Sample script:

```
$cr_port=80

$service_username= "domain\username" #e.g."aaspl-brd\ellie.brown"
$service_pwd="password"

#$certpath = "C:\SilentInstall\test256.pfx"
#$certpass = "changeit"

$db_server="localhost"
$cr_db_name="CRDB-NEW-SI-3"
$db_user="sa"
$db_pwd="Admin@123"

$elastic_password="Test@123"

$installation_path="C:\Program Files\Automation Anywhere"

#Install latest setup
$static_installation_path="\Enterprise\*****"
$silent_details=" /s ", "v***** -join "/"
$installpath_details=" /qn INSTALLDIR=*****"

$deployment_details=" /AA_SDSFEATURE=true"

$custom_details=" /vAA_SETUPTYPE=Custom
                 /vAA_CUSTOMMODETYPE=1"

$port_cluster_details=" /vAA_SETCLUSTERMODE=0
                      /vAA_CRLISTENPORT=$cr_port"

#$service_details=" /vAA_CRSETLOCALSERVICECRED=0
                  /vAA_CRSERVICEUSERNAME=$service_username
                  /vAA_CRSERVICEPASSWD=$service_pwd
                  /vAA_CRSERVICECONFIRMPASSWD=$service_pwd"

$service_details=" /vAA_CRSETLOCALSERVICECRED=1"

#$service_selections (The below parameter is optional and must be
used if you want to selectively install the services. To install
```



```

any specific service, set the value to 1 or remove that specific
service from the below parameter.)
$service_selections=" /vAA_STARTSERVICE_IQBOT=0 /
vAA_STARTSERVICE_AARI=0 /vAA_STARTSERVICE_STORAGE=0 /
vAA_STARTSERVICE_DISCOVERYBOT=0 /vAA_STARTSERVICE_DISCOVERYBOTML=0"

#$db_details=" /vAA_BIMETADATADBTYPE=AA_BIMETADATADBTYPE
/vIS_SQLSERVER_SERVER=$db_server
/vIS_SQLSERVER_DATABASE=$cr_db_name
/vIS_SQLSERVER_DATABASE1=$bi_db_name"

$db_details=" /vIS_SQLSERVER_SERVER=$db_server
/vIS_SQLSERVER_USERNAME=$db_user
/vIS_SQLSERVER_PASSWORD=$db_pwd
/vIS_SQLSERVER_DATABASE=$cr_db_name
/vIS_SQLSERVER_AUTHENTICATION=1"

$other=" /vAA_ESPASSWD=$elastic_password
/vAA_CRWCHTTPPORT=80
/vAA_CRWCHTTPSPORT=443
/vAA_CRSELFSIGNCERT=1
/vAA_OPTIONALCACERT=0
/vAA_CRWCCERTPATH=$certpath
/vAA_CRWCCERTPASSWD=$certpass
/vLAUNCHPROGRAM=1
/v""
/LIweamoruc! log.txt""

#Ensure that you remove the $service_selection parameter from the
$final_command line if $service_selection is not used.
$final_commandline = -join($silent_details,
$installpath_details,$installation_path,
$static_installation_path,$custom_details,
$port_cluster_details,$service_details,$service_selections,
$db_details,$pg_details,$other)

Write-Host $final_commandline
$a=Get-ChildItem $PSScriptRoot\* -Include *.exe
#$a = "C:\Silent\AutomationAnywhereEnterprise_A2019_<build>.exe"

Write-Host $a
Write-Host "Starting the installation wait for sometime..."

$processdetail=(Start-Process -FilePath
$a -ArgumentList $final_commandline
-Wait -PassThru).ExitCode

Write-Host $a.Name execution is done.
If installation is not proper check msi logs in the temp folder.
pause

```

**Note:** When using Windows authentication for connecting to Microsoft SQL Server database, ensure that the following settings are configured:

- The IS\_SQLSERVER\_AUTHENTICATION installation parameter should be set to 0
- The user assigned to the \$service\_username parameter should be an active user in Microsoft SQL Server with permissions set as: db\_datareader, db\_datawriter, and db\_ddladmin

- The \$db\_user and \$db\_pwd parameter values should be disabled or commented out

3. Save the script you edit to the server for installation.
4. On the installation server, log on as an administrator, open Powershell in admin mode, and execute the following: `Set-ExecutionPolicy Unrestricted -Scope CurrentUser -Force`
5. Start Powershell in admin mode and execute: `.\install.ps1`

---

**Note:** The silent installation logs are stored in the folder from which the installation script is executed. For example, if you run the script from `C:\Silent Install`, the logs are stored in `C:\Silent Install` folder.

---

Complete the Control Room configuration and validation.

- After installing the Control Room, complete the configuration settings to ensure timely Automation Anywhere communications are specified and confirm Automation Anywhere services are running.
- After completing the post-installation tasks, validate the setup by logging in to the Control Room and installing a license. First time access to the Control Room walks you through the configuration for your authentication method.
- As a Cloud user with administrator permissions, you can create, view, edit, delete, and enable or disable a user. Creating users steps vary depending on whether the user is a non-Active Directory, Active Directory, or single sign-on (SSO) user from an IdP server.

Related concepts

[Post-installation user management](#) on page 1371

After completing the post-installation tasks, validate the setup by logging in to the Control Room and installing a license. First time access to the Control Room walks you through the configuration for your authentication method.

Related tasks

[Complete Control Room post-installation configuration](#) on page 1315

After installing the Control Room, complete the configuration settings to ensure timely Automation Anywhere communications are specified and confirm Automation Anywhere services are running.

[Performing silent installation of Control Room on Linux](#) on page 1298

Silent Control Room installation, also known as unattended installation, uses a customized script with parameters specific to your business requirements. The entire installation process runs in the background without requiring user interaction or displaying messages.

Related reference

[Users](#) on page 1737

As an administrator, you can create, view, edit, delete, and enable or disable a user. Creating users steps vary depending on whether the user is a non-Active Directory, Active Directory, or single sign-on (SSO) user from an IdP server.

## Complete Control Room post-installation configuration

After installing the Control Room, complete the configuration settings to ensure timely Automation Anywhere communications are specified and confirm Automation Anywhere services are running.

1. [Configure post-installation settings](#)

After installing the Control Room, complete the configuration settings to ensure timely Automation Anywhere communications are specified and confirm Automation Anywhere services are running.

2. [Verify Automation Anywhere services](#)

Automation Anywhere specific services are installed on the Control Room server.

3. [Change Control Room configuration to HTTPS from HTTP mode](#) on page 1386

Configure Control Room for HTTPS mode using a self-signed or CA certificate either before or after performing a custom Control Room configuration.

4. [Import HTTPS, intermediate, and CA certificates](#) on page 1387

After installing the Control Room, import a certificate for HTTPS, Certificate Authority (CA), or both using the Windows or Linux command prompt.

5. [Configure disaster recovery site for OpenSearch IP addresses](#) on page 1319

If you have configured the Control Room for high availability (HA) and disaster recovery (DR) and installed the Control Room on both the primary and secondary sites, configure Elasticsearch IP addresses for the secondary site.

6. [Add primary IP address for cluster](#) on page 1320

If your Control Room server has dual IP addresses or network interface cards (NICs) and you configure the second NIC as your backup IP address, you must manually update the `cluster.properties` file to include the backup IP address.

7. [Configure additional IP address for a new cluster node](#) on page 1321

After installing the Control Room in the cluster node, when you add new nodes in the cluster, you must configure additional static IP addresses for all the nodes in the property file on each node in the cluster.

## Configuring post-installation settings

After you have installed the Control Room, configure specific items to ensure timely Automation Anywhere communications.

### Post-installation tasks and settings

Exclude anti-virus

Exclude anti-virus scans from running in the Automation Anywhere local repository because they interfere with running bots.

By default, the repository path is `C:\ProgramData\AutomationAnywhere`

## Set the language locale

`\Server Files`. If you have modified the repository path after installation, you can verify the path from **Administration > Settings > Control Room database & software**.

Select your language as the region setting.

The following example uses English (United States) as the region setting.

- Windows: Select **Control Panel > Region > Administrative > Change system locale**.

For usernames that contain non-ASCII characters, update the following settings:

1. From **Control Panel > Clock and Region > Administrative > Change system locale**, select the required language from the **Current system locale** list.
2. If available, clear the **Beta: Use Unicode UTF-8 for worldwide language support** check box.
3. To change the code page identifier, enter `chcp <identifier-code>` at the command prompt. For example, enter `chcp 949` to use ANSI or OEM Korean (Unified Hangul Code).

[Code Page Identifiers](#)

4. Restart your machine.

- Linux

1. Verify the current locale:

```
$ locale
```

2. Display a list of all available locales on the server:

```
$ locale -a
```

3. Depending on your operating system, use one of these options to set the locale for the whole server with the LANG variable.

Substitute language `en_US.UTF-8` with your own:

```
Ubuntu: sudo update-locale  
LANG=en_US.UTF-8 LANGUAGE
```

```
Red Hat Enterprise Linux: sudo  
localectl set-locale  
LANG=en_US.UTF-8
```

4. Update either the global locale settings file `etc/locale.conf` or settings / `~/.bash_profile` for the user that owns Automation 360:

```
LANG="en_US.utf8"
export LANG
```

Set the region

Select your language as the region format.  
Windows: Select **Control Panel > Region > Format**.

Set time synchronization

Enable Network Time Protocol (NTP) on the Control Room .

For additional information about setting the NTP, contact your system administrator.

For Microsoft Azure platform installation, set configuration

Use the Microsoft Azure Portal to configure:

- Windows credentials
- Control Room settings for repository, URL, and Master Key for Credential Vault
- Microsoft Active Directory authentication
- Optionally, SMTP settings

Related tasks

[Complete Control Room post-installation configuration](#) on page 1315

After installing the Control Room, complete the configuration settings to ensure timely Automation Anywhere communications are specified and confirm Automation Anywhere services are running.

Related reference

[Verifying Automation Anywhere services](#) on page 1317

Verify the various Automation Anywhere specific services that are installed on the Control Room server.

[Working with SQL Servers](#) on page 1192

Configure Microsoft SQL Servers before setting up the Control Room database.

## Verifying Automation Anywhere services

Verify the various Automation Anywhere specific services that are installed on the Control Room server.

---

**Linux users:** See [Stop and start Control Room services on Linux](#) on page 1306.

---

## Verify installed Windows services

From your Windows device:

1. Select **Control Panel > Administrator Tools > Services**.

The specific path to **Services** can vary, depending on your specific Windows version.

2. Scroll through the list to find the listed service name. Note the **Status** should show as running.

## Control Room installed services

Verify that the following Windows services are installed by the Automation Anywhere Control Room installer.

Service name	Description
Automation Anywhere Bot Compiler Service	Stores all details about the bot compile service. Receives and processes Bot compilation requests for the Control Room.
Automation Anywhere Control Room Caching	Used for distributed cache storage.
Automation Anywhere Control Room IQ Bot Service	Used for Automation 360 IQ Bot.
Automation Anywhere Control Room Messaging	Allows Control Room services to communicate asynchronously.
Automation Anywhere Control Room Reverse Proxy	Receives all incoming HTTP and HTTPS requests for Automation Anywhere products and forwards to the correct service.
Automation Anywhere Control Room Robotic Interface Service	Is the Automation Co-Pilot for Business Users (Automation Co-Pilot) service used to create and orchestrate workflows between forms and bots.
Automation Anywhere Control Room Service	Receives and processes API requests for the Control Room.
Automation Anywhere Elastic Search Service	Stores all logs and related activities for search functionality. For details about Elasticsearch, see <a href="#">Elastic Stack and Product Documentation</a> .
Automation Anywhere Control Room Discovery Bot Service	Used for Discovery Bot.

Service name	Description
Automation Anywhere Control Room Discovery Bot ML Service	Used to launch Discovery Bot from Control Room.  <b>Note:</b> If the Automation Anywhere Control Room Discovery Bot ML Service does not start during installation, you must update Windows Server 12 with the Microsoft patch. For more details, see <a href="#">Update for Universal C Runtime in Windows</a> .
Automation Anywhere Control Room Storage Service	Used for uploading and accessing files in Automation Co-Pilot and Document Automation. This service is used to manage the lifecycle of the files that are uploaded to Control Room.  Depending on the environment that the Automation 360 deployment is on, Automation Anywhere Control Room Storage Service is supported in Amazon Simple Storage Service (Amazon S3), Google Cloud Platform, and Network File System (On-Premises).

- All the services can be configured either in the Local System or Domain account when the Control Room is installed in Custom mode. For a Control Room installed in Express mode, all the services are run in the Local System account.
- By default, the Automation Anywhere Control Room services restart automatically after a system reboot. You do not need a windows service start-up script to restart the services.
- We recommend you wait for two (2) minutes for the Automation Anywhere Control Room services to restart after a system reboot. If the services do not start automatically, you will see the `Bad gateway` error. You can restart the services manually in any sequence.
- Running Automation Workspace services is mandatory for using the Automation Workspace platform. However, running the Automation Co-Pilot, Discovery Bot, and IQ Bot services is optional for Automation Workspace platform.

#### Related concepts

[Installing Control Room using Custom mode](#) on page 1245

Log in to the server as an administrator and install Automation Anywhere Control Room in Custom mode to select installation and configuration options, including installing non-default requirements. Select this mode for a data center deployment.

#### Related tasks

[Installing Control Room using Express mode](#) on page 1270

[Installing Control Room on Linux](#) on page 1293

You start installing the Automation Anywhere Control Room in the Linux environment and complete the installation in the Control Room.

## Configure disaster recovery site for OpenSearch IP addresses

If you have configured the Control Room for high availability (HA) and disaster recovery (DR) and installed the Control Room on both the primary and secondary sites, configure OpenSearch IP addresses for the secondary site.

Ensure that you are logged in to the as the administrator.

Complete the Control Room installation on both the primary and secondary DR sites.

Before adding a new node, ensure the existing cluster is in yellow or green state and all ports on the new node are open.

---

**Note:** Starting from Automation 360 v.28 release (Build 17593), the Elasticsearch service is replaced with OpenSearch service as the underlying technology for core product capabilities such as audit, Bot Insight, and so on.

---

Perform this task to make the IP address of the secondary DR site OpenSearch available to the primary DR site.

1. From the primary site Control Room, navigate to **Administration > Settings > General > Control Room Database & Software**.
2. Click **Edit**.
3. Enter the DR secondary site **Cluster IP address** in the **Elasticsearch disaster recovery backup cluster** field.
4. Click the plus sign to add additional cluster IP addresses.
5. Click **Save Changes**.

Related concepts

[High availability deployment](#) on page 1235

To support Automation 360 in your data center, configure an high availability (HA) cluster. Follow your company methods and procedures for implementing your data center cluster.

Related tasks

[Warm stand-by](#) on page 1240

Host two setups or sites - primary and backup for the warm stand-by DR procedure.

## Add primary IP address for cluster

If your Control Room server has multiple IP addresses or network interface cards (NICs), you can manually update the `cluster.properties` file to include the primary IP address.

To perform the task, you must have a administrator account with the required rights and permissions.

- Ensure you have the view and manage settings permission.
- Complete the Control Room installation.
- Updating the `cluster.properties` file requires a downtime, so ensure a maintenance window for the following:
  - All the user devices will be disconnected.
  - No schedules will run during maintenance.
  - Bot Agent and Automation Anywhere Control Room will not be accessible.

Update the `cluster.properties` file to ensure the caching service requirement to define a single IP address for the primary NIC of the Control Room.

Ensure that you complete these tasks on all the Control Room nodes in a high availability cluster.

1. Locate the `cluster.properties` file in your Control Room directory.  
For example, the default location is: `C:\Program Files\Automation Anywhere\Enterprise\config\`



If the file does not exist in your Control Room directory, create the file.

2. Add the following property option to the `cluster.properties` file:  
`ignite.local.static.ip=<nic_ip_address>`  
For example, `ignite.local.static.ip=172.16.20.168`

---

**Note:** The `ignite.local.static.ip` property is configured with a single IP address of the primary NIC of the Control Room with which the communication between the Control Room nodes is expected. You can manually reconfigure the property when more than one IP address is available.

---

3. Save the `cluster.properties` file.
4. Restart the following Automation Anywhere Windows services:
  - a) Automation Anywhere Control Room Caching
  - b) Automation Anywhere Control Room Messaging
  - c) Automation Anywhere Control Room Service
5. To ensure all the cache is in sync, restart the rest of the Automation Anywhere Windows services.

## Configure additional IP address for a new cluster node

After installing the Control Room in the cluster node, if you add new nodes in the cluster, you have to configure additional static IP addresses for all the nodes in the property file on each node in the cluster.

To perform the task, you must have a administrator account with the required rights and permissions.

- Ensure that you have a maintenance window, which requires complete downtime for the following:
  - All the user devices will be disconnected.
  - No schedules will run during maintenance.
  - Bot Agent and Automation Anywhere Control Room will not be accessible.
- Complete the Control Room installation on any new node.

Perform the following steps on each node in the cluster:

1. Stop the following Automation Anywhere services on the Control Room node:
  - a) Automation Anywhere Control Room Reverse Proxy
  - b) Automation Anywhere Control Room Caching
  - c) Automation Anywhere Control Room Service
  - d) Automation Anywhere Elastic Search Service
  - e) Automation Anywhere Bot Insight Elastic Search
  - f) Automation Anywhere Control Room IQ Bot Service
  - g) Automation Anywhere Control Room Robotic Interface Service
  - h) Automation Anywhere Control Room Discovery Bot Service

2. Locate the `cluster.properties` file in your Control Room directory.  
For example, the default location is: `C:\Program Files\Automation Anywhere\Enterprise\config\`  
If the file does not exist in your Control Room directory, create the file.
3. Add the following properties and configure the primary IP addresses as a static IP address for all the cluster nodes (including existing cluster nodes) in the `cluster.properties` file.

```
ignite.discovery.mode=static
ignite.discovery.static.ips=<primary ip addresses>
```

For example: `ignite.discovery.static.ips=10.0.11.153,10.0.11.13`

4. If the nodes have multiple IP addresses, also add the following property and configure a specific primary IP address on each node in the cluster:

```
ignite.local.static.ip=<primary ip address>
```

For example: `ignite.local.static.ip=10.0.11.153`

5. Save the `cluster.properties` file.
6. Modify the `elasticsearch.yml` file for the new IP address:
  - a) Locate the `elasticsearch.yml` file in the Control Room directory.  
For example, the default location is: `C:\Program Files\Automation Anywhere\Enterprise\elasticsearch\config\elasticsearch.yml`
  - b) Update `elasticsearch.yml` with the new IP address using the following property:  
`discovery.zen.ping.unicast.hosts:["ip1","ip2","ip-new"]`
  - c) Save the `elasticsearch.yml` file.

---

**Note:** Starting from Automation 360 v.28 release (Build 17593), the Elasticsearch service is replaced with OpenSearch service as the underlying technology for core product capabilities such as audit, Bot Insight, and so on.

---

7. Start all the services that were stopped in Step 1 on each Control Room node.

---

**Note:** Wait for an interval of 40 seconds before starting the next service.

---

## Add service URLs to trusted list for On-Premises

For On-Premises deployment, to ensure secure access to Automation 360 online services, add service URL list to the safe recipients or trusted list.

### URL list

Online service hosting uses dynamic IP addresses, therefore we recommend that you add to the safe recipients or trusted list, the complete URL instead of an IP address for the Automation Anywhere online services.

---

**Note:** Add the URLs to trusted list only for On-Premises deployments that are connected to the internet.

---

Service	URL	Port	Devices
Automation Anywhere	www.automationanywhere.com	TCP 443 (HTTPS)	All devices
Automatic download of newly released package versions for On-Premises Control Room	https://aai-artifacts.my.automationanywhere.com	TCP 443 (HTTPS)	All Control Room nodes
Automation Anywhere community (A-People)	apeople.automationanywhere.com	TCP 443 (HTTPS)	All devices
Automation Anywhere documentation	docs.automationanywhere.com	TCP 443 (HTTPS)	All devices
Automation Anywhere Cloud license server	license.automationanywhere.com (192.124.249.160: Add this URL or IP address to the safe recipients list in the outbound direction so that the Control Room can now securely connect to the Cloud license server.  The Control Room is capable of connecting to the Cloud license server using your network proxy. For more information, see <a href="#">Configure forward proxy settings</a> on page 1812.)	TCP 443 (HTTPS)	All devices that run Automation 360 Control Room
Bot Store	botstore.automationanywhere.com	TCP 443 (HTTPS)	All devices
Telemetry  Allows performance and usage information to be gathered anonymously in order to improve product quality.  For more information, see <a href="#">Usage statistics</a> on page 1835	<ul style="list-style-type: none"> <li>cdn.pendo.io</li> <li>app.pendo.io/</li> <li>data.pendo.io/</li> <li>https://pendo-static-5673999629942784.storage.googleapis.com/</li> </ul>	TCP 443 (HTTPS)	All devices
Automation Anywhere Google Chrome extension  Enables you to automate using the Google Chrome browser.	https://chrome.google.com/webstore/detail/automation-360/kammdlphdfejllopponbapppbgakimokm	TCP 443 (HTTPS)	Bot Creator and Bot Runner devices

Service	URL	Port	Devices
Automation Anywhere Microsoft Edge extension Enables you to automate using the Microsoft Edge browser.	<a href="https://microsoftedge.microsoft.com/addons/detail/automation-360/dbmodiepejcg1jbmeebedkmegndokbk">https://microsoftedge.microsoft.com/addons/detail/automation-360/dbmodiepejcg1jbmeebedkmegndokbk</a>	TCP 443 (HTTPS)	Bot Creator and Bot Runner devices
Automation Anywhere Mozilla Firefox extension Enables you to automate using Mozilla Firefox browser.	<a href="https://addons.mozilla.org/en-US/firefox/addon/automation-360">https://addons.mozilla.org/en-US/firefox/addon/automation-360</a>	TCP 443 (HTTPS)	Bot Creator and Bot Runner devices
CoE Manager	<ul style="list-style-type: none"> <li>US region: <a href="https://util.shibumi.com">https://util.shibumi.com</a>*</li> <li>EU region: <a href="https://util.eu.shibumi.com">https://util.eu.shibumi.com</a>*</li> <li>AP region: <a href="https://util.ap.shibumi.com">https://util.ap.shibumi.com</a>*</li> </ul>	--	--

## Files and folders

For information on files and folders to add to the safe list and to the antivirus exception list, see these articles:

- [Files and URLs to add to safe list for Automation 360 \(A-People login required\)](#)
- [List of files to add to antivirus exception list for Automation 360 \(A-People login required\)](#)

Related reference

[Add service URLs to trusted list for Cloud](#) on page 1170

For Cloud deployment, to ensure secure access to Automation 360 online services, add the service URL list to the safe recipients or trusted list.

## Using the Control Room diagnostics utility

Use the Control Room diagnostics utility to gather the Control Room logs, event viewer logs and system information for a specified duration and troubleshoot any Control Room related issues.

Because the diagnostic utility is designed for On-Premises Windows environment only, ensure that the Control Room is installed on the machine. To gather the required information, you must execute the utility independently on each node of the Control Room cluster.

1. Open the Windows Command Prompt with elevated privileges (Run as administrator).
2. Navigate to the Control Room installation path.

Default installation path for Control Room is:

```
C:\Program Files\Automation Anywhere\Automation360
```

3. Run the Control Room diagnostic utility using the following command:

```
C:\Program Files\Automation Anywhere\Automation360\jdk11\bin\java -
jar crdiagnosticutility.jar [OPTIONS]
```

**Note:** The Java Development Kit (JDK) is bundled with the Control Room and the default location is C:\Program Files\Automation Anywhere\Automation360\jdk11\bin\java.

4. The following table describes the option for performing the diagnostic check:

Option	Description
-collectLogs	<p>By capturing multiple logs for the Control Room, you reduce the turnaround time for collecting information on issues. The logs are collected as a zip file on the machine where the utility is being run.</p> <p>The logs are saved in the configured log directory of Control Room. For example, the default log directory is C:\ProgramData\AutomationAnywhere\Logs\.. The compressed file will be created in C:\ProgramData\AutomationAnywhere\Logs\CR_logs_&lt;datetimestamp&gt;.zip.</p> <p>Review the following considerations on using the Control Room diagnostic utility:</p> <ul style="list-style-type: none"> <li>• To capture Windows logs for security events, run the utility with administrative or elevated privileges. An alert is displayed if you run the utility without elevated privileges.</li> <li>• To save the storage space, delete the zip file after debugging.</li> </ul>

## Uninstalling Automation 360

Use the Automation 360 installer or the **Uninstall or change a program** option from the Windows Control Panel to remove or uninstall a Control Room instance.

1. To uninstall the Control Room using the installer, run the setup file from the installation path. Run the installer in admin mode.
2. In the InstallShield wizard, click **Next**.
3. Click **Remove**.

4. Click **Finish** to complete uninstalling the Control Room from your machine or server.

Related concepts

[Migrate to Automation 360](#) on page 1496

Migration (upgrade) is the process of moving your data and bots from Enterprise 11 or Enterprise 10 to Automation 360. Migration includes but is not limited to replicating and updating your existing database and repository, converting your bots to the Automation 360 format, and migrating learning instances for IQ Bot and dashboards for Bot Insight.

Related reference

[Installing Control Room On-Premises](#) on page 1177

Review the installation core tasks and topics for installing the Automation 360 Control Room in a data center on an On-Premises server or a cloud service provider server instance.

## Set up Community Edition

Community Edition is a free web-based option for you to experience a wide range of bot creation capabilities available in Automation 360. Use these tasks to register for, and start creating and using bots with the Community Edition.

1. Register for the Automation Anywhere Community Edition:
  - a) From the Automation Anywhere website <https://www.automationanywhere.com> scroll to and click the **Get Community Edition** option.  
Alternatively, select **Customers & Partners > A People Community > Community Edition**. Scroll to the registration form: **GET COMMUNITY TODAY**.
  - b) Enter your identification information in the form that appears.  
The form information includes your first name, last name, email, country, phone number, and company. This information is used to create your Community Edition user login credentials.  

---

**Restriction:** Only the period/dot (.) and at sign (@) are allowed in the email field. No other special characters are supported.

---
  - c) Read and agree to the terms, privacy policy, and license agreement. Select and click **Submit**.
2. Wait for the email from Automation Anywhere that contains the information for you to log in to the Community Edition.  
The email includes the Community Control Room URL, your username, and assigned user password. After you log in, you are prompted to reset your password.
3. [Log in to the Control Room](#).  
To do this, open the Control Room URL in your browser, enter your credentials in the login screen, and click **Log in**.
4. Install the Bot Agent, register your device, and set user device credentials.  
[Install Bot Agent and register device](#) on page 1347 | [Set user device credentials](#) on page 1353  
The Bot Agent is a lightweight application that enables you to run bots on your device by connecting the device to the Control Room. To run bots on a local machine, install the Bot Agent and add the local device to the list of enabled host devices.

To enable a device for running bots, set the local device credentials.

If you are using an operating system other than Windows, you will not be able to install the Bot Agent at this time. See [system requirements](#). However, you can still build bots using the [Bot editor](#).

**5. [Create your first bot](#)** on page 1489.

Follow these steps to create your first bot that prints the message, `Go be great!`, the Automation Anywhere version of `Hello World!`

**6. [Run your first bot](#)** on page 1493.

Run a bot from the same device that you used to create the bot.

Watch the following videos that illustrate some of the steps in this task:

- Installing the Bot Agent:
- Building your first bot:
- Running your first bot in the Community Edition:

Community Edition offers most of the same features as Automation 360. For more about Community Edition access, bot creation, and running condition details, see [Community Edition capabilities](#) on page 1327.

## Community Edition capabilities

Community Edition is a powerful automation platform that offers most of the same features as our enterprise product, Automation 360. Learn about how to get the most out of Community Edition and how it compares to Automation 360.

Community Edition is a completely free automation platform available to anyone to use to automate daily, routine tasks. It's designed for a single user to automate their own tasks, rather than for a large team to collaborate on automation.

### How is Community Edition meant to be used

To decide between Community Edition and Automation 360, consider how you want to use automation. Community Edition is designed to work best for 3 specific situations:

- Small businesses and non-profits can leverage the power of automation.
- Learners can accelerate their automation (or automation-adjacent) career by practicing automation.
- Businesses can test drive the Automation Success Platform and upgrade to the enterprise version when ready.

### How is Community Edition not meant to be used

Community Edition is a powerful automation platform, so it's a great place to start your automation practice. However, it's not designed for enterprise-scale automation. If that's your goal, consider Automation 360.

## How are Community Edition and Automation 360 features different

Community Edition offers most of the same Automation Workspace tools as Automation 360 to build automations. However, enterprise-oriented features such as collaboration tools and high-volume bot runs are different.

What's the same in Community Edition and Automation 360

Community Edition has almost all the same features to build powerful automations:

- Build and run unlimited automations.
- Build complex processes to automate complex workflows.
- Use automated tools to easily identify and correct mistakes in your code.

Community Edition updates on the same release schedule:

- Community Edition and Automation 360 are updated in the same, quarterly release cycle.
- Community Edition updates are released automatically (unlike Automation 360, where you can choose when to update).
- Community Edition is updated before Automation 360 for early access

What's different in Community Edition and Automation 360

Collaboration tools

Since Community Edition is designed for a single user, it does not have the same collaboration tools as Automation 360.

- In Community Edition, a single user has their own workspace, whereas in Automation 360 multiple team members can collaborate.
- Community Edition does not include our custom packages software development kit (SDK), which Automation 360 developers can use to build packages for multiple team members to reuse.
- Community Edition does not include team-oriented security features such as multi-factor authentication (MFA).

Volume of bot runs

While Automation 360 is designed for a large team to run many automations at once, Community Edition is designed for a single user to run one automation at a time.

- Community Edition connects to a local device to run automations, whereas Automation 360 can connect to many Bot Runners to run many automations simultaneously.
- In Community Edition, the user manually triggers an automation to run, whereas in Automation 360 automations can be run on a pre-set schedule.

Bot Store integration

Our Bot Store enables developers to accelerate automation builds by reusing expert-built automations.

- Community Edition users can reuse Bot Store bots but not packages, whereas Automation 360 users can access packages too.
- Only Automation 360 users can submit automations to Bot Store.

Availability of enterprise products



The Automation Success Platform includes many products beyond the Automation Workspace and automation building tools. These offerings are designed to enable automation at an enterprise scale.

- Available in Community Edition: Document Automation, which can be useful for independent developers to intelligently extract data from documents.
- Not available in Community Edition: Bot Runner, Automation Co-Pilot, and CoE Manager, and administrator settings

If you want to explore the enterprise Automation Success Platform, you can [request a live demo](#).

Community support

Community Edition is supported in our Community user group. To ask a question or discuss Community Edition, [join the group](#).

## Usage guidelines

Number of bots creators per Community Edition user	Each Community Edition user can use one Bot Creator and one attended Bot Runner at a time. Community Edition user does not have access to unattended Bot Runner licenses.
Number of bots created by Community Edition user	Each Community Edition user can create multiple bots.
Number of registered devices per Community Edition user	Each Community Edition user can register multiple devices, but only be logged in to one at a time, and only run a bot on one device at a time.
Number of bots run by Community Edition user	Each Community Edition user can run one bot at a time on any one registered device.
Export bots function for Community Edition user	Community Edition user cannot export bots from the Control Room.
Import bots function for Community Edition user	Community Edition user cannot import bots downloaded from the Bot Store to the Control Room.

## Get started with Bot Agent

The Bot Agent is a lightweight application that enables you to run bots on your local device by connecting it to Control Room. After installing the Bot Agent on a device, a registered user with role-based access privileges can create, manage, and deploy bots on that device.

### Bot Agent configuration

1. A Control Room administrator creates and shares the user credentials. You can then log into Control Room using these sign in credentials.
2. After signing into Control Room, you install the Bot Agent and register your local device. This device is then mapped to your username in Control Room.

3. The Bot Agent is registered as a Windows service (Automation Anywhere Bot Agent Service) on your device and the Automation Anywhere extension is added to your browser.
4. The device communicates with the Control Room using WebSocket and stays connected.

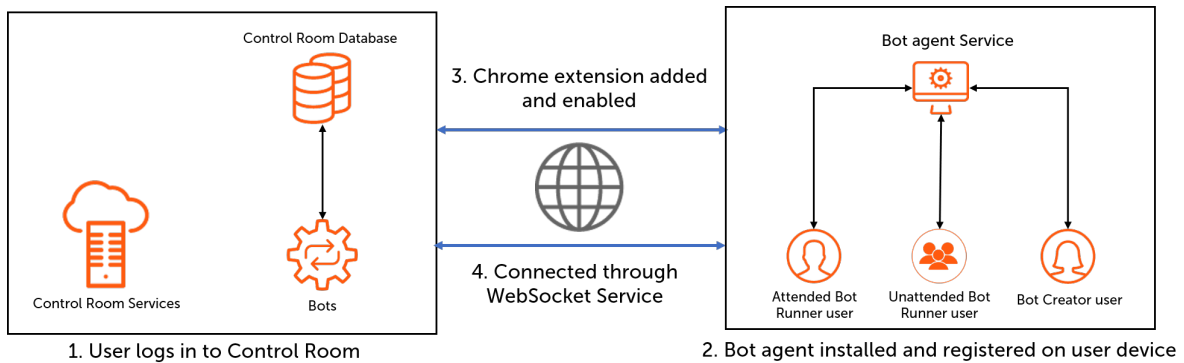

## Privilege mapping

A user is granted privileges governed by role-based access and assigned a device license by a Control Room administrator. User is assigned a Bot Creator or Bot Runner license.

### Bot Creator

Users with this license can log into the Control Room from a browser to perform the following actions:

- Create, edit, or delete bots.
- Manage bots for using in Bot Insight, IQ Bot, and Bot Store.

### Bot Runner

Users with this license can deploy bots from the Control Room. Additionally, a user can be assigned one of the following Bot Runner licenses:

- Unattended Bot Runner license

Users with this license are can allow other Control Room users with the required role to run and schedule automations in Control Room. These users are also referred as **Run as users**.

- Attended Bot Runner license

Users with this license are allowed to run attended automations on their devices from the Control Room.

**Note:** If you encounter black screen when running bots in unattended mode, see the following article for troubleshooting steps.

[Black screenshot while running the bot in unattended mode \(A-People login required\)](#)

### Related tasks

[Install Bot Agent and register device](#) on page 1347

Install Bot Agent on your local device and connect it to Control Room. In order to run bots on that local device, ensure that you add it to the list of enabled host devices.

Related reference

[Bot Agent compatibility](#) on page 1332

Before you install the Bot Agent, ensure that you review the compatible Automation 360 builds.

[Automation 360 licenses](#) on page 1407

The **All Licenses** page displays detailed information about current product and device licenses.

## Bot Agent communication with Control Room

Bot Agent uses various channels to communicate with the Control Room. Relevant data is transferred directly and indirectly using communication channels such as loop-back interface, browser plug-in, and WebSocket connection.

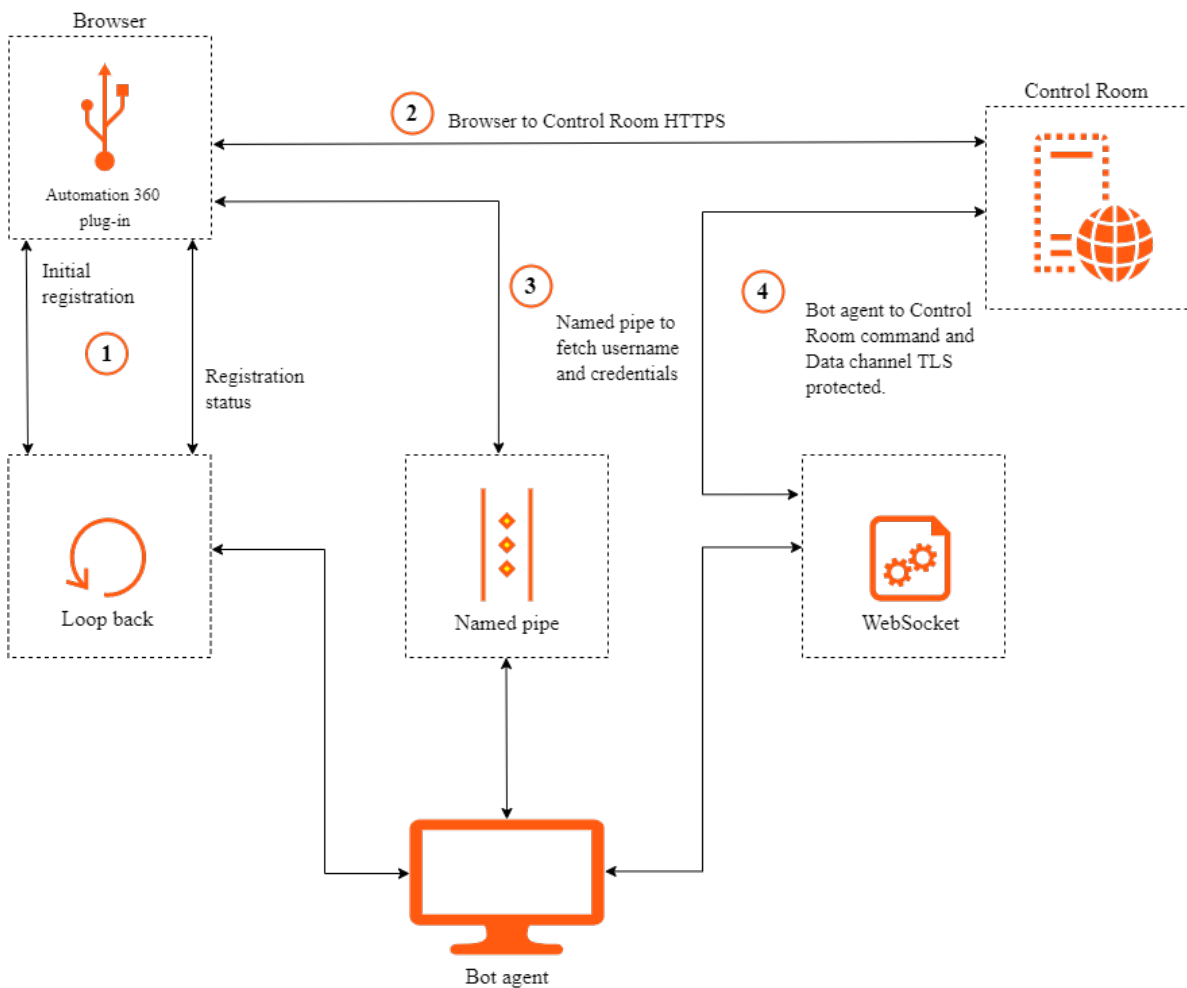

### Browser to loop-back interface

The browser-to-loop-back-interface channel is used during initial Bot Agent device registration and post-registration to check the current connection status to the Control Room. The loop-back interface uses HTTP unencrypted connection.

The following initial registration data is transferred over this channel:

- Control Room user token. This is accessible through developer tools on the browser.
- Control Room URL
- Proxy metadata, such as device ID, whether the proxy is configured or not, and whether it uses authentication or not.

The following connection status data is transferred over this channel:

- Device ID
- Control Room URL
- Installation type, such as system-level or user-level
- Proxy metadata, such as device ID, whether the proxy is configured or not, and whether it uses authentication or not.

## Browser to Control Room

The browser-to-Control Room channel is used by the browser to connect to the Control Room. The data transferred over this channel includes all Control Room web data. The browser uses HTTPS encrypted connection.

## Plug-in to Bot Agent named pipe

The plug-in to the Bot Agent named pipe channel is used to fetch current logged-in username and credentials if an authenticated proxy is to be obtained for the browser. The plug-in channel is protected by user permissions.

## Bot Agent to Control Room WebSocket

The Bot Agent-to-Control Room WebSocket channel is used for all command and data transfer between the Bot Agent and Control Room. Data transferred over this channel includes requests from the Bot Agent to the Control Room, bot code transfer, password data, Control Room-to-Bot Agent requests. Password data is payload-encrypted, with the device public key in addition to the TLS encryption of the channel.

## Bot Agent compatibility

Before you install the Bot Agent, ensure that you review the compatible Automation 360 builds.

The latest version of Bot Agent is available for download and is compatible with the Control Room version that is used.

## Guidelines

- When you update the Bot Agent in Windows Server 2012 or earlier versions of the operating system, you might encounter unexpected system reboots during the update because of the limitations in the operating system.

- When the Bot Agent update is optional, you can continue to use the Bot Agent from any of the previous (optional) releases, which will be compatible with the current release. For example, the Bot Agent update is optional for v.26. So you can continue to use the Bot Agent from v.25 release.

You can download and install the latest version of Bot Agent anytime on your device. However, an alert on the availability of the latest version of Bot Agent is displayed on the login screen if you are connected to a device that is running a previous version of Bot Agent.

- A Control Room version is only compatible with corresponding or previous versions of Bot Agent.

For example, if you are using the v.26 Control Room, you can use the Bot Agent version released with v.26 or previous versions. However, you cannot use Bot Agent version that is later than v.26 Control Room.

- In Community Edition, the Bot Agent is automatically updated to the compatible version when a Bot Agent update is required.
- If you want to use the latest version of packages from a new release, you might be required to update to the latest version of the Bot Agent even if it is optional.

### Compatibility with release builds

Automation 360 version	Automation 360 build	Bot Agent version	Bot Agent update
Automation 360 v.31	<ul style="list-style-type: none"> <li>• Build 21023 (On-Premises)</li> <li>• Build 21023 (Cloud-Sandbox)</li> <li>• Build 21023 (Community Edition)</li> </ul>	<ul style="list-style-type: none"> <li>• 22.20.5</li> <li>• 22.20.5</li> <li>• 22.20.5</li> </ul>	Optional
Automation 360 v.30	<ul style="list-style-type: none"> <li>• Build 19688 (On-Premises)</li> <li>• Build 19688 (Cloud)</li> <li>• Build 19678 (Community Edition)</li> </ul>	<ul style="list-style-type: none"> <li>• 22.3.1</li> <li>• 22.3.1</li> <li>• 22.0.23334</li> </ul>	Optional
Automation 360 v.29	<ul style="list-style-type: none"> <li>• Build 18399 (On-Premises)</li> <li>• Build 18361 (Cloud)</li> <li>• Build 18361 (Community Edition)</li> </ul>	<ul style="list-style-type: none"> <li>• 21.250</li> <li>• 21.250</li> <li>• 21.250</li> </ul>	Optional
Automation 360 v.28	<ul style="list-style-type: none"> <li>• Build 17593 (On-Premises)</li> <li>• Build 17566 (Cloud)</li> <li>• Build 17566 (Community Edition)</li> </ul>	<ul style="list-style-type: none"> <li>• 21.240</li> <li>• 21.240</li> <li>• 21.240</li> </ul>	Optional

Automation 360 version	Automation 360 build	Bot Agent version	Bot Agent update
Automation 360 v.27	<ul style="list-style-type: none"> <li>Build 16685 (On-Premises)</li> <li>Build 16701 (Cloud)</li> <li>Build 16701 (Community Edition)</li> </ul>	<ul style="list-style-type: none"> <li>21.230</li> <li>21.230</li> <li>21.230</li> </ul>	Optional
Automation 360 v.26	<ul style="list-style-type: none"> <li>Build 15459 (On-Premises)</li> <li>Build 15459 (Cloud)</li> <li>Build 15450 (Community Edition)</li> </ul>	<ul style="list-style-type: none"> <li>21.222</li> <li>21.222</li> <li>21.222</li> </ul>	Optional
Automation 360 v.25	<ul style="list-style-type: none"> <li>Build 15112 (On-Premises)</li> <li>Build 14304 (Cloud)</li> <li>Build 14304 (Community Edition)</li> </ul>	<ul style="list-style-type: none"> <li>21.210</li> <li>21.210</li> <li>21.210.14966</li> </ul>	Optional
Automation 360 v.24R2 patch	<ul style="list-style-type: none"> <li>Build 13343 (Cloud, On-Premises GA, Sandbox, Community Edition)</li> <li>Build 13331 (On-Premises pre-GA)</li> </ul>	<ul style="list-style-type: none"> <li>21.200</li> <li>21.1000.14009</li> </ul> <p>On-Premises pre-GA build: Uninstall Bot Agent 21.1000.14009 and install Bot Agent 21.200.</p>	Optional
Automation 360 v.24	<ul style="list-style-type: none"> <li>Build 12350 (On-Premises)</li> <li>Build 12350 (Cloud)</li> <li>Build 12350 (Community Edition)</li> </ul>	<ul style="list-style-type: none"> <li>21.134 (On-Premises)</li> <li>21.134 (Cloud)</li> <li>21.134 (Community Edition)</li> </ul>	Optional
Automation 360 v.23	<ul style="list-style-type: none"> <li>Build 11513 (On-Premises)</li> <li>Build 11513 (Cloud)</li> <li>Build 11524 (Community Edition)</li> </ul>	<ul style="list-style-type: none"> <li>21.121.12191 (On-Premises)</li> <li>21.121.12191 (Cloud)</li> <li>21.121.12202 (Community Edition)</li> </ul>	Optional

Automation 360 version	Automation 360 build	Bot Agent version	Bot Agent update
Automation 360 v.22	<ul style="list-style-type: none"> <li>Build 10526 (On-Premises)</li> <li>Build 10535 (Cloud and Community Edition)</li> </ul>	<ul style="list-style-type: none"> <li>21.98.11198</li> <li>21.100.11213</li> </ul>	Optional
Automation 360 v.21	<ul style="list-style-type: none"> <li>Build 9664 (On-Premises)</li> <li>Build 9664 (Cloud and Community Edition)</li> </ul>	<ul style="list-style-type: none"> <li>21.82.10342</li> <li>21.82.10342</li> </ul>	Required
Enterprise A2019.20	<ul style="list-style-type: none"> <li>Build 8815 (On-Premises)</li> <li>Build 8846 (Cloud)</li> </ul>	<ul style="list-style-type: none"> <li>20.17.9493 (On-Premises)</li> <li>Cloud:                             <ul style="list-style-type: none"> <li>20.18.9528 (for US-West and Japan regions)</li> <li>20.17.9518 (for regions other than US-West and Japan)</li> </ul> </li> </ul>	Required
Enterprise A2019.19	<ul style="list-style-type: none"> <li>Build 8147 (On-Premises)</li> <li>Build 8145 (Cloud and Community Edition)</li> </ul>	<ul style="list-style-type: none"> <li>18.12.8825</li> <li>18.12.8823</li> </ul>	Required
Enterprise A2019.18	Build 7560 (Cloud, On-Premises, and Community Edition)	16.19.8238	Optional
Enterprise A2019.17	Build 7103 (Cloud, On-Premises, and Community Edition)	16.7.7774	Required
Enterprise A2019.16	Build 6463 (Cloud, On-Premises, and Community Edition)	14.3.7141	Required
Enterprise A2019.15	Build 5933 (Cloud, On-Premises, and Community Edition)	12.7.6609	Optional
Enterprise A2019.14	Build 5322 (Cloud, On-Premises, and Community Edition)	12.1.6000	Required
Enterprise A2019.13	<ul style="list-style-type: none"> <li>Build 4705 ( On-Premises)</li> <li>Build 4701 (Cloud and Community Edition)</li> </ul>	<ul style="list-style-type: none"> <li>9.0.5383</li> <li>9.0.5379</li> </ul>	Required

Automation 360 version	Automation 360 build	Bot Agent version	Bot Agent update
Enterprise A2019.12	<ul style="list-style-type: none"> <li>Build 4111 (Cloud and Community Edition)</li> <li>Build 4105 (On-Premises)</li> </ul>	<ul style="list-style-type: none"> <li>7.0.4789</li> <li>7.0.4783</li> </ul>	Required
Enterprise A2019.11	Build 3337 (On-Premises, Cloud, and Community Edition)	6.0.4015	Required
Enterprise A2019.10	Build 2545 (Cloud, On-Premises, and Community Edition)	3.3.3211	Optional
Enterprise A2019.09	Build 2094 (Cloud, On-Premises, and Community Edition)	3.0.2772	Required
Enterprise A2019.08	<ul style="list-style-type: none"> <li>Build 1610 (On-Premises only)</li> <li>Build 1598 (Cloud and Community Edition)</li> </ul>	<ul style="list-style-type: none"> <li>1.0.2288</li> <li>1.0.2276</li> </ul>	Optional
Enterprise A2019.07	<ul style="list-style-type: none"> <li>Build 1089 (On-Premises only)</li> <li>Build 1082 (Cloud and Community Edition)</li> </ul>	<ul style="list-style-type: none"> <li>1.0.1767</li> <li>1.0.1760</li> </ul>	Optional
Enterprise A2019.06	Build 543 (Cloud, On-Premises, and Community Edition)	1.0.1221	Optional
Enterprise A2019.05	Build 336 (Cloud, On-Premises, and Community Edition)	1.0.1014	Required

For information on Bot Agent device requirements, see [Bot Agent device requirements](#) on page 1340.

Related concepts

[Update Bot Agent](#) on page 1361

Updating to the latest Bot Agent version enables users to use new features available in the Automation 360 release.

Related tasks

[Install Bot Agent and register device](#) on page 1347

Install Bot Agent on your local device and connect it to Control Room. In order to run bots on that local device, ensure that you add it to the list of enabled host devices.

Related reference

[Automation 360 feature comparison matrix](#) on page 990

Compare Automation 360 features with Enterprise 11.3.x and Enterprise 10 features to understand the benefits to Automation 360. Review advantages of Automation 360 if you are a new user of the product.

[Universal Recorder supported applications and browsers](#) on page 2248



Use the Universal Recorder to record interactions with objects from the supported technologies.

## Auto login support for Bot Agent

The **Auto login** feature enables you to automatically log into a device, run a scheduled automation, and restore the device to its original locked or logged off state after the automation has completed.

The **Run as user** device credentials are used for auto-login. Auto login restores a device to its original state in the following scenarios:

- Automation was stopped on the Control Room or device.
- An error is encountered during bot execution.
- When the automation has completed successfully.

### Auto login support: Operating system

Identify the operating system support specific to auto-login on Bot Agent devices. The auto-login process involves several stages and depends on the Bot Agent activity.

The following scenarios are supported on Windows 10 and virtual machines only:

SID#	Scenario
1	No user session established (user is not logged in)
2	User session established
3	User has logged in but locked the screen
4	A different user (not the device log in user used for deployment) is logged in
5	A different user is logged in and locked the screen
6	Fast user switching

For scenarios 4, 5, and 6 in the above table, the active user is logged off and a new session is created with device credentials for deploying the bot.

The following scenarios are applicable and supported on Windows Server 2019, Windows Server 2016, Windows Server 2012 R2, Windows 10, 8, and 7:

SID#	Scenario
1	No active RDP session
2	User has active RDP session
3	User's RDP session is disconnected
4	User's RDP session is locked
5	Another user has active RDP session
6	Another user has a disconnected session

SID#	Scenario
7	Another user has an active session and locked

## Auto login support: Operating system with cloud platform

**Note:** Remote Desktop Protocol (RDP) based deployment on a Virtual Machine (VM) hosted in Amazon Web Services (AWS) workspace is not supported when there is an active user session (no active console session from previous user login).

The following table identifies the support specific to auto-login on Bot Agent devices for operating system across cloud platforms:

SID#	Scenario	Supported OS
1	No active RDP session	<ul style="list-style-type: none"> <li>• Windows 2019 - AWS</li> <li>• Windows 2016 R2 - AWS</li> <li>• Windows 2012 R2 - AWS</li> <li>• Windows 10 AWS</li> <li>• Windows 11 (Enterprise)</li> <li>• Windows 10 Azure (Enterprise)</li> <li>• Windows 10 VMWare (ESXi 6.7 and Horizon)</li> <li>• Windows 10 Citrix</li> </ul>
2	User has active RDP session	<ul style="list-style-type: none"> <li>• Windows 2019 - AWS</li> <li>• Windows 2016 R2 - AWS</li> <li>• Windows 2012 R2 - AWS</li> <li>• Windows 10 AWS</li> <li>• Windows 11 (Enterprise)</li> <li>• Windows 10 Azure (Enterprise)</li> <li>• Windows 10 VMWare (ESXi 6.7 and Horizon)</li> <li>• Windows 10 Citrix</li> </ul>
3	User's RDP session is disconnected	<ul style="list-style-type: none"> <li>• Windows 2019 - AWS</li> <li>• Windows 2016 R2 - AWS</li> <li>• Windows 2012 R2 - AWS</li> <li>• Windows 10 AWS</li> <li>• Windows 11 (Enterprise)</li> <li>• Windows 10 Azure (Enterprise)</li> <li>• Windows 10 VMWare (ESXi 6.7 and Horizon)</li> <li>• Windows 10 Citrix</li> </ul>

SID#	Scenario	Supported OS
4	User's RDP session is locked	<ul style="list-style-type: none"> <li>Windows 2019 - AWS</li> <li>Windows 2016 R2 - AWS</li> <li>Windows 2012 R2 - AWS</li> <li>Windows 10 AWS</li> <li>Windows 11 (Enterprise)</li> <li>Windows 10 Azure (Enterprise)</li> <li>Windows 10 VMWare (ESXi 6.7 and Horizon)</li> <li>Windows 10 Citrix</li> </ul>
5	Another user has active RDP session	<ul style="list-style-type: none"> <li>Windows 2019 - AWS</li> <li>Windows 2016 R2 - AWS</li> <li>Windows 2012 R2 - AWS</li> <li>Windows 10 AWS</li> <li>Windows 11 (Enterprise)</li> <li>Windows 10 Azure (Enterprise)</li> <li>Windows 10 VMWare (ESXi 6.7 and Horizon)</li> <li>Windows 10 Citrix</li> </ul>
6	Another user has a disconnected session	<ul style="list-style-type: none"> <li>Windows 2019 - AWS</li> <li>Windows 2016 R2 - AWS</li> <li>Windows 2012 R2 - AWS</li> <li>Windows 10 AWS</li> <li>Windows 11 (Enterprise)</li> <li>Windows 10 Azure (Enterprise)</li> <li>Windows 10 VMWare (ESXi 6.7 and Horizon)</li> <li>Windows 10 Citrix</li> </ul>
7	Another user has an active session and locked	<ul style="list-style-type: none"> <li>Windows 2019 - AWS</li> <li>Windows 2016 R2 - AWS</li> <li>Windows 2012 R2 - AWS</li> <li>Windows 10 AWS</li> <li>Windows 11 (Enterprise)</li> <li>Windows 10 Azure (Enterprise)</li> <li>Windows 10 VMWare (ESXi 6.7 and Horizon)</li> <li>Windows 10 Citrix</li> </ul>

Additional notes on auto-login:

- Auto-login is only supported on 64-bit operating systems.
- Auto-login is unable to sign-out the root admin session, when trying with scenarios that involve two different auto-login users. Remember to log out of the admin user account before deploying a bot.

Related concepts

[Manage device settings](#) on page 1797

Control Room administrator can configure the device settings to automatically set a user's default device when that user logs into Control Room.

Related tasks

[Configure auto-login settings](#) on page 1804

Configure auto-login settings in the Control Room to either create user sessions or reuse existing user sessions to reduce the bot startup time.

Related reference

[Bot Agent compatibility](#) on page 1332

Before you install the Bot Agent, ensure that you review the compatible Automation 360 builds.

## Bot Agent device requirements

Review the Bot Agent device requirements such as hardware components, compatible devices, supported operating systems and browser extensions.

### Hardware requirements

You can install the Bot Agent on devices that meet the following hardware requirements.

Device	Processor	RAM	Storage (free disk space)	Network
Single user machine	Intel Core i3 2.6 GHz with 4 multi-cores or higher  64-bit	<ul style="list-style-type: none"> <li>4 GB (Minimum)</li> <li>8 GB (Recommended)</li> </ul>	<ul style="list-style-type: none"> <li>32 GB</li> <li>Add 100 through 150 KB per Automation Anywhere script</li> <li>Add 40 through 50 GB per long-term project</li> </ul>	<ul style="list-style-type: none"> <li>5Mbps (Minimum)</li> <li>20Mbps or higher (Recommended)</li> </ul>
Multi-user machine	2 CPU per additional user	4 GB per additional user		

**Note:** If you have more than 10 users for a multi-user machine, ensure that you double the storage space and network bandwidth as well. For example, if you have 20 users, the storage space must be a minimum of 64 GB and the network bandwidth must be 40 Mbps or higher.

Additional RAM requirements for the registered devices

Add additional RAM to account for applications and services running on the registered devices, for example:

- Microsoft Office applications (example: Excel)
- Browsers (example: Google Chrome)

- Enterprise applications (example: CRM, Oracle EBS, and SAP)
- VDI infrastructure applications
- Anti-virus software
- AISense Recorder

Additional disk space on registered devices

- Automation 360 scripts average approximately 100-150 KB. Additional free disk space is required to develop automation projects because temporary files such as screenshots, server logs, and audit files are created during the execution of the automation scripts.
- Free space required increases with the project size. Recommendation: Have at least 40-50 GB of free disk space for each long-term project.
- Increase storage space configuration after installation, as needed, depending on product usage. For example, depending upon the complexity of your bot, generating log files and logic creation require additional disk space later.

---

**Note:** The hardware requirements for Document Automation are the same as the Bot Agent.

---

## Device compatibility

A device running the Bot Agent to perform automation must meet the following requirements:

---

**Note:**

- Device requirements are different for the Control Room and Bot Agent.  
For Control Room compatibility, see [Operating system, environment, and platform supported for Control Room](#) on page 1194.
- For your device to work properly on Amazon WorkSpaces, update the registry on all workspace machines by renaming the `spacedeskHookKmode.sys` file to `spacedeskHookKmode.sys.old` in `C:\Windows\System32\drivers`. Restart your machine and verify that `STXHD Hosted Application Service` is not running.  
For more information, see [Troubleshooting Amazon WorkSpaces issues](#).
- If the deployment type for your device is set as **Regular**, you will not encounter any issues with bot deployments in Amazon WorkSpaces. If the deployment type for your device is set as **RDP**, you must enable RDP sessions on Amazon WorkSpaces for successful bot deployments. To

enable the RDP sessions on Amazon WorkSpaces, see [How to connect to Workspace with RDP](#).

On-Premises machines	Physical machines running on supported operating systems.
Terminal servers	Remote desktop (RDP) running on supported operating systems from Enterprise A2019.11 or later.
Virtual machines	<p>From Enterprise A2019.09 or later, the Bot Agent can be installed on all virtual machines (VMs) with supported Windows OS.</p> <p>For Alsense recorder to work on a VM, enable AVX instructions for both Bot Runner and Bot Creator.</p> <p>For details, see <a href="#">Automation 360: AI Sense Recorder is crashing (A-People login required)</a>.</p> <p>The Bot Agent is certified on all major versions of VMs and supports the following:</p>

Virtual Machine (VM)	Operating System and edition	Supported for multi-user deployments
Amazon Web Services EC2	<ul style="list-style-type: none"> <li>Windows 11 (Enterprise)</li> <li>Windows 10 (Professional)</li> <li>Windows 2012 Server, Windows 2016 Server, and Windows 2019 Server (Standard and Datacenter)</li> </ul>	Yes

Virtual Machine (VM)	Operating System and edition	Supported for multi-user deployments
Amazon Web Services WorkSpaces (4 vCPU, 16 GB memory) For more information, see <a href="#">Amazon WorkSpaces Core Pricing</a> .	<ul style="list-style-type: none"> <li>• Windows 11 (Enterprise)</li> <li>• Windows 10 (Professional)</li> </ul>	No
Google Compute Engine	<ul style="list-style-type: none"> <li>• Windows 11 (Enterprise)</li> <li>• Windows 10 (Professional)</li> <li>• Windows 2012 Server, Windows 2016 Server, and Windows 2019 Server (Standard and Datacenter)</li> </ul>	No
Microsoft Azure Virtual Machine (VM)	<ul style="list-style-type: none"> <li>• Windows 11 (Enterprise)</li> <li>• Windows 10 (Professional and Enterprise)</li> <li>• Windows 2019 Server (Datacenter)</li> </ul>	Yes

Virtual Machine (VM)	Operating System and edition	Supported for multi-user deployments
Microsoft Azure Windows Virtual Desktop (WVD)	<ul style="list-style-type: none"> <li>Windows 11 (Enterprise)</li> <li>Windows 10 (Enterprise)</li> </ul>	Yes
VMware VMs on ESXi 6.x	<ul style="list-style-type: none"> <li>Windows 10 (Professional)</li> <li>Windows 2016 Server</li> </ul>	Yes
Citrix XenDesktop (VDI)	Windows 2016 Server	No
Citrix VM	<ul style="list-style-type: none"> <li>Windows 10 (Enterprise)</li> <li>Windows 2016 (Server)</li> </ul>	Yes
VMware Horizon	Windows 10 (Enterprise)	Yes
Windows 365 Cloud PC	Windows 11 (Enterprise)	No

---

**Note:** Multi-user deployment for Windows 10 (Professional) is not supported.

---

**Note:** When you install the Bot Agent on virtual machines, ensure that you change the virtual machine **Power and Sleep** settings to **Never** so that bot deployments from the Control Room can run without interruption.

---

## Operating system compatibility

You can install the Bot Agent on machines running the following operating systems.



This compatibility applies to On-Premises, Cloud deployments, and Community Edition of Automation 360.

**Note:**

- Only 64-bit operating system version is supported.
- Bot Creator tasks are supported with all the listed operating systems.
- The Bot Agent cannot be installed on Linux systems. You cannot register a device that is running on a Linux system. However, you can use a registered device running on a Windows system to access a Control Room that is installed on a Linux system.

Windows version	Windows edition	Attended Bot Runner	Unattended Bot Runner	Bot Creator
Windows Server 2022	Datacenter	Supported	Supported <sup>1</sup>	Supported
Windows Server 2019	Datacenter and Standard	Supported	Supported <sup>1</sup>	Supported
Windows Server 2016	Datacenter and Standard	Supported	Supported <sup>1</sup>	Supported
Windows Server 2012	Datacenter and Standard	Supported	Supported <sup>1</sup>	Supported
Windows 11	Enterprise	Supported	Supported <sup>1</sup>	Supported
Windows 10	Professional and Enterprise	Supported	Supported <sup>1</sup>	Supported
Windows 8 <sup>2</sup>	Professional and Enterprise	Supported	Supported	Supported
Windows 7 <sup>2</sup>	Professional and Enterprise	Supported	Supported	Supported

(1) Auto-login

Auto-login is only supported on 64-bit systems.

(2) Supported OS

Windows 11 (64-bit) supported on Automation 360 Build 15459 or later.

Windows 8 (64-bit) supported on Enterprise A2019 (Builds 1598 and 1610) or earlier.

Windows 7 (64-bit) supported on Enterprise A2019.12 or later.

**Browser compatibility**

The user interface for Bot Agent is through a browser. Log in to Automation 360 using the supported browsers to install and register your device.

For a list of supported browsers, see [Supported browsers](#) on page 1210

## Supported extensions

When you connect your Bot Agent device to the Control Room, you can enable supported extensions from your browser to record automations.

For a list of supported extensions, see [Extensions for automation](#) on page 1213

## Auto-login support

Auto-login is used to automatically log on to a device, run a scheduled automation, and restore the device to its original locked or logged off state after running the automation.

For operating system support specific to auto-login on Bot Agent devices, see [Auto login support for Bot Agent](#) on page 1337

Related tasks

[Bulk install Bot Agent on devices](#) on page 1354

Installing Bot Agent across multiple devices such as on-premises machines, virtual machines (VM), and non-persistent virtual desktop infrastructure (VDI) including Amazon WorkSpaces is called Bulk install (or silent install). You must edit the Bot Agent MSI file for bulk installation.

## Manage Bot Agent

Users can perform tasks based on their assigned role after installing the Bot Agent on their device.

1. Review the prerequisites to install the Bot Agent are complete.  
[Bot Agent compatibility](#) on page 1332
2. Install Bot Agent on your device.
  - [Install Bot Agent and register device](#) on page 1347
  - [Bulk install Bot Agent on devices](#) on page 1354
3. In order to deploy bots on your device, connect the Bot Agent to your device using an authentication proxy and ensure that the changed proxy setting or credentials are updated.  
[Connect Bot Agent to a device with a proxy](#) on page 1351
4. Set device credentials to for the Control Room to deploy bots on your device.  
[Set user device credentials](#) on page 1353
5. Switch to a different Control Room based on your automation requirements.  
[Switch Bot Agent to a different Control Room](#) on page 1350
6. When updates are available, you can update the Bot Agent to the latest version. You can enable one of the following methods of updating Bot Agent:
  - [Automatically update the Bot Agent](#) on page 1361
  - [Manually update the Bot Agent](#) on page 1362
7. Verify the Bot Agent version and device connection under the **Devices** page in Control Room.  
[Devices](#) on page 1873

## Related tasks

Users can also perform the following tasks:

- Use the Bot Agent diagnostic utility to perform diagnostic checks on Bot Runner devices and to help in resolution of Bot Agent connectivity challenges.  
[Perform Bot Agent diagnostic checks](#) on page 1364
- Use the Bot Agent relevant logs to resolve issues.  
[Bot Agent log files](#) on page 3607
- Create and edit Task Bots  
[Create your first bot](#) on page 1489 | [Edit a bot](#) on page 2313
- Deploy bots on attended and unattended Bot Runners with or without Workload automation.  
[Run a bot](#) on page 2282 | [Schedule a bot](#) on page 2129 | [Run bot with queue](#) on page 2006
- Manage different bots and packages using Bot Store, Bot Insight, and Automation 360 IQ Bot.
  - [Bot Store](#) on page 3607
  - [Using Bot Insight](#) on page 3948
  - [Automation 360 IQ Bot](#) on page 3730
- Perform other activities such as updating user profile.  
[Edit profile](#) on page 1397

---

**Note:** For additional information about the Bot Agent, see [Automation Anywhere Certification \(A-People login required\)](#)

---

## Install Bot Agent and register device

Install Bot Agent on your local device and connect it to Control Room. In order to run bots on that local device, ensure that you add it to the list of enabled host devices.

Starting with Automation 360 v.29, we have enhanced the Bot Agent installer by-, including new `.exe` files for the **Bot launcher**, **Node manager**, **Triggers**, and **Child session launchers**. The following changes occur in the installer when you:

- Install the Bot Agent, `java.exe` will be replaced by `NodeManager.exe`.
- Run a bot, `javaw.exe` will be replaced by `BotLauncher.exe`.
- Configure a trigger, the trigger will be activated with `TriggerListener.exe` instead of `javaw.exe`.
- Run a bot with Automation Co-Pilot (integrations) (AARI), `javaw.exe` will be replaced with `ChildSessionLauncher.exe`.

---

**Note:** When you install or update the Bot Agent, you must include the new `.exe` files in the trusted list.

---

- To install the Bot Agent, the Windows installer policy must be enabled for your local device.
- The read, write, and execute permissions must be enabled for the Bot Agent folders on your local device.

- Ensure that the local device system date and time are in sync with the current date and time so that the device registration is successful.

[Credential requirements](#) on page 1197

The Bot Agent version available for download is the latest and compatible with the Control Room version that is used.

---

**Note:**

- You can now install the Bot Agent on a device with an existing Enterprise 11 client. However, ensure that the Automation 360 and Bot Agent versions that you are using are v.25 or later.
    - A Bot Creator can log in and access both Automation 360 and Enterprise 11 client to create bots.
    - Attended Bot Runners can run bots from both Automation 360 and Enterprise 11 Control Room instances.
    - Unattended Bot Runners can deploy bots by using the run and schedule permission on the same device.
  - You cannot run bots from Enterprise 11 and Automation 360 at the same time.
  - You cannot install a Bot Agent on a device with an existing Enterprise 10 client.
  - When the Bot Agent is installed on a device where Enterprise 11 client is also installed and then you uninstall the client, you might face login issues with the device. Therefore, you must uninstall and re-install the Bot Agent on the device.
- 

**Note:** If the Bot Agent is installed at system level, then as part of the configuration update, permissions for the Global Cache folder is set as follows:

- Full access for System user and Administrator group.
  - Read, Execute, and List access for Authenticated users.
- 

1. Use a supported browser to log into Control Room through your Automation Anywhere URL.
2. Install the Bot Agent and add a local device by choosing one of the following options:
  - From the menu on the left, click the device icon to connect a local device.
  - Go to the **Devices** page, and click the **Connect local device** icon located at the top-right of the Devices list.

3. Click **Connect to my computer**.

The Bot Agent setup file is downloaded.

4. Follow the steps outlined in the wizard.

Authenticated proxy access: If your device's access to the internet is controlled through an authenticating proxy server, you are prompted to provide the proxy server authentication details. These credentials are required for the device to communicate with the Control Room.

To enable the authenticated proxy, register the device through a Google Chrome browser with the Automation 360 Chrome extension enabled.

---

**Note:** The Chrome and Edge extensions are installed for Google Chrome and Microsoft Edge Enterprise browser users, respectively, even if the device is offline. The extension is downloaded with the Bot Agent MSI installer file.

---

5. Select an option to install the Bot Agent either at the system level or user level.
  - To install at the system level, select **Anyone who uses this computer (all users)**

All users of the device can use this Bot Agent. However, users installing the Bot Agent must have administrator privileges.
  - To install at the user level, select **Only for me (username)**.

The Bot Agent will be available only to the individual user.
6. Enter the following in the **Additional information** screen:
  - Device nickname (optional)
  - Device type (single user or multiple user)

---

**Note:** For a multiple user device, enter the number of concurrent sessions that will be allowed. A minimum of two concurrent sessions is supported.

---
7. Click **Done**.
  - The Bot Agent is installed to the default location `C:\Program Files\Automation Anywhere\Bot Agent`.
  - The Bot Agent is registered as a Windows service: Automation Anywhere Bot Agent Service.
  - A shortcut to access Automation Co-Pilot Desktop Assistant is added to the Windows Start menu and desktop.
  - The Java Runtime Environment (JRE) files are installed with the Bot Agent in the Bot Agent install folder: `C:\Program Files\Automation Anywhere\Bot Agent\jre`.
8. Set the user device credentials so that your device can run bots.
9. Refresh the **Devices** page and verify that the local device is added.

You can identify the devices by their IP address and hostname.

---

**Note:** After you remove a device, wait for 35 seconds to re-register the device.

---

#### Troubleshooting:

- If you face any issues registering your device, see [Automation 360: Error while registering device - An unexpected problem occurred \(A-People login required\)](#).
- If the Bot Agent service is paused and does not start after installation, see [Automation 360 Error: Device is disconnected or needs upgrade \(A-People login required\)](#).
- If you are using Google Chrome browser version 94 or later and if you face issues registering your device in a Control Room On-Premises, we recommend that you configure the Control Room for HTTPS instead of HTTP. Alternatively, use Microsoft Internet Explorer or Mozilla Firefox to register your device.

If you face any issues adding a new device, see [Unable to Add New Device \(A-people login required\)](#).

- We recommend that you do not remove the Google Chrome extension. If you remove the extension, existing Google Chrome policy will restrict you from adding the extension (online or offline) even after you reinstall the Bot Agent. However, if you have removed the extension, use the following instruction to add it:
  - Go to the Google Chrome extension store to add the extension online. See [Automation 360 extension for Chrome](#).

- Drag the `ChromeExtension.crx` file (`C:\Program Files\Automation Anywhere\Bot Agent\AABrowserAgent`) to the Google Chrome extension tab (**three vertical dots menu on top-right > Settings > Extensions**).
- Similarly, ensure that you do not remove the Microsoft Edge extension as the existing Microsoft Edge policy will restrict you from adding the extension (online or offline) even after you reinstall the Bot Agent. For Microsoft Edge extension store, see [Microsoft Edge extension for Automation 360](#)

Watch the following video on how to install the Bot Agent in Automation 360:

Optionally, [Edit profile](#) on page 1397.

If your device is set with a proxy, see the tasks that apply to your proxy settings, [Connect Bot Agent to a device with a proxy](#) on page 1351.

Related concepts

[About device pools](#) on page 1881

Device pools are a logical grouping of devices or similar unattended Bot Runner machines on which you can run your workload management automations or scheduled unattended automations. For example, you can group the devices (system-wide type) of a specific department or unit and create a device pool.

Related tasks

[Create device pools](#) on page 1883

Create a device pool with a unique name and add Unattended Bot Runners to the device pool.

[Set user device credentials](#) on page 1353

To enable a device for running bots, set the local device credentials.

[Uninstall and reinstall Bot Agent](#) on page 1368

We recommend that you update to the most recent version of Bot Agent in order to use the latest features available in Automation 360 and resolve any possible issues that you might encounter during bot runs.

## Switch Bot Agent to a different Control Room

Switch the Bot Agent on a registered device to work with a different Control Room manually when you work on automations using different environments.

Ensure that you have the start, stop, and pause permissions to access and edit the Windows services.

Perform this task to manually associate your device with a different Control Room in the following scenarios:

- When the Control Room is on a different release version.
  - When the setting to switch devices is not enabled in the Control Room.
1. Stop the Bot Agent service from the local Windows Task Manager.
  2. Navigate to the following folder: `C:\Windows\System32\config\systemprofile\AppData\Local\AutomationAnywhere`
  3. Optional: Delete the `registration.properties` file.

**Note:** This is only required if you want to register the device in a different Control Room environment. To view the Control Room where the device is registered, open the `registration.properties` file and check the value for the Control Room URL.

---

4. Delete all `.db` files.  
For example, `AA-DB.mv.db` file.
5. Log in to the Control Room.
6. Navigate to **Manage > Devices**.
7. Click the **Connect local device** icon.
8. Download and install the latest Bot Agent.
9. Return to the **Devices** page in the Control Room from the updated device to check the device status.

The `registration.properties` file is not generated immediately after the Bot Agent installation. It is generated only when a user accesses a Control Room URL from that device. If the device registration is successful, the machine is shown as **Connected** and the `registration.properties` file is created at the specified location on the Bot Runner machine.

10. Navigate to the `C:\Windows\System32\config\systemprofile\AppData\Local\AutomationAnywhere` folder to ensure that the `registration.properties` file is present and verify the Bot Agent update.

Related tasks

[Install Bot Agent and register device](#) on page 1347

Install Bot Agent on your local device and connect it to Control Room. In order to run bots on that local device, ensure that you add it to the list of enabled host devices.

[Switch device registration between Control Room instances](#) on page 1807

Configure the device settings in the Control Room to enable single-user devices to easily switch between different instances of the Control Room to run bots in multiple environments. This option enables you to register the Bot Agent on multiple Control Room instances without uninstalling the Bot Agent.

## Connect Bot Agent to a device with a proxy

When you install a Bot Agent, your device proxy settings are imported during the installation process. However, if the proxy settings are not imported during installation, you can update the proxy configuration details manually.

---

**Note:** Your device proxy settings for authenticated proxy can be set during the Bot Agent registration process and can be updated via the Bot Agent diagnostic utility. The same credentials will be used for all users on the device.

---

Typically, when you change your proxy settings, whether you added a proxy or changed the credentials to the authenticating proxy, the Bot Agent prompts for the new credentials.

You can use two methods to add or update proxy credentials manually.

- Using `PSEXEC -sid` command.
- Using `netsh winhttp` command.

You can perform these steps before or after installing the Bot Agent.

**1.** Use any one of the following methods to add or update proxy credentials.

- Using `PSEXEC -sid` command.

**a)** Download PSTools.

[PsExec](#)

**b)** Extract the files from downloaded zip file.

**c)** Open the Microsoft command prompt in administrator mode.

**d)** Change to the directory where you extracted the PSTools files.

**e)** Execute the following command:

```
.\psexec -i -s -d cmd
```

**f)** In the new command prompt window, execute the following command:

```
whoami
```

The system returns the following:

```
nt authority\system
```

**g)** Execute the following command:

```
inetcp1.cpl
```

**h)** In the **Internet Properties**, navigate to **Connections > LAN settings**.

**i)** Select the **Use automatic configuration script** option.

**j)** Provide the address to the proxy auto-configuration (PAC) file.

For example: `http://localhost:888/proxy.pac`.

**k)** Click **OK**.

- Using `netsh winhttp` command.

**a)** Open the Microsoft command prompt in administrator mode.

**b)** List the proxy status by running the command:

```
netsh winhttp show proxy
```

**c)** If the command returns `Direct access`, then run the command:

```
netsh winhttp import proxy source = ie
```

If proxy settings are configured, the command returns the proxy server address. See following sample:

```
Current WinHTTP proxy settings:  
Proxy server(s): 123.0.0.4:1234  
Bypass List    : (none)
```

You do not have to import the settings.



**Note:** We recommend you import proxy settings using Bot Agent installer because of limitations to importing PAC file using the `netsh winhttp import proxy source = ie` command.

---

2. Restart the Bot Agent service from Windows services.
3. Open a Google Chrome browser with the Automation Anywhere extension enabled.
4. Log out and log back in to the Control Room.  
If prompted, provide the proxy credentials.
5. From the Control Room, check the device status and verify that it is connected.

Related reference

[Bot Runner device requirements](#) on page 1167

Review the hardware requirements, operating system versions, and browser types supported for creating and running bots on a device. The same requirements are also valid for Automation 360 Community Edition.

[Bot Agent compatibility](#) on page 1332

Before you install the Bot Agent, ensure that you review the compatible Automation 360 builds.

[Add service URLs to trusted list for Cloud](#) on page 1170

For Cloud deployment, to ensure secure access to Automation 360 online services, add the service URL list to the safe recipients or trusted list.

[Add service URLs to trusted list for On-Premises](#) on page 1322

For On-Premises deployment, to ensure secure access to Automation 360 online services, add service URL list to the safe recipients or trusted list.

## Set user device credentials

To enable a device for running bots, set the local device credentials.

The Bot Agent is a lightweight application that enables you to run bots on your device by connecting the device to the Control Room. To run bots on a local machine, install the Bot Agent and add the local device to the list of enabled host devices. Add the local device before editing the credentials. See [Install Bot Agent and register device](#) on page 1347.

For Community Edition users, your profile contains only one set of credentials at a time. These credentials are applied to any of your registered devices you select to run your bots. Ensure each device that you use accepts the credentials in your profile.

Automation 360 Cloud users have the option to apply different credentials to registered devices.

1. In the Control Room panel, click your user name and select **My settings**.
2. In **My Settings** page, navigate to **Devices > Credentials** section to update the **Username** and **Password** for the device.

Device login credentials are required to run a bot from this device.

---

**Note:** Automation 360 does not validate the device login credentials until you run a bot.

---

If your username is part of a domain, include the domain within the format `domain \username`. Typically, home users are not part of a domain, unless they are specifically configured.

3. Save the changes.

[Create your first bot](#) on page 1489

Related tasks

[Install Bot Agent and register device](#) on page 1347

Install Bot Agent on your local device and connect it to Control Room. In order to run bots on that local device, ensure that you add it to the list of enabled host devices.

## View and update Bot Agent device settings

View your local device details and update the bot running device settings. The local device is the one from which you access the Bot Agent. The bot running device is the one on which the recorder will record your automations and run the bots.

You must have the register device, view and manage all devices, attest device credentials, and edit devices permissions to perform this task. See [Credential requirements](#) on page 1197.

This task is performed by a user to select a local user or remote Bot Agent device to create and run bots.

1. In the Control Room, click your username and select the **My settings** link.
2. In the **Devices > Bot running device** section, click **Edit**.
3. Select a bot running device.
4. Save the changes.

---

**Note:** To update the local device settings, click the device name link. This will open the **Devices** page for your local device in view mode.

---

Related concepts

[Manage device settings](#) on page 1797

Control Room administrator can configure the device settings to automatically set a user's default device when that user logs into Control Room.

## Bulk install Bot Agent on devices

Installing Bot Agent across multiple devices such as on-premises machines, virtual machines (VM), and non-persistent virtual desktop infrastructure (VDI) including Amazon WorkSpaces is called Bulk install (or silent install). You must edit the Bot Agent MSI file for bulk installation.

To perform the task, you must have a administrator account with the required rights and permissions.

- Ensure that you have downloaded the MSI file from the Control Room and the parameters required to install devices are available in the Bot Agent MSI file.

---

**Note:** If you are trying to download the MSI file for the first time, you must click **Settings > Bot agent bulk install > Edit > Save changes** to generate a registration key and view the **Download installer** for the MSI file. .

---

- Ensure that the Windows 10 Software Development Kit including Orca is installed on the device.

You can install Orca from `C:\Program Files (x86)\Windows Kits\10\bin\10.0.18362.0\x86\Orca-x86_en-us.msi`.

**Note:** You can find a sample `autoregistration.properties` file at the end of the page for your reference.

1. Use the latest `AutomationAnywhereBotAgent.msi` file from the following locations:
  - Download the file from the Control Room (**Administrator** > **Settings** > **Bot agent bulk install**).

The download option is available for On-Premises and Cloud deployments.

  - Select the file from the `<application filepath>\crui\asset` folder. For example `c:\Program Files\Automation Anywhere\crui\asset`

This option is available only for On-Premises deployments.
2. Edit the `AutomationAnywhereBotAgent.msi` file using the Orca tool.
3. Click the **Property** option.
4. Enter appropriate values for the following parameters:

Parameter	Description
AA_CRURL	Enter the Control Room instance to which the Bot Agent will to be connected.  <b>Note:</b> Ensure you do not add a backslash (/) at the end of the Control Room URL. For example, <code>mycr.mydomain.com/</code> .

Parameter	Description
AA_CRTOKEN	<p>Enter the corresponding registration key value for each Control Room. The registration key is provided by the Control Room admin.</p> <p>You can configure up to 20 Control Room URLs. Ensure that:</p> <ul style="list-style-type: none"> <li>• You provide the corresponding registration tokens under AA_CRTOKEN, AA_CRTOKEN2 through AA_CRTOKEN20 for each configured Control Room URL.</li> <li>• There is a one-to-one match between CR_URL and CR_TOKEN.</li> <li>• There is no skipping between CR_URL and CR_TOKEN, and this is filled consecutively.</li> </ul> <p>For example, to configure three Control Room URLs, it must be populated in the following order: AA_CRURL, AA_CRURL2, AA_CRURL3.</p> <p>See <a href="#">Generate registration key to install Bot Agent in bulk</a> on page 1836.</p>
AA_DELAY_REGISTRATION_UNTIL_LOGIN	<p>Enter <code>True</code> to delay the Bot Agent registration to a Control Room until a user logs in to that Control Room.</p> <p>If a user logs in to any of the Control Room instances configured from the device where the Bot Agent is installed, the Bot Agent on that device will be automatically registered with that associated Control Room. If the logged-in Control Room URL is not configured, then Bot Agent is not registered with that Control Room.</p>
AA_DEVICE_TYPE	<p>Enter one of the following values for the device type:</p> <ul style="list-style-type: none"> <li>• <code>SINGLE_USER</code></li> <li>• <code>MULTIPLE_USERS</code></li> </ul> <hr/> <p><b>Note:</b> Ensure that you enter the values in uppercase.</p> <hr/>

Parameter	Description
AA_LIFESPAN	<p>Enter one of the following values for a non-persistent or persistent device:</p> <ul style="list-style-type: none"> <li>• TEMPORARY</li> <li>• PERSISTENT</li> </ul> <hr/> <p><b>Note:</b> Ensure that you enter the values in uppercase when you install the Bot Agent.</p>
AA_CONCURRENT_SESSIONS	<p>Enter the concurrent sessions allowed, from 1 through 99. The default value is 1.</p> <hr/> <p><b>Note:</b> The concurrent sessions are only applicable for multi-user devices (AA_DEVICE_TYPE = Multiuser)</p>
AA_INSTALL_ONLY	<p>Choose whether you want to install the Bot Agent without registering with the Control Room.</p> <ul style="list-style-type: none"> <li>• Enter <code>True</code> to only install and not register the Bot Agent.</li> </ul> <hr/> <p><b>Note:</b></p> <p>The <code>autoregistration.properties</code> file is created when <code>AA_INSTALL_ONLY</code> is set to <code>True</code>. You can set <code>AA_INSTALL_ONLY</code> to <code>True</code> only for system-level installation.</p> <hr/> <ul style="list-style-type: none"> <li>• Enter <code>False</code> to install and register the Bot Agent.</li> </ul>
AA_DEVICE_POOL_NAME	<p>Specify the device pool name. The default value is 0.</p> <hr/> <p><b>Note:</b> Ensure that you use an existing device pool.</p>

5. Save the changes.
6. Copy the `AutomationAnywhereBotAgent.msi` file to the VM instance (golden image) on which you want to install the Bot Agent.

---

**Note:** Ensure that you do not restart the VM instance (golden image).

---

7. Run the `AutomationAnywhereBotAgent.msi` file.
8. Validate that the Bot Agent is installed on the VM instance and Bot Agent service is not running in the Task Manager Services tab.

---

**Note:** An `autoregistration.properties` file will be generated at:

```
C:\Windows\System32\config\systemprofile\AppData\Local
\AutomationAnywhere\autoregister
```

---

To deploy the Bot Agent on temporary or non-persistent devices, you must configure the SysPrep settings and create machine images on the VM instance.

9. Shut down the VM instance without SysPrep after you enable temporary or non-persistent computer name settings for the VM.  
For an example of how to use SysPrep on AWS EC2 instance, see [Use Sysprep to create and install custom reusable Windows AMIs](#).
10. Create machine images on the VM instance as required.  
For an example of how to create Amazon Machine Images (AMI) from an AWS EC2 instance, see [Create an AMI from an Amazon EC2 Instance](#).

If a Bot Agent is registered in the VM instance by mistake, perform these steps to restore the machine image:

1. Uninstall the Bot Agent from the Windows Control Panel of the VM instance.
2. Delete all files from `C:\Windows\System32\config\systemprofile\AppData\Local\AutomationAnywhere`.
3. Enter `True` for the `AA_INSTALL_ONLY` parameter in the `AutomationAnywhereBotAgent.msi` file that you previously used to install the Bot Agent.
4. Run the `AutomationAnywhereBotAgent.msi` file again.

Sample `autoregistration.properties` file

```
url=http://ec2-myexampleCR.com
url2=URL2
url3=URL3
url4=URL4
token=eyJhbGciOiJSUzUxMiJ9.eyJjbGllbnRUeXB1IjoiQk9UX0FHRU5UX0FVVE9fUkVHSVNUUkFUSU90IiIjKlVONeupDQF4IQ3oZbjpyk73vrLI2k0UeTVpvKuURbZhz8bPIBYer4z1zRjEB-9nOID8MtNRcpz1XgkQ27GENIMzer-R8sxMnr7hSfi_aYDx8emyoH2XtFAQAYuXiw6vOXWalo-TYDtPknIJsga6aAifJ9-w6ndJAov0JvTClmeyLQgBA
token2=t2
token3=t3
token4=t4
device_type=MULTIPLE_USERS
concurrent_sessions=4
lifespan=TEMPORARY
delay_registration_until_login=true
```

Validate that the devices are added on the Control Room **Devices** page.

Related concepts

[Bot Agent device requirements](#) on page 1340

Review the Bot Agent device requirements such as hardware components, compatible devices, supported operating systems and browser extensions.

Related tasks

[Configure temporary devices](#) on page 1803

Configure your device settings to automatically delete a temporary device when the device is disconnected from the Control Room after a certain time interval.

[Generate registration key to install Bot Agent in bulk](#) on page 1836

The Control Room administrator can generate a registration key to install the Bot Agent on multiple devices at a time in bulk.

[Edit the Bot Agent installer file](#) on page 1837

Edit the Bot Agent MSI installer file to add the registration key and Control Room URL to remotely install the Bot Agent on multiple devices.

Related reference

[Bot Agent compatibility](#) on page 1332

Before you install the Bot Agent, ensure that you review the compatible Automation 360 builds.

[Devices](#) on page 1873

The device is a machine through which a user connects to the Control Room to create or run bots. Manage devices that are registered to the Control Room through the **Devices** page located in the **Manage** tab.

## Bulk install Bot Agent using Microsoft Endpoint Configuration Manager

Install Bot Agent in bulk on multiple devices from a central location using the Microsoft Endpoint Configuration Manager or System Center Configuration Manager (SCCM).

- Ensure that Microsoft SCCM is installed on two machines, first on a machine that hosts the Control Room primary site and distribution server and then on a second machine that hosts the database server to store and process all client-server communication and operations.
- Ensure that the latest `AutomationAnywhereBotAgent.msi` file is downloaded from one of the following locations based on your Control Room deployment:

- For On-Premises and Cloud: **Administrator > Settings > Bot agent bulk install**
- For On-Premises: `<application filepath>\crui\asset` folder

For example, `C:\Program Files\Automation Anywhere\crui\asset`.

1. Add parameters in the `AutomationAnywhereBotAgent.msi` file using the Orca tool.  
For detailed steps, see [Bulk install Bot Agent on devices](#) on page 1354.
2. Configure the Bot Agent application in SCCM.
  - a) Add general details, such as application name.  
For example, Automation Anywhere Bot Agent Windows installer (\*.msi file).
  - b) Add content details, such as content location, settings for uninstalling, and deployment options.  
For example:
    - Content location: `\\crserver\msibackup\`
    - Settings for content uninstalling: Same as install content
    - Deployment options: Download content from distribution point and run locally

- c) Provide the program commands required to install the application.  
For example, `msiexec /i "AutomationAnywhereBotAgent.msi"/q`.
- d) Provide the application detection method to determine whether the application is already installed on a device.  
The SCCM automatically detects and adds the clause for the msi file.
- e) Provide user experience details, such as installation behavior (install for system or user), logon requirement, installation visibility (interactive or hidden), and whether or not to enforce configuration manager behavior.  
For example:
  - Installation behavior: Install for system
  - Logon requirement: Whether or not a user is logged on
  - Installation visibility: Hidden

For more information, see [Create and deploy an application with Configuration Manager](#).

3. Distribute the application on devices using the SCCM Distribution Point (DP).  
To install the Bot Agent, configure the DP on the primary server on which the Control Room is installed. It is important to ensure that after the application is created, it is distributed properly to DP and it can be monitored in SCCM.  
For more information, see [Install and configure distribution points in Configuration Manager](#).
4. Use boundaries in SCCM to virtually partition the devices identified through domains, subnets, or a range of IP addresses.  
Boundaries help in segregating the DP for different applications and can be configured through the hierarchy configuration section from the Administration option of SCCM.  
For more information, see [Define network locations as boundaries for Configuration Manager](#).
5. Right-click Automation Anywhere Bot Agent application to deploy the Bot Agent using the SCCM Applications option.  
For more information, see .
6. Verify that the devices are added on the Control Room **Devices** page.

#### Related tasks

[Install Bot Agent and register device](#) on page 1347

Install Bot Agent on your local device and connect it to Control Room. In order to run bots on that local device, ensure that you add it to the list of enabled host devices.

[Bulk install Bot Agent on devices](#) on page 1354

Installing Bot Agent across multiple devices such as on-premises machines, virtual machines (VM), and non-persistent virtual desktop infrastructure (VDI) including Amazon WorkSpaces is called Bulk install (or silent install). You must edit the Bot Agent MSI file for bulk installation.

[Edit the Bot Agent installer file](#) on page 1837

Edit the Bot Agent MSI installer file to add the registration key and Control Room URL to remotely install the Bot Agent on multiple devices.

#### Related reference

[Devices](#) on page 1873



The device is a machine through which a user connects to the Control Room to create or run bots. Manage devices that are registered to the Control Room through the **Devices** page located in the **Manage** tab.

## Update Bot Agent

Updating to the latest Bot Agent version enables users to use new features available in the Automation 360 release.

A Control Room administrator can choose between updating the Bot Agent version automatically or manually when a new version becomes available.

### Automatically update the Bot Agent

Using the auto-update capability to update the Bot Agent to a later version reduces the downtime because each user is not required to log into the Control Room to update the Bot Agent version.

Ensure that you are logged in to the as the administrator.

The automatic update of the Bot Agent is based on the following:

- All user devices are connected to the Control Room.
- The Automation 360 deployment you use.
- The following update settings:
  - In Automation 360 v.21 and earlier, the Bot Agent update setting was **Auto update** by default. Therefore, the Bot Agent was updated automatically when Automation 360 was updated. Starting from Automation 360 v.22, the default setting for the Bot Agent update was **Auto update** for Cloud and Community Edition, but was optional for On-Premises.
  - Starting from Automation 360 v.29, the Bot Agent update was set to manual for On-Premises by default to provide users control on the Bot Agent update. Therefore, if the default setting in the Control Room for updating the Bot Agent is not changed, when updating to Automation 360 v.29 the default value for updating the Bot Agent is set to manual to ensure the Bot Agent version is not updated automatically. To manually update Bot Agent, see [Manually update the Bot Agent](#) on page 1362.

1. Navigate to **Administration > Settings > Devices**.
2. Select **Bot-agent software** settings.
3. Click the **Edit** icon. 
4. For automatic updates of the Bot Agent, you can choose either all updates (required and optional) or only the required updates.

Option	Description
Auto update optional and mandatory	Automatically update the Bot Agent for both required and optional updates.  During the update, new bot deployments on the Bot Runner user devices are queued.

Option	Description
Auto update mandatory updates only	<p>Automatically update the Bot Agent only for required updates.</p> <p>During the update, new bot deployments on the Bot Runner user devices are queued.</p> <hr/> <p><b>Note:</b> When you update Automation 360 to version 30, the mandatory update feature for the Bot Agent is turned off. Therefore, the Bot Agent will not be automatically updated even if you have selected the <b>Auto update mandatory updates only</b> option.</p> <hr/>

**Note:** To set manually update the Bot Agent, choose **Disable auto updates** option.

5. Optional: [Update the Bot Agent from a local drive](#) on page 1364.
6. Click **Save changes**.

Verify the Bot Agent version and device connection in the **Devices** page of the Control Room.  
Related tasks

[Manually update the Bot Agent](#) on page 1362

Update the Bot Agent to an available version manually. The Bot Agent version available for download is the latest and compatible with the Control Room version that is used.

Related reference

[Devices](#) on page 1873

The device is a machine through which a user connects to the Control Room to create or run bots. Manage devices that are registered to the Control Room through the **Devices** page located in the **Manage** tab.

[Bot Agent compatibility](#) on page 1332

Before you install the Bot Agent, ensure that you review the compatible Automation 360 builds.

## Manually update the Bot Agent

Update the Bot Agent to an available version manually. The Bot Agent version available for download is the latest and compatible with the Control Room version that is used.

- To install the Bot Agent, the Windows installer policy must be enabled for the user device.
- The read, write, and execute permissions must be enabled for the Bot Agent folders on the user device.

Some of the Bot Agent version updates are optional and does not affect your existing bots. For more information, see [Bot Agent compatibility](#) on page 1332.

- Update the Bot Agent on connected host devices
  - a) Use your Automation Anywhere URL to log in to the Control Room as an administrator or a user with administrator privileges.
  - b) Click **Manage > Devices**.  
On the **Devices** page, the device status indicates if the Bot Agent requires an update. The arrow color on the device icon indicates the status:

- Red: Update required
- Blue: Update available but not required
- Green: Most recent version; no update required

- c) Select the device where you want to update the Bot Agent and click the **Update checked items** icon (🔍).

The **Status** of the device changes while the update is in progress. After the update is complete, the **Status** changes to **Connected**.

---

**Note:** If you have multiple devices, ensure that you select only the devices with the **Status** as **Connected**, and click the **Update checked items** icon to update the Bot Agent. However, if all the listed devices are connected to the Control Room, you can select the **Check all** check box and click the **Update checked items** icon.

---

Video: See the following video on updating the Bot Agent on connected host device:

- Update the Bot Agent on a locally connected device or a remote device using the local device option

You can update the Bot Agent on a locally connected device or a remote device without manually downloading and installing the Bot Agent.

- a) On the home screen, at the bottom-left corner, click the **Local device** icon (📍).
- b) In the **Bot running device** window, click **Update now**.  
The **Status** for the devices changes to indicate the progress of the update. After the update is complete, the **Status** changes to **Connected**.

Video: See the following video on how to update the Bot Agent on a locally connected device:

Video: See the following video on how to update the Bot Agent on a remote device using the local device option:

- Update Bot Agent on the locally connected device using the connect local device option  
You can update the Bot Agent on your locally connected device by manually downloading and installing the Bot Agent.

a) From the Devices page, click the **Connect local device** icon (📍) at the top-right corner of the devices table.

b) Click **Connect to my computer**.

c) Click the **Manually download the latest version** link.

d) After the `AutomationAnywhereBotAgent.exe` is downloaded, install the Bot Agent and follow the instructions on the installation wizard to complete the installation.

e) After the Bot Agent installation is complete, go back to Automation 360 Control Room and click **Next**.

f) Follow the instructions on the screen to complete the update.

Video: See the following video on how to update the Bot Agent on the locally connected device using the connect local device option:

The following message is displayed: `Connected to your computer. Your local bot agent has been successfully installed configured.`

If you see the following message displayed: `Device is disconnected or needs upgrade!`, see [Error: Device is disconnected or needs upgrade \(A-People login required\)](#)

Verify the Bot Agent version and device connection in the **Devices** page of the Control Room.

Related tasks

[Automatically update the Bot Agent](#) on page 1361

Using the auto-update capability to update the Bot Agent to a later version reduces the downtime because each user is not required to log into the Control Room to update the Bot Agent version.

Related reference

[Devices](#) on page 1873

The device is a machine through which a user connects to the Control Room to create or run bots. Manage devices that are registered to the Control Room through the **Devices** page located in the **Manage** tab.

[Bot Agent compatibility](#) on page 1332

Before you install the Bot Agent, ensure that you review the compatible Automation 360 builds.

## Update the Bot Agent from a local drive

As a Control Room administrator, you can download the Bot Agent installation file to a local machine and update the Bot Agent from the local drive.

Ensure that the Bot Agent installation file is downloaded to the local machine.

---

**Important:** This functionality is implemented in v.26 and can be used from v.27. That is, after you update your Bot Agent to v.26, future updates can be performed from the local drive.

---

Update the Bot Agent on several devices by providing the local file path to the installation file.

1. Navigate to **Administration > Settings > Devices** and click the **Edit** icon (✎).
2. Go to the **Bot-agent software** settings.
3. Click the **Edit** icon. (✎)
4. In the **Bot agent installation** section, select the **Update bot agent from local drive** option.  
When the **Update bot agent from local drive** option is enabled, the device checks for the installation file in the local drive and use it to update the Bot Agent.

---

**Note:** If an installation file is not available in the local drive or not compatible with Control Room, the Bot Agent will be updated with the latest version from the Control Room.

---

5. Enter the file path to the Bot Agent installation file in your local drive.  
For example: `C:\Temp\AutomationAnywhereBotAgent.exe` or `\\network-share-name\foldername1\AutomationAnywhereBotAgent.exe`
6. Click **Save changes**.

## Perform Bot Agent diagnostic checks

Use the Bot Agent diagnostic utility for connectivity-related issues between the Bot Runner device and Control Room. The utility helps to diagnose issues either by providing solutions or suggestions to help resolve the issues.

Ensure the Bot Agent is installed on the user device.

1. Open the Windows command prompt.

2. Navigate to the Bot Agent installation path.
  - Default path for Bot Agent installed at system level is C:\Program Files\Automation Anywhere\Bot Agent.
  - Default path for Bot Agent installed at local user level is %USERPROFILE%\AppData\Local\Programs\Automation Anywhere\Bot Agent.
3. Enter AADiagnosticUtility.exe to run the Bot Agent diagnostic utility.  
Various options to perform the diagnostic check are displayed with their descriptions.

Option	Description
<code>-checkDownloadError &lt;CR_URL&gt;</code>	<p>Check for bot dependency download errors if the bot deployment fails.</p> <hr/> <p><b>Note:</b> Error messages are maintained in the device memory and are removed when the Bot Agent service is restarted.</p> <hr/> <p>Use this option when the Bot Runner device is connected to the Control Room but automations fail because the dependent packages are not downloaded on the Bot Runner device. In this case, the utility provides suggestions for further diagnosis.</p>
<code>-checkProxy &lt;CR_URL&gt;</code>	<p>Check the proxy settings on the device.</p> <p>When the Bot Runner device is unable to connect to the Control Room, use this option to verify if a proxy is available or configured for the Bot Agent to use.</p> <p>You are also provided the option to import proxy settings using the <code>importProxy</code> option.</p> <hr/> <p><b>Note:</b> Your device proxy settings for authenticated proxy can be set during the Bot Agent registration process and can be updated through the Bot Agent diagnostic utility. The same credentials are used for all users on the device.</p>

Option	Description
<p><code>-checkWSError &lt;CR_URL&gt;</code></p>	<p>Check for WebSocket connectivity and errors.</p> <hr/> <p><b>Note:</b> Error messages are maintained in the device memory and are removed when the Bot Agent service is restarted from Services tab of the Windows Task Manager.</p> <hr/> <p>When a Bot Runner device is unable to connect to the Control Room because of WebSocket connection errors, this option provides the possible reasons for further investigation.</p>
<p><code>-collectLogs</code></p>	<p>Reduce the turnaround time for collecting information on issues by capturing multiple logs for the Bot Runner device.</p> <p>Use this option to capture and save current day node manager, bot launcher, and event viewer logs for debugging and troubleshooting in a zipped folder on the device where the utility is being run.</p> <ul style="list-style-type: none"> <li>For Bot Agent installed at system level, the logs are saved in <code>C:\ProgramData\AutomationAnywhere\BotRunner\Logs\bot_agent_logs_&lt;datetimestamp&gt;.zip</code></li> <li>For Bot Agent installed at local-user level, the logs are saved in <code>%USERPROFILE%\AppData\Local\AutomationAnywhere\BotRunner\Logs\bot_agent_logs_&lt;datetimestamp&gt;.zip</code></li> </ul> <hr/> <p><b>Note:</b></p> <ul style="list-style-type: none"> <li>To capture Windows logs for security events, run the utility with elevated privileges (run as administrator). If you run the utility without elevated privileges, the following error is displayed: <code>Error: Unable to capture security_event_viewer_&lt;date&gt;.evtx</code></li> <li>To save storage space, delete the file after debugging.</li> </ul>

Option	Description
<code>-configProxy &lt;CR_URL&gt;</code>	<p>Check proxy configuration and configure proxy credentials, if required.</p> <p>When the Bot Runner device is unable to connect to the Control Room because of missing credentials for an authenticated server, use this option to configure the proxy server credentials. Verify that the connectivity problem is resolved by logging in to the Control Room.</p>
<code>-importProxy &lt;CR_URL&gt;</code>	<p>Import the proxy settings from a logged-in user device to the system user device.</p> <hr/> <p><b>Note:</b> You must have administrator permission to import proxy settings.</p> <hr/> <p>When the Bot Runner device is unable to connect to the Control Room because of proxy server issues, use this option to import the proxy settings from a logged-in user to the system user for the Bot Agent.</p> <p>This option provides information about the following:</p> <ul style="list-style-type: none"> <li>• Whether the proxy server is authenticated or not.</li> <li>• Control Room URL is added to the safe recipients list in the proxy server.</li> <li>• WebSocket connections are allowed as part of the proxy configuration.</li> </ul>
<code>-importSSLCertificate path_to_ssl_certificate</code>	<p>Import a SSL certificate into the Java credential store, if required.</p> <hr/> <p><b>Note:</b> You must have administrator permission to import the SSL certificate.</p> <hr/> <p>When the Bot Runner device is unable to connect to the Control Room because of an invalid SSL certificate, use this option to import the SSL certificate. You must ensure a valid certificate file is available in the file location specified in the <code>importSSLCertificatepath_to_ssl_certificate</code> option.</p> <p>You must restart the Automation Anywhere Bot Agent service so that the imported certificate becomes effective.</p>

Option	Description
-list	View active bot deployments on the local devices.  Use this option to check and list the automation (bots) that are running.
-ping <CR_URL>	Check connectivity between the Control Room and Bot Runner devices.  Use this option to check if a Bot Runner device can ping (reach) the Control Room.
-validateSSLCertificate <CR_URL>	Check for a valid SSL certificate and view whether the certificate is valid or invalid.  <b>Note:</b> You must have read permission to perform this check.  When the Bot Runner device is unable to connect to the Control Room because of an invalid SSL certificate, use this option to check and view if the SSL certificate is valid or not. To resolve the issue, use the <code>importSSLCertificate</code> option.

4. Enter the following option in the command prompt: <filepath>  
`\AADiagnosticUtility.exe -<option> <CR_URL>`  
 For example, to verify WebSocket errors, enter the following in the command prompt:  
`AADiagnosticUtility.exe -checkWSError https://yourcrurl.com/`  
 The option returns the following result: Recently this device have not encountered any Web Socket errors

Use the other options to perform further diagnostic checks.

## Uninstall and reinstall Bot Agent

We recommend that you update to the most recent version of Bot Agent in order to use the latest features available in Automation 360 and resolve any possible issues that you might encounter during bot runs.

Review the following instructions to uninstall and reinstall Bot Agent:

1. On your Windows device, go to **Control Panel > Programs and Features**.

**Note:** The navigation to your programs might be different based on the Windows version installed on your device.

2. Click **Automation Anywhere Bot Agent > Uninstall**.

Follow the instructions in the Bot Agent uninstallation wizard.

Bot Agent is uninstalled from your device along with all the associated registry files and folders.

3. Log in to Control Room.



4. Select one of the following options to install the Bot Agent and add a local device:
  - Go to the **Devices** page, and click the **Connect local device** icon located at the top-right of the **Devices** list.
  - From the menu on the left, click the **Device** icon to connect to a local device.
5. Click **Connect to my computer**.

The Bot Agent setup file is downloaded to your local device.
6. Run the setup file and perform the installation steps.

For more information, see [Install Bot Agent and register device](#) on page 1347.

The latest version of Bot Agent associated with the Automation 360 version that you are using is installed on your device.

## Installing Control Room for Cloud-enabled deployment

With Cloud-enabled deployment, you can store and process native business and operational data on site and take advantage of management and operational services delivered from Automation Anywhere Cloud.

Automation Anywhere deploys and provisions an Automation 360 Cloud-enabled service instance in our cloud to deliver management and operational capabilities. Customer then installs the Cloud-enabled application within their infrastructure to consume these capabilities for storing and processing customer data.

---

**Note:** Linux is not supported for Cloud-enabled deployments.

---

For Cloud-enabled deployment, the initial welcome email that you received from Automation Anywhere contains:

- URL to the Automation Anywhere Cloud-enabled instance
- Provisioning token needed to establish trust connectivity with the Automation Anywhere Cloud Control Room

---

**Important:** Do not discard the content of this email. You will need the information in the email to setup on-premises application.

---

1. Receive your Automation 360 Cloud-enabled service URL from Automation Anywhere and provisioning token.
2. Install and access the On-Premises application.

Download and install the Cloud-enabled application on your network; the installation user is assigned administrator privileges.

[Installing Control Room On-Premises](#) on page 1177
3. Log in to the On-Premises Control Room.

[Log in to Automation Anywhere Control Room](#) on page 1488
4. Navigate to **Administration > Settings > Cloud-Enabled**.
5. Provide the provisioning token to connect to the Control Room.
6. Click **Save changes**.

The trusted relationship between the instances is created.

7. To test Cloud-Enabled functionality, open a browser, enter the URL of the Cloud Control Room service instance, and press Enter.  
You are redirected to the On-Premises Control Room.

Related concepts

[Post-installation user management](#) on page 1371

After completing the post-installation tasks, validate the setup by logging in to the Control Room and installing a license. First time access to the Control Room walks you through the configuration for your authentication method.

Related tasks

[Install Bot Agent and register device](#) on page 1347

Install Bot Agent on your local device and connect it to Control Room. In order to run bots on that local device, ensure that you add it to the list of enabled host devices.

Related reference

[Installed Control Room directories and files](#) on page 1398

When installing the Automation Anywhere Control Room on different operating systems, the installer executes and installs files and folders in the following directories.

## Naming guidelines for Control Room URLs

Adhere to Domain Name System (DNS) guidelines when you configure domain and subdomain Control Room URLs for On-Premises and Cloud deployments.

### Guidelines for On-Premises Control Room deployments

By following these DNS guidelines, you can successfully register your Bot Agent with the On-Premises Control Room. According to RFC 952, RFC 1035, and RFC 1123, the following guidelines apply when creating names for domain and subdomain URLs:

- The host name can be up to 63 characters in length and can contain the following characters:
  - Uppercase characters (A–Z)
  - Lowercase characters (a–z)
  - Numerals (0–9)
  - Hyphens (-)
- The host name should not consist of all numeric values.
- The host name should not start nor end with a hyphen (-).
- The URL domain and subdomain names should not contain the underscore character (\_).

---

**Note:** Instead of an underscore (\_), use a hyphen (-).

---

## Guidelines for Cloud Control Room deployments

By following DNS guidelines, you can successfully register your Bot Agent with the Cloud Control Room. The Cloud Control Room URL syntax is: `https://<domainname>.myautomationanywhere.digital`, where `<domainname>` is configurable.

- The domain name can be up to 27 characters in length and can contain the following characters:
  - Lowercase characters (a–z)
  - Numerals (0–9)
  - Hyphens (-)
- The domain name should not consist of all numeric values.
- The domain name should not start nor end with a hyphen (-).
- The URL domain and subdomain names should not contain the underscore character (\_).

---

**Note:** Instead of an underscore (\_), use a hyphen (-).

---

Related reference

[Automation 360 Cloud prerequisites](#) on page 1166

Use the checklist to determine whether your device fulfills the requirements for registering with Automation 360 Cloud.

[Automation 360 On-Premises prerequisites](#) on page 1180

Determine whether the system has the required hardware and software to install Control Room for Automation 360 On-Premises.

## Post-installation user management

After completing the post-installation tasks, validate the setup by logging in to the Control Room and installing a license. First time access to the Control Room walks you through the configuration for your authentication method.

[Configure Control Room authentication options](#) on page 1373

The options for launching the Control Room for the first time and the authentication method depend on the installation mode and deployment type.

Validate services

Validate that the following services are running in automatic mode:

- Automation Anywhere Control Room Caching
- Automation Anywhere Control Room Messaging
- Automation Anywhere Control Room Reverse Proxy
- Automation Anywhere Control Room Service
- Automation Anywhere Elastic Search Service
- Automation Anywhere Bot Compiler Service

- Automation Anywhere Control Room IQ Bot Service
- Automation Anywhere Control Room Robotic Interface Service
- Automation Anywhere Control Room Discovery Bot Service
- Automation Anywhere Control Room Discovery Bot ML Service
- Automation Anywhere Control Room Storage Service

[Users](#) on page 1737

As an administrator, you can create, view, edit, delete, and enable or disable a user. Creating users steps vary depending on whether the user is a non-Active Directory, Active Directory, or single sign-on (SSO) user from an IdP server.

Related tasks

[Complete Control Room post-installation configuration](#) on page 1315

After installing the Control Room, complete the configuration settings to ensure timely Automation Anywhere communications are specified and confirm Automation Anywhere services are running.

## Configure Control Room as a service provider

A valid SAML IdP setup must be configured before the Control Room can be switched to a SAML-authentication environment.

This task is performed by a network administrator on SAML IdP. You must have the necessary privileges to complete this configuration.

Create a user in Active Directory to match one of your Control Room Admin users. This user tests the Control Room configuration as the last step in the configuration. We recommend that you do not test SAML login with a non-Admin Control Room user access, or you risk having a Control Room that has no Admin user.

Complete the necessary network-side preparations to switch the Control Room to act as the service provider in the SAML IDP setup.

1. Create an application on a SAML IdP.  
For information on commonly used SAML IdPs, see [Automation 360 - Change control room authentication to SAML based SSO](#).
2. Set the ACS or service provider URL to `<Enterprise Control Room URL>/v1/authentication/saml/assertion`.

---

**Note:** Ensure that you do not configure the SAML assertions for single logout.

---

3. Configure the application that is created in the SAML IdP to map the key user attributes defined in the IdP to be used in the Control Room.  
Key attributes include: **UserID**, **FirstName**, **LastName**, and **EmailAddress**.  
This value is required when setting up the Control Room to use SAML IdP.
4. Optional: Provide access to users on the application created on SAML IdP.

**Note:**

- Download the SAML IdP metadata and share it with the Control Room administrator for setting up the Control Room.
  - The SAML assertion includes an authentication statement that must include the SessionIndex attribute. As per the SAML specifications, the assertion ID is used as the session index. The purpose of the SessionIndex attribute is to identify which sessions to logout during SAML logout.
- 

```
<saml2:AuthnStatement  
  AuthnInstant="authenticated_instance" SessionIndex="index_value_required">
```

[Set up SAML authentication on the Control Room](#)

Related tasks

[Set up SAML authentication](#) on page 1390

Switch user authentication for Control Room from Control Room database to SAML single sign-on (SSO).

## Configure Control Room authentication options

The options for launching the Control Room for the first time and the authentication method depend on the installation mode and deployment type.

The authentication options for Control Room in Cloud and Cloud-enabled deployments differ from the options for On-Premises deployment (installed using the Custom mode).

After the installation (Custom mode) is complete, configure the Control Room in Custom mode to authenticate users with an Active Directory (AD), Control Room database, or single sign-on (SSO).

---

**Note:** The Active Directory authentication mode is available for On-Premises deployment and not for Cloud and Cloud-enabled deployments.

---

Based on your installation mode (express or custom) and deployment type (On-Premises, Cloud, and Cloud-enabled), select any of the following authentication methods for the Control Room:

- After an Express mode installation, configure the Control Room in Express mode using the default settings.  
[Configure Control Room in Express mode](#) on page 1374
- Authenticate users using Active Directory by manually adding the LDAP URLs.  
[Configure Control Room for Active Directory: manual mode](#) on page 1375
- Authenticate users using Active Directory by enabling the Control Room to discover and list domains and sites in your organization.  
[Configure Control Room for Active Directory: auto mode](#) on page 1378
- Authenticate users using the database option.  
[Configure Control Room database](#) on page 1384

- Configure an authenticated environment Control Room database to a SAML identity provider (IDP).  
[Set up SAML authentication](#) on page 1390
- Configure the environment for Smart Card, X.509 Certificate authentication.  
[Configure Smart Card authentication installation procedure](#) on page 1381

## Configure Control Room in Express mode

After completing the installation in Express Mode, configure the Control Room in Express Mode using the default settings.

To configure Control Room when you start it for the first time, do the following steps:

1. Open Control Room in a browser to launch the **Getting Started** wizard.
    - **Windows:** Double-click the Automation Anywhere Control Room icon on the desktop.
    - **Linux:** Open a browser and navigate to the Linux server hostname. Example: `server1.mycompany.com`
  2. Update the following fields:
    - **Username:** Enter a user name.
    - **First name** Enter the first name.
    - **Last name** Enter the last name.
    - **Email** Enter an email address.
    - **Password** Enter a password.
    - **Confirm password** Confirm the password.
  3. Click **Next**.  
The **Create security questions** page appears.
  4. Enter three security questions and answers.
  5. Click **Next**.  
The **Credential settings** page appears.
  6. Select from the following options:
    - **Express mode:**The system stores your Master Key to connect to the Credential Vault on the Control Room filesystem. This option is not recommended for a production environment.
    - **Manual mode:** You store the Master Key on your own, and then provide the Master Key when the Credential Vault is locked. Users use the Master Key to connect to the Credential Vault to secure their credentials and access them when creating and running Task Bots.
- 
- Important:** If you lose the key, you will not be able to access the Control Room.
- 
7. Click **Save and log in**.  
You are logged in to the Control Room as an administrator. You can now configure and manage the overall RPA environment with Control Room and clients.

After configuring the Control Room, install product licenses.

## Configure Control Room for Active Directory: manual mode

Configure the Control Room to authenticate users using Active Directory by manually adding the Lightweight Directory Access Protocol (LDAP) URLs.

To configure the Control Room when you start it for the first time, do the following:

1. Open the Control Room URL that is sent by your system administrator in your browser.

2. Type the repository path.

This is the location where the uploaded automation files, for example, IQ Bots, and Task Bots are stored. For example, `C:\ProgramData\AutomationAnywhere\Server Files`.

3. Enter the access URL.

This is the URL for accessing your installation of Control Room.

4. Click **Save and continue**.

---

**Important:** The **back** button of your web browser is automatically disabled after you click **Save and continue**. This ensures that the Credential Vault Master Key that generates matches the repository path and Control Room access URL.

To return to the Configure Control Room settings page, press `Ctrl` plus `F5` and restart.

---

The Credential Vault settings page appears.

5. Select from the following options:

- **Express mode:** The system stores your Master Key to connect to the Credential Vault. This option is not recommended for a production environment.
- **Manual mode:** You store the Master Key on your own, and then provide the Master Key when the Credential Vault is locked. Users use the Master Key to connect to the Credential Vault to secure their credentials and access them when creating and running Task Bots.

---

**Important:** If you lose the Master Key, you will not be able to access the Control Room.

---

6. Click **Save and continue**.

---

**Important:** The **back** button of the web browser is automatically disabled after you click **Save and continue**. No further changes to the Control Room configuration or Credential Vault settings are allowed.

To make changes, reinstall the Control Room.

---

The Authentication type for Control Room users page appears.

7. Select Active Directory.

Automation Anywhere supports Active Directory Multi-Forest authentication for the Control Room. Before providing the Authentication Type, ensure the following:

- One-way or two-way trust is set up between all forests. For a one-way trust, this is from the Enterprise Client forest to the Control Room forest (Control Room forest must always be the trusting forest).
- Two-way trust is set up for every domain in a forest.
- The root certificate of the LDAP server is imported using the provided CertMgr tool through the command.

- The provided LDAP URLs per forest cannot be behind a load balancer. Also, all LDAP URLs must point to the root (main) domain controllers.
- The node that runs the Control Room is in the same domain network where the Active Directory runs.
- The user is in the parent domain and the URL points to the parent.

This ensures that when there are two or more forests, and one of the forest has a subdomain with a different name space, a user from the other forests does not have permission to access that subdomain.

**8.** Type the Global Catalog URL.

For example, `ldap://server01.domain.com`.

For failsafe authentication, click the plus option to provide additional LDAP URLs.

---

**Note:** For users and groups from one or more Active Directory domains, to access the Control Room, use a fully qualified host name of the Global Catalog (GC) server, listening on port 3268 (3269 if SSL).

---

When adding LDAP URLs, ensure that you provide a fully qualified host name like `ldap://server01.ldap.com`.

Provide URLs of multiple Global Catalogs per forest so that if one Global Catalog in a forest goes down, the other can serve. This feature does not provide support for the load-balanced URL.

You must enter the Domain username and password and click **Manually add connections** to enter the LDAP URLs.

**9.** Provide service account credentials

Ensure that the username provided is a user in the Domain Users group and ideally and be set up in Active Directory with a **password never expires** option. If otherwise, there will be some downtime in RPA authentication as the service account password is reset. Provide the username in a User Principal Name (UPN) in the `username@domain.com` format and password.

**10.** Click **Check connection**.

If Control Room is unable to connect to the Active Directory database, an error message appears.

**11.** Click **Next**.

The Control Room first administrator page appears.

**12.** Select the **Active Directory domain** from the drop-down list and type the Control Room administrator username.

**13.** Click **Check name in Active Directory**.

If the username is in the Active Directory the following user details are shown:

- **First name**
- **Last name**
- **Email**

You can edit these prepopulated fields.

**14.** Click **Save and log in**.



You are logged in to the Control Room as an administrator. You can now configure and manage the overall RPA environment with Control Room and clients.

After configuring the Control Room, install product licenses.

Related tasks

[Configure Control Room for Active Directory: auto mode](#) on page 1378

Configure the Control Room to authenticate users using Active Directory by enabling the Control Room to discover and list domains and sites in your organization.

## Configure LDAP channel binding

Configure LDAP channel binding in Automation 360 On-Premises for enhanced security in network communications between an Active Directory and its clients. This method provides a more secure LDAP authentication over SSL and TLS.

Enable channel binding in the `um.properties` file when required.

1. Go to the Control Room installation path.
2. From the list of files in the `config` folder, open the `um.properties` file with an XML editor.
3. Add the `um.ldap.channel.binding.enabled` property in the `um.properties` file. For example, `um.ldap.channel.binding.enabled=false`
4. To enable channel binding, change the value to `true`.  
The default value is `false` and channel binding is disabled.  
Channel binding is enabled if it is enabled on the server side.

For information about enabling channel binding on the server side, see [LDAP enforce channel binding registry entry](#).

5. Save the file.

## Configuring LDAP signing

LDAP signing provides enhanced security for network communications between an Active Directory and its clients.

To configure LDAP signing, perform these steps:

1. Go to the Control Room installation path.
2. From the list of files, open the `um.properties` file with an XML editor such as Notepad++.
3. Define the `um.ad.quality.of.protection` property in the `um.properties` file. For example, `um.ad.quality.of.protection=auth-int`

Select one of the following options to define the value of the property.

Option	Description
<b>auth</b>	<p>Authentication only</p> <p>If secure LDAP (LDAPS) is enabled, this option is used as the default value and this option will work whether required signing is enabled or not.</p> <p>If LDAP and required signing are enabled, this option will not work.</p>

Option	Description
<b>auth-int</b>	Authentication and integrity protection This is the default value when LDAPS is not enabled. This option will work whether required signing is enabled or not.
<b>auth-conf</b>	Authentication with integrity and privacy protection If required LDAP signing is enabled, configure this option if you want more security such as privacy protection.

4. Save the file and restart these services: Automation Anywhere Control Room Caching, Automation Anywhere Control Room Messaging, and Automation Anywhere Control Room Service.

## Configure Control Room for Active Directory: auto mode

Configure the Control Room to authenticate users using Active Directory by enabling the Control Room to discover and list domains and sites in your organization.

To configure the Control Room when you start it for the first time, do the following:

1. Double-click the Automation Anywhere Control Room icon on your desktop.  
The Configure Control Room settings page appears.
2. Type the repository path.  
This is the location where the uploaded automation files, for example, IQ Bots, and Task Bots are stored. For example, `C:\ProgramData\AutomationAnywhere\Server Files`.
3. Enter the access URL.  
This is the URL for accessing your installation of Control Room.
4. Click **Save and continue**.

---

**Important:** The **back** button of your web browser is automatically disabled after you click **Save and continue**. This ensures that the Credential Vault Master Key that generates matches the repository path and Control Room access URL.

To return to the Configure Control Room settings page, press `Ctrl` plus `F5` and restart.

---

The Credential Vault settings page appears.

5. Select from the following options:
  - **Express mode:** The system stores your Master Key to connect to the Credential Vault. This option is not recommended for a production environment.
  - **Manual mode:** You store the Master Key on your own, and then provide the Master Key when the Credential Vault is locked. Users use the Master Key to connect to the Credential Vault to secure their credentials and access them when creating and running Task Bots.

---

**Important:** If you lose the Master Key, you will not be able to access the Control Room.

---

6. Click **Save and continue**.

**Important:** The **back** button of the web browser is automatically disabled after you click **Save and continue**. No further changes to the Control Room configuration or Credential Vault settings are allowed.

To make changes, reinstall the Control Room.

---

The Authentication type for Control Room users page appears.

**7.** Select Active Directory.

Automation Anywhere supports Active Directory multi-forest authentication for the Control Room. Before providing the authentication type, ensure the following:

- For one-way trust between forests:
  - The Bot Agent devices are in one or more forests and the Control Room is in a different forest, the Control Room must be in the trusting forest.
  - Set up trust between the forest that contains the Control Room and each of the forests containing the Bot Agent devices.
  - Domains containing Bot Agent devices and the Control Room must be configured with two-way trust between the domains.
- For two-way trust between forests:
  - In the scenario where the Bot Agent devices are in one or more forests and the Control Room is in a different forest, all forests containing Bot Agent device and the Control Room are configured with two-way trust between forests.
  - Set up trust between all forests containing the Control Room and the Bot Agent devices.
  - Domains containing Bot Agent devices and the Control Room must be configured with two-way trust between the domains.
- The root certificate of the LDAP server is imported using the provided CertMgr tool via command.
- The provided LDAP URLs per forest cannot be behind a load balancer. Also, all LDAP URLs must point to the root (main) domain controllers.
- The node that runs the Control Room is in the same domain network where the Active Directory runs.
- The user is in the parent domain and the URL points to the parent.

This ensures that when there are two or more forests, and one of the forest has a sub-domain with a different name space, a user from the other forests does not have permission to access that sub-domain.

**8.** Type the Domain username.

Ensure you use the User Principal Name (UPN) in the `username@domain.com` format. The username you enter is for a user who has access to all domains using the same credentials.

**9.** Type the Domain password.

This user is not expected to use the Control Room. Although you have an option to update the password, use an Account with the password never expires option. If it expires, it can be updated but with some downtime.

**10.** Click **Discover connections**.

All discovered Active Directory domains with one or more sites per domain are shown.

By default, all domains and sites are selected. If only one domain and one site under it is discovered, then it is shown in read-only mode and cannot be edited.

You can configure the maximum number of sites per domain that can be discovered across multiple domains by adding the following property in the `um.properties` file saved in `<installation path>/config`:

```
um.ldap.auto.discovery.find.max.sites=<number of sites>
```

For example, you can configure auto-discovery for a maximum of 15 sites per domain by adding the entry `um.ldap.auto.discovery.find.max.sites=15` in the `um.properties` file. This means that for every domain that you have, a maximum of 15 associated sites can be discovered per domain.

---

**Note:** If this property is not configured, by default, 10 sites per domain will be discovered.

---

- 11.** Select the domains and sites to use for authentication.

Select the domains and sites to use for authentication. Select a minimum of one site for each domain that is selected

- 12.** Click **Test connections** to register the sites to use for authentication.

- 13.** Click **Check connection**.

If Control Room is unable to connect to the Active Directory database, an error message appears.

- 14.** Click **Next**.

The Control Room first administrator page appears.

- 15.** Select the **Active Directory domain** from the drop-down list and type the Control Room administrator username.

- 16.** Click **Check name in Active Directory**.

If the username is in the Active Directory the following user details are shown:

- **First name**
- **Last name**
- **Email**

You can edit these pre-populated fields.

- 17.** Click **Save and log in**.

You are logged in to the Control Room as an administrator. You can now configure and manage the overall RPA environment with Control Room and Bot Agent.

After configuring the Control Room, install product licenses.

Related tasks

[Configure Control Room for Active Directory: manual mode](#) on page 1375

Configure the Control Room to authenticate users using Active Directory by manually adding the Lightweight Directory Access Protocol (LDAP) URLs.

[Configure Control Room database](#) on page 1384

Configure the Control Room to authenticate users using the database option.

## Configure Smart Card authentication installation procedure

Configure the Control Room to authenticate users using the Smart Card option.

To perform the task, you must have a administrator account with the required rights and permissions.

Follow these steps to configure your Cloud Control Room to use Smart Card, X.509 certificate authentication.

1. Configure the secondary hostname to point to the Control Room load balancer.  
This process defines the secondary hostname used for authentication requests when the Control Room is configured for Smart Card authentication. The secondary hostname is configured within the Control Room load balancer automatically. Both the primary and secondary hostnames must be configured within the DNS system used by the Control Room environment (add DNS entries for primary and secondary hostnames - external to Control Room).
2. How to obtain Java KeyStore with trusted CA certificates.  
Configure the location the Control Room will check for Certificate Authority (CA) certificates used to authenticate user certificates for user logins.

**Note:** The certificates in this location are the server certificates for the CAs that will issue the user certificates.

Option	Action
Periodically scan the following location	This setting allows the administrator to define the path to keystore file containing the CA certificates. Use this setting if you periodically update the CA truststore and set the frequency of the scan.
Upload the KeyStore manually	This setting allows the administrator to load a keystore file containing the CA certificates. Use this setting if your CAs are known and static and indicate whether or not the keystore is password protected. If the keystore is password protected, supply and confirm the password.

3. Select the revocation checking method.  
Revocation checking configures the Control Room to reject authentication requests for certificates that have been revoked.

Option	Action
Online Certificate Status Protocol (OCSP)	Use this setting if your CA has OCSP implemented.
Certificate Revocation List	Use this setting if you maintain a static list of revoked certificates.

Option	Action
No Revocation Checking	<p>Using this setting the Control Room will not perform revocation check.</p> <hr/> <p><b>Note:</b> This is not recommended for production deployments where revocation will typically be used.</p> <hr/>

**4. Use the other method if selected method fails**

This setting will attempt to use the non-selected method of revocation checking if the configured method fails.

**5. Allow user to authenticate even if revocation status cannot be determined**

Use this setting to assure users can authenticate if either of the revocation check method fails.

**6. Configure user name mapping.**

User name mapping specifies which attribute of the user certificate is used for the Control Room username. The user name must be configured in the Control Room prior to the user logging into the Control Room and must match the user name derived from the certificate.

**a) Obtain user name from**

Certificate subject

Use this setting if the Control Room user name is the same as the string in the Subject field for the user certificate.

Universal Principal Name

Use this setting if the Control Room user name is the same as the string in the Universal Principal Name field for the user certificate.

**b) Use Regular Expression**

Enter Regular Expression that will filter the Control Room user name from the selected field of the user certificate. This may not be necessary if the Control Room user name is the same as the data within the selected certificate field.

**7. Configure first name mapping.**

First name mapping specifies which attribute of the user certificate is used for the Control Room username. The first name must be configured in the Control Room prior to the user logging into the Control Room and must match the user first name derived from the certificate.

**a) Obtain first name from**

Certificate subject

Use this setting if the Control Room first name is the same as the string in the Subject field for the user certificate.

Universal Principal Name

Use this setting if the Control Room user name is the same as the string in the Universal Principal Name field for the user certificate.

**b) Use Regular Expression**

Enter Regular Expression that will filter the Control Room user first name from the selected field of the user certificate. This may not be necessary if the Control Room user first name is the same as the data within the selected certificate field.

**8.** Configure last name mapping.

Last name mapping specifies which attribute of the user certificate is used for the Control Room username. The last name must be configured in the Control Room prior to the user logging into the Control Room and must match the user last name derived from the certificate.

**a) Obtain last name from**

Certificate subject

Use this setting if the Control Room last name is the same as the string in the Subject field for the user certificate.

Universal Principal Name

Use this setting if the Control Room user name is the same as the string in the Universal Principal Name field for the user certificate.

**b) Use Regular Expression**

Enter Regular Expression that will filter the Control Room user last name from the selected field of the user certificate. This may not be necessary if the Control Room user last name is the same as the data within the selected certificate field.

**9.** Configure email address mapping.

Email address mapping specifies which attribute of the user certificate is used for the Control Room username. The email address must be configured in the Control Room prior to the user logging into the Control Room and must match the user last name derived from the certificate.

**a) Obtain last name from**

Certificate subject

Use this setting if the Control Room email address is the same as the string in the Subject field for the user certificate.

Universal Principal Name

Use this setting if the Control Room user name is the same as the string in the Universal Principal Name field for the user certificate.

**b) Use Regular Expression**

Enter Regular Expression that will filter the Control Room user email address from the selected field of the user certificate. This may not be necessary if the Control Room user email address is the same as the data within the selected certificate field.

**10.** Click **Next**.

## Control Room smart card first administrator

After configuring the smart card authentication process, an administrator user is needed. This process will walk you through setting up the first administrator for the Control Room.

To perform the task, you must have a administrator account with the required rights and permissions.

When authenticating with smart cards, the authenticating system will send a signal to the operating system to "Insert Smart Card" and prompt the user, from the smart card software, to select the certificate to use for authentication.

The following steps guide you through setting up your first administrator user with smart card authentication installed.

You should be on the correct configuration page if you have completed [Configure Smart Card authentication installation procedure](#) on page 1381.

**1.** Navigate to > **Control Room first administrator.**

**2.** Insert the smart card for the administrator.

**3.** Click **Authenticate and pre-fill user data.**

This will start the smart card authentication process and pre-fill data from the selected certificate base on the mappings defined during the configuration of the Certificate (smart card) authentication installation process. If any information requires correction, click the **Back** button and make the necessary changes.

**4.** Verify the data.

View the Username, First Name, Last Name, and Email Address that is pre-filled and verify that these data points were correctly mapped during the smart card authentication installation procedure.

**5.** Click **Save and log in**

The configuration of Certificate (smart card) authentication strategy is complete.

After configuration of the smart card authentication process, the login page of the Control Room will display only the "Insert CAC/PIV" option for authenticating the user. Pressing this button will start the smart card authentication process and the browser will signal a smart card login request to the operating system which will then prompt the user to insert their smart card and possibly an optional PIN.

The user selects the appropriate certificate on the smart card and proceeds with the Control Room login.

## Configure Control Room database

Configure the Control Room to authenticate users using the database option.

To configure the Control Room when you start it for the first time, do the following:

**1.** Open a browser and navigate to the Control Room URL.

The Configure Control Room settings page appears.

- Windows

Double-click the Automation Anywhere Control Room icon on your desktop.

- Linux



Open a browser and navigate to the host name of the server on which you installed Automation Anywhere Control Room. For example, `myserver.mycompany.com`

---

**Note:** Do not retain the forward slash at the end of the URL, as the validation will fail.

---

2. Enter the repository path.

- Windows

This is the location where the uploaded automation files (such as IQ Bots, and Task Bots) are stored. For example,

`C:\ProgramData\AutomationAnywhere\Server Files`

- Linux

`/opt/automationanywhere/enterprise/appdata`

3. Enter the access URL.

This is the URL for accessing your Control Room installation.

4. Click **Save and continue**.

---

**Important:** The **back** button of your web browser is automatically disabled after you click **Save and continue**. This ensures that the Credential Vault Master Key that generates matches the repository path and Control Room access URL.

To return to the Configure Control Room settings page, press `Ctrl` plus `F5` and restart.

---

The Credential Vault settings page appears.

5. Select from the following options:

- **Express mode:** The system stores your Master Key to connect to the Credential Vault. This option is not recommended for a production environment.
- **Manual mode:** You store the Master Key on your own, and then provide the Master Key when the Credential Vault is locked. Users use the Master Key to connect to the Credential Vault to secure their credentials and access them when creating and running Task Bots.

---

**Important:** If you lose the Master Key, you will not be able to access the Control Room.

---

6. Click **Save and continue**.

---

**Important:** The **back** button of the web browser is automatically disabled after you click **Save and continue**. No further changes to the Control Room configuration or Credential Vault settings are allowed.

You must reinstall the Control Room to make any changes.

---

The Authentication type for Control Room users page appears.

7. Select **Control Room database**.

Select from Active Directory, Single Sign-On (SAML 2.), Certificate (Smart Card), or Control Room database. Please refer to those configuration topics for specific steps and processes.

8. Click **Next**.

The Control Room first administrator page appears.

9. Fill in the following fields:

- **Username:** Enter a user name.
- **First name** Enter the first name.
- **Last name** Enter the last name.
- **Email** Enter an email address.
- **Password** Enter a password.
- **Confirm password** Confirm the password.

**10.** Click **Next**.

The **Create security questions** page appears.

**11.** Enter three security questions and answers.

**12.** Click **Save and log in**.

You are logged in to the Control Room as an administrator. You can now configure and manage the overall RPA environment with Control Room and clients.

Install a license.

Related tasks

[Configure Control Room for Active Directory: manual mode](#) on page 1375

Configure the Control Room to authenticate users using Active Directory by manually adding the Lightweight Directory Access Protocol (LDAP) URLs.

[Configure Control Room for Active Directory: auto mode](#) on page 1378

Configure the Control Room to authenticate users using Active Directory by enabling the Control Room to discover and list domains and sites in your organization.

## Change Control Room configuration to HTTPS from HTTP mode

If your Control Room is configured for HTTP mode, you can change the configuration to HTTPS mode. You must use a self-signed certificate either before or after performing a custom Control Room configuration.

Transportation Layer Security is configured as part of the Control Room installation. If that step was skipped or the certificate expires, configure the TLS certificate with this post-installation configuration.

---

**Important:** It is not recommended to use self-signed certificates. However, if you use a self-signed certificate, ensure you install the certificate on each device manually and accept the certificate to enable communication between the device and the Control Room after configuring the self-signed certificate.

---

- 1.** Log in to the Control Room.  
The Control Room instance launches in your default browser.
- 2.** Change the Control Room URL setting and port to **HTTPS** and port number to **443**.  
The **Website Security Warning** page is displayed.
- 3.** Select the **Force HTTP Traffic to HTTPS** check box.
- 4.** Continue to the Control Room website to access the Control Room.

[Configure Control Room authentication options](#) on page 1373

If you have already configured it, then log in to the Control Room.

Related tasks

[Import HTTPS, intermediate, and CA certificates](#) on page 1387

After you install the Control Room for an On-Premises deployments, you can use the Windows or Linux command prompt to import all or some of these certificate:

[Configure application Transport Layer Security](#) on page 1249

Use the **Transport Layer Security (TLS) configuration** wizard page from the Automation 360 installer to generate a self-signed certificate or import a security certificate to set up a highly secure Control Room instance.

## Intermediate certificates

Intermediate certificate are used to determine if a certificate is issued by a valid and trusted root certification authority (CA).

The certificate chain or certification path is a list of certificates with intermediate certificate issuers. The certificate chain or certification path verification check starts with a leaf certificate and each certificate in the chain is checked by the entity identified by the next certificate in the chain until the root certificate is verified.

The certificate chain verification will fail if following sample conditions are encountered:

- Certificates are expired.
- Certificates do not have a valid signature.
- Certificates do not have a valid issuing CA.

The server makes intermediate certificates available to the client as part of the secure connection established between the client and server. An intermediate certificate is used to determine if a certificate was issued by a valid root CA. The root CA certificate issues or signs the intermediate certificate, and the intermediate certificate issues or signs a TLS certificate. If the intermediate certificate is not installed on the sever where the TLS certificate is installed, then applications might not trust the server TLS certificate. To have clients trust the TLS certificate, you must make the intermediate certificates available on the server.

## Import HTTPS, intermediate, and CA certificates

After you install the Control Room for an On-Premises deployments, you can use the Windows or Linux command prompt to import all or some of these certificate:

- HTTPS
- Intermediate
- Certificate Authority (CA)

You can import HTTPS, intermediate, and CA certificates in the following scenarios:

- When you switch the Control Room from HTTP to HTTPS after Automation 360 is installed.
- The certificates expire or need modification, for example, when you add a new server.

These instructions apply to both Windows and Linux installations.

To import an HTTPS, intermediate, or CA certificate to configure the Control Room for secure connection using the command prompt, perform the following steps:

1. Run the command prompt in administrator mode.
2. Navigate to the Automation Anywhere installation path.

The default installation path for Windows is `C:\Program Files\Automation Anywhere\Automation360`.

The default installation path for Linux is `/opt/automationanywhere/enterprise`

**3.** Enter or paste the following at the command prompt:

- For Windows, if only server certificate is required or if the intermediate certificates are required and all certificates are in a single file (single file with certificate chain), then enter the command:

```
jdk11\bin\java -jar certmgr.jar -appDir "C:\Program Files
\Automation Anywhere\Automation360" -setServerCert "C:\Users
\cradmin\Desktop\test_automationanywhere_com.pfx" -privateKeyPass
<PFX Password>
```

- For Windows, if intermediate certificates are required and the server certificate file does not contain any intermediate certificates, then copy all the intermediate certificates to a directory on your device and use the directory path in the following command. Enter the command only after you have updated it with the required values:

```
jdk11\bin\java -jar certmgr.jar -appDir "C:\Program Files
\Automation Anywhere\Automation360" -setServerCert "<path to P12/
PKCS12 certificate file>" -privateKeyPass <cert file password> -
intermediateCertDir "<path to unzipped certs directory>"
```

---

**Note:**

- Importing intermediate certificate is supported on Windows only.
- Password protected intermediate certificates are not supported.

- 
- For Windows CA certificate, enter the command:

```
jdk11\bin\java -jar certmgr.jar -appDir "C:\Program Files
\Automation Anywhere\Automation360" -importTrustCert "D:\<user
name>\My Downloads\CA31.cer"
```

- For Linux CentOS HTTPS certificate, enter the command:

```
jdk11/bin/java -jar certmgr.jar -appDir "/opt/
automationanywhere/enterprise" -setServerCert "/home/<user>/
test_automationanywhere_com.pfx" -privateKeyPass <PFX Password>
```

- For Linux CentOS CA certificate, enter the command:

```
jdk11/bin/java -jar certmgr.jar -appDir
"/opt/automationanywhere/enterprise"
-importTrustCert "CA31.cer"
```

- 4.** Restart the Control Room Reverse Proxy Service to view the imported certificates.
- 5.** During the installation, if you did not accept the default and indicated you want to upload your own (self-signed) certificate, add the following parameters to the `boot.db.properties` file that is located in the `config` folder, in the Automation Anywhere installation path.

- Windows file location:

```
root:\Program Files\Automation Anywhere\config\boot.db.properties
```

- Linux file location:

```
/opt/automationanywhere/enterprise/config/boot.db.properties
```

Parameter:

```
trustServerCertificate=false
```

## Add Control Room certificate to Windows certificate stores

To ensure that the Bot Agent is registered successfully and works as intended, manually add or update the Control Room certificate to the Windows certificate stores. Perform this task if the Windows certificate stores does not accept the certificate and you see a certificate path validation error.

You must reinstall the certificates in the Windows certificate stores if the Bot Agent is updated.

To resolve the certificate on the browser of the Bot Agent machine, download and install the certificate.

---

**Note:** On-Premises users can import intermediate certificates and server certificate to their Control Room. If the certificates are issued by an intermediate Certificate Authority (CA), import the intermediate certificates to your server. To import intermediate certificates, see [Import HTTPS, intermediate, and CA certificates](#) on page 1387.

We recommend that you have the CA root certificates made available on client devices.

---

1. To download the certificate using Google Chrome, perform these steps:
  - a) Open the Control Room instance used to access the Bot Agent.
  - b) Press the function key F12 to open the developer window.
  - c) Navigate to the **Security** tab and click the **View certificate** option. The **Certificate Viewer** window appears.
  - d) In the **Details** tab, click the **Export** option.
  - e) Select a Base-64 encoded option from the Save as type drop-down list.
  - f) Save the file to a location of your choice.
  
2. To import the certificate, perform these steps:
  - a) Open a command window.
  - b) Enter `MMC` to launch the console window.
  - c) Select the **Add/Remove Snap-in** option from the **File** menu.
  - d) Double-click **Certificates** option and then select **Computer account** in the **Certificates snap-in** window.
  - e) Click **Next** and select the **Local Computer** option in the **Select Computer** window.
  - f) Click **Finish**.
  - g) Click **OK** to return to the console window.
  
3. Now add the certificates to the **Trusted Root Certification Authorities** and **Trusted Publishers** folders.
  - a) Double-click the **Certificates** name.

- b) Right-click the **Trusted Root Certification Authorities** name.
  - c) Select the **Import** option from the **All Tasks** menu.  
The **Certificate Import Wizard** is launched.
  - d) Click **Next**.
  - e) Click **Browse** and select the certificate that was saved.
  - f) Click **Next** and select the option to place all certificates in a store.
  - g) Click **Next** and click **Finish** to import the certificates.  
The certificate is imported successfully.
  - h) Repeat the above steps to import certificates in the **Trusted Publishers** folder.  
The console window now shows the certificates imported for current user.
4. Restart the Bot Agent device to validate that the device is registered successfully.

For more information on troubleshooting steps, see [Automation 360: Error while registering device - An unexpected problem occurred \(A-People login required\)](#).

## Preparing for users

After completing initial installation and depending upon your deployment option, the post-installation configuration and validation, you are ready to prepare for users to login and work with bots.

See [Users](#) on page 1737.

## Set up SAML authentication

Switch user authentication for Control Room from Control Room database to SAML single sign-on (SSO).

---

**Note:** SAML integration is irreversible. After it has been established, you cannot modify the configuration.

When using SAML for authentication, use the network access capabilities of the IdP to restrict access of the Control Room to specific allowed IP addresses. Ensure all allowed IP addresses configured are removed from the Control Room network settings before switching to SAML for authentication. For more information, see [Add access public IP addresses](#) on page 1808.

---

Ensure that you are logged in to the as the administrator.

Before you set up authentication for the Control Room, setup tasks (such as introducing credentials on a new system and importing users) might be required. If you import users, then you must also include matching user IDs, email addresses, first and last names, in both the Automation Anywhere credentials and matching records to log in after the SAML integration. For example, if using Okta as a SSO, then users must have matching IDs, email addresses, first name and last names in both Automation Anywhere and Okta to log in after the SAML integration.

You should have the required user information and certificate ready. Typical user information consists of user ID, first and last name, and an email address.

**Note:** You must validate the SAML IdP setup before you configure the Control Room. See [Configure Control Room as a service provider](#) on page 1372.

After switching to SAML authentication, any users with non-SAML IdP formatted IDs will not be able to log in. You need to verify that any bots in the private workspace of such users are exported beforehand so that the bots can be imported for their new SAML SSO enabled user accounts.

Much of this configuration relies on third-party applications to create the necessary metadata. If you require more specific configuration information based on a specific provider, see [Configure SSO authentication with Okta](#) on page 1392.

To switch the Control Room to SAML SSO, follow these steps.

1. Navigate to **Administration > Settings > User authentication**.
2. Select the **Use SAML** option.

**Note:** The **Use Control Room database** option is selected by default.

3. In the **SAML metadata** field, enter the metadata from your SAML IdP setup. The following shows an example SAML2 response:

```
<saml:AuthnStatement AuthnInstant="2022--10-24T13:41:04Z"
  SessionIndex="_dc2ab824-cb14-40d3-8e7f-d823193fd6a2">
  <saml:AuthnContext>
    <saml:AuthnContextClassRef>
      urn:oasis:names:tc:SAML:2.0:ac:classes:Password
    </saml:AuthnContextClassRef>
  </saml:AuthnContext>
</saml:AuthnStatement>
```

**Note:** SAML metadata format varies based on your IdP.

4. In the **Unique Entity ID for Control Room (Service Provider)** field, enter the entity ID.

**Note:** The Unique Entity ID is defined in SAML IdP to identify the Control Room.

5. In the **Sign authentication requests** field, select one of the following options:

Option	Description
<b>Do not sign</b>	SAML authentication requests are not signed.
<b>Sign</b>	SAML authentication requests are signed.

6. In the **Encrypt SAML Assertions** field, select one of the following options:

Option	Description
<b>Do not encrypt</b>	SAML assertions are not encrypted.
<b>Encrypt</b>	SAML assertions are encrypted.

**Note:** The **Encrypt SAML Assertions** option is automatically enabled when you click the **Validate SAML Settings** button when the following conditions are met:

- You have selected the **Sign** option in the **Sign authentication requests** field.
- You have selected the **Do not encrypt** option in the **Encrypt SAML Assertions** field.

- Optional: Enter the **Public key** and **Private key** values.
  - Public key: Specifies the SAML IdP X.509 format certificate.
  - Private key: Specifies the private key generated for signing SAML authentication requests and/or encrypting SAML assertions for the Control Room.

---

**Note:** Enter keys only if you require signed SAML authentication requests and/or encrypted SAML assertions.

Refer to the following article for generating public and private key pair for signing SAML authentication requests and/or encrypting SAML assertions for Control Room: [How to generate signing certificate public and private keys to sign SAML authentication request](#).

---

- Click **Validate SAML Settings**.

The Control Room will log in through the SAML IdP and redirect back to the **Control Room User Authentication** section on the settings page.

When you click this option, you will be redirected to a SAML 2.0 IdP webpage where you will be prompted to enter your SAML SSO user credentials and other applicable data.

- Log in to your SAML IdP when prompted.
- Click **Save changes**.

The Control Room authentication is switched to SAML SSO.

Related tasks

[Configure Control Room as a service provider](#) on page 1372

A valid SAML IdP setup must be configured before the Control Room can be switched to a SAML-authentication environment.

## Configure SSO authentication with Okta

To log in after SAML integration, configure single sign-on (SSO) authentication with Okta as identity provider (IDP).

---

**Note:** Okta is a third party and might update their user interface (UI) anytime. Hence, the Okta UI references and images here are indicative and meant only for basic guidance.

---

Ensure that the following requirements are fulfilled:

- The Control Room is a secure environment.
- A secure Automation 360 Cloud tenant is used.

- Create a user in Okta and an admin account in Automation 360.

---

**Note:** The user must be created with the same User ID, , First Name, Last Name, and Email Address. You might need to use email address for User ID. During testing, only email address is allowed in Okta.

---

- Generate an SSL certificate with private and public keys.

These keys are required to encrypt the communication between Okta and Automation 360.
- [Create app integration](#) on page 1393.
- [Assign application to the user](#).



5. [Configure the Control Room](#) .
6. [Validate the connection](#).

## Create app integration

Configure Okta on a system before you import users and perform other setup tasks. Create SAML integration in Okta and set the advanced settings and attributes.

When you import users, ensure that they have a matching user ID, email address, first name, and last name in both Automation 360 and Okta to log in after the SAML integration.

1. In Okta, navigate to **Applications** and click **Create App Integration**.

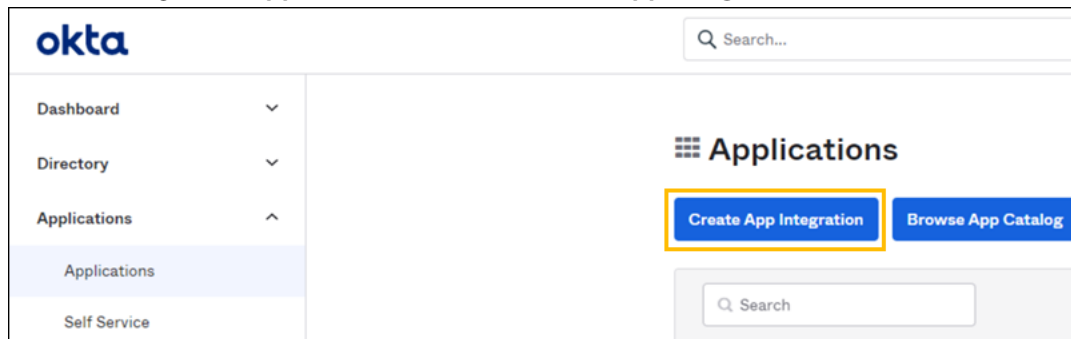

2. Select the **SAML 2.0** sign-in method and click **Next**.
3. In the **App name** field, enter the name of the app and click **Next**.

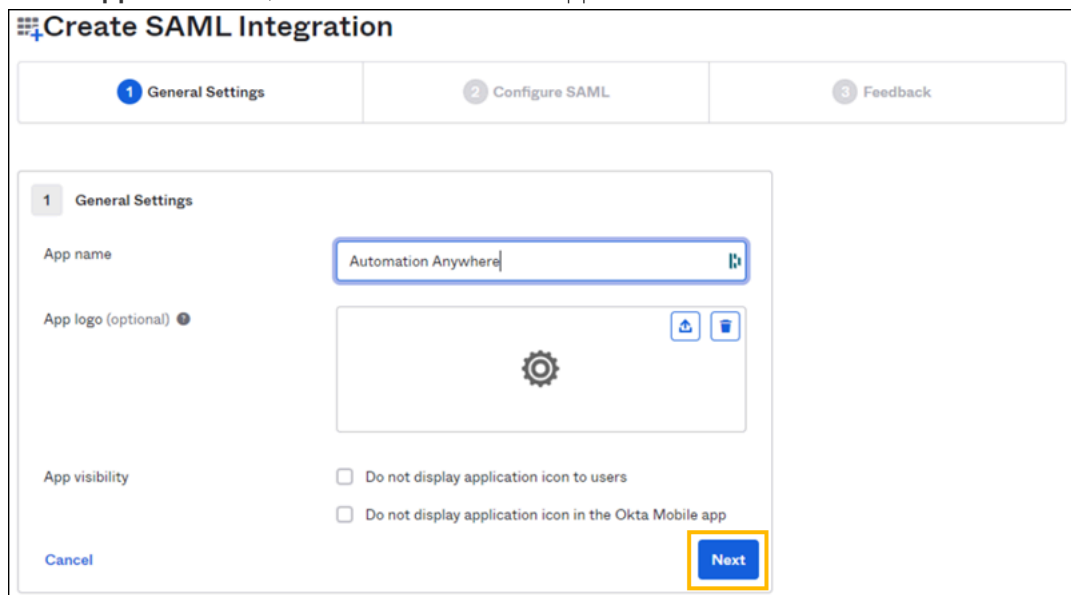

4. Enter the **Single sign-on URL**.  
It is the Assertion URL on the Control Room in the <CRURL>/v1/authentication/saml/assertion format.
5. Enter the **Audience URI**.  
This can be any word or phrase (no spaces). Make note of this term to use in the Control Room configuration.
6. Click **Show Advanced Settings**.
7. In the **Advanced Settings** section, select the **Assertion Encryption** as **Encrypted**.

8. For **Encryption Certificate**, click **Browse files** and select the public key certificate that you generated.

Hide Advanced Settings

Response ?	Signed
Assertion Signature ?	Signed
Signature Algorithm ?	RSA-SHA256
Digest Algorithm ?	SHA256
Assertion Encryption ?	Encrypted
Encryption Algorithm ?	AES256-CBC
Key Transport Algorithm ?	RSA-OAEP
Encryption Certificate ?	<input type="text"/> <a href="#">Browse files...</a>

9. Scroll down to the **Attribute Statements** section and enter attributes, and then click **Next**.

Attribute Statements (optional) [LEARN MORE](#)

Name	Name format (optional)	Value
FirstName	Unspecified	user.firstName
LastName	Unspecified	user.lastName
EmailAddress	Unspecified	user.email
UserID	Unspecified	user.login

[Add Another](#)

10. Select the appropriate option to notify whether you are a customer or a vendor, and then click **Finish**.

11. Scroll down and click **View Setup Instructions**.

The **Identity Provider metadata** field at the bottom is used in the Control Room configuration.

[Assign application to user](#) on page 1396

## Assign application to user

After the application is created, assign it to the user.

1. In Okta, navigate to the **Applications > Assignments** tab.
2. Click **Assign** and select **Assign to People**.

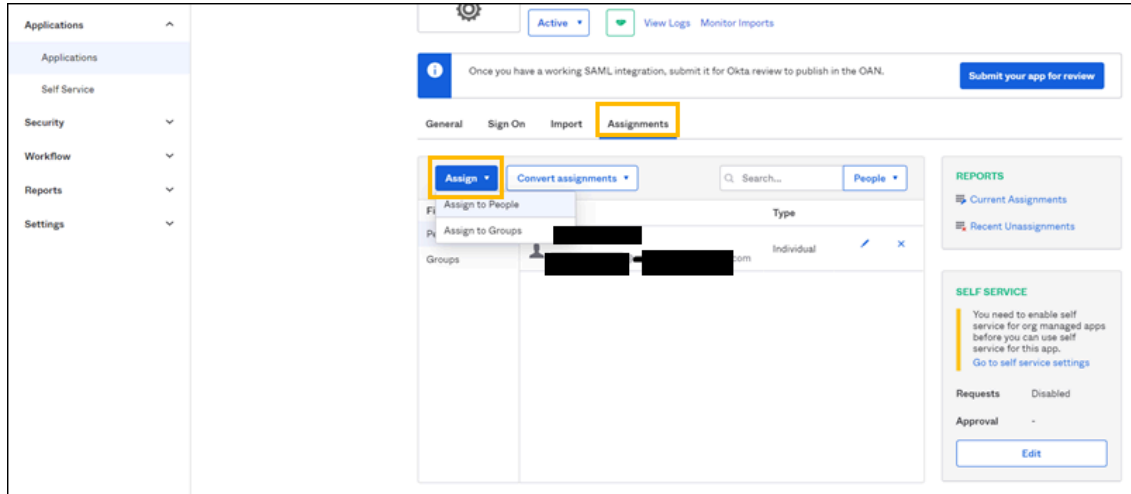

3. Click the **Assign** link that is next to the required user and confirm the assignment, and then click **Done**.

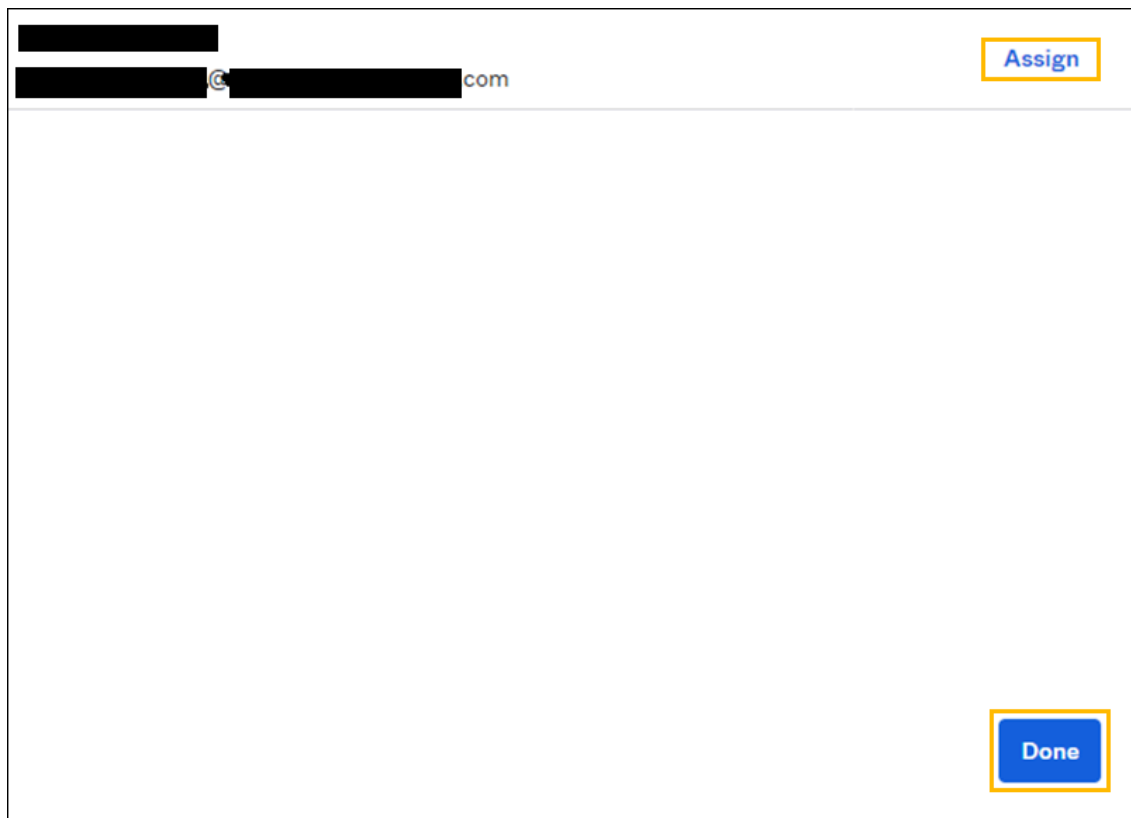

[Configure Control Room for Okta user](#) on page 1397

## Configure Control Room for Okta user

After the application is assigned to the user, configure the Control Room for a user assigned in Okta.

1. Log in to the Control Room as the same user configured in Okta (User ID as Email address on both systems).
2. Navigate to **Administration > Settings > User authentication**.
3. Select **Use SAML**.

---

**Note:** **Use Control Room database** is selected by default.

---

4. In the **Unique Entity ID for Control Room (Service Provider)** field, enter the entity ID.
5. In the **Encrypt SAML Assertions** field, select one of the following options:

Option	Description
<b>Do not encrypt</b>	SAML assertions are not encrypted.
<b>Encrypt</b>	SAML assertions are encrypted.

6. Optional: Enter the **Public key** and **Private key** values.

---

**Note:** Enter the keys only if you require encrypted SAML assertions.

---

[Validate the connection](#) on page 1397

## Validate the connection

After the Control Room is configured, validate the SAML settings.

1. Click **Validate SAML Settings**.  
The Control Room will log in through the SAML provider and redirect back to the **Control Room User Authentication** page.  
When you click this option, you are redirected to a SAML 2.0 service provider web page where you are prompted to enter the credentials and other data.
2. Log in to Okta when prompted and click **Save changes**.

## Edit profile

Manage user profiles.

For users of Control Room configured with a non-directory environment, change the password, first name, last name, and email address.

1. Click the Device icon and select **Update credentials**.  
In the Control Room panel, click your username and select the **My settings** link.
2. In the **Device login credentials** section, enter the **Username** and **Password** for the device.  
In the **My profile** section, click **Edit**.  
Device login credentials are required to run a bot from this device.

---

**Note:** Automation 360 does not validate the device login credentials until you run a bot.

---

If your username is part of a domain, include the domain within the format `domain\username`. Typically, home users are not part of a domain, unless they are specifically configured.

If your username contains non-ASCII characters, ensure your system locale settings are configured to use these characters.

[Configuring post-installation settings](#) on page 1315

3. Enter information for general details, contact info and change password.
4. Click **Update**  
Save the changes.

## Installed Control Room directories and files

When installing the Automation Anywhere Control Room on different operating systems, the installer executes and installs files and folders in the following directories.

### Window OS directory structure

When you install the Automation Anywhere Control Room on Windows OS, the default installation directory for many configuration files is located:

`C:\Program Files\Automation Anywhere\`

### Linux OS directory structure

When you install the Automation Anywhere Control Room on Linux OS, the installer creates the following directories.

Directory path	Description	Comments
<code>/opt/automationanywhere/automation360</code>	All binary files	
<code>/opt/automationanywhere/automation360/config</code>	Config files	
<code>/var/log/automationanywhere/automation360</code>	Log files	
<code>/tmp</code>	Temporary files	Directory that contains temporary files created by the system and users.  Files under this directory are deleted when the system is rebooted.

Directory path	Description	Comments
/opt/automationanywhere/ automation360/appdata/Server Files	Server files	Control Room repository folder.
/opt/automationanywhere/ automation360/_Automation 360_installation/Logs	Installer logs	Installation logs provide details about issues during installation, if any.

## Configuration files

**Note:** Automation 360 supports UTF-8 file encoding type. When you edit or create any Bot Agent or Control Room configuration file, ensure to use UTF-8 file encoding type.

The minimum installed configuration files include:

- Installation license keys - Request the installer and appropriate license keys from your account manager.
- Bot Creator schedules configuration files
  - Log file name: `logging.properties`
  - Log file location: `<install_location>\config`
- Auto-login configuration files
  - Configuration file name: `autologinhelper-logging.xml`
  - Configuration file location: `C:\Program Files\Automation Anywhere\Bot Agent\config`
- Device configuration files
  - Configuration file name: `settings.properties`
  - Configuration file location: `<install_location>\config`
- Database configuration files

The database connection string is configured in:

- Configuration file name: `boot.db.properties`
- Configuration file location: `<installation_location>\config`

Additional configuration files that are created as needed, include:

- Cluster configuration
  - Configuration file name: `cluster.properties`
  - Configuration file location: `<installation_location>\config\`
- Key distribution center (KDC)
  - Configuration file name: `um.properties`
  - Configuration file location: `<installation_location>\config\`

- Parallel repository tuning
  - Configuration file name: `boot.server.properties`
  - Configuration file location: `<installation_location>\config\`
- Remote Desktop Protocol (RDP)
  - Configuration file name: `deployment.properties`
  - Configuration file location: `<installation_location>\config\`
- URL resources
  - Configuration file name: `DWMP_CONNECTIONS.properties`
  - Configuration file location: `<installation_location>\DWAService\bin\src\main\resources`
- Trusted list restrictions
  - Configuration file name: `repository.properties`
  - Configuration file location: `<installation_location>\config\`
- Workload management
  - Configuration file name: `wlm.properties`
  - Configuration file location: `<installation_location>\config`

## Control Room fail-safe status

The Control Room connects to the Automation Anywhere Cloud license server and obtains license entitlements based on the license key that is installed on the Control Room.

A Control Room can enter the fail-safe mode in one of the following scenarios:

1. When the Control Room cannot connect to the license server, it moves into the fail-safe status.
2. When the licenses are oversubscribed on the Control Room, the Control Room moves into the fail-safe status.

With respect to the Control Room license server database, the Control Room is in one of three states. These states indicate what user licensing actions can be performed. With each state change, an entry is made in the audit log.

Active

Normal operations. All API calls from the Control Room are accepted by the license server.

Users can be assigned floating licenses as they log on. Floating licenses can be released as users log off.

When the Control Room is restarted and operational, and connectivity to the license



server is established, the Control Room is in the Active state:

- Users who had licenses assigned prior to the fail-safe have their original licenses reallocated.
- New users can request for and be allocated licenses.

Fail-safe

Only the heartbeat API call is allowed to the license server. All other calls from the Control Room are stopped.

- Fail-safe entry threshold: If the license does not receive the heartbeat from the Control Room for 48 hours, then the license server considers that the Control Room is running in the fail-safe mode. This 48-hour period is called the fail-safe entry threshold.

Fail-safe-expired

The Control Room stops all operations, and all users are logged out of the Control Room.

- Fail-safe expiry threshold: After the license server moves a Control Room into fail-safe mode, it waits up to 30 days to reinstate the license. After 30 days, the status is changed to **Suspended**, and you need to connect to technical support to restore the Control Room to fail-safe mode.

	Fail-safe entry		Fail-safe expiry	
	Due to loss of connectivity	Due to license overconsumption	Due to loss of connectivity	Due to license overconsumption
Days	Two days after loss of connectivity	Two days after overconsumption	30 days from fail-safe entry	30 days from fail-safe entry
Reason	Loss of connectivity/ license server down	License overconsumption. If user licenses are consumed more than allocated, the Control Room displays a message showing the overconsumption.	Loss of connectivity/ license server down	License overconsumption. (Consumption is more than purchased license count.)

	Fail-safe entry		Fail-safe expiry	
	Due to loss of connectivity	Due to license overconsumption	Due to loss of connectivity	Due to license overconsumption
Remedy	Restore connection	Release overconsumed license and sync license with LS or renew the licenses overconsumed. <ul style="list-style-type: none"> <li>You can remove the extra licenses associated with users and resync with the license server by clicking <b>Sync license from server</b>.</li> </ul>	Restore connection	<ol style="list-style-type: none"> <li>1. Renew the overconsumed license.</li> <li>2. Raise support ticket to restore fail-safe entry, and then release the overconsumed license and sync data with license server.</li> </ol>

	Fail-safe entry		Fail-safe expiry	
	Due to loss of connectivity	Due to license overconsumption	Due to loss of connectivity	Due to license overconsumption
Possible operations	<ol style="list-style-type: none"> <li>1. Only license allocation and deallocation is allowed. The data is later synced when connectivity is restored.</li> <li>2. Both admin and non-admin users are able to log in.</li> <li>3. Banner is shown when you log in, along with error message on the license page.</li> <li>4. RPA operations continue normally.</li> </ol>	<ol style="list-style-type: none"> <li>1. All license operations are allowed</li> <li>2. Both admin and non-admin users are able to log in</li> <li>3. Banner is shown when you log in along with error on license page, along with license overconsumption error on license page.</li> <li>4. RPA operations continue normally.</li> </ol>	<ol style="list-style-type: none"> <li>1. Only admin user can log in. Non-admin users cannot log in.</li> <li>2. No license operations are allowed</li> <li>3. Banner is shown when you log in along with error message on license page.</li> <li>4. RPA operations cannot continue.</li> </ol>	<ol style="list-style-type: none"> <li>1. Admin can log in and install licenses.</li> <li>2. No license operations are allowed</li> <li>3. Banner is shown last day before the Control Room shuts down along with overconsumption error on license page</li> <li>4. RPA operations cannot continue.</li> </ol>
Notifications		After the initial 48 hours, you will see a banner in your Control Room with a message about the overconsumption.		On the 30th day, you will see the banner with a red background and a post that the user will not be able to log in. After the 30th day, you will not be able to use the Control Room.

Related concepts

[Licenses and cloud services](#) on page 1404

The Licenses and Cloud Services portal enables you to manage the licenses, Cloud Control Room instances, and cloud RPA services linked to your account. As an Automation Anywhere customer

or partner, and an RPA, Control Room, or IT administrator, you need to manage your entire IT asset framework efficiently to realize the value of your investments.

Related reference

[Automation 360 licenses](#) on page 1407

The **All Licenses** page displays detailed information about current product and device licenses.

[Control Room license expiry notifications](#) on page 1421

The Automation Anywhere Control Room license expiry notifications appear when the Control Room license is about to expire.

## Licenses and cloud services

The Licenses and Cloud Services portal enables you to manage the licenses, Cloud Control Room instances, and cloud RPA services linked to your account. As an Automation Anywhere customer or partner, and an RPA, Control Room, or IT administrator, you need to manage your entire IT asset framework efficiently to realize the value of your investments.

The main functionalities provided by the Licenses and Cloud Services portal are license management and cloud services management for customers and partners.

Customers can perform the following tasks through this portal:

- Provision and manage their cloud services.
- Get details about the globally unique identifiers (GUIDs) of the licenses served from the license cloud.
- Configure and download their license files (where applicable).

Partners can perform the following tasks through this portal:

- Provision and manage their cloud services and their customers' cloud services.
- Get details about their own and their customers' cloud license GUIDs served from the license cloud.
- Configure and download license files for themselves and their customers.

## Overview

To efficiently use and manage their environments, IT and RPA administrators require visibility into license entitlements and a real-time view of available and used licenses. Also, these administrators require visibility into the purchased cloud services and service instances to efficiently manage the RPA requirements of their organizations. The portal helps these users gather this data and view and manage licenses and cloud services.

## Accessing the portal

You can access the Licenses and Cloud Services portal on the A-People site. You must have an account on A-People, and you must be assigned as a designated portal user as part of the sales process.

1. Log in to A-People using your login credentials: [A-People home page \(login required\)](#)
2. Click the **License and Cloud Services** tab.

Alternatively, navigate directly to this page by clicking the link provided in the welcome email.

## License management

You can manage the following types of product licenses through the Licenses and Cloud Services portal:

### Cloud licenses

Software license entitlements that are distributed and governed by the Automation Anywhere cloud license server. The Control Room connects to the Automation Anywhere cloud license server and obtains license entitlements based on the license key that is installed on the Control Room.

The license key is in the form of a GUID and is made available on the portal. Automation 360 Cloud and On-Premises Control Room instances that have access to the cloud license server can use the cloud licenses.

### File licenses

File licenses are mainly used for Automation Anywhere Enterprise 11 and Enterprise 10 versions and for some Automation 360 On-Premises Control Room deployments. One license file per Control Room can be generated from the portal and manually installed on the Control Room.

Customers and partners can perform the following tasks related to licenses:

- View all the license entitlements and get details of purchased and available licenses and subscription terms (license start and end dates).
- Configure and download the license files as needed.
- View all the license entitlements and get details of GUIDs for cloud licenses.
- As a partner, you can view and manage license entitlements for your company as well as for your end customers.

## Cloud services management

Use the Licenses and Cloud Services portal to manage the following types of Cloud Control Room services:

- Pure Cloud Control Room
- Pure Cloud Sandbox Control Room
- Cloud-enabled Control Room
- Cloud-enabled Sandbox Control Room
- Cloud Control Room Migration

Pure Cloud Control Room and pure Cloud Sandbox Control Room instances have to be explicitly provisioned by the Customer License User (CLU) on demand when the customer is ready for consuming the cloud service.

Cloud-enabled Control Room and Cloud-enabled Sandbox Control Room instances are automatically provisioned by the Licenses and Cloud Services portal, providing the CLU user with a token required to install the Cloud-enabled Control Room on their infrastructure.

Customers and partners can perform the following tasks related to cloud services:

- View an inventory of all the Cloud Control Room subscribed services, with a visual display of configuration parameters associated with the cloud service.
- Perform on-demand provisioning of cloud services, such as Cloud Control Room and IQ Bot. This helps in real-time provisioning of your services.
- Access and manage ordered Control Room services.
- Migrate production and QA Control Room services.

## Managing Cloud and file licenses

The Licenses and Cloud Services portal includes the following main tabs: Manage File Licenses, Manage Cloud Licenses, Cloud Control Room Instances, and Partner Drawdowns.

### Manage Cloud Licenses

The tab provides customers and partners visibility into all Cloud-based license entitlements and the license keys (GUID) to be applied to all customer Control Room instances.

For Automation 360 On-Premises, a designated user can obtain the Control Room GUID from this tab and paste it into their respective Control Room instance. Please refer to [Installing additional licenses](#) on page 1786.

---

**Note:** For first-time Automation 360 Cloud customers, this tab is only informational because when a Cloud Control Room is provisioned for the first time, the GUID is already applied to their Control Room instance.

---

### Manage File Licenses

The **Manage File Licenses** tab provides customers and partners the visibility to all file-based license entitlements available. Designated license users can configure a license file for each of their Control Room instances with the necessary entitlements. Please refer to [Manage licenses](#) on page 1782 and [Installing additional licenses](#) on page 1786 for more information.

The steps below offer guidance to the licensing process for Automation 360 and Enterprise 11.

1. In the Control Room list view, click the Control Room name available as a hyperlink.  
The hyperlink redirects you to the license configuration page, where you can select the entitlements you want to add to the Control Room and save and generate a license file.

---

**Note:** The portal takes a few minutes to generate the file.

---

2. Use the **Refresh** option to see whether the license file is generated.  
After the Control Room status changes to **Active**, you can click the Control Room name again and download the file.
3. Based on your business requirements, reconfigure license files at any point of time from the same tab.

You can only configure entitlements that are in **Available** status. If all the entitlements are used in your license files, you need to reconfigure a file to release entitlements and make them available to be added to a different license file.

Please refer to these videos for more information:

For partners, the page displays an additional drop-down list, which enables you to switch context between multiple customers that you are managing. The page provides a similar view, with an additional drop-down list, which enables partners to switch the context between various customer entitlements.

## Automation 360 licenses

The **All Licenses** page displays detailed information about current product and device licenses.

### Product licenses

The Automation Anywhere Control Room is the web-based application at the center of the Digital Workforce providing enterprise-wide management and control. The Control Room ensures reliable, scalable, and secure bot deployment and execution. From this central vantage point, operators can receive tasks from the Bot Creator and push to the Bot Runners for execution with simple mouse clicks. The Control Room monitors and audits all scheduled and running bots, in real time.

The Control Room provides an automated mechanism for tracking and controlling the use of licensed software across Bot Creators and Bot Runners, addressing NIST Change Management CM-10.

### Device licenses

The device licenses section shows the number of licenses purchased, used, and available. If the licenses are added to the Control Room from the Cloud, the Licenses page also shows the number of pages processed in other Control Room instances.

License	Permission
Bot Creator	Users with this license can create, edit, schedule, and trigger bots. Additionally, these users can run bots in the following ways: <ul style="list-style-type: none"><li>• On their local machine</li><li>• From the public workspace if the Control Room administrator has specified a <b>Run as user</b> for unattended Bot Runner</li></ul>

License	Permission
Unattended Bot Runner Run-time license	<p>Users with this license can perform all automation tasks that attended users can perform. Additionally, this license can also be used for Automation Anywhere Control Room deployment, centralized scheduling, and API-based deployment.</p> <hr/> <p><b>Note:</b> Among all the triggers, you can associate any trigger only with a user who has a Bot Runner license. Also, for a user with unattended Bot Runner license, if you associate triggers such as Hot key, Interface, or Window, the following conditions apply:</p> <ul style="list-style-type: none"> <li>• The default device must not be in the logged-off or locked state.</li> <li>• The user must be logged in to the device to perform the predefined task that can trigger the bot.</li> </ul> <hr/>
Attended Bot Runner Run-time license	Users with this license can run bots on their devices. However, these users cannot run or schedule bots on another device.
Citizen Developer license	<p>Users with this license can create and run bots (including bots with triggers) on their devices.</p> <p><a href="#">Create a Citizen Developer role</a> on page 1764</p>
IQ Bot pages (Number of pages)	This license is required for uploading documents to Automation 360 IQ Bot.
Standard Forms pages (Number of pages)	This license is required for uploading documents for processing in Standard Forms.
Google Document AI (Number of pages)	<p>Enables Document Automation users to process documents in Google Document AI.</p> <hr/> <p><b>Note:</b> This metric is visible only to customers who purchased Google Document AI licenses through Automation Anywhere.</p> <hr/>
Document Automation Standard Forms (Number of pages)	This license is required for processing documents in standard forms in Document Automation.
Document Automation 360 Extraction (Number of pages)	This license is for processes documents in an Automation Anywhere (Pre-trained) model, including the User-defined document type.
Document Workspace (Number of pages)	This license tracks consumption for customers who brought their own license for Google Document AI or Standard Forms.
Classifier (Number of pages)	This license can be used to classify documents and pages leveraging the IQ Bot Classifier package.



License	Permission
Bot Insight	Bot Insight provides real-time, RPA native analytics for both business insights and operational intelligence.  The Bot Insight license is purchased on a per-user basis. To access the <b>Business</b> dashboard, the user must be assigned this license.
AARI (Automation Co-Pilot)	Users with the AARI license can be added to a Team for Process Composer consumption. This allows them to create requests and submit tasks within Automation Co-Pilot.
Discovery Bot	Process Discovery licenses must be purchased for use for business analysts and business users using Discovery Bot. Discovery Bot supports two licenses. The business analyst uses the process analyzer license to view and manage the metadata from all recordings within the process. The business user uses the process recorder license to view, record, and submit a process using the Discovery Bot recorder.

## RBAC on License Management

Access to License Management is deny-all and allow by exception based on roles and domains as defined in RBAC. Only those users who have access to License Management permission can view the entitlement details from the Automation Anywhere Control Room.

## Baseline inventory controls: Bot Creators, Bot Runners, and Bots

The Automation Anywhere Control Room manages all automation operations. Inventory controls are maintained through the application of RBAC to establish a single point of control for Base Line Configurations (NIST CM-2), access restrictions for configuration management (NIST CM-5 and 6). Automated baseline reporting can be configured.

## Licensing in high availability and disaster recovery

The license information that is centrally stored in the database or license cloud, is shared within High Availability clusters and across Disaster Recovery sites because synchronous data replication is configured between multiple Control Room servers.

[HA and DR deployment models](#) on page 1230

Related tasks

[Installing additional licenses](#) on page 1786

Upload new licenses to the Automation Anywhere Control Room to be distributed to users as required.

Related reference

[Control Room license expiry notifications](#) on page 1421

The Automation Anywhere Control Room license expiry notifications appear when the Control Room license is about to expire.

## Accessing Automation 360

Any new customer who orders our products receive license confirmation from Automation Anywhere.

The designated person responsible for configuring licenses for their company receives two email confirmations.

The SSO email from sso@automationanywhere.com grants you access to set up a new password for your Automation Anywhere Single Sign-On (SSO) account. The Orders email from orders@automationanywhere.com grants you access to your license entitlement information.

Do the following:

1. Open SSO email → access link.
2. Enter and confirm new password.
3. Access **A-People Community**.
4. There are two options to access your license entitlements.

Option	Action
A-People	Navigate to <b>LICENSES</b> .
Orders email	Access link to redirect to license page.

**Note:** Your license entitlement validation date is provided within the context of the Orders email and on the A-People License configuration page.

5. You now have access to your license entitlements.

On this page, you have access to more information of your order. The **Product Versions** shows your current license entitlement version, the **License Entitlements** shows the number of license entitlements in your order, and the **Control Rooms** shows the number of control rooms in your order, and allows to configure each licenses.

## Understanding licenses in Document Automation

This topic describes Document Automation device licenses and associated permissions.

To obtain specific Document Automation licenses, contact your sales representative or Customer Success Manager.

### Note:

- Document Workspace is available to customers from Automation 360 v.28 onwards.
- If you are leveraging BYOK (bring your own key), we recommend that you update to Document Automation v.28 or later.

The following table describes the different licenses for the Document Automation platform and Document Automation Classifier:

Licenses	Descriptions
Document Automation Platform	

Licenses	Descriptions
IQ Bot#pages (Up to X number of pages a year)	<p>Process documents in Document Automation via Automation 360 IQ Bot learning instances by using the <b>Connect learning instance</b> capability. This capability will only count pages that have been processed against the consumption.</p> <hr/> <p><b>Note:</b> For more consumption details for Automation 360 IQ Bot, see <a href="#">Review the dashboard</a> on page 3793.</p> <hr/>
Google Document AI#for Document Automation (Up to X number of documents a year)	<p>Process invoices, utility bills, or expense receipts using the Google Document AI engine. For example, 10 pages = 1 document</p>
Document Automation (Up to X number of pages a year)	<p>Process documents usingAutomation Anywhere#pre-trained models (invoice, arrival notice, bill of lading, packing list, and waybill), including the User-defined document type for semi-structured and unstructured documents.</p>
Standard Forms for Document Automation (Up to X number of pages a year)	<p>Process documents using the Standard Forms engine inDocument Automation for fixed/structured forms.</p>
Document Workspace (Number of pages)	<p>Process documents using own license (BYOK set-up) forGoogle Document AI,Standard Forms, or Google Custom Document Extractor (CDE).</p>
Document Automation Document Classifier	
Document Classifier (Up to X number of pages a year)	<p>Classify documents and pages, leveraging the Document Classifier package.</p> <p>Classify documents and pages, leveraging the Document Classifier package and tracks consumption on the license administration page for processed documents (number of pages) in the Document Classifier package.</p> <ul style="list-style-type: none"> <li>• For a document of 30 pages, the <b>Classify</b> action decrements it by 30 pages.</li> <li>• For a document of 30 pages, the <b>Classify documents</b> action decrements it by 1 document.</li> <li>• The <b>Train Classifier</b> action does not consume any pages.</li> </ul> <hr/> <p><b>Note:</b> This consumption of processed documents (number of pages) in the Document Classifier package is available from Document Automation v.30 onwards.</p> <hr/>

Licenses	Descriptions
Advanced Classifier	Classify documents and pages, leveraging the Advanced Classifier package. A valid Skillja (3rd Party provider) license is mandatory for utilizing the Advanced Classifier package.

## Monitor license consumption and availability

The **Manage > Licenses** page displays the number of product licenses purchased, used, and remaining for each product for the current license period. If your device is connected to the Internet, your Control Room instance receives updated counts every hour.

You will receive notifications for your license consumption when the following criteria are met:

- When 80% of your licenses are consumed
- When 90% of your licenses are consumed
- When 95% of your licenses are consumed
- When 99% of your licenses are consumed
- When 100% of your licenses are consumed

---

**Note:** When your license consumption reaches 100%, notifications are sent every week until you purchase additional licenses.

---

You will receive notifications depending on the type of events that you have enabled. For more information, see [Enable or disable event categories](#) on page 2207.

The following table describes how licenses are consumed based on different document types:

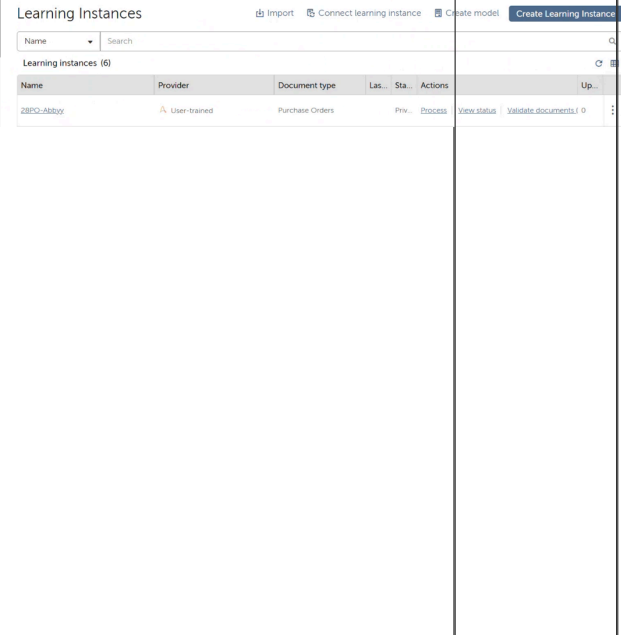
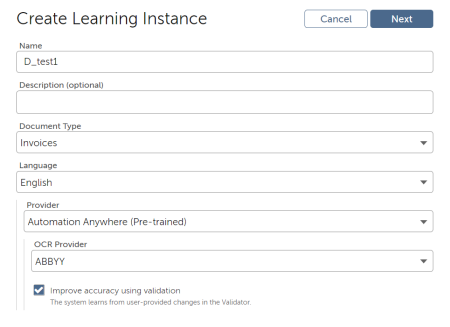
Type	Provider	Related Learning Instance	Is BYOK applicable?	License entity consumption
Contract, Health Insurance, Invoices, Purchase Orders, Other, and so on.	User-Trained	Document Automation > IQ Bot Connected Learning Instances  	No	IQ Bot (Number of pages)  <b>Note:</b> You can track IQ Bot consumption by leveraging the IQ Bot <b>Dashboard</b> . This license is consumed only for <b>Document Automation &gt; IQ Bot Connected Learning Instances</b> .
Invoices	Automation Anywhere (Pre-trained)	Create Learning Instance 	No	Document Automation 360 Extraction (Number of pages)

Type	Provider	Related Learning Instance	Is BYOK applicable?	License entity consumption
Invoices	Google Document AI	<div style="border: 1px solid #ccc; padding: 5px;"> <p style="text-align: right;">Cancel <span style="float: right;">Next</span></p> <p>Create Learning Instance</p> <p>Name  <input type="text" value="D_test2"/></p> <p>Description (optional)  <input type="text"/></p> <p>Document Type  <input type="text" value="Invoices"/></p> <p>Language  <input type="text" value="English"/></p> <p>Provider  <input type="text" value="Google Document AI"/></p> <p><small>Google Document AI can extract documents in other languages besides the language you selected above.</small></p> </div>	Yes	Google Document AI#(Number of documents)  <b>Note:</b> If using BYOK, the applicable license entity is Document Workspace (Number of pages).
Receipts	Google Document AI	<div style="border: 1px solid #ccc; padding: 5px;"> <p style="text-align: right;">Cancel <span style="float: right;">Next</span></p> <p>Create Learning Instance</p> <p>Name  <input type="text" value="D_test3"/></p> <p>Description (optional)  <input type="text"/></p> <p>Document Type  <input type="text" value="Receipts"/></p> <p>Language  <input type="text" value="English"/></p> <p>Provider  <input type="text" value="Google Document AI"/></p> <p><small>Google Document AI can extract documents in other languages besides the language you selected above.</small></p> </div>	Yes	Google Document AI#(Number of documents)  <b>Note:</b> If using BYOK, the applicable license entity is Document Workspace (Number of pages).

Type	Provider	Related Learning Instance	Is BYOK applicable?	License entity consumption
Standard Forms	Microsoft Forms Recognizer	<p>Create Learning Instance <span>Cancel</span> <span>Next</span></p> <p>Name D_test4</p> <p>Description (optional)</p> <p>Document Type Standard Forms</p> <p>Language English</p> <p>Provider Microsoft Forms Recognizer</p> <p>Model <span>Browse...</span></p>	Yes	<p>Document Automation Standard Forms (Number of pages)</p> <hr/> <p><b>Note:</b> If using BYOK, the applicable license entity is Document Workspace (Number of pages).</p>
User-defined	Automation Anywhere (User-defined)	<p>Create Learning Instance <span>Cancel</span> <span>Next</span></p> <p>Name D_test5</p> <p>Description (optional)</p> <p>Document Type User-defined</p> <p>Language English</p> <p>Provider Automation Anywhere (User-defined)</p> <p>OCR Provider ABBYY</p> <p><input checked="" type="checkbox"/> Improve accuracy using validation <small>The system learns from user-provided changes in the validation.</small></p>	No	<p>Document Automation 360 Extraction (Number of pages)</p>
User-defined	Google Document AI (User-defined)	<p>Create Learning Instance <span>Cancel</span> <span>Next</span></p> <p>Name D_test7</p> <p>Description (optional)</p> <p>Document Type User-defined</p> <p>Language English</p> <p>Locale English (United States)</p> <p>Provider Google Document AI (User-defined)</p>	Yes	<p>The applicable license entity is Document Workspace (Number of pages).</p> <hr/> <p><b>Note:</b> In addition, you need a valid subscription to Document AI workbench.</p>

Type	Provider	Related Learning Instance	Is BYOK applicable?	License entity consumption
Utility Bill	Google Document AI		Yes	Google Document AI#(Number of documents)  <b>Note:</b> If using BYOK, the applicable license entity is Document Workspace (Number of pages).

Type	Related package	Is BYOK applicable?	License entity consumed
All document types		No	Classifier (Number of pages)

**Note:**

- If you have an invalid license, the following error message is displayed:  
License expired or not available. Obtain the necessary license.
- The BYOK (bring your own key) refers to using your own license key for third party providers.

## Provision Cloud Control Room instances

You can access, view, provision, and edit all the purchased Cloud Control Room instances. If required, you can also purchase and provision the IQ Bot services later.

Use the Licenses and Cloud Services portal to provision Cloud Control Room and Cloud sandbox Control Room instances on demand. Cloud-enabled Control Room instances are automatically provisioned by the portal.



Customers can provision their own Cloud Control Room instances, and partner users can provision Cloud Control Room for themselves and their customers.

1. Log in to A-People using your login credentials: [A-People home page \(login required\)](#).
2. Click the **Licenses and Cloud Services** tab.
3. On the navigation pane on the left side, click the **Cloud Control Rooms Instances** tab to display a list of provisioned and unprovisioned Cloud Control Room instances for the different types of Cloud Control Room instances.

The inventory view displays the different parameters about provisioned Cloud Control Room instances, such as domain name, Control Room URL, and the region from where the Control Room is hosted. Use the region name to subscribe to maintenance notifications on `status.automationanywhere.digital`.

4. In the **Control Room Name** field, enter a name.
5. In the **Cloud Control Room Domain Name** field, enter a domain name.

The domain name must be a unique name that will be part of your Cloud Control Room URL. The portal checks and validates the uniqueness of the domain name across the system.

Consider the following examples for domain names:

- Example URL for Cloud Control Room: `https://<domain-name>.my.automationanywhere.digital`
- Example URL for Cloud sandbox Control Room: `https://<domain-name>.cloud#.automationanywhere.digital`

---

**Note:** After provisioning is done, the domain name for a Cloud Control Room cannot be changed. For assistance, contact Automation Anywhere support: [Open a support case \(A-People login required\)](#)

---

6. Select an **Environment** option.  
The options are **Production**, **Development**, and **UAT**. By default, for sandbox Control Room, only the sandbox option is displayed here.
7. Select the **Country** from where most of your users will access this Control Room.  
Based on the country you select, your Cloud Control Room will be hosted from a region that is nearest.

---

**Note:** After provisioning is done, the **Country** for the Cloud Control Room cannot be changed.

---

8. Select and specify the Cloud Control Room administrator.  
You can either select from existing customer contacts or create one. If you are creating a user, enter details such as first name, last name, and email address.
9. Optional: If your account is entitled for IQ Bot service, you can register for IQ Bot by selecting the check box.
10. Click **Save** to provision the Cloud Control Room instance.

The Cloud Control Room instance is automatically provisioned, and the Control Room status changes from **Provision** to **Provisioning in-Progress**. Provisioning takes some time to complete. When provisioning is complete, the status changes to **Provisioning Complete**.

## Self-service Control Room Migration

Manage the migration provisioning process with self migration capabilities and the flexibility to choose manual or automated migration.

To perform the task, you must have a administrator account with the required rights and permissions.

Complete the Cloud Migration Control Room setup before provisioning an IQ Bot server with the Control Room, if proper entitlement is licensed.

---

**Note:** Migration is currently not supported on GCP.

---

1. Log in to A-People using your login credentials: [A-People home page \(login required\)](#).
2. Click the **Licenses and Cloud Services** tab.
3. On the navigation pane on the left side, click the **Cloud Control Rooms Instances** tab to display a list of provisioned and unprovisioned Cloud Control Room instances for the different types of Cloud Control Room instances.

The inventory view displays the different parameters about provisioned Cloud Control Room instances, such as domain name, Control Room URL, and the region from where the Control Room is hosted. Use the region name to subscribe to maintenance notifications on [status.automationanywhere.digital](https://status.automationanywhere.digital).

4. In the **Control Room Name** field, enter a name.
5. Select the type of migration.
  - Automation Migration with Migration Utility. For more information, see [Install Cloud Migration Utility](#) on page 1554.
  - Manual Migration. You will get a new Cloud Control Room to work with.

6. In the **Cloud Control Room Domain Name** field, enter a domain name.

The domain name must be a unique name that will be part of your Cloud Control Room URL. The portal checks and validates the uniqueness of the domain name across the system. Consider the following examples for domain names:

Example URL for pure Cloud Control Room: <https://<domain-name>.my.automationanywhere.digital>

Example URL for pure Cloud Sandbox Control Room: <https://<domain-name>.cloud#.automationanywhere.digital>

7. Select an **Environment** option.

The options are **Production**, **Development**, and **UAT**. By default, for Sandbox Control Room, only the Sandbox option is displayed here.
8. Select the **Country** from where most of your users will access this Control Room.

Based on the country you select, your Cloud Control Room will be hosted from a region that is nearest.

---

**Note:** After provisioning is done, the **Country** for the Cloud Control Room cannot be changed.

---

9. Select you **Region**.

---

**Note:** After provisioning is done, the **Region** for the Cloud Control Room cannot be changed.

---

10. Select and specify the Cloud Control Room administrator.  
You can either select from existing customer contacts or create one. If you are creating a user, enter details such as first name, last name, and email address.
11. To generate the migration code, click **Save**.  
The **View** tab displays the migration code.
12. Copy the migration code to the **Cloud Migration utility**. This will export and import the data to Cloud.

---

**Note:** You can click the **View** tab for the following:

- View the migration code.
- Regenerate the migration code when the code is expired.
- Indicates that the Cloud Control Room is ready for use by displaying the user credentials.
- Displays the status of the Cloud Control Room during the migration process.

---

**Note:** During the migration process, you can view the stages of migration: New, Consumed, Expired, Renewed, or Complete.

---

## Viewing the Cloud Migration Control Room Details

In addition to the other details shown for regular Cloud Control Room, this page displays the migration code to being used by the migration utility.

### View Cloud Migration Control Room Details

Users who trigger the provisioning and administrators of the Cloud Migration Control Room receive an email with instructions on how to get the migration code, how to install the migration utility, and how to start the migration process.

Here is some additional information regarding this process, related to **Migration Status**, **Migration Code**, and **Migration Code Expiry Date**.

Following are the important details to track from this page for Administrators:

Migration Status	Displays the current status of the migration
Migration Code	The necessary code required to complete the migration process
Migration Code Expiry Date	If the expiry date for the code has lapsed, you must generate a new migration code for application.

## Manage and allocate licenses (partners)

Automation Anywhere partners can manage and process Licenses and Cloud services.

Partners can manage their and their customers entitlements from the portal. Partners access the Licenses and Cloud portal in the following ways:

- Purchases Automation Anywhere licenses for their own use.

- Participates in a customer purchases Automation Anywhere licenses through the partner.
- Partner draws down from their own license entitlements and allocates some portion of the entitlements to a customer.

Use the **Select an Account** to switch entitlements via the drop-down list. Partners can view license entitlements, configure licenses (file-based licensing), view Control Room GUIDs (cloud-based licensing), and view and manage provision ready cloud services (Control Room, IQ Bot server).

For information, see [Managing Cloud and file licenses](#) on page 1406.

Assigning a customer and entitlements

To draw down on entitlements and assign to a customer, perform the following tasks.

1. Log in to the A-People portal: [A-People home page \(login required\)](#).
2. Click the **Licenses and Cloud Services** tab, and navigate to the **Partner Draw downs** tab.  
An empty page is displayed when you log in for the first time. After a few requests have been processed, this page displays a list of draw-downs that you have processed.
3. To start a new draw-down process, click **New**.
4. From the **New Partner Draw Down Request** page, select an order from the drop-down list.  
You can draw down from only one order at a time.
5. Enter the required information in the following fields:
  - **Assign to customer account:** Customer account name
  - **Customer website:** URL to the customer's website
  - **Customer name:** Name of your customer contact
  - **Customer email:** Email address of the customer contact

6. After entering the customer information, generate a partner draw down request (PDR) by specifying a number for each of the products available.

7. Click **Save** to generate a new PDR.

The PDR is in submitted state.

First, generate the PDR, an email notification is sent to your accounts team for approval.

Once the PDR is validated and approved (or rejected), the partner who requested for the PDR will receive an email notification. The PDR requesting partner has to then navigate back to the portal to take appropriate action.

8. After approval, click **Accept**.  
After acceptance, the license entitlements from the PDR are transferred from the partner to the customer. If the PDR is rejected, you can see the reason for rejection.

---

**Note:** If for any reason the draw down is no longer required, the partner can cancel the request at this point.

---

9. Clone the PDR if required, make the necessary changes and resubmit the PDR.

Partners can refer to the customer documentation for managing licenses and provisioning cloud services.

- For configuring file licenses, see [Configure new licenses](#).
- For provisioning of cloud services, see [Provision Cloud Control Room instances](#) on page 1416.

The Licenses and Cloud portal provides the partners with an automated way to process draw downs for their customers.

## View and edit Cloud Control Room instances

You can get a complete inventory view of all the Cloud Control Room instances and Migration Control Rooms that have been purchased and linked to your account. You can check their provisioning status, which can be Not Provisioned, Provisioning in progress, Provisioning complete, or Provisioning failed. You can provision these instances as and when required.

1. Log in to A-People using your login credentials: [A-People home page \(login required\)](#).
2. Click the **License and Cloud Services** tab to open the Licenses and Cloud Services portal.
3. On the navigation pane on the left side, click the **Cloud Control Rooms Instances** tab to display a list of provisioned and unprovisioned Cloud Control Room instances for the different types of Cloud Control Room instances.

The inventory view displays the different parameters about provisioned Cloud Control Room instances, such as domain name, Control Room URL, and the region from where the Control Room is hosted. Use the Region name to subscribe to any maintenance notifications on [status.automationanywhere.digital](mailto:status.automationanywhere.digital).

4. Click the **View** option for any of the provisioned Cloud Control Room instances. It opens the page with the details about the Cloud Control Room instances, such as name and domain name, provisioning status, service type (Pure Cloud, Cloud-enabled, Cloud Sandbox, and so on), license GUID, provisioning date, Cloud-enabled token, type of environment in which the instance is deployed, and cloud region where the instance is hosted.
5. Optional: On the displayed page, click **Edit** to change the Cloud Control Room name to a name of your choice.
6. If your account is entitled for an IQ Bot service, register for it by selecting the check box in the displayed page.
7. Click **Save** to apply the changes in the page.

## Control Room license expiry notifications

The Automation Anywhere Control Room license expiry notifications appear when the Control Room license is about to expire.

When the Control Room license is about to expire, the administrator sees a visible banner notification on log in to the Control Room. The Control Room checks the license status daily. At 30 days before a license expiration date, a notification message is displayed in the Control Room with the number of days remaining for the license to expire. The banner is displayed every time the administrator logs in to the Control Room during the last 30 days before the Control Room license expiration. The severity of the banner notification becomes critical in the last seven days before Control Room license expiration. As the expiration date approaches, notifications become more persistent at the following countdown intervals:

- 30 days: When a license is within 30 days of expiration, a dismissible notification appears in the Control Room banner and the message is displayed in the banner until the license is renewed or expired.

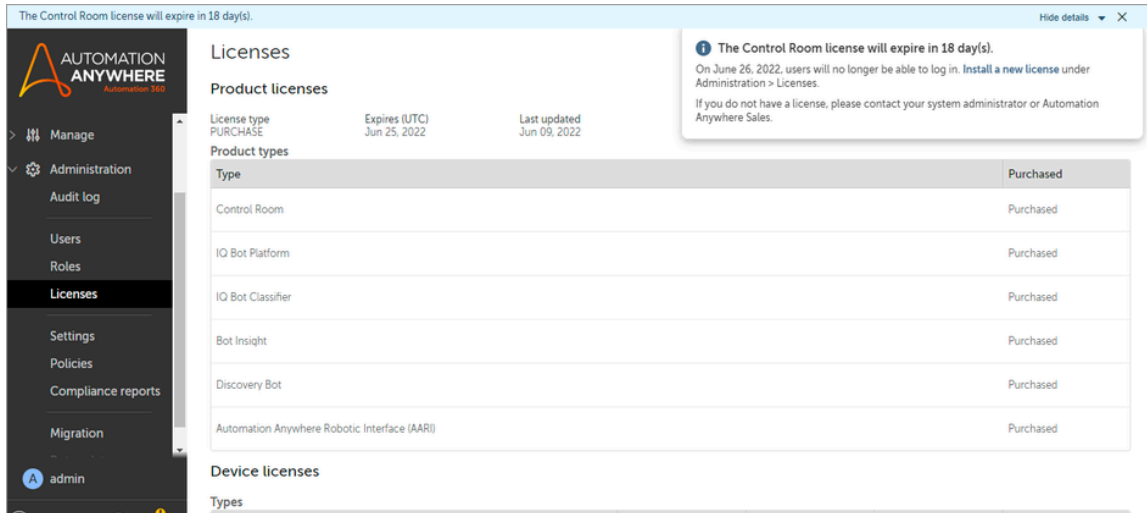

- 7 days: When the approaching license expiration date is in seven days or less, a red banner appears showing the expiry date and a link to extend the license. This notification appears in the console until the service is extended or the 30-day expiration period elapses.

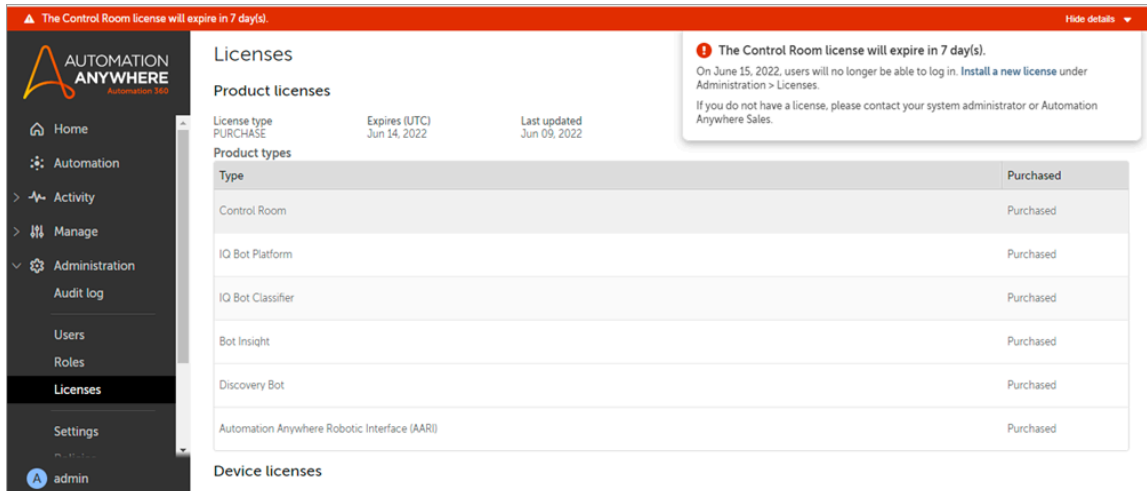

- 0 days (expired): After the license has expired, you will not be able to use the Control Room. You will see a screen similar to the following with a non-dismissible notification.

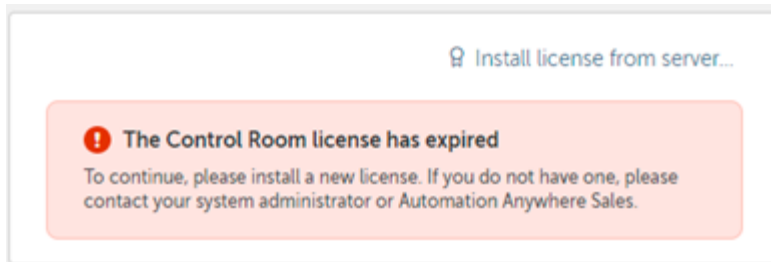

**Note:** In the SSO environment, if the option to install license is not displayed after the license has expired, clear the browser cache and refresh the browser. The install license option becomes visible.

## See also

- [Automation 360 licenses](#) on page 1407
- [Licenses and cloud services](#) on page 1404
- [Control Room fail-safe status](#) on page 1400

## Update Automation 360 to latest version

Update Automation 360 On-Premises to the latest version to get new features and enhancements that help improve and scale your automation programs.

- Before each release update, ensure that you backup the database, repository, and installation configuration files.

---

**Note:** The configuration files in <Installation Directory>/config/ are overwritten after an update. Ensure you either take a backup of these files before the update, or rewrite the settings after the update.

- Ensure you are on one of the previous three releases from the latest release (on an n-3 release, where n refers to the latest release).

For example, to update to Automation 360 v.21 release, you must be on the v.20, v.19, or v.18 release. However, to update from v.15 to Automation 360 v.21 release, you must first update to v.18 release and then update to Automation 360 v.21 release. In the second scenario, ensure you perform backup of v.15 data before you update to v.18, and then backup v.18 data before you update to v.21.

---

### Important:

- You must perform the following steps before you update the Automation 360 version:
  - Ensure you reconfigure the settings for `log4j2.xml` files after the installation because when you update, the previous settings set at log level in log4j2 change back to default.
  - Configure the SSL settings (certificates) every time you update.
- When you update from an Automation 360 release earlier than an n-3 release to the latest release, you might see an Elasticsearch Open Distro error message. Before updating, delete the multiple `application_log` indices from Elasticsearch, which will free up disk space for the update.

For details on the Elasticsearch indices limit, see [Cluster-level shard allocation and routing settings](#).

- Before you update from Automation 360 On-Premises v.22 to the latest release, see [A360 | Upgrading to A360.23, A360.24, A360.25 from A360.22 \(A-People login required\)](#)
- When you update to Automation 360 v.25 from an earlier release, an error might occur when the database server includes the instance name. In such a scenario, remove the instance name in the database server and continue with the installation.

For information on removing the instance name from the database server, see [Error parsing the SQL instance name while upgrading to Automation 360 v.25 \(A-People login required\)](#).

- Before you update to Automation 360 v.28 On-Premises from any of the earlier versions, review the following article: [Automation 360 On-Premise Edition | A360.28 – Upgrade Considerations \(A-People login required\)](#). This article is applicable only to On-Premises

customers who started using Automation 360 from v.15 or previous versions. To successfully update to Automation 360 v.28, you must perform the pre-update steps in the KB article.

- 
1. Log in to Automation Anywhere Support site to download the latest version of the Automation 360 setup file: [A-People Downloads page \(Login required\)](#).
  2. On the **Downloads** page, click the link to the latest Automation 360 setup file.
  3. Click **Installation Setup**, and then click either **Windows Setup** or **Linux Setup** based on the operating system of the machine on which you want to install Automation 360.
  4. Download the `Automation360_Build_<build-number>.<file-extension>` file.  
Watch the following video on downloading the build:
  5. Install the latest version of Automation 360 without uninstalling your current version.  
[Installing Control Room On-Premises](#) on page 1177
- 

**Important:** You must use the existing SQL database from current installation in the newer version of Automation 360.

---

Related concepts

[Migrate to Automation 360](#) on page 1496

Migration (upgrade) is the process of moving your data and bots from Enterprise 11 or Enterprise 10 to Automation 360. Migration includes but is not limited to replicating and updating your existing database and repository, converting your bots to the Automation 360 format, and migrating learning instances for IQ Bot and dashboards for Bot Insight.

## Update Automation 360 on Microsoft Windows Server using scripts

You can update Automation 360 using a customized script with parameters to maintain existing user configurations.

To perform the task, you must have a administrator account with the required rights and permissions.

- Verify [Automation 360 On-Premises prerequisites](#) on page 1180.
- Ensure that you have the following:
  - Automation Anywhere Control Room installation file
  - TLS certificate
  - License file

---

**Sample config.properties file:** For your reference, you can find a sample config.properties file at the end of the page.

---

**Note:** For instructions on performing silent install and configuration of Automation 360 separately, see [Silent installation and configuration of Automation 360 using scripts \(A-People login required\)](#).

---



Create and run a PowerShell script to update Automation 360.

1. Create a PowerShell script with the required parameters:

The following is a sample PowerShell script for upgrading Automation 360:

```
# Script Begins
# It fetches Data from config.properties file present under the same
  directory level

$PropertyFilePath = 'C:\script\config.properties'
$rawProperties = cat $PropertyFilePath
$propertiesToConvert = ($rawProperties -replace '\\', '\\') -join
  [Environment]:: NewLine;
$properties=ConvertFrom-StringData $propertiesToConvert
$env:SEE_MASK_NOZONECHECKS = 1

# Setting up the logger and InstallerRoot Directory

$baseLogFilePath=$properties.baseLoggingDirectory
$logFilePath=$baseLogFilePath
+'Express_CR_Installation_Scenario1.txt'
$baseInstallerPath=$properties.baseInstallerDirectory
$installer_name_regex=$properties.installerNameRegex

# Logging Begins

Start-Transcript -Path $logFilePath -Append -IncludeInvocationHeader

$binary = Get-ChildItem $baseInstallerPath | Where-Object
  { $_.FullName -imatch $installer_name_regex }
$a = $binary.FullName
$final_commandline = " /update /s /v/qn /v"/L*v
  CR_Onprem_Installationlog_Scenario1.txt""

# Recording the Start Time
Get-Date -Format g

# Invoking the Installer here
$processdetail = (Start-Process -FilePath $a -ArgumentList
  $final_commandline -Wait -Passthru).ExitCode

# Recording the End Time
Get-Date -Format g

Stop-Transcript
```

2. Optional: Customize the script to include parameters according to your requirements.
3. Save the script to the installation server.
4. Log in to the installation server as administrator.
5. Start PowerShell in administrator mode.
6. Run the following:

```
Set-ExecutionPolicy Unrestricted -Scope CurrentUser -Force
.\install.ps1
```

---

**Note:** The silent installation logs are stored in the folder from which the installation script is run. For example, if you run the script from `C:\Silent Install`, the logs are stored in the `C:\Silent Install` folder.

---

7. Validate the following:

- All Automation Anywhere services are running in Windows Task Manager.  
[Verifying Automation Anywhere services](#) on page 1317
- You are able to log in to the Control Room from a supported browser.  
[Log in to Automation Anywhere Control Room](#) on page 1488
- You are able to install the required license in the Control Room.  
[Installing additional licenses](#) on page 1786
- All automations (deployed and scheduled) are running in the Control Room.  
[Activities](#) on page 2121

Example of config.properties file

```
# Properties utilized across all Scenarios

# Default/Express Mode Params

baseLoggingDirectory=C:\script\logs\
baseInstallerDirectory=C:\script\
installerNameRegex=AutomationAnywhereEnterprise_A2019
```

## Install and update Automation 360 IQ Bot

This collection of topics guide you through the process of installing or setting up Automation 360 IQ Bot On-Premises and Cloud.

- [Automation 360 IQ Bot Cloud deployed](#)
- [Automation 360 IQ Bot On-Premises](#)

### Automation 360 IQ Bot On-Premises

Step 1: Pre-installation

Go to Automation Anywhere support site and download the Automation 360 IQ Bot On-Premises package:

[A-People Downloads page \(Login required\)](#)

---

**Note:** Automation 360 IQ Bot On-Premises uses a 3-node cluster to ensure high availability (HA).

[High availability and disaster recovery overview](#)

---

Review and verify the requirements and options before installing IQ Bot. This topic provides you with important information about the supported operating systems, hardware and software requirements, and the prerequisite steps you have to complete even before you begin the installation process.

[IQ Bot installation prerequisites](#) on page 1429      Verify the hardware, software, and configuration required to install IQ Bot On-Premises.

Step 2: IQ Bot installation

Install IQ Bot using any of the following installation options:

[Installing IQ Bot in Express mode](#) on page 1439      Install IQ Bot in Express mode with the default settings.

[Installing IQ Bot in Custom mode](#) on page 1440      Use Custom mode to install IQ Bot with configuration details.

[Installing IQ Bot in Cluster mode](#) on page 1444      Install IQ Bot in Cluster mode for improved throughput. IQ Bot supports clustering of up to five IQ Bot installations.

[Installing IQ Bot in Cluster mode on Amazon EC2](#) on page 1448      Install IQ Bot in the cluster mode on Amazon Elastic Compute Cloud (Amazon EC2).

Step 3: Post installation

After downloading IQ Bot, register with the Control Room and do the various configurations as required. You would also go through the checklist to ensure all services, databases, tables, and configuration settings are in place.

[Postinstallation checklist](#) on page 1449      Verify that IQ Bot is installed, ensure that the IQ Bot services are running using the healthcheck APIs, and register IQ Bot with the Control Room.

- Step 4 (optional): Install an OCR engine
- During IQ Bot installation, the system sets the latest version of Tesseract Optical Character Reader as the default OCR engine. To use a different engine, follow the steps in the respective link:
- [Use Microsoft Azure Computer Vision OCR engine](#) on page 1459
  - [Use ABBYY FineReader Engine OCR engine in IQ Bot](#) on page 1462
  - [Use Google Vision API OCR engine](#) on page 1465
  - [Use Tegaki API OCR engine](#) on page 1469
- Step 5: Login and set up the Control Room
- Create and register IQ Bot specific users in the Control Room. Learn more about IQ Bot roles and access permissions:
- [IQ Bot user personas and roles](#) on page 3734
- Next: Connect to IQ Bot with the assigned user role, and begin creating learning instances
- [Automation 360 IQ Bot](#) on page 3730

## Automation 360 IQ Bot Cloud deployed

Follow these steps to deploy and register as a user:

- Step 1: Pre-installation
- If you are your company's principal administrator and ordered Cloud deployed Automation 360 IQ Bot, you receive an email from Automation Anywhere with your URL and credentials.
- Step 2: Log in to IQ Bot
- To log in to Automation 360, open the Control Room URL in your browser, enter your credentials in the login screen, and click **Log in**.
- [Log in to Automation Anywhere Control Room](#) on page 1488
- Step 3: Set up the Control Room
- Create and register IQ Bot specific users in the Control Room. Learn more about IQ Bot roles and access permissions:
- [IQ Bot user personas and roles](#) on page 3734
- Next: Connect to IQ Bot with the assigned user role, and begin creating learning instances
- Go to the Control Room dashboard to access the IQ Bot URL link.
- [Automation 360 IQ Bot](#) on page 3730

Related concepts

[Automation 360 IQ Bot](#) on page 3730

Automate document-centric business processes, end to end, by using IQ Bot, a web-based, Cloud-native intelligent document processing solution that can read and process complex

documents and email. This solution combines RPA with AI techniques to extract and classify semi-structured and unstructured data.

[Get started with Automation 360 Cloud](#) on page 1165

Use these tasks to start creating and using bots with Automation 360 Cloud.

[Migrate to Automation 360 IQ Bot](#) on page 1718

Migration is the process of upgrading from earlier versions of IQ Bot (Enterprise 11.x, 6.x, or 5.x) to the latest Automation 360 IQ Bot version. This includes replicating your existing database and repository, converting your bots to Automation 360 format, and migrating all the learning instances.

## IQ Bot installation prerequisites

Verify the hardware, software, and configuration required to install IQ Bot On-Premises.

---

**Note:** This page applies to On-Premises installations only. For Cloud deployment, see [Automation 360 IQ Bot Cloud deployed](#) on page 1428.

---

### Hardware and software requirements

---

**Important:** As a prerequisite step, open ports 4369 and 25672 and add inbound firewall rules to allow traffic to these ports on each target machine. To add nodes to the cluster, sync the RabbitMQ v3.8.18 cookies to enable running any RabbitMQ v3.8.18 commands. If IQ Bot is already installed on the target machine, clean up and remove the existing cookies.

---

[Automation 360 IQ Bot version compatibility](#)  
on page 1010

[IQ Bot system requirements](#) on page 1431

### Prerequisite

[IQ Bot prerequisite steps](#) on page 1433

[IQ Bot service configuration](#) on page 1435

[IQ Bot Windows services](#) on page 1435

[RabbitMQ v3.8.18 and Erlang/OTP upgrade](#) on  
page 1436

[Installing IQ Bot in Cluster mode on machines  
with IQ Bot preinstalled](#) on page 1437

[Prerequisites for installing IQ Bot in Express  
mode](#) on page 1438

### Installation limitations

Database encryption limitations

Installation time increases when encryption of the SQL database backup file is in progress, and also when the database backup file size increases.

The encryption process of the SQL database might result in the creation of large transaction logs. Allocate at least 3 to 4 times more disk space than the database backup file size.

---

**Note:**

- The following list of installation packages are not supported from Automation 360 v.28 release onwards:
  - Custom installation + HTTPS + Windows authentication + Service user installation + Custom output path + Cyber ark
  - Express installation + Windows authentication (Automation 360 v.27 to Automation 360 v.28) and Express fresh installation
  - Custom installation + HTTPS + Windows authentication + Local account installation + SMB output path
  - Custom installation + HTTPS + Azure authentication + Local user account installation + custom output path
- The following list of installation packages are not supported from Automation 360 v.27 release onwards:
  - On-Premises custom fresh installation - custom installation + HTTP + SQL authentication + local account installation
  - On-Premises Express fresh installation
  - On-Premises without internet fresh installation
  - On-Premises GCP fresh and upgrade
  - On-Premises SDS fresh installations (AD and Non-AD)
  - On-Premises migration from IQ Bot 11.x to On-Premises Automation 360.x using Migration Assistant Tool (MAT).

---

**Note:** If you are on any version prior to IQ Bot On-Premises Version 11.3.5.6, you must update to Version 11.3.5.6 or later version. The base version must be Version 11.3.5.6 or later version to use the Database Migration Assistant Tool. You must migrate to Automation 360 v.30 using the Database Migration Assistant Tool and then update from Automation 360 v.30 to later versions.

---

---

Related tasks

[Installing IQ Bot in Express mode](#) on page 1439

Install IQ Bot in Express mode with the default settings.

[Installing IQ Bot in Custom mode](#) on page 1440

Use Custom mode to install IQ Bot with configuration details.

## IQ Bot system requirements

Review the operating system and database compatibility, database information, and the hardware and software requirements for Automation 360 IQ Bot.

**Legal disclaimer:** The information provided in this workflow might vary depending on which offering is being used. Administrative instructions might not be applicable to Automation 360 IQ Bot Community Edition.

**Note:** When you migrate from any of the earlier IQ Bot versions (11.x or 6.x) to Automation 360 IQ Bot, ensure that you update the Microsoft Windows Server Operating System to one of the versions listed in the table below.

The following table lists the Operating System and database compatibility with Automation 360 IQ Bot On-Premises:

Operating System	Supported platforms	Database type	Database version	Database edition
Microsoft Windows Server:	<ul style="list-style-type: none"> <li>Microsoft Azure Virtual Machines</li> <li>Amazon Elastic Compute Cloud (Amazon EC2)</li> <li>Google Cloud Platform</li> </ul>	<ul style="list-style-type: none"> <li>Microsoft SQL Azure (RTM)</li> <li>Amazon Relational Database Service (Amazon RDS)</li> <li>Microsoft SQL Server</li> </ul>	<ul style="list-style-type: none"> <li>2019</li> <li>2017</li> <li>2016</li> </ul>	<ul style="list-style-type: none"> <li>Express</li> <li>Standard</li> <li>Enterprise</li> </ul>

The following table provides the required database information:

Microsoft SQL Server and Amazon RDS databases	
Required information	Description
Database (SQL Server) authentication	Provide credentials for a Microsoft SQL Server user who has permission to connect to the database.
Database name	IQBot
Database port	Default: 1433
Service credentials	Provides the user with the following permissions: <ul style="list-style-type: none"> <li>CONNECT SQL</li> <li>CREATE ANY DATABASE</li> <li>VIEW ANY DATABASE</li> </ul>

**Note:**

If you are using an older version of the Microsoft SQL Server which does not support TLS 1.2, then you must keep a IQ Bot database backup and update to a Microsoft SQL Server version that supports TLS 1.2. For more information, see <https://support.microsoft.com/en-us/topic/kb3135244-tls-1-2-support-for-microsoft-sql-server-e4472ef8-90a9-13c1-e4d8-44aad198cdbc>.

**Hardware requirements**

IQ Bot	Minimum requirements
Application server	<ul style="list-style-type: none"> <li>• 32 GB RAM</li> <li>• 8 Core Processor with support for AVX instructions set (this is a requirement starting from A2019.19)</li> <li>• 500 GB hard disk space</li> <li>• Ensure drive C has 100 GB plus free hard disk space</li> </ul>
For all IQ Bot related database servers	<ul style="list-style-type: none"> <li>• 16 GB RAM</li> <li>• 8 Core Processor</li> <li>• 500 GB hard disk space</li> </ul> <p><b>Note:</b> If you are hosting IQ Bot databases along with other application databases, ensure the hardware resources are increased proportionately.</p>
Microsoft Azure SQL Database: production environment	<ul style="list-style-type: none"> <li>• vCore model (recommended)</li> <li>• DTU model (Premium tier recommended)</li> </ul>

**Software requirements**

Software	Details
Database Management System	<a href="#">Automation 360 IQ Bot feature comparison matrix</a> on page 1005
Automation Anywhere Control Room	<a href="#">Automation 360 IQ Bot version compatibility</a> on page 1010



Software	Details
Web browsers	Google Chrome 80 (or later) Microsoft Edge Chromium 98 (or later) Mozilla Firefox 80 (or later)
	Azure File Share with Server Message Block 2.0 and 3.x (SMB) protocol.
Dependencies	<p>Automation 360 requires the following software, which is automatically installed during the installation:</p> <ul style="list-style-type: none"> <li>• Microsoft .NET Framework v4.7.2 The system prompts for a restart to complete the update.</li> <li>• Microsoft Visual C++ Redistributable 2017 x64 package</li> <li>• Erlang v26.0.2</li> <li>• RabbitMQ v3.12.1</li> <li>• NodeJS v16.20.2</li> <li>• Microsoft SQL Server 2012 Native Client-QFE</li> <li>• Python 3.11.5 (64 bit)</li> <li>• Java Virtual Machine (JVM) 8</li> </ul> <hr/> <p><b>Note:</b> In a cluster environment, all dependencies are installed on each machine where IQ Bot is installed.</p> <hr/>

Related reference

[IQ Bot installation prerequisites](#) on page 1429

Verify the hardware, software, and configuration required to install IQ Bot On-Premises.

## IQ Bot prerequisite steps

Complete the steps before you begin installing IQ Bot.

1. User needs to have either the SYSADMIN role or the following privileges for SQL database account as this is used during installation to create database and run the BULK INSERT statement.
  - SQL connection (CONNECT SQL)
  - Database creation (CREATE ANY DATABASE)
  - View any database (VIEW ANY DATABASE)

---

**Note:** Installation with Microsoft Azure SQL requires the dbmanager role.

---

**Note:** Installation with AWS RDS requires a role with the above three privileges. These privileges are already assigned to the `db_owner` role in RDS.

---

Grant permissions for a specific database user and see the permissions for that role using the following TSQL query:

```
SELECT * FROM fn_my_permissions(NULL, 'SERVER');
```

2. First enable HTTPS, to configure IQ Bot with HTTPS. Keep the following HTTPS certificate files ready for use:
    - Control Room certificate in `.crt` format (Certificate Authority list bundle).
    - Control Room certificate in `.crt` format (Server side public certificate).
    - IQ Bot server certificate in `.pfx` and `.crt` format.
- 

**Important:** Install the `.crt` certificates for Control Room manually to their appropriate certificate stores.

---

**Note:** See [Configuring IQ Bot with HTTP when Control Room is configured with HTTPS](#) on page 1457 for more information.

---

3. Keep the following ports open because they are used by IQ Bot services:
    - Application access port (configurable): 3000
    - Database access port (configurable): 1433
    - Internal application services ports (fixed): 8100, 9002, 9991, 9992, 9995, 9996, 9997, 9998, 9999
    - Inbound listening ports:
      - 47100-47200 on IQ Bot server for IQ Bot-Control Room communication.
      - 47100-47200 and 47500-47600 on Control Room server.
    - RabbitMQ v3.8.18
      - Port: 5672
      - Port: 5673
  4. If your SQL Server version is older than SQL Server Native Client 2012, a dialog box appears, giving you the option to upgrade. Open `services.msc` and stop the SQL Server (MSSQLSERVER) to do the upgrade. Then continue with the installation process.
  5. During the upgrade process, the installer will detect existing learning instances from a previous version of IQ Bot. To retain the original classifier for those learning instances, select that earlier version of IQ Bot from the drop-down list. This ensures consistency in the behavior of the learning instances with that earlier version.
  6. IQ Bot installer is case sensitive about the user account created for SQL Server or Windows.
- 

**Important:** Use the username as it appears on the Microsoft SQL Server Management Studio under **Security > Logins**. If it was created in upper case, then use upper case for the username to launch the installer. Additionally, verify if the collation database property is set to case sensitive.

---

## IQ Bot service configuration

In some IQ Bot deployments, the service account can be different from the login account. As an administrator, provide the service credentials during installation.

IQ Bot Installer supports service credentials during Microsoft Windows or SQL server authentication. When installing Services for IQ Bot, in the service installation window, the **Local System Account** check box is selected by default. You can deselect this and provide a username and password.

---

### Note:

- Use Windows authentication with a valid system administration user in service configuration.
- Use Windows authentication with a local system for a system administration user.
- When using a remote SQL server to create a database, the combination of local system account for service credentials and Windows authentication for SQL connection is not supported.
- The service account used for IQ Bot services must have full rights to the IQ Bot installation folder.

---

If you do not select the **Local System Account** checkbox, provide your user credentials to run the IQ Bot Services.

---

### Note:

- A valid system administrator user requires Windows authentication with the Services user credentials.
- When entering user credentials, ensure the credentials are associated with a domain. For example: example.com/testuser. User is unable to use this function without the domain.

---

See [Installing IQ Bot in Custom mode](#) on page 1440 to view the use of service credentials in IQ Bot.

Related reference

[IQ Bot installation prerequisites](#) on page 1429

Verify the hardware, software, and configuration required to install IQ Bot On-Premises.

## IQ Bot Windows services

IQ Bot Windows services are automatically installed when running the installation and setup.

Make sure that the following Windows services are set when installing IQ Bot.

Service name	Description
Automation Anywhere Cognitive Alias	IQ Bot service that manages domains, domain dictionary, aliases, and languages supported in the system.
Automation Anywhere Cognitive Application	IQ Bot service that provides support for all Control Room integration points and information about IQ Bot application configuration.

Service name	Description
Automation Anywhere Cognitive Classifier	IQ Bot service that provides support to classify documents in a learning instance, into different groups.
Automation Anywhere Cognitive Console	IQ Bot user interface.  <b>Note:</b> In contrast to other services, the Automation Anywhere Cognitive Console service runs on the local user account rather than the domain or service account.
Automation Anywhere Cognitive File Manager	IQ Bot service that manages documents in the file management system.
Automation Anywhere Cognitive Gateway-2	IQ Bot Gateway for all the IQ Bot backend services, handling authorization and validation of request/response of APIs.
Automation Anywhere Cognitive MLScheduler Service	IQ Bot service scheduler for ML Web Service.
Automation Anywhere Cognitive MLWeb Service	IQ Bot service that prepares models based on user validation.
Automation Anywhere Cognitive Projects	IQ Bot service managing learning instances.
Automation Anywhere Cognitive Report	IQ Bot dashboard.
Automation Anywhere Cognitive Validator	IQ Bot service to manage documents that go for validation.
Automation Anywhere Cognitive Visionbot Manager	IQ Bot service to manage vision bots in the system.
Automation Anywhere Cognitive VisionbotEngine Service	IQ Bot service to process document based on different inputs provided.

**Note:** All the services can be configured either in Local System or Domain account when IQ Bot is installed in Custom mode. For IQ Bot installed in Express mode, all the services are run in Local System account.

Related reference

[IQ Bot installation prerequisites](#) on page 1429

Verify the hardware, software, and configuration required to install IQ Bot On-Premises.

## RabbitMQ v3.8.18 and Erlang/OTP upgrade

The IQ Bot installation package includes the RabbitMQ v3.8.18 version 3.7.17 and Erlang/OTP version 22.0.

For Automation 360 IQ Bot, ensure that you download the Microsoft Visual C++ Redistributable 2017 x64 version because it is required for the latest version of Erlang/OTP.

The following information explains different scenarios for upgrading RabbitMQ v3.8.18/Erlang/OTP:

- Fresh installation of IQ Bot

For a fresh installation, you do not have to perform any additional steps, as RabbitMQ v3.8.18 Erlang/OTP are included in the IQ Bot installation package. These get installed automatically on the machine during the installation process.

- Upgrade from previous version of IQ Bot

Uninstall the earlier version of RabbitMQ v3.8.18 / Erlang/OTP.

1. Uninstall existing RabbitMQ v3.8.18 and Erlang/OTP from the Control Panel.
2. Run the `Cleanup_Components.bat` file as an administrator.
3. Restart your machine.
4. After running the scripts, verify that RabbitMQ v3.8.18 and Erlang/OTP are removed completely. If not, uninstall them manually to delete any remaining files from the program files folder, and then repeat Step 3.

- An earlier version of RabbitMQ v3.8.18/Erlang/OTP exists on the machine and the user wants to upgrade to the latest versions:

You need to manually remove any older versions from the system using a batch utility file provided by Automation Anywhere. Contact the Automation Anywhere Support team to get the utility. You can then proceed with installing IQ Bot.

Related reference

[IQ Bot installation prerequisites](#) on page 1429

Verify the hardware, software, and configuration required to install IQ Bot On-Premises.

## Installing IQ Bot in Cluster mode on machines with IQ Bot preinstalled

If you have IQ Bot already installed on your machine, uninstall IQ Bot, stop service, and clean the existing RabbitMQ v3.8.18 cookies before installing IQ Bot in Cluster mode.

- Open ports 4369 and 25672 and add inbound firewall rules to allow traffic to these ports on each target machine.
- To add nodes to the cluster, sync the RabbitMQ v3.8.18 cookies to enable running any RabbitMQ v3.8.18 commands. If IQ Bot is already installed on the target machine, clean up and remove the existing cookies.

Follow the clean up procedure before setting up a cluster:

1. Uninstall IQ Bot from Program and Features.
2. Stop the RabbitMQ v3.8.18 service, by running the command: `net stop RabbitMQ /yes`.
3. Uninstall RabbitMQ v3.8.18 from `%Programfiles%\RabbitMQ Server\uninstall`.
4. Stop the `epmd.exe` and its descendants by running this command: `Taskkill /IM epmd.exe /F`.
5. Stop `erl.exe` and `erlsrv.exe` and its descendants by running the following commands:
  - a) `Taskkill /IM erl.exe /F`

- b) Taskkill /IM erlsrv.exe /F
- 6. Uninstall Erlang from %Programfiles%\erl8.2\Uninstall.
- 7. Remove the following folders if they were not removed from the uninstall:
  - a) %Programfiles%\Rabbit MQ Server
  - b) %Programfiles%\erl8.2
- 8. Remove the following folders: %appdata%\RabbitMQ, %WINDIR%\erlang.cookie, %USERPROFILE%\erlang.cookie.

Do the following after completing the installation steps:

- The load balancer details for the following are available:
  - name of the load balancer
  - port
  - type of security used (For example, HTTP or HTTPS)
- Share a folder for configuring the output path.

---

**Note:** The user installing IQ Bot requires appropriate access permissions.

---

Related reference

[IQ Bot installation prerequisites](#) on page 1429

Verify the hardware, software, and configuration required to install IQ Bot On-Premises.

## Prerequisites for installing IQ Bot in Express mode

Complete the prerequisites to set up in express mode.

Complete the following steps before you begin installing IQ Bot in express mode.

1. Install the Control Room in a version that is compatible with IQ Bot.  
[Automation 360 IQ Bot version compatibility](#) on page 1010
2. Ensure that SQL Server Browser service is up and running before installing IQ Bot in express mode.
3. Start the SQL Server Browser service in any one of the following ways:

Option 1	<ul style="list-style-type: none"> <li>a) Launch the <b>SQL Server Configuration Manager</b>.</li> <li>b) Go to <b>SQL Server Services</b>.</li> <li>c) Start the <b>SQL Server Browser</b> services.</li> </ul>
Option 2	<ul style="list-style-type: none"> <li>a) Launch the Task Manager.</li> <li>b) Go to the <b>Services</b> tab.</li> <li>c) Start the <b>SQLBrowser</b> services.</li> </ul>

4. Use the `Automation_Anywhere_IQ_BOT_<version_number>.exe` file to install IQ Bot.
5. The setup wizard guides you through the installation process. During installation, any software dependencies or missing prerequisites are installed.

---

**Note:** When a file is uploaded to a fresh IQ Bot instance, the database administrator is unable to extract any information about that file from the database as the data is encrypted.

---

6. Enable SQL authentication.  
Enable the TCP protocol on the SQL server and listen to the local host at port 1433.
7. Set the SQL server instance name to `AACRSQLEXPRESS`.
8. Create a user with sysadmin permissions for username `aaadmin`, and password `aabots@123`.

See [Installing IQ Bot in Express mode](#) on page 1439 for steps to install in Express mode.

Related reference

[IQ Bot installation prerequisites](#) on page 1429

Verify the hardware, software, and configuration required to install IQ Bot On-Premises.

## Installing IQ Bot in Express mode

Install IQ Bot in Express mode with the default settings.

Complete the prerequisites: [Prerequisites for installing IQ Bot in Express mode](#) on page 1438

1. Double-click the `Automation_A360_IQ_BOT_<build number>.exe` file.
2. In the IQ Bot Setup Wizard, click **Yes**, and then click **Next**.
3. In the **Prerequisites** page, review the prerequisites and click **Next**.
4. In the **License Agreement** page, review the license agreement, accept the terms, and click **Next**.

IQ Bot runs a pre-installation check.

The pre-installation screen appears, displaying the applications that do not have the required version and necessary ports along with the services occupying those ports.

5. If the pre-installation check is not successful, uninstall the mentioned software and free the required ports.
  - a) Click **Retry**.
  - b) When the pre-installation check is successful, click **Next**.

The **Installation Type** page appears with **Express** and **Custom** options.

---

**Note:** Express installation installs HTTP-based IQ Bot without Active Directory support.

---

6. Select **Express** and click **Next**.
7. After you click **Next**, the `unable to proceed with installation` message might appear if the installer is unable to communicate with the Control Room or SQL Express. If the error message appears, perform these steps:
  - a) Click **Back** to review or change the installation settings. Alternatively, exit the Setup Wizard and click **Cancel**.
  - b) In the confirmation dialog box, click **Yes** to exit the Setup Wizard.  
This rolls back all the changes.

c) Click **No** to resume.

**8.** In the **Ready to install the program** page, click **Install**.

The express installation begins and the system shows the **Finished** page after a few minutes to indicate a successful installation.

IQ Bot is installed with the following default settings:

Security type: None (HTTP)

Web configuration: <web url:port>

Database configuration: <database url:port> (user: aaadmin ; Authentication: SQL)

Database password: aabots@123

Host Gateway: <gateway:port> (SSL Offloading: No)

Output path: C:\Users\Public\Documents\Automation Anywhere IQBot Platform\Output\

Logging Path: C:\Users\Public\Documents\Automation Anywhere IQBot Platform\Logs\

Logging path Automation 360 IQ Bot A360.21 onward: C:\Users\Public\Documents\Automation 360 IQBot Platform\Logs\

Installation path for Automation 360 IQ Bot: C:\Program Files (x86)\Automation Anywhere IQ Bot A2019\

Installation path for Automation 360 IQ Bot A360.21 onward: C:\Program Files (x86)\Automation 360 IQ Bot\

Verify that IQ Bot is installed, ensure that the IQ Bot services are running using the healthcheck APIs, and register IQ Bot with the Control Room. [Postinstallation checklist](#) on page 1449

## Installing IQ Bot in Custom mode

Use Custom mode to install IQ Bot with configuration details.

1. Run the `Automation_A360_IQ_BOT_<build number>.exe` installation file as an administrator.
2. For first-time installations, a server restart might be required after the installation. Restart the IQ Bot installation process if required.
3. In the Automation Anywhere IQ Bot setup wizard, click **Next**.
  - a) Click **Next** in the **Prerequisites** window.

4. Read the license agreement, accept the terms, and click **Next**.  
IQ Bot runs a pre-installation verification.

The pre-installation screen appears, displaying the applications that do not have the required version and necessary ports along with the services occupying those ports.

5. If the pre-installation verification is not successful, uninstall the mentioned software and free the required ports.
  - a) Click **Retry**.
  - b) When the pre-installation verification is successful, click **Next**.

The **Installation Type** page appears with **Express** and **Custom** options.



---

**Note:** Express installation installs HTTP-based IQ Bot without Active Directory support.

---

6. Select the **Custom** option and click **Next**.
7. On the **Database Configuration** window, add these details:
  - a) **Hostname or IP:** Enter the hostname or IP address.

---

**Note:** An underscore is not accepted in a hostname.

---

- b) **Port:** Enter the port number.

---

**Note:** If a Microsoft Windows SQL Server Express database is installed locally on the target machine, the hostname is auto-populated as localhost, and port as 1433.

---

8. Optional: To connect to your CyberArk vault to store the custom keys for encrypting and decrypting IQ Bot data, select the **Use CyberArk external vault** option and provide the following connection details to your CyberArk account.
  - **Vault URL:** The CyberArk URL endpoint on the CyberArk server
  - **Application ID:** The CyberArk-issued Application ID
  - **Object** and **Safe Name:** Identify the custom key in CyberArk
  - **Client certificate path:** The Control Room Client Certificate certificate used to authenticate to CyberArk. If the certificate is distributed in a passphrase protected file, you must enter the passphrase.
  - **(Optional) Server certificate:** You can load the CyberArk AIM Server certificate to the Control Room trust store here to make sure that the Control Room will trust the CyberArk server.

Obtain the connection details from your CyberArk vendor or IT team.

9. Enter the following database server details on the **Database Configuration** window, and click **Next**.

Option	Description
Option 1	Provide your Microsoft Windows SQL Server user credentials to log in to the database server.
Option 2	If you select the <b>Use Windows Authentication</b> check box, you do not need to provide the Microsoft Windows credentials to log in to the database server because the installer detects them automatically.

The Unable to connect to the SQL server with given configuration error message appears if the following scenarios occur:

- Incorrect server name/IP address, and port number
- Incorrect database server credentials
- Insufficient user privileges to connect to the database

---

**Note:**

- When installing IQ Bot, configure the credentials of a newly hosted database on Microsoft Azure SQL PaaS. This can take up to 300 seconds to verify the credentials and move to the next screen. However, if the on-premise database for IQ Bot is already migrated to Microsoft Azure SQL PaaS before the installation, there is no delay during the database configuration.
- IQ Bot does not support retry logic for Microsoft Azure SQL PaaS. Avoid operating IQ Bot during planned maintenance events in the Microsoft Azure SQL database.
- When IQ Bot and the database instance already exist, and IQ Bot is installed again, and IQ Bot takes the default database instance during installation.
- Windows authentication with the local system works only if the `NT Authority\System` user has system administrator permissions.
- The combination of the Local System account for Service credentials and the Microsoft Windows authentication for SQL connection is not supported if you use the remote SQL server to create databases.

**10.** In the **Services Configuration** window, select the **Local system account** check box and click **Next**.

- Select the **Local system account** check box to run the services on your local system account.
- If you do not select the **Local system account** check box, provide your user credentials to run the IQ Bot services.
  - A valid system administrator user requires Windows authentication with the Services user credentials.
  - When entering user credentials, ensure the credentials are associated with a domain. For example: `example.com/testuser`. The user cannot avail this function without the domain.

**11.** Enter the following details in the IQ Bot **Portal Configuration** window and click **Next**.

Portal security
Select the security type: <b>HTTPS</b> or <b>HTTP</b> .
If you select <b>HTTPS</b> , verify that you can browse and then select a valid PFX certificate file from the <b>Certificate Path</b> field. <a href="#">Configuring IQ Bot with HTTP when Control Room is configured with HTTPS on page 1457</a>
If you select <b>HTTP</b> then go to the next step.
Enter a valid certificate passphrase from the <b>Certificate Passphrase</b> field.

Portal configuration	
Hostname or IP	Enter the hostname or IP address of IQ Bot or use the auto-populated default, which is the fully qualified domain name (FQDN) of the machine on which you are installing IQ Bot.  <b>Note:</b> This is auto-populated by default with the FQDN of the machine on which you are installing IQ Bot.
Port	Enter the port number or use the auto-populated default, 3000.

12. In the **Load Balancer Configuration** window, do the following:

- a) Select the **Use same as IQ Bot Portal** check box to use the same hostname and port number for the load balancer as specified previously in the IQ Bot **Portal Configuration** window. This check box is selected by default. Keep this check box selected if any of the following conditions exist:
  - You are installing the IQ Bot on a single machine
  - You plan to keep the load balancer configuration the same as the IQ Bot page
- b) If the configuration values for the load balancer are different from the IQ Bot page, clear the **Use same as IQ Bot Portal** check box and enter the following:
  - **Load Balancer Hostname:** Enter the hostname or IP address.
  - **Load Balancer Port:** Enter the port number.
- c) Select the **Load Balancer can handle SSL Offloading** check box if required, and click **Next**.

---

**Note:** When configuring the load balancer, if you set the security mode to HTTPS in the IQ Bot **Portal Configuration** window, the SSL offloading is disabled by default. To enable SSL offloading for the load balancer, select **HTTP** in the IQ Bot **Portal Configuration** window.

---

These are some additional load balancer customization options:

- When you install IQ Bot on AWS, to access the IQ Bot server from an external location, replace the Host Gateway name with the Public DNS .
- During re-installation, the hostname of the load balancer and port are automatically detected by the installer based on the previous installation details stored in the Control Room. Change them as required because this is useful when you install multiple instances of IQ Bot for scalability (because you are not required to remember the details for each instance).
- When using an HTTPS certificate in the load balancer with an alias name, which is different from the hostname of the machine (FQDN), enter the alias name as the hostname.

- The installer takes the value from the IQ Bot Portal **Configuration** window, (from the previous page), but shows the previously retrieved values in the disabled text boxes from the Control Room.

**13.** In the **Destination Folder** window, make the required changes to the destination folders and click **Next**.

- **Installation Path:** Select a different installation path if required.

The default installation path is: `C:\Program Files (x86)\Automation Anywhere IQ Bot <version number>\`

IQ Bot A360.21 onward: `C:\Program Files (x86)\Automation 360 IQ Bot\`

- **Output Path:** Select the output path where the output is stored. The output path can also be a shared network path. During re-installation, the **Output Path** is automatically detected by the installer (based on the previous installation details stored in IQ Bot's Configuration database). Change the details if required.

The default output path is: `C:\Users\Public\Documents\Automation Anywhere IQ Bot Platform\Output\`

**14.** In the **Ready to Install the Program** window, verify and review your installation settings and click **Install** to start the installation.

- On first installation, during the installation process, a Microsoft Windows Security alert can prompt you to allow the installer to install Erlang. If prompted, click **Allow access**.
- Sometimes, the **Windows Security Alert** window is not visible (it can be hidden behind other active windows). Use the Alt plus tab key combination, and verify that the **Windows Security Alert** window is not hidden behind other visible windows.

**15.** Click **Allow access** to complete the installation, and in the **Installation Successful** window, click **Finish**.

An IQ Bot icon is created on the desktop.

If you encounter an error in launching IQ Bot, you might have to restart the Automation Anywhere Control Room Reverse Proxy and the Automation Anywhere Cognitive Console services.

**16.** For the Control Room, set the `cluster.properties` file as required based on the release version..

Verify that IQ Bot is installed, ensure that the IQ Bot services are running using the healthcheck APIs, and register IQ Bot with the Control Room. [Postinstallation checklist](#) on page 1449

## Installing IQ Bot in Cluster mode

Install IQ Bot in Cluster mode for improved throughput. IQ Bot supports clustering of up to five IQ Bot installations.

Ensure you have a load balancer for a cluster setup to distribute traffic to all application server nodes.

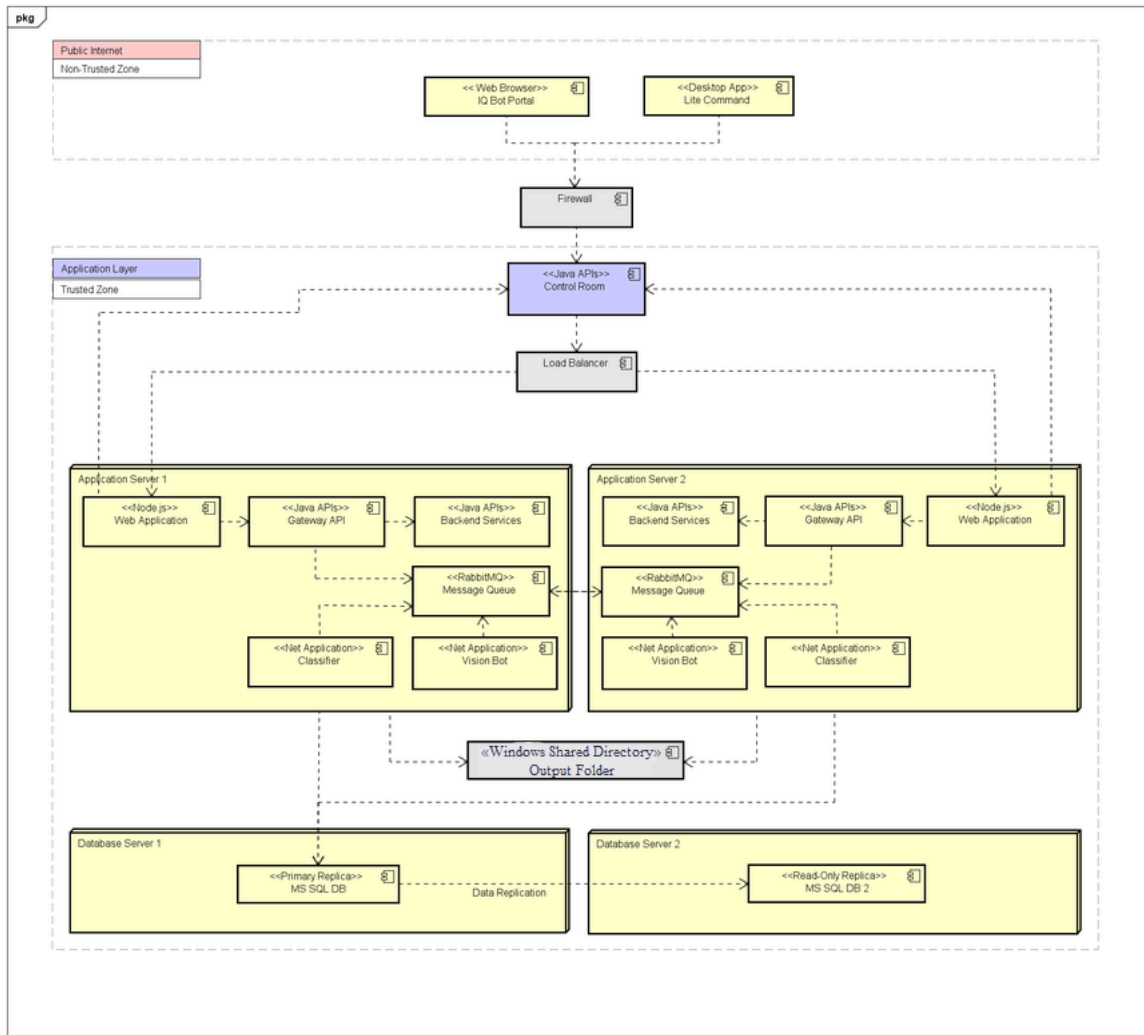

powered by Astah

1. Install IQ Bot on each machine in custom mode.
  - During installation, on the **Load Balancer Configuration** screen, type in the load balancer host name and port.
  - Select the **Load Balancer can handle SSL Offloading** option, if the load balancer supports is to enable SSL offloading.
  - Provide the shared output path on the **Destination Folder** screen.
  - During installation, use the same database server details on all the nodes.

[Installing IQ Bot in Custom mode](#) on page 1440

2. Share the **output** folder with the access role **Everyone**.  
See [Make a Shared Folder Accessible](#) on page 1447.
3. Use Command Prompt to link each machines containing an IQ Bot installation to the primary cluster.  
See [RabbitMq cluster configuration for IQ Bot](#) on page 1446.
4. Optional: If you have set up in High Availability mode, you can set up IQ Bot in High Availability mode as well.

[High availability and disaster recovery overview](#) on page 1480

5. Configure the firewall to have ports 4369 and 25672 open.

For each machine containing an IQ Bot installation, verify that IQ Bot is installed, ensure the IQ Bot services are running using the healthcheck APIs, and register IQ Bot with Control Room.

[Postinstallation checklist](#) on page 1449

---

**Note:** When you register each installation of IQ Bot, in the **URL** field, enter the URL to the load balancer.

---

**Important:** In a cluster setup, if a temporary network issue occurs, the cluster breaks. To add the nodes back into the cluster, you must manually execute commands in each of the participating nodes. You also have to monitor the cluster status to know if it is healthy or broken. To avoid such issues, you can configure the cluster to automatically recover (auto-recover) from temporary network issues. See this article for information about how to enable auto-recovery: [RabbitMQ Cluster Configuration with Auto-recovery \(A-People login required\)](#).

---

## RabbitMq cluster configuration for IQ Bot

Use the command prompt to configure three clusters.

Complete steps 1 and 2 in [Installing IQ Bot in Cluster mode](#) on page 1444.

1. Open command prompt, navigate to {RabbitMq installation directory}\sbin and execute the following command: `rabbitmqctl.bat cluster_status`.  
You will see an output similar to this:  

```
Cluster status of node
rabbit@IQBotCluster1 ... [{ nodes, [{ disc, [rabbit
@IQBotCluster1] } ] }, { running_nodes, [rabbit @IQBotCluster1] },
{ cluster_name, << "rabbit@IQBotCluster1" >> }, { partitions, [] },
{ alarms, [{ rabbit @IQBotCluster1, [] } ] } ] }
```
2. Execute the following command: `rabbitmqctl list_queues -p test`.
3. Configure the primary cluster.
  - a) In IQBotCluster1 VM, open command prompt and navigate to {IQ Bot Installation Directory}\Configurations
  - b) Execute the following command: `messagequeue_cluster_configuration.bat "IQBotCluster1"`.
4. Link the second cluster to the primary cluster.
  - a) In IQBotCluster2 VM, open command prompt and navigate to {IQ Bot Installation Directory}\Configurations.
  - b) Execute the following command: `messagequeue_cluster_configuration.bat "IQBotCluster1"`.
5. Verify if the clusters were added successfully.  
Open command prompt, navigate to {RabbitMq installation directory}\sbin and execute the following command: `rabbitmqctl.bat cluster_status`.  
You should see a similar output to the following, confirming that the two clusters were successfully added: `Cluster status of node rabbit @IQBotCluster2...[{ nodes, [{ disc, [rabbit @IQBotCluster1, rabbit @IQBotCluster2] } ] }, { running_nodes, [rabbit @IQBotCluster1,`

```
rabbit @IQBotCluster2] }, { cluster_name, << "rabbit@IQBotCluster1"
>> }, { partitions, [] }, { alarms, [{ rabbit @IQBotCluster1, [] },
{ rabbit @IQBotCluster2, [] }] }
```

6. Link the third cluster to the primary cluster.
  - a) In IQBotCluster3 VM, open command prompt and navigate to {IQ Bot Installation Directory}\Configurations.
  - b) Execute the following command: `messagequeue_cluster_configuration.bat "IQBotCluster1"`.

You should see a similar output to the following, confirming that the third cluster was successfully added: Cluster status of node rabbit @IQBotCluster3...

```
[{ nodes, [{ disc, [rabbit @IQBotCluster1, rabbit @IQBotCluster2,
rabbit @IQBotCluster3] } ] }, { running_nodes, [rabbit @IQBotCluster1,
rabbit @IQBotCluster2, rabbit @IQBotCluster3] }, { cluster_name, <<
"rabbit@IQBotCluster1" >> }, { partitions, [] }, { alarms, [{ rabbit
@IQBotCluster1, [] }, { rabbit @IQBotCluster2, [] }, { rabbit
@IQBotCluster3, [] }] }
```

When you are done linking the clusters, proceed to step 4 in [Installing IQ Bot in Cluster mode](#) on page 1444.

## Make a Shared Folder Accessible

Share the output folder with all the devices on the cluster so that when IQ Bot processes documents, the extracted data is saved to the one output folder.

Follow the steps to make your shared folder accessible to IQ Bot.

1. Change log on of the application services with .\Administrator account on all cluster nodes.
2. On primary (shared folder) node, change following settings:
  - a) Click **Control Panel > Network and Internet > Network and Sharing Center > Advanced Sharing Setting**
  - b) Expand **Private** and click **Network Discovery**.
  - c) In **Network Discovery**:
    1. Select **Turn on Network Discovery**.
    2. Check the **Turn on automatic setup of network connected devices** checkbox.
    3. Click **File and Printer Sharing** and then select the **Turn on file and printer sharing** checkbox.
  - d) Expand **Guest or Public** and click **Network Discovery**.
  - e) In **Network Discovery**:
    1. Select **Turn on Network Discovery**.
    2. Click **File and Printer Sharing** and then select the **Turn on file and printer sharing** checkbox.

Open "Local Group Policy Editor". Go to Local Computer Policy >> Windows Settings >> Security Settings >> Local Policies >> Security Options. Find "Network access :

Sharing and security model for local accounts". Change it to "Guest only - local users authenticate as Guest".

- f) Click **Local Group Policy Editor**.
- g) Click **Local Computer Policy > Windows Settings > Security Settings > Local Policies > Security Options**.
- h) Find **Network access : Sharing and security model for local accounts** and change it to Guest only - local users authenticate as Guest.
- i) Execute this Powershell script:

```
Set-ItemProperty -Path "HKLM:\SYSTEM\CurrentControlSet\Services  
\LanmanWorkstation\Parameters" -Name "AllowInsecureGuestAuth" -Type  
DWord -Value 1
```

You need to execute this Powershell script on every machine which is a part of the cluster.

After you have made the shared folder accessible to every device in the cluster, proceed to step 3 in [Installing IQ Bot in Cluster mode](#) on page 1444.

## Installing IQ Bot in Cluster mode on Amazon EC2

Install IQ Bot in the cluster mode on Amazon Elastic Compute Cloud (Amazon EC2).

If you install IQ Bot in Cluster mode on Amazon EC2, make a note of the following.

- The name for the Amazon EC2 RabbitMQ v3.8.18cluster is in this format: `rabbit@ip-XXX-XXX-XX-XX`.
- Connecting to a node works if both the nodes are in the same local network, but if you connect to a cluster outside the local Amazon EC2 network, configure the host file of node 2.
- Add an entry in the host file where `AA.AA.AAA.AAA` is the public IP of node 1.

```
AA.AA.AAA.AAA  
ip-XXX-XX-XX-XX
```

If all the IQ Bot instances in a cluster are not a part of the same domain, ensure that the following services are running using the Administrator user login on each instance.

- Automation Anywhere Cognitive Projects
- Automation Anywhere Cognitive Validator
- Automation Anywhere Cognitive File Manager

To run a service using the Administrator user login, do the following procedure.

1. Click **Task Manager > Services > Open Services**.
2. Right-click the target service, for example, Automation Anywhere Cognitive Projects, and click **Properties**.
3. In the Properties dialog box, select **This account** and enter the credentials for the administrator user.



4. Click **OK** and restart this service. Repeat these steps for the remaining services on this instance and all the other IQ Bot instances in the cluster.

## Postinstallation checklist

Verify that IQ Bot is installed, ensure that the IQ Bot services are running using the healthcheck APIs, and register IQ Bot with the Control Room.

Step 1: Verify IQ Bot in the Control Panel

Ensure that the Automation Anywhere IQ Bot item exists in **Control Panel > Programs > Programs and Features** of the machine where IQ Bot is installed.

Step 2: Confirm that Automation Anywhere cognitive services are running

Ensure that the following services are installed on the machine where IQ Bot is installed and the status of the services is set to Running on the Microsoft Windows services window.

To see the list of services that are currently running, open services.msc using **Start > Run**.

- Automation Anywhere Cognitive Alias
- Automation Anywhere Cognitive Application
- Automation Anywhere Cognitive Classifier Service
- Automation Anywhere Cognitive Console
- Automation Anywhere Cognitive File Manager
- Automation Anywhere Cognitive Gateway-2
- Automation Anywhere Cognitive MLScheduler Service

---

**Note:** As of Build 12350, this service is disabled, by default.

- Automation Anywhere Cognitive MLWeb Service

---

**Note:** As of Build 12350, this service uses a new model to better detect check boxes and tables. To revert to the previous model, open the CognitiveServiceConfiguration.json file, locate the following code snippet, and update the `version` value to `v1`:

```
"MLWebService": {
  "port": "9991",
  "version": "v2"
}
```

- Automation Anywhere Cognitive Projects

- Automation Anywhere Cognitive Report
- Automation Anywhere Cognitive Validator
- Automation Anywhere Cognitive Visionbot Manager
- Automation Anywhere Cognitive VisionbotEngine Service

To reinstall the IQ Bot services, **Run** `reinstall-allservices.bat` as an administrator from **IQ Bot Installation Directory > Configuration Folder**. You will see a list of services with serial numbers. Perform either of the following steps to reinstall the services:

1. Enter the serial number of the service that you want to reinstall.

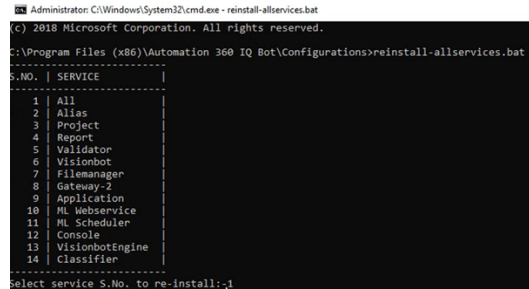

2. Enter the serial number of the service followed by the domain username and password.

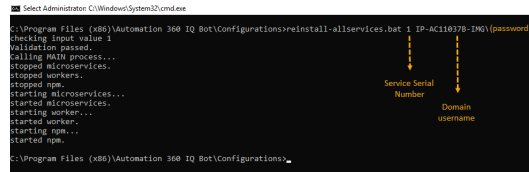

### Step 3: Perform a healthcheck

Use the Healthcheck API to verify about the required service. The request/response details of the Healthcheck API are described in the following table.

#### Requests

The following table lists the API requests sent for doing a healthcheck of different IQ Bot services:

Service name	URL
Alias	http://<hostname/IP>:9997/healthcheck

Service name	URL
Application Service	http://<hostname/IP>: <b>9002</b> /healthcheck
Project Service	http://<hostname/IP>: <b>9999</b> /healthcheck
FileManager Service	http://<hostname/IP>: <b>9996</b> /healthcheck
Visionbot	http://<hostname/IP>: <b>9998</b> /healthcheck
Validator Service	http://<hostname/IP>: <b>9995</b> /healthcheck
Report Service	http://<hostname/IP>: <b>9992</b> /healthcheck
Gateway Service	http://<hostname/IP>: <b>8100</b> /healthcheck
Frontend or Console Service	http://<hostname/IP>: <b>3000</b> /healthcheck
MLWeb Service	http://<hostname/IP>: <b>9991</b> /healthcheck

In the table listing, replace <hostname/IP> with the host name/IP address of IQ Bot to create the Healthcheck API request using a web browser on the machine on which IQ Bot is installed.

For example, if your IQ Bot is accessible at http://localhost:3000, the FileManager Healthcheck can be accessed using this URL: http://localhost:9996/healthcheck.

Responses

A typical successful response is in the following code example:

Subsystem

Application: <Service Name>  
Status: OK  
Application uptime: 0d 3h 45m 6s  
Version: 1.2.0-RELEASE  
Branch: RC-5.2-1  
GIT #:  
d88e59c0435c3a836bb47cd586081205564904c5  
Build Time:  
2018-02-17T09:26:52.523Z  
Dependencies:  
Database Connectivity: OK  
MessageQueue Connectivity: OK  
Project: OK  
VisionBot: OK  
\*\*<Service Name> could be alias,  
application, filemanager, project, reports,  
gateway, validator, or visionbot.

Dependencies: lists the status of all the dependent services, for example, database and message queue of probed service.

If the API responds with Status: Not\_OK, see [Healthcheck status Not\\_Ok \(A-People login required\)](#).

Step 4: Verify the database

The system creates the IQBot database. Log in to the database using the <dbusername> and <dbpasswd> to verify the names of the databases and tables using <hostname>, <dbusername>, and <dbpasswd>.

Step 5 (optional): Create the appropriate certificates and configure the HTTP and HTTPS settings

[Creating a self-signed certificate with Subject Alternative Name](#) on page 1453  
[Configuring IQ Bot with HTTP and HTTPS](#) on page 1455

Step 6: Register

You must register IQ Bot with Control Room before you can start using IQ Bot.  
[Registering IQ Bot with the Control Room](#) on page 1455

If registration fails:

Do the steps in the following pages to resolve the issue:

1. [Unregistering IQ Bot from the Control Room](#) on page 1470

2. [Resolving IQ Bot registration failure](#) on page 1470

Next:

Install an OCR engine (optional): During IQ Bot installation, the system sets the latest version of Tesseract Optical Character Reader as the default OCR engine. To use a different engine, follow the steps in the respective link:

[Use Microsoft Azure Computer Vision OCR engine](#) on page 1459

[Use ABBYY FineReader Engine OCR engine in IQ Bot](#) on page 1462

[Use Google Vision API OCR engine](#) on page 1465

[Use Tegaki API OCR engine](#) on page 1469

Login and set up the Control Room: Create and register IQ Bot specific users in the Control Room. Learn more about IQ Bot roles and access permissions: [IQ Bot user personas and roles](#) on page 3734

Related concepts

[Install and update Automation 360 IQ Bot](#) on page 1426

This collection of topics guide you through the process of installing or setting up Automation 360 IQ Bot On-Premises and Cloud.

## Creating a self-signed certificate with Subject Alternative Name

Create a self-signed certificate with Subject Alternative Name (SAN) when you want to use an SSL certificate for multiple domains.

1. Create a file with the name `domain.cnf` and add the following configuration as per your requirement:

```
[req]
default_bits = 2048
prompt = no
default_md = sha256
x509_extensions = v3_req
distinguished_name = dn
[dn]
C = ES
ST = MyState
L = MyCity
O = MyOrg
emailAddress = email@mydomain.com (Any email address)
```

```

CN = sss-laptop136.aaspl-brd.com (CR FQDN Url Name)
[v3_req]
subjectAltName = @alt_names
[alt_names]
DNS.1 = sss-laptop136.aaspl-brd.com (CR FQDN Url Name)
DNS.2 = sss-laptop151.aaspl-brd.com (IQBOT URL FQDN Name)

```

2. Download the Openssl utility.

3. Create the certificate either on Microsoft Windows or on Linux:

- Run the following command to create the certificate on Microsoft Windows:

```

openssl.exe req -new -x509 -newkey rsa:2048 -sha256 -nodes -keyout
"D:\ssc\ssc\key.key" -days 3560 -out "D:\ssc\ssc\cert.crt" -config
"D:\ssc\ssc\domain.cnf"

```

- Run the following command to create the certificate on Linux:

```

openssl req -new -x509 -newkey rsa:2048 -sha256 -nodes -keyout /
tmp/cert/key.key -days 3560
-out /tmp/cert/cert.crt -config /tmp/cert/domain.cnf

```

4. Create the .pfx file from cert and key file:

- Run the following command to create the .pfx file from the cert and key file on Microsoft Windows:

```

openssl.exe pkcs12 -export -out "D:\ssc\ssc\sss-aspl.pfx" -inkey
"D:\ssc\ssc\key.key"
-in "D:\ssc\ssc\cert.crt"

```

- Run the following command to create the .pfx file from the cert and key file on Linux:

```

openssl.exe pkcs12 -export -out /tmp/cert/sss-aspl.pfx -inkey /
tmp/cert/key.key -in
/tmp/cert/cert.crt"

```

5. Import the .pfx file in Microsoft IIS.

Use the same .pfx file with the installation of IQ Bot.

6. Run the following command to import the certificate in the Java keystore:

```

keytool.exe -import -alias dev -keystore "C:\Program Files
(x86)\Java\jre1.8.0_91\lib\security\cacerts" -file "D:\cert
\xyz.com.crt"

```

Based on the type of operating system 32-bit / 64-bit, this C:\Program Files (x86)\Java\jre1.8.0\_91\lib\security\cacerts directory can differ.

If the certificate is not imported in the Java keystore, then Control Room shows the following error message: Java security certificate path validator signature check failed.

7. Go to `%installation_dir%\Configurations` and run `stopanduninstallallservices.bat` as an administrator.
8. Go to `%installation_dir%\Configurations` and run `installandstartservices.bat` as an administrator.
9. Import the `cert.crt` file to the Trusted Root using the Microsoft Management Console (MMC).

Related concepts

[Install and update Automation 360 IQ Bot](#) on page 1426

This collection of topics guide you through the process of installing or setting up Automation 360 IQ Bot On-Premises and Cloud.

## Registering IQ Bot with the Control Room

IQ Bot is integrated with Control Room for user management. Log in to the Control Room and register IQ Bot.

Do the following before registering IQ Bot with Control Room:

- Launch the Control Room and create an admin user.
- Install the license for IQ Bot. See [Configure new licenses](#).

IQ Bot can be accessed after registering it with Control Room.

---

**Note:** Make a note of the database credentials used for the Control Room installation. This is required for IQ Bot installation if you are using the same database.

---

1. Log in to Control Room as an administrator.  
If you already logged into Control Room in the same browser session, you are automatically logged in to IQ Bot.
2. Click **Administration > Settings > IQ Bot**.
3. Click **Edit** in the IQ Bot section, and a text box appears.
4. Enter the correct IQ Bot URL for example, `http(s)://IQBotURL/`, and click **Save changes**.  
If the application registration fails, try registering again.

---

**Note:** The URL `https://{CR_URL}/IQBot/` is case-sensitive. For example, ensure that the URL mentions "IQBot" and not "IQbot".

---

## Configuring IQ Bot with HTTP and HTTPS

This section describes single and multiple domain scenarios when installing IQ Bot and Control Room with various server certificates.

There are two main scenarios:

- Installing and with wildcard server certificates (single domain).
- Installing and with individual server certificates (different domains).

You can encrypt the communication between IQ Bot and Control Room by configuring Two-way (Mutual) SSL. The following steps explain how to configure this and can be achieved by exchanging the SSL certificates between IQ Bot and the Control Room.

---

**Note:** IQ Bot does not support self-signed certificate.

---

#### Prerequisite for single domain

If Control Room and IQ Bot are on a single domain, and we name the domain as DomainOne, the following certificate files are required:

- PFX file:

Ensure you have the `DomainOne.pfx` file. The file size is approximately 7/8 KB. One pfx file is required for a single domain.

- CA Bundled certificate from the Enterprise Control Room (with all intermediate certificate information):

Use any tool to create the bundle certificate, or you can use openssl to create CA/bundled certificate from `DomainOne.pfx` file.

Use the following example command to create CA/Bundled certificate using openssl for `DomainOne.pfx`:

```
openssl.exe pkcs12 -in "{DomainOne.pfx file location}" -cacerts -nokeys -chain -out "{Outputlocation}\DomainOne_ControlRoom_CA.crt"
```

---

**Note:** You will need the Control Room bundle certificate for single or multiple domains.

---

- Public certificates from IQ Bot and Control Room:

Use any tool to create the public certificates or use openssl to create Public certificate from the `DomainOne.pfx` file.

Use the following example command to create the Public certificate using openssl for `DomainOne.pfx`:

```
openssl.exe pkcs12 -in "{DomainOne.pfx file location}" -clcerts -nokeys -out "{Outputlocation}\DomainOne_ControlRoom_PublicCertificate.crt"
```

---

**Note:** For a single domain, there will be one public certificate for both, IQ Bot and Control Room.

---

#### Prerequisite for multiple domains

If the Control Room and IQ Bot are on separate domains, and the domain names are DomainOne (Control Room) and DomainTwo (IQ Bot), the following certificate files are required:

- Pfx file:

Ensure you have the `DomainOne.pfx` and `DomainTwo.pfx` files. The file size is approximately 7/8 KB.

- Public certificates from IQ Bot and Control Room:



Use any tool to create the bundle certificate or use openssl to create Public certificate from DomainTwo.pfx file.

Use the following example command to create the Public certificate using openssl for DomainTwo.pfx:

```
openssl.exe pkcs12 -in "{DomainTwo.pfx file location}" -clcerts -nokeys -out "{Outputlocation}\DomainTwo_IQBot_PublicCertificate.crt"
```

**Note:** : If you set up Control Room or IQ Bot with HTTPS, then configure IQ Bot with HTTPS before registering.

## Configuring IQ Bot with HTTPS when Control Room is configured with HTTP

Configure IQ Bot with HTTPS when Control Room is configured with HTTP.

1. Set up IQ Bot using the PFX file with HTTPS configuration during installation.
2. Put the bundled certificate (DomainTwo\_IQBot\_CA.crt) for Control Room in the IQ Bot folder, after IQ Bot installation at C: \Program Files (x86)\Automation Anywhere IQ Bot\Portal\keys. Rename the DomainTwo\_IQBot\_CA.crt to ca.crt.

**Important:** If the ca.crt file in the C:\Program Files (x86)\Automation Anywhere IQ Bot <version number>\Portal\keys folder is already present, then replace it with the new ca.crt file.

3. Add the IQ Bot Public certificate (DomainTwo\_IQBot\_PublicCertificate.crt) to the keystore for the Control Room by running the following command as a system administrator:

```
"{Control Room installation directory}\JRE\bin\java.exe" -jar certmgr.jar -appDir "{Control Room installation directory}" -importTrustCert "{FolderLocation}/DomainTwo_IQBot_PublicCertificate.crt"
```

## Configuring IQ Bot with HTTP when Control Room is configured with HTTPS

Configure IQ Bot with HTTP and HTTPS to access IQ Bot using HTTPS and HTTP in the IQ Bot URL.

1. Put the bundled certificate (DomainOne\_ControlRoom\_CA.crt) for Control Room in the IQ Bot folder after IQ Bot installation at C: \Program Files (x86)\Automation Anywhere IQ Bot\Portal\keys. Rename the ControlRoom\_CA.crt to ca.crt.

**Important:** If the ca.crt file in the C:\Program Files (x86)\Automation Anywhere IQ Bot <version number>\Portal\keys folder is already present, then replace it with the new ca.crt file.

2. Add the Control Room public certificate (DomainOne\_ControlRoom\_PublicCertificate.crt) to the keystore for IQ Bot by running this command as a system administrator:

```
"{IQ Bot installation directory}\JRE\zulu8.40.0.20-sa-fx-jre8.0.222-win_x64\bin\keytool.exe" -import -alias cr -keystore "{IQ Bot installation directory}\JRE\zulu8.40.0.20-sa-fx-jre8.0.222-win_x64\lib\security\cacerts" -file "{FolderLocation}\DomainOne_ControlRoom_PublicCertificate.crt "
```

The system will ask for a keystore password, which is `changeit`.

---

**Note:** Sometimes the system shows a message saying `cr` exists. In this case, change `cr` in the command to `cr1` or something else.

---

## Configuring IQ Bot with HTTPS using single domain

Configure IQ Bot with HTTPS when Control Room is configured with HTTPS using single domain.

1. Set up IQ Bot using the PFX file with HTTPS configuration during installation.
2. Put the bundled certificate (`DomainOne_ControlRoom_CA.crt`) for Control Room in the IQ Bot folder after IQ Bot installation at `C:\Program Files (x86)\Automation Anywhere IQ Bot <version number>\Portal\keys`. Rename the `DomainOne_ControlRoom_CA.crt` to `ca.crt`.

---

### Important:

If the `ca.crt` file in the `C:\Program Files (x86)\Automation Anywhere IQ Bot <version number>\Portal\keys` folder is already present, then replace it with the new `ca.crt` file.

3. Add the Control Room public certificate (`DomainOne_ControlRoom_PublicCertificate.crt`) to the keystore for IQ Bot by running this command as a system administrator:

```
"{IQ Bot installation directory}\JRE\zulu8.40.0.20-sa-fx-jre8.0.222-win_x64\bin\keytool.exe" -import -alias cr -keystore "{IQ Bot installation directory}\JRE\zulu8.40.0.20-sa-fx-jre8.0.222-win_x64\lib\security\cacerts" -file "{FolderLocation}\DomainOne_ControlRoom_PublicCertificate.crt "
```

The system will ask for a keystore password, which is `changeit`.

---

**Note:** Sometimes the system shows a message saying `cr` exists. In this case, change `cr` in the command to `cr1` or something else.

---

Related concepts

[Naming guidelines for Control Room URLs](#) on page 1370

Adhere to Domain Name System (DNS) guidelines when you configure domain and subdomain Control Room URLs for On-Premises and Cloud deployments.

## Configuring IQ Bot with HTTPS using multiple domains

Configure IQ Bot with HTTPS when Control Room is configured with HTTP using multiple domains.

1. Set up IQ Bot using the PFX file with the HTTPS configuration during installation.
2. Put the bundled certificate (DomainOne\_ControlRoom\_CA.crt) for the Control Room in the IQ Bot folder after IQ Bot installation at: C:\Program Files (x86)\Automation Anywhere IQ Bot\Portal\keys.

Rename the DomainOne\_ControlRoom\_CA.crt to ca.crt.

---

**Important:** If the ca.crt file in the C:\Program Files (x86)\Automation Anywhere IQ Bot <version number>\Portal\keys folder is already present, then replace it with the new ca.crt file.

---

3. Add the Control Room public certificate (DomainOne\_ControlRoom\_PublicCertificate.crt) to the keystore for IQ Bot by running this command as a system administrator:

```
"{IQ Bot installation directory}\JRE\zulu8.40.0.20-sa-fx-jre8.0.222-win_x64\bin\keytool.exe" -import -alias cr -keystore "{IQ Bot installation directory}\JRE\zulu8.40.0.20-sa-fx-jre8.0.222-in_x64\lib\security\cacerts" -file "{FolderLocation}/DomainOne_ControlRoom_PublicCertificate.crt "
```

The system will ask for a keystore password, which is changeit.

---

**Note:** Sometimes the system shows a message saying cr exists. In this case, change cr in the command to cr1 or something else.

---

4. Add the IQ Bot Public certificate (DomainTwo\_IQBot\_PublicCertificate.crt) to the keystore for the Control Room by running the following command as a system administrator:

```
"{Control Room installation directory}\JRE\bin\java.exe" -jar certmgr.jar -appDir "{Control Room installation directory}" -importTrustCert "{FolderLocation}/DomainTwo_IQBot_PublicCertificate.crt"
```

---

**Note:** For Automation 360 IQ Bot (Build 550), change JRE to jrk in the command mentioned above.

---

5. Next, restart the machine(s) and follow instructions to register IQ Bot.

See [Registering IQ Bot with the Control Room](#) on page 1455

## Use Microsoft Azure Computer Vision OCR engine

Microsoft Azure Computer Vision OCR engine is a cloud OCR engine and is available to all customers of IQ Bot. IQ Bot automates some installation steps for Microsoft Azure Computer Vision OCR engine.

When you process documents using the Microsoft Azure Computer Vision OCR engine, data is removed immediately. Microsoft Azure Computer Vision OCR engine provides approximately 18% STP and 80% accuracy with data extraction. For more information on privacy for data retention, see [Microsoft Azure Cognitive Services](#).

**Note:** IQ Bot also supports containerized deployment of Microsoft Azure Computer Vision OCR engine:

[Configure IQ Bot using Docker container and Azure OCR \(A-People login required\)](#)

---

When creating a learning instance, you can select any language from the **Primary language of documents** drop-down menu. During processing, the OCR engine tries to auto-detect the primary language and can override your selection. For example, you can specify English, but if you upload a Spanish document, the API will try to process the Spanish language.

---

**Tip:** You can troubleshoot any issues with extracting data from low quality or handwritten documents [IQ Bot unable to extract data from low quality and Handwritten documents \(A-People login required\)](#)

---

Follow the steps to configure the `Settings.txt` file and use Microsoft Azure Computer Vision OCR engine.

---

**Important:** Configuring the `settings.txt` file is not applicable to Automation 360 IQ Bot Cloud

---

1. Ensure your IQ Bot server has internet connectivity and external DNS resolution.  
Check to enable communication for the API endpoint on default port = 443: `default endpoint = https://aai-iq-bot-ocr.cognitiveservices.azure.com/`.
- 

**Note:** To validate connectivity to the API endpoint and the server, open a web browser on the server and type in the complete URL for the API endpoint. If the browser returns a **404 error**, then it implies that a response from the API endpoint was received.

---

2. You can use your own Microsoft Azure Computer Vision OCR engine subscription or spell-check keys. See [Use your own keys for Microsoft Azure Computer Vision OCR engine](#) on page 1461 for more information.
3. Optional: From the `C:\Program Files (x86)\Automation 360 IQ Bot <version number>\Configurations` folder, open the `Settings.txt` file, and change the OCR engine value to `OCREngine=Tesseract4` or `OCREngine=Abbyy` to `OCREngine=MicrosoftAzureAPI`. Then save the file.
4. Run the `stopanduninstallallservices.bat` file at `C:\Program Files (x86)\Automation 360 IQ Bot\Configurations`.  
After stopping the services, run `installandstartallservices.bat` file to install and start the services.
5. Create learning instances in IQ Bot, and use Microsoft Azure Computer Vision OCR engine for the text segmentation, and OCR engine for these learning instances.  
For these learning instances, you can continue to use the IQ Bot capabilities for document classification, auto-mapped fields, cognitive extraction, and field value auto-correction.

List of service URLs used for Microsoft Azure Computer Vision OCR engine (optional)

- `https://aai-iq-bot-ocr.cognitiveservices.azure.com/`
  - `https://aai-iq-bot-ocr-spellcheck.cognitiveservices.azure.com/`
- 

**Note:** All URLs point to a global service region in United States.

---

If IQ Bot is unable to process a document using Microsoft Azure Computer Vision OCR engine, you can review the troubleshooting tips.

---

[IQ Bot unable to process the document with Microsoft Azure OCR \(A-People login required\)](#)

## Use your own keys for Microsoft Azure Computer Vision OCR engine

You can use your own Microsoft Azure Computer Vision OCR engine subscription or Spell Check keys.

Users can use a combination of their own Microsoft Azure Computer Vision OCR engine keys with the Spell Check keys provided by Automation Anywhere. Using the provided Spell Check keys from Automation Anywhere will send your data to the Automation Anywhere account. If you do not want to send any data to the Automation Anywhere Microsoft Azure account, you would have to provide your own Spell Check service keys, or turn it off by setting the value in the `AzureOCREngineSettings.json` file to `EnableAutoCorrectSegmentText: false`.

Follow the steps to use your own keys for Microsoft Azure Computer Vision OCR engine.

1. By default, IQ Bot's encrypted Microsoft Azure Computer Vision OCR engine subscription and Spell Check keys are used. If you prefer to use your own Microsoft Azure Computer Vision OCR engine subscription and, or Spell Check keys, go to `C:\Program Files (x86)\Automation Anywhere IQ Bot <version>\Configurations` and folder **Configurations** > **AzureOCREngineSettings.json** file, and specify your keys.

If both `SubscriptionKey` and `SubscriptionClientKey` are specified, then `SubscriptionClientKey` is used:

- `VisionSubscriptionKey`
- `VisionSubscriptionClientKey`
- `SpellCheckSubscriptionKey`
- `SpellCheckSubscriptionClientKey`

2. Enter your keys correctly to ensure proper API calls as follows:

Before:

```
{
  "VisionServiceUrl": "https://aai-iq-bot-ocr.cognitiveservices.azure.com/",
  "EngineType": 0,
  "VisionSubscriptionKey": "",
  "VisionSubscriptionClientKey": "",
  "SpellCheckSubscriptionKey": "",
  "SpellCheckSubscriptionClientKey": "",
  "EnableDebugging": false,
  "DebuggingFolder": "C:\\Users\\Public\\Documents\\Automation Anywhere IQBot Platform\\Output\\Engine\\Azure",
  "HttpTimeoutInSec": 300,
  "EnableReprocessLowConfidentSegment": true,
  "EnableAutoCorrectSegmentText": true,
  "EnableResolveOverlappedSegment": true,
  "EnableFieldMerging": true,
  "EnableFieldRegions": true
}
```

After:

```
{
```

```
"VisionServiceUrl": "https://aai-iq-bot-ocr.cognitiveservices.azure.com/",
  "EngineType": 0,
  "VisionSubscriptionKey": "",
  "VisionSubscriptionClientKey": "191234d5e7abc1f382123459d4399e33",
  "SpellCheckSubscriptionKey": "",
  "SpellCheckSubscriptionClientKey":
"336f8f6a503a4c30ba123456834d4abc",
  "EnableDebugging": false,
  "DebuggingFolder": "C:\\Users\\Public\\Documents\\Automation
Anywhere IQBot Platform\\Output\\Engine\\Azure",
  "HttpTimeoutInSec": 300,
  "EnableReprocessLowConfidentSegment": true,
  "EnableAutoCorrectSegmentText": true,
  "EnableResolveOverlappedSegment": true,
  "EnableFieldMerging": true,
  "EnableFieldRegions": true
}
```

3. Run the `stopanduninstallallservices.bat` file as an administrator. The default location of the file is at `C:\Program Files (x86)\Automation Anywhere IQ Bot <version>\Configurations`.
4. Run the `installandstartallservices.bat` file as an administrator. The default location of the file is at `C:\Program Files (x86)\Automation Anywhere IQ Bot <version>\Configurations` .  
Log in or refresh your IQ Bot web page.

## Use ABBYY FineReader Engine OCR engine in IQ Bot

IQ Bot supports ABBYY FineReader Engine version 12.2, 12.3, and 12.4.

When installing IQ Bot, the system automatically installs an ABBYY FineReader Engine open run-time license on your server.

---

**Note:** If you have completed the steps to upgrade IQ Bot, you must update the folder path to the `AbbyyOCREngineSettings.json` configuration file.

---

Use the following steps to manually install ABBYY FineReader Engine:

1. Download the OCR plug-in with IQ Bot.
2. Unzip the OCR plug-in folder in your downloads folder, and place that unzipped folder, at `<IQ Bot Installation Path>\Automation 360 IQ Bot\`.
3. Ensure the folder says `<IQ Bot Installation Path>\Automation 360 IQ Bot\OCR Plugins\ABBY SDK\12\FineReader Engine. . .`, and the unzipping does not create `OCR Plugins\OCR Plugins` twice. After you unzip the downloaded file, make sure to keep the folder name as `OCR Plugins`, and remove the version number. For example: If the unzipped folder name is `OCR Plugins 12.4`, remove the version number (12.4) from the end of the folder name.
4. To use ABBYY FineReader Engine with IQ Bot you have the following options:

Options	Description
Set ABBYY FineReader Engine as your default OCR engine	<p>Configure the <code>Settings.txt</code> file.</p> <p>Follow steps 5 and 6 to configure the <code>Settings.txt</code> file.</p> <hr/> <p><b>Important:</b> Configuring the <code>settings.txt</code> file is not applicable to Automation 360 IQ Bot Cloud</p> <hr/>
Select ABBYY FineReader Engine OCR engine from the UI	To select from the UI, see <a href="#">Select an OCR engine</a> on page 3748.

5. **Important:** Configuring the `settings.txt` file is not applicable to Automation 360 IQ Bot Cloud .

In Automation 360 IQ Bot Cloud, you can use the `appConfigurations` API to read and update the OCR settings.

For help with using the API, contact the Support team. [Open a support case \(A-People login required\)](#)

To set ABBYY FineReader Engine as your default OCR engine, from the `C:\Program Files (x86)\Automation 360 IQ Bot <version>\Configurations` folder, open the `Settings.txt` file, change `OCREngine=Tesseract4` to `OCREngine=Abbyy`, and save the file.

**Important:** Troubleshoot classification issue in processing Chinese language documents: [All files are getting unclassified while processing Chinese language documents \(A-People login required\)](#)

6. Next, run the `stopanduninstallallservices.bat` file at `C:\Program Files (x86)\Automation 360 IQ Bot\Configurations`.

**Note:** After stopping the services, run `installandstartallservices.bat` file to install and start the services.

7. Create learning instances in IQ Bot, and use ABBYY FineReader Engine for the text segmentation and OCR engine for these learning instances. At the same time, for these learning instances you still partner with the IQ Bot capabilities on document classification, auto-mapped fields, cognitive extraction, and field value autocorrection.

**Note:** If you install IQ Bot in a different folder besides `C:\Program Files (x86)\Automation 360 IQ Bot <version>`, find and open the **Configurations > ABBYYOCREngineSettings.json** folder, and update the embedded `EnginePath` and `LicensePath` to match the different folder.

For example:

```
{
  "UseOpenRuntimeLicense": true,
  "EnginePath": "C:\\Program Files (x86)\\Automation 360 IQ Bot\\OCR
Plugins\\ABBYY SDK\\12\\FineReader Engine\\Bin",
  "DeveloperSN": "",
  "ProjectId": "",
```

```
"LicensePath": "C:\\Program Files (x86)\\Automation 360 IQ Bot\\
Configurations\\Runtime.ABBYY.LocalLicense",
"LicensePassword": ""
}
```

**Note:** Sometimes, documents can fail to classify with ABBYY FineReader Engine as your default OCR engine.

- The following table lists the various ABBYY FineReader Engine versions that are supported and compatible with IQ Bot:

Table 2: Version compatibility matrix of ABBYY FineReader Engine and IQ Bot

ABBYY FineReader Engine version	IQ Bot version
12.2	(A2019.12) and below
12.2 and 12.3	(A2019.13) to (A2019.16)
12.2, 12.3, and 12.4	(A2019.17) and later

## Use your own ABBYY FineReader Engine license

Follow the steps to use your own ABBYY FineReader Engine license.

- Navigate to the **IQ Bot installation directory > configuration folder**, and open `AbbyyOCREngineSettings.json` to update the following properties:
  - Change the `EnginePath` and paste the installed ABBYY FineReader Engine engine path. For example, `C:\\Program Files\\ABBYY SDK\\12\\FineReader Engine\\Bin`. Ensure the path includes separators as two backward slashes. Update the `DeveloperSN` property with the license key.
  - Update the `ProjectId` property with your license project ID.
  - Update the `UseOpenRuntimeLicense` to `false`.
- From the `C:\\Program Files (x86)\\Automation Anywhere IQ Bot <version>\\Configurations` folder, open the `Settings.txt` file to ensure or modify `OCREngine=ABBYY FineReader Engine`, and save the file.
- Run the `stopanduninstallallservices` file at `C:\\Program Files (x86)\\Automation Anywhere IQ Bot <version>\\Configurations`.
- Run the `installandstartallservices` file and log in to or refresh your IQ Botweb page.

## Installation steps if ABBYY FineReader Engine remains installed from a previous IQ Bot version

If ABBYY FineReader Engine remains installed from a previous IQ Bot version, use the IQ Bot ABBYY FineReader Engine open run-time license.

- Navigate to the **IQ Bot installation directory > configuration folder**, and open the `AbbyyOCREngineSettings.json` file to update the following properties:

Change the `EnginePath` and paste the installed ABBYY FineReader Engine engine path. For example, `C:\\Program Files\\ABBYY SDK\\12\\FineReader Engine\\Bin`. Ensure the path includes separators as two backward slashes.



2. Go to the ABBYY FineReader Engine installation directory, open the Bin folder, and remove the Protection.Developer.dll file.
3. From the C:\Program Files (x86)\Automation Anywhere IQ Bot <version>\Configurations folder, open the Settings.txt file, modify or ensure OCREngine=ABBYY FineReader Engine, and save the file.
4. Run the stopanduninstallallservices file at C:\Program Files (x86)\Automation Anywhere IQ Bot <version>\Configurations.
5. Run the installandstartallservices file and log in, or refresh your IQ Bot web page.

## Use Google Vision API OCR engine

Use the Google Vision API OCR engine with IQ Bot to improve the accuracy of the optical character recognition (OCR) results for training documents in Asian languages, particularly in Japanese and Korean. Google Vision API OCR engine in IQ Bot supports all languages supported by the engine.

Verify that the default port 443 is available to enable communication for the API endpoint using TCP.

---

**Note:** See a list of allowed service URLs for using Google Vision API in the example section below.

---

Google Vision API files are installed on your machine automatically during the IQ Bot installation and is provided as a built-in plug-in, with a single-step installation, and is available for all users:

- It is a cloud OCR engine.
- Google Vision API does not support documents with more than one language. Before using this feature, ensure you want to primarily extract Japanese or Korean text only.
- Languages that are written right to left, rather than left to right, are not supported within IQ Bot for document extraction. For example, Arabic, Aramaic, Azeri, Divehi, Fula, Hebrew, Kurdish, N'ko, Persian, Rohingya, Syriac, and Urdu.

Prior to this release, the engine primarily supported data extraction for Japanese and Korean text only.

[Languages supported in Automation 360 IQ Bot on page 3739](#)

- Data is not stored in Google Cloud and is removed immediately.

For additional information on privacy for data retention see: [Google Data Usage](#)

IQ Bot provides you with the license to use the Google Vision API OCR engine. You can also use your own license key.

[Use your own license keys for Google Vision API OCR engine on page 1467](#)

---

**Note:** Updates to Google Vision API such as OCR engine improvements, enhancements, and bug fixes might affect content extraction when you use this OCR engine in IQ Bot. Therefore, we recommend that you periodically refer to the Google Vision API release notes for the latest updates.

See [Potential impact of Google Vision API OCR upgrade on page 1468](#).

---

You have the following options for using this OCR engine:

Options	Description
Option 1: Set Google Vision API as your default engine	Configure the <code>Settings.txt</code> file.  <b>Restriction:</b> Configuring the <code>settings.txt</code> file is not applicable to Automation 360 IQ Bot Cloud
Option 2: Select Google Vision API engine directly from the UI when creating a learning instance	<a href="#">Select an OCR engine</a> on page 3748

To set Google Vision API as your default OCR engine, configure the `Settings.txt` file as follows:

**Restriction:** Configuring the `settings.txt` file is not applicable to Automation 360 IQ Bot Cloud

1. Run the IQ Bot installer.
2. Optional: Set Google Vision API as the default OCR for new learning instances.  
Navigate to `..\Automation 360 IQ Bot\Configurations\Settings.txt`, and modify the following value: `OCREngine=GoogleVisionAPI`.  
This will set Google Vision API OCR engine as the default engine for your environment.
3. The `GoogleOCREngineSettings.json` file is generated within the `..\Automation 360 IQ Bot\Configurations` folder with default values as follows:  
Use the following with Google Vision API:

```
{
  "ADCJson": null,
  "EngineType": 2,
  "EnableFieldMerging": true,
  "EnableFieldRegions": true,
  "DebuggingFolder": "C:\\Users\\Public\\Documents\\Automation 360
IQBot Platform\\Logs\\Engine\\Google"
}
```

4. For Japanese and Korean language documents, update the field: `"EnableCustomParse": true`.

**Note:** A service restart is not required after making the change.

List of service URLs used for Google Vision API (optional)

Use the following allowed URLs if required:

**Note:** All URLs point to a global service region in the US.

- API URL: <https://vision.googleapis.com/>
- Auth URL: <https://accounts.google.com/o/oauth2/auth>
- Token URL: <https://oauth2.googleapis.com/token>
- Auth Provider URL: <https://www.googleapis.com/oauth2/v1/certs>

- Client Auth URL: <https://www.googleapis.com/robot/v1/metadata/x509>
1. Create a new learning instance with the Asian language document you want to train.
  2. Train the document and set your learning instance to production.
  3. Upload Asian language files and run the bot.
  4. Download and view the accuracy of the extraction results.

## Use your own license keys for Google Vision API OCR engine

You can use your own keys for Google Vision API OCR engine subscription.

Users can use their own authentication of Google Vision API. They would need to create Google Cloud Application Default Credentials (ADC) and copy the content from ADC JSON file to the "ADCJson" field in `GoogleVisionOCREngineSettings.json`.

**Note:** Use the link to create Google Cloud Application Default Credentials for Google Vision API: <https://cloud.google.com/docs/authentication/production>.

Follow the steps to use your own keys for Google Vision API OCR engine.

1. By default, IQ Bot's encrypted Google Vision API subscription keys are used. If you prefer to use your own Google Vision API subscription keys, go to `C:\Program Files (x86)\Automation Anywhere IQ Bot <version>\Configurations`, and folder **Configurations > GoogleVisionOCREngineSettings.json** file, and specify your keys.
2. IQ Bot provides you with an inbuilt license for Google Vision API, but you have the option to overwrite this license if you would like to use your own. Copy the content from the ADC JSON file correctly to ensure proper API calls as follows:

```
{
  "ADCJson": {
    "type": "service_account",
    "project_id": "dark-caldron",
    "private_key_id": "9e83979f61cff072d0e0e4f91bf837e6e29bbb",
    "private_key": "-----BEGIN PRIVATE KEY-----
\nMIIEvgIBADANBg.....----END PRIVATE KEY-----\n",
    "client_email": "vision-test@dark-
caldron.iam.gserviceaccount.com",
    "client_id": "105342202023265468399",
    "auth_uri": "https://accounts.google.com/o/oauth2/auth",
    "token_uri": "https://oauth2.googleapis.com/token",
    "auth_provider_x509_cert_url": "https://www.googleapis.com/
oauth2/v1/certs",
    "client_x509_cert_url": "https://www.googleapis.com/
robot/v1/metadata/x509/vision-test%40dark-
caldron-254807.iam.gserviceaccount.com"
  },
  "EngineType": 2,
  "EnableDebugging": false,
  "DebuggingFolder": "C:\\Users\\Public\\Documents\\Automation
Anywhere IQBot Platform\\Logs\\Engine\\Google",
  "HttpTimeoutInSec": 300,
  "EnableCustomParse": false,
  "DistanceThreshold": 15
}
```

}

## Potential impact of Google Vision API OCR upgrade

Google Vision API OCR is Cloud based, and typically, it is upgraded to a newer version according to Google's release cycle. As a result of this upgrade, an impact might be observed on document extraction processing and extraction results in IQ Bot.

## Impact on document classification in IQ Bot after the update of Google Vision API OCR

The classification of documents is based on the OCR result, particularly the order in which the fields are detected. Thus, if the content of the OCR results varies, then the classification results of the similar document processed previously might show visible differences during document extraction.

The auto-upgrade affects the classifier service in two ways:

- Different groups are assigned to documents: The documents when processed will be assigned to different groups versus what they were originally routed to so far. Consequently, some data extractions might fail, which were previously successful.
- New groups are created: The documents previously being processed with a group might now result in new group being created.

## Impact on data extraction in IQ Bot after update of Google Vision API OCR

A change in OCR output might result in the following differences during data extraction from a similar document type:

- Improvement in character recognition and its associated impact: As a result of improved keyword character recognition, previously unrecognized values from a document will now provide better extraction results.

---

**Note:** If any processing logic is written to fix the lack of detected characters, it might cause issues when the document is processed.

---

- Degradation in character recognition and its impact: Validation might fail due to degradation in OCR output, and the document will be routed to the Validator. In a scenario where there is no validation setup, the extracted data output might see a degradation.

## Options to mitigate

If you encounter any of the previously mentioned issues, you have the following options to explore:

- Retrain existing learning instance to fix issues with document classification.
- Write processing logic using Python to mitigate extraction outcomes.
- Evaluate creating learning instance with different OCR provider supported by IQ Bot.
- Raise a support ticket with Automation Anywhere.

## Use Tegaki API OCR engine

Use the Tegaki API OCR engine with IQ Bot to improve the accuracy of the optical character recognition (OCR) results that is used for training documents in Japanese and Korean languages. You can configure it for use with Automation 360 IQ Bot On-Premises.

**Important:** From Automation 360 v .30, we have deprecated the use of Tegaki API OCR engine for data extraction in Automation 360 IQ Bot. We recommend using the [Google Vision API OCR engine](#) instead. For details, see [Feature deprecations affecting Automation Anywhere products](#).

Review the following prerequisites for setting up Tegaki API OCR engine:

- Only Automation 360 IQ Bot On-Premises supports Tegaki API OCR.
- You must have a dedicated server that meets the requirements set by Cogent Labs. For more information, contact your Customer Success Manager.
- IQ Bot provides Tegaki API as a built-in plug-in. Set Tegaki API as your default OCR engine in the `settings.txt` file available in the following folder:

```
C:\Program Files (x86)\Automation 360 IQ Bot <version>\Configurations
```

- Set the communication for the API endpoint on default `port = 443`, using TCP protocol.

**Important:** Not available in Automation 360 IQ Bot Cloud.

Tegaki API OCR supports documents in the following languages:

- Japanese
- Korean
- Japanese- English
- Korean- English

1. Run the IQ Bot installer.
2. Configure the Tegaki API OCR engine for the On-Premises version on your machine based on instructions received from your Automation Anywhere representative.
3. Input your license key in the Tegaki OCR settings.json file.

As IQ Bot does not provide you with the license to use the Tegaki API OCR engine, you must use your own license key. Follow the steps to install your own license key:

- a) Navigate to the following location:

```
C:\Program Files (x86)\Automation 360 IQ Bot\Configurations
```

- b) Set up the Tegaki API endpoint where you have installed the On-Premises version. Set `APIKey = <your key here>` and configure the `TegakiOCREngineSettings.json` file.

```
{
  "APIKey": "<ensure your key meets UUID format (https://www.uuidgenerator.net)>",
  "RestEndpointURL": "<your Tegaki Server URL here>",
  "RestEndpointPort": <80>,
  "EngineType": 3,
  "EnableFieldMerging": false,
  "EnableFieldRegions": false,
  "DebuggingFolder": "C:\\Users\\Public\\Documents\\Automation Anywhere IQBot Platform\\Logs\\Engine\\Tegaki"
```

```
}  
}
```

See [How to change OCR Settings in IQ Bot \(A-People login required\)](#).

4. Navigate to `..\Automation 360 IQ Bot\Configurations\Settings.txt`, and modify the following value: `OCREngine=TegakiAPI`.

The `TegakiOCREngineSettings.json` file is available after IQ Bot installation.

1. Create a new learning instance with the Asian language document you want to train.
2. Train the document and set your learning instance to production.
3. Upload Asian language files and run the bot.
4. Download and view the accuracy of the extraction results.

Related concepts

[Install and update Automation 360 IQ Bot](#) on page 1426

This collection of topics guide you through the process of installing or setting up Automation 360 IQ Bot On-Premises and Cloud.

## Resolving IQ Bot registration failure

Use the instructions in this topic if IQ Bot registration fails due to HTTPs URL issues.

1. Use Windows **Services** to restart the Control Room service.
2. Update the Control Room HTTPs URL by logging in to **Control Room > Administration > Settings > General**.
3. Use Windows **Services** to restart the following services:
  - Automation Anywhere Control Room Cognitive Console
  - Automation Anywhere Control Room Reverse Proxy
4. Re-register IQ Bot with the HTTPs URL in the Control Room.  
IQ Bot is registered successfully.

## Unregistering IQ Bot from the Control Room

You have to unregister IQ Bot from the Control Room if the IQ Bot URL changes because of installation or uninstallation of IQ Bot, or when a load balancer is added.

After unregistering IQ Bot from the Automation Anywhere Control Room, restart the Automation Anywhere Cognitive Console service.

1. Using the **sysadmin** role, run two separate SQL queries in different databases.
2. Run the first set of SQL statements in the Control Room database to delete the following data:

Run the following SQL statements for versions A2019.10 to A2019.13:

```
DELETE FROM [AAE-Database].[dbo].[ACTIVEMQ_ACKS]
```

```
DELETE FROM [AAE-Database].[dbo].[ACTIVEMQ_MSGS]
```

```
DELETE FROM [AAE-Database].[dbo].[SERVICE_USER]
```

```
DELETE FROM [AAE-Database].[dbo].[USERS] where  
user_type='APP'
```

Run the following SQL statements for version A2019.14 and later:

a) Run the following query:

```
USE [AAE-Database]
SELECT T.uuid As TenantID,T.name AS  
TenantName,T.created_by,T.enabled,U.id AS  
IQBotAppUserId,U.user_type,S.url AS  
IQBotURL FROM [dbo].[TENANTS] T  
LEFT JOIN [dbo].[USERS] U ON T.uuid = U.tenant_uuid  
LEFT JOIN [dbo].[SERVICE_USER] S ON U.id = S.id  
WHERE (U.user_type='APP' AND S.type='IQBOT')
```

b) The above query will provide you an 'IQBotAppUserId' number. Replace id = 'IQBotAppUserId'.

c) Execute the following delete queries:

```
DELETE FROM [AAE-Database].[dbo].[SERVICE_USER] WHERE  
[type]='IQBOT'
```

d) 

```
DELETE FROM [AAE-Database].[dbo].[USERS] WHERE id =  
'IQBotAppUserId'
```

3. Run the second set of SQL statements in the IQ Bot configuration database to delete the following data:

- ```
DELETE FROM [IQBot].[dbo].[Configurations] where  
[key]='controlRoomVersion'
```
- ```
DELETE FROM [IQBot].[dbo].[Configurations] where  
[key]='appRegistered'
```
- ```
DELETE FROM [IQBot].[dbo].[Configurations] where  
[key]='controlRoomUrl'
```
- ```
DELETE FROM [IQBot].[dbo].[Configurations] where [key]='appId'
```

You have unregistered successfully.

## Set up log file automatic rollover

This topic addresses setting up automatic rollover of log files based on the file size.

After the log files are created, the system continues logging messages, which increases the log file size to a point where they are too large to open. This prevents the user from opening the log files for reviewing the information and error messages.

### Note:

- This happens sooner if the logging level is increased to DEBUG or TRACE modes.
- To ensure smooth operation of the system, manual clear the logs periodically.

For all Java services, user can identify the log files under `<IQ Bot installation directory>/Services` . Open any logging configuration file, and add the following change under `<SizeBasedTriggeringPolicy size="100MB" />` in the first occurrence of Policies:

```
<Policies>
<TimeBasedTriggeringPolicy interval="720" />
<SizeBasedTriggeringPolicy size="50MB" />
</Policies>
```

In the following example setting, after the log file reaches 50 MB, the system creates a new file automatically and starts logging in it. Though the user ends up with more files, but each file would be 50 MB only. This is standard practice to manage log files.

This example shows entries a user can add to the setting for Automation 360 IQ Bot On-Premises to automatically roll over the logs after the files reach a certain size.

```
<RollingFile name="Alias" fileName="${env:PUBLIC}/Documents/Automation
Anywhere IQBot Platform/Logs/Alias.log"
    filePattern="${env:PUBLIC}/Documents/Automation
Anywhere IQBot Platform/Logs/Archive/${date:yyyy-MMM}/Alias-%d{yyyy-
MMM-dd}-%i.log.zip"
    immediateFlush="true"
    append="true">
    <PatternLayout pattern="CPL1 Alias %X{cid} %d{ISO8601}
{UTC}Z %-5level %C %M %msg %n"/>
    <Policies>
        <TimeBasedTriggeringPolicy />
        <SizeBasedTriggeringPolicy size="50MB" />
    </Policies>
    <DefaultRolloverStrategy max="10"/>
</RollingFile>
```



## Health Check API response if RabbitMQ v3.8.18 fails to start

Check the status of each IQ Bot service using the Health Check API if RabbitMQ v3.8.18 fails to start.

The Health Check response for RabbitMQ startup failure is different in case of FileManager, Project, Validator, VisionBot as described in the following table.

Service name	Health Check response	Reason for failure
FileManager http:// <hostname>:<9996>/ healthcheck	<u>Failure 1</u> : localhost refused to connect  <u>Failure 2</u> : localhost refused to connect	Reason for failure 1: The RabbitMQ v3.8.18 node/ service went down when the Filemanager service was running.  Reason for failure 2: The RabbitMQ node/service was already down when the Filemanager service started.
Project http:// <hostname>:<9999>/ healthcheck	<u>Failure:</u> localhost refused to connect	Reason for failure: The RabbitMQ v3.8.18 node/ service is down.
Validator http:// <hostname>:<9995>/ healthcheck	<u>Failure:</u> localhost refused to connect	Reason for failure: The RabbitMQ v3.8.18 node/ service is down.
VisionBotManager http:// <hostname>:<9998>/ healthcheck	<u>Failure:</u> localhost refused to connect	Reason for failure: The RabbitMQ v3.8.18 node/ service is down.
Gateway-2 service http:// <hostname>:8100/ healthcheck	Application: gateway-2  <u>Failure 1:</u> localhost refused to connect  <u>Failure 2:</u> localhost refused to connect	Reason for failure 1: Port is blocked and the Gateway-2 service is running.  Reason for failure 2: The Gateway-2 service is not running.

## Reinstalling HTTPS SSL certificate for secure communication when it expires

Reinstall HTTPS SSL certificate in Automation 360 IQ Bot when your HTTPS SSL certificate expires.

The HTTPS SSL certificate is required for secure and encrypted communication between your browser and IQ Bot, to protect highly confidential online transactions, for example, online financial and shopping transactions. The padlock icon on your browser indicates that you have an active secure connection.

To enable a secure connection, get the HTTPS SSL certificate as follows:

1. Go to `%installation_dir%\Configurations` and as an administrator, run `stopanduninstallallservices.bat`.

---

**Note:** In a cluster installation, stop the services on each of the nodes for IQ Bot and Control Room cluster.

---

2. Go to `%installation_dir%\Portal\keys` and make a backup of the `cert.crt`, `key.key`, and `ca.crt` files.
3. Convert the `.pfx` file of the IQ Bot certificate to `.crt` and `.key` formats by running the following commands:

- Extract an encrypted key from `.pfx` file.

```
openssl.exe pkcs12 -in "path_to_cert\example.pfx" -nocerts -out
"path_to_cert\example encp.key"
```

---

**Note:** If the `.pfx` file is password protected, you need to enter the pass phrase when prompted.

---

- Convert an encrypted key to a readable format.

```
openssl.exe rsa -in "path_to_cert\example encp.key" -out
"path_to_cert\key.key"
This command converts encrypted key to a readable format.
```

- Convert the `.pfx` file to `.crt` format.

```
openssl.exe pkcs12 -in "path_to_cert\example.pfx" -clcerts -nokeys
-out
"path_to_cert\cert.crt"
```

- Fetch the `ca.crt` file from the Control Room certificate (`.pfx`) file only if the Control Room certificate also expires.

```
openssl pkcs12 -in <filename.pfx> -cacerts -nokeys -chain -out
<ca.crt>
```

4. Copy or replace the `cert.crt`, and `key.key` (generated in the previous step), and the `ca.crt` (generated using the Control Room certificate `.pfx` file) to the `%installation_dir%\Portal\keys` folder.

5. To import the IQ Bot public certificate into the Java Key store for IQ Bot, go to C:\Program Files (x86)\Automation 360 IQ Bot\JRE\zulu11\bin and run the following command as a system administrator:

```
"JRE Location\bin\keytool.exe" -import -alias iqbot-keystore  
"cacerts location of iq bot" -file " iq bot public certificate  
file"
```

Example: C:\Program Files (x86)\Automation 360 IQ Bot\JRE\zulu11\bin  
\keytool.exe -import -alias cr -keystore "C:\Program Files  
(x86)\Automation 360 IQ Bot\JRE\zulu11\lib\security\cacerts" -file  
"C:\Certificate\cert.crt"

6. To import the IQ Bot public certificate into Control Room, go to the Control Room installation path, such as C:\Program Files\Automation Anywhere\Automation360\jdk11\bin, and run the following command as system administrator:  

```
java.exe -jar "C:\Program Files\Automation Anywhere  
\Automation360\certmgr.jar" -appDir "C:\Program Files\Automation  
Anywhere\Automation360" -importTrustCert "C:\Certificate\cert.crt"
```
7. After importing the certificates, restart the Control Room and IQ Bot servers.  
This refreshes the system caches.
8. On IQ Bot Server, go to %installation\_dir%\Configurations and as an administrator, run installandstartallservices.bat.

If the Control Room certificate expires

1. Follow the steps: [Import HTTPS and CA certificates](#)
2. Convert .pfx to .crt format. 

```
openssl.exe pkcs12 -in "path_to_cert\example.pfx"  
-clcerts -nokeys -out "path_to_cert\cert.crt".
```
3. Fetch the ca.crt file from the Control Room certificate (.pfx) file. 

```
openssl pkcs12 -in  
<filename.pfx> -cacerts -nokeys -chain -out <ca.crt>
```
4. Copy or replace the ca.cert to the keys folder in IQ Bot.
5. Import the Control Room public certificate into Java Key store for IQ Bot by running this command as a system administrator: "JRE Location\bin\keytool.exe" -import -alias cr -keystore "cacerts location of iq bot" -file "control room public certificate file".

Example: C:\Program Files (x86)\Automation Anywhere IQ Bot <version  
number>\JRE\1.8.0\_161\bin\keytool.exe" -import -alias cr -keystore  
"C:\Program Files (x86)\Automation Anywhere IQ Bot <version number>  
\JRE\1.8.0\_161\lib\security\cacerts" -file "C:\Certificate\cert.crt"

---

**Note:** To change the Control Room certificate, follow steps here: [Import HTTPS and CA certificates](#)

---

## Updating Automation 360 IQ Bot

Update Automation 360 IQ Bot On-Premises to the most recent version for all the latest features and enhancements.

Ensure you back up your existing IQ Bot learning instances. Depending on the Automation 360 IQ Bot version you are currently using, the following update options are available:

- Update from earlier Automation 360 IQ Bot builds (1089, 1598, and 2079) to the latest Automation 360 IQ Bot On-Prem version

The earlier versions of Automation 360 IQ Bot had five databases. A single unified database is available starting with Automation 360 IQ Bot On-Premises Build 2545. Use the migration script to migrate these five databases to a unified database.

[Run IQ Bot On-Premises database migration script](#) on page 1476

- Update to the latest version of Automation 360 IQ Bot On-Prem.

Ensure you update your existing Automation 360 IQ Bot On-Premises to the latest version which provides the product improvements and bug fixes.

[Update Automation 360 IQ Bot On-Premises to the latest version](#) on page 1477

- Troubleshoot CyberArk vault integration for upgrade

If you encounter a vault key validation error while upgrading Automation 360 IQ Bot to Build 15112, troubleshoot the issue by ensuring the JDBC Driver is in the `C:\Windows\System32` folder.

[Troubleshoot CyberArk vault integration for upgrade \(A-People login required\)](#)

## Run IQ Bot On-Premises database migration script

IQ Bot On-Premises Builds 1089, 1598, and 2079 included five databases. Starting with IQ Bot On-Premises Build 2545, one unified database is supported. You have to run a migration script to migrate the databases of Builds 1089, 1598, 2079 to the latest build.

Before you run the migration script, you must be on the latest IQ Bot On-Premises build, and verify that the SQL command utility `SQLCMD.exe` is installed on your system.

Also, verify and ensure Microsoft ODBC Driver 17 for SQL Server is installed on the IQ Bot server. This can be obtained from: <https://learn.microsoft.com/en-us/sql/connect/odbc/download-odbc-driver-for-sql-server?view=sql-server-ver16>

1. Uninstall the current build of IQ Bot On-Premises.
2. Install the latest IQ Bot On-Premises build.

During installation, a new IQ Bot database is created.

---

**Note:** Remember your database username and password in order to the update migration script value.

---

3. Navigate to your Binn folder.

This might be located in `C:\Program Files\Microsoft SQL Server\Client SDK\ODBC\170\Tools\Binn`.

4. Verify that `SQLCMD.exe` is installed.

If SQLCMD.exe is not installed, follow these steps:

- a) Download and extract the Data Migration.zip from the [Installation Setup](#) folder onto the IQ Bot server.
- b) Navigate to **DataMigration > UTILITY-MsSqlCmdLnUtils**.
- c) Run MsSqlCmdLnUtils.msi to install SQLCMD.exe.

After SQLCMD.exe is installed, run the migration script.

1. Access the AA.IQBot\_Database\_Migration.bat file within the DataMigration folder.
2. Edit the AA.IQBot\_Database\_Migration.bat file.
3. Update the values as follows:
  - a) Set the SQLCMD value to the path of your Binn.

```
SQLCMD="C:\Program Files\Microsoft SQL Server\Client SDK\ODBC
\170\Tools\Binn\SQLCMD.exe"
```

- b) Set LOGIN value to your database username.  
LOGIN="database username"

---

**Note:** The **bulkadmin**, **dbcreator**, and **public** roles are required to run the migration script.

---

- c) Set the PASSWORD value to your database password.  
PASSWORD="database password"
  - d) Set the SERVER value to the path of your database server hostname.  
SERVER="path of database server hostname"

4. Run the migration script AA\_IQBot\_Database\_Migration.bat file with administrator privilege.  
After the migration is complete, an output is created. Verify C:\Datamigrationlog.txt for log history and errors.

---

**Note:** If an output is not displayed, contact support.

---

## Update Automation 360 IQ Bot On-Premises to the latest version

If you are using any of the earlier versions of Automation 360 IQ Bot On-Premises, you can update to the latest version, which offers enhancements and bug fixes.

It is recommended that you review your existing Automation 360 IQ Bot On-Premises version and back up your database, output path, and installation configuration files.

---

**Note:** Uninstall the existing version of Automation 360 IQ Bot On-Premises from your device before updating to the latest version.

---

1. Go to Automation Anywhere support site to download the latest version of the Automation 360 IQ Bot setup file.

[A-People Downloads page \(Login required\)](#)

2. Click the link to the latest Automation 360 IQ Bot setup file.
3. Click `Installation Setup`.
4. Download the `Automation_Anywhere_IQ_Bot_A2019_Build_<build number>.exe` file and install it.

[Install and update Automation 360 IQ Bot](#) on page 1426

The latest version of Automation 360 IQ Bot On-Premises is installed on your device.

## Upgrading and downgrading IQ Bot

Uninstall and install a later version to upgrade IQ Bot. Uninstall and install an earlier version of IQ Bot to downgrade.

To upgrade or downgrade IQ Bot, perform the following procedure.

- Upgrading IQ Bot
  - a) Create a new folder in any location and take a backup of the `Settings.txt` and both or either of the `.json` files `ImageProcessingConfig.json` or `AbbyyImagePreProcessingSettings.json` for your reference from the `<Installation Path/Configuration>` folder to this new folder.
  - b) Take a backup of the existing IQ Bot databases before starting the upgrade.
  - c) Follow the uninstall process:  
[Uninstalling IQ Bot](#) on page 1479
  - d) Copy a later version of IQ Bot installable file from `<path of the installable file>` to your local system.
  - e) Follow the installation process.

---

### Note:

- Refer to the settings from the `Settings.txt` and both or either of the `.json` files `ImageProcessingConfig.json` or `AbbyyImagePreProcessingSettings.json` to enter the configuration values when you are installing an earlier version of the product.
- Back up your database to restore it in case any issue occurs in future or in case you downgrade to an earlier version of IQ Bot.
- If you are using the ABBYY FineReader Engine OCR, you must update the folder path to the `AbbyyOCREngineSettings.json` configuration file after completing the upgrade installation steps.

---

[Migrate learning instances](#) on page 1725

- Downgrading IQ Bot
  - a) Create a new folder in any location and take a backup of the `Settings.txt` and both or either of the `.json` files `ImageProcessingConfig.json` or `AbbyyImagePreProcessingSettings.json` for your reference from the `<Installation Path/Configuration>` folder to this new folder.
  - b) Uninstall the later version of IQ Bot.

- c) Take a backup of the current databases.
- d) Remove the backup of the current databases.
- e) Restore the database backup of the earlier IQ Bot version.
- f) Install the earlier version of IQ Bot.

---

**Note:**

- Refer to the settings from the Settings.txt and both or either of the .json files ImageProcessingConfig.json or AbbyyImagePreProcessingSettings.json to enter the configuration values when you are installing an earlier version of the product.
  - Back up your database to restore it in case any issue occurs in future or in case you upgrade to a different version of IQ Bot.
- 

## Uninstalling IQ Bot

If you have installed Automation 360 IQ Bot On-Premises, use these steps to uninstall IQ Bot and its dependencies.

To manually uninstall, go to **Windows > Control Panel > Programs > Uninstall a program**, and choose IQ Bot.

For all other versions, use the following steps.

1. Double-click the `Automation_360_IQ_BOT_<version-number>.exe` installer file. The Automation Anywhere IQ Bot - Wizard appears.
2. Enter the administrative permissions in the **User Access Control** dialog box if a dialog box appears.

---

**Note:** Ensure you close all the existing browser instances running IQ Bot before you begin uninstallation.

---

3. Click **Next**. The **Ready to Remove** page appears.
4. Click **Remove**.

The uninstallation process begins.

---

**Note:** During the uninstallation process, if setup information appears, click **OK** to continue. Clicking **Cancel** to close the process.

---

5. When complete, the **Finished** page appears. Click **Finish** to complete the process.

---

**Note:** Uninstalling IQ Bot does not delete the IQ Bot database or any of the following dependencies. Manually remove them using recommended third party procedures.

- Erlang/OTP
- RabbitMQ v3.8.18
- NodeJS

- SQL Server Native Client
  - Python
- 

## High availability and disaster recovery overview

High availability (HA) provides a failover mechanism if an IQ Bot service or server fails. Disaster recovery (DR) enables recovery across a geographically separated distance if a disaster causes an entire data center to fail.

IQ Bot uses a minimum of 3 nodes and a maximum of 5 nodes in a cluster for high availability (HA).

### IQ Bot HA and DR solution

In the context of IQ Bot, implementation of High Availability (HA) and Disaster Recovery (DR) reduces downtime and maintains continuity of business (CoB) for your bot activities.

- High availability (HA)— High availability is an architectural system design that attempts to safeguard a system against certain failure scenarios. This means that even if parts of a system is failing, as a whole it is still available and usable. High availability solutions typically protect against specific scenarios such as: server failures, single component failures, dependency failures, variable load increases, and networks splits where dependent on system components that become unreachable on a network.
- Disaster recovery (DR)— Disaster recovery involves a set of policies and procedures to enable the recovery or continuation of vital infrastructure and systems following a natural or human-induced disaster. Disaster recovery addresses many different causes of failures in a system where high availability typically accounts for a predictable few. Disaster recovery has a focus on re-establishing services after an incident not just failover. Recovery of a system includes scenarios such as: restarting a service or system, restoring configuration files or a database from backups.

To ensure HA and DR protection of your IQ Bot components, configure your existing HA and DR infrastructure, load balancing, and failover systems to include IQ Bot servers and services. See your data center administrator for your approved local HA and DR procedures.

### Required HA and DR infrastructure elements

- Distributed approach— In addition to clustering IQ Bot related data center components, we also recommend that you deploy IQ Bot on multiple physical and, or virtual servers.
- Load balancing— Performed by a load balancer, this is the process of distributing application or network traffic across multiple servers to protect service activities and allows workloads to be distributed among multiple servers. This ensures bot activity continues on clustered servers.
- Databases— Databases use their own built-in failover to protect the data. This ensures database data recovery.
  - Between the HA clusters, configure synchronous replication between the primary (active) and secondary (passive) clustered Microsoft SQL Server instances in the data center. This ensures consistency in the event of a database node failure.



For the required HA synchronous replication, configure one of the following:

- Backup replica to **Synchronous-Commit mode of SQL Server Always On** availability groups
- SQL to **Server Database Mirroring**
- Between the DR sites, configure your database to provide asynchronous replication from the primary (production) DR site to the secondary (recovery) DR site that is at a geographically separated location from the primary DR site.

## Sample scenario

Point all IQ Bot instances within the same cluster to the same database and repository files. This is required to enable sharing data across multiple servers and ensuring data integrity is maintained across IQ Bots servers within a cluster.

## HA and DR deployment models

To ensure your IQ Bot is protected by HA and, or DR, configure your data centers according to the deployment models described in:

- [High Availability deployment model](#) on page 1484
- [Disaster Recovery deployment model](#) on page 1484

## HA implementation requirements

- Install IQ Bot on multiple servers.
- Access to IQ Bot is through a load balancer.
- Open a RabbitMQ v3.8.18 synchronization port between IQ Bot servers.
- Configure the Microsoft SQL Server in high availability mode.

## Installation HA and DR configuration requirements

- The IQ Bot installer does not directly support cluster installation. To set up a cluster do the following:
  - Run the installer on each application server node.
  - Share the `output` folder using the access role `Everyone`.
  - Post installation, execute the `messagequeue_cluster_configuration.bat` with appropriate command line arguments.
- Configure IQ Bot in a high availability configuration.
- Open firewall ports: 4369 and 25672.
- Install RabbitMQ v3.8.18 on every IQ Bot node in the cluster.

The first node where IQ Bot is installed becomes the primary RabbitMQ v3.8.18 node. The host name of the primary node is used to configure the RabbitMQ v3.8.18 cluster.

- The load balancer is required to distribute a traffic to all IQ Bot server nodes.
- Configure Microsoft SQL Server for high availability. Use the Microsoft SQL Server **Always On** option.
- For RabbitMQ v3.8.18 specific installation, see your RabbitMQ v3.8.18 documentation.

## HA and DR known limitations

- To discover the availability of IQ Bot instances, a load balancer periodically sends pings, attempts connections, or sends requests to test the IQ Bot instances. These tests are called health checks.
- Health checks do not verify the availability of RabbitMQ v3.8.18 instances.

## HA cluster configuration overview

To support Automation Anywhere in your data center, configure an HA cluster. Follow your company methods and procedures for implementing your data center cluster.

HA clusters protect services and data in the event of a server or service failure. The following is a list of processes associated with clusters.

Database replication	Configure synchronous replication between the primary site (active) and secondary site (passive) Microsoft SQL Server instances to ensure consistency in the event of a database node failure.
Downtime	The amount of downtime depends on the number of restart attempts the administrator configures for the primary server services, the number of failovers allowed per number of hours, and the failback configuration.
Failback	After the primary server is returned to normal, fail back the workload from the secondary servers to the primary servers. The primary server becomes the active server again. Restoring operations to the primary system or site after a failover or disaster recovery on a secondary system or site.
Failover	If one of the primary servers fails, the workload of the failed server automatically shifts to the secondary server in the cluster. This automatic process is called failover. Failover ensures continuous availability of applications and data. When failover completes, the secondary server becomes the active server. When a (primary) system detects a fault or failure, it automatically transfers control to a (secondary) duplicate system. This applies to HA clusters, where failover is from one server to another.

Graceful degradation	Process allowing cluster dependencies to operate gracefully on a degraded primary site.
Redundancy	HA clusters use redundancy to prevent single points of failure (SPOF), such as a failed server or service. HA clusters include primary (active) servers that host services or databases and secondary (passive) servers that host replicated copies of the services and databases.
Replication	The secondary servers have the same configuration and software as the primary servers, they are a duplicate (redundant copy) of the primary. Data is replicated (copied) from the primary servers to the secondary servers.

To support HA and DR for Automation Anywhere, configure the selected components in your data center for HA.

---

**Note:** In the context of clusters, though the terms server, host, and node each have specific meaning, they are frequently used interchangeably.

---

Cluster	A cluster is a set servers (nodes) that are connected by physical cables and software. In an HA environment, these clusters of servers are allowed to be in the same physical data center.
Cluster group (role)	Group of clustered services that failover together and are dependent on each other.
Host	The cluster machine that is hosting the services.
Multiple servers	The HA technique where operations are available across multiple servers with workload managed by a load balancer. This applies to IQ Bot instances.
Node	A generic term for a machine in a cluster.
Primary node	The active node in the cluster. The machine where the production activities run. This applies to the database servers.
Secondary node	The machine that is designated as the target in the event of a failover. The secondary node is a passive duplicate of the primary node. This applies to the database servers.
Server	The machine in the cluster installed with the server operating system.

HA cluster technologies guard against three specific types of failures:

Application and service failures	These affect application software and essential services.
Site failures in multisite organizations	This is caused by natural disasters, power outages, or connectivity outages.

System and hardware failures	This affects hardware components such as CPUs, drives, memory, network adapters, and power supplies.
------------------------------	--

This ability to handle failure allows clusters to meet two requirements that are typical in most data center environments:

High availability	The ability to provide end users with access to a service for a high percentage of time and reduces unscheduled outages.
High reliability	The ability to reduce the frequency of system failure.

### High Availability deployment model

The High Availability (HA) deployment model provides failure tolerance for the IQ Bot servers, services, and databases.

The following shows IQ Bot and data center components.

In this example, the IQ Bot servers and Microsoft SQL Servers have HA redundancy.

- Multiple users have access the IQ Bot cluster through their web browsers. The web browsers communicate to the IQ Bot cluster through the load balancer.
- Multiple Bot Runners communicate to the IQ Bot cluster through the load balancer.
- The server message block (SMB) file share and the Microsoft SQL Server store data from the IQ Bot cluster.
- Microsoft SQL Server uses redundancy through replication syncing to the clustered Microsoft SQL Server.

Pros	Maintains availability when server failures occur within a single data center.
Cons	Does not provide protection against data center outage.
Use Cases	Small to medium-size businesses that do not require multi-site disaster recovery.

### Disaster Recovery deployment model

The Disaster Recovery (DR) deployment model uses high availability (HA) clusters distributed over a geographic area.

Disaster Recovery (DR) is a method where two high availability (HA) data center configurations are separated geographically. The extra benefit here from a single location HA configuration is that in the event of a localized disaster, the physically removed data center resumes functions with minimum downtime.

Prerequisites

Before performing the IQ Bot DR, review the following prerequisites:

- Enable the inbound and outbound ports.

- Add all the hostnames in the host file entries for all the nodes.
- Ensure that the primary and secondary databases are in sync.
- Automation Anywhere Control Room and IQ Bot must be installed on both primary (active) and secondary (passive) DR sites.
- While switching between the primary and secondary servers, ensure the following:
  - If the secondary database has read-only permission, the primary database has read/write permission.
  - If the secondary database has read/write permission, the primary database has read-only permission.

The following diagram shows the IQ Bot DR setup:

In this example, all the servers have redundancy.

- Multiple users have access the IQ Bot cluster through their web browsers. The web browsers communicate to the IQ Bot clusters through the load balancers.
- Multiple Bot Runners communicate to their IQ Bot cluster through the load balancer.
- The server message block (SMB) file share and the Microsoft SQL Server store data from their IQ Bot cluster. Both servers are asynchronously replicated to the backup disaster recovery site.
- Microsoft SQL Server uses redundancy through replication syncing to the clustered Microsoft SQL Server on the primary disaster recovery site.

For disaster recovery in IQ Bot environment.

- Deploy a second IQ Bot HA cluster in an additional data center that is in a separate geographic location.
- In the event of a primary site failure, do the disaster recovery manually. See [Disaster recovery failover steps overview](#) on page 1487.

---

**Note:** When a failover to a backup site occurs, it is possible that very recent changes made on the primary site are lost.

---

Pros	Provides business continuity when faced with data center outage or loss.
------	--

Cons	Increased operational burden.
------	-------------------------------

Contact your Customer Success Manager (CSM) or Partner Enablement Manager (PEM) for more information on benchmarking IQ Bot On-Premises Disaster Recovery.

[IQ Bot On-Premises Disaster Recovery benchmarking \(A-People login required\)](#)

## DR configuration requirements

When you configure your Disaster Recovery enabled data centers for IQ Bot, ensure the listed conditions are met.

### Disaster Recovery configuration requirements

- Asynchronous replication—Configure asynchronous, rather than synchronous replication, between DR sites for all supporting services. This ensures off-site replication does not impact performance of the primary site.
- AD domain—Ensure the same Active Directory domain is available to both the primary and backup sites.
- Site domains—Ensure the backup site Control Room and device machines are members of the same domain as the primary site Control Room and machines.
- Licenses—Assign floating licenses for users, so that they are able to log into devices on the backup site.
- Backup site services—Shutdown the Control Room services at the backup site until they are needed.
- Site configurations—Ensure the machines at the primary site and backup site have the same specification and configuration. This includes the Control Room, Bot Runners, associated devices, and login credentials. This is required to ensure equal level of service during an outage.

---

**Note:** Schedules are stored in UTC and therefore run at the same time regardless of the physical location or time zone settings of the server.

---

### Database Replication Details

The database replication configuration for disaster recovery is an extension of the high availability configuration. This configuration requires the use of **Always On** availability groups.

- Configure the primary site replica in **Synchronous-Commit** mode.
- Configure the recovery site replica in **Asynchronous-Commit** mode. **Asynchronous-Commit** mode ensures that the latency and reliability of the inter-datacenter does not impact the performance and availability of the primary site.
- Do not configure the recovery site replica to offer any database services until a recovery failover is triggered.

### Failure mode

With asynchronous replication there is the possibility that a transaction that occurs on the primary site does not reach the recovery site replica before the failure occurs.

---

**Note:** This possibility of losing the most recent transactions applies to all DR automated application solutions using asynchronous replication, not just Automation Anywhere solution.

---

Deployment requires strict consistency between distant geographical locations. **Synchronous-Commit** configured between replicas with significant latency has a detrimental effect on all Control Room operations.

To prevent work items being processed twice when a failure occurs, some work items awaiting delivery to a device are placed into an error state. This ensures they can be manually reviewed and marked as ready to be processed or complete as appropriate.

## Disaster recovery failover steps overview

Overview of failover steps for IQ Bot recovery after a disaster.

Complete the disaster recovery deployment on two geographically separated sites, where one site is primary (active) and the other is a backup (passive) site. Disaster recovery is performed on remote backup site.

The procedure is identical regardless of whether switching over from primary to secondary (recovery), or secondary to primary.

If the failed IQ Bot nodes are still available:

1. Shut off all IQ Bot services at the primary site.
2. Failover all IQ Bot-related databases using the database tools.
3. Failover your Server Message Block (SMB) share using the appropriate tools to make the recovery site SMB file share writable.
4. Start IQ Bot services at the recovery site.
5. Wait until the IQ Bot web interface is available.
6. Login to the web interface as an administrator.
7. After the recovery site is operating as the primary site, configure a replacement secondary site. Using the database tools, set replication from the recovery primary site to the replacement secondary site.

## Re-establish a duplicate DR site

After a secondary (backup) site is recovered as the primary (production) site, establish a new secondary DR site.

The recovery site is up and running as the new production site.

The process of returning activity to a primary (active) production site, plus secondary (backup) site depends on the state of the original primary site.

- If the old production environment becomes available again, complete the following to switch back to the original DR primary site.
  - a) Restore/replicate the DR database and file system to the original production database and file system respectively.
  - b) Bring up the new DR primary (production) IQ Bot.
  - c) Verify new DR primary (production) environment is working, as expected.
  - d) Stop the DR IQ Bot services on the DR recovery site.
  - e) Establish the replication between the new DR primary (production) and DR secondary (standby) IQ Bot (DB and NAS).
- If the old DR primary production environment is rendered completely unusable due to the disaster, re-establish a new secondary (standby) DR site. Complete the recovery DR steps to re-establish primary and secondary DR sites.

- a) Restore/replicate the database and file system data from DR environment to the new production environment.

No additional steps are required. The DR primary and secondary sites are restored.

- The bot Activation utility does not need to be run again. Activation occurs when IQ Bot is first deployed to the DR cluster sites only.
- For any subsequent disasters, only the database query needs to be run on DR secondary (standby) IQ Bot database. This is required because the replication between DR primary (production) and DR secondary (standby) overwrites DR secondary site Bot Runner data in DR secondary site database with DR primary (production) Bot Runner data.
- Similarly, the mapping between DR primary and DR secondary Bot Runner is established. Use the same mapping for all subsequent disasters or mock drills.

## Log in to Automation Anywhere Control Room

To log in to Automation 360, open the Control Room URL in your browser, enter your credentials in the login screen, and click **Log in**.

Receive your registration confirmation email.

- Automation 360 users: This is sent by your system administrator.
- Community Edition users:
  1. Register for the Community Edition.  
[Set up Community Edition](#) on page 1326
  2. This is sent by Automation Anywhere using the information you provided when you registered.

This email contains:

- Control Room URL
- Username, credentials, and provisioning tokens (where applicable)
- Temporary password

Reset this password when you log in the first time.

---

**Note:** If you use the Microsoft Internet Explorer browser to log in to the Control Room, a notification banner is displayed indicating that support for Internet Explorer 11 is ending. Your Control Room will no longer be accessible on Internet Explorer. Starting from the Automation 360 v.25 release, you will be prompted to access the Control Room through an alternative supported browser, such as Google Chrome or Microsoft Edge (Chromium). Refer to the banner for details on how you can evaluate any potential impact to your existing automations. [Microsoft Internet Explorer 11 EOL FAQ](#) on page 1100

---

1. Open the URL in your browser.
2. In the **Log in** form, enter your username and password.  
If this is the first time you are logging in, use the password provided in your welcome email.
3. First-time users: Change your password. For Cloud users, create your security questions.



The change password and create security questions form automatically opens when you log in for the first time. Complete the form.

**a)** Complete the **Change password** fields.

Enter your current password, enter your new password, and confirm the new password.

Passwords must be 8-15 characters long and can only contain the following characters: a-z, A-Z, 0-9, at sign (@), dash (-), underscore (\_), exclamation point (!), number sign (#), dollar sign (\$), percent (%), ampersand (&), and period (.).

**b)** For Cloud users: In each pair of question and answer fields, enter a question and an answer that you will remember if you forget your password or must confirm your login.

**c)** Click **Save and log in**.

After the first login, to change the password, click your **username**, select **Change password**, and complete the form.

**4.** Optional: Select **Remember my username** to quickly log in to the Cloud Control Room.

**5.** Optional: Click **Forgot password?** to reset your password.

An email is sent to you with a link to the necessary page to reset the account password.

**6.** Click **Log in**.

The credentials are authenticated directly with the Cloud Control Room or Community Control Room database.

---

**Note:** When you access the Enterprise Control Room with the **Login with Windows** option selected, you must enter the FQDN to log in successfully.

---

---

**Note:** Your account is locked if you enter the wrong password a specific number of times depending on the password policy set by your administrator. For security reasons, failed log-in attempts are audited. This allows the administrator to analyze and take appropriate actions.

---

#### Related tasks

[Create your first bot](#) on page 1489

Perform the following steps to create your first bot that prints the message, `Go be great!`, the Automation Anywhere version of `Hello World!`

[Install Bot Agent and register device](#) on page 1347

Install Bot Agent on your local device and connect it to Control Room. In order to run bots on that local device, ensure that you add it to the list of enabled host devices.

[Reset user password](#) on page 1747

The Control Room administrator generates an email process for the user to reset their password.

## Create your first bot

Perform the following steps to create your first bot that prints the message, `Go be great!`, the Automation Anywhere version of `Hello World!`

This task is performed by the user who wants to build and deploy. You must have the necessary rights and permissions to complete this task, and authorization to log in to the as the licensed user.

- You must have the Bot Creator license to create bots in the Control Room.

- You must have the following permissions:
  - Check in
  - View packages
  - Create folders
- naming conventions: Keep the following considerations in mind when creating and naming :
  - When creating a , ensure that your name does not include the following special characters:

Slash (/)	Asterisk (*)	Comma (,)
Backslash (\)	Less than sign (<)	Left or right braces ({})
Question mark (?)	Greater than sign (>)	Left or right brackets ([])
Pipe ( )	Double quotation marks (")	Plus sign (+)
Percent sign (%)	--	--

- The name must be unique. If a with the same name exists in the same folder location to which you have access in the public workspace, you cannot create or rename the with this name in the private workspace.
- Do not use names that are reserved for the Windows operating system. The reserved names are as follows:

CON	PRN	AUX	NUL	COM1
COM2	COM3	COM4	COM5	COM6
COM7	COM8	COM9	LPT1	LPT2
LPT3	LPT4	LPT5	LPT6	LPT7
LPT8	LPT9	--	--	--

- Ensure that a name does not end with a period (.) or space.
- For more information about file naming, see [Microsoft guidelines](#).

---

**Note:** These steps describe the guided workflow for first time users. The guided workflow is only displayed the very first time you complete these steps.

---

- Log in to your instance of the Automation Anywhere Control Room.
- Create a new bot:
  - On the left panel, click **Automation**.
  - Click **Create new > Bot**.
  - In the **Create Task Bot** window, enter the bot name.
  - Accept the default folder location: `\Bots\`  
To change the default bot storage location, click **Choose** and follow the prompts.
  - Click **Create and edit**.
- Insert a **Message box** action.
  - Click **Actions**.
  - Search for the Message Box package.

Click in the **Actions** search box and enter `message`. Click the arrow to expand the Message Box options.

- c) Double-click or drag the **Message box** action to the Bot editor (open space to the right).
4. In the dialog box on the right, specify the conditions for the **Message box** action.
    - a) In the **Enter the message box window title** field, enter `My first bot!`.
    - b) In the **Enter the message to display** field, enter `Go be great!`.
    - c) Accept the defaults in the **Scrollbar after lines** field and **Close message box after** check box.
  5. Click **Save**.

Your bot is now ready to run.

You can view the time spent to create a bot by navigating to **Automation > Home > My metrics**. The **Active Task Bots** table displays the time taken to create every bot. When a bot is edited, the table shows the total time spent on the bot.

For example, if you spend 10 minutes on creating and saving a bot, the **Active Task Bots** table displays the time spent as 10 minutes. If you spend 5 more minutes on editing the same bot, the **Active Task Bots** table displays the total time spent as 15 minutes.

Similarly, the **Average time spent to create a Task Bot** field on the **My Metrics** page displays the average time spent across all users on all bots.

For example, if user 1 spends 120 minutes on **Bot A**, user 2 spends 2 minutes on **Bot B**, and user 3 spends 4 minutes on **Bot C**, the average time is calculated as  $(120+2+4)/3 = 42$  minutes.

6. Click through the Bot editor options for viewing and editing bots:  
They are located at the top of the Bot editor.

---

**Note:** You can use the search box in the **Flow**, **List**, or **Dual** view to search for text, variables, or actions in a bot. This feature can be helpful when you view or edit a bot with longer code lines.

---

- **Flow:** Displays actions used in an automation as a flow diagram (Default)

---

**Note:** The **Flow** view is not available when you create or edit a bot and the bot exceeds 500 lines of code. Use the **Show list view** option to navigate to the list view.

---

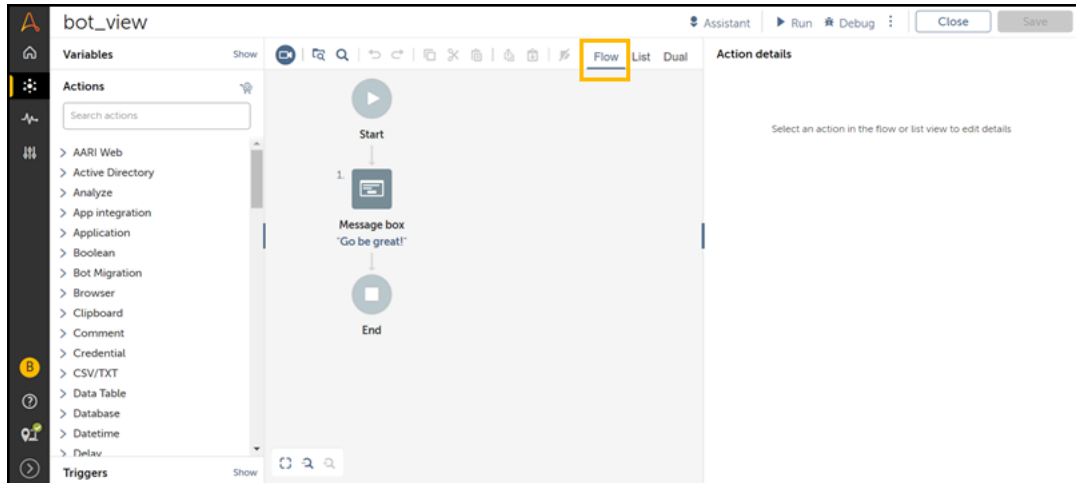

- **List:** Displays the actions used in an automation as a list

**Note:** Drag the selected actions within the task logic.

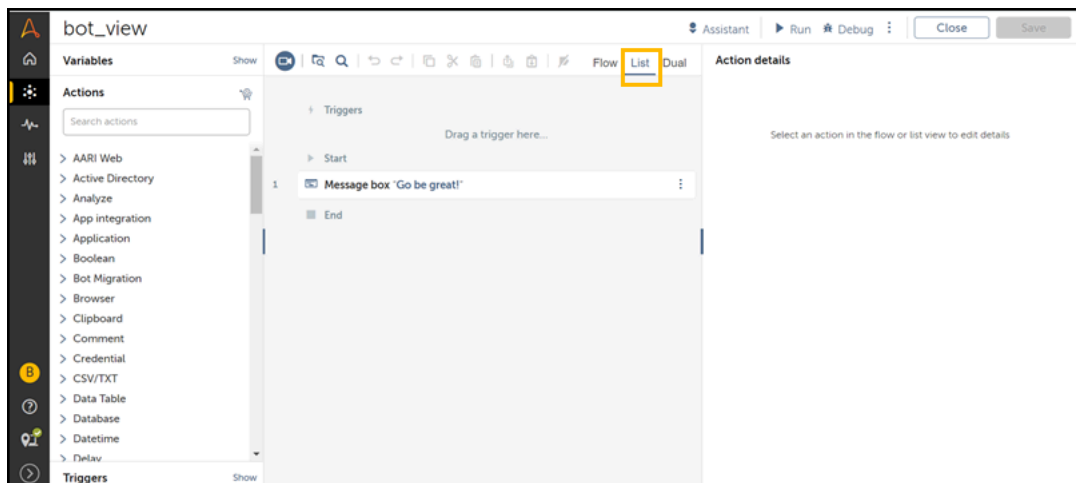

- **Dual:** Displays the actions used in an automation from both **Flow** and **List** view aspects

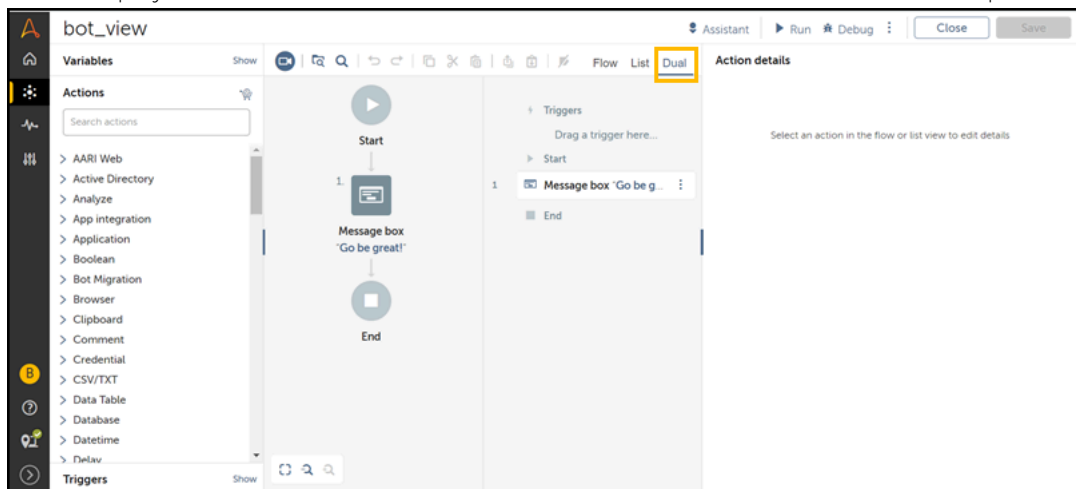

7. Run your bot from your device.  
See [Run your first bot](#) on page 1493.

## Run your first bot

Run a bot from the same device that you used to create the bot.

Log in to your instance of the Automation Anywhere Control Room, and complete these steps:.

1. [Install Bot Agent and register device](#) on page 1347
2. [Set user device credentials](#) on page 1353
3. [Create your first bot](#) on page 1489

These steps describe the guided workflow for first-time users. The guided workflow is only displayed the very first time you complete these steps.

You can run a bot from the following devices:

- The same device you are using to log in to the Control Room.
- Another device you registered that has the same login credentials as the machine you are using to log in to your Community Control Room or a device with defined credentials in the Control Room.

---

**Note:** Windows NT LAN Manager (NTLM) is a challenge or response authentication method that enables clients to provide their user name and password as encrypted credentials or plain text. Use Google Chrome browser to enable the Automation Anywhere extension and capture the proxy information. After the proxy information is captured, you can use any browser to run a bot in Automation 360.

---

1. Locate and select your bot.  
From your Control Room dashboard left panel, select **Automation**. A list of available bots and forms is displayed.
2. Select the bot to run.  
From the **Files and folders** table, mouse over the ellipsis (three stacked dots) to the right of your bot's name.  
The **Edit** Task Bot panel appears.
3. Click the **Run Task bot** icon.  
The **Run bot now** window opens. In the **Task Bots** table, your bot is selected to run.
4. Click **Next**.  
The **Device** tab opens with a table of one or more registered devices.
5. If your device is not already selected, select your device to run the bot, and click the right arrow.
6. Click **Run bot now**.  
Control Room uses the credentials in your profile to log in to the device you selected and runs the bot.  
The **In progress activity** window opens with the status of the running bot. When the bot is done, it disappears from this window.

7. Click **Historical** to see if your bot ran successfully.

Watch the following video on how to run your first bot in the Community Edition:

Build bots using variables, actions, and the Universal Recorder. See [Get started building bots](#) on page 3197.

## Moving from Automation 360 On-Premises to Cloud

If you are on Automation 360 On-Premises, move your data and bots to Cloud to get the benefits of a cloud-native architecture.

### Requirements

- Obtain a Cloud license for every On-Premises Control Room instance that you want to migrate to Cloud. Work with the Automation Anywhere sales, Customer Success Manager (CSM), and partner teams to obtain the required licenses.

---

**Note:** You can move data from multiple On-Premises Control Room instance to one or more Cloud Control Room instances. There is no restriction that you can only move data from a single On-Premises Control Room instance to a single Cloud Control Room. You can migrate data as per your requirements.

---

- Ensure that you have the correct number of licenses in your Cloud Control Room for executing automations from your Cloud.
- Ensure that you back up your data before migration.

See: [Integrating Control Room with Git repositories](#) on page 1824.

### Choose your method

Use one of the following procedures to migrate from your On-Premises Control Room instance to your Cloud Control Room instance:

- [Moving data using Control Room operations](#) on page 1495
- [Migrate using Control Room APIs](#) on page 1495

### Post-requisite tasks

After the migration is complete, perform the following steps:

1. Open firewall rules to allow connectivity between the Cloud Control Room and the On-Premises Bot Runners.

See: [Bot Agent communication with Control Room](#) on page 1331.

2. Perform sanity testing of the migrated bots in the Cloud Control Room. Ensure that the bots are working as they were in your On-Premises Control Room.

3. Deregister the Bot Runners from the On-Premises Control Room and register them to the Cloud Control Room.
4. Decommission the On-Premises Control Room after the migration is complete and when the workload can be managed from your Cloud Control Room.
5. Repeat all these tasks for all your On-Premises Control Room instances.

---

**Note:** You can use these instructions to not only migrate from your On-Premises Control Room instances to your Cloud Control Room instances but also to move data between your Cloud Control Room instances.

---

## Moving data using Control Room operations

You can manually move bots and queues from your On-Premises Control Room to Cloud using the Bot Lifecycle Management and Workload Management import and export features.

For the rest of the data (such as users, roles, lockers, and so on) in your On-Premises Control Room, you must manually move the data to Cloud, if required.

1. Use Bot Lifecycle Management to export bots from On-Premises Control Room to a local system and then import them manually into your Cloud Control Room.  
See: [Bot Lifecycle Management](#).
2. Export [Workload Management](#) queues from the On-Premises Control Room to a local system.  
See: [Export queues](#) on page 2022.
3. Import [Workload Management](#) queues manually into your Cloud Control Room.  
See: [Import queues](#) on page 2023.
4. Move the rest of the Control Room data manually using the Cloud Control Room operations. For example, to manually move roles from your On-Premises Control Room to Cloud, export the roles from your On-Premises Control Room and manually create the roles in your Cloud Control Room.
5. After the moving the data is complete, ensure that you perform the [Post-requisite tasks](#) on page 1494.

## Migrate using Control Room APIs

You can manually migrate your On-Premises Control Room data using the Control Room APIs.

1. Set up an API orchestrator (such as Postman) that can use the `*_read_*` API from an endpoint and use the information in the response to form a new request in the format required by the `*_write_*` API at another endpoint and call the API method.
2. Use the Control Room APIs to migrate data from your On-Premises Control Room to your Cloud Control Room.

---

**Note:** You can use the Control Room APIs to migrate or move data from an On-Premises or Cloud Control Room instance to another Cloud Control Room instance.

---

See: [Control Room APIs](#) on page 3961.

## Migrate to Automation 360

Migration (upgrade) is the process of moving your data and bots from Enterprise 11 or Enterprise 10 to Automation 360. Migration includes but is not limited to replicating and updating your existing database and repository, converting your bots to the Automation 360 format, and migrating learning instances for IQ Bot and dashboards for Bot Insight.

Automation 360 is a single, integrated cloud-native Digital Workforce platform that is designed for flexibility and agility. Migrating to this platform provides you benefits such as faster time to value, business agility, and lower TCO.

For more information, see [Automation 360](#) on page 1013.

### What is migration

The migration (or upgrade) process copies all your Enterprise 11 or Enterprise 10 entities such as users, roles, lockers, and bots to Automation 360. This eliminates the efforts required to re-create all these entities in Automation 360. The migration process also eliminates the possibility of missing out on copying an entity that might be required to run a bot after migration. All the Enterprise 11 or Enterprise 10 entities are ready for use in Automation 360 after they are successfully migrated, except bots and MetaBots.

When Enterprise 11 or Enterprise 10 data is migrated, bots are copied as `.atmx` files and MetaBots are copied as `.mbot` files. You must convert these bots and MetaBots to the Automation 360 format before you use them.

Migration also includes migrating your IQ Bot learning instances and Bot Insight dashboards.

#### IQ Bot migration

When migrating Enterprise 11 or Enterprise 10 bots, migrate your IQ Bot learning instances. Before starting the IQ Bot migration, ensure that your Automation 360 environment is installed and set up for use. IQ Bot migration involves migrating the bots built to use IQ Bot as well as the IQ Bot learning instances that have been trained for data extraction.

Use the IQ Bot server upgrade and learning instance procedures to move the information over to your new system. See [Migrate to Automation 360 IQ Bot](#) on page 1718.

#### Bot Insight migration

Migration of the Bot Insight data and dashboard is performed as part of the overall migration process. It involves cloning your Bot Insight database (which is separate from your Enterprise 11 Control Room database) and using the pre-migration utility to extract your dashboard metadata (widgets, layouts, and so on).



## Migration phases

Migration involves three main steps, as shown in the following image:



### 1. [Check migration readiness](#) on page 1505

Analyze your bots using the Bot Scanner and review the generated report to verify your migration readiness.

### 2. [Prepare new Control Room for migration](#) on page 1546

Choose your deployment model (Cloud, On-Premises, or Cloud-enabled) and request for the migration licenses. Prepare your Control Room and environment for the migration.

### 3. [Migrate and validate bots](#) on page 1586

Convert your Enterprise 11 or Enterprise 10 bots to Automation 360 format. After migration, verify the converted bots run successfully, and update bots as required based on the migration reports or testing phase.

---

**Note:** If you encounter any error when you migrate from Enterprise 11 or Enterprise 10, you might have to review or take some actions on the migrated bots. See [Migration messages](#) on page 1678.

---

## Tools used for migration

The following tools are available for migration:

### Bot Scanner

The Bot Scanner scans your existing bots (Task Bots and MetaBots) and generates reports. These reports provide information about the commands and variables used in these bots and how many of these commands and variables are supported for migration in Automation 360. (The scanner was previously called the pre-migration utility.)

[Bot Scanner for migration](#) on page 1529

### Bot Migration Wizard

Integrated in the Automation 360 Control Room, this tool guides you through the process of converting the bots to the Automation 360 compatible format after you have completed the prerequisites steps. The wizard enables you to migrate multiple bots (Task Bots and MetaBots) and their dependent bots.

The migration wizard migrates a bot only if all of the components used in that bot are supported for migration in Automation 360.

[Migrate Enterprise bots](#) on page 1590

#### Cloud Migration Utility

This tool enables you to upload all your Enterprise 11 data to Automation Anywhere Cloud. After the data is successfully uploaded to Cloud, the Cloud Control Room is created and all the uploaded data is available for use in that Control Room. The utility migrates data from Control Room repository (bots, their dependencies, and Credential Vault) and Control Room database (users, roles, schedules, queues, and Control Room settings).

[Upload Enterprise 11 data using Cloud Migration Utility](#) on page 1556

#### Audit log data migration utility

This utility enables you to export the audit log data from the Enterprise 11 Control Room to a JSON file. You must paste the JSON file in the Automation 360 repository and then migrate the audit log data.

#### Bot Insight pre-migration utility

This utility enables you to export Enterprise 11 Bot Insight dashboard metadata (widgets and layouts) and dashboard profiles as a zip file. You must paste the zip file in the Automation 360 repository to migrate the Bot Insight dashboards.

[Export Enterprise 11 Bot Insight dashboards for migration](#) on page 1568

## What is migrated and not migrated

Enterprise 10 : Review the information about what is migrated and what is not migrated for the On-Premises deployment model.

Enterprise 10	Migrated to On-Premises
Bots and their dependencies	Yes
Credential Vault	Yes
Roles	Yes
Users	Yes
Schedules (these are disabled after they are migrated to Automation 360)	Yes
Audit logs	No
Bots version control history	No

Enterprise 10	Migrated to On-Premises
Devices and device pools	No
File system logs	No
IQ Bot (IQ Bot migration requires a separate process)	No

Enterprise 11 : Review the information about what is migrated and what is not migrated for the different deployment models.



Enterprise 11	Cloud	On-Premises
Users, roles, and credential variables and lockers	Yes	Yes
Bots and their dependencies	Yes	Yes
Schedules (these are disabled after they are migrated to Automation 360)	Yes	Yes
Workload queues	Yes	Yes
Bot Insight dashboards <ul style="list-style-type: none"> <li>• Published dashboard</li> <li>• Default and customized dashboard</li> </ul>	Yes	Yes
Bots transactional data <ul style="list-style-type: none"> <li>• Private workspace transactional data (bots which run with Bot Creator license)</li> <li>• Public workspace transactional data (bots which run with Bot Runner license)</li> </ul>	Yes	Yes
Bot execution operational data	Yes	Yes
Licenses	Yes (Requires unique license GUID)	Yes
IQ Bot learning instances (IQ Bot migration requires a separate process)	No	Yes
Audit logs	No	Yes
Device pools	No	Yes
Historical data	Yes	Yes

---

Enterprise 11	Cloud	On-Premises
Control Room settings	No	Yes
Bots version control history	No	No
Devices	No	No
File system logs	No	No
Workflows	No	No
Bot Insight dashboards for imported bots	Yes	No
AASettings.xml file data	No	No

### Choose your migration path

After you have verified the migration readiness for your current version, choose your migration path based on the Automation 360 deployment model that meets your business requirements.

If you are on this version	Start your migration
Enterprise 11	<ul style="list-style-type: none"> <li> <a href="#">Enterprise 11 to Automation 360 Cloud (using the Cloud Migration Utility)</a> <p>Workflow map: Click the following schematic image to view this migration workflow in an interactive visual</p>  <p>format:</p> <ol style="list-style-type: none"> <li><a href="#">Migrating from Enterprise 11 to Automation 360 Cloud</a></li> </ol> </li> <li> <a href="#">Enterprise 11 to Automation 360 On-Premises</a> <p>Workflow map: Click the following schematic image to view this migration workflow in an interactive visual</p>  <p>format:</p> <ol style="list-style-type: none"> <li><a href="#">Migrating from Enterprise 11 to Automation 360 On-Premises</a></li> </ol> </li> <li> <a href="#">Manually migrate to Automation 360 Cloud</a> </li> <li> <a href="#">Manually migrate to Automation 360 On-Premises</a> </li> <li> <a href="#">Enterprise 11 to Cloud-enabled</a> </li> <li> <a href="#">Enterprise 11 to Automation 360 on Linux CentOS</a> </li> </ul>

If you are on this version	Start your migration
Enterprise 10	<p data-bbox="881 243 1333 306"><a href="#">Enterprise 10 to Automation 360 On-Premises</a></p> <p data-bbox="881 323 1354 420">Workflow map: Click the following schematic image to view this migration workflow in an interactive visual</p>  <p data-bbox="881 682 971 711">format:</p> <ol data-bbox="881 730 1308 793" style="list-style-type: none"> <li>1. <a href="#">Migrating from Enterprise 10 to Automation 360 On-Premises</a></li> </ol> <p data-bbox="881 856 1419 982"><b>Note:</b> We do not support migration from to . However, you can manually migrate to by using the bot export utility. For assistance, contact support: .</p>

If you have a large number of bots, you can run both Automation 360 and Enterprise 11 or 10 in parallel. This dual-environment method helps to eliminate downtime. Choose one of the following procedures based on your deployment model:

If you want to use these dual environments	Use this procedure
Enterprise 11 and Automation 360 Cloud	<a href="#">Enterprise 11 and Automation 360 Cloud in parallel</a>
Enterprise 11 and Automation 360 On-Premises	<a href="#">Enterprise 11 and Automation 360 On-Premises in parallel</a>
Enterprise 10 and Automation 360 On-Premises	<a href="#">Enterprise 10 and Automation 360 On-Premises in parallel</a>

### Other resources

The following resources can help you in your journey with Automation 360:

- [Migration resource center](#): Access multiple migration resources, including videos, project templates, and high-level information from one place.
- [Automation Anywhere University: RPA Training and Certification \(A-People login required\)](#): Access the Migrating to Automation 360 learning trail.

Learn how to use Automation 360 with Automation Anywhere University for hands-on learning that is designed for beginners to advanced developers. Instructor-led training options are also available.

- [XML path is not working which works fine in Enterprise 11](#)

Related tasks

[Update Automation 360 to latest version](#) on page 1423

Update Automation 360 On-Premises to the latest version to get new features and enhancements that help improve and scale your automation programs.

## Migration best practices

Review best practices and guidelines on the migration process (migrating your bots, Bot Insight, and IQ Bot) and on the Bot Scanner, Control Room, and Credential Vault to complete your migration successfully.

### Bot Scanner

When using the Bot Scanner to check your migration readiness, consider these best practices:

- Create a copy of your Enterprise 11 or Enterprise 10 Control Room repository.  
Create a copy of your Control Room repository on the device on which you want to run Bot Scanner.
- Use the latest version of Bot Scanner.

New versions of Bot Scanner are available with each Automation 360 release. The latest version is updated with support for more Enterprise 11 or Enterprise 10 commands and features, which helps you to decide when to migrate.

- Always run the Bot Scanner on the copy of the Enterprise 11 or Enterprise 10 repository.
- Do not mix bots from multiple Control Room instances. For example, if you have two Control Room instances, do not copy bots from both Control Room instances at the same location and use that location in the Bot Scanner to scan these bots.
- Review the Bot Scanner report thoroughly.

The report helps you to determine which bots are ready for migration and when support for unsupported commands and features will be available. Understanding timelines for unsupported commands and features helps you decide when to migrate.

### Control Room and Credential Vault

- Create and save a backup of Enterprise 11 or Enterprise 10 Control Room repository and database before you install Automation 360.

Use this backup to perform migration so that there is no disruption to your existing Enterprise 11 or Enterprise 10 automation.

- Do not change the name of the database when you restore the backup of the Enterprise 11 or Enterprise 10 database.
- For migration, do not use a machine on which Automation 360 is already installed.
- Configure Credential Vault in express mode.

## Bot building

When building new bots in Enterprise 11 or Enterprise 10, keep the following considerations in mind so that migration to Automation 360 is easier.

---

**Note:** These considerations will mainly help users who have a dual environment (running Enterprise 11 or Enterprise 10 and Automation 360 in parallel).

---

- Do not use Microsoft Internet Explorer to build your automations as Microsoft is planning to discontinue support for Internet Explorer from June 2022 on certain operating systems.
- Use object-based automation wherever possible: For example, use Object Cloning command instead of Web Recorder command.
- Use AI Sense Recorder very minimally as migration of this recorder is not yet supported in Automation 360.
- Do not use Citrix Automation, Internet Connection commands, Apache Flex, Adobe Flash, or the Microsoft Edge (legacy) browser in Object Cloning as these are not supported in Automation 360.

## Bot migration

- Assign the required migration role and permissions to users who will start the migration process and the Bot Runners that will be used for bot migration.
- Assign the required device permissions for the devices that will be used for bot migration.
- Install the Bot Agent on the devices that will be used for bot migration.
- Test the Automation 360 setup before using the Bot Migration Wizard to migrate your bots.

Create and run a sample bot before using the Bot Migration Wizard. This helps to ensure that Automation 360 system prerequisites such as device registration, credential updates, and Auto Login are met.

- Start migration with a business process for which all the bots are completely ready for migration.
- Check for any required manual updates for migrated .

Review the messages for the migrated bots to check if any updates are required for the migrated bots to run these bots successfully. The list of bots that require updates after migration is available in the **Action required** tab of the Bot Scanner report.

## Post-migration

- Validate the migrated bots.

Plan a dedicated time to validate and ensure that the bots are migrated successfully. Do not delete the Enterprise 11 or Enterprise 10 format bots until you complete validating that these bots run successfully after migration.

- Create all new bots in Automation 360 after migration is completed.
- If you have updated any bots in Enterprise 11 or Enterprise 10 after migration, you must migrate these bots again.



## Bot Insight migration

- Back up and restore the Enterprise 11 Bot Insight database before you install Automation 360.
- Use the same credentials you have used for Enterprise 11 database when you restore the database.

## IQ Bot migration

- Download the database migration assistant that is compatible with your Automation 360 version.
- Create backups of Enterprise 11 databases.
- Stop processing, training, and validating documents in Enterprise 11.
- Prepare a new environment for IQ Bot and the database migration assistant installation.
- Restore backed-up Enterprise 11 databases in different locations.
- Review the database migration assistant log file.
- Clean up the application registration information in the IQ Bot database if the Automation 360 Control Room address is new.
- Migrate learning instances one at a time. Do not place all learning instances in one `iqba` file.

## Tools for migration

We have moved the information that was on this page to other pages. See the following links for more information.

- For an overview of migration, including information that was previously on this page, see [Migrate to Automation 360](#) on page 1496.
- For information about Bot Scanner, see [Bot Scanner for migration](#) on page 1529.
- For information about Bot Migration Wizard, see [Bot Migration Wizard](#) on page 1587.

## Check migration readiness

Perform the tasks in this workflow to verify whether you are ready to migrate to Automation 360 from Enterprise 11 and Enterprise 10.

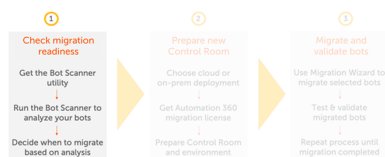

1. Verify the current version of your Enterprise 11 or Enterprise 10 platform.  
[Verifying your Enterprise 11 or Enterprise 10 version for migration](#) on page 1511
2. Check whether your current Enterprise 11 or Enterprise 10 version is supported for migration.  
[Supported Control Room versions for migration](#) on page 1506
3. Compare Automation 360 and Enterprise 11 or Enterprise 10 features.  
[Automation 360 feature comparison matrix](#) on page 990

4. Review information about packages mapping and variables mapping to understand how Enterprise 11 or Enterprise 10 commands and variables differ from the equivalent Automation 360 packages and variables.  
[Package mapping for migration](#) on page 1620 | [Variable mapping for migration](#) on page 1655
5. Use the Bot Scanner to analyze your bots and identify commands and variables used in the bots that are supported for migration in Automation 360.  
[Scan Enterprise 11 or 10 bots using Bot Scanner](#) on page 1531
6. Analyze the report generated by the Bot Scanner.  
[Analyze Bot Scanner report for migration](#) on page 1534

[Prepare new Control Room for migration](#) on page 1546

## Supported Control Room versions for migration

Review the Enterprise 11 and Enterprise 10 versions that are certified and supported for migration to Automation 360 On-Premises and public or private Cloud on Microsoft Windows Server. A certified Enterprise 11 or Enterprise 10 version means that major functionality of that platform version and bots developed on the version are supported in Automation 360.

---

**Note:** We do not support migration from . However, you can manually migrate to by using the bot export utility. For assistance, contact [support](#):

---

Support for more Enterprise 11 and Enterprise 10 versions will be added over a period of time.

---

**Remember:** The Enterprise 11 and Enterprise 10 versions that are not listed in the following tables are not certified for migration. If you are using a version that is not certified for migration and you want to migrate to Automation 360, you must first upgrade to a version that is certified and then proceed with migration.

---

If you are migrating from OEM products such as IBM RPA, contact Automation Anywhere Support: [Open a support case \(A-People login required\)](#)

## On-Premises migration: Supported Enterprise 11 and 10 versions

If you are using any of the following Enterprise 11 and Enterprise 10 versions, you can perform the migration. The table also lists the base version of Automation 360 from which the specific Enterprise 11 or Enterprise 10 version is supported.

[Supported Enterprise 11 versions](#) | [Supported Enterprise 10 versions](#)

Enterprise 11 versions for On-Premises migration

Enterprise 11 releases	Supported Control Room version	Supported Automation 360 b
11.3.5	<ul style="list-style-type: none"> <li>• 11.3.5.5</li> <li>• 11.3.5.4</li> <li>• 11.3.5.3</li> <li>• 11.3.5.2</li> <li>• 11.3.5.1</li> <li>• 11.3.5</li> </ul>	<ul style="list-style-type: none"> <li>• v.23 and later</li> <li>• v.24 and later</li> <li>• v.24 and later</li> <li>• v.23 and later</li> <li>• v.16 and later</li> <li>• v.18 and later</li> </ul>
11.3.4	<ul style="list-style-type: none"> <li>• 11.3.4.7</li> <li>• 11.3.4.6</li> <li>• 11.3.4.5</li> <li>• 11.3.4.4</li> <li>• 11.3.4.3</li> <li>• 11.3.4.2</li> <li>• 11.3.4.1</li> <li>• 11.3.4</li> </ul>	<ul style="list-style-type: none"> <li>• v.25 and later</li> <li>• v.23 and later</li> <li>• v.24 and later</li> <li>• v.23 and later</li> <li>• v.16 and later</li> <li>• v.20 and later</li> <li>• v.19 and later</li> <li>• v.17 and later</li> </ul>
11.3.3	<ul style="list-style-type: none"> <li>• 11.3.3.5</li> <li>• 11.3.3.3</li> <li>• 11.3.3.2</li> <li>• 11.3.3.1</li> <li>• 11.3.3</li> </ul>	<ul style="list-style-type: none"> <li>• v.23 and later</li> <li>• v.16 and later</li> <li>• v.22 and later</li> <li>• v.21 and later</li> <li>• v.17 and later</li> </ul>
11.3.2	<ul style="list-style-type: none"> <li>• 11.3.2.5</li> <li>• 11.3.2.4</li> <li>• 11.3.2.2</li> <li>• 11.3.2.1</li> <li>• 11.3.2</li> </ul>	<ul style="list-style-type: none"> <li>• v.23 and later</li> <li>• v.15 and later</li> <li>• v.09 and later</li> <li>• v.09 and later</li> <li>• v.08 and later</li> </ul>
11.3.1	<ul style="list-style-type: none"> <li>• 11.3.1.11 (over 11.3.1)</li> <li>• 11.3.1.11 (over 11.3.1.2)</li> <li>• 11.3.1.10</li> <li>• 11.3.1.9</li> <li>• 11.3.1.8</li> <li>• 11.3.1.7</li> <li>• 11.3.1.5</li> <li>• 11.3.1.4</li> <li>• 11.3.1.2</li> <li>• 11.3.1.1</li> <li>• 11.3.1</li> </ul>	<ul style="list-style-type: none"> <li>• v.23 and later</li> <li>• v.23 and later</li> <li>• v.22 and later</li> <li>• v.17 and later</li> <li>• v.19 and later</li> <li>• v.15 and later</li> <li>• v.17 and later</li> <li>• v.20 and later</li> <li>• v.22 and later</li> <li>• v.21 and later</li> <li>• v.09 and later</li> </ul>
11.3	11.3	v.10 and later

Enterprise 11 releases	Supported Control Room version	Supported Automation 360 base version
11.2.1	<ul style="list-style-type: none"> <li>11.2.1.6</li> <li>11.2.1.5</li> <li>11.2.1.4</li> <li>11.2.1.3</li> <li>11.2.1.2</li> <li>11.2.1.1</li> <li>11.2.1</li> </ul>	<ul style="list-style-type: none"> <li>v.23 and later</li> <li>v.20 and later</li> <li>v.15 and later</li> <li>v.11 and later</li> <li>v.11 and later</li> <li>v.23 and later</li> <li>v.23 and later</li> </ul>
11.2	11.2	v.19 and later
11.1	<ul style="list-style-type: none"> <li>11.1.2</li> <li>11.1.0</li> </ul>	<ul style="list-style-type: none"> <li>v.22 and later</li> <li>v.23 and later</li> </ul>

Enterprise 10 versions for On-Premises migration

Supported Control Room Enterprise 10 version	Supported Automation 360 base version
10.7.5	v.16 and later
10.5.141	v.22 and later
10.5.113	v.18 and later
10.5.112	v.18 and later
10.5.17	v.18 and later
10.5.16	v.12 and later
10.5.15	v.16 and later
10.5.14	v.22 and later
10.5.13	v.20 and later
10.5.12	v.22 and later
10.5.11	v.15 and later
10.5.9	v.17 and later
10.5.0	v.12 and later
10.3.11	v.25 and later
10.3.5	v.25 and later
10.3.0	v.22 and later

**Cloud migration: Supported Enterprise 11 versions**

If you are using any of the following Enterprise 11 versions, you can perform the Cloud migration.

All supported Enterprise 11 Control Room versions listed in this table also support Bot Insight migrations.

Enterprise 11 releases	Supported Control Room versions
11.3.5	<ul style="list-style-type: none"> <li>• 11.3.5.5</li> <li>• 11.3.5.4</li> <li>• 11.3.5.3</li> <li>• 11.3.5.2</li> <li>• 11.3.5.1</li> <li>• 11.3.5</li> </ul>
11.3.5	<p>Certified for IBM installer versions:</p> <ul style="list-style-type: none"> <li>• 11.0.0.10.iFix004 (over Automation Anywhere 11.3.5.4)</li> <li>• 11.0.0.10.iFix003 (over Automation Anywhere 11.3.5.3)</li> <li>• 11.0.0.10.iFix002 (over Automation Anywhere 11.3.5.2)</li> <li>• 11.0.0.10.iFix001 (over Automation Anywhere 11.3.5.1)</li> <li>• 11.0.0.10 (over Automation Anywhere 11.3.5 JDK update)</li> <li>• 11.0.0.9 (over Automation Anywhere 11.3.5)</li> </ul>
11.3.4	<ul style="list-style-type: none"> <li>• 11.3.4.6</li> <li>• 11.3.4.5</li> <li>• 11.3.4.4</li> <li>• 11.3.4.3</li> <li>• 11.3.4.2</li> <li>• 11.3.4.1</li> <li>• 11.3.4</li> </ul>
11.3.3	<ul style="list-style-type: none"> <li>• 11.3.3.5</li> <li>• 11.3.3.3</li> <li>• 11.3.3.2</li> <li>• 11.3.3.1</li> <li>• 11.3.3</li> </ul>
11.3.2	<ul style="list-style-type: none"> <li>• 11.3.2.5</li> <li>• 11.3.2.4</li> <li>• 11.3.2.2</li> <li>• 11.3.2.1</li> <li>• 11.3.2</li> </ul>

Enterprise 11 releases	Supported Control Room versions
11.3.1	<ul style="list-style-type: none"> <li>• 11.3.1.11 (over 11.3.1.2)</li> <li>• 11.3.1.11 (over 11.3.1)</li> <li>• 11.3.1.10 (over 11.3.1)</li> <li>• 11.3.1.9 (over 11.3.1)</li> <li>• 11.3.1.7 (over 11.3.1.2)</li> <li>• 11.3.1.7 (over 11.3.1)</li> <li>• 11.3.1.5 (over 11.3.1)</li> <li>• 11.3.1.4 (over 11.3.1.2)</li> <li>• 11.3.1.4 (over 11.3.1)</li> <li>• 11.3.1.2</li> <li>• 11.3.1.1</li> <li>• 11.3.1</li> </ul>
11.3	11.3
11.2	<ul style="list-style-type: none"> <li>• 11.2.1.6</li> <li>• 11.2.1.5</li> <li>• 11.2.1.4</li> <li>• 11.2.1.3</li> <li>• 11.2.1.2</li> <li>• 11.2.1.1</li> <li>• 11.2.1</li> <li>• 11.2</li> </ul>
11.1	<ul style="list-style-type: none"> <li>• 11.1.2</li> <li>• 11.1.0</li> </ul>

### Cloud migration: Supported database deployment types

Cloud migration is supported for the following database deployment types:

Database deployment type	Contained database	Uncontained database
Microsoft SQL Server on AWS RDS	Yes	Yes
Microsoft SQL Server on Azure PaaS	Yes	Yes
Microsoft SQL Server on Google cloud	Yes	Yes

Supported Microsoft SQL Server database versions

For database deployment types listed in the previous table, you can host any of the following Microsoft SQL Server database versions. Note that all the Database editions (Enterprise, Express, Standard, Developer (for 2019), and GCP Cloud SQL) are supported for migration.

Database	Build	File version	Supported operating system
Microsoft SQL Server 2014	12.0.2000.8	2014.120.2000.8	Windows Server 2012 R2 Standard and later
	12.0.6024.0	2014.120.6024.0	
Microsoft SQL Server 2016	13.0.5026.0	2015.131.5026.0	Windows Server 2012 R2 Standard and later
Microsoft SQL Server 2017	14.0.1000.169	2017.140.1000.169	Windows Server 2012 R2 Standard and later
Microsoft SQL Server 2019	15.0.2000.5	2019.150.2000.5	Windows Server 2016 and later

### Verifying your Enterprise 11 or Enterprise 10 version for migration

Migration to Automation 360 is supported for many certified versions of Enterprise 10 and Enterprise 11. Before you start the migration process, verify your current platform version and then check if that version is currently supported for migration.

#### Verify your current platform version

You can find your current platform version in both the Control Room and Enterprise Client. Verify your platform version from your Control Room:

1. Log in to your Enterprise 11 Control Room.
2. Click the Help icon on the top-right of the Control Room to verify the version number, which is listed at the bottom of the menu.

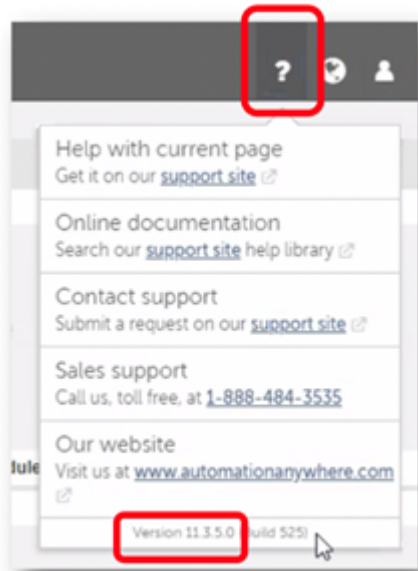

## Verifying versions supported for migration

After you have verified which Enterprise 11 or Enterprise 10 version your organization has deployed, check which versions are supported for migration.

1. Go to the following page: [Supported Control Room versions for migration](#) on page 1506.
2. Verify if your version is supported for migration.

The supported versions for both Cloud and On-Premises migration are listed on this page.

## Platform version not on supported list

Although we recommend that you begin migration after confirming if your version is supported for migration, you can still run the Bot Scanner to determine which of your bots and their corresponding commands are ready for migration. This will help you plan your migration by learning when currently unsupported bots and commands will be supported in an upcoming release.

## Unsupported features for migration

Review the features that are not supported for migration from Enterprise 11 or Enterprise 10 to Automation 360.

## Features not yet supported

The following features are not yet supported for migration:

- Migration of audit logs from Enterprise 11 is not supported on Cloud deployments.



- In Enterprise 11, if bots were using the **Before-After** string operation with the **OR** logical operator and operation output resulted in an empty string, then the output displayed as an empty string.

However in Automation 360, if the output of such an operation results in an empty string, the value used in the **End before text** string operation is ignored and the result displays in the output.

For example, in the text `email:user@outlook.com`, if the value in the **Before** operation is `email:` and the value in **After** operation is `user`, the results differ based on product version:

- Enterprise 11 displays an empty string as the output.
  - Automation 360 displays `user@outlook.com` as the output.
- In Enterprise 11, if users select internal variables for the window titles; but not used in the bot, after migration, these internal variables are also migrated to Automation 360.
  - In migrated bots, if you are using OLE DB Driver version 18 or later and when you export SQL Server Database with bit columns to a CSV file, the bit value of `-1` is returned instead of `1` for string value `TRUE`.

Fixed in: v.27

- When you migrate bots using **SAP > Select item by index** command, incorrect index is displayed in the migrated bot.

Fixed in: v.26

- Bots that include the Terminal Emulator package are migrated only to **Advanced Technology** and not to **Legacy Technology**.
- When you migrate a bot that was using the Manage Window Controls action, the last digit of the height value is not available after migration. However, the bot will execute successfully.

Fixed in: v.26

- When an Excel session is active in SAP, a corresponding Excel process starts in the background. In such a scenario, Automation 360 uses the same Excel process that SAP started. When you run a bot to automate spreadsheet data, Automation 360 processes the first request successfully. However, during execution, if the Excel is closed and a subsequent request is sent for automating the spreadsheet data, Automation 360 does not process the request because the Excel process is still being accessed by SAP. Therefore, the correct window is not activated for automating the spreadsheet data.

Fixed in: v.26

- If a bot is using the **Structured text** type field in the **PDF > Extract text** action, some of the characters might not be extracted correctly.

Fixed in: v.25

- After migration, the **Before**, **Before and/or after**, and **After** options in the **String > Extract text** action does not match the case in a string.

Fixed in: v.25

- After migration, bots that were using the **Get text > All lines** action in Enterprise 11 will display only 24 rows of lines in the Terminal Emulator.

Fixed in: v.26

- Migrating bots with **Get Total Rows** command in SAP GUI returns values as **Float** string type instead of an **Integer** type after migration.

Fixed in: v.26

- If you are a Bot Creator or a Bot Runner user, you might not be able to view the Review messages displayed in the **Bot Assistant** without having the **View migration** permission.

Fixed in: v.26

- When you use counter as a variable in a nested loop, the parent loop functions properly but the child loop does not run as expected.

Fixed in: v.27

- Bots with SAP packages cannot pick and convert window titles that include "\*" (asterisk) character. These window titles are not converted to currently active window names after migration.

Fixed in: v.26

- Bot deployment might fail when you run migrated bots with the **SAP > Get Property** command. This issue occurs because of the following reason: In Enterprise 11, property name is case in-sensitive. During migration, property name is changed to being case sensitive, so bot deployment fails when the case of property name does not match.

Fixed in: v.26

- When you send an email through **Exchange Web Services** (EWS), the format of the email output do not have line breaks , the content appears tampered, and the entire content of the email appears in a single line.

Fixed in: v.26

- The Enterprise 11 or Enterprise 10 Bot Runner and Bot Creator devices are not included in the migration process and are therefore not migrated to Automation 360.

The Automation 360 Bot Agent replaces the Enterprise 11 and Enterprise 10 Enterprise Client. Use the Bot Agent to connect a device to the Automation 360 Control Room and run bots on the connected devices.

- When you run a migrated bot with the option **Validate if attachment is missing** option checked, and if the attachment is missing when you send the email, the bot might not run successfully.
- Workflows, triggers, version control history of bots, and file system logs.
- Migration of Enterprise 11 bots that uses Subversion Version Control for version control.
- Migration of Enterprise 11 On-Premises Control Room to Automation 360 Cloud service on GCP using the Cloud Migration Utility is not supported.
- Control Room that uses Oracle Database.
- Migration of Bot Insight data and other entities such as users, roles, schedules and credential variables when Automation 360 is installed using a fresh database.
- Cut, copy, paste, and Ctrl+A functions on the terminal screen when using Terminal Emulator.

Fixed in: v.27

- Use of a variable within a variable (except value type variables) in a bot.

For example, if a bot contains \$variable1\$, where \$variable1\$ contains \$variable2\$, and \$variable2\$ contains the actual value, this bot cannot be migrated.

- Use of a fixed value and a variable to specify the index position, for example, \$v\_ArrVar(1\$RowIndex\$,1)\$.
- The capability to capture images from the runtime window when a bot is being executed.
- Enterprise 11 or Enterprise 10 bots that use a string value in a variable that is used in the If command along with '<' or '=' operator are migrated to Automation 360. However, these bots encounter an error when they run in Automation 360.
- The If command or the Loop command that use '<', '>', '<=', or '>=' operator with variables that contain a string value encounters an error after migration.

For example, if you have a bot that contains a variable with the value abcd and uses the > operator, the bot encounters an error when it is run after the migration because string type variables are not suppose to use the <, >, <=, or >= operator.

- Object Cloning command that automates the following applications:
  - Flash applications
  - Web application running on Edge-Legacy browser
- Enterprise 11 or Enterprise 10 bots were able to run a Microsoft Excel macro from the Microsoft Excel file available in the XLSTART folder when the that macro is called from another Excel file that does not contain that macro. After migration, these bots are not able to run the macros which are available in another Excel
- The arrow symbol is not displayed in the Automation 360 Bot editor.

When the arrow symbol is used in Enterprise 11 or Enterprise 10 bots, the Bot editor does not display any symbol after migration, with one exception. The exception is that when the symbol is used in multiple IF/ELSE commands, the Bot editor displays the \$String:FormFeed\$ variable instead of the arrow symbol.

## Unsupported features with workaround

You can migrate bots with the following features if you update them based on the specified workaround:

- The output of the String Length action is different in Automation 360 when compared to Enterprise 11 because Automation 360 considers the line feed character whereas Enterprise 11 considers both carriage return and line feed characters when calculating the string length.

Workaround: Calculate the number of line feed characters used in the string and add it to the string length.

- If you have created triggers, indexes, views and such custom Database objects in addition to the existing standard objects created in the Enterprise 11 Control Room, you might not be able to restore the exported data to Cloud using the Cloud Migration Utility. If you need help to identify such objects, contact Automation Anywhere support: [Open a support case \(A-People login required\)](#).

Workaround: Disable the additionally created Database objects before exporting data to the Cloud.

- In Enterprise 11, if bots were using a window title value or variable that contained leading spaces, after migration, the bots will be unable to select the corresponding window.

Workaround: Remove the leading spaces from the window title value or variable and then run the bots.

- When you use the Recorder to capture an object, select **HTML Tag**, **HTML InnerText**, and **HTML type** properties in **Search** Criteria, or migrate a bot with similar properties selected in **Search** Criteria, the bot fails to identify or locate the object and perform the selected action.

Workaround: Modify the **DomXPath** according to the controls you capture or add more properties in **Search** Criteria.

- When your bot has some error, you add the **Try/Finally** block around those actions and insert one more action in the **Finally** block. When you save and run the bot, you will see the Bot error dialog shows the wrong error line number within the **Finally** block.

Workaround: If you are using **Try** and **Finally** without using **Catch** action, the Bot error dialog will not show the correct line number. Instead, use **Try/Catch**, the **Try** action handles the error

and sends execution to **Catch** with line number and description. This would give the correct line number within the **Finally** block.

- Note: Issue applies only to v.22 and earlier (as this is fixed in v.23, see [Migration of non-credential vault variables](#)). The **Run Logic** command that uses credential variables as input for a logic of a MetaBot

Workaround: Bots that use the **Run Logic** command that passes Credential Vault attributes from a Task Bot to a MetaBot logic can be migrated to Automation 360. The credential name and attribute name are displayed in the fields in the corresponding line of the migrated bot.

If you have migrated using the restored Enterprise 11 database, an equivalent locker is created in Automation 360 for the credential variables used in the Enterprise 11 bot.

Choose one of the following options to run the migrated bots successfully:

- Option 1: Pass the credential type variables.
  1. Create a credential type variable in the child bots as input variables.
  2. In the **Run** action of the Task Bot package of the parent bot, update the input value fields to use the Credential Vault attributes for the credential type variable created for the child bot (corresponding to MetaBot logic).
- Option 2: Pass the credential values as a global value.
  1. Create the Global value in Automation 360 for the credentials use in the **Run Logic** command in Enterprise 11.
  2. In the **Run** action of the Task Bot package of the parent bot, update the Input value fields to use the Global values for the credential type variable created for the child bot (corresponding to MetaBot logic).

If you have not used the restored Enterprise 11 database when installing Automation 360, you must first create the required locker for the credential variables used in the Enterprise 11 bot, before performing the preceding steps.

---

**Note:** Automation 360 provides enhanced security by allowing you to assign Credential Vault attributes only to the credential type variables. This restricts any nonsecure handling of Credential Vault attributes where they might have been assigned to non-credential type variables.

---

- When you create DLLs with different functions, if you use the same filename for DLLs and add them to multiple MetaBots, after migration, if a Task Bot is using the Logic of these MetaBots, an error occurs during execution.

The error occurs because the DLL sessions are based on the DLL filenames, and only the session of the first DLL will be active during execution. Any function called from subsequent DLLs will not be present in the first DLL session that is active.

For example, consider that MetaBot1 is using a DLL that has function1 and MetaBot2 is using a DLL that has function2, and both the DLLs have the same filename `test.dll`. After migration, when you run a Task Bot that uses MetaBot1 Logic and MetaBot2 Logic, the DLL session of MetaBot1 Logic is activated and function1 runs successfully. However, when the MetaBot2 Logic is run, the corresponding DLL is not activated because the session with the same DLL filename is already active, and function2 is not present in the DLL of MetaBot1 Logic, which results in an error.

Workaround: Depending on your requirements, you can perform one of the following workarounds:

- Before migrating the bots, ensure that you rename the DLL filename of one of the DLLs, update the references to the DLL function in MetaBots Logic, and then migrate the bots.
- After migrating the bots, change the session name in the **Create DLL session** box of the Open DLL action and then update the same DLL session name in the related **If** action for the **DLL Session does not exists** condition and the **Run DLL** action.
- In Enterprise 11, if a MetaBot was using `Microsoft.Exchange.WebServices.dll` to use Microsoft Exchange services, after migration, when you use the **Get DLL details** option in the **DLL Run function**, an error is encountered. The error is because, in Automation 360, the `Microsoft.Exchange.WebServices.dll` is not automatically installed in the global assembly cache (GAC) on your device.

Workaround: You must manually install the `Microsoft.Exchange.WebServices.dll` in GAC on your device and then use the **Get DLL details** option.

See [How to: Install an assembly into the global assembly cache](#) .

- In Enterprise 11, if a bot was using the Log To File action and you entered text greater than 1000 characters in the **Enter text to log** field, then after migration, the bot will encounter an error.

Workaround: Ensure that the you configure the text as a variable, and then use this variable in the **Enter text to log** field instead of entering the static text.

- In Enterprise 11, if a bot uses the Text file > **Read Variables** action to read values of variables from a text file and uses the If > **String condition** to execute actions based on the value of the specified source string, when you run the bot after migration, the bot might fail if the key value added to the mapped variable does not match the value in the text file.

Workaround: To pass null values successfully perform the following steps:

1. Use the Text file > **Read Variables** action to add a dictionary variable.
2. Use the Dictionary > **Get** action to find and save a specific key value.

---

**Note:** If the key value does not match with the value in the text file, an empty string is returned to the string variable.

---

Alternatively, use the If > Dictionary > **Check key** condition to validate if the key is present in the text file. You can then assign the value to the string variable.

- PD-50108 In Enterprise 11, if you used the Loop action to open the same Excel sheet multiple times without closing it, after migration, an error occurs. The error occurs because, in Automation 360, only one Excel session can be active at a time.

Workaround: In the Loop action, ensure that you use the **Close** action to close the Excel session before opening the Excel sheet again with the same session name.

- In Enterprise 11, if bots were using the **String** > **Replace** action to find a carriage return line feed (CRLF) character and replace it with another character, after migration, the output might not be the same as the output seen in Enterprise 11.

Workaround: In the **Find string** option, instead of the **Enter** (LF) variable, use the **Newline** (CRLF) variable.

- After migration, bots that were using the Log To File action to log files are using the LF character instead of the CRLF character for new lines.

Workaround: Use the `$$string:Newline$` variable to use the CRLF character in the migrated bots.

- If a MetaBot Logic (for example, Logic A) is referenced to a Task Bot or another MetaBot Logic and if Logic A was renamed or moved from one logic folder to another within the same MetaBot, after migration, the Task Bot or MetaBot Logic does not work when it calls for Logic A.

Workaround: In the Task Bot or MetaBot Logic which calls for Logic A, update the name or path to reference to Logic A.

- If a bot is using the **Browser > Download files** action to download files from a URL, some files whose URLs have special characters or require Windows native authentication access might not download properly.

Workaround: Use the **Browser > Open** action instead.

- Automated migration to Automation 360 Cloud.

Workaround: You can use the manual process to migrate to a Cloud-enabled instance. See [Prepare for Enterprise 11 to Automation 360 Cloud-enabled migration](#) on page 1574.

- When you insert XML > **Insert node** as an attribute using a variable, the bot migration might fail.

Workaround: Insert the attribute by providing the direct value instead of a variable.

- When you run migrated bots that open URL without the protocol information (such as http, https, or file), the web page might not open properly.

Workaround: Ensure that you add the appropriate protocol information to the URL.

- If a MetaBot Logic was using a DLL file that used classes without a namespace, after migration, any Task Bot that uses the MetaBot Logic will not work.

Workaround: Manually update the DLL file to include namespace for classes.

- After migrating bots, an error is seen when using FTP actions on bots that are using comma in the filenames and when using the Delete files and Delete folder FTP actions on bots that are using colon in the filenames.

Workaround: Ensure that you remove comma in the filenames before using the FTP actions and colon in the filenames before using the Delete files and Delete folder FTP actions.

- If a bot was using the Send action to send an email with attachments where the path for the attachments were variables, the bot will either fail to execute or ignore the attachment.

Workaround: Replace variables with the paths for the attachments.

- Enterprise 11 or Enterprise 10 bots encounter an error after migration when these bots use the **Run Logic** command to run a MetaBot logic and the location of the logic is specified up to the folder that contains that logic. For example, consider you want to run Logic1 that is available in `D:Metabots\Logics\Finance` location. If you specify only `D:Metabots\Logics\Finance` instead of the complete path (`D:Metabots\Logics\Finance\Logic1`) of the logic, an error is encountered.

Workaround: Update the path of all the MetaBot logic to the complete path in Enterprise 11 or Enterprise 10 bots before migration.

- Enterprise 11 or Enterprise 10 MetaBots that use the credential variable to pass a numeric value as an input to a DLL function.

Workaround:

1. Update the DLL function to use the input parameter of type string.
2. Delete the commands from the MetaBots that pass the numeric type input parameter to the DLL function.

3. Add the commands in the MetaBots to pass the string type input parameters to the DLL function.
4. Migrate the relevant Task Bots and MetaBots.

- If you are migrating to Automation 360 Cloud and you have configured SAML as the authentication type in Enterprise 11, the migration process changes the authentication type to the Control Room database authentication type for the migrated Automation 360 Control Room.

Workaround: To configure SAML as the authentication type for the Cloud Control Room after migration, perform these steps:

1. Delete the user that was used to configure SAML in Enterprise 11 from Automation 360.
2. Create another user with the required permissions and use that user to configure SAML in Automation 360.

- Applicable to v.24 and earlier: Migration from Enterprise 10 to Automation 360 Cloud.

Workaround: Migrate to an Enterprise 11 version that is supported for migration to Automation 360 Cloud and then migrate to Automation 360 Cloud.

- Enterprise 11 bots that use the Exchange Web Service (EWS) to send email using the Send Email command encounters an error after they are migrated to Automation 360

Workaround: Create the following global values in Automation 360 and update the migrated bots to use EWS in all the actions:

- AAE\_EmailSettings\_auth
- AAE\_EmailSettings\_host
- AAE\_EmailSettings\_port
- AE\_EmailSettings\_ssl

The values for these global values must be as specified in Enterprise 11.

- The Loop command or the If command that use date conditions to compare dates in different formats encounters an error after migration. For example, a date with MM/dd/yyyy format does not work with a date with MM/dd/yyyy hh:mm:ss format.

Workaround: Update dates with the different format to the same format.

- A bot cannot use a variable or an object that contains data larger than 64 KB. For example, if you have captured a table from a website using the Object Cloning command and the captured object contains data larger than 64 KB. Bots containing such objects encounters an error after migration.

Workaround: Remove unwanted data or copy the data in a CSV or a text file and uses the **Read** action of the CSV/TXT package.

- Migration fails for action from which the Credential Vault value is missing in the Control Room.

Workaround: Create the Credential Vault value in the Automation 360 before migration and start the migration again using the Bot Migration Wizard.

## Migrating bots with N/A status

The Bot Scanner reports shows the status of bots that contain unsupported commands and cannot be migrated as N/A. You can migrate such bots by modifying them in your Enterprise 11 or Enterprise 10 machine as specified in the following table:

Message	Migration of bots not yet supported due to child bots using unsupported commands.
Description	A child bot that uses a command that is currently unsupported for migration cannot be migrated. As a result, parent bots that use this child bot also cannot be migrated.
Action	To migrate these parent bots, remove references to the child bot from the parent bot and then migrate that parent bot.  To view the unsupported commands used in the child bots, go to the list of bots that cannot be migrated and click the child bot name.

Message	Migration of "Object Cloning" with "HTML (Edge)" is not yet supported
Description	The Microsoft Edge Legacy browser is not supported in the Automation 360, so the migration of bots configured with this browser is not supported.
Action	Update the Enterprise 11 bots using other supported browsers such as Google Chrome, Firefox, Internet Explorer, or Microsoft Edge Chromium browser.

Message	Migration of MetaBot is not supported. The screen file does not exist. Please fix the bot and try again.
Description	MetaBot Logic refers to a screen that does not exist in the MetaBot.
Action	To migrate the MetaBot, either add the screen again or remove references to the non-existent screens.

Message	Migration of "Variable Operation" command where variable types do not match is not supported. Please fix the bot and try again.
Description	Enterprise 11 or Enterprise 10 bot uses the <b>Variable Operation</b> command where the variable types of the variables used are not the same.
Action	Update the <b>Variable Operation</b> command in the Enterprise 11 or Enterprise 10 bots to ensure that the referenced variables are of the same type.



Message	Migration of "Variable Operation" command where the variable does not exist is not supported. Please fix the bot and try again.
Description	Enterprise 11 or Enterprise 10 bot references a non-existent variable in the <b>Variable Operation</b> command.
Action	Either create a variable with the same name and type, or remove the command that references the non-existent variable.

Message	Migration of "If" command where the variable does not exist is not supported. Please fix the bot and try again.
Description	Enterprise 11 or Enterprise 10 bot references a non-existent variable in the <b>If</b> command.
Action	Either create a variable with the same name and type, or remove the command that references the non-existent variable.

Message	Migration of "ElseIf" command where the variable does not exist is not supported. Please fix the bot and try again.
Description	Enterprise 11 or Enterprise 10 bot references a non-existent variable in the <b>Else If</b> command.
Action	Either create a variable with the same name and type, or remove the command that references the non-existent variable.

Message	Migration of "Loop" command where the variable does not exist is not supported. Please fix the bot and try again.
Description	Enterprise 11 or Enterprise 10 bot references a non-existent variable in the <b>Loop</b> command.
Action	Either create a variable with the same name and type, or remove the command that references the non-existent variable.

Message	Migration of "Run Task" with bot path defined using "AAAApplicationPath" not followed by valid repository folder path is not supported. Please fix the task bot path in the 11.x bot and migrate again.
Description	Enterprise 11 or Enterprise 10 bot uses an invalid path in the <b>Run Task</b> command of the child bot.

Action	To migrate this bot, modify the Enterprise 11 bot to ensure a valid child bot path is provided after AAAApplicationPath.
--------	--

Message	Migration of "If - TaskSuccessful" with bot path defined using "AAAApplicationPath" not followed by valid repository folder path is not supported. Please fix the task bot path in the 11.x bot and migrate again.
---------	--

Description	Enterprise 11 or Enterprise 10 bot uses an invalid path within the <b>If &gt; Task Successful</b> condition of the child bot.
-------------	---

Action	Update the Enterprise 11 or Enterprise 10 bot to ensure a valid child bot path followed by a proper folder structure is provided after AAAApplicationPath.
--------	--

Message	Migration of "If - TaskUnsuccessful" with bot path defined using "AAAApplicationPath" not followed by valid repository folder path is not supported. Please fix the task bot path in the 11.x bot and migrate again.
---------	--

Description	Enterprise 11 or Enterprise 10 bot uses an invalid path within the <b>If &gt; Task Unsuccessful</b> condition of the child bot.
-------------	---

Action	Update the Enterprise 11 or Enterprise 10 bot to ensure a valid child bot path followed by a proper folder structure is provided after AAAApplicationPath.
--------	--

Message	Migration of "ElseIf - TaskSuccessful" with bot path defined using "AAAApplicationPath" not followed by valid repository folder path is not supported. Please fix the task bot path in the 11.x bot and migrate again.
---------	--

Description	Enterprise 11 or Enterprise 10 bot uses an invalid path within the <b>Else If &gt; Task Successful</b> condition of the child bot.
-------------	--

Action	Update the Enterprise 11 or Enterprise 10 bot to ensure a valid child bot path followed by a proper folder structure is provided after AAAApplicationPath.
--------	--

Message	Migration of "ElseIf - TaskUnsuccessful" with bot path defined using "AAAApplicationPath" not followed by valid repository folder path is not supported. Please fix the task bot path in the 11.x bot and migrate again.
---------	--

Description	Enterprise 11 or Enterprise 10 bot uses an invalid path within the <b>Else If &gt; Task Unsuccessful</b> condition of the child bot.
-------------	--

Action	Update the Enterprise 11 or Enterprise 10 bot to ensure a valid child bot path followed by a proper folder structure is provided after AAApplicationPath.
--------	---

Message	Migration of "Variable Operation" command resetting system variable "\$WorkItemResult\$" will not be supported.
---------	---

Description	Resetting the system variable <b>\$WorkItemResult\$</b> is not supported for <b>Variable Operation</b> command.
-------------	---

Action	Use the <b>String &gt; Assign</b> operation and assign an empty string to the <b>\$WorkItemResult\$</b> system variable instead of resetting it.
--------	--

Message	Migration of "Windows - Close All Open Windows" is not yet supported.
---------	---

Description	If you have used the <b>Close</b> command with the <b>All open windows</b> option selected in a bot, you cannot migrate that bot.
-------------	---

Action	Update the Enterprise 11 or Enterprise 10 bot so that it does not use the <b>All open windows</b> option before you migrate it
--------	--

Message	Migration of "If - ObjectProperties" with field "OObjectPlay_PropertyInfo_ReviewMessage" of type "String" is not yet supported.
---------	---

Description	Enterprise 11 or Enterprise 10 bot uses an object in the <b>If &gt; Object Properties</b> command that has one of the properties with size larger than 64 KB.
-------------	---

Action	To migrate this bot, you can perform one of the following actions: <ul style="list-style-type: none"> <li>• Delete the property value that is larger than 64 KB in size, in the <b>If &gt; Object Properties</b> command.</li> <li>• Store the property value which exceeds 64 KB into a text file. Then, create a variable which reads the value from this file. Assign this new variable to the corresponding property in the <b>If &gt; Object Properties</b> command.</li> </ul>
--------	--

Message	Migration of "ElseIf - ObjectProperties" with field "OObjectPlay_PropertyInfo_ReviewMessage" of type "String" is not yet supported.
---------	---

Description	Enterprise 11 or Enterprise 10 bot uses an object in the <b>Else If &gt; Object Properties</b> command that has one of the properties with size larger than 64 KB.
-------------	--

Action	<p>To migrate this bot, you can perform one of the following actions:</p> <ul style="list-style-type: none"> <li>To migrate this bot, delete the property value that is larger than 64 KB in size, in the <b>Else If &gt; Object Properties</b> command.</li> <li>Store the property value which exceeds 64 KB into a text file. Then, create a variable which reads the value from this file. Assign this new variable to the corresponding property in the <b>Else If &gt; Object Properties</b> command.</li> </ul>
Message	<p>Migration of "Loop.Condition - ObjectProperties" with field "OObjectPlay_PropertyInfo_ReviewMessage" of type "String" is not yet supported.</p>
Description	<p>Enterprise 11 or Enterprise 10 bot uses an object in the <b>Loop while &gt; Object Properties</b> command that has one of the properties with size larger than 64 KB.</p>
Action	<p>To migrate this bot, you can perform one of the following actions:</p> <ul style="list-style-type: none"> <li>To migrate this bot, delete the property value that is larger than 64 KB in size, in the <b>Else If &gt; Object Properties</b> command.</li> <li>Store the property value which exceeds 64 KB into a text file. Then, create a variable which reads the value from this file. Assign this new variable to the corresponding property in the <b>Else If &gt; Object Properties</b> command.</li> </ul>

## Differences in Automation 360 and Enterprise 11/Enterprise 10 features

Review how some features and functionalities, such as folder structure, bot deployment, packages, variables, and MetaBots, are different in Automation 360 as compared with Enterprise 11 and Enterprise 10.

### Folder structure

The folder structure in which bots (Task Bots and MetaBots) are stored in Automation 360 is different compared with Enterprise 11 and Enterprise 10.

Automation 360 folder structure

The bots (Task Bots and MetaBots) are available in the **Automation > Bots**. Bots that are migrated from Enterprise 11 or Enterprise 10 are available in the public workspace.

The following image shows the folder structure in Automation 360

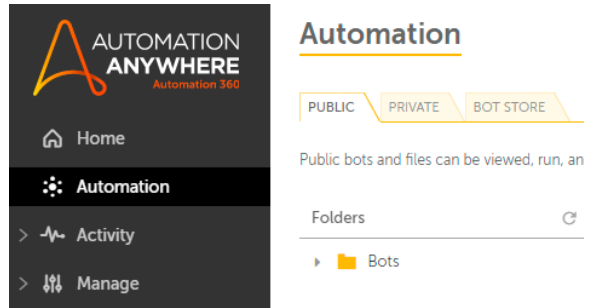

Enterprise 11 and Enterprise 10 folder structure

Bots (Task Bots only) are available in the **My Tasks** folder (**Automate > Tasks > My Tasks**) and MetaBots are available in the **My MetaBots** folder.

The following image shows the folder structure in Enterprise 11:

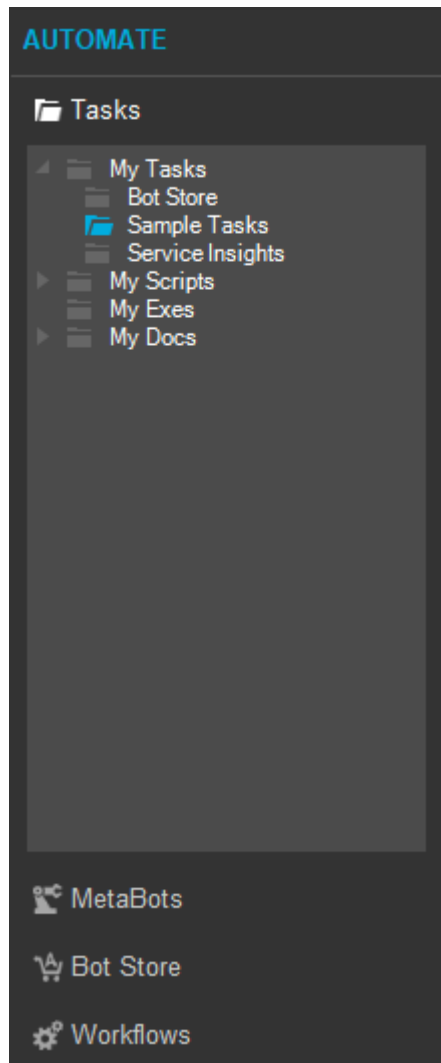

## Bot deployment

- Enterprise 11 : When a low-priority bot is running and a high-priority bot is deployed, the system pauses the low-priority bot and runs the high-priority bot. After the high-priority bot is run, the low-priority bot resumes.
- Automation 360 : The priority of bots is verified at deployment. When bots are queued for a Bot Runner user, higher-priority bots are deployed before lower-priority bots. However, if a lower-priority bot is already running, the higher-priority bots are deployed only after the lower-priority bot completes running.

## Packages

For most of the Enterprise 11 or Enterprise 10 commands, similar or equivalent actions and packages are available in Automation 360. However, the behavior of some of the Automation 360 commands is different compared with those in Enterprise 11 or Enterprise 10.

- Automation 360 is created afresh to support not only the current but also the future automation needs of modern enterprises. Accordingly, Automation 360 is built to meet important objectives, such as providing the following features:
  - A standardized, predictable, and scalable platform
  - Consistent user experience
  - Improved flexibility and security

With Automation 360, we aim to provide these features by employing industry-standard exception handling, rich support for dedicated data types, and so on.

Because Automation 360 is created afresh, some of the Enterprise 11 capabilities that have been redesigned in Automation 360 might not have a directly corresponding Automation 360 feature.

However, to ensure that the migrated bots produce output that is identical to that produced by their corresponding Enterprise 11 bots, we have mapped Enterprise 11 commands to their corresponding actions in Automation 360.

In instances where a direct mapping between an Enterprise 11 command and an Automation 360 action is unavailable, we have used "expressions" to ensure that the migrated bots produce output that is identical to that produced by their corresponding Enterprise 11 bots, without requiring you to manually update the bots.

---

**Note:** The usage of expressions leads to more number of lines and additional variables in the migrated bots as compared to their corresponding Enterprise 11 bots.

---

For information about expressions, see [Legacy Automation package](#) on page 2765.

- For Enterprise 10/Enterprise 11 command using a windows title field configured with a user defined variable, the migration process migrates the bot by adding the **Set Title** action just above the respective command. Automation 360 does not allow user variables in the **Windows Title** field. Use the **Set Title** action to achieve the same behavior.
- In Enterprise 11, when a bot contains more than one command with the **resize window** option selected, the window is resized to the dimensions specified by the first command. In Automation 360, the window is resized each time the bot encounters an action with the **resize window** option selected. This ensures that at runtime the window dimensions of each action

match the dimensions at which that action was configured, which enhances the bot's ability to find the object.

- In Enterprise 11 or Enterprise 10, loop indexing of table starts with 1 and increments by 1. Automation 360 starts indexing with 0 and increments by 1.
- The migration process migrates IF and Loop commands that contain multiple conditions of a variable.
- Disabled commands are migrated as follows based on the different coding patterns:
  - An individually disabled command (with or without any validation error) is migrated as a disabled action. All actions are disabled if one disabled command is migrated to multiple actions in Automation 360.
  - Disabled **Error Handling** command is migrated to disabled try and catch block including all other actions depending on its configuration.
  - Disabled **Loop** command is migrated to a disabled **Loop** action in Automation 360.
  - Disabled **If** command is migrated as a comment so that the migrated bot returns the same result as that returned by the corresponding Enterprise 10 or Enterprise 11 bot.
- In Enterprise 11 or Enterprise 10, some String operation commands use Tab, Enter, and Separator special characters. In Automation 360, these characters are system variables in the String package.

Enterprise 10/Enterprise 11	Automation 360
[Tab]	\$String:Tab\$
[Enter]	\$String:Enter\$
[Separator]	\$String:Separator\$

See [String package](#) on page 3086.

- Enterprise 11 or Enterprise 10 provides various presets as part of the windows title selection and they are migrated to respective presets in Automation 360.

Enterprise 10/Enterprise 11 Options	Automation 360 Options
Current Active Window	Current Active Window
Desktop	<ul style="list-style-type: none"> <li>• For the <b>Insert mouse click</b> command, use the <b>Screen for window title</b> option.</li> <li>• For the <b>Insert keystroke</b> command, use the <b>Current Active Window</b> option.</li> <li>• For <b>Screen &gt; Capture area</b>, use the <b>Screen for window title</b> option.</li> <li>• For the <b>Capture Desktop</b> command of the Screen Capture command, use the <b>Capture area</b> action of the Screen package with the <b>Screen</b> option selected from the list available in the <b>Application</b> tab.</li> </ul>
Wallpaper	Desktop
Taskbar	Taskbar

[Package mapping for migration](#) on page 1620

## Variables

For most of the Enterprise 11 or Enterprise 10 user, system, and credential variables, similar or equivalent system variables are available in Automation 360. The behavior of some of the Enterprise 11 or Enterprise 10 variables is different compared with Automation 360.

- For each variable passed as input in Enterprise 11 or Enterprise 10 bot, a line is added in the migrated bot in Automation 360. For example, if you are passing 100 variable as input in Enterprise 11 bot, after migration that bot has 100 new lines.
- In Enterprise 11 or Enterprise 10, you can use the **Session Name** field in paired commands to specify a session name as both a static value and a variable value. For example, you can specify a session name to open a file or establish a connection. You can then use that same session name as a variable value in a Loop command. However, migrated bots differentiates between a static value and a variable value, and handle the values differently after migration. As a result, after you migrate these bots to Automation 360, you must update the bot to use the correct output Dataset variables in the Loop command (which is aligned with the **Open file** session variable). For migrated bots, we recommend that you configure the session name as a static value or a variable value in all the instances.
- Enterprise 11 or Enterprise 10 commands that store the return values to the \$Clipboard\$ system variable are not supported in Automation 360. When you migrate bots with this functionality, the migration process assigns the values to a temporary variable and then assigns the value to the Automation 360 \$System:Clipboard\$ system variable by adding the **Copy To** action to the **Clipboard** package.
- Some commands return values to variables for further processing. In Enterprise 11 or Enterprise 10, users can store these values in different types of variables, where as in Automation 360, these values are stored in a specific type of variable only.

For example, if a command returns a value to an array for a specific cell, then in Automation 360, we store the value in a temporary string variable. Then in the next action, we store this temporary value to an actual array variable to ensure that the bot execution logic stays intact.

- In Automation 360, the single dollar sign (\$) is reserved for Automation Anywhere use, so all user entries of a single dollar sign are automatically replaced with two dollar signs (\$\$). For example, if you have a text field, "Pay \$5.00", we convert that field to read "Pay \$\$5.00" in Automation 360 for it to display properly to users.
- In Enterprise 11 or Enterprise 10, bots can use a variable to specify the child bot you want to run. In Automation 360, the task path is updated to the Bots folder. The following table provides a few examples:

Enterprise 11/ or Enterprise 10	Automation 360
D:\My Documents \AAE_v11\Automation Anywhere Files\Automation Anywhere\My Tasks\Migration\\${bot_name\$}	Bots\My Tasks\Migration\ \${bot_name\$}
\$AAAapplicationpath\$\Automation Anywhere\My Tasks\Migration\ \${bot_name\$}	Bots\My Tasks\Migration\ \${bot_name\$}



Enterprise 11/ or Enterprise 10	Automation 360
D:\\$UserName\$\My Documents \AAE_v11\Automation Anywhere Files\Automation Anywhere\My Tasks\Migration\\$bot_name\$	Bots\My Tasks\Migration\ \$bot_name\$
D:\My Documents \AAE_v11\Automation Anywhere Files\Automation Anywhere\ \$bot_path\$\\$bot_name\$	Bots\My Tasks\\$bot_path\ \$bot_name\$

[Variable mapping for migration](#) on page 1655

[Variables support](#) on page 1001

## MetaBots

MetaBots are not available in Automation 360. When you migrate Enterprise 11 or Enterprise 10 MetaBots, they are migrated to equivalent Task Bots in Automation 360. These Task Bots provide similar output and capabilities of the MetaBots.

The migration process migrates the DLLs and logic to equivalent bots. The **Run Logic** command is converted to the **Run** action of the Task Bot package. The DLLs in the MetaBots use the **Execute** command to run a function from that DLL. After migration to Automation 360, each **Execute** command is converted to **Open**, **Run function**, and **Close** actions of the **DLL** package. Information about which function to run from the DLL, which parameters to use, and other details in the **Execute** command is migrated to the **Run** action. MetaBots with DLLs that use credential variables of string, character, and Byte data type can be migrated to Automation 360.

Earlier to Automation 360 v.17, the dictionary variable was used to provide input parameters in a migrated bots which used to add additional steps in the bot. Starting from v.17, the Entrylist variable is used to provide input parameters in a migrated bot. This reduces the number of steps added to the migrated bot.

[How MetaBots are migrated](#) on page 1596

## Bot Scanner for migration

The Bot Scanner analyzes bots (Task Bots and MetaBots) created in your Enterprise 10 or Enterprise 11 Control Room. The scanner generates a report summarizing the number of bots, commands, and variables that are ready for migration and those not yet supported for migration, and provides a recommendation on whether you are ready for migration.

---

**Note:** A new version of Bot Scanner is released with each Automation 360 release. Use the latest Bot Scanner version to monitor the commands and variables that are supported for migration in Automation 360 with each update. The scanner obtains information about the Automation Anywhere components used by customers and prioritizes support for these components for migration.

---

## Considerations for using Bot Scanner

- Ensure that you are on the supported Enterprise 10 or Enterprise 11 Control Room version for migration before you scan your bots.  
[Supported Control Room versions for migration](#) on page 1506
- You do not have to install Automation 360 to run the Bot Scanner, but access to your Enterprise 10 or Enterprise 11 repository is a requirement.
- You must run the Bot Scanner before performing any migration steps.

## How Bot Scanner works

The Bot Scanner reads the contents of your Enterprise 10 or Enterprise 11 and provides a summary report for your analysis. The scanner provides a recommendation on whether or not to migrate now and an estimated time of availability (ETA) on when unsupported commands will be supported in Automation 360.

---

**Note:** The Bot Scanner does not migrate bots or perform any other action. If you are not ready for migration, the Bot Scanner identifies the reasons why the bots cannot be migrated.

---

The bots (.atmx and .mbot files) are scanned at the location you specify and the summary report provides the following information:

- The number of bots scanned
- The number of bots that can and cannot be migrated to Automation 360
- The commands and variables that are used in the scanned bots and supported in Automation 360
- The commands that are migrated to Automation 360 with some modifications that have to be reviewed

---

**Note:** The Bot Scanner generates the summary report in HTML format and a separate report for each bot in XML format.

---

## Bot Scanner reports

The Bot Scanner generates the following reports to help you decide whether you should start the migration.

Proceed with migration

This recommendation is provided when 95% or more than 95% of your bots can be migrated. As the majority of your bots are ready for migration, you are eligible for migration. You might have to perform some work before or after migration to migrate some of the remaining bots.

Wait to migrate

This recommendation is provided when less than 95% of your bots can be migrated. In this case, you must run the latest version of the Bot Scanner available with next release of

Automation 360, to assess your eligibility for migration.

## Sharing Bot Scanner report to improve experience

You can help improve the experience of migration to Automation 360 by sharing the reports generated by the Bot Scanner. These reports help our engineering team focus on supporting the components that are more frequently used by our customers.

---

**Important:** We maintain the privacy of the shared reports. No personally identifiable information (PII) is included and you can review the reports before sharing. Contact your Customer Success Manager (CSM) or Partner Enablement Manager (PEM) for more details.

---

## Bot Scanner for EOL features

For information about Automation 360 Bot Scanner for EOL features, go to [Scan bots for Basic authentication](#) on page 1134.

## Scan Enterprise 11 or 10 bots using Bot Scanner

Before you migrate to Automation 360, it is important to verify the migration readiness of your bots. Scan the bots using Bot Scanner and analyze the generated report for information about the commands and variables used in these bots and how many of these commands and variables are supported for migration.

Ensure you meet the system requirements for using the Bot Scanner:

- Hardware requirements

Processor	2.66 GHz or higher (64-bit)
RAM	8 GB or higher
Disc space	128 GB or higher
Repository size	up to 10 GB

- Software requirements
  - Operating systems: Windows 7 or later (32-bit and 64-bit)
  - Number of bots: 10,000

You can also use the Bot Scanner to scan and identify bots that use Internet Explorer that can be converted to a supported browser.

---

### Note:

- If your repository size is high or the number of bots is more than 10,000, then increase the Xmx heap size or RAM size to generate the report.

- If your repository size is more than 10 GB or if the number of bots is more than 50,000, we recommend that you only scan for bots and skip scanning for processes.

- 
1. Download the latest version of Bot Scanner from the Automation Anywhere Support site.
    - a) Navigate to the [A-People Downloads page \(Login required\)](#).
    - b) Click the `Automation 360 v.xx <Build_number>` link.  
The `xx` in the link refers to the release number. For example, Automation 360 v.21.
    - c) Click the `Installation Setup` folder.
    - d) Click the `AAE Bot Scanner` zip file, and then click **Download** on the toolbar.

See the following video on how to download Bot Scanner:

2. Extract the files from the zip file you have downloaded and double-click `AAE_Bot_Scanner.exe`.

---

**Note:** Ensure that you save the `AAE_Bot_Scanner.exe` file in a location path that does not contain a double-byte character. Otherwise, the Bot Scanner encounters an error when it is run.

---

You can use the Bot Scanner to scan bots that use Internet Explorer. The scanner generates a report that provides details on the number of bots that can be converted and the number of bots that cannot be converted to a supported browser.

3. From the **Automation Anywhere Bot Scanner** dialog box, select one of the following options:
  - Migration to Automation 360
  - Migration + Bots using Internet Explorer
  - Bots using Internet Explorer

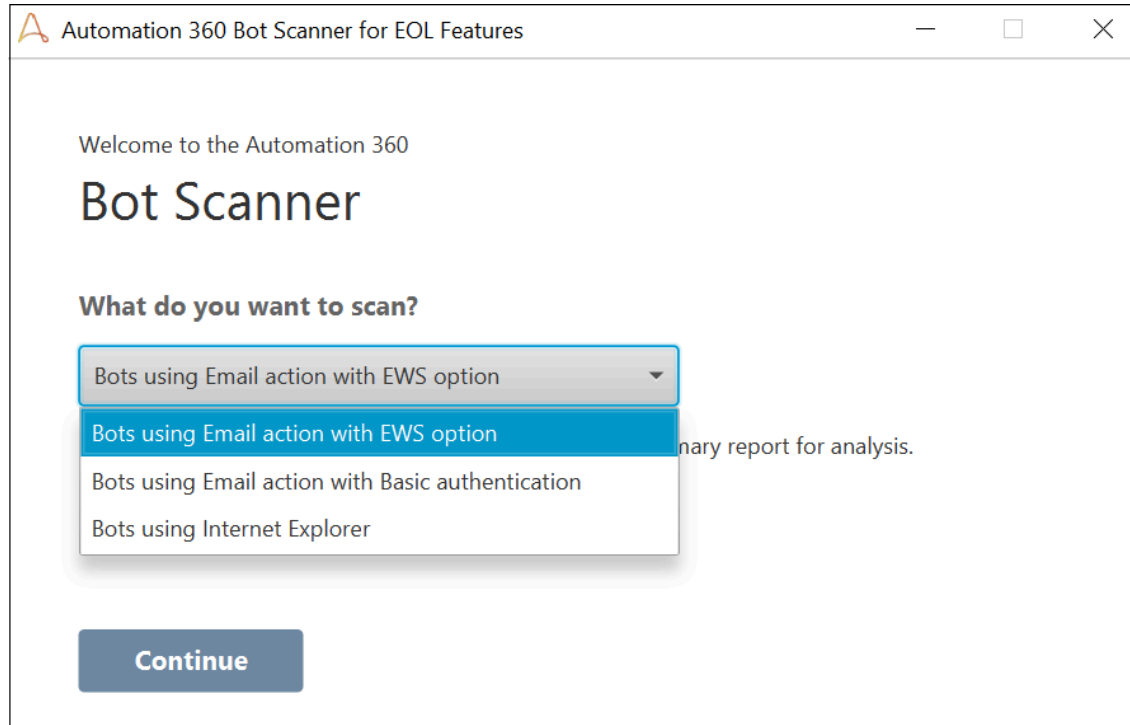

The second and third options provide Internet Explorer usage statistics that helps you to convert Internet Explorer bots to a supported browser.

4. In the **Automation Anywhere Bot Scanner** dialog box, enter the location of the folder that contains the bots that you want to analyze in the **Select repository path** field.

**Important:** You must create a copy of the Control Room repository and provide the location of the copied folder instead of the actual repository folder.

- a) Copy the Control Room repository.  
For example, if the current location of the repository is `C:\ProgramData\AutomationAnywhere\Server Files\Default\Automation Anywhere`, you must copy the `Automation Anywhere` folder.
- b) Paste the copied repository at a temporary location. For example, `D:\My Bots` folder. You must provide this location (`D:\My Bots`) in the **Select repository path** field in Step 3.

5. Enter the location where you want to save the generated report in the **Select destination folder** field.

**Note:** The Bot Scanner related files and folders in the destination folder are overwritten if you have specified the same location when you have used the Bot Scanner previously.

6. Enter a value in the **Timeout** field to specify the maximum time the Bot Scanner should take to analyze a bot.  
If the scanning of a bot takes more than the value specified in the **Timeout** field, Bot Scanner stops scanning that bot and proceeds to scanning other bots in the repository.
7. In the **Generate output report for** option, select the options for which you need to generate the report.

**Note:** For repositories that are more than 10 GB in size, we recommend that you select only the **Bots** option for generating the report.

---

**8.** Click **Create report**.

The Bot Scanner starts analyzing the bots available in the repository.

The Bot Scanner displays an error if it scans a bot that is created using an unsupported version of Enterprise Client. You must upgrade the bot to a supported version of Enterprise Client and scan the bot again.

**9.** Optional: You can click **Stop scanning** when the Bot Scanner is analyzing the bots to cancel the operation.

The summary report and individual reports are available for the bots that were analyzed before the operation was canceled.

**10.** Click **Open report** to open the summary report in the default browser after the Bot Scanner has completed analyzing all the bots available in the repository.

See the following video on how to use the scanner to scan Enterprise 11 or 10 bots:

- For migration: [Analyze Bot Scanner report for migration](#) on page 1534
- For IE EOL: [Analyze report for Internet Explorer bots](#) on page 1115
- For Basic authentication EOL: [Scan bots for Basic authentication](#) on page 1134

Related concepts

[Bot Scanner for migration](#) on page 1529

The Bot Scanner analyzes bots (Task Bots and MetaBots) created in your Enterprise 10 or Enterprise 11 Control Room. The scanner generates a report summarizing the number of bots, commands, and variables that are ready for migration and those not yet supported for migration, and provides a recommendation on whether you are ready for migration.

Related reference

[Analyze Bot Scanner report for migration](#) on page 1534

You can analyze the report generated by the Bot Scanner to get information about the bots (Task Bots and MetaBots) and processes that can be migrated. Use the Bot Scanner to decide if you are ready to start migration now or prefer to wait until more commands are supported.

## Analyze Bot Scanner report for migration

You can analyze the report generated by the Bot Scanner to get information about the bots (Task Bots and MetaBots) and processes that can be migrated. Use the Bot Scanner to decide if you are ready to start migration now or prefer to wait until more commands are supported.

The Bot Scanner report provides the following information:

- **Bots:** In the Bot Scanner report, a bot is an individual Task Bot (.atmx) or MetaBot (.mbot) that is used in other bots.

The **Bots** tab provides detailed information about bots that can be migrated, those that require action or review, and those that cannot be migrated.

- **Processes:** In the Bot Scanner report, a process is a bot that is not used in any other bots and can include one or more child bots.

The **Processes** tab provides detailed information about processes that can be migrated, those that require action or review, and those that cannot be migrated.

The Bot Scanner provides the following important information about the bots and processes:

- Number of bots and processes analyzed
- A high-level summary in the form of boards to indicate the migration status of bots and processes
- Number of bots and processes that you can and cannot migrate to Automation 360
- Commands that are used in the bots and the frequency of usage
- Reasons why bots and processes cannot be currently migrated and frequency of such occurrences
- Actions and reviews required by the users after migration due to change in the behavior of the commands
- Bots and processes that cannot be migrated and their corresponding error messages
- Number of lines in bots, and total number of lines of each bots associated with a process
- Line number for individual bots and processes that need review or action

---

**Important:** Automation 360 is updated frequently in order to achieve 100% functional equivalency with Enterprise 10 or Enterprise 11 versions. The percentage of bots, commands, and variables that are supported for migration in Automation 360 will increase until it reaches 100% over the next upcoming releases. That is, for every function you do in Enterprise 10 or Enterprise 11, an equivalent capability is in Automation 360.

Most of the Enterprise 10 or Enterprise 11 features are available as is; however, some features are implemented differently to support web (without a client) operations. For these features, you have to change the way bots are written.

---

The Bot Scanner is designed to scan bots (Task Bots and MetaBots) created using both Enterprise 10 and Enterprise 11 versions of Enterprise Client. The total file count includes the number of files that were skipped and not scanned.

The reports are available at the output location you specified in the **Select destination folder** field in the **Automation Anywhere Bot Scanner** dialog box. The Bot Scanner generates a summary report (`summary.html`) and a separate XML for each bot that it scanned. It creates a separate report for each logic available in a MetaBot.

A `raw-data` folder is created that contains the reports (in XML format) for each bot scanned. It helps our engineers to further analyze the migration process and take corrective actions, if required. No personally identifiable information (PII) is included in the summary report or the individual reports of the scanned bots.

If you choose to share the reports with us to help improve the product, compress the files in the `raw-data` folder and coordinate with your Customer Success Manager (CSM) or Partner Enablement Manager (PEM). No data is automatically shared with Automation Anywhere.

## Summary report for all bots

The Bot Scanner utility provides an option to scan for either bots or processes, or bots and processes. Depending on what you choose, the summary report will contain information about the bots, processes, or bots and processes. Most of the sections seen in these summary reports will be the same except that in the bots and processes summary report you will also see an

---

additional **All** tab that lists all the bots or processes that are flagged and sorted as **Action required**, **Review required**, **No review required**, and **Non Migratable**.

---

**Note:** For generating processes summary report, the maximum repository size that is supported is up to 10 GB.

---

The summary report provides information about the following:

- whether you can migrate to Automation 360
- the total number of bots scanned
- bots only report that provides information about the bots supported for migration to Automation 360 (in percentage)
- processes only report that provides information about the processes supported for migration to Automation 360
- bots and processes combined report that provides information about the bots and processes supported for migration to Automation 360

For example, consider the Bot Scanner has scanned 10 bots. Of the 10 bots, if 8 bots are ready for migration to Automation 360, then percentage of bots that can be migrated is 80% and the percentage of bots that cannot be migrated now is 20%.

Reviewing the Bot Scanner report for bots

Consider a scenario where you have scanned a total of 1618 bots, of which 98% (1614 bots) can be migrated to Automation 360. However, 5% of bots require action after migration, and 2% (4 bots) cannot be currently migrated due to certain reasons. In such a scenario, the Bot Scanner report enables you to perform the following actions:

- Identify the actions and reviews for the remaining 5% of bots so that you can successfully migrate a majority of your bots and run them in Automation 360 after migration.
- Identify bots that can be migrated to Automation 360 without any manual intervention.
- Identify the reason why 2% of bots cannot be currently migrated and the estimated time for when you can migrate them later. The reason might be due to commands and variables not yet supported in Automation 360.

Reviewing the Bot Scanner report for processes

To review a process message, perform these steps:

1. Click the **Processes** tab.
2. Click the messages tab that you want to review.
3. In the **Master Task Reference** column, click the expand icon (  ) to view the process.
4. Click a process name to view the message.

Consider a scenario where you have a total of 100 processes, of which 99 processes can be migrated to Automation 360. However, 5 processes require action after migration, 10 processes require review after migration, and 1 processes cannot be currently migrated due to certain reasons. In such a scenario, the Bot Scanner report enables you to perform the following actions:

- Identify the actions and reviews for the remaining 15 processes so that you can successfully migrate a majority of your processes and use them in Automation 360 after migration.
- Identify processes that can be migrated to Automation 360 without any manual intervention.



- Identify the reason why that 1 process cannot be currently migrated and the estimated time for when you can migrate them later.  
The reason might be due to commands and variables not yet supported in Automation 360.

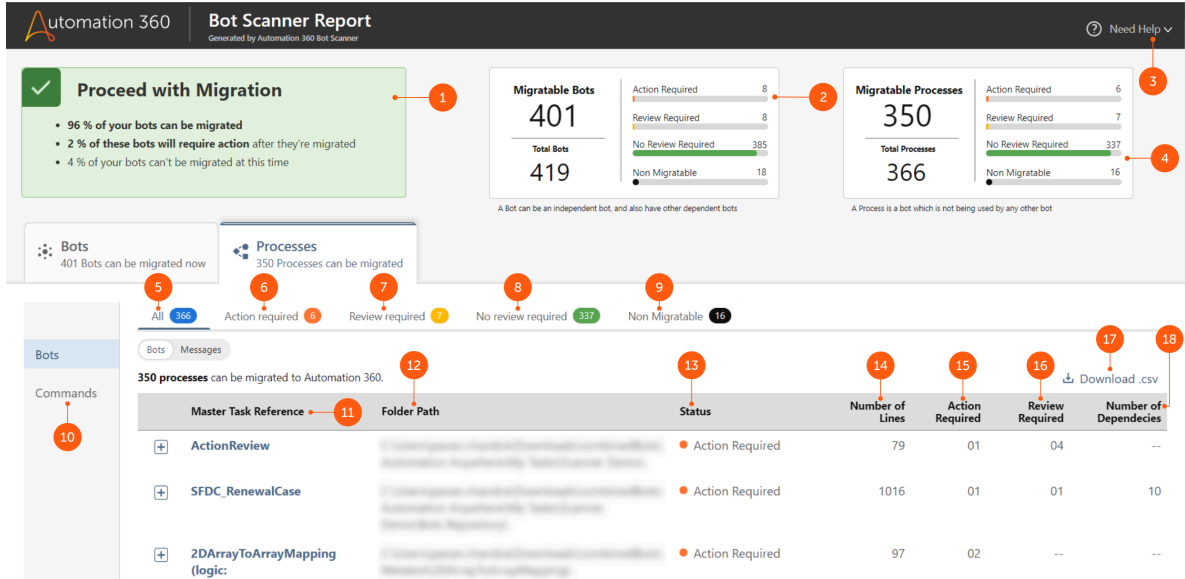

The following image is a sample report from the Bot Scanner:







The following table describes the various fields in the sample Bot Scanner report (as numbered in the previous image):

Field/option	Description
1	Provides a summary and status of the migration readiness of your bots. Review the status of migrated based on the following: <ul style="list-style-type: none"> <li>Green: You can proceed with migration provided that you review the report for any action or review required for your bots.</li> <li>Amber: You have to wait for migrating your bots as the percentage of bots that are qualified for migration do not meet the migration requirements.</li> </ul>

Field/option	Description
2	<p>Provides a summary of the following information for bots:</p> <ul style="list-style-type: none"> <li>• <b>Migratable Bots:</b> Provides a summary of the total number of bots that can be migrated.</li> <li>• <b>Total Bots:</b> Provides a summary of the total number of bots that were scanned.</li> <li>• <b>Action Required:</b> Provides a summary of the total number of bots that require action after migration to Automation 360.</li> <li>• <b>Review Required:</b> Provides a summary of the total number of bots that require review after migration to Automation 360.</li> <li>• <b>No Review Required:</b> Provides a summary of the total number of bots that can be migrated to Automation 360 without any manual intervention.</li> <li>• <b>Non Migratable:</b> Provides a summary of the total number of bots that cannot be currently migrated to Automation 360.</li> </ul>
3	Provides additional resources to ease the migration process.
4	<p>Provides a summary of the following information for processes:</p> <ul style="list-style-type: none"> <li>• <b>Migratable Processes:</b> Provides a summary of the total number of processes that can be migrated.</li> <li>• <b>Total Processes:</b> Provides a summary of the total number of processes that were scanned.</li> <li>• <b>Action Required:</b> Provides a summary of the total number of processes that require action after migration to Automation 360. Even if a child bot in a process requires action, the process is flagged as <b>Action Required</b>.</li> </ul> <hr/> <p><b>Note:</b> If a process contains bots where some of them require review and some others require action, then the process is flagged as <b>Action Required</b>. The <b>Action Required</b> status takes precedence over the <b>Review Required</b> status.</p> <hr/> <ul style="list-style-type: none"> <li>• <b>Review Required:</b> Provides a summary of the total number of processes that require review after migration to Automation 360. Even if a child bot in a process requires review, the process is flagged as <b>Review Required</b>.</li> <li>• <b>No Review Required:</b> Provides a summary of the total number of processes that can be migrated to Automation 360 without any manual intervention. All the bots in the process can be migrated.</li> <li>• <b>Non Migratable:</b> Provides a summary of the total number of processes that cannot be currently migrated to Automation 360. All the bots in the process cannot be migrated.</li> </ul>

Field/option	Description
5	<ul style="list-style-type: none"> <li>• <b>Bots &gt; All &gt; Bots or Processes &gt; All &gt; Bots:</b> Go to this view for a list of all the bots or processes that are flagged and sorted as <b>Action required, Review required, No review required, and Non Migratable.</b></li> <li>• To view the message for a specific bot that require action or review, click the bot name.</li> <li>• To view the message for a specific process that require action or review, click the expand icon (  ), and then click the task reference name.</li> </ul> <p>Click the message code to view the information about changes in Automation 360 behavior for the command compared with the Enterprise 11 or Enterprise 10 behavior.</p> <hr/> <p><b>Note:</b> Each message includes information you have to review after migration. For a list of these messages, see <a href="#">Review required messages</a> on page 1694. Use the message code (for example R102) to view the specific message quickly.</p>
6	<p><b>Bots &gt; Action required &gt; Bots or Processes &gt; Action required &gt; Bots:</b> Go to this view for the list of bots or processes that require action after migration to Automation 360.</p> <ul style="list-style-type: none"> <li>• To view the message for a specific bot that require action, click the bot name.</li> <li>• To view the message for a specific process that require action, click the expand icon (  ), and then click the task reference name.</li> </ul> <p>Click the message code to view the information about changes in Automation 360 behavior for the command compared with the Enterprise 11 or Enterprise 10 behavior.</p> <hr/> <p><b>Note:</b> Each message includes information you have to review after migration. For a list of these messages, see <a href="#">Review required messages</a> on page 1694. Use the message code (for example R102) to view the specific message quickly.</p>

Field/option	Description
7	<ul style="list-style-type: none"> <li>• <b>Bots &gt; Review required &gt; Bots</b> or <b>Processes &gt; Review required &gt; Bots</b>: Go this view for a list of the bots or processes that require review after migration to Automation 360.</li> <li>• To view the review required message for a specific bot, click the bot name.</li> <li>• To view the review required message for a specific process, click the expand icon (  ), and then click the task reference name.</li> </ul> <p>Click the message code to view the information about changes in Automation 360 behavior for the command compared with the Enterprise 11 or Enterprise 10 behavior.</p> <hr/> <p><b>Note:</b> Each message includes information you have to review after migration. For a list of these messages, see <a href="#">Review required messages</a> on page 1694. Use the message code (for example R102) to view the specific message quickly.</p>
8	<p><b>Bots &gt; No review required &gt; Bots</b> or <b>Processes &gt; No review required &gt; Bots</b>: Go to this view for a list of bots or processes that can be migrated to Automation 360 without any manual intervention.</p>
9	<p><b>Bots &gt; Non Migratable &gt; Bots</b> or <b>Processes &gt; Non Migratable &gt; Bots</b>: Go to this view for a list of bots or processes that cannot be currently migrated to Automation 360.</p>
10	<p><b>Bots &gt; Commands</b> : Go to this view for a list of the commands that can be migrated and the number of times the commands are used across all your scanned bots.</p>
11	<ul style="list-style-type: none"> <li>• Bot name: In the <b>Bots</b> tab, click a bot name to view the action required message of a specific bot, click the bot name.</li> <li>• Master Task Reference: In the <b>Processes</b> tab, to view the action required message of a specific process, click the expand icon (  ), and then click a task reference name.</li> </ul> <p>Click the message code to view the manual steps you must perform to run the migrated process successfully in Automation 360.</p> <p>You can also view the commands that the bot contains and the frequency or the number of times the command is used in the bot.</p> <hr/> <p><b>Note:</b> Each message includes the cause and the action you have to perform after migration. For a list of these messages, see <a href="#">Action required messages</a> on page 1678. Use the message code (for example A101) to view a specific message quickly.</p>
12	<p>Provides the location of the bot.</p>
13	<p>Provides the status of the bot or process.</p>

Field/option	Description
14	<ul style="list-style-type: none"> <li>For bots, this field displays the number of lines used in a bot. This information will help you understand the complexity of the bot.</li> <li>For processes, this field displays the sum of the total number of lines used in the parent and child bots within a process. This information will help you understand the complexity of the process.</li> </ul>
15	<p>For processes, this field displays the number of bots in a process that requires action after migration to Automation 360.. Click the expand icon (  ) and then click a task reference name that is flagged as <b>Action Required</b>.</p> <p>Click the message code to view the information about changes in Automation 360 behavior for the command compared with the Enterprise 11 or Enterprise 10 behavior.</p> <hr/> <p><b>Note:</b> This field is available only for processes.</p>
16	<p>For processes, this field displays the number of bots in a process that requires review after migration to Automation 360. Click the expand icon (  ) and then click a task reference name that is flagged as <b>Review Required</b>.</p> <p>Click the message code to view the information about changes in Automation 360 behavior for the command compared with the Enterprise 11 or Enterprise 10 behavior.</p> <hr/> <p><b>Note:</b> This field is available only for processes.</p>
17	Download (as a CSV file) the list of bots, processes, or commands that can or cannot be migrated so that you can share the file with others.
18	<ul style="list-style-type: none"> <li>For bots, this field displays the number of times a bot is used as a child bot.</li> <li>For processes, this field displays the sum of the total number of dependencies used in the parent and child bots within a process.</li> </ul>

The report is valid until the next version of Bot Scanner is available. When the next version of Bot Scanner is available, a report expiry message is displayed. You must download the latest version of Bot Scanner and scan the bots again.

## Verifications and actions required after migration

Some commands in the bots might be marked as review required in the Bot Scanner report. For these items, you need perform certain validation or update the bots after they are migrated.

The following Bot Scanner messages require verification or some actions:

- Child bot path is completely variablized and is resolved at runtime. Bot would fail upon execution if the path specified in the variable is not valid. Please review the migrate bot.

Ensure that the child bot is available at the location specified in the variablized path. If the path in the parent bot is not correct, update the path to point to the correct child bot.

- Value returned by system variable "Error Description" might be different w.r.t. legacy versions. Please review the migrated bot.

Description of some of the error messages in Automation 360 might be different than Enterprise 11 or Enterprise 10 for the same error. If an Enterprise 11 or Enterprise 10 bot is configured to take decisions based on the description of the error messages, you might have to update the migrated bot based on the new description of error messages.

- Migration of "Database - Connect" command is completed but additional configuration required for "Windows authentication". Please refer the database package documentation for more details.

Complete the steps specified to connect to a Microsoft SQL Server with Windows authentication. See [Connect to Microsoft SQL Server with Windows authentication](#) on page 2473.

- Migration of "IF" with variable condition is completed. However, could not determine the date format of the user variable, hence migrated with default date format mm/dd/yyyy HH:mm:ss. Please review and change the format if required.

Update the date format in the migrated bot to the same format used in Enterprise 11 for that bot.

- Could not determine if a variable used as position is index or column name. Index position starts from 0 instead of 1 hence take necessary actions if needed.

If you have used the FileData Column[\$variable\$] or Excel Column[\$variable\$] system variables in the Enterprise 11 or Enterprise 10 bot, we assume that you have used the column name in the \$variable\$. In such cases, the migrated bot contains the FileData Column{\$variable\$} expression. If the \$variable\$ in the Enterprise 11 or Enterprise 10 bot contains the column number, you must update the expression in the migrated bot to FileDataColumn[\$var.String:toNumber()\$].

- The Run Logic command that uses credential variables as input for a logic of a MetaBot

Bots that use the **Run Logic** command that passes Credential Vault attributes from a Task Bot to a MetaBot logic can be migrated to Automation 360. The credential name and attribute name are displayed in the fields in the corresponding line of the migrated bot.

If you have migrated using the restored Enterprise 11 database, an equivalent locker is created in Automation 360 for the credential variables used in the Enterprise 11 bot.

Choose one of the following options to run the migrated bots successfully:

- Option 1: Pass the credential type variables.
  1. Create a credential type variable in the child bots as input variables.
  2. In the **Run** action of the Task Bot package of the parent bot, update the input value fields to use the Credential Vault attributes for the credential type variable created for the child bot (corresponding to MetaBot logic).

- Option 2: Pass the credential values as a global value.
  1. Create the Global value in Automation 360 for the credentials use in the **Run Logic** command in Enterprise 11.
  2. In the **Run** action of the Task Bot package of the parent bot, update the Input value fields to use the Global values for the credential type variable created for the child bot (corresponding to MetaBot logic).

If you have not used the restored Enterprise 11 database when installing Automation 360, you must first create the required locker for the credential variables used in the Enterprise 11 bot, before performing the preceding steps.

**Note:** Automation 360 provides enhanced security by allowing you to assign Credential Vault attributes only to the credential type variables. This restricts any nonsecure handling of Credential Vault attributes where they might have been assigned to non-credential type variables.

## Report for an individual bot

The report for each bot provides information about its dependencies, variables, and commands used.

The individual bot report looks similar to the following code:

```

    <analysis version="1.3.0">
      <stat>
        <dependencies ucount="0" count="0"/>
        <errors ucount="6" count="12">
          <error count="1">System variable
$AAApplicationPath$</error>
          <error count="1">Command [If FolderNotExist]
is not supported</error>
          <error count="3">System variable
$CurrentDirectory$</error>
          <error count="3">System variable $Extension$</
error>
        </errors>
      </stat>
      <commands>
        <command target-action="assign"
name="VariableOperation" line="1"
          grp="VariableOperation" api="VarOpe">
          <msg type="error" review="true"
category="variable">System
variable $AAApplicationPath$</msg>
          <msg type="info" review="false"
category="default">Command
parameter [Option] of type [String] is not
required.</msg>
        </command>
        <command target-action="createFolder"
name="createFolder" line="3"
          grp="FilesFolders" api="CreateFolder"/>

```

```

line="5"          <command target-action="copyFiles" name="CopyFiles"
                  grp="FilesFolders" api="CreateFolder"/>
line="3"          <command target-action="connect" name="Connect"
                  grp="Database" api="Connect"/>
line="9"          <command target-action="OpenCSVTEXT" name="ReadFrom"
                  grp="CsvText" api="Csv"
                  <msg tpye="info" review="false"
category="command">Line
                  in 11.x client, there is no separate option
given for CSV
                  and TEXT in Automation 360</msg>
                  <msg type="error" review="true"
category="variable">System
                  variable $CurrentDirectory$</msg>
                  <msg type="error" review="true"
category="variable">System
                  variable $Extension$</msg>
                  <msg type="error" review="true"
category="variable">System
                  variable $FileName$</msg>
                  </command>
</commands>
<variables>
  <variable name="$CSV-TXT-Default-DATA$"
            type="TABLE" value-type=""/>
</variables>
</analysis>

```

The following table describes the various attributes available in the XML report shown in the previous image:

Node	Attribute	Description
Stat	--	Provides information about the number of dependencies, error, and warnings.
--	dependencies	Specifies the number of dependencies for the bot. The <code>ucount</code> indicates the number of unique dependencies and the <code>count</code> indicates the total number of dependencies.
--	error	Specifies the number of errors for the bot. The <code>ucount</code> indicates the number of unique errors and the <code>count</code> indicates the total number of errors.
Command--		Provides information about the various commands and actions used in the bot.
--	command target-action	Specifies the action being performed for the command.
--	name	Specifies the name of the command.
--	line	Specifies the line number where the command is available in the bot.
--	grp	Specifies the command group the command belongs to.



Node	Attribute	Description
--	api	Specifies the name of the API the command uses.
--	msg type	Provides information about the message type. The <code>error</code> type indicates that the command cannot be migrated to Automation 360, and an <code>info</code> type indicates that the command can be migrated but some of its attributes will be changed during migration.
--	review	Provides information about whether the command has to be reviewed.  This attribute is always true for <code>error</code> type messages, which indicates that migration of that command to Automation 360 is not yet supported. For <code>info</code> type messages, if the attribute is true, you must review the value in the <code>category</code> attribute. You can decide whether you want to take any action on the migrated bot based on the value available in the <code>category</code> attribute.
--	category	Provides information about the command or variable for which the message is displayed.
Variables		Provides information about the system variables used by the bot.
--	variable name	Specifies the name of the variable.
--	type	Specifies the type of variable.
--	value type	Specifies the type of value provided for that variable.

See the following video on how to analyze the scanner report

## Get migration license

Migration is offered for free. To migrate to an Automation 360 environment (Cloud or On-Premises), you must request a migration license.

### License terms and duration

- If your migration is taking longer than expected to complete, contact your Customer Success Manager or Account Representative to discuss extensions.
- Your Automation 360 migration license is transitional, which means it will overlap with your Enterprise 10 or Enterprise 11 license during the migration period.

After you have completed your migration, your Automation 360 products and licenses will transfer over to the 1-to-1 equivalents of your current contract. You should review your automation requirements or renewal dates and determine if any updates in licensing are necessary.

**Note:** Run the Bot Scanner and determine when to migrate first. We recommend that you request a migration license only after you have run the Bot Scanner and have reviewed the prerequisites for your deployment choice.

---

## Requesting your migration license

When you are ready to begin migration, contact your Account Representative, submit your Bot Scanner report, and specify if you are requesting licenses for an Automation 360 Cloud or On-Premises deployment.

- To get started with Automation 360 (Cloud or On-Premises), you will be required to accept the in-product user terms.
- Because Automation Anywhere will be hosting customer data, customers migrating to Automation 360 Cloud must also agree to the Cloud Automation Agreement.

For Cloud migration, keep in mind the following:

- You must request the equivalent number of licenses for Control Room and other entitlements such as Bot Creators, Bot Runners, IQ Bot, and Bot Insight.

Migration fails if the number of Automation 360 licenses is not equivalent to the number of Control Room and other entitlements available in your Enterprise 11 environment.

Ensure that the number of Automation 360 licenses is equal to the number of Control Room and other entitlements available in your environment.

Otherwise, non-migrated user accounts will require further action after migration.

- You must request for the license when you are ready to begin migration because the migration code is valid for 30 days.

If you are not ready to begin migration and you get the migration license (along with the migration code), the 30-day validity of the code might expire by the time you begin migration or you might not have sufficient time to complete the migration.

## Activating the license

- Automation 360 Cloud: You will be provided with a migration code that includes your migration license. Paste this code into the Cloud Migration Utility, and then run the utility to activate your license.
- Automation 360 On-Premises: When you complete your Automation 360 installation, upload your GUID when you open the Automation 360 Control Room. If you do not have a license GUID, then upload the current license file.

## Prepare new Control Room for migration

Perform the tasks in this workflow to prepare your Automation 360 environment for migration.

Ensure that you have completed all the tasks to check your readiness for migration: [Check migration readiness](#) on page 1505.



1. Choose a deployment model (Cloud, Cloud-enabled, or On-Premises).
2. Request and activate your migration license.
3. Based on the deployment model you have selected, prepare your environment for migration:

Deployment model	Actions
Cloud	<ul style="list-style-type: none"> <li>• Migrate using the Cloud Migration Utility: <a href="#">Prepare for Enterprise 11 to Automation 360 Cloud migration</a> on page 1551</li> <li>• Use both Automation 360 Cloud and Enterprise 11 in parallel: <a href="#">Prepare for migration when using Enterprise 11 and Automation 360 Cloud in parallel</a> on page 1559</li> <li>• Manually migrate to Cloud: <a href="#">Prepare to manually migrate to Automation 360 Cloud</a> on page 1560</li> </ul> <hr/> <p><b>Note:</b> We do not support migration from to . However, you can manually migrate to by using the bot export utility. For assistance, contact support: .</p> <hr/>
Cloud-enabled	<a href="#">Prepare for Enterprise 11 to Automation 360 Cloud-enabled migration</a> on page 1574

Deployment model	Actions
On-Premises	<ul style="list-style-type: none"> <li>• Enterprise 11 to Automation 360:               <ul style="list-style-type: none"> <li>• <a href="#">Prepare for Enterprise 11 to Automation 360 On-Premises migration</a> on page 1563</li> <li>• Use both Automation 360 On-Premises and Enterprise 11 in parallel: <a href="#">Prepare for migration when using Enterprise 11 and Automation 360 On-Premises in parallel</a> on page 1571</li> </ul> </li> <li>• Enterprise 10 to Automation 360:               <ul style="list-style-type: none"> <li>• <a href="#">Prepare for Enterprise 10 to Automation 360 On-Premises migration</a> on page 1577</li> <li>• Use both Automation 360 On-Premises and Enterprise 10 in parallel: <a href="#">Prepare for migration when using Enterprise 10 and Automation 360 On-Premises in parallel</a> on page 1583</li> </ul> </li> </ul>

#### 4. [Complete the pre-migration tasks.](#)

[Migrate and validate bots](#) on page 1586

## Choose deployment model

The Automation 360 platform is developed on a cloud-native architecture with a single codebase that supports both Cloud and On-Premises deployments. The experience of all the components is the same whether the platform is deployed on Cloud or On-Premises on your own infrastructure, which can be physical servers, your private Cloud, or a public Cloud.

---

**Note:** Migration is available in Automation 360 starting from Build 2079 for On-Premises and from Build 7554 for Cloud deployments.

---

## Deployment models

Automation 360 provides the following deployment models:

### Cloud

Automation 360 Cloud is hosted by Automation Anywhere, providing an easy consumption model of the Automation 360 platform built on a cloud-native architecture. With the Automation 360 Cloud service, the Automation 360 platform, which includes the Automation 360 Control Room and applications (Automation Workspace, IQ Bot, Bot Insight, Automation Co-Pilot, and Discovery

Bot), is hosted by Automation Anywhere and accessed by users through a web browser. The Bot Agent devices where the bots run and execute the automations remain on the customer's infrastructure and securely connect to the Automation 360 Cloud service through HTTPS.

Cloud-enabled

In this deployment model, data is hosted On-Premises. This model is suitable for customers who have to adhere to strict regulatory norms where data sovereignty is mandatory.

On-Premises with packages updates through Cloud

With Automation Anywhere On-Premises with packages updates through Cloud service, all business, personal, and operational data is kept on and deployed from the server on-premises on the customer network.

The following image shows the deployment models for Automation 360:

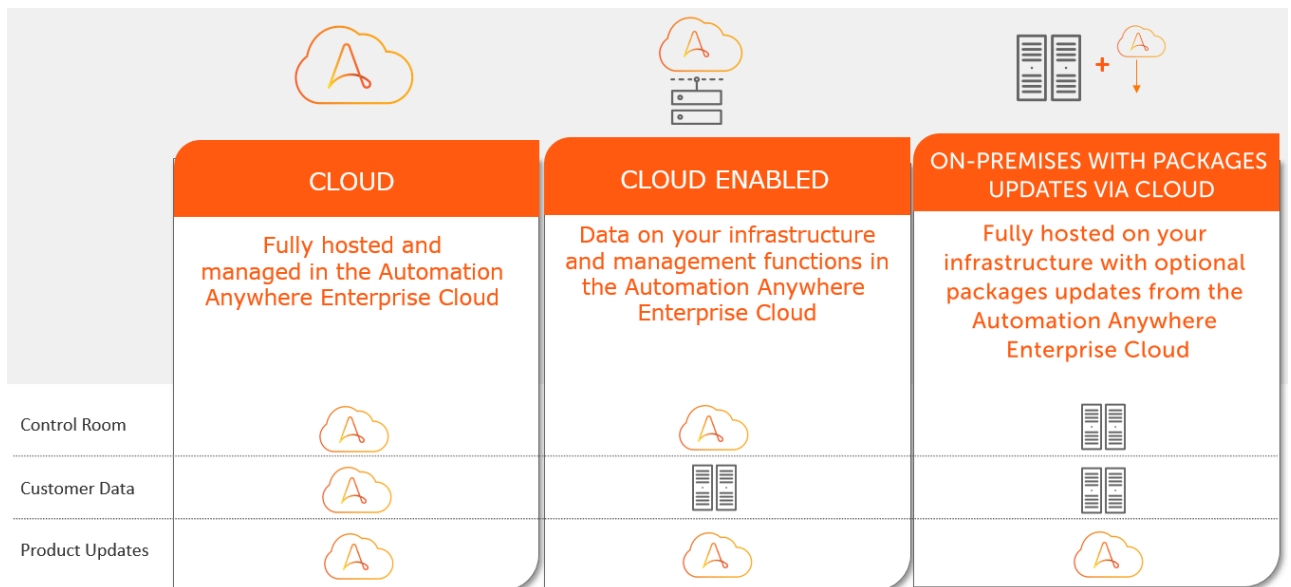

See also [Cloud operational responsibilities](#) on page 1033.

**Important:**

- Irrespective of the deployment model you choose, we recommend that you set up your first Automation 360 instance as a development (Dev) environment.
- We recommend that you have three separate environments for Bot Lifecycle Management: development (Dev), testing (Test or UAT), and production (Prod).
- Setting up a Dev environment during the migration process provides two advantages:
  - A platform to test the migrated Enterprise 11 or Enterprise 10 bots to ensure that they run successfully and provides expected outcomes.

- Access for your developers to the new Automation 360 environment to build new automation simultaneously when migrated bots are being tested.
- 

## Getting ready for Cloud

When you choose an Automation Anywhere Cloud deployment, there is no additional physical server infrastructure to set up for the Control Room. After you have completed your upgrade, you will benefit from automatic updates across your organization and scale easily in the Cloud. As you get started with Automation 360 on Automation Anywhere Cloud, ensure the system and compatibility requirements for running Automation 360:

- [Bot Agent compatibility requirements](#): Bot Agent must be installed on registered devices so users can build and run bots on them.

## Getting ready for Automation 360 Cloud-enabled

When you choose the Cloud-enabled deployment, two instances of Control Room are required: one deployed on Automation Anywhere Cloud and another installed on your own infrastructure. The Control Room deployed on Cloud manages the operational services and the Control Room installed on your infrastructure manages your business and operational data.

- [Bot Agent compatibility requirements](#): Bot Agent must be installed on registered devices so users can build and run bots on them.
- [System requirements](#): Hardware and data center requirements, including server, database, ports, protocols, and more.

## Getting ready for On-Premises (customer's infrastructure)

Install and maintain Automation 360 on your own infrastructure. After you have completed your upgrade, you will benefit from regular updates for packages with new release builds made available to download and install. Ensure you meet the system and setup requirements for Automation 360 On-Premises:

- [Bot Agent compatibility requirements](#): Bot Agent must be installed on registered devices so users can build and run bots on them.
- [System requirements](#): Hardware and data center requirements, including server, database, ports, protocols, and more.

## Prepare for Enterprise 11 to Automation 360 Cloud migration

Perform the tasks in this workflow to migrate from Enterprise 11 to Automation 360 Cloud, including migrating your bots.

Workflow map: You can also view this migration workflow in an interactive visual format by clicking the following schematic



image:

### 1. [Migrating from Enterprise 11 to Automation 360 Cloud](#)

1. Ensure that you have completed the following tasks to check your readiness for migration  
[Check migration readiness](#) on page 1505
2. Ensure you have procured and activated your migration license.  
[Get migration license](#) on page 1545

For information about managing and processing licenses and Cloud services , see [Manage and allocate licenses \(partners\)](#).

### Important:

- We support migration only to an Automation 360 Control Room that is hosted on Amazon Web Services (AWS).
- Migration is performed to a new Cloud Control Room, which will be provisioned during the migration. You cannot reuse an existing Cloud Control Room for the migration.
- Logs and Bot Insight dashboard data are excluded from the upload to the new Cloud Control Room.
- Migrating data from standard Microsoft SQL database deployments is supported. See [Supported Control Room versions for migration](#) on page 1506.
- If Enterprise 11 is configured to use Active Directory or single sign-on (SSO), the authentication type for all migrated users in Automation 360 Cloud is changed to database. The password for all the migrated users is set to null except for the principal administrator.

Login credentials for the principal administrator is shared through email. The principal administrator can change the authentication type for users to SSO before migrating bots.

- Recommended: Create a backup of your data that is not migrated to Automation 360 Cloud such as audit logs and system logs before you decommission your Enterprise 11 instances.

For IQ Bot migration, see [Migrate from Automation 360 IQ Bot On-Premises to Cloud](#) on page 1724.

1. Ensure that all the credential variables used in the Enterprise 11 bots are available in the Enterprise 11 Control Room.
2. Download and install the Cloud Migration Utility.  
[Install Cloud Migration Utility](#) on page 1554
3. Use the utility to upload Enterprise 11 data to Automation Anywhere Cloud.  
[Upload Enterprise 11 data using Cloud Migration Utility](#) on page 1556

[Prerequisite tasks for migrating bots](#) on page 1585

## Recommended workflow for Cloud migration

Review the process of how Enterprise 11 data is migrated to Automation 360 Cloud, particularly when you maintain separate development, testing, and production environments.

---

**Important:** This is the recommended workflow for migrating from Enterprise 11 to Automation 360 Cloud.

---

**Note:** We do not support migration from `Enterprise 11` to `Automation 360 Cloud`. However, you can manually migrate `Enterprise 11` to `Automation 360 Cloud` by using the bot export utility. For assistance, contact `support`.

---

In some scenarios, there might be a separate Enterprise 11 environments for development (Dev), testing (UAT), and production (Prod) based on the requirements and each of these environments might have multiple Control Room instances. The number of Cloud Control Room licenses you request must be the same as the total number of Control Room instances in all of your Enterprise 11 environments. For example, if you have separate environments for Dev, UAT, and Prod, and each of these environments has two Control Room instances, you must request six Cloud Control Room licenses.

When you migrate from Enterprise 11 to Automation 360 Cloud, you must copy all the bots from the production and testing environments to the development environment using Bot Lifecycle Management. This ensures that all new or modified bots available in the production and testing environments are available in the development environment before you start the migration process.

The following image shows the Enterprise 11 to Automation 360 Cloud migration workflow:



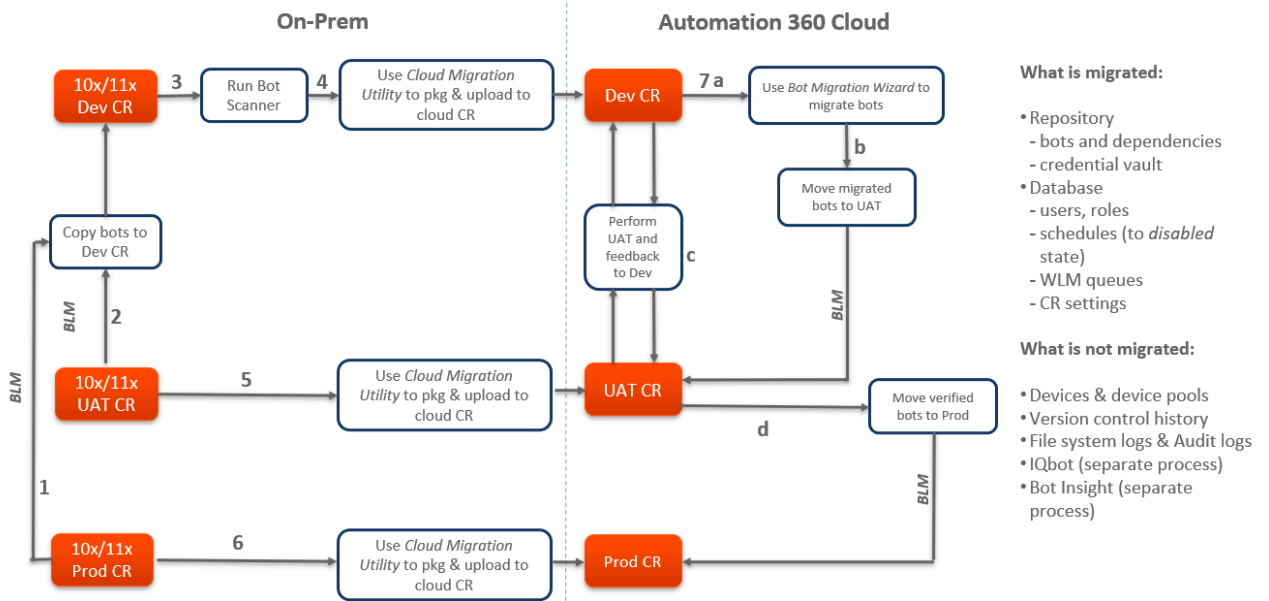

1. Optional: Copy bots from the Enterprise 11 Prod environment to the Dev environment using Bot Lifecycle Management.

[Bot Lifecycle Management - an overview](#)

2. Optional: Copy bots from the Enterprise 11 UAT environment to the Dev environment using Bot Lifecycle Management.

[Bot Lifecycle Management - an overview](#)

3. Analyze your bots and identify commands and variables used in the bots that are supported for migration to Automation 360.

[Scan Enterprise 11 or 10 bots using Bot Scanner](#) on page 1531 | [Analyze Bot Scanner report for migration](#) on page 1534

4. Upload Enterprise 11 data to Dev Cloud Control Room using the Cloud Migration Utility.

[Install Cloud Migration Utility](#) on page 1554 | [Upload Enterprise 11 data using Cloud Migration Utility](#) on page 1556

5. Upload Enterprise 11 data to UAT Cloud Control Room using the Cloud Migration Utility.

6. Upload Enterprise 11 data to Prod Cloud Control Room using the Cloud Migration Utility.

7. Complete the following steps on Automation 360 Cloud Dev environment:

a) Convert the bots (Task Bots and MetaBots) in .atmx and .mbot format to the .bot Automation 360 format using the Bot Migration Wizard.

b) Copy the converted bots to the Automation 360 Cloud UAT environment using Bot Lifecycle Management.

[Bot Lifecycle Management](#) on page 2030

c) Test the converted bots in the Automation 360 Cloud UAT environment.

If any of the migrated bots are not working as expected and require some modification, move such bots to the Automation 360 Cloud Dev environment.

After the bots are modified, move them to Automation 360 Cloud UAT environment for testing. Repeat this process until all of the migrated bots work as expected.

- d) After all the converted bots are tested and work as expected, copy these bots to the Automation 360 Cloud Prod environment.

## Install Cloud Migration Utility

The Cloud Migration Utility enables you to upload all your Enterprise 11 data to Automation Anywhere Cloud. After the data is successfully uploaded to Cloud, the Cloud Control Room is created and all the uploaded data is available for use in that Control Room.

The utility migrates data from Control Room repository (bots, their dependencies, and Credential Vault) and Control Room database (users, roles, schedules, queues, and Control Room settings).

---

**Note:** Migration of Enterprise 11 Control Room data, such as users, roles and credentials, to Automation 360 Cloud on Google Cloud Platform is not supported.

---

Consider the following recommendations:

- Ensure that you install the Cloud Migration Utility on the same application server where the Enterprise 11 Control Room is installed. For Enterprise 11, also ensure that the utility is installed on the same database where the Bot Insight database is hosted.
- If you installed Enterprise 11 in cluster mode, install the migration utility on one of the nodes of the cluster.

---

**Note:** We do not support migration from `to` . However, you can manually migrate `to` by using the bot export utility. For assistance, contact `support`: .

---

1. Download the latest version of the Cloud Migration Utility from the Automation Anywhere support site: [A-People Downloads page \(Login required\)](#).
  - a) In the Automation Anywhere Automation 360 section, click the **Automation Anywhere Enterprise Cloud Migration Utility** link.
  - b) Download the `.zip` file.
2. Extract the `.zip` file and run the `AAE Cloud Migration Utility.exe` file as administrator.
3. On the **Requirement** screen, click **Install**.

The screen lists the applications that are required to install the utility on the machine. The utility installs the required applications; no separate installation is required.
4. On the **Welcome** screen, click **Next**.
5. On the **License Agreement** screen, read and accept the license, and click **Next**.
6. On the **Destination Folder** screen, click **Change** if you want to change the location where you want to install the utility, and click **Next**.
7. On the **Ready to Install the Program** screen, click **Install**.

The **Installing AAE Cloud Migration Utility** screen displays the progress of the installation.
8. On the **Completed** screen, click **Finish**.

For Enterprise 11, [Upload Enterprise 11 data using Cloud Migration Utility](#) on page 1556

## Prerequisites for Cloud migration

After you have installed the Cloud migration utility, you must perform certain tasks before you start uploading data to Automation 360.

Complete the following requirements before you run the Cloud Migration Utility to upload data to Automation 360 Cloud:

- Cloud Migration Utility
  - [Install the Cloud Migration Utility](#)
  - You can migrate only one Control Room at a time. So when you connect to the Control Room, ensure that the installation path, the repository path, and the database details belong to the same Control Room before you run the Cloud Migration Utility.

- Migration code: Ensure you have received an email that contains a migration code. Contact your sales representative to receive the code.

The migration code is valid for one Control Room only. If you have multiple Control Room instances, you will receive an equivalent number of migration codes. Ensure that you use the correct migration code for the migration of a specific Control Room.

---

**Important:** The migration code you receive through email is valid for 30 days from the date it is generated and shared with you. So start the migration before the code expires. Otherwise, you will have to request a new code, which might take a significant amount of time.

---

- Automation Anywhere Cloud customer tenant:
  - The tenant name does not support the underscore ( \_ ) character. So an underscore is used in the tenant name, the specified URL will not be created.
- Port, firewall, internet connection
  - The port that is used to connect to the Enterprise 11 Control Room database must be open and available for the utility.
  - The firewall must be configured to allow the utility to connect to the following for outbound HTTPS traffic over the port 443:
    - <https://aa-provsvc.globalservices.automationanywhere.digital/>
    - <https://aws.amazon.com>
  - Ensure a stable internet connection with sufficient bandwidth to upload the data within 60 minutes. If the upload time exceeds 60 minutes, the Cloud Migration Utility will timeout and you need to start the upload process again.
- Enterprise 11 Control Room
  - We recommend that you plan for some downtime for the Enterprise 11 Control Room or stop all user activities when you use the migration utility.

The downtime is required to ensure that no data is missed when the Cloud Migration Utility is packaging Enterprise 11 data for upload. If downtime is not possible, ensure no user activities are performed on the Enterprise 11 Control Room for the time period when the Cloud Migration Utility is uploading data.

- Control Room: Ensure that the size of the Enterprise 11 repository is less than 20 GB and the Enterprise 11 database is less than 9 GB.

If the size of the repository or database is more than these sizes, contact Automation Anywhere support for assistance.

- Ensure that the credentials you have used to connect with the Enterprise 11 database has db\_owner permission.
- Ensure that the Enterprise 11 repository and database you specify in the Cloud Migration Utility belong to the same Enterprise 11 Control Room.
- Log files: Grant access to the C:\ProgramData\AutomationAnywhere folder for the migration utility to store the log files.
- Credential Vault: Ensure that the Credential Vault mode is set to express mode.
  - This mode ensures that the credentials and variables available within the Enterprise 11 Credential Vault are migrated to the Cloud Control Room.
  - If the Credential Vault mode is set to manual mode in Enterprise 11, the credentials and variables in the Enterprise 11 Credential Vault are not migrated to the Cloud Control Room.

You can change the mode back to manual after the Control Room data is migrated. See [Configure Credential Vault Connection mode](#) on page 1813.

- SSO: If you want to integrate SSO after migrating to Automation 360 Cloud, ensure that the IDs of users in the Enterprise 11 Control Room exactly match the IDs in the SSO database. SSO integration will fail for IDs that do not match.

Related concepts

[Get migration license](#) on page 1545

Migration is offered for free. To migrate to an Automation 360 environment (Cloud or On-Premises), you must request a migration license.

## Upload Enterprise 11 data using Cloud Migration Utility

Use the Cloud Migration Utility to gather Enterprise 11 data and upload it to Automation Anywhere Cloud.

Ensure you have completed all the prerequisites before you start uploading data to Automation 360. See [Prerequisites for Cloud migration](#) on page 1555.

---

**Note:** Stop the Automation Anywhere Control Room Reverse Proxy service.

If Enterprise 11 is installed in a cluster setup, you must stop the Automation Anywhere Control Room Reverse Proxy service on all the nodes in the cluster.

---

**Note:** In Enterprise 11, if the domain name and email address of an Active Directory user match, the same Customer License User (CLU) account is migrated to Automation 360. Else, a new user account is created with the account-level CLU details registered with Automation Anywhere.

- 
1. Run the Cloud Migration Utility as administrator.
  2. Select the **Connect to the internet via proxy** option if you want to connect to the internet using a proxy server, and then click **Get started**.
    - a) Specify the hostname or IP address of the proxy server in the **Proxy hostname/IP address** field.
    - b) Specify the port you want to use to connect to the proxy server in the **Port** field.
    - c) Select the **Authentication** option if the proxy server requires authentication.
    - d) Specify the credentials you want to use for authentication in the **Username** and **Password** fields.

3. On the **Connect to Control Room** screen, enter the following details about the Enterprise 11 environment.

**Important:** These fields are automatically populated with the required values from the Enterprise 11 environment when the Cloud migration utility is run on the same application server where the Enterprise 11 Control Room is installed.

As you can migrate only one Control Room at a time, ensure that the installation path, the repository path, and the database details belong to the same Control Room.

Field	Value
Installation Path	Location where the Control Room is installed. The Installation path value is auto-populated to ensure that the details match with the Control Room database.  <b>Note:</b> Network path is not supported as an Installation Path value.
Repository Path	Location where the Control Room repository is stored.  The Repository Path value is automatically populated and cannot be edited. This is to ensure that the details match those in the Control Room database.
IP address/Hostname	IP address or hostname of the database server.
Port	Port that is used to connect to the database server.
Database Name	Name of the Control Room database that you want to upload.
Secure Connection	Option to use a secure connection to connect with the database.

Field	Value
Authentication	<p>Authentication method that you want to use:</p> <ul style="list-style-type: none"> <li>Windows authentication: Select this option to use Windows authentication for establishing a connection with the database server.</li> </ul> <hr/> <p><b>Note:</b> The user who is logged in to the Enterprise 11 server and is running the Cloud migration utility must be a Windows user administrator with db_owner permission to the Enterprise 11 database.</p> <hr/> <ul style="list-style-type: none"> <li>SQL authentication: Select this option to use database credentials for authentication when establishing a connection with the database server.</li> </ul> <p>If you select this option, provide the credentials you want to use to connect to the database server in the <b>Username</b> and <b>Password</b> fields.</p> <p>The password can contain the following characters:</p> <ul style="list-style-type: none"> <li>Uppercase characters (A–Z)</li> <li>Lowercase characters (a–z)</li> <li>Numerals (0–9)</li> <li>Special characters (\$&amp;#@%!(){}^*_+{} :&lt;&gt;?-=[]\;/)</li> </ul>
Backup Path	Location where you want to store backup of the Enterprise 11 Control Room data.

- Click **Next**.
- On the **Summary** screen, review the information and click **Next**.
- On the **Validate migration code** screen, enter the migration code you received through email and click **Validate**.  
The system validates the migration code you have entered.
- Click **Next**.  
The system extracts the Enterprise 11 data and starts transferring data to Automation Anywhere Cloud.
- Click **Exit**.  
After the data is successfully uploaded, you will receive an email with a link and login credentials to access the Control Room.

See the following video on how to upload Enterprise 11 data using the Cloud Migration Utility:

See the following video on how to verify the Enterprise 11 data in the Cloud Control Room:

[Migrate Enterprise bots](#) on page 1590

## Prepare for migration when using Enterprise 11 and Automation 360 Cloud in parallel

Perform the tasks in this workflow if you want to use both Automation 360 Cloud and Enterprise 11 in parallel. You can continue to use both environments till the time you are ready to start the migration from Enterprise 11 to Automation 360 Cloud.

1. Ensure that you have completed the following tasks to check your readiness for migration  
[Check migration readiness](#) on page 1505.
2. Ensure you have procured and activated your migration license.  
[Get migration license](#) on page 1545

---

### Important:

- Migration is performed to a new Cloud Control Room, which will be provisioned during the migration. You cannot reuse an existing Cloud Control Room for the migration.
- You cannot use the Cloud Migration Utility to upload your data to the Cloud Control Room if you have selected the standard Automation 360 Cloud SKUs when you signed the order form.

If you want to use the Cloud Migration Utility, you must have selected the Automation 360 Cloud migration SKUs when you signed the order form.

- 
1. Ensure that all the credential variables used in the Enterprise 11 bots are available in the Enterprise 11 Control Room.
  2. Download and install the Cloud migration utility.  
[Install Cloud Migration Utility](#) on page 1554
  3. Use the Cloud migration utility to upload Enterprise 11 data to Automation Anywhere Cloud.  
[Upload Enterprise 11 data using Cloud Migration Utility](#) on page 1556
  4. Continue using both Enterprise 11 and Automation 360 environments in parallel.

---

**Note:** Create all new bots and entities such as users, roles, and schedules in Automation 360.

---

5. If you create any new entity such as users, roles, or schedules (except bots) in Enterprise 11 after installing Automation 360, create the same entity in Automation 360.
6. When you are ready to use only Automation 360 as your production environment:
  - a) If you have created new bots in Enterprise 11 data is uploaded in Automation 360 Cloud:
    1. Export all the bots and their dependencies that were created after data was uploaded in Automation 360 Cloud using Bot Lifecycle Management.  
[Export bots](#)
    2. Import all the bots to Automation 360 using Bot Lifecycle Management.  
[Import bots](#) on page 2035

---

**Note:** After migration, if you add any new Bot Insight data or dashboard or modify any existing data in Enterprise 11, these changes are currently not imported to Automation 360 and therefore will not be migrated.

---

[Prerequisite tasks for migrating bots](#) on page 1585

## Prepare to manually migrate to Automation 360 Cloud

You can manually migrate from Enterprise 11 or Enterprise 10 to Automation 360 Cloud (without using the Cloud Migration Utility) by creating users, roles, permissions, and other entities required by the migrated bots to run successfully.

---

**Note:** The only way by which you can migrate from Enterprise 11 or Enterprise 10 to Automation 360 Cloud on Google Cloud Platform is by using the following procedure.

---

1. Ensure that you have completed the following tasks to check your readiness for migration
  - [Check migration readiness](#) on page 1505.
2. Ensure you have procured and activated your migration license.
  - [Get migration license](#) on page 1545

---

**Note:** Use the manual migration in the following scenarios:

- You have an existing Automation 360 Cloud instance and want to migrate your Enterprise 11 data.
- When you want to migrate only bots and re-create all other Enterprise 11 or Enterprise 10 entities such as users, roles, and credentials manually in Automation 360.
- When you want to migrate only a few of the Enterprise 11 or Enterprise 10 entities. For example, if you have 50 users and 10 user-defined roles in Enterprise 11 or Enterprise 10 and you want to migrate only 40 users and 7 roles to Automation 360. Similarly, if you want to migrate only users and roles and want to re-create the required schedules in Automation 360.

---

For information about automated migration to Cloud (using the Cloud Migration Utility), see [Prepare for Enterprise 11 to Automation 360 Cloud migration](#) on page 1551.

1. Create all the Enterprise 11 or Enterprise 10 entities in Automation 360 Cloud. For more information about the entities you must create, see [Prerequisites for manual migration](#) on page 1561.
2. Upload the bots:

Version	Steps
Enterprise 11	<a href="#">Import bots</a> on page 2035



Version	Steps
Enterprise 10	<p><b>a)</b> <a href="#">Upload bot and its dependencies</a> on page 2360</p> <p>The bots are uploaded to the private workspace in Automation 360. Ensure you have created the same folder structure in the public workspace as in Enterprise 10 Control Room.</p> <p>You must upload all dependent bots and other files required by the uploaded bots to run successfully in Automation 360. All uploaded bots, their dependent bots, and other required files must be stored in the same folder in the Automation 360 as in Enterprise 10.</p> <p><b>b)</b> Check in the uploaded bots that are available in the private workspace.</p> <p><a href="#">Check in a bot</a> on page 2301</p>

See the following video on how to manually migrate to Automation 360 using Bot Lifecycle Management:

[Prerequisite tasks for migrating bots](#) on page 1585

### Prerequisites for manual migration

When you migrate from Enterprise 11 or Enterprise 10, if you have not used the Enterprise 11 database or copied Enterprise 10 data, you must manually create all the entities of Enterprise 11 or Enterprise 10 in Automation 360.

Create the following Enterprise 11 or Enterprise 10 entities except bots in Automation 360:

- [Create a user](#) on page 1739
- [Create a role](#) on page 1748
- Credentials and lockers used in bots

[Credentials and lockers in the Credential Vault](#) on page 1861

- AAApplicationPath global value and set its value the same as Enterprise 11 or Enterprise 10 for the required users
- AADefaultDateFormat global value and set its value as MM/DD/YYYY HH:MM:SS.
- The following global values that will be used by the **Send email** action:
  - AAE\_EmailSettings\_auth
  - AAE\_EmailSettings\_host
  - AAE\_EmailSettings\_port
  - AAE\_EmailSettings\_ssl

The values for the preceding global values must be the same as those specified in Enterprise 11 in **Tools > Options > Email Settings**.

You must create the `AAE_EmailSettings_auth` and `AAE_EmailSettings_ssl` global values of type boolean. The value for these must be assigned based on the Enterprise 11 configuration. For example, if the **My server requires authentication** option is selected in Enterprise 11, you must set the `AAE_EmailSettings_auth` value as `true`. Similarly, if the **My server uses a secure connection** option is selected in Enterprise 11, you must set the `AAE_EmailSettings_ssl` value as `true`.

- The following global values if you have used Exchange Web Services (EWS) in Enterprise 11:
  - `AAE_EmailSettings_tenantId`
  - `AAE_EmailSettings_clientId`
  - `AAE_EmailSettings_domainName`
- Create the same folder structure as Enterprise 11 or Enterprise 10 in Automation 360.

---

**Important:** You must create the `MetaBots` folder in the `Bots` folder in Automation 360 even if you do not have any MetaBots in Enterprise 11 or Enterprise 10.

---

- Upload all Enterprise 11 or Enterprise 10 bots and their dependencies to the Automation 360 Control Room.

You must upload the bots and their dependencies at the same location as in Enterprise 11 or Enterprise 10.

- Migrate the bots in the following sequence:
  1. MetaBots
  2. Child bots
  3. Parent or main bots

---

**Important:** You must create all of the preceding entities in Automation 360 the same as how they are available in Enterprise 11 or Enterprise 10.

---

## Prepare for Enterprise 11 to Automation 360 On-Premises migration

Perform the tasks in this workflow to migrate from Enterprise 11 to Automation 360 On-Premises, including migration of your bots to Automation 360. Dashboards created in Bot Insight for Enterprise 11 analytics bots are also migrated.

Workflow map: You can also view this migration workflow in an interactive visual format by clicking the following schematic



image:

### 1. [Migrating from Enterprise 11 to Automation 360 On-Premises](#)

1. Ensure that you have completed the following tasks to check your readiness for migration  
[Check migration readiness](#) on page 1505.
2. Ensure you have procured and activated your migration license.  
[Get migration license](#) on page 1545
3. If you are installing Automation 360 on a machine on which Enterprise 11 was previously installed, you must delete the data from the Elasticsearch data folder located at `C:\ProgramData\elasticsearch\data`.

If the location of the Elasticsearch data folder was changed, you can find the updated information in the `C:\Program Files\Automation Anywhere\Enterprise\elasticsearch\config\elasticsearch.yml` file.

---

**Important:** If you delete the Elasticsearch data, you will lose the Enterprise 11 audit data.

---

**Note:** Install Automation 360 on a separate server to ensure that your Enterprise 11 environment is not impacted by the migration activities.

1. We recommend that you create a backup of the Enterprise 11 database and restore it in the same or different SQL instance to avoid failure of any automation task that is using the Enterprise 11 database.

[Quickstart: Back up and restore a SQL Server database on-premises](#)

Bot Insight migration: The Bot Insight data and dashboards are migrated as part of the overall migration process. For the migration, clone your Bot Insight database (which is different from

your Enterprise 11 Control Room database) and extract and export your dashboard metadata to Automation 360 using the Bot Insight pre-migration utility.

[Export Enterprise 11 Bot Insight dashboards for migration](#) on page 1568

The following video shows how to create a backup of the Enterprise 11 database:

2. If you are migrating from Version 11.3.x or later versions, delete data from the `ES_SETTINGS` table from the Enterprise 11 Control Room database.
3. Copy and paste the Enterprise 11 Control Room repository and update the Enterprise 11 database with the Automation 360 repository path.  
[Copy and paste Enterprise 11 information to Automation 360](#) on page 1565
4. Ensure that all the credential variables used in the Enterprise 11 bots are available in the Enterprise 11 Control Room.
5. Install Automation 360 On-Premises:
  - a) Ensure you meet the system requirements.  
[Automation 360 On-Premises prerequisites](#) on page 1180
  - b) Install Automation 360 On-Premises Control Room in custom mode to a staging environment.  
[Installing Control Room using Custom mode](#) on page 1245

---

**Important:** During the installation, configure the Automation 360 On-Premises Control Room to use the restored Enterprise 11 database. This ensures that all your Enterprise 11 data is available in Automation 360 as is. For information on what is migrated and not migrated, see [What is migrated and not migrated](#) on page 1498.

---

6. After installing the Automation 360 On-Premises, update Automation 360 access URL in the restored Enterprise 11 Control Room database. This access URL will be used to access the Control Room in Automation 360.

To update the access URL: update CONFIGURATION set value = '[Automation 360 Control Room URL]' where category = 'CR\_setup\_general' and config\_key = 'AccessUrl'

Example query: update [Automation 360-Database].[dbo].[CONFIGURATION] set value = 'http://Automation 360-crurl.com' where config\_key='AccessUrl'

---

**Note:** Do not include a slash ('/') at the end of the access URL that you provide in the above command.

---

7. Verify that all the data you pasted is available in the relevant files and folders.
8. Optional: Migrate audit log data.

[Migrate Enterprise 11 audit logs](#) on page 1569

To learn more, search for the Migrating from enterprise 11 to Automation 360 On-Premises course in [Automation Anywhere University: RPA Training and Certification \(A-People login required\)](#).

[Prerequisite tasks for migrating bots](#) on page 1585

Related tasks

[Prepare for Enterprise 10 to Automation 360 On-Premises migration](#) on page 1577

Perform the tasks in this workflow to migrate from Enterprise 10 to Automation 360 On-Premises, including migration of your bots to Automation 360.

## Back up and restore Enterprise 11 or Enterprise 10 database

Before you start migration, back up and restore your Enterprise 11 or Enterprise 10 database.

[Quickstart: Back up and restore a SQL Server database on-premises.](#)

## Copy and paste Enterprise 11 information to Automation 360

The Enterprise 11 server repository files and the Credential Vault file are required in the Automation 360 environment. The most efficient way to get this data is to copy it from the Enterprise 11 environment into Automation 360.

You must copy the necessary files from Enterprise 11 data and paste it before installing Automation 360. You must also run the queries to update the Control Room access URL and repository path.

To learn more about how to migrate to Automation 360, search for the following courses in [Automation Anywhere University: RPA Training and Certification \(A-People login required\)](#):

- Migrating from Enterprise 11 to Automation 360 On-Premises
- Migrating from Enterprise 10 to Automation 360 On-Premises

### 1. Copy and paste the Enterprise 11 repository data.

The location of the Enterprise 11 repository is available from **Administration > Settings > General** in the Enterprise 11 Control Room.

See [Configuration settings](#) .

---

### Remember:

- If the Enterprise 11 Credential Vault is configured in **Manual** mode, copy the file containing the **Master Key** of the Credential Vault that is stored at a secured location. The **Master Key** is required when you log in to Automation 360 for the first time after migrating from Enterprise 11 using the restored Enterprise 11 database.
- If your Enterprise 11 Control Room has version control enabled, the latest versions of each bot, including the dependencies, are copied and migrated from the Enterprise 11 repository to Automation 360. However, the version history of the bot and its dependencies are not copied and migrated.
- If you want to set up a cluster configuration in Automation 360, you must paste the copied Enterprise 11 data on a shared network location that all the nodes can access in the cluster.
- If you are using NAS to store Enterprise 11 repository data and your Automation 360 repository data is on local drive, the process of copying Enterprise 11 data from NAS to Automation 360 local drive remains the same.

---

### a) Create the following folder structure at any location on the device if it does not already exist.

For example, `C:\ProgramData\AutomationAnywhere\Server Files`

---

### Note:

- If you want to set up a cluster configuration in Automation 360, you must paste the copied Enterprise 11 data on a shared network location that all the nodes can access in the cluster.

- If your Enterprise 11 database is stored in NAS storage and you want to migrate to your Automation 360 local drive, the process of copy and paste is same.

- b)** Create the following folders within the Server Files folder you have created in Step a:  
 Default\0\Automation Anywhere\Bots
- Based on the folders you created in the previous step, the final folder structure must be:  
 C:\ProgramData\AutomationAnywhere\Server Files\Default\0\Automation Anywhere\Bots

The C:\ProgramData\AutomationAnywhere\Server Files in the folder structure is the dynamic path, which can be any location based on your requirement. Whereas the Default\0\Automation Anywhere\Bots is a constant path that does not change.

**Note:** This path is not a temporary path for migration but will be used to store all the bots and packages.

- c)** Copy and paste the Enterprise 11 CredentialVault.dat file and the folders that contain bots and MetaBots in the folder structure you have created in the previous step.

Enterprise 11 files and folders to be copied	Enterprise 11 location	Automation 360 location
CredentialVault.dat file	AutomationAnywhere\Server Files	AutomationAnywhere\Server Files
	The CredentialVault.dat file is available at this location only if the Enterprise 11 Credential Vault is configured in <b>Express</b> mode.	
All the files and folder including My Tasks and My MetaBots folders	\AutomationAnywhere\AutomationAnywhere\Server Files\Default\Automation Anywhere\	\AutomationAnywhere\AutomationAnywhere\Server Files\Default\Automation Anywhere\Bots\

- a)** Create a folder for Automation 360 at any location on the device.  
 For example, D:\New project\Automation 360.

**Notes:**

- If you want to set up a cluster configuration in Automation 360, you must paste the copied Enterprise 11 data on a shared network location that all the nodes can access in the cluster.
- If your Enterprise 11 database is stored in NAS storage and you want to migrate to your Automation 360 local drive, the process of copy and paste is same.

- b) Create the following folders within the Automation 360 folder you have created in the previous step: AutomationAnywhere\Server Files\Default\0\Automation Anywhere\Bots

Based on the folders you created in the previous step, the final folder structure must be: D:\New project\Automation 360\AutomationAnywhere\Server Files\Default\0\Automation Anywhere\Bots

The D:\New project\Automation 360 in the folder structure is the dynamic path, which can be any location based on your requirement. Whereas the AutomationAnywhere\Server Files\Default\0\Automation Anywhere\Bots is a constant path that does not change.

- c) Copy and paste the Enterprise 11 CredentialVault.dat file and the folders that contain bots and MetaBots in the folder structure you have created in the previous step.

Enterprise 11 files and folders to be copied	Enterprise 11 location	Automation 360 location
CredentialVault.dat file	AutomationAnywhere\Server Files	AutomationAnywhere\Server Files
	The CredentialVault.dat file is available at this location only if the Enterprise 11 Credential Vault is configured in <b>Express</b> mode.	
All the files and folder including My Tasks and My MetaBots folders	\AutomationAnywhere\AutomationAnywhere\Server Files\Default\Automation Anywhere\	\AutomationAnywhere\AutomationAnywhere\Server Files\Default\0\Automation Anywhere\Bots\

See the following video on how to create the Enterprise 11 Control Room repository in the Automation 360 server:

You must perform the following step (Step 2) on the Enterprise 11 restored database that you backed up as part of Step 1 in [Prepare for migration](#).

- 2. Update the Automation 360 repository path in the restored Enterprise 11 database by running the following SQL command:

To update the repository path, update CONFIGURATION set value = Automation 360 Control Room dynamic path followed by \AutomationAnywhere\Server Files where category = 'CR\_setup\_general' and config\_key = 'RepositoryPath'

The dynamic path in the query is the dynamic path where you have pasted the copied Enterprise 11 data in the above step.

Example query: update [Automation 360-Database].[dbo].[CONFIGURATION] set value = 'C:\ProgramData\AutomationAnywhere\Server Files' where config\_key='RepositoryPath'

The path mentioned in the query is the same as the dynamic path where the Enterprise 11 data is copied in the example in the previous step.

See the following video on how to restore a backed-up Enterprise 11 database:

Complete the steps listed in [Prepare for Enterprise 11 to Automation 360 On-Premises migration](#) on page 1563.

## Export Enterprise 11 Bot Insight dashboards for migration

Use the Bot Insight pre-migration utility to export your Enterprise 11 Bot Insight dashboard metadata (widgets and layouts) and dashboard profile as a zip file. Run this utility in your Enterprise 11 device and paste the zip file in the Automation 360 repository to migrate the Bot Insight dashboards.

- Back up the Bot Insight database after you have backed up the Enterprise 11 Control Room database and restore it in the SQL Server instance. Ensure the following when you restore the Bot Insight database:
  - Use the same username and password of the Control Room database used in Automation 360.
  - The name of the Bot Insight database that you are restoring in Automation 360 environment is the same as the Enterprise 11 Bot Insight backed up database.
- Ensure that JRE is installed in the Enterprise 11 device.

---

**Important:** Migration of Bot Insight is supported only if the database is installed on Microsoft SQL Server or if the Metadatabase is installed on either Microsoft SQL Server or PostgreSQL Server. Bot Insight migration is not supported if the database is installed on PostgreSQL Server.

---

**Note:** After data is migrated from Enterprise 11 to Automation 360, ensure that the end-to-end migration activity is completed within 90 days from the first day of data migration. After 90 days, the Bot Insight analytical data will be deleted.

---

1. Download the latest version of the Bot Insight pre-migration utility from the Automation Anywhere Support site.

---

**Important:** You must download the utility on the device on which the Enterprise 11 Control Room is installed.

---

- a) Navigate to the Automation Anywhere Downloads page: [A-People Downloads page \(Login required\)](#).
- b) Click the **Automation 360** download link.
- c) Open the **Installation Setup** folder and download the `AAE_Export_BI_Dashboards_<version_number>.jar` file, for example, `AAE_Export_BI_Dashboards_A360.23.jar`.

See the following video on how to download the pre-migration utility:

2. Run the utility in the Enterprise 11 device.
  - a) Open the Windows command prompt.
  - b) Run the following command to export the Bot Insight dashboards to a zip file: `java -jar "<path_of_downloaded_utility_jar>/AAE_Export_BI_Dashboards_<version_number>.jar" -installationPath "<installation_path>/Enterprise" -outputDir "<path_to_save_zip_file>/dashboards"`



```
For example: java -jar "Downloads/  
AAE_Export_BI_Dashboards_A360.23.jar " -installationPath "C:/  
Program Files/Automation Anywhere/Enterprise" -outputDir "E:/AA/  
work/release/A360/migration/dashboard"
```

The utility generates the `dashboards.zip` file at the output directory you specified.

---

**Note:** You can also use double backslash (`\\`) to run the JAR file.

---

3. Create the `bot-insight` folder at the Automation 360 installation location.  
For example, `C:\Program Data\Automation Anywhere\Server Files\bot-insight`  
  
In this path, `C:\Program Data\Automation Anywhere\Server Files` is a dynamic path, which can be any location based on your requirement. The folder structure following the dynamic path (`\bot-insight`) is a constant path that does not change.
4. Copy the `dashboards.zip` file available at the output location and paste in the `Server Files\bot-insight` folder.

After exporting dashboards in the Automation 360 repository, do the following for migrating the Bot Insight dashboards.

1. Install Automation 360 and log in to your Automation 360 staging environment.  
[Installing Control Room On-Premises](#) on page 1177
2. Migrate the bots along with the Bot Insight data and dashboards using the Bot Migration Wizard.  
[Migrate Enterprise bots](#) on page 1590

See the following video on how to prepare Bot Insight data for migration:

## Migrate Enterprise 11 audit logs

The audit log export utility enables you to export the audit log data from the Enterprise 11 Control Room to a JSON file. You must paste the JSON file in the Automation 360 repository and then migrate the audit log data.

---

**Note:** Migration of audit logs from Enterprise 11 to Automation 360 is supported only for On-Premises deployments.

---

Ensure you have the **AAE\_Admin** role or the **Manage Migration** permission.

- Starting with Automation 360 v.23, you can migrate audit log data of Version 11.3.5 or later versions.
- The audit log export utility exports information about all Enterprise 11 log events, including those that are currently not supported in Automation 360 such as multi-factor authentication (MFA) and run bots through command line.

Based on the current version of your Control Room, choose one of the following ways to export and migrate the audit log data:

- For Version 11.3 and later:
  - a) Download the latest version of the audit log export utility from the Automation Anywhere Support site.

**Important:** You must download the utility on the machine on which the Version 11.3 Control Room is installed. If the Control Room is installed in **Cluster mode**, you can download the utility on any of the node available in the cluster.

---

- a) Navigate to the Automation Anywhere Downloads page: [A-People Downloads page \(Login required\)](#).
  - b) Click the Automation 360 link.
  - c) Click **Installation Setup**, and then click `AAE_Export_Audit_Log_v3.zip` file..
- 
- b) Extract the files from the zip file you have downloaded.
  - c) Open the Windows command prompt.
  - d) Change the working directory to `AAE_Export_Audit_Log_v3` and enter the following command:  

```
bin\java -jar AAE_Export_Audit_Log_v3.jar  
export.path="OUTPUT LOCATION" cr.version="CONTROL ROOM VERSION"  
install.path="CONTROL ROOM INSTALLATION PATH"
```

Update the following values in the command:
    - **OUTPUT LOCATION:** Replace the text with the location where you want to save the output.
      - Ensure that the folders mentioned in the location exist.
      - Ensure that you specify the location of the output folder in double quotation marks.
    - **CONTROL ROOM VERSION:** Replace the text with the current version of the Enterprise 11 Control Room that is installed. The `cr.version` value is the first three digits of the Enterprise 11 Control Room. For example, if the Control Room is Version 11.3.4.4, enter the `cr.version` value as 11.3.4.
    - **CONTROL ROOM INSTALLATION PATH:** Replace the text with the full path of the location where the Control Room is installed. For example, `C:\Program Files\Automation Anywhere\Enterprise`.

Command example: 

```
bin\java -jar AAE_Export_Audit_Log_v3.jar  
export.path="C:\Migration\Audit Log" cr.version="11.3.2"  
install.path="C:\Program Files\Automation Anywhere\Enterprise"
```

The utility generates the `es_export.json` file at the output location you specified. The generated JSON file contains a maximum of 10000 records. If there are more than 10000 records available in the audit data, the utility generates multiple JSON files at the same location and adds a suffix such as `es_export_1`.
- e) Create the `migration\es-data` folders in the Automation 360 repository.
  - f) Copy the JSON file available at the output location.  
If the utility has generated multiple JSON files, you must copy all the files.
  - g) Paste the JSON file in the `Server Files\migration\es-data` folder.  
See the following video on exporting 11.3.x audit log data for migration:
  - h) Log in to your Automation 360 staging environment.
  - i) Go to **Administration > Migration**.
  - j) Click **Migrate Audit log** from the **Migrate bots** menu on the top-right of the screen.
-

The system starts retrieving and migrating the audit log data from the `es_export.json` file and uploading it to Automation 360 Elasticsearch. The entries are displayed in the **Audit Log** tab of Automation 360.

After the Audit log migration is complete, navigate to **Administration > Migration** page to view the status of the audit log migration and other related information. You can also filter the audit log migration results based on the migration **Type** as the **Audit log migration**.

Click the **View migration** option for each audit migration instance to see additional information such as the audit log file path and the reasons why individual `es_export.json` files were skipped or were not successfully migrated when migrating the audit logs.

[View migration reports](#) on page 1675

- For version 11.2 and earlier:
  - a) Log in to your Automation 360 staging environment.
  - b) Go to **Administration > Migration**.
  - c) Click **Migrate Audit data** from the **Migrate bots** menu on the top-right of the screen. The system starts retrieving and migrating the audit data from the database and uploading it to the Automation 360 Elasticsearch. The entries are displayed in the **Audit Log** tab of Automation 360.

See the following video on migrating Enterprise 11 audit log data:

Related tasks

[View migration reports](#) on page 1675

Use the reports to analyze the status of individual bot migration, data migration, and audit log migration and identify the status and summary of the individual migration.

## Prepare for migration when using Enterprise 11 and Automation 360 On-Premises in parallel

Perform the tasks in this workflow if you want to use both Automation 360 On-Premises and Enterprise 11 in parallel. You can continue to use both environments till the time you are ready to start the migration from Enterprise 11 to Automation 360 On-Premises.

1. Ensure that you have completed the following tasks to check your readiness for migration
  - [Check migration readiness](#) on page 1505.
2. Ensure you have procured and activated your migration license.
  - [Get migration license](#) on page 1545
3. If you are installing Automation 360 on a machine on which Enterprise 11 was previously installed, you must delete the data from the Elasticsearch data folder located at `C:\ProgramData\elasticsearch\data`.

If the location of the Elasticsearch data folder was changed, you can find the updated information in the `C:\Program Files\Automation Anywhere\Enterprise\elasticsearch\config\elasticsearch.yml` file.

---

**Important:** If you delete the Elasticsearch data, you will lose the Enterprise 11 audit data.

---

**Note:** Install Automation 360 on a separate server to ensure that your Enterprise 11 environment is not impacted by the migration activities.

---

1. We recommend that you create a backup of the Enterprise 11 database and restore it in the same or different SQL instance to avoid failure of any automation task that is using the Enterprise 11 database.

[Quickstart: Back up and restore a SQL Server database on-premises](#)

Bot Insight migration: The Bot Insight data and dashboards are migrated as part of the overall migration process. For the migration, clone your Bot Insight database (which is different from your Enterprise 11 Control Room database) and extract and export your dashboard metadata to Automation 360 using the Bot Insight pre-migration utility.

[Export Enterprise 11 Bot Insight dashboards for migration](#) on page 1568

2. If you are migrating from Version 11.3.x or later versions, delete data from the `ES_SETTINGS` table from the Enterprise 11 Control Room database.
3. Copy and paste the Enterprise 11 Control Room repository and update access URL and repository path.
4. Ensure that all the credential variables used in the Enterprise 11 bots are available in the Enterprise 11 Control Room.
5. Install Automation 360 On-Premises:

- a) Ensure you meet the system requirements.

[Automation 360 On-Premises prerequisites](#) on page 1180

- b) Install Automation 360 On-Premises Control Room in custom mode to a staging environment.

[Installing Control Room using Custom mode](#) on page 1245

---

**Important:** During the installation, configure the Automation 360 On-Premises Control Room to use the restored Enterprise 11 database.

---

6. Continue using both Enterprise 11 and Automation 360 environments in parallel.
- 

**Note:** Create all new bots and entities such as users, roles, and schedules in Automation 360.

---

7. If you create any new entity such as users, roles, or schedules (except bots) in Enterprise 11 after installing Automation 360, create the same entity in Automation 360.
  8. When you are ready to use only Automation 360 as your production environment:
    - a) If you have created new bots in Enterprise 11 after installing Automation 360:
      1. Export all the bots and their dependencies that were created after Automation 360 was installed using Bot Lifecycle Management.  
[Export bots](#)
      2. Import all the bots to Automation 360 using Bot Lifecycle Management.  
[Import bots](#) on page 2035
  9. Optional: Migrate audit log data.
-

[Migrate Enterprise 11 audit logs](#) on page 1569

[Prerequisite tasks for migrating bots](#) on page 1585

## How workload management data is migrated

Enterprise 11 workload management data is automatically migrated to Automation 360 when you install Automation 360 and point the Control Room to the restored Enterprise 11 database.

When you migrate workload management data to Automation 360, all related workload management is moved to the Automation 360 environment, including queues, device pools, owners, and consumers. Migrated device pools are empty because the migration process does not migrate devices. You must update the device pool with the relevant unattended Bot Runner devices.

---

**Note:** Bots that are deleted in the workload management automation records are skipped during migration. These bots are displayed as **N/A** in the workload queues.

---

Bots associated with a workload template are migrated to the same Automation 360 template with all information intact.

The following work item variables are supported for migration:

- `$WorkItem$` – How this variable is migrated depends on the String, Number, and DateTime type associated with it.

[Variable mapping for migration](#) on page 1655

- `$WorkItemResult$` – Bots using this variable must be associated with a workload template in Enterprise 11 if you want to use it after migration. If you migrate a bot that has the `$WorkItemResult$` variable in a command and the bot is not linked to a workload template, then the command shows an error when it is opened in the Bot editor in Automation 360.

The following work item variable operations are not yet supported and bots using these variable operations cannot be migrated successfully:

- Reset `$WorkItem$`
- Reset `$WorkItemResult$`

Related tasks

[Edit device pools](#) on page 1885

As a Control Room user with device pool management privileges or as a device pool owner, you can edit device pool details to customize your automation requirements.

[Use Work Item variables](#) on page 2343

You can use the Work Item variables to pass the Work Item attributes or values to the Task Bot from the Control Room when you run the bot with the option **Run bot with queue**.

## Prepare to manually migrate to Automation 360 On-Premises

You can manually migrate from Enterprise 11 to Automation 360 On-Premises by creating users, roles, permissions, and other entities required by the migrated bots to run successfully.

1. Ensure that you have completed the following tasks to check your readiness for migration

[Check migration readiness](#) on page 1505

2. Ensure you have procured and activated your migration license.

[Get migration license](#) on page 1545

---

**Note:** Use the manual migration in the following scenarios:

- You have an existing Automation 360 On-Premises instance and want to migrate your Enterprise 11 data.
- When you want to migrate only bots and re-create all other Enterprise 11 entities such as users, roles, and credentials manually in Automation 360.
- When you want to migrate only a few of the Enterprise 11 entities. For example, if you have 50 users and 10 user-defined roles in Enterprise 11 and you want to migrate only 40 users and 7 roles to Automation 360. Similarly, if you want to migrate only users and roles and want to re-create the required schedules in Automation 360.
- When you want to migrate Enterprise 11 entities to Automation 360 using a freshly installed database and server.

- 
1. Install Automation 360 On-Premises:
    - a) Ensure you meet the system requirements.  
[Automation 360 On-Premises prerequisites](#) on page 1180
    - b) Install Automation 360 On-Premises Control Room in custom mode to a staging environment.  
[Installing Control Room using Custom mode](#) on page 1245

---

**Important:** You must install Automation 360 with a new database.

---

2. Create all the Enterprise 11 entities in Automation 360 On-Premises.  
For more information about the entities you must create, see [Prerequisites for manual migration](#) on page 1561.
3. Export all the bots and their dependencies that were created after Automation 360 was installed using Bot Lifecycle Management.  
[Export bots](#)
4. Upload the bots to Automation 360 On-Premises.  
[Import bots](#) on page 2035

[Prerequisite tasks for migrating bots](#) on page 1585

## Prepare for Enterprise 11 to Automation 360 Cloud-enabled migration

Perform the tasks in this workflow to migrate from Enterprise 11 to Automation 360 Cloud enabled, including migration of your bots.

If you are installing Automation 360 on a machine on which Enterprise 11 was previously installed, we recommend you delete the data from the Elasticsearch data folder located at `C:\ProgramData\elasticsearchdata`.

**Note:** If the location of the Elasticsearch data folder was changed, you can find the updated information in the C:\Program Files\Automation Anywhere\Enterprise\elasticsearch\config\elasticsearch.yml file.

---

1. Ensure that you have completed the following tasks to check your readiness for migration  
[Check migration readiness](#) on page 1505.
2. Ensure you have procured and activated your migration license.  
[Get migration license](#) on page 1545
1. Install the Automation 360 for Cloud enabled deployment.  
[Installing Control Room for Cloud-enabled deployment](#) on page 1369
2. Create all the entities such as users, roles, and credentials except bots in Automation 360 the same as how they are available in Enterprise 11.  
[Prerequisites for manual migration](#) on page 1561
3. Export all Enterprise 11 bots and their dependencies that you want to migrate to Automation 360 using Bot Lifecycle Management.  
[Export bots](#)
4. Import all Enterprise 11 bots to Automation 360 using Bot Lifecycle Management.  
[Import bots](#) on page 2035
5. Optional: Migrate audit log data.  
[Migrate Enterprise 11 audit logs](#) on page 1569

[Prerequisite tasks for migrating bots](#) on page 1585

## Prepare for Enterprise 11 to Automation 360 on Linux CentOS migration

Perform the tasks in this workflow to migrate from Enterprise 11 to Automation 360 On-Premises on Linux CentOS, including migrating your bots to Automation 360. If the Enterprise 11 bot is enabled for analytics, the associated Bot Insight data and business analytics dashboard are also migrated.

---

**Note:** Create a new environment for migrating to Automation 360 to avoid any issues to your existing bots due to migration activities.

---

1. We recommend that you create a backup of the Enterprise 11 database and restore it in the same or different SQL instance to avoid failure of any automation task that is using the Enterprise 11 database.  
[Quickstart: Back up and restore a SQL Server database on-premises](#)
2. If you are migrating from Version 11.3.5 or later versions, you must delete data from the ES\_SETTINGS table from the Enterprise 11 Control Room database.
3. Ensure that all the credential variables used in the Enterprise 11 bots are available in the Enterprise 11 Control Room.
4. Copy and paste the Enterprise 11 Control Room repository:
  - a) Use the `sudo mkdir -p /opt/automationanywhere/enterprise/appdata/` command to create the required Automation 360 folders.





## Prepare for Enterprise 10 to Automation 360 On-Premises migration

Perform the tasks in this workflow to migrate from Enterprise 10 to Automation 360 On-Premises, including migration of your bots to Automation 360.

Workflow map: You can also view this migration workflow in an interactive visual format by clicking the following schematic



image:

### 1. [Migrating from Enterprise 10 to Automation 360 On-Premises](#)

1. Ensure that you have completed the following tasks to check your readiness for migration  
[Check migration readiness](#) on page 1505.
2. Ensure you have procured and activated your migration license.  
[Get migration license](#) on page 1545

---

**Note:** Install Automation 360 on a separate server to ensure that your Enterprise 10 environment is not impacted by the migration activities.

---

1. We recommend that you create a backup of the Enterprise 10 database and restore it in the same or different SQL instance to avoid failure of any automation task that is using the Enterprise 10 database.  
[Quickstart: Back up and restore a SQL Server database on-premises](#)
2. Ensure that all the credential variables used in the Enterprise 10 bots are available in the Enterprise 10 Control Room.
3. Install Automation 360 On-Premises:
  - a) Ensure you meet the system requirements.  
[Automation 360 On-Premises prerequisites](#) on page 1180
  - b) Install Automation 360 On-Premises Control Room in custom mode to a staging environment.  
[Installing Control Room using Custom mode](#) on page 1245

---

**Important:** You must install Automation 360 with a new database.

---

- c) Configure the same authentication in Automation 360 as in Enterprise 10.

Do not switch authentication types between Enterprise 10 and Automation 360. For example, if Active Directory is set as authentication in Enterprise 10, you must configure Active Directory as authentication in Automation 360 as well.

4. Copy the Enterprise 10 data to Automation 360.  
[Copy Enterprise 10 data](#) on page 1581
5. Create the **AAApplicationPath** global value in Automation 360 and set the same value as Enterprise 10.  
[Migrating from Enterprise 10](#) on page 1608
6. Complete the pre-migration tasks.  
[Pre-migration tasks](#)

[Migrate Enterprise bots](#) on page 1590

### How Enterprise 10 data is copied to Automation 360

Enterprise 10 users, roles, licenses, credentials, bots, and schedules are copied to Automation 360 as part of the copy data process.

The system copies Enterprise 10 data in the following order:

1. Roles
2. Users
3. Credentials
4. Bots
5. Schedules

If the copy process skips an item in the sequence for any reason, then all related items are also skipped and are not migrated. For example, if the Bot\_Manager role is not migrated and the user Jane\_Smith belongs only to that role, then that user account and any credentials, bots, or schedules associated with that role are also not migrated.

Enterprise 10 items	How Enterprise 10 items are copied to Automation 360
Users	<p>When you copy Enterprise 10 users the first time, if the system encounters a user of the same name in Automation 360, the migration process renames the Enterprise 10 username by adding a suffix such as _1, _2, and so on, and then copies the renamed user to Automation 360. For example, a duplicate username Jane_Smith is renamed as Jane_Smith_1 in Automation 360. Subsequent data copy operations will skip the previously migrated user data.</p> <p>For Active Directory users, the system does not migrate duplicate users. If a domain user with the same name already exists in Automation 360, the migration process skips that user and its dependencies.</p>

Enterprise 10 items	How Enterprise 10 items are copied to Automation 360
Roles	<p>The first time you copy Enterprise 10 roles, the migration process handles duplicate system roles and custom roles differently. The migration process maps Enterprise 10 system roles to Automation 360 system roles. For example, the Enterprise 10 Admin role and Basic role are mapped to the AAE_Admin role and AAE_Basic role, respectively.</p> <p>If a custom role of the same name exists in Enterprise 10 and Automation 360, the migration process renames it by adding a suffix such as _1, _2, and so on, and then copies the renamed role to Automation 360. For example, a duplicate Sales_Operations role is renamed as Sales_Operations_1 in Automation 360.</p> <p>Subsequent data copy operations will skip previously migrated roles.</p>
Licenses	<p>The migration process automatically migrates user allocated licenses, but they are not shown in the migration report. If the Automation 360 Control Room has fewer Bot Creator or Bot Runner licenses than Enterprise 10 Control Room and all Automation 360 licenses have been consumed, then newly migrated users will not be allocated any licenses. The system migrates these users and the related data without allocating any new licenses.</p>

Enterprise 10 items	How Enterprise 10 items are copied to Automation 360
Credentials	<p>For system credentials associated with a migrated user, the system migrates only the Email Settings and Autologin Settings system credentials.</p> <p>For credentials created by the Control Room administrator, the system creates the <b>AAE_10x_Credentials</b> locker in the Automation 360 Credential Vault and adds the credentials from Enterprise 10 as standard credentials. The system assigns the user who migrates the Enterprise 10 data as the owner of the <b>AAE_10x_Credentials</b> locker and all custom roles as consumers of the locker. If a locker with the name <b>AAE_10x_Credentials</b> already exists in Automation 360, the system adds the migrated credentials in that locker.</p> <hr/> <p><b>Note:</b></p> <ul style="list-style-type: none"> <li>• Migration of credentials with more than 50 attributes is not supported.</li> <li>• Users with only <b>AAE_Basic</b> role assigned to them in Enterprise 10 must be granted a custom role in Automation 360 to be a consumer of the <b>AAE_10x_Credential</b> locker.</li> </ul> <hr/> <p>For MetaBots that contain screens as assets and use password type variables in these screens, equivalent credential type variables are created in Automation 360. If the password type variable in the MetaBot is an input variable and a value to that variable is passed from the parent bot in Enterprise 10, complete the following steps before you run the migrated bots:</p> <ol style="list-style-type: none"> <li><b>1.</b> Create the credential with the <b>Standard</b> option selected as input.</li> <li><b>2.</b> Create a locker and use the credential you created in the previous step in that locker.</li> <li><b>3.</b> In the migrated parent bot, use the credential you created to pass that credential to the child bots.</li> </ol> <p>If you have used an array variable within a loop to pass multiple values to the password type variable used in the MetaBot, the migrated bot uses the credential you created to pass a single value.</p>

Enterprise 10 items	How Enterprise 10 items are copied to Automation 360
Bots	<p>If a bot of the same name exists in Enterprise 10 and Automation 360, the copy data process skips the bot migration and its associated schedule. Commands that use credential variables in Enterprise 10 bots use the <b>AAE_10x_Credentials</b> locker after migration.</p> <p>If your Enterprise 10 Control Room is configured with SVN version control, then the copy data process also copies the latest version of each bot including the dependencies from the Enterprise 10 repository to the Automation 360 repository. Use the bot migration wizard to migrate the Enterprise 10 bots to Automation 360. However, the version history of the bot and its dependencies are not copied and migrated.</p> <hr/> <p><b>Note:</b> Migration of the production version of Enterprise 10 bots is currently not supported. As a workaround, make or set the current production version of the bots as the latest version and then migrate the bots.</p> <hr/>
Schedules	<p>If duplicate schedules exist in both environments, the duplicate schedule is migrated and results in two schedules of the same name in Automation 360.</p> <p>Migration of schedules fails if the associated user does not exist in Automation 360.</p>

See the following video on how to review the copied Enterprise 10 data in Automation 360:

Related tasks

[Copy Enterprise 10 data](#) on page 1581

You must copy the Enterprise 10 data to Automation 360 before you convert the Enterprise 10 bots.

[Enable schedules after migration](#) on page 1616

When you copy Enterprise 10 data to Automation 360, the Enterprise 10 schedules are migrated. Version Enterprise 11 schedules are migrated when you update the Enterprise 11 data to Automation 360.

## Copy Enterprise 10 data

You must copy the Enterprise 10 data to Automation 360 before you convert the Enterprise 10 bots.

The user performing this task must have the **AAE\_Admin** role.

1. Log in to your Automation 360 staging environment.
2. Click **Administration > Migration**.
3. Click **Copy 10.x data**.
4. Provide the following information on the **GENERAL** page.

Option	Action
Name	Enter a migration name or use the default one. The default migration name shows the name of the user who is logged in, current date, and time stamp.
Description	Enter a description for the migration.

5. Click **Next**.

6. Provide the following information on the **DATABASE** page.

Option	Action
Use secure connection	Select this option to use a secure connection to connect with the database.
Server host name	Enter the host name of the database server that contains the Enterprise 10 data you want to migrate.
Server port	Enter the port you want to use to connect with the database server.
Use database credentials	Select this option to use database credentials for authentication when establishing a connection with the database server.  If you have selected this option, provide the credentials you want to use to connect to the database server in the <b>Username</b> and <b>Password</b> fields.
Use Windows authentication	Select this option to use Windows authentication for establishing a connection with the database server.  <b>Important:</b> This option works only if you have configured a domain account during installation and which has read and write permissions for Enterprise 10 database.
Database name	Enter the database name that contains the Enterprise 10 data you want to migrate.
Connect	Click this option to establish a connection with the database.

7. Click **Next**.

8. Provide the following information on the **REPOSITORY** page.

Option	Action
Repository path	Enter the location of the restored Enterprise 10 data that is available on the device.
<b>Master key</b>	Enter the <b>Master key</b> for Enterprise 10.
Validate	Click this option to validate the connection before you copy the Enterprise 10 data.

## 9. Click **Copy data**.

See the following video on how to copy Enterprise 10 data to Automation 360:

[Create AAApplicationPath global value in Automation 360](#)

Related concepts

[How Enterprise 10 data is copied to Automation 360](#) on page 1578

Enterprise 10 users, roles, licenses, credentials, bots, and schedules are copied to Automation 360 as part of the copy data process.

Related tasks

[Enable schedules after migration](#) on page 1616

When you copy Enterprise 10 data to Automation 360, the Enterprise 10 schedules are migrated. Version Enterprise 11 schedules are migrated when you update the Enterprise 11 data to Automation 360.

## Prepare for migration when using Enterprise 10 and Automation 360 On-Premises in parallel

Perform the tasks in this workflow if you want to use both Automation 360 On-Premises and Enterprise 10 in parallel. You can continue to use both environments till the time you are ready to start the migration from Enterprise 10 to Automation 360 On-Premises.

1. Ensure that you have completed the following tasks to check your readiness for migration  
[Check migration readiness](#) on page 1505.
2. Ensure you have procured and activated your migration license.  
[Get migration license](#) on page 1545

---

**Note:** Create a new environment for migration to Automation 360 to avoid any issues to your existing bots because of migration activities.

---

1. We recommend that you create a backup of the Enterprise 11 database and restore it in the same or different SQL instance to avoid failure of any automation task that is using the Enterprise 11 database.  
[Quickstart: Back up and restore a SQL Server database on-premises](#)
2. Ensure that all the credential variables used in the Enterprise 11 bots are available in the Enterprise 11 Control Room.
3. Install Automation 360 On-Premises:
  - a) Ensure you meet the system requirements.
  - b) Install Automation 360 On-Premises Control Room in custom mode to a staging environment.  
[Installing Control Room using Custom mode](#) on page 1245

---

**Important:** You must install Automation 360 with a new database.

---

4. Complete the pre-migration tasks.  
[Pre-migration tasks](#)

5. Create the **AAApplicationPath** global value in Automation 360 and set the same value as Enterprise 10.  
[Variable mapping for migration](#) on page 1655
6. Copy the Enterprise 10 data to Automation 360.  
[Copy Enterprise 10 data](#) on page 1581
7. Continue using both Enterprise 10 and Automation 360 environments in parallel.

---

**Note:** Create all new bots and entities such as users, roles, and schedules in Automation 360.

---

8. If you create any new entity such as users, roles, schedules, and bots in Enterprise 10 after installing Automation 360, create the same entity in Automation 360.
9. When you are ready to use only Automation 360 as your production environment:  
If you have created new bots or updated the existing ones in Enterprise 10 after installing Automation 360, based on your environment, follow these steps:
  - Applies from v.24 onwards:
    - a) Export all the bots and their dependencies that were created after Automation 360 was installed using the export utility.  
[Migrate new or updated Enterprise 10 bots to Automation 360](#) on page 1584
    - b) Import all the bots to Automation 360 using Bot Lifecycle Management.  
[Import bots](#) on page 2035
  - Applies to v.23 and previous versions
    - a) Copy all the bots and their dependencies from Enterprise 10 by using the **Copy 10.x data** option in the Automation 360.
    - b) Login as the Bot Creator to upload the bots and their dependencies to the Automation 360 private workspace. Note that the folder structure of the bots and their dependencies must be same as that of version Enterprise 10.
    - c) Check in the bots to the public workspace.

[Migrate Enterprise bots](#) on page 1590

## Migrate new or updated Enterprise 10 bots to Automation 360

The Enterprise 10 export utility enables you to migrate new or modified Enterprise 10 bots to Automation 360 after an earlier migration.

Use the export utility to create an `.aapkg` package that can be imported using the Bot Lifecycle Management and then migrated using the Bot Migration Wizard in Automation 360.

1. Download the latest version of the bot export utility from the Automation Anywhere Support site.
  - a) Navigate to the Automation Anywhere Downloads page: [A-People Downloads page \(Login required\)](#).
  - b) Click the Automation 360 link.
  - c) Click **Installation Setup**, and then click `AAE_Export_Legacy_Bots_<version>.zip` file.



2. Extract the files from the zip file you have downloaded.
3. Open the Windows command prompt.
4. Change the working directory to `AAE_Export_Legacy_Bots_<version>` and enter the following command: `bin\java -jar AAE_Export_Legacy_Bots_<version>.jar -INPUT="INPUT LOCATION" -OUTPUT="OUTPUT LOCATION" -INCLUDE_SUBFOLDERS`  
Update the following values in the command:
  - **INPUT:** Replace the text with the file path or folder path of the Control Room repository from where the bot files (.atmx and .mbot files) have to be exported.
    - Ensure that the folders mentioned in the location exist.
    - Ensure that you specify the location of the input folder in double quotation marks.
  - **OUTPUT:** Replace the text with an output location where you want to store the exported bot files in a package (.aapkg) with time stamp.
    - Ensure that the folders mentioned in the location exist.
    - Ensure that you specify the location of the output folder in double quotation marks.
  - **INCLUDE\_SUBFOLDERS:** Provide this optional parameter to indicate whether the bot files from the nested subfolders of the Control Room repository should be exported or not.

Command example to export folder: `bin\java -jar AAE_Export_Legacy_Bots_<version>.jar -INPUT="E:\Migration10x\Automation Anywhere Server Files\Default\Automation Anywhere\My Tasks\10X\Sample_Tasks" -OUTPUT="F:\10x-Export-Utility\Exported-Bots"`

Command example to export file: `bin\java -jar AAE_Export_Legacy_Bots_<version>.jar -INPUT="E:\Migration10x\Automation Anywhere Server Files\Default\Automation Anywhere\My Tasks\10X\AutomationTask.atmx" -OUTPUT="F:\10x-Export-Utility\Exported-Bots"`

The utility generates the .aapkg file at the output location you specified.

1. Navigate to **Automation > Import bots** to import the .aapkg package file in Automation 360.  
[Import bots](#) on page 2035
2. Navigate to **Administration > Migration** to migrate the bots (convert .atmx file to .bot file) in Automation 360 using the Bot Migration Wizard.  
[Migrate Enterprise bots](#) on page 1590

## Prerequisite tasks for migrating bots

After you have set up Automation 360, you must perform certain tasks before migrating the Enterprise 11 or Enterprise 10 bots.

- Licenses:
  - For migration to be successful, the license requirements of the target environments must match the existing source environments.
  - At least one license is required for migration.
- Roles:

Assign the **AAE\_Bot Migration Admin** role to the user who will initiate the migration and the Bot Runner user who will perform the migration. The Bot Runner user who runs the migration must have the following permissions and criteria:

- An unattended Bot Runner license
- **Autologin Set** status
- Default device configured

See the following video on how to create an Admin user to initiate bot migration:

See the following video on how to create a Bot Runner user to perform the bot migration:

- Control Room settings:
  - Enterprise 11 users who have installed Automation 360 using a fresh database and Enterprise 10 users who have not copied Enterprise 10 data must manually create all the Enterprise 11 or Enterprise 10 entities, except bots, in Automation 360. See information about the entities you must create, see [Prerequisites for manual migration](#) on page 1561.

- Bot Agent: Install the Bot Agent on the device that you want to use for migration: [Install Bot Agent and register device](#) on page 1347.

See the following video on how to install the Bot Agent on the device identified for bot migration:

- Bots: To migrate the production version of bots, import the Enterprise 11 bots using the Bot Lifecycle Management feature from the SVN version control enabled Enterprise 11 Control Room. See [Import bots](#) on page 2035.

## Next steps

[Migrate Enterprise bots](#) on page 1590

## Migrate and validate bots

Perform the tasks in this workflow to convert your bots to the Automation 360 format and to validate them after migration.

Ensure that you have completed all the tasks about preparing your Automation 360 environment for migration: [Prepare new Control Room for migration](#) on page 1546.



1. Migrate your Enterprise 11 and Enterprise 10 bots to Automation 360: [Migrate Enterprise bots](#) on page 1590.
2. Verify the migration is completed successfully:
  - [View migration reports](#) on page 1675
  - [Verify the bot migration](#) on page 1674

- [Export to CSV](#) on page 1676
- [View changes to migrated bots using Bot Assistant](#) on page 1677

See also the following video on migrating, testing, and updating your migrated bots:

## Bot Migration Wizard

This wizard is integrated in Control Room in Automation 360 and guides you through the migration process after you complete the prerequisites. You can migrate multiple bots and their dependent bots using this wizard.

The Bot Migration Wizard migrates a bot only if all of the components used in that bot are supported for migration. If a bot uses other dependent files such as .txt, .doc, and .png, you have to add these files as dependencies manually after migrating the bots.

You can also use the **Bot migration** package to migrate individual bots. However, we do not recommend using this package because it does not migrate bot dependencies and other entities that are required to run the bot after migration.

In the Control Room (**Administration > Migration > Overview**) tab, you can get a consolidated view of the status of migrated bots.

Overview tab

---

**Important:** You must have both View migration and Manage Migration permission to view this tab.

---

You can view the overall status of bot migration, including the following details:

- Bots that are migrated successfully
- Bots that failed to migrate
- Bots that are migrated with a review message
- Bots that are migrated with an action required message
- History of migration: Information about past migrations that were run from a specific folder or from all folders.

You can also perform the following actions:

- Rerun migration on selected bots and view the history of each bot that has gone through multiple migrations.
- View the time when the bot was migrated using the time stamp.
- Get a summary count of bots that are successfully migrated, that failed to migrate, and those that require your review or action.
- Export a specific list of bots.
- View the version of the migrated bot.

- View the version history of the migrated bot (the check-in message indicates that the bot is migrated from legacy Enterprise 10 and Enterprise 11 version).

To view the updated status of the remigrated bot, you can refresh either the table or the screen, shown in the following

**Migration List**

Before you migrate bots

1. Review your Bot Scanner Report to determine which bots can be migrated.
2. Create a Bot Runner with a bot running device, migration role, and unattended bot runner license.

For more information, [Go to Documentation](#)

Overview Migration runs

Total bots: 16

● Successful: 8 ● Successful with Review Required: 2 ● Successful with Action Required: 4 ● Unsuccessful: 2

Name Search

Bots (16)

	Type	Name	Migrated bot status	Folder path	Migration run	Start time	End time
<input type="checkbox"/>		action.atmx	Unsuccessful	Bots\My Tasks\Success...	Migration.migrator.22.02.25.19.1...	5 days ago	5
<input type="checkbox"/>		action-review.atmx	Successful with A...	Bots\My Tasks\Success...	SuccessWithReview.Action.Test	1 month ago	1
<input type="checkbox"/>		action-review-sameline-multipl...	Successful with A...	Bots\My Tasks\Success...	SuccessWithReview.Action.Test	1 month ago	1
<input type="checkbox"/>		action-review-sameline-single.a...	Successful with A...	Bots\My Tasks\Success...	SuccessWithReview.Action.Test	1 month ago	1

Watch the following video to learn how to convert Enterprise 11 or 10.x bots in .atmx and .mbot format to .bot format to Automation 360. You perform this task after you have replicated your Enterprise 11 or Enterprise 10 database and bots are available in Automation 360 Control Room.

## Considerations when you migrate and validate bots

The migration process is designed to be seamless. Learn what to expect while you convert, validate, and migrate bots so that you can run your daily automated processes as usual.

Time taken for migration

Migration time will vary based on the number of bots in your Enterprise 11 or Enterprise 10 repository, the number of processes automated, and the number of Bot Runners and machines that are performing the migration. The time required to migrate varies based on your internal processes and requirements.

**Note:** After data is migrated from Enterprise 11 to Automation 360, ensure that the end-to-end migration activity is completed within 90 days from the first day of data migration. After

90 days, the Bot Insight analytical data will be deleted.

---

The following factors impact the time taken for migration:

- Number and complexity of bots
- Number of lines in a bot
- Control Room and Bot Agent configuration
- Current load on Control Room (indicated by the number of users connected to a Control Room at a specific time)
- Migration environment: whether migration is being performed on an isolated production or staging environment.

Migration in an isolated environment occurs faster.

- Whether the bots to be migrated are located in a single folder or are located across multiple folders

Bots present in a single folder are migrated faster.

- Hardware requirements of the device from where the migration is performed
- Network bandwidth
- Public repository size: When you run the Bot Migration Wizard on a Git public repository that is larger than 1 GB and contains more than 50,000 files or objects, the migration time might be impacted.

### Migrating at your pace

The migration tools provide you with control over what to migrate and when to migrate. You can choose to migrate all of your bots at the same time or migrate a few bots at a time. During the transition period from Enterprise 11 or Enterprise 10 to Automation 360, you can continue to run bots on the previous platform as usual until your migration is complete.

---

**Note:** After the migration is completed, all new bots must be built on Automation 360. This will help you manage your bots and your organization to transition.

---

### Zero downtime

Migration does not impact any scheduled bots or the ability to run bots as planned on Enterprise 11 or Enterprise 10 when you migrate data to Automation 360. As long as your infrastructure requirements are met according to your automation needs, and

Running Enterprise 11 or Enterprise 10 and Automation 360 in parallel

you run Enterprise 11 or Enterprise 10 and Automation 360 in parallel, there should be no pause in regular automation activities.

During the transition period, we recommend that customers run automation on Enterprise 11 or Enterprise 10 until migrated bots are tested and running successfully on Automation 360. This is the best way to ensure zero downtime.

## Migrate Enterprise bots

The bot migration process uses the Bot Migration Wizard to convert Enterprise 11 or Enterprise 10 bots (Task Bots and MetaBots) in `.atmx` and `.mbot` format to the `.bot` format used in Automation 360 and uploads the successfully migrated bots to the Control Room public workspace.

Ensure you have completed all the prerequisite tasks for migrating bots: [Prerequisite tasks for migrating bots](#) on page 1585.

All manual dependencies of bots are automatically converted as Control Room dependencies during migration. The **Copy Control Room file** action copies these dependencies from the Control Room to the respective locations.

1. Log in to your Automation 360 staging environment.
2. Click **Administration > Migration**.

**Note:** If you have migrated bots from Enterprise 10 to Enterprise 11, the information about that migration is not displayed on the **Migration List** page.

3. On the Bot Migration Wizard screen, click **Migrate bots**.

4. Select the options and configuration as required in the the **Settings** tab.

Option	Action
Name	Enter a migration name or use the default one. The default migration name shows the name of the user who is logged in, current date, and time stamp.
Description	Enter a description for the migration.
Overwrite if a bot with the same name exists	Select this option to overwrite an existing bot if a bot with the same name exists in the folder.
Exclude bot dependencies	Select this option to exclude child bots of sub-tasks from migration or updating. By selecting this flag, you can now choose to migrate parent and child bots separately or independently.
Use "Excel Cell Row" legacy behavior	Select this option if you are migrating from a version earlier than Version 11.3.0 or you want to retain the legacy behavior of the <b>Excel Cell Row</b> system variable.
Use outgoing Email server settings	Select this option if your bot contains the Send Email command. Use these settings to specify the type of email server to use.
Include web service settings	Select this option for custom proxy configuration support. When you select this option, the REST commands with <b>Custom</b> proxy configurations that use the following global variables are migrated: <ul style="list-style-type: none"> <li>• <code>AAProxyHost</code> for <b>Hostname</b></li> <li>• <code>AAProxyPort</code> for <b>Port</b></li> </ul>
Convert bots built using Internet Explorer to Edge with Internet Explorer mode	Select this option if you want to migrate Enterprise 10 or Enterprise 11 bots that use Internet Explorer to Automation 360 bots that use Microsoft Edge with IE mode.
Convert \n characters to \r\n in Log to File action	Select this option to convert \n characters (LF) into \r\n characters (CRLF), which automatically take new line in migrated bots using <b>Log to File</b> action.

Option	Action
Tag bots and variables for analytics	<p>Select this option when Bot Insight data exists in the Enterprise 11 bots, and you also want to migrate the Bot Insight data with those bots. When you select this option, the Bot Insight <b>Open</b> and <b>Close</b> actions are created.</p> <hr/> <p><b>Note:</b> To migrate Bot Insight data, you must enable this option.</p> <hr/> <p>When you migrate Bot Insight data along with bot migration, ensure that the Bot Insight prerequisites are met. <a href="#">Bot Insight prerequisites</a>   <a href="#">Cloud Migration Utility prerequisites</a></p> <p>If the Bot Insight prerequisites are not met, Cloud migration with Bot Insight might become stuck in the <b>In Progress</b> state.</p> <p>Also, regardless of whether the Bot Insight and the Cloud Migration utility prerequisites are met or not, import or upload of the .atmx file &gt; <b>Migrate</b>. This issue is observed on both On-Premises and Cloud deployments.</p>

5. Click **Next**.

6. Select the bots and the folders that contain the bots (Task Bots and MetaBots) that you want to migrate.

The ability to select a folder eliminates the effort required in selecting individual bots from that folder.

- If you selected a folder, all subfolders within that folder and the bots within these subfolders are automatically selected for migration.
- If the folder is empty, the migration process encounters an error.

The **Last Migrated** column indicates when the bot was migrated previously. N/A means the bot has not been migrated before.

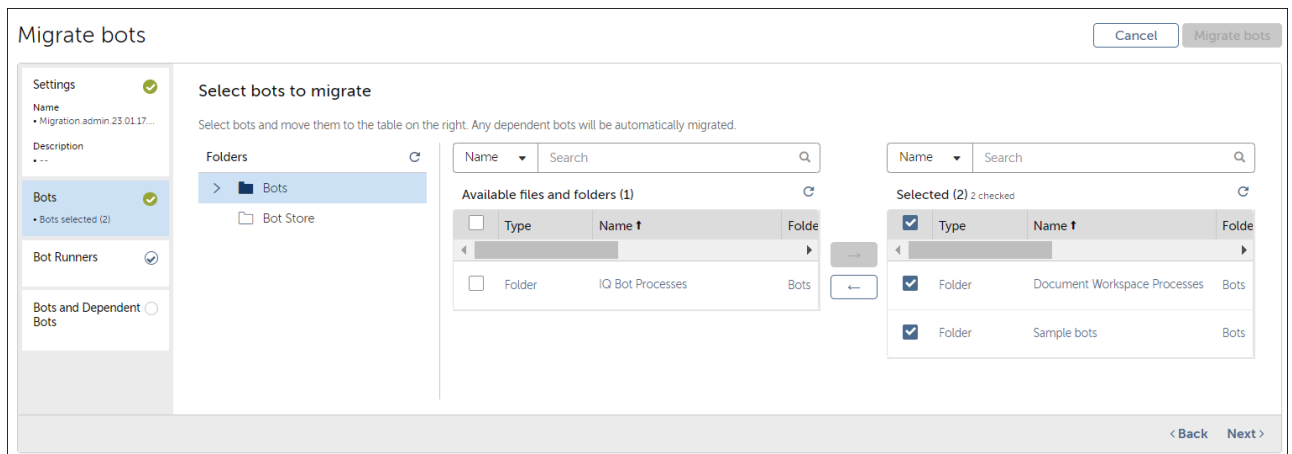



7. Click **Next**.
8. Select one or more usernames from the list to run the migration and click the right arrow.
 

Username can display either the message `Picked at run time` or the device name in the **Device** column. `Picked at run time` is shown when a user does not have a default device, for example, a user who has not registered a device and a system administrator has assigned a device to that user. A default device must be configured for all Bot Runners you have selected.

  - Bots are distributed across selected Bot Runner users in a round-robin method.
  - The first Bot Runner user on the selected list is the first one used.
  - A parent bot and its dependencies are assigned to a single Bot Runner user.

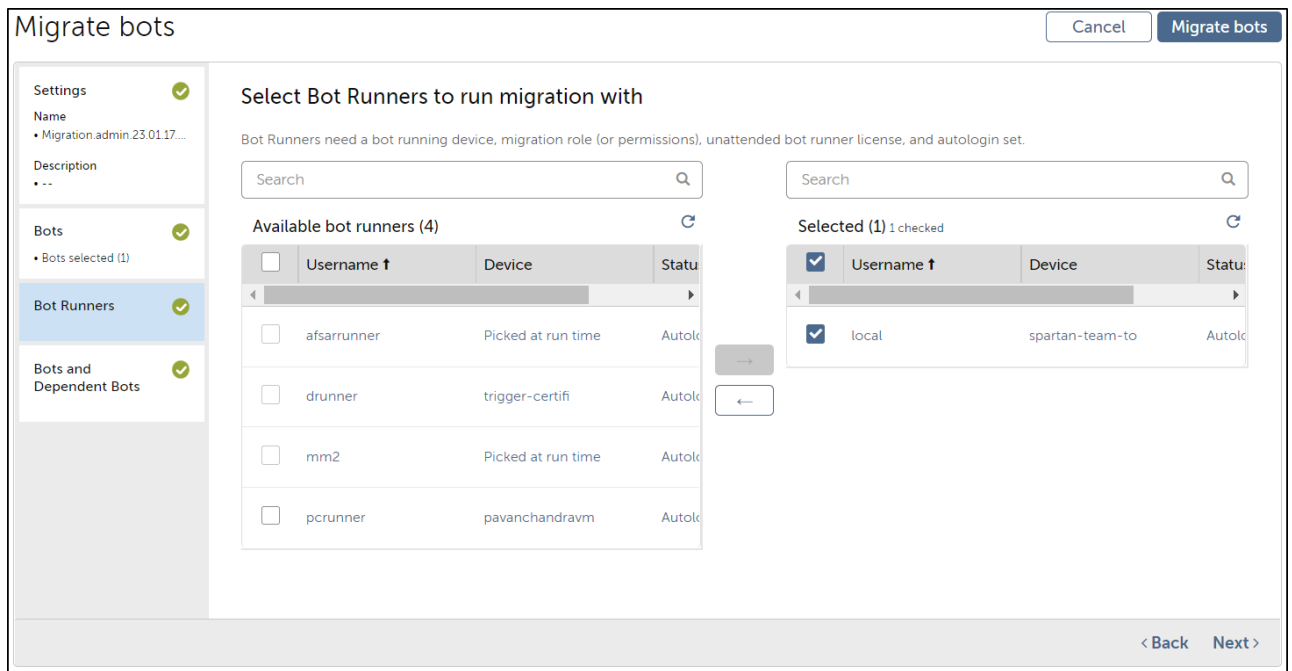

9. Click **Next**.
10. Optional: Review the dependent Task Bots and MetaBots on the **Bot and Dependent Bots** page before you migrate them.

If you have selected a folder and bots from the **Bots** page, that folder and dependencies of the selected bots are displayed in the table.

Dependent bots (Task Bots and MetaBots) are migrated before the primary bot.

The table shows the primary bot at the bottom and its dependencies above. For example, the following information means that `Sample05.atmx` has a dependency on `Sample04.atmx`, and `Sample04.atmx` has a dependency on `MessageBox.atmx` and `MetaTask.mbot`.

Type	Name	Path
MetaBot (mbot)	MetaTask.mbot	Bots\My Metabots \MetaTask.mbot
Task Bot (atmx)	MessageBox.atmx	Bots\MyTasks \MessageBox.atmx
Task Bot (atmx)	Sample04.atmx	Bots\MyTasks \Sample04.atmx

Type	Name	Path
Task Bot (atmx)	Sample05.atmx	Bots\MyTasks \Sample05.atmx

#### 11. Click **Migrate bots**.

The system validates whether the user who initiated the migration and the Bot Runner users selected have the required permissions to perform the migration. The system verifies whether all of the following permissions are granted to the user performing the migration and the Bot Runners you have selected:

- User performing migration:
  - **View Migration** permission
  - **Manage Migration** permission
  - Permission on the folders containing the bots and MetaBots you want to migrate
  - A role that has access to Bot Runners that you want to select for running the migration (on the **Administration > Migration > Run As** page)
  - **View & edit ALL credentials attributes value** permission
- Bot Runners:
  - An unattended Bot Runner license
  - **Autologin Set** status
  - **Allow a bot-runner user to run migrations** permission
  - **Create standard attributes for a credential** permission
  - **Create folder** permission
  - **View package** permission
  - **Register device** permission
  - **View my bots** and **Run my bots** permissions
  - **Check-in** and **Check-out** permissions for the **My Tasks** and **My Metabots** folders in Automation 360
  - **Default device** settings

If any of the required permission is not granted, the system displays those permissions in the validation results. You must grant the required permissions and start the migration process again.

If all the required permissions are granted to the users, the system starts migrating the selected bots and their dependent bots.

After the migration, the system uploads successfully migrated bots, the associated Bot Insight data, and the published dashboards to the public workspace of the Automation 360 Control Room (in the same folder in which the .atmx file is available). Only bot migrations initiated from the Control Room are stored in the public workspace.

Validation error details for each bot are displayed in the bot migration results. The error details include the line number, error details, and the reason and recommendation.

The Bot migration results display the number of bots migrated, along with their individual statuses. Click the **Status** column to filter bots with specific statuses for quick analysis.

In the **Reasons** column, click the **View Migration issues** option to see detailed reasons for the error. The **View Migration issues** dialog box displays the line number where the error occurred, a summary of the error, and a detailed error report for your review.

- a) Check out the bot to migrate the private dashboards associated with that bot.  
The private dashboards are migrated only for the user who checked out the associated bot for the first time.
- b) View in-progress migration activities from the **Activity > In progress** page.

Migrations (26)									
<input type="checkbox"/>	Status	Name	Type	Start time ↓	End time	Duration			
<input type="checkbox"/>	Successful	<a href="#">array CS ISuee</a>	Bot migration	5 days ago	5 days ago	28 sec			⋮
<input type="checkbox"/>	Successful	<a href="#">Migration.migadmin.22.12.06.12...</a>	Bot migration	1 month ago	1 month ago	23 sec			⋮
<input type="checkbox"/>	Successful	<a href="#">Migration.migadmin.22.12.06.12...</a>	Bot migration	1 month ago	1 month ago	23 sec			⋮
<input type="checkbox"/>	Successful	<a href="#">Migration.migadmin.22.12.06.12...</a>	Bot migration	1 month ago	1 month ago	27 sec			⋮
<input type="checkbox"/>	Unsuccessful	<a href="#">Migration.migadmin.22.12.06.12...</a>	Bot migration	1 month ago	1 month ago	30 sec			⋮
<input type="checkbox"/>	Successful	<a href="#">Migration.shweta_r.22.12.02.16.4...</a>	Bot migration	1 month ago	1 month ago	1 min 1 sec			⋮
<input type="checkbox"/>	Successful	<a href="#">Migration.shweta_r.22.12.02.16.3...</a>	Bot migration	1 month ago	1 month ago	1 min 13 sec			⋮
<input type="checkbox"/>	Successful	<a href="#">Migration.shweta_r.22.12.02.16.2...</a>	Bot migration	1 month ago	1 month ago	1 min 3 sec			⋮
<input type="checkbox"/>	Unsuccessful	<a href="#">Migration.shweta_r.22.12.02.16.2...</a>	Bot migration	1 month ago	1 month ago	35 sec			⋮

See the following video on how to migrate Enterprise 11 or Enterprise 10 bots:

See the following resources if you encounter errors during migration:

- [Migration error: Physical bot files aren't available \(A-People login required\)](#)
- [Migration error: Unable to download the source bot file for conversion \(A-People login required\)](#)
- [Migration shows unsuccessful by creating duplicate atmx files \(A-People login required\)](#)
- [Unable to migrate due to java.lang.StackOverflowError exception \(A-People login required\)](#)
- [Migration error: Unable to delete the file MigrationBot \(A-People login required\)](#)

[Verify the bot migration](#) on page 1674 | [View migration reports](#) on page 1675

Related tasks

[View migration reports](#) on page 1675

Use the reports to analyze the status of individual bot migration, data migration, and audit log migration and identify the status and summary of the individual migration.

[Export Enterprise 11 Bot Insight dashboards for migration](#) on page 1568

Use the Bot Insight pre-migration utility to export your Enterprise 11 Bot Insight dashboard metadata (widgets and layouts) and dashboard profile as a zip file. Run this utility in your Enterprise

11 device and paste the zip file in the Automation 360 repository to migrate the Bot Insight dashboards.

## How MetaBots are migrated

When you migrate a MetaBot to Automation 360, equivalent bots are created for the various logic available in the MetaBot, except for application screens. After successful migration, each logic in a .mbot file is converted to a Task Bot file.

A MetaBot contains assets and logic. Assets are the application screens or DLLs that are used to automate a task on an application. Logic is a set of commands to perform an operation and interact with other logic and bots.

---

### Note:

- Before you migrate .atmx or .mbot using the Bot Migration Wizard, ensure that all the Logics, dlls, .mbots, .atmx files and other dependencies related to the MetaBots or Task Bots that were previously migrated are not in the **Checked-out** state. Otherwise, the following error occurs during re-migration:

`Bot is not ready for migration.`

The details of the unsuccessful migration are displayed in the **Bot Migration wizard > Results > Skipped** tab.

- If the bot that you are migrating has been checked out or has been migrated previously, ensure that the bot to be migrated is in the **Checked-in** state. Also, to reuse the migrated bot, in the Bot Migration Wizard, select the **Overwrite if a bot with same name exists** option. To use an updated bot, disable the **Overwrite if a bot with same name exists** option.

---

The migration process performs the following actions:

- Converts MetaBot logic to corresponding Task Bots.
- Maintains the folder structure of the MetaBots after it is migrated. The new folders created in Automation 360 contain the Task Bots for each logic migrated to Automation 360.
- Updates the Task Bots that use MetaBot logic to refer to the new Task Bots that are created for the migrated MetaBot logic.

You do not have to update the Task Bots manually.

Features such as use of DLLs, input and output variables, and **Execute** permission which were available only for MetaBots are now available for all Task Bots.

We will use the following MetaBot to explain how it is migrated to Automation 360:

- MetaBot name: MetaTask
- Assets:
  - Login screen
  - General.dll
  - DLL\Binary.dll
- Logic:
  - Common
  - Process1\Connect
  - Process1\Disconnect

- Process1\Operations\Numeric

## Benefits of reusable Task Bots in Automation 360

The following table lists the benefits of using reusable Task Bots in Automation 360 compared with MetaBots in Enterprise 11:

Automation 360 reusable Task Bots	v11 MetaBots
You can navigate to a child bot through fewer clicks using the Finder component, thus saving time. Navigate to <b>Editor &gt; Finder</b> to reach the child bot.	You must navigate through the <b>TaskBot &gt; Run</b> action to reach the child bot.
You can search the child bots from the private workspace as well as public workspace to use them in Task Bots.	You must download the MetaBots to the local repository to use a child bot in the Task Bots.
Only a specific Logic is deployed when it is used in a task, which saves time and bandwidth.	Entire MetaBot is deployed to the Bot Runner machine even if only one Logic is used in the Task.
Provides better RBAC, which enables you to customize permissions.	MetaBots forces all Logic to have the same permissions even if multiple Logic are spread across different folders.

## MetaBot migration process

The system creates a folder with the same name as the MetaBot within the **My MetaBots** folder available in the **Bots** folder, and the same folder structure as Enterprise 11 is retained. For example, if the folder structure in Enterprise 11 is **Accounts/Tax/MetaTask.mbot**, the system retains the folder structure as **Accounts/Tax/MetaTask.mbot**. All the components of a MetaBot are stored in the folder created for that MetaBot. In this example, the system creates the **MetaTask** folder in the **Bots\My MetaBots** folder and stores all the components the MetaBot in that folder.

Enterprise 10 bots that directly call DLLs and screens in a MetaBot without using MetaBot logic are migrated to the equivalent Task Bots and actions in Automation 360. In Enterprise 10, if a DLL that returns a list or array type parameters and the output of that DLL is mapped with a value type parameter, an extra space is added at the start of the output value. The extra space is not added to the output value after the bot is migrated.

10.1 MetaBots that use DLL functions that accept one-dimensional array and list type input parameters and is mapped with the array type parameter. In such cases, row index and column index are required as input to specify the value to be returned. After migration, the row index is considered as column number.

**Note:** For bots that are upgraded from 10.1 to 10.3.5 and then migrated to Automation 360, the Bot Migration Wizard does not show the dependency on the **Bot and Dependent Bots** page. For

such bots, you must migrate the MetaBots before migrating the Task Bots that are calling those MetaBots.

---

## Migration of DLLs

The system does not maintain the folder structure for assets in order to maintain the references between the DLLs. For the above example, `General.dll` and `Binary.dll` are stored in the `MetaTask` folder although the `Binary.dll` is stored in the `DLL` subfolder.

See the following video for information on migrating MetaBots with DLLs to Automation 360:

## MetaBot migration process overview

Use the information provided in this section to understand the processes involved in migrating MetaBot to Automation 360.

Concept of DLL session in the migrated bot

The following DLL changes are observed in the migrated bot:

- When you migrate a Task Bot with multiple MetaBots that contain DLLs with the same name, a session name using the name of the first DLL is created. When the subsequent DLL with the same name from another MetaBot is migrated, the ID of the folder in which the DLL resides is used as a session name.

For example: `M_DLL_Session-  
<MetabotFolderId>_<DLLName>`.

- When the **Execute DLL** command in Enterprise 11 is migrated to Automation 360, the command is converted to the **Open** and **Run function** actions and the **DLL Session does not exist** If condition.
- The DLL session name is created by appending the DLL name to the "M-DLL-Session-" token. For example, if the DLL name is `Sample.dll`, after migration, the DLL session name will be `M-DLL-Session-Sample`.
- The DLL session represents the DLL it is using to run the DLL functions.
- To run multiple functions from the same DLL, the same DLL session name must be provided in the **Session name** field.

Condition to check for the existence of a DLL session in a migrated bot

After migration, when the same DLL is used across multiple logics of the same MetaBot, a condition to check if a DLL session is already open is added for every DLL to ensure that

the DLL session is opened only once. Some DLLs that are used in MetaBot share sessions or global variables across multiple DLL functions. If such DLL functions are called from different logics, sharing of such sessions and variables is possible only if the DLL session is opened only once and a condition is added to check if a DLL session is already available. If a DLL session is missing, Automation 360 creates a DLL session of type **Global**.

What happens to a migrated Task Bot that has reference to two DLL functions from same or different logics of a MetaBot?

In Enterprise 11, if a Task Bot was referencing to a logic that called two functions using the **Run Logic** command, in Automation 360, a DLL session will be created in the Task Bot (logics are migrated as Task Bots) and will be used in the **Run function** action. Also, when a Task Bot refers multiple logics that calls multiple functions, the Task Bots will use the same DLL session name to execute the functions. The DLL session condition check will ensure that only one session is created across such logics.

For example, if a Task Bot is using MetaBot1 Logic and MetaBot2 Logic where MetaBot1 Logic and MetaBot2 Logic are calling multiple functions, when you run the Taskbot, a DLL session name is created to run MetaBot1 Logic. The DLL session name that was created to run MetaBot1 Logic will be used to run MetaBot2 Logic as well.

## Migration of screens

Each screen in a MetaBot is converted to a windows variable and the actions performed on the screen are migrated to the equivalent actions in Automation 360.

The following table lists the screens that can be migrated to Automation 360:

Browser	Internet Explorer Google Chrome (for object play type only)
Screen type	Standard
Technology	Java, HTML, MSAA, .Net, UI Automation (for object play type only)
Play type	Object, Image, Coordinate

You can also migrate MetaBots with screens that are captured in the Citrix environment from applications that are based on Java, UI Automation, and MSAA technologies.

The linked objects on a MetaBot screen that are captured using the object play type are migrated to the **Capture** action of the Recorder package. The source object is displayed in the **Main** tab and the linked object is displayed in the **Anchor** tab of the **Capture** action.

The following table provides information about the actions that are performed on an object play type object and text play type linked object available on the screen is migrated to the equivalent actions in Automation 360:

Play type	Enterprise 11 Action	Automation 360 Action
Object	Get Property, Get Total Items, Get Selected Index, Get Selected Text, Select Item by Text, Select Item by Index, Click, Left Click, Right Click, Double Click, Set Text, Append Text, Get Property, Check, Uncheck, Toggle, Expand, Select, Get Status,	<p>Migrated to the <b>Capture</b> action of the Recorder package.</p> <p>The <b>GetAllChidrenName</b> and <b>GetAllChidrenValue</b> commands in Enterprise 11/Enterprise 10 return string type variable values. In Automation 360, they return list values. The migration process joins the list values and stores them into a string variable to maintain consistent bot behaviors across releases.</p> <p>The <b>Object Cloning</b> command with the <b>Export to CSV</b> action in Enterprise 11/Enterprise 10 is migrated to:</p> <ul style="list-style-type: none"> <li>The <b>Capture</b> action of the Recorder package. This action saves the captured date into a table variable.</li> <li>The <b>Write to file</b> action of the Data Table package. This action saves the data from the table variable to the CSV file.</li> </ul>

The following table provides information about the actions that are performed on an image play type object image play type linked object available on the screen is migrated to the equivalent actions in Automation 360:

Play type	Enterprise 11 Action	Automation 360 Action
Image	Left Click	Migrated to the <b>Find window in window</b> action of the Image Recognition package with the <b>Left Click</b> selected from the <b>Action</b> list.
	Right Click	Migrated to the <b>Find window in window</b> action of the Image Recognition package with the <b>Right Click</b> selected from the <b>Action</b> list.
	Double Click	Migrated to the <b>Find window in window</b> action of the Image Recognition package with the <b>Double Click</b> selected from the <b>Action</b> list.



Play type	Enterprise 11 Action	Automation 360 Action
	Middle Click	Migrated to the <b>Find window in window</b> action of the Image Recognition package with the <b>Left Click</b> selected from the <b>Action</b> list.
	Set Text	Migrated to: <ul style="list-style-type: none"> <li>• The <b>Find window in window</b> action of the Image Recognition package with the <b>Left Click</b> selected from the <b>Action</b> list.</li> <li>• The <b>Delay</b> action of the Delay package with the <b>Regular</b> delay set to 500 milliseconds.</li> <li>• The <b>Simulate keystrokes</b> action of the Simulate keystrokes package.</li> </ul>
	Get Text	Migrated to the <b>Capture area</b> action of the OCR package.
	GetVisibility	Migrated to <b>IF</b> action with condition Image Recognition: <b>Find Window in window</b> . The <b>GetVisibility</b> action returns a <b>True</b> or <b>False</b> value based on whether the object in an image is visible or not. Similarly, the condition within the <b>IF</b> action is evaluated based on whether the window is found in another window. The result is stored in a temporary variable.

The following table provides information about the actions that are performed on a coordinate play type object coordinate play type linked object available on the screen is migrated to the equivalent actions in Automation 360:

Play type	Enterprise 11 Action	Automation 360 Action
Coordinate	Click	Migrated to the <b>Click</b> action of the Mouse package with the <b>Left Button</b> and <b>Click</b> options selected.
	Left Click	Migrated to the <b>Click</b> action of the Mouse package with the <b>Left Button</b> and <b>Click</b> options selected.
	Right Click	Migrated to the <b>Click</b> action of the Mouse package with the <b>Right Button</b> and <b>Click</b> options selected.
	Middle Click	Migrated to the <b>Click</b> action of the Mouse package with the <b>Middle Button</b> and <b>Click</b> options selected.
	Double Click	Migrated to the <b>Click</b> action of the Mouse package with the <b>Left Button</b> and <b>Double click</b> options selected.

Play type	Enterprise 11 Action	Automation 360 Action
	Set text	Migrated to: <ul style="list-style-type: none"> <li>The <b>Click</b> action of the Mouse package with the <b>Left Button</b> and <b>Click</b> options selected.</li> <li>The <b>Delay</b> action of the Delay package with the <b>Regular</b> delay set to 500 milliseconds.</li> <li>The <b>Simulate keystrokes</b> action of the Simulate keystrokes package.</li> </ul>
	Get text	Migrated to: <ul style="list-style-type: none"> <li>The <b>Click</b> action of the Mouse package with the <b>Left Button</b> and <b>Click</b> options selected.</li> <li>The <b>Clear</b> action of the Clipboard package.</li> <li>The <b>Delay</b> action of the Delay package with the <b>Regular</b> delay set to 500 milliseconds.</li> <li>The <b>Simulate keystrokes</b> action of the Simulate keystrokes package.</li> <li>The <b>Delay</b> action of the Delay package with the <b>Regular</b> delay set to 500 milliseconds.</li> <li>The <b>Copy to</b> action of the Clipboard package.</li> </ul>

The following table provides information about actions that are performed on a coordinate play type custom object available on the screen that is migrated to equivalent actions in Automation 360:

Play type	Enterprise 11 action	Automation 360 action
Coordinate	Click	Migrated to the <b>Click</b> action of the Mouse package with the <b>Left Button</b> and <b>Click</b> options selected.
	Left Click	Migrated to the <b>Click</b> action of the Mouse package with the <b>Left Button</b> and <b>Click</b> options selected.
	Middle Click	Migrated to the <b>Click</b> action of the Mouse package with the <b>Middle Button</b> and <b>Click</b> options selected.
	Double Click	Migrated to the <b>Click</b> action of the Mouse package with the <b>Left Button</b> and <b>Double click</b> options selected.
	Set text	Migrated to the following: <ul style="list-style-type: none"> <li>The <b>Click</b> action of the Mouse package with the <b>Left Button</b> and <b>Click</b> options selected.</li> <li>The <b>Delay</b> action of the Delay package with the <b>Regular</b> delay set to 500 milliseconds.</li> <li>The <b>Simulate keystrokes</b> action of the Simulate keystrokes package.</li> </ul>

Play type	Enterprise 11 action	Automation 360 action
	Get text	<p>Migrated to the following:</p> <ul style="list-style-type: none"> <li>• The <b>Click</b> action of the Mouse package with the <b>Left Button</b> and <b>Click</b> options selected.</li> <li>• The <b>Clear</b> action of the Clipboard package.</li> <li>• The <b>Delay</b> action of the Delay package with <b>Regular</b> delay set to 500 milliseconds.</li> <li>• The <b>Simulate keystrokes</b> action of the Simulate keystrokes package.</li> <li>• The <b>Delay</b> action of the Delay package with <b>Regular</b> delay set to 500 milliseconds.</li> <li>• The <b>Copy to</b> action of the Clipboard package.</li> </ul>

The following table provides information about actions that are performed on a text play type custom object available on the screen that is migrated to equivalent actions in Automation 360:

Play type	Enterprise 11 action	Automation 360 action
Text	Click	Migrated to the <b>Find window in window</b> action of the Image Recognition package with <b>Left Click</b> selected from the <b>Action</b> list.
	Left Click	Migrated to the <b>Find window in window</b> action of the Image Recognition package with <b>Left Click</b> selected from the <b>Action</b> list.
	Double Click	Migrated to the <b>Find window in window</b> action of the Image Recognition package with <b>Double Click</b> selected from the <b>Action</b> list.
	Set text	<p>Migrated to the following:</p> <ul style="list-style-type: none"> <li>• The <b>Find window in window</b> action of the Image Recognition package with <b>Left Click</b> selected from the <b>Action</b> list.</li> <li>• The <b>Delay</b> action of the Delay package with <b>Regular</b> delay set to 500 milliseconds.</li> <li>• The <b>Simulate keystrokes</b> action of the Simulate keystrokes package.</li> </ul>
	Get text	Migrated to the <b>Capture area</b> action of the OCR package.

## Migration of logic

Each logic in a MetaBot is converted to a Task Bot and each command used in a logic is converted to the equivalent action in Automation 360. The variable used in a logic is converted to an equivalent variable in Automation 360. Credential variables used in the logic are migrated to

Automation 360 and used in the equivalent actions in the migrated bots. If the **Parameter Type** of a variable is input or output, the same is maintained after that variable is migrated to Automation 360. For example, if the **Parameter Type** of the variable ABC is set as **Input**, the variable ABC created in Automation 360 has the **Use as input** option selected after it is migrated. The system retains the internal folder structure of the logics. For the above example, all the migrated logics are stored as listed in the following table:

Folder structure in Automation 360	Entry
MetaTask	Common
MetaTask\Process1	Connect
MetaTask\Process1	Disconnect
MetaTask\Process1\Operations	Numeric

The following table provides information about how the Import DataSet command used in the MetaBot logic is migrated to the equivalent actions in Automation 360:

Play type	Enterprise 11 Action	Automation 360 Action
Object	Get Property, Get Total Items, Get Selected Index, Get Selected Text, Select Item by Text, Select Item by Index, Click, Left Click, Right Click, Double Click	Migrated to the <b>Capture</b> action of the Recorder package.
Image	Left Click	Migrated to the <b>Find window in window</b> action of the Image Recognition package with the <b>Left Click</b> selected from the <b>Action</b> list.
	Right Click	Migrated to the <b>Find window in window</b> action of the Image Recognition package with the <b>Right Click</b> selected from the <b>Action</b> list.
	Double Click	Migrated to the <b>Find window in window</b> action of the Image Recognition package with the <b>Double Click</b> selected from the <b>Action</b> list.
	Middle Click	Migrated to the <b>Find window in window</b> action of the Image Recognition package with the <b>Left Click</b> selected from the <b>Action</b> list.
	Set Text	Migrated to: <ul style="list-style-type: none"> <li>• The <b>Find window in window</b> action of the Image Recognition package with the <b>Left Click</b> selected from the <b>Action</b> list.</li> <li>• The <b>Delay</b> action of the Delay package with the <b>Regular</b> delay set to 500 milliseconds.</li> <li>• The <b>Simulate keystrokes</b> action of the Simulate keystrokes package.</li> </ul>

Play type	Enterprise 11 Action	Automation 360 Action
Coordinate	Click	Migrated to the <b>Click</b> action of the Mouse package with the <b>Left Button</b> and <b>Click</b> options selected.
	Left Click	Migrated to the <b>Click</b> action of the Mouse package with the <b>Left Button</b> and <b>Click</b> options selected.
	Middle Click	Migrated to the <b>Click</b> action of the Mouse package with the <b>Middle Button</b> and <b>Click</b> options selected.
	Double Click	Migrated to the <b>Click</b> action of the Mouse package with the <b>Left Button</b> and <b>Double click</b> options selected.
	Set text	Migrated to: <ul style="list-style-type: none"> <li>The <b>Click</b> action of the Mouse package with the <b>Left Button</b> and <b>Click</b> options selected.</li> <li>The <b>Delay</b> action of the Delay package with the <b>Regular</b> delay set to 500 milliseconds.</li> <li>The <b>Simulate keystrokes</b> action of the Simulate keystrokes package.</li> </ul>

The following table provides information about how the Export Dataset command used in the MetaBot logic is migrated to the equivalent actions in Automation 360:

Play type	Enterprise 11 Action	Automation 360 Action
Object	Get Property, Get Total Items, Get Selected Index, Get Selected Text, Select Item by Text, Select Item by Index, Click, Left Click, Right Click, Double Click	Migrated to the <b>Capture</b> action of the Recorder package.
Image	Left Click	Migrated to the <b>Find window in window</b> action of the Image Recognition package with the <b>Left Click</b> selected from the <b>Action</b> list.
	Right Click	Migrated to the <b>Find window in window</b> action of the Image Recognition package with the <b>Right Click</b> selected from the <b>Action</b> list.
	Double Click	Migrated to the <b>Find window in window</b> action of the Image Recognition package with the <b>Double Click</b> selected from the <b>Action</b> list.
	Middle Click	Migrated to the <b>Find window in window</b> action of the Image Recognition package with the <b>Left Click</b> selected from the <b>Action</b> list.

Play type	Enterprise 11 Action	Automation 360 Action
	Get Text	Migrated to the <b>Capture area</b> action of the OCR package.
Coordinate	Click	Migrated to the <b>Click</b> action of the Mouse package with the <b>Left Button</b> and <b>Click</b> options selected.
	Left Click	Migrated to the <b>Click</b> action of the Mouse package with the <b>Left Button</b> and <b>Click</b> options selected.
	Middle Click	Migrated to the <b>Click</b> action of the Mouse package with the <b>Middle Button</b> and <b>Click</b> options selected.
	Double Click	Migrated to the <b>Click</b> action of the Mouse package with the <b>Left Button</b> and <b>Double click</b> options selected.
	Get text	Migrated to: <ul style="list-style-type: none"> <li>• The <b>Click</b> action of the Mouse package with the <b>Left Button</b> and <b>Click</b> options selected.</li> <li>• The <b>Clear</b> action of the Clipboard package.</li> <li>• The <b>Delay</b> action of the Delay package with the <b>Regular</b> delay set to 500 milliseconds.</li> <li>• The <b>Simulate keystrokes</b> action of the Simulate keystrokes package.</li> <li>• The <b>Delay</b> action of the Delay package with the <b>Regular</b> delay set to 500 milliseconds.</li> <li>• The <b>Copy to</b> action of the Clipboard package.</li> </ul>

## Migration of Run Logic command

The **Run Logic** command is used in a bot to run a specific logic from a MetaBot in Enterprise 11. When you migrate that bot, the **Run Logic** command is converted to the **Run** action of the Task Bot package.

The input variables are converted to equivalent variables in Automation 360 and the output variables are migrated to a dictionary variable. You use the key in the dictionary variable to use the associated value. The dictionary variable might contain other variable types, for example, list, value, integer, and array. You can map the variables available in the dictionary variable with other variable types. For example, you can map the list type variable available in the dictionary variable with the list, value, and array type variables.

## Migration of Execute command

The DLLs in the MetaBots use the **Execute** command to run a function from that DLL. After migration to Automation 360, each **Execute** command is converted to **Open, Run function, and Close** actions of the **DLL** package. Information about which function to run from the DLL, which parameters to use, and other details in the **Execute** command is migrated to the **Run** action.

Starting from Enterprise A2019.16 (6448), you can migrate MetaBots that contain DLLs whose return types are different from that of the MetaBot. The following table provides information about the variable type of the output of the MetaBot and the return type of a DLL.

MetaBot variable type	DLL function return type
Value	Two-dimensional array, List, Byte in array (Byte[]), unsigned integers (UInt32, UInt64), signed integers, IDictionary, IList, and unsigned integers in array (UInt16[], UInt32[], UInt64[]), signed Byte
Array	Two-dimensional array, List, unsigned integers (UInt16[], UInt32, UInt64), signed integers, IList, signed Byte and IDictionary

**Note:** The migration of bots that uses IDictionary variable is supported, however, the migrated bots might not return the correct value. This behavior is same as in Enterprise 11 or Enterprise 10.

The following table provides information about the variable type that is passed from the MetaBot and the input type a DLL accepts.

Variable type of MetaBot	Input variable type the DLL accepts
List	Two-dimensional array, list, byte, unsigned integers (UInt16, UInt32, UInt64), signed integers, signed Byte, byte in array (Byte[]), and unsigned integers in array (UInt16[], UInt32[], UInt64[])
Array	Two-dimensional array, list, byte, unsigned integers (UInt16, UInt32, UInt64), signed integers, signed Byte, byte in array (Byte[]), and unsigned integers in array (UInt16[], UInt32[], UInt64[])
Value	Byte, unsigned integers (UInt16, UInt32, UInt64), signed integers, signed Byte
Dictionary	Byte, unsigned integers (UInt16, UInt32, UInt64), signed integers, signed Byte

## How AAApplicationPath variable is migrated

The AAApplicationPath variable is used in Enterprise 11 and Enterprise 10 to specify the physical path of a bot or file that is used in the current bot. The AAApplicationPath system variable returns the path that is set in **Tool > Option** of what is known as the "client application".

## Migrating from Enterprise 11 using restored Enterprise 11 database

When you migrate to Automation 360 using a restored Enterprise 11 database, the migration process performs the following actions:

- Creates the AAAApplicationPath global value when the first bot is migrated using the Bot Migration Wizard.
- Copies the value for the AAAApplicationPath system variable specified for each user in Enterprise 11 and sets that value to the AAAApplicationPath global value for all these users in Automation 360.
- Updates references you have used in Enterprise 11 bots with the AAAApplicationPath global value available in the Automation 360 Control Room, eliminating any requirement to update the migrated bots to use the AAAApplicationPath.
- Updates the path in the **Run Task** command set in the Enterprise 11 bot. For example, if the path in the **Run Task** command is set to \$AAAApplicationPath\$\Automation Anywhere\My Tasks\child-task.atmx in Enterprise 11, this path is automatically converted to Bots\My Tasks\child-task.atmx after migration.

Therefore, no manual update is required and the bot runs as is after migration.

---

**Important:** When you migrate bots using the Bot Migration package, you must manually create the AAAApplicationPath global value. After you have created the AAAApplicationPath global value, all users who have used the AAAApplicationPath system variable in Enterprise 11 must update the AAAApplicationPath global value with the value that is used in Enterprise 11.

See [Migrate from Enterprise 11 using a restored Enterprise 11 database](#).

---

## Migrating from Enterprise 10

When you migrate from Enterprise 10, you must manually create the AAAApplicationPath global value in Automation 360 with the **CAN be changed** option selected. After you have created the AAAApplicationPath global value, all users who have used the AAAApplicationPath system variable in Enterprise 10 must update the AAAApplicationPath global value with the value that is used in Enterprise 10. This update ensures that when you run the bot in Automation 360, the AAAApplicationPath folder value is uniquely resolved for each user.

Example: If the Enterprise 10 path value for AAAApplicationPath is D:\John.Doe\My Documents\Automation Anywhere Files, then you must create the AAAApplicationPath global value in Automation 360 and update with this path.

---

**Note:** Bot Runners and Bot Creators must update the global value for the AAAApplicationPath in the Control Room before they run migrated bots in Automation 360.

---

See [Prepare for Enterprise 10 to Automation 360 On-Premises migration](#) on page 1577.

## Manually migrating from Enterprise 11 or Enterprise 10

When you manually migrate from Enterprise 11 or Enterprise 10, you must manually create the AAAApplicationPath global value in Automation 360 with the **CAN be changed** option selected. After you have created the AAAApplicationPath global value, all users who have



used the AAApplicationPath system variable in Enterprise 11 or Enterprise 10 must update the AAApplicationPath global value with the value that is used in Enterprise 11 or Enterprise 10.

See [Prerequisites for manual migration](#) on page 1561.

## AASettings in Automation 360 after migration

After you migrate to Automation 360, some of the values available in AASettings in Enterprise 11 can be configured.

The following table shows the keys, descriptions, values allowed, default values, and what's supported in Automation 360 (scroll to the right to view the columns):

Key	Description	Values allowed	Default value	Supported in Automation 360
allowaddingdefaultnamespace	<p>Allows you to enable DefaultNSPrefix. In the XML package, when you insert a node into the XML file, DefaultNSPrefix is no longer added. In the <b>Advanced</b> view tab of the insert a node action, xmlns (the default XML namespace) is not allowed either as a prefix or as an attribute.</p> <hr/> <p><b>Note:</b> If DefaultNSPrefix is enabled and the value of allowaddingdefaultnamespace is set to True, when you insert or update a new node as an empty node, a newline character will be added and indentation will be lost.</p> <hr/>	True, False	False	No

Key	Description	Values allowed	Default value	Supported in Automation 360
allowlowersecurity	Allows you to lower the security cipher for connecting to mainframe hosts that use SSL connections with lower security cipher.	True, False	False	No
applyshiftkeyfix	Allows you to check for any missing special key in child bots and executes the key if the special key is missing.	0, 1	0	No
capturehtmlwithjs	Allows you to enable capturing HTML by MetaBot screen capture.	True, False	True	No
citrixchanneltimeout	Allows you to set the Citrix channel timeout value for the Citrix remote agent.	Integer	--	No
closebrowserbyhandle	Allows you to enable CloseInstanceByhandle if CloseInstanceByprocess fails.	0, 1	0	No
connectionretryattempts	Allows you to configure the number of attempts to try for connecting to the mainframe if connection to the mainframe failed.	Integer	3	No

Key	Description	Values allowed	Default value	Supported in Automation 360
connectionretryinterval	Allows you to configure the timeout value, in milliseconds, to wait before attempting the next connection.	Integer	3000	No
connectiontimeout	Allows you to configure the timeout value, in minutes, for database connections. We recommend that you configure this timeout value to 30 minutes.	Integer	30	No
CustomDateFormat	Allows you to set a custom date format.	String (mm/dd/yyyy HH:mm:ss)	--	No
DecimalPlaces	Allows you to configure the number of decimal places for digits used in the Number element.	Integer from 0 to 16	4	No
enablesetfocusapi	Allows you to configure the SetFocus API for Oracle applications.	True, False	False	No
fetchemailretrycount	Allows you to configure the number of retries for fetching emails.	Integer	3	No
findiewndatmpt	Allows you to use the MetaBot recorder to search for objects.	Integer	5	No

Key	Description	Values allowed	Default value	Supported in Automation 360
ietimeoutvalue	Allows you to configure the timeout value for capturing MetaBot screens.	Integer	240	No
IETimeoutValue	Allows you to configure the maximum timeout value, in seconds, for loading a webpage on Internet Explorer.	Integer	240	No
IsEnabled	Allows you to check whether the decimal places option in the Number element is enabled or disabled.	True, False	False	No
isremoteobjectdetected	Allows you to enable automation of Citrix XenApp through the Enterprise Client.	True, False	False	No
iterationtoverify	Allows you to configure the number of retries to verify a value in a cell.	Integer	3	No
keystrokedelay	Allows you to configure a delay between the up and down keys in an Excel table.	Integer	25	No
legacybehaviourforcomma	Allows you to retain the legacy behavior for the comma sign.	True, False	True	No

Key	Description	Values allowed	Default value	Supported in Automation 360
multithreadlogic	Allows you to enable or disable multithreading.	0, 1	1	No
NormalizationForm	Allows you to verify whether string normalization is available.	NFC, NFD, NFKC, NFKD	--	No
ParallelThreadCount	Allows you to configure the number of links that can be processed at a time.	Integer	10	No
perchardelay	Allows you to configure the delay between entering two characters as input.	Integer	0	No
percommanddelay	Allows you to configure the delay between running keystroke commands.	Integer	0	No
readvirtualproperty	Allows you to enable the GetvirtualAccessibleName API.	True, False	True	No
readwithsystemencoding	Allows you to configure the default encoding for the system.	True, False	True	No
restclienttype	Allows you to execute REST Web Service.	restsharpclient, nativerestclient	restsharpclient	No
retainexcelcellrow	Allows you to revert the behavior of ExcelCellRow to Enterprise 11 version 11.3.1 or earlier.	True, False	False	No

Key	Description	Values allowed	Default value	Supported in Automation 360
screenchangewaittime	Allows you to configure the timeout value, in milliseconds, to wait for the application after sending certain keys because the screen might change after sending some keys.	Integer	5	No
searchinmultiplewindows	Allows you to check for windows with the same name.	0, 1	0	No
ShutDownTimeout	Allows you to configure the timeout value for the <b>Shutdown</b> action in the System package.	Integer	30000	No
skipappnames	Allows you to check whether the application is Oracle.	Comma-separated application starting name.  For example, if the application window title is Test Application, then it should contain the following value: Test,abc,xyz	--	No
textplayirpercentage	Allows you to configure the match percentage of the image recognition based control finding in the legacy AISense Recorder.	Integer from 0 to 100	95	No

Key	Description	Values allowed	Default value	Supported in Automation 360
timeout	Allows you to configure the HTTP request timeout value for the REST Web Service command.	String	60000	No
Timeout	Allows you to configure the timeout value for each web response while traversing through webpages.	Integer	10	No
usesinglethreading	Allows you to enable or disable single threading.	True, False	True	No
version	Allows you to select multiple versions of keystroke commands in Enterprise 11.	Integer	1	No
WaitForPageLoad	Allows you to configure additional delay for loading webpages in MetaBot and Recorder.	0, 1	0	No
WaitForWindow	Allows you to configure the wait time for window.	Integer	30	No
WaitForWindowClosed	Allows you to check whether the wait time for window is enabled.	0, 1	0	No
windowactivationmode	Allows you to activate Window using a None key.	0, 1, 2	0	No

Key	Description	Values allowed	Default value	Supported in Automation 360
windowresize	Allows you to disable the resizing of window during execution.	True, False	True	No

## Enable schedules after migration

When you copy Enterprise 10 data to Automation 360, the Enterprise 10 schedules are migrated. Version Enterprise 11 schedules are migrated when you update the Enterprise 11 data to Automation 360.

After you migrate a bot associated with a schedule, the system automatically replaces the .atmx bot within that schedule with the Automation 360 bot. Migrated schedules are inactive and do not have associated devices, so some dependencies must be remapped in the Automation 360 environment.

To reenable migrated schedules, follow these steps:

1. Confirm that the bot linked to the schedule has been successfully migrated.  
Migrated schedules only point to successfully migrated bots. If a bot migration fails, then the associated schedule continues pointing to the .atmx bot.
2. Install the Bot Agent on your Bot Runner devices.  
[Install Bot Agent and register device](#) on page 1347
3. Edit the schedule to add relevant devices.  
[Schedule a bot](#) on page 2129
4. Enable the schedule by clicking **Enable** after you have provided the required information for scheduling a bot.  
[Schedule a bot](#) on page 2129

Related concepts

[Migrate to Automation 360](#) on page 1496

Migration (upgrade) is the process of moving your data and bots from Enterprise 11 or Enterprise 10 to Automation 360. Migration includes but is not limited to replicating and updating your existing database and repository, converting your bots to the Automation 360 format, and migrating learning instances for IQ Bot and dashboards for Bot Insight.

Related tasks

[Copy Enterprise 10 data](#) on page 1581

You must copy the Enterprise 10 data to Automation 360 before you convert the Enterprise 10 bots.

[Copy and paste Enterprise 11 information to Automation 360](#) on page 1565

The Enterprise 11 server repository files and the Credential Vault file are required in the Automation 360 environment. The most efficient way to get this data is to copy it from the Enterprise 11 environment into Automation 360.

[Migrate Enterprise bots](#) on page 1590

The bot migration process uses the Bot Migration Wizard to convert Enterprise 11 or Enterprise 10 bots (Task Bots and MetaBots) in .atmx and .mbot format to the .bot format used in



Automation 360 and uploads the successfully migrated bots to the Control Room public workspace.

## Pause and resume bot migration

You can pause and then resume the paused bot migration. You might want to pause a bot migration if you want to perform a high-priority task on the same Bot Runner device on which the bot migration is running.

You must have the required permissions to start bot migration.

- Pause and resume bot migration when only one Bot Runner is used for bot conversion:
  - a) Select the active bot migration you want to pause from the **Activity > In progress** page.
  - b) Click the pause icon in the bot Launcher or on the **In progress** page.  
The system pauses the bot migration. The status of bot migration is listed on the following:
    - The **Activity > In progress** page and marked as paused.
    - The bot migration on the **Administration > Migrations** page, where the status is displayed as paused.
    - The **Bot migration report** tab, where the status of the bot that was being converted and the bot migration that was paused is set as paused. The status of all other bots that were not converted is set as pending.
  - c) Select the paused bot migration that you want to resume from the **Activity > In progress** page.
  - d) Click the resume icon in the bot Launcher or on the **In progress** page.  
The system resumes the paused bot migration. The details status of the resumed bot migration is available on the following:
    - The **Activity > In progress** page where the status is marked as active.
    - The **Administration > Migrations** page where the status is marked as in progress.
    - The **Bot migration report** tab, where the status of the bot that was being converted and the bot migration was paused is set as in progress.
  
- Pause and resume bot migration on some of the Bot Runners when multiple Bot Runners are used for bot conversion:
  - a) Select the active bot migration you want to pause from the **Activity > In progress** page.
  - b) Click the pause icon on the toolbar to pause the selected migration processes.  
The system pauses the selected migration processes that were running on various Bot Runners. The status of the paused bot migration is displayed on the **Activity > In progress** page and marked as paused.  
  
There is no change in the status of the bot migration on the **Administration > Migrations** page and on the **Bot migration report** tab.
  - c) Select the paused bot migrations you want to resume from the **Activity > In progress** page.
  - d) Click the resume icon on the toolbar to resume the selected paused bot migration.  
The system resumes the bot migration for the selected Bot Runners. The status of Bot Runners for which the bot migration is resumed is displayed on the **Activity > In progress** page and marked as active.

The status of the bot migration on the **Administration > Migrations** page is displayed as in progress.

- Pause a bot migration for all Bot Runners when multiple Bot Runners are used for bot conversion.
  - a) Select all the active bot migration you want to pause from the **Activity > In progress** page.
  - b) Click the pause icon on the toolbar to pause the selected bot migration.

The system pauses the selected bot migrations that were running on various Bot Runners. The entry for all the paused migration processes is available on the following:

    - The **Activity > In progress** page and marked as paused.
    - The **Administration > Migrations** page where it is displayed as paused.
    - The **Bot migration report** tab, where the status of the bots for which migration has not started is set as paused.
  - c) Select all the paused bot migration you want to resume from the **Activity > In progress** page.
  - d) Click the resume icon in the bot Launcher or on the **In progress** page for all Bot Runners.

The system resumes the paused the bot migration. The status for all the Bot Runners is available on the following:

    - The **Activity > In progress** page and marked as active.
    - The **Administration > Migrations** page where it is displayed as in progress.
    - The **Bot migration report** tab, where the status of the bot that was being converted and the bot migration was paused is set as in progress.

## Stop bot migration

You can stop an in-progress bot migration if that bot migration is not progressing or is not responding.

You must have the required permissions to start bot migration.

1. Select the active bot migration that you want to stop from the **Activity > In progress** page.
2. Click the stop icon in the bot Launcher or on the **In progress** page.

The system immediately terminates the bot migration. The status of the stopped bot migration is listed on the following:

  - The **Activity > Historical** page and marked as failed.
  - The **Administration > Migrations** page, where it is displayed as unsuccessful.
  - The **Bot migration report** tab, where the status of the bot that was being converted and the migration process that was stopped is set as unsuccessful. The status of all other bots that were not converted is set as pending.
  - The **View historical activity** page for the entry shows the reason for the failure.

## Validating and updating bots after migration

Migrated bots are uploaded to the public repository of the Automation 360 Control Room (in the same folder containing the equivalent .atmx files). You can review the current status of the

migrated bots and any errors encountered due to unsupported commands or attributes available in those bots from the **Migration List** page.

It is important that you review, test, and verify all migrated bots to ensure that they run successfully in the Automation 360 environment.

The migration assistant is merged with the error assistant to provide a comprehensive view of all the lines in a bot that require review or action by you, or which have errors in these and therefore require you to address them. This feature helps you to quickly identify the areas of bots that require your attention. Before testing any bot, scroll through the entire migrated bot from the first to last line so that the Migration Assistant flags any issues.

If you do not review the entire bot, you might see a `failed to compile` error.

## Updating your bots

If a bot requires any modifications based on the migration reports or testing phase, you can edit the bot:

1. Check out the bot from the public repository into a private repository.
2. Use the Migration Assistant to view changes to migrated bots.

The Migration Assistant will guide you for any required changes and provide opportunities to leverage new Automation 360 features.

3. Edit the bot in the Bot editor if required.

You can run the bot directly from the Bot editor as you modify your bot and test the process steps.

Perform these steps in your Development (DEV) environment. After the migrated bots clear your preset pass criteria, move them to the User Acceptance Testing (UAT) environment to test the bots against production-like systems with larger datasets.

Only when the bot clears the UAT requirements should you deploy it in a Production (PROD) environment. This process is part of the typical industry standard software development lifecycle (SDLC) best practices.

## Moving bots using Bot Lifecycle Management

Use Bot Lifecycle Management to move bots from one environment to another. After you have tested and successfully run the migrated bots in the development (DEV) environment, you can use Bot Lifecycle Management to move the bots from the development environment to the UAT environment. Similarly, you use Bot Lifecycle Management to move the bots from the UAT production (PROD) environment.

When you move bots, if the following error occurs `"Can't create directory: <directory name>"`, see [Unable to import or export the bots from v11 to Automation 360 \(A-People login required\)](#).

## Bot compatibility version

After migration, if you remove the `AAApplicationPath` from the destination path and the bot compatibility version is set to **1**, the bot deployment fails. This occurs because in version 1 the

file path is parsed during compilation time. Depending on the Control Room device (Linux or Windows), the file or folder paths might differ causing an error when this path is parsed during bot compilation time.

---

**Recommendation:** Change the bot compatibility version to **2**. In this version, the file path is parsed during bot runtime depending on the device on which the bot runs.

---

When you migrate the bots from Enterprise 11 to Automation 360, the bots have a default bot compatibility version of 1. If you change the bot compatibility version from 1 to any other version (such as 2, 3, or 4) and your bot or file path contains a combination of forward and backward slashes, the bot execution fails with an error to verify the path.

Consider the following scenarios to understand how changing the bot compatibility version affects the migrated bots.

Scenario 1:

- Bot compatibility version: Retained as 1
- Input path: `c:\test\foo.pdf`
- Path during compilation: Remains the same as input path, that is `c:\test\foo.pdf`
- Result: Bot executes successfully

Scenario 2:

- Bot compatibility version: Changed to 2, 3, or 4
- Input path: `c:\test\foo.pdf`
- Path during compilation: Modified to `c:\test\foo.pdf`
- Result: Bot execution fails

You can either retain the bot compatibility version as 1 for the migrated bots or change the bot or file path for those bots containing a combination of forward and backward slashes in their path.

See the following video on how to validate changes made to migrated bots:

Related reference

[Package mapping for migration](#) on page 1620

This page contains information about Enterprise 10 and Enterprise 11 commands and how they map to respective Automation 360 actions or packages. In some cases, an Enterprise 10 or Enterprise 11 command migrates to more than one Automation 360 action. This is to ensure that the behavior of the migrated bot is unchanged.

[Variable mapping for migration](#) on page 1655

In migration, some variables map directly from previous product versions to Automation 360 while others behave differently or contain configuration changes.

## Package mapping for migration

This page contains information about Enterprise 10 and Enterprise 11 commands and how they map to respective Automation 360 actions or packages. In some cases, an Enterprise 10 or Enterprise 11 command migrates to more than one Automation 360 action. This is to ensure that the behavior of the migrated bot is unchanged.

Automation 360 has a new package called **Legacy automation**. This package provides the additional support needed during migration. The **Legacy automation** package is for use during

migration only; we do not recommend using this package for new bot development. [Legacy Automation package](#) on page 2765

You can migrate bots when the user doing the migration is using an authenticated proxy server.

**Note:** For a list of packages and actions that support migration and conversion of Internet Explorer bots from Enterprise 11 or Enterprise 10 to Automation 360 with **Edge with IE mode**, see [Packages and Actions](#).

## Active Directory

Respective **Active Directory** commands are migrated within the **Connect** and **Disconnect** actions. Each command is migrated as follows:

Enterprise 11 or Enterprise 10 commands	Equivalent Automation 360 actions and packages
<b>Create user</b>	<b>Create user</b>
<b>Modify group</b> command with the <b>Rename group</b> option selected	<b>Rename group</b>
<b>Modify group</b> command with the <b>Delete group</b> option selected	<b>Delete group</b>
<b>Modify group</b> command with the <b>Add users to group</b> option selected	<b>Add users to group</b>
<b>Modify group</b> command with the <b>Remove users from group</b> option selected	<b>Remove users from group</b>
<b>Modify group</b> command with the <b>Set property</b> option selected	<b>Set group property</b>
<b>Modify group</b> command with the <b>Disable user account</b> option selected	<b>Disable user account</b>
<b>Modify group</b> command with the <b>Update user details</b> option selected	<b>Update user details</b>
<b>Modify user</b> command with the <b>Rename user</b> option selected	<b>Rename user</b>
<b>Modify user</b> command with the <b>Delete user</b> option selected	<b>Delete user</b>
<b>Modify user</b> command with the <b>Enable user account</b> option selected	<b>Enable user account</b>
<b>Modify user</b> command with the <b>Update Account Options</b> option selected	<b>Update account options</b>
<b>Modify user</b> command with the <b>Change Password</b> option selected	<b>Change Password</b>
<b>Create object</b> command with the <b>Computer object</b> option selected	<b>Computer object</b>

Enterprise 11 or Enterprise 10 commands	Equivalent Automation 360 actions and packages
<b>Create object</b> command with the <b>Organizational unit object</b> option selected	<b>Create organizational unit</b>
<b>Search</b> command with the <b>Run Query</b> option selected	<b>Run Query</b>
<b>Search</b> command with the <b>Get all users of a Group</b> option selected	<b>Get all users of a group</b>
<b>Get property</b> command with the <b>User</b> option selected	<b>Get user property</b>
<b>Get property</b> command with the <b>Group</b> option selected	<b>Get group property</b>
<b>Get property</b> command with the <b>Computer</b> option selected	<b>Get computer property</b>
<b>Get property</b> command with the <b>Organizational unit</b> option selected	<b>Get organizational unit property</b>
<b>Modify Object</b> command with <b>Computer</b> object type and the <b>Rename Object</b> option selected	<b>Rename computer</b>
<b>Modify Object</b> command with <b>Computer</b> object type and the <b>Delete Object</b> option selected	<b>Delete computer</b>
<b>Modify Object</b> command with <b>Computer</b> object type and the <b>Move Object</b> option selected	<b>Move computer</b>
<b>Modify Object</b> command with <b>Computer</b> object type and the <b>Set Property</b> option selected	<b>Set computer property</b>
<b>Modify Object</b> command with <b>Organizational Unit</b> object and the <b>Rename Object</b> option selected	<b>Rename organizational unit</b>
<b>Modify Object</b> command with <b>Organizational Unit</b> object and the <b>Delete Object</b> option selected	<b>Delete organizational unit</b>
<b>Modify Object</b> command with <b>Organizational Unit</b> object and the <b>Move Object</b> option selected	<b>Move organizational unit</b>
<b>Modify Object</b> command with <b>Organizational Unit</b> object and the <b>Set Property</b> option selected	<b>Set organizational unit property</b>

See [Active Directory package](#) on page 2374.

## App Integration

**App Integration** in Automation 360 does not have actions for each technology, unlike in Enterprise 10/Enterprise 11. In Automation 360, all actions are divided into individual actions.

Enterprise 11 or Enterprise 10 commands	Equivalent Automation 360 actions and packages
<b>App Integration</b> commands that capture text from a window	<b>Capture text from window</b> action of the App Integration package

Enterprise 11 or Enterprise 10 commands	Equivalent Automation 360 actions and packages
<b>Modify group</b> command with the <b>Rename group</b> option selected	<b>Rename group</b>
<b>Modify group</b> command with the <b>Delete group</b> option selected	<b>Delete group</b>
<b>Modify group</b> command with the <b>Add users to group</b> option selected	<b>Add users to group</b>

Enterprise 11 bots that resize the application window when they are deployed can be migrated to Automation 360.

See [App Integration package](#) on page 2423.

## Clipboard

All commands of Clipboard are migrated to equivalent actions of the Automation 360 **Clipboard** package. There is no change in behavior or command name.

See [Clipboard package](#) on page 2447.

## Comment

Comment is migrated to Automation 360 **Comment** action.

If the Comment command contains a variable or a \$ symbol, the command gets disabled after migration.

## Database

Enterprise 10/Enterprise 11 uses ODBC drivers and Automation 360 uses JDBC drivers.

The **SQL Query** action is called **Read from** in Automation 360.

The following table shows the commands that currently can be migrated.

Enterprise 11 or Enterprise 10 commands	Equivalent Automation 360 actions and packages
Connect	Migrates to the <b>Connect</b> command. If you encounter an unsupported connection string in Automation 360, the reasons might vary based on your environment. More details are available as part of the migration process. Contact Technical Support if you need assistance resolving the issue.  0 is not a valid time out value in Automation 360. The migration process replaces 0 with an empty value.

Enterprise 11 or Enterprise 10 commands	Equivalent Automation 360 actions and packages
Run Stored Procedure	<p>The parameter name and output parameter are mandatory fields in Automation 360.</p> <hr/> <p><b>Important:</b> After you migrate the bot, you must provide the parameter name and output parameter type in the <b>Run stored procedure</b> action.</p> <hr/>

See [Database package](#) on page 2466.

## Delay

Delay command is migrated to the **Delay** action in Automation 360. "Delay in Milliseconds" and "Delay in Seconds" options (Enterprise 11) have changed to radio options within the **Time unit** area (Automation 360). See [Delay package](#) on page 2492.

## Email

There are no sessions for Email commands in Enterprise 10 or Enterprise 11. However, Automation 360 includes **Connect** and **Disconnect** actions to ensure email sessions are started and closed. Therefore, during migration, the **Connect** action is placed before the respective email action and the **Disconnect** action after the respective email action.

The **Save attachment** option of the **Get All Messages** command is now a dedicated action called **Save attachment** in the **Email** package in Automation 360.

For bots created to automate email-related tasks on the Exchange Web Services (EWS) server, the **Get All Message** command is migrated to the **Loop** action with the iteration set to **For all each mail in mailbox**. Similarly, the **Delete** and **Delete all** commands are migrated to **Delete** and **Delete all** actions.

When you migrate Enterprise 11 bots that contain the Email package with **Authentication type** set to OAuth2, most of the parameters included in the package migrate to the same values in Automation 360. However, the following parameters migrate with different values:

- The **IMAP** and **POP3** protocols migrate to the corresponding Email server in Automation 360.
- The **Use Local timezone** migrates to the **Loop** action as a Boolean value in Automation 360.

See [Email package](#) on page 2517.

## Error Handling

Disabled Error Handling commands are not migrated to Automation 360.

**Begin Error Handling** and **End Error Handling** is migrated to the **Try/Catch** block of the Error handler package in Automation 360. Many options available in Begin Error Handling are migrate to respective Automation 360 actions.



**Note:** To avoid an exception error when you use the **Try/Catch** block in a Loop, we recommend that you validate all the command inputs.

Refer the below table for details:

Enterprise 11 or Enterprise 10 commands	Equivalent Automation 360 actions and packages
Continue	By default, execution continues after executing the <b>Catch</b> block in Automation 360.
Stop	<b>Stop</b> action of the <b>Task</b> package is added in the <b>Catch</b> block.
Take Snapshot	<p>When the <b>Take Snapshot</b> option is selected and the location is provided in the <b>File Path</b> field of the Enterprise 11 bot, the migrated bot contains:</p> <ul style="list-style-type: none"> <li>• The <b>Capture desktop</b> action of the Screen package to capture the error screen.</li> <li>• The <b>Log to file</b> action of the Log To File package to capture the error message in a text file.</li> <li>• The <b>To string</b> action of the Datetime package to convert the datetime value to string that will be stored in the text file along with the error message.</li> </ul> <p>The above actions are added in the <b>Catch</b> block of the migrated bot and the captured image and the error message are stored at the location provided in the <b>File Path</b> field of the Enterprise 11 bot.</p> <p>When the <b>Take Snapshot</b>, <b>Send Email</b>, and <b>Attach Sanpshot</b> options are selected and the location is not provided in the <b>File Path</b> field in the Enterprise 11 bot, the migrated bot contains the following:</p> <ul style="list-style-type: none"> <li>• The <b>Create</b> action of the Folder package to create a temporary location to store the captured image and the text file that contains the error message.</li> <li>• The <b>Capture desktop</b> action of the Screen package to capture the error screen.</li> <li>• The <b>Log to file</b> action of the Log To File package to capture the error message in a text file.</li> <li>• The <b>To string</b> action of the Datetime package to convert the datetime value to string that will be stored in the text file along with the error message.</li> <li>• The <b>Send</b> action of the Email package to send an email notification with the image and text file attached.</li> <li>• The <b>Delete</b> action of the File package to delete the image and text file stored in the temporary location.</li> </ul> <p>The above actions are added in the <b>Catch</b> block of the migrated bot.</p>
Run Task	<p><b>Run</b> action of the <b>Task</b> package is added in <b>Try</b> block.</p> <p>When a child bot encounters an error, the bot continues with the execution of the next action of the parent bot.</p>

Enterprise 11 or Enterprise 10 commands	Equivalent Automation 360 actions and packages
Log Data into File	<b>Log to File</b> action is added in <b>Catch</b> block.
Send Email	<b>Send</b> action from the <b>Email</b> package is added to the <b>Catch</b> block. The Task Bot variables and variable values sent as email attachment using the Attach Variable option are also migrated.
Variable Assignment	<b>Assign</b> action of the <b>String</b> package is added with respective the condition in the <b>Catch</b> block.

See [Error handler package](#) on page 2552.

## Excel

The Enterprise 10/Enterprise 11 Excel commands are migrated to respective Automation 360 actions of the **Excel Advanced** package.

In Enterprise 11, a bot can open a Microsoft Excel spreadsheet even when a file extension is not provided. In Automation 360, the migrated bots uses the **Open** action in the Excel advanced package to open a Microsoft Excel spreadsheet when a file extension is not provided.

In Enterprise 10/Enterprise 11, data returned by **Get Multiple Cells** and **Get All Cells** commands are returned to the **Loop > Each Row in an Excel Dataset** command. In Automation 360, the functionalities of **Get Multiple Cell** and **Get All Cells** are available in **Loop > Each Row in an Excel Dataset** action, so values from these commands are migrated to the loop instead of actual actions.

Bots that use the **Get Single Cell** command with the **Specific cell** and **Get Cell Value** options are migrated to the **Get single cell** action of the Excel advanced package with the **Specific cell** and **Read cell value** options selected after migration.

When you run a migrated bot with the **Excel Advanced > Cell range** option, ensure that you use a numeric value as the last character in the **From cell** and **To cell** fields (for example, testa1). The last character cannot be an alpha character.

The following table shows action name changes:

Enterprise 11 or Enterprise 10 commands	Equivalent Automation 360 actions and packages
Save Spreadsheet	Save workbook
Open Spreadsheet	Open
Close Spreadsheet	Close  <b>Note:</b> When you migrate a bot with <b>Excel: Close</b> action, in Enterprise 10/Enterprise 11, the bot ignores the <b>Save</b> option for the read-only file, whereas in Automation 360, the following prompt is displayed: <b>The File already exists.</b>

Enterprise 11 or Enterprise 10 commands	Equivalent Automation 360 actions and packages
Get Cells	Divided into <b>Get single cell</b> and <b>Get multiple cells</b> actions <hr/> <b>Note:</b> The <b>Get Cells</b> action retrieves output in different formats for Enterprise 10/Enterprise 11 and Automation 360 for specific data types such as Boolean and Date.
Activate Sheet	Switch to sheet <hr/> <b>Note:</b> In Enterprise 11, the bot containing the <b>Activate Sheet</b> command does not switch to and perform operations on a hidden worksheet. However, after migration to Automation 360, the bot containing the equivalent <b>Switch to worksheet</b> action switches to the hidden worksheet and performs operations on it. After the operations are completed, the worksheet remains hidden and is not activated.
Find/Replace	Divided into <b>Find</b> and <b>Replace</b> actions When you migrate a bot with the <b>Excel &gt; Find</b> action and if the value is present at the beginning of a cell address, the migrated bot retrieves the same output results in a different sequence for the <b>Find Text</b> for Enterprise 11 and Automation 360. For example, if A2, B5, and D15 cell addresses have the value XYZ and you search for XYZ in the range A2:D15, the Enterprise 11 bot collects the result in the sequence: B5, D15, and A2. However, the migrated bot will collect the result in a different sequence: A2, B5, and D15, after migrating to Automation 360.

See [Excel advanced package](#) on page 2565.

- In Enterprise 11 or Enterprise 10 and in Automation 360, a session (used to open a Microsoft Excel spreadsheet) can be shared between the parent bot and a child bot. In Automation 360, you can close a shared session from the child bot.

**Note:** When you use more than one spreadsheet to automate an operation, you must use different session names for each spreadsheet. If you want to use the same session name to automate all the spreadsheets, you must first close the session of one spreadsheet before using the same session name for another spreadsheet.

- In Enterprise 11 or Enterprise 10, when you try to save a read-only spreadsheet, an error is not displayed. However, in Automation 360, when you try to save a read-only spreadsheet, an error message that the workbook cannot be saved is displayed.

Workaround: Ensure that you have the **Edit** access for the file and retry the operation. If the issue persists, contact your system administrator. The **Write** action is not allowed on such files.

## File and Folder

All commands of **File/Folder** have been split into **File** and **Folder** packages.

The following **File** related actions have changed in Automation 360:

Enterprise 11 or Enterprise 10 commands	Equivalent Automation 360 actions and packages
Copy Files	Copy action of the File package
Create Files	Create action of the File package
Create File Shortcut	Create shortcut action of the File package
Delete Files	Delete action of the File package
Open Files	Open action of the File package
Print Files	Print action of the File package
Rename Files	Rename action of the File package
Unzip Files	Unzip action of the Folder package
Zip Files	Zip action of the Folder package

The following **Folder** related actions have changed in Automation 360:

Enterprise 11 or Enterprise 10 commands	Equivalent Automation 360 actions and packages
Copy Folder	Copy action of the Folder package
Create Folder	Create action of the Folder package
Create Folder Shortcut	Create shortcut action of the Folder package
Delete Folder	Delete action of the Folder package
Open Folder	Open action of the Folder package
Rename Folder	Rename action of the Folder package

See [File package](#) on page 2600 and [Folder package](#) on page 2612.

Enterprise 11 bots can use regular expressions in the **Copy Files**, **Delete Files**, **Print Multiple Files**, **Rename Files**, and **Zip Files** commands to search for files on which you want to perform an operation. The equivalent actions in Automation 360 too can use regular expressions to search for files on which you want to perform an operation.

## FTP/SFTP

All commands of **FTP/SFTP** are migrated to equivalent Automation 360 actions of the **FTP/SFTP** package. There is no change in behavior or command name.

**Get files** and **Get folder** actions return runtime errors if they have additional criteria based on dates, which are provided as variables that have values in a format other than MM/DD/YYYY. You must fix such instances after bot migration. During the migration process, these two actions also add extra error handlers in the migrated bots when filtering is done on datetime.

In Enterprise 11, if a bot was using the FTP / SFTP commands, after migration, the respective FTP / SFTP actions are assigned a local session in Automation 360.

## If/Else

Variables containing string condition

" If " with the following operators is migrated as a String condition in Automation 360:

- =
- < >
- Include
- Does not Include

For the **Random** variable of the **String** subtype, Automation 360 adds the **Generate random string** action of the **String** package to generate a random string above the If condition and assigns the value to the respective migrated variable.

Variable containing number condition

" If " with the following operators is migrated as a Number condition in Automation 360:

- >=
- <=
- >
- <

For the **Random** variable of the **Number** subtype, Automation 360 adds the **Assign a random number** action of the **Number** package to generate a random string above the If condition and assigns the value to the respective migrated variable.

Value type variable containing date

The system tries to evaluate if a condition on a variable has a date value. If found, it migrates If with the Datetime condition in Automation 360. Otherwise, the system migrates it as a string or number condition based on the operator used. In those cases, you must change it to a date condition after the bot migration if a date operation is involved.

Additionally, you might also have to change the date format to one that is compatible with your data. The default format used to convert a date to string is `MM/dd/yyyy HH:mm:ss`.

See [If package](#) on page 2724.

Image Recognition

The **If** command with the **Image Recognition** condition in Enterprise 10/Enterprise 11 can become one of the following actions in Automation 360 based on the selected Enterprise 10/ options:

- If > **Image file is found in image file** – Created if Image1 has the **From File** option selected and Image2 has the **From File** option selected in Enterprise 10 or Enterprise 11.
- If > **Image file is found in a window** – Created if Image1 has the **From File** option selected and Image2 has the **From Window** option selected in Enterprise 10 or Enterprise 11.
- If > **Window is found in image file** – Created if Image1 has the **From Window** option selected and Image2 has the **From File** option selected in Enterprise 10 or Enterprise 11.
- If > **Window is found in a window** – Created if Image1 has the **From Window** option selected and Image2 has the **From Window** option selected in Enterprise 10 or Enterprise 11.

See [If package](#) on page 2724.

**Important:** If a condition involves date, under certain situation, you must change the migrated information to a date condition after the bot migration.

The table below shows how various conditions are migrated to the respective Automation 360 conditions.

Enterprise 11 or Enterprise 10 commands	Equivalent Automation 360 actions and packages
Task Successful or Task Unsuccessful	Migrated to the equivalent <b>If</b> condition of <b>Task Bot</b> package.
Script Successful or Script Unsuccessful	Script successful/unsuccessful is migrated to respective <b>If &gt; Script Successful</b> and <b>If &gt; Script Unsuccessful</b> actions of the <b>Legacy automation</b> package.
Object Properties	Migrated to the <b>If &gt; Condition &gt; Window Exists</b> and <b>Object</b> conditions of the <b>Recorder</b> package.
Application Running or Application Not Running	Migrated to the equivalent <b>If</b> condition of the <b>Application</b> package.
File Exists, File Does Not Exist, File Date, File Size	Migrated to the equivalent <b>If</b> condition of the <b>File</b> package.
Folder Exists or Folder Does Not Exist	Migrated to the equivalent <b>If</b> condition of the <b>Folder</b> package.
Ping Successful Or Ping Unsuccessful	Migrated to the equivalent <b>If</b> condition of the <b>Ping</b> package.
Web Control Exists or Web Control Does Not Exist	Migrated to the equivalent <b>If</b> condition of the <b>Legacy Automation</b> package.

Enterprise 11 or Enterprise 10 commands	Equivalent Automation 360 actions and packages
Window Exists/Window Does Not Exist	<p>The following commands configured with the "Show child and hidden windows" option selected are migrated to the Automation 360 <b>Legacy Automation</b> package:</p> <ul style="list-style-type: none"> <li>• <b>If &gt; Condition &gt; Window Exists</b></li> <li>• <b>If &gt; Condition &gt; Window Does Not Exist</b></li> </ul>
Logic Successful/Logic Unsuccessful	<p>The <b>If</b> command is migrated to <b>If &gt; Task Successful</b> and <b>If &gt; Task Unsuccessful</b> respectively.</p> <p>The <b>Else If</b> command is migrated to <b>Else If &gt; Task Successful</b> and <b>Else If &gt; Task Unsuccessful</b> respectively.</p> <p>Bots that use the <b>Logic Successful</b> or <b>Logic Unsuccessful</b> condition and return an output variable to the parent bot, can be migrated to Automation 360.</p> <p>Bots that use Credential Vault variables are passed from one MetaBot Logic to another MetaBot Logic for both <b>IF &gt; Logic Successful</b> and <b>IF &gt; Logic Unsuccessful</b> commands.</p> <p>You can migrate a MetaBot with a Logic (parent) that includes a renamed Logic (child). If a child Logic is renamed after it is mapped to the parent Logic, this parent Logic mapping is migrated with the new name.</p> <p>Applies from v.25: Enterprise 11 or Enterprise 10 bots that use the <b>If &gt; Logic Successful</b> or <b>If &gt; Logic Unsuccessful</b> command are migrated when a referred MetaBot Logic name is renamed or has changed the relative path after mapping. If a MetaBot Logic is renamed or changed the path after being mapped in the <b>TaskBots</b>, then the <b>TaskBots</b> are now migrated with the new MetaBot Logic name or path.</p> <p>For information about how a bot is migrated if the <b>Logic Successful</b> command passes a Credential Vault variable, see <a href="#">Run Logic</a> on page 1643.</p>
Service is running/Service is not running	<p>The <b>If</b> command is migrated to <b>If &gt; Service is running</b> and <b>If &gt; Service is not running</b>.</p> <p>The <b>ElseIf</b> command is migrated to <b>Else If &gt; Service is running</b> and <b>Else If &gt; Service is not running</b>.</p>

## Image Recognition

The **Image Recognition** command is split into **Find file image inside window image** and **Find window image inside another window image** actions in Automation 360.

In Automation 360, **Advanced** option is used as the default comparison mode. The other comparison modes (such as **Gray-scale**, **Normal** and **Monochrome**) that existed in Enterprise 10 and Enterprise 11, are hidden in Automation 360 but match the behavior with Automation 360

after migration. The migration process maps the information automatically and does not impact related bots.

When you run a migrated bot with Image Recognition that contains an If, IF/ELSE, or Loop action, an error displays when the window does not exist.

Migration of bots with the **Image Recognition** command might fail if the command is using any file type other than the following:

- .jpg
- .jpeg
- .jpe
- .jfif
- .bmp
- .gif

See [Image Recognition package](#) on page 2731.

## Insert Keystrokes

This command is called **Simulate Keystrokes** in Automation 360. The following keystroke conventions have changed:

Enterprise 11 or Enterprise 10 commands	Equivalent Automation 360 actions and packages
[PAGE UP]	[PAGE-UP]
[NUM LOCK]	[NUM-LOCK]
[SCROLL LOCK]	[SCROLL-LOCK]
[PAGE DOWN]	[PAGE-DOWN]
[CAPS LOCK]	[CAPS-LOCK]
[UP ARROW]	[UP-ARROW]
[LEFT ARROW]	[LEFT-ARROW]
[RIGHT CLICK]	[MENU]
[RIGHT ARROW]	[RIGHT-ARROW]
[DOWN ARROW]	[DOWN-ARROW]
[ALT GR DOWN]	[ALT-GR DOWN]
[ALT GR UP]	[ALT-GR UP]
[\$]	[DOLLAR]

In Enterprise 11 or Enterprise 10, the delay time is divided by the total characters and applied between each character stroke. In Automation 360, the delay you specify applies to the time between each keystroke.

The legacy **Get keystrokes delay** action in Automation 360 supports migrated bots that include the **Simulate keystrokes** action. The legacy **Get keystrokes delay** action matches the duration of delay defined in Enterprise 11 bots for the Insert Keystrokes command and simulates the same



value in Automation 360 for the **Simulate keystrokes** action. After migration, if keystrokes are typed faster (for example, keystrokes used to perform shortcuts in Microsoft 365 Excel), add the **Delay** action after the **Simulate keystrokes** action to ensure that the bots run without issues. The legacy **Get keystrokes delay** action provides similar delay, as seen in Enterprise 11, in the migrated bots to ensure that the migrated bots produce the same output as seen in Enterprise 11. However, this change leads to the command being split into multiple lines after migration.

If the **Encrypt Keystrokes** option is selected in Enterprise 11 or Enterprise 10 bots, after migration the value is stored in the Credential Vault. The migration process creates a locker in the Credential Vault with the following attributes:

- Name of the locker created in Automation 360 is name `AAE_<folder_name>` (folder\_name is the folder in which the migrated bot is available).

The migrated bot uses this locker. Users who have any permission for the folder that contains the bot can access the locker. The migration run-as user must have the **Create standard attributes for a credential** permission.

- A locker contains only one credential for each bot. The name of the credential created is `Keystrokes_<bot_name>` for the Task Bots and `Keystrokes_<Metabot_name>_<Logic_name>` for MetaBots.
- Attributes for the locker are created with the name `Encrypted_keystrokes`.

If a locker, credential, or attribute with the same name is already available, the system appends the locker name, credential name, and attribute name with a numeric value. For example, `AAE_<folder_name>_1`, `Keystrokes_<bot_name>_1`, and `Encrypted_keystrokes_1` respectively. If name of the locker, credential, or attribute is longer than 50 characters, the system trims the characters at the end to limit the name to 50 characters.

---

**Note:** You cannot migrate a bot that is available on the local device and the **Encrypt Keystrokes** option is selected.

---

See [Simulate keystrokes package](#) on page 3070.

## Launch Website

This command is migrated to the **Open** action of the **Browser** package in Automation 360.

Commands with the **Edge** or **Override default browser** option deselected in the legacy product is automatically changed to use **Default Browser** after migration.

Enterprise 11 bots that open a website in a new window of all browsers supported by Automation 360 can be migrated. The Enterprise 11 bots that open the website in a new or an existing tab of the Internet Explorer browser can be migrated to Automation 360. The equivalent option to open the website in a new window, tab, or an existing tab is selected in the migrated bots.

---

**Note:** The support for the Microsoft Edge Legacy browser is no longer available, whereas the Microsoft Edge Chromium browser is supported. As a result, you cannot create new bots using the Microsoft Edge Legacy browser. However, the existing bots created in Microsoft Edge Legacy browser can be updated using other supported browsers such as Google Chrome or Microsoft Edge Chromium browser.

---

See [Browser package](#) on page 2435.

**Important:** If you have created bots in Enterprise 11 or Enterprise 10 using the Microsoft Edge browser, you must first port these bots to another browser, and then you can migrate them.

## Log To File

This command is migrated to **Log to file** action in Automation 360.

See [Log To File package](#) on page 2781.

## Loop

The following table shows how the Loop command is migrated to the equivalent Automation 360 actions and packages:

Enterprise 11 or Enterprise 10 commands	Equivalent Automation 360 actions and packages
Loop command with the <b>Times</b> option selected	Loop action of the Loop package with the <b>For n times</b> option selected.
Loop command with the <b>List</b> option selected	Loop action of the Loop package with the <b>For n times</b> option selected.
Loop command with the <b>Each Row in an Excel Dataset</b> option selected	Loop action of the Loop package with the <b>For each row in worksheet</b> option selected. The system variable <b>\$Excel Column\$</b> used inside the loop is now a user defined variable specified in the same iterator.
Loop command with the <b>Each Row In A SQL Query Dataset</b> option selected	Loop action of the Loop package with the <b>For each row in a SQL query Dataset</b> option selected. The system variable <b>\$Dataset Column\$</b> used inside the loop is now a user defined variable specified in the same iterator.
Loop command with the <b>Each File In A Folder</b> option selected	Loop action of the Loop package with the <b>For each file in a folder</b> option selected. The system variables <b>\$Filename\$</b> and <b>\$Extension\$</b> are now keys name and extension of a dictionary variable specified in the same iterator. In Enterprise 11, the bots does not encounter an error if the folder does not exist. In Automation 360, the migrated bots encounter an error if the folder does not exist.
Loop command with the <b>Each Folder In A Folder</b> option selected	Loop action of the Loop package with the <b>For each folder in a folder</b> option selected. The system variable <b>\$Folder name\$</b> used inside the loop is now a user defined variable specified in the same iterator. In Enterprise 11, the bots does not encounter an error if the folder does not exist. In Automation 360, the migrated bots encounter an error if the folder does not exist.

Enterprise 11 or Enterprise 10 commands	Equivalent Automation 360 actions and packages
Loop command with the <b>Each Row In A CSV/Text File</b> option selected	Loop action of the Loop package with the <b>For each row in CSV/TXT</b> option selected. The system variable <b>\$Filedata Colum\$</b> used inside the loop is now a user defined variable specified in the same iterator.
Loop command with the <b>Each Email Message On Mail Server</b> option selected	Loop action of the Loop package with the <b>For each mail in mailbox</b> option selected. The system variables <b>\$Email Cc\$, \$Email From\$, \$Email Message\$, \$Email Received Date\$, \$Email Received Time\$, \$Email Subject\$, and \$Email To\$</b> are now keys <b>emailCc, emailFrom, emailMessage, emailReceivedDate, emailReceivedTime, emailSubject, and emailTo</b> respectively of a dictionary variable specified in the same iterator.
Loop command with the <b>Each Node In An XML Database</b> option selected	Loop action of the Loop package with the <b>For each node in an XML database</b> option selected. The system variable <b>\$XML Data Node\$</b> used inside the loop is now a user defined variable specified in the same iterator.

The following commands configured with the **Show child and hidden windows** option selected are migrated to the Automation 360 **Legacy Automation** package:

- **Loop > Condition > Window Exists**
- **Loop > Condition > Window Does Not Exist**

Variables containing string condition

" If " with the following operators is migrated as a String condition in Automation 360:

- =
- < >
- Include
- Does not Include

For the **Random** variable of the **String** sub-type, Automation 360 adds the **Generate random string** action of the **String** package to generate a random string above the If condition and assigns the value to the respective migrated variable.

Variable containing number condition

" If " with the following operators is migrated as a Number condition in Automation 360:

- >=
- <=
- >
- <

Variable containing date conditions	<p>For the <b>Random</b> variable of the <b>Number</b> sub-type, Automation 360 adds the <b>Assign a random number</b> action of the <b>Number</b> package to generate a random string above the If condition and assigns the value to the respective migrated variable.</p>
List type variable	<p>The system tries to evaluate if a condition on a variable has a date value. If found, it migrates IF with the Datetime condition in Automation 360. Otherwise, the system migrates it as a string or number condition based on the operator used. In those cases, you must change it to a date condition after the bot migration if a date operation is involved.</p> <p>Additionally, you might also need to change the date format to one that is compatible with your data. The default format used to convert a date to string is <b>MM/dd/yyyy HH:mm:ss</b>.</p> <p>Loop on a variable condition of type List is migrated to either String or Number condition based on the operator used in the condition. The system uses the list index to validate the condition.</p>
Web Control Exists or Web Control Does Not Exist	<p>Loop with <b>Web control exists</b> and <b>Web control does not exist</b> conditions are migrated to <b>Loop &gt; While</b> conditions Web control exists and Web control does not exist of the <b>Legacy Automation</b> package respectively.</p>

See the following table to understand how various conditions are migrated to the respective Automation 360 conditions.

Enterprise 11 or Enterprise 10 conditions	Equivalent Automation 360 actions and packages
Web Control Exists or Web Control Does Not Exist	Migrated to the equivalent If condition of the <b>Legacy Support</b> package.
Object Properties	Migrated to the <b>Object</b> condition of the <b>Recorder</b> package.
Application Running or Application Not Running	Migrated to the equivalent If condition of the <b>Application</b> package.
File Exists, File Does Not Exist, File Date, File Size	Migrated to the equivalent If condition of the <b>File</b> package.
Folder Exists or Folder Does Not Exist	Migrated to the equivalent If condition of the <b>Folder</b> package.
Ping Successful Or Ping Unsuccessful	Migrated to the equivalent If condition of the <b>Ping</b> package.

Enterprise 11 or Enterprise 10 conditions	Equivalent Automation 360 actions and packages
Service is running or Service is not running	Migrated to the equivalent If condition of the <b>Service</b> package.

The following table shows the Loop commands supported for migration and their respective mappings in Automation 360.

Enterprise 11 or Enterprise 10 commands	Equivalent Automation 360 actions and packages
Exit Loop	Break
Continue	

### Message Box

This command is migrated to **Message box** action in Automation 360.

See [Message box package](#) on page 2796.

### Object Cloning

This command is migrated to the **Recorder** package > **Capture** action in Automation 360.

Migration is supported for applications using the following technologies (including when they are within a Citrix environment):

- MSAA (Standard desktop technology)
- Google Chrome browser
- Internet Explorer browser
- Java desktop
- Web Java
- UI Automation (advanced)
- Firefox browser (object based on HTML technology only)
- Microsoft Silverlight version 5

The following table lists the behavioral differences between Enterprise 11 or Enterprise 10 and Automation 360:

Enterprise 11 or Enterprise 10 behavior	Automation 360 behavior
<b>GetAllChildrenName</b> and <b>GetAllChildrenValue</b> commands return string type variable values	The equivalent actions in Automation 360 return list values. The migration process joins the list values and stores them into a string variable to maintain consistent bot behaviors across releases.
In Enterprise 11, the command is used to capture the control in an image	The entire window image is captured with the control highlighted using a red rectangle

Object Cloning with the **Export to CSV** action in Enterprise 10/Enterprise 11 is migrated into the following packages/actions combinations because the action does not exist in Automation 360:

- The **Capture** action saves the captured data into a table variable.
- The **Write to file** action of the **Data table** package is then used to save the data from the table variable to the CSV file.

The window title is copied from the source command to the destination action.

The X, Y coordinates and window title are also migrated to Automation 360.

The **Coordinate** and **Image** execution or play modes from Enterprise 11 are migrated as the following actions:

Play mode as coordinates:

Play mode as coordinates

Mouse click actions: The Click, Right Click, Left Click, Middle Click, and Double Click actions are migrated in the Mouse: Click action as a combination of Button and Events. The corresponding mouse buttons with events are migrated as shown:

- Click changes to Left Button-Click
- Right Click changes to Right Button-Click
- Left Click changes to Left Button-Click
- Middle Click changes to Middle Button-Click
- Double Click changes to Left Button Double-Click

Get Text

The Get Text action is migrated as a combination of actions that include Mouse: Click with Left Button-Click, Clipboard: Clear, Delay, and Simulate keystrokes.

Set Text

The Set Text action is migrated as a combination of actions that include Mouse: Click with Left Button-Click, Clipboard: Clear, Delay, and Simulate keystrokes.

The following table shows the property name changes for the controls and objects captured using **Object Cloning**. The migration process automatically maps the name changes. However, if a property is used inside a variable, you must manually enter the new name in the variable.

Enterprise 11 or Enterprise 10 property name	Automation 360 property name
Object ID	ID
Type	Control Type
State(s)	States
Action	DefaultAction
Bold	IsBold
Italic	IsItalic
Underline	IsUnderline

Enterprise 11 or Enterprise 10 property name	Automation 360 property name
Strike Through	IsStrikethrough
Super Script	IsSuperscript
Sub Script	IsSubscript
Background Color	BackgroundColor
Foreground Color	ForegroundColor
Font	FontFamily
Font Size	FontSize
First Line Indent	FirstLineIndent
Left Indent	LeftIndent
Right Indent	RightIndent
Line Spacing	LineSpacing
Space Above	SpaceAbove
Space Below	SpaceBelow
Item Name	ItemName
Item Value	ItemValue
Animated	IsAnimated
CapStyle	Cap
Font Weight	FontWeight
Horizontal Alignment	HorizontalAlignment
Hidden	IsHidden
Read Only	IsReadOnly
Bottom Margin	BottomMargin
Left Margin	LeftMargin
TopMargin	TopMargin
Right Margin	RightMargin
Overline Color	OverlineColor
Strikethrough Color	StrikethroughColor
Tabs Style	Tabs
Text Flow Direction	TextFlowDirection
Underline Color	UnderlineColor
HTML ID	IEID
HTML Name	IEName
HTML Alt	IEAlt

Enterprise 11 or Enterprise 10 property name	Automation 360 property name
HTML Tag	IEtag
HTML Class	IEClass
HTML InnerText	IEInnerText
HTML SourceIndex	IESourceIndex
HTML HRef	IEHref
HTML Value	IEValue
HTML Type	IEType
HTML ClassId	IEClassId
HTML Title	IETitle
HTML Tag Index	IEtagIndex
HTML HasFrame	IEHasFrame
HTML FrameID	IEFrameID
HTML Frame Name	IEFrameName
HTML Frame Src	IEFrameSrc
HTML Width	IEWidth
HTML Top	IETop
HTML Left	IELeft
HTML Height	IEHeight
HTML Frame Path	IEFramePath
Item Collection	ItemCollection
OCR Engine	OCREngine
OCR Occurrence	OCROccurrence
Row Control Type	RowControlType
GetSelectedIndex	GetSelectedIndex
GetSelectedText	GetSelectedText

- The migration process truncates the data to 64 KB if the Enterprise 11 or Enterprise 10 bots that use an object and any properties of that object contain data larger than 64 KB. This is to ensure that these bots do not encounter an error after migration.
- In Enterprise 11, you can remove the control type of an object from the search criteria, but this option is not available in Automation 360. In Automation 360, the capture action executes only on objects with the same control types. If you want to use this action on objects with different control types, you must capture these control types in separate capture actions.

See [Using the Capture action](#) on page 2940.



## OCR

All commands of **OCR** are migrated to equivalent Automation 360 actions of the **OCR** package. There is no change in behavior or command name.

In Enterprise 11, **ABBYY, MODI, TESSERACT, TOCR** OCR options are available as OCR engines. In Automation 360, by default only **ABBY** OCR engine is used.

See [OCR package](#) on page 2804.

## Open Program/File

This command is migrated to the **Open program/file** action of the **Application** package. In Enterprise 10/Enterprise 11, this command does not throw an error if you provide an incorrect value in the **Start In** field. Automation 360 validates the value entered for the same field and throws an error during bot execution.

See [Application package](#) on page 2428.

---

**Important:** Users must change the bot accordingly if they want to continue even if the Start In value field is incorrect.

---

## PDF integration

The following table shows the PDF integration command and their equivalent actions and packages in Automation 360:

Enterprise 11 or Enterprise 10 commands	Equivalent Automation 360 actions and packages
Merge Document	Merge document
PDF to Image	Extract image
Extract Form Fields	Extract field
Extract Text	Extract text
Split Documents	Split documents
Encrypt Document	Encrypt document
Decrypt Document	Decrypt document

If the Enterprise 11 bot uses the **Extract Form Fields** command and stores values in the Credential Vault, the migration process migrates these values in the Automation 360 Credential Vault.

The output of an Enterprise 11 bot is mapped with multiple variables in the equivalent actions of the PDF package after that bot is migrated to Automation 360. This reduces the number of actions in the migrated bot because a separate action is no longer required to map output to a variable.

See [PDF package](#) on page 2879.

## PGP

All commands of **PGP** are migrated to equivalent Automation 360 actions of the **PGP** package. There is no change in behavior or command name.

See [PGP package](#) on page 2888.

## Play Sound

All commands of Play Sound are migrated to its equivalent actions of the **Sound** package in Automation 360.

Automation 360 supports only .mp3 and .wav file types in Play media file action.

See [Play Sound package](#) on page 2891.

## Printer

**Default Printer**, **Remove Printer**, and **Select Default Printer** are migrated to the equivalent actions of the **Printer** package in Automation 360.

See [Printer package](#) on page 2891.

## Prompt

All commands of **Prompt** are migrated to equivalent Automation 360 actions of the **Prompt** package.

The following table shows commands that can be migrated with name changes.

Enterprise 11 or Enterprise 10 commands	Equivalent Automation 360 actions and packages
Prompt For Value	Converts to the <b>For value</b> action. In addition, <b>Simulate keystroke</b> action is added below the <b>For value</b> action to perform the keystrokes on the specific window title. This is to retain the execution behavior of old bots.
Prompt for File	For file
Prompt for Folder	For folder
Prompt For Yes/No	For yes/no

See [Prompt package](#) on page 2905.

## Read from CSV/Text

The **Read from CSV/Text** is converted to **Open**, **Read**, and **Close** actions in the Automation 360 **CSV/TXT** package.

If your Enterprise 10/Enterprise 11 bot is using a variable as a session name and the **Loop** action used to read all rows of the **CSV/TXT** is using a hard-coded session name instead of a variable, then you must review the migrated bot and set the output variable of the **CSV/TXT > Read** action in the respective loop. Otherwise, you will get a UI error when you edit the Automation 360 bot.

In Automation 360, if the CSV/TXT file is not present in the specified file path, the bot returns an error message, whereas in Enterprise 11, the bot does not return such message.

---

**Important:** Review the migrated bot and set the output variable of the **CSV/TXT > Read** action in the respective loop.

---

## REST Web Service

The **Save Header To** option in Enterprise 11 is migrated to Automation 360. This option enables you to store the response header in the array and dictionary variables with the response header name as key and its header value as the value of the dictionary.

In Enterprise 11, the failure response is captured by default. In Automation 360, enabling the **Capture failure response** option captures the errors and adds to the response dictionary variable. When you migrate an Enterprise 11 bot to Automation 360, the **Capture failure response** option is enabled by default to capture the failure response of the migrated bot.

The time-out value configured in Enterprise 11 to send REST request is migrated to Automation 360 as part of global values (AARestTimeOut). The default time-out value is set as 60000 ms in Automation 360. You can update this value if the REST Web Service is taking more time to receive a response.

See [REST Web Service package](#) on page 2961.

## Run Logic

**Run logic** command is migrated to the **Run** action of the **Task Bot** package in Automation 360.

Additionally, **Error Handling** with the **Run Logic** command is migrated to the **Try and Catch** block.

- Applies from v.25: Enterprise 11 or Enterprise 10 bots that use the **Run Logic** command are migrated where a referred MetaBot Logic name is renamed or has changed the relative path after mapping. If a MetaBot Logic is renamed or changed the path after being mapped in the **TaskBots**, then the **TaskBots** are now migrated with the new MetaBot Logic name or path.

Changing the relative path is applicable in the following scenarios:

- Logic is moved from one folder to another.
  - Logic is moved from a MetaBot root-level folder to a subfolder.
  - Logic is moved from a subfolder to a folder at MetaBot root level.
  - The folder that has the Logic is renamed.
- Bots that use the **Run Logic** command that passes Credential Vault attributes from a Task Bot to a MetaBot logic can be migrated to Automation 360. The credential name and attribute name are displayed in the fields in the corresponding line of the migrated bot.
  - If you have migrated using the restored Enterprise 11 database, an equivalent locker is created in Automation 360 for the credential variables used in the Enterprise 11 bot.

- Applies from v23: Enterprise 11 or Enterprise 10 bots that use the **Run Logic** command are allowed to pass Credential Vault type variables from the parent bot to a MetaBot non-Credential Vault type variable. However, in Automation 360, Credential Vault variables are passed only to credential type variables (and not to non-Credential Vault type variable) for enhanced security. Therefore, the migration process first converts the Credential Vault type variable to the string type variable using the **Convert credential to string** action of the **Credential package** so that the migrated bot can run successfully. The string variable is then assigned to a temporary variable that is used as an input parameter in the **Task > Run** action to call the MetaBot Logic.
- Bots that use Credential Vault variables are passed from one MetaBot Logic to another MetaBot Logic for the **Begin Error Handling > Run Logic** command.
- When you perform a **Begin Error Handling > Run Logic** command, you can migrate a MetaBot with a Logic (parent) that includes a renamed Logic (child). If a child Logic is renamed after it is mapped to the parent Logic, this parent Logic mapping is migrated with the new name.

Choose one of the following options to run the migrated bots successfully:

- Option 1: Pass the credential type variables.
  1. Create a credential type variable in the child bots as input variables.
  2. In the **Run** action of the Task Bot package of the parent bot, update the input value fields to use the Credential Vault attributes for the credential type variable created for the child bot (corresponding to MetaBot logic).
- Option 2: Pass the credential values as a global value.
  1. Create the Global value in Automation 360 for the credentials use in the **Run Logic** command in Enterprise 11.
  2. In the **Run** action of the Task Bot package of the parent bot, update the Input value fields to use the Global values for the credential type variable created for the child bot (corresponding to MetaBot logic).

If you have not used the restored Enterprise 11 database when installing Automation 360, you must first create the required locker for the credential variables used in the Enterprise 11 bot, before performing the preceding steps.

---

**Note:** Automation 360 provides enhanced security by allowing you to assign Credential Vault attributes only to the credential type variables. This restricts any nonsecure handling of Credential Vault attributes where they might have been assigned to non-credential type variables.

---

## Run Script

The **Run Script** command is migrated to the **Run Script** action of the **Legacy automation** package.

When you use the **Legacy automation** package with the **Run Script** action after migration, you might run into issues in some scenarios, so review the cause and how to resolve the issue:

- Cause: In the **Run Script action > Input Parameters** field, if the value of the argument (passed by **String > Assign action**) contains double quotation marks followed by a backslash at the

end of the argument and the variable value contains a space, the string breaks where the first space occurs (this is due to upgrade changes in openJDK).

- Example: Consider a folder path as the argument value that is passed using **String > Assign action**, "\\fwus129ns.ny.fw.gs.com\mahatb\home\My Documents\Test Adhoc Request\". When you migrate this Enterprise 11 bot to Automation 360, this single argument value is considered as four different argument values in Automation 360, as follows:
  - \\fwus129ns.ny.fw.gs.com\mahatb\home\My
  - Documents\Test
  - Adhoc
  - Request\
- Solution: Edit the Enterprise 11 bot and remove the double quotation marks in the variable value in **String > Assign action**.

## SAP Integration

This command is migrated to the Recorder package > **Capture** action in Automation 360. All object properties in the Enterprise 11 bots are mapped with the equivalent properties in the migrated bots.

**Note:** If the Enterprise 11 bot with the SAP Integration command is using SAP GUI 740 or earlier versions, perform additional steps in the Bot Agent machine to run the migrated bot successfully in Automation 360. For more information, see [Failed to capture SAP application using SAP GUI 740 \(A-People login required\)](#).

If you run migrated bots with the SAP GUI option selected but the SAP GUI window is closed, an exception error is displayed. This occurs because, the Recorder package uses the **Window** title during runtime and, in Automation 360, SAP Integration is migrated to Recorder package.

The following table provides a list of SAP objects and the actions that can be migrated to Automation 360.

Object	Action
Text box	Set Text, Append Text, Left Click, Right Click, Double Click
Combo box	Select Item By Text, Select Item By Index, Get Total Items, Get Selected Item Text, Get Selected Item Key, Get Property, Set Focus, Left Click, Right Click, Double Click
Check box	Check, Uncheck, Toggle, Get Status, Get Property, Set Focus, Left Click, Right Click, Double Click
Button	Click, Get Property, Left Click, Right Click, Double Click
Radio button	Select, Get Status, Get Property, Set Focus, Left Click, Right Click, Double Click
Menu bar	Select Item By Text, Get Property, Set Focus, Left Click, Right Click, Double Click

Object	Action
Tree	Get Property, Set Focus, Left Click, Right Click, Double Click, Get total items, Get selected index, Get selected text, Select item by index, Select item by text
Label	Click, Get Property, Set Focus, Left Click, Right Click, Double Click
Tab	Get Property, Set Focus, Left Click, Right Click, Double Click, Get total items, Get selected index, Get selected text, Select item by index, Select item by text
Rest of the control (It includes controls such as: GuiMainWindow, GuiBox, GuiUserArea, GuiTitlebar, and GuiStatusbar)	Get Property, Set Focus, Left Click, Right Click, Double Click

The following table shows the actions performed on the main window object and their equivalent actions in Automation 360:

Enterprise 11 action	Equivalent Automation 360 action
Activate Window	<b>Activate</b> action of the Window package.
Close Window	<b>Close</b> action of the Window package.
Execute Script	<b>Append SAP session</b> and <b>Run function</b> actions of the Legacy Automation package.
Maximize Window	<b>Maximize</b> action of the Window package
Restore Window	<b>Restore</b> action of the Window package

SAP commands that support BAPI features in Enterprise 11 are migrated to equivalent actions of the SAP BAPI package in Automation 360.

The following table shows the Enterprise 11 command and its equivalent action in Automation 360:

Enterprise 11 command	Automation 360 action
Connect	<b>SAP BAPI &gt; Connect</b>  You must create the <b>JcoDllPath</b> and <b>JcoJarPath</b> global values. Update the <b>JcoJarPath</b> global value with the location of the SAP Java connector package and the <b>JcoDllPath</b> with the location of the SAP Java connector DLL.
Create Function	<b>SAP BAPI &gt; Create function</b>
Get Data command with the <b>Field</b> option selected	<b>SAP BAPI &gt; Get field</b>

Enterprise 11 command	Automation 360 action
Get Data command with the <b>Table</b> option selected	<b>SAP BAPI &gt; Get table</b>
Get Data command with the <b>Structure</b> option selected	<b>SAP BAPI &gt; Get structure</b>
Set Data command when the <b>Fields, Table, or Structure</b> option is selected	<b>SAP BAPI &gt; Set field</b>
Invoke Function	<b>SAP BAPI &gt; Run function</b>
Run standard workflow	<b>SAP BAPI &gt; Run standard workflow</b>
Run custom workflow	<b>SAP BAPI &gt; Run custom workflow</b>

## Send Email

In Enterprise 10/Enterprise 11, the Send Email command uses user-specific email settings stored as credential attributes within the system locker. When the first bot is migrated, we create a custom locker called AAE\_Email and add the AAE\_EmailSettings credential with the Username and Password attributes to it. Additionally, we create Global Values for the non-credential attributes, such as Server host, port, SSL and authentication, which correspond to the same Email Settings. Enterprise 10/Enterprise 11 Email Settings credentials are split into Credential Variable and Global Values in Automation 360, so during the migration process, email settings are migrated as follows:

Enterprise 10/Enterprise 11 Email Settings	Automation 360 Email Settings	Automation 360 Storage Type
Host	AAE_EmailSettings_host Global Value of type String	
Port	AAE_EmailSettings_port Global Value of type Number	
Use secure connection (SSL/TLS)	AAE_EmailSettings_ssl Global Value of type Boolean	
My server requires authentication	AAE_EmailSettings_auth Global Value of type Boolean	
Username	userName Credential attribute within AAE_EmailSettings credential assigned to AAE_Email locker	
Password	password Credential attribute within AAE_EmailSettings credential assigned to AAE_Email locker	

## Services

All commands of **Services** are migrated to equivalent Automation 360 actions of the **Service** package. There is no change in behavior or command name.

### SOAP Web Service

This package behaves the same in Automation 360.

If a SOAP web service is configured to call REST APIs, then we migrate them to the REST web service action instead of the SOAP web service action. Based on additional XML operations, we add actions from the **XML** package to make sure the migrated bot gives same result as the legacy bot.

The time-out value configured in Enterprise 11 to send SOAP request is migrated to Automation 360 as part of global values (AASoapTimeOut). The default time-out value is set as 60000 ms in Automation 360. You can update this value if the SOAP Web Service is taking more time to receive a response.

[Example of using the SOAP web service action](#) on page 3240

Enterprise 11 provides options to select the **URI type for execution** such as **Default**, **Static**, and **Dynamic**. However, in Automation 360, no option is available to select the URI type for execution. The Enterprise 11 URI types are migrated in Automation 360 as follows:

- Default and Static: If your Enterprise 11 bot is configured with the **Default** or **Static** URI type, it is migrated as static and the **Address location** field is automatically populated.
- Dynamic: If your Enterprise 11 bot is configured with the **Dynamic** URI type, it is migrated as dynamic and the **Address location** field is empty.

See [SOAP Web Service package](#) on page 3084.

### String Operation

The Enterprise 11 or Enterprise 10 String Operation command is migrated to equivalent actions of the String package.

The following table shows the String Operation commands and their equivalent actions in Automation 360.

Enterprise 11 or Enterprise 10 commands	Equivalent Automation 360 actions and packages
Before-After	Extract
Compare	Compare
Find	Find
Length	Length
Lower Case	Lowercase
Replace	Replace
Reverse	Reverse



Enterprise 11 or Enterprise 10 commands	Equivalent Automation 360 actions and packages
Split	Split
Substring	Substring
Trim	Trim
Upper Case	Uppercase

In Enterprise 11, if you are using carriage return (CR) (\r) in regular expression in the String Find command, after migration, the output displayed in Automation 360 is different from the output in Enterprise 11.

Workaround: In Automation 360, use \r|\R instead of \r for carriage return.

In Enterprise 11, both carriage return (CR) and newline (LF) were enumerated to calculate the total length of String Operation. However, in Automation 360, only newline (LF) is considered for the length of String Operation. Hence, the length count in the resulting output in Automation 360 is lesser.

Enterprise 11 bots can use regular expressions in the **Find** and **Replace** commands to search for the string on which you want to perform an operation. The equivalent actions in Automation 360 too can use regular expressions to search for the string on which you want to perform an operation.

In Enterprise 11, the system considers the new line character (/n) used in the variable when you use the **Find** and **Replace** commands. However, in Automation 360, the system does not consider the new line character when you use the **Find** and **Replace** commands.

When you migrate a bot to Automation 360 with the string operation set to **Before** or **After** action, the output is retrieved correctly and the operation is successful. The matching output is displayed even if no characters are present before the matched string. In Enterprise 11, bots with **Before** or **After** action do not retrieve output correctly and therefore retrieve the source string itself. If no characters are present before the matched string, the output is displayed as no match is found.

Example:

```
Drag Before/After Action → (Inputs : [Source = (ABCZ)] → [Before = Z] →
[assign to Prompt-assign] → Output : Empty(""))
```

```
Drag Before/After Action → (Inputs : [Source = (ZABC)] → [After = Z] →
[assign to Prompt-assign] → Output : ZABC
```

## System

**Lock computer**, **Logoff**, **Restart**, and **Shutdown** actions are migrated to the equivalent actions of the **System** package in Automation 360.

See [System package](#) on page 3105.

## Task

The following table shows the different commands that are migrated to the respective actions of the Automation 360 **Task Bot** package.

Enterprise 11 or Enterprise 10 commands	Equivalent Automation 360 actions and packages
Pause	Pause
Stop Task	Stop
Run Task	Run. The output returned by the child bots is mapped to the respective variable in the parent bots.

## Terminal Emulator

Encrypt text is not supported in the **Send Text** and **Set Field** actions for Automation 360. We recommend that you use Credential Vault instead of plain text.

In Enterprise 11 and in Automation 360:

- Bots that use the following terminal model can be migrated to Automation 360:
  - VT 220 model of the VT Series terminal type
  - IBM 5555 B01 and C01 models of the TN 5250 terminal type
- A session (used to establish a connection with the terminal server) can be shared between the parent bot and a child bot. You can close a session from the child bot instead of closing the session from the parent bot.
- You can use the **Default** terminal in bots for the VT100 terminal type.
- Bots that send Japanese text using the **Send Text** command in Enterprise 11 with the **DBCS** option from the **Encoding** list and the **Japanese Shift-JIS (932)** option from the **CodePage** list selected in the **Connect** command can be migrated to Automation 360.
- Applies only to v.24 and earlier : In the Terminal Emulator, when you manually click the key in the keyboard, the main keyboard Enter is identified as {enter} in Enterprise 11, while in Automation 360, it is identified as {return}.
- Ensure that you set the correct row value (use the **Set row** value as 24 to set the cursor at the last row) in the **Set cursor position** action for bots to execute successfully.

Automation 360 does not support legacy technology and by default supports all capabilities of Advance Technology of the Enterprise 10/Enterprise 11 bots.

The maximum index value in Automation 360 is 99999. The migration process automatically updates the value of **Field index** in the **Set Field** action to 99999 to meet the maximum value restriction. If the index value is higher than 99999 and is used in a variable, then you must change it manually.

The SSHI feature is not yet supported in Automation 360.

The **Search field** action enables you to search for field index or field name by using a text.

Bots created in Enterprise 11 no longer show the **Trying...** text after the bots are migrated to Automation 360.

See [Terminal Emulator package](#) on page 3117.

## Variable Operation

The following are the operations when a value is assigned to the variable:

### Value type variables

The functionality for this command has been divided into multiple packages in Automation 360.

In Enterprise 10/Enterprise 11, this command was performing assignment operations for all the supported datatypes. Automation 360 has built a dedicated **Assign** action for each data type. The migration process handles the mapping of the corrected packages and action based on the assignment that the respective variable operation is performing.

For Enterprise 11 bots that use the **Decimal configuration** option, the **To string** action of the Number package is added in the migrated bots. In Enterprise 11, the system rounds off the value based on the value specified in the **Decimal configuration** field. For example, if the value that is assigned to the variable is 13.456 and the value specified in the **Decimal configuration** field is 2, the system rounds off the value in Enterprise 11 to 13.46. In Automation 360, the value is trimmed instead of rounded off. For example, the value 13.456 will be converted to 13.45 in Automation 360.

### List type variables

Operations involving on list assignments are migrated to the **Set item** of the **List** package. If the operation has a fixed value, the system creates a temporary variable and stores the fixed value in it. You can then use this temporary variable in the **Assign** action of the **List** package to save it.

### Array type variables

Operations involving on array assignment is migrated to **Set value of a single cell** action of the **Datatable** package to set a value for specific rows and columns.

### Dictionary type variables

Operations involving dictionary assignment is migrated to the **Put** action of the **Dictionary** package to set the value for a specific key. If the key is a combination of a variable and fix value (for example `$Dictionary(key-$id $)`), then the **String** package > **Assign** action is added to get the actual key.

System variable \$Date\$

The Enterprise 10/Enterprise 11 Variable Operation command that uses the **\$Date\$** system variable is migrated to Automation 360 by adding new date actions based on the operation being performed using **\$Date\$**. The migration process also converts the date value to a default string format – mm/dd/yyyy HH:mm:ss.

Random variable of sub type string: We migrate and map this directly.

The following are the variable operations when a value of the variable is reinitialized:

List variable

For the **Variable Operations** command that reinitialize the list variable in Enterprise 10/Enterprise 11, the migration process creates a temporary list variable with new values and assign it to the destination list variable in Automation 360.

List variable declared by reading a Text file

This command is migrated to the **Import list from text file** action in the **Legacy Automation** package.

---

**Note:** In Automation 360, the bot encounters an error if the source file is empty or does not contain a key for initializing the list variable, unlike in Enterprise 10 or Enterprise 11.

---

Array variable declared by reading a Text file

The Array variable type is migrated as a Table variable type in Automation 360. The system uses the **CSV/TXT** package to read and load the respective data into the table variable in the bot.

Dictionary variable

The migration process creates a temporary dictionary variable to store all keys and values. Then the system uses the **Dictionary** package > **Assign** action to update the target variable with the keys and values from the temporary dictionary variable.

Dictionary variable declared by reading a Text file

The migration process addresses this use case by adding actions to read the CSV file using the **CSV/Text** package and storing the data in a table variable. Then it adds actions to perform a loop on the table variable and uses the **Dictionary** package > **Put** action to add keys and values into the dictionary variable.

Array variable declared by reading an Excel/CSV file

The migration process addresses this use case by migrating the Array variable type as a Table variable type in Automation 360. The system adds **Open, Get Multiple Cells,** and **Close**

actions of the **Excel Advance** package and populates the table variable.

The following are the variable operations when a value of the system variable is reset:

Variable Operation (resetting system variables)	<p>The following system variables are migrated as user defined variables in Automation 360. The system adds a respective action to clear the value of the equivalent variable created in Automation 360.</p> <ul style="list-style-type: none"><li>• Email Cc</li><li>• Email From</li><li>• Email Message</li><li>• Email Received Date</li><li>• Email Received Time</li><li>• Email Subject</li><li>• Email To</li><li>• Error Description</li><li>• Error Line Number</li></ul>
---	---

## Wait

**Wait for window** and **Wait for screen change** in Automation 360 throws an exception error if the respective window is not open/close in the specified time or the screen is not found in specified time. In these cases, the system adds try and catch block if the command was configured to stop the bot and adds the **Stop task** action in the catch block. This is to ensure that the execution behaviour of migrated bots is the same as Enterprise 10/Enterprise 11.

Because we are migrating commands with the **Stop bot** action is encapsulated with the try and catch block in Automation 360, the bot also stops if the action fails due to some other reason. During the migration process, the **Stop bot** action also adds extra error handlers in the migrated bots when the **Stop the task** option is selected.

The **Wait for window** action can have negative values for coordinates that are not supported in Automation 360. The negative values are changed to 0 during the migration process.

## Web Recorder

All commands (except those mentioned below explicitly) of **Web recorder** are migrated to respective actions within the **Legacy Automation** package in Automation 360. The **Legacy Automation** package ensures that the migrated bots give the same results as Enterprise 10/Enterprise 11. However, it is not recommended to use the **Legacy Automation** package for new development.

**Find broken links** is migrated to **Browser > Find broken links** package. Additionally, Enterprise 10/Enterprise 11 has the "Find broken links timeout" and "Find broken links" options within the Tools > Options. Automation 360 has these options as part of the action and the timeout defaults to 10 seconds and the number of parallel threads value defaults to 10.

**Download files** is migrated to **Browser > Download files** package.

During the migration process, the **Extract table** action adds extra error handlers in the migrated bots when the **On error continue with next action** check box is enabled.

## Window Action

All commands of Windows Actions are migrated to its equivalent actions of the Window package in Automation 360.

Enterprise 11 bots can use regular expressions in the **Get Active Window Title**, **Activate Window**, **Maximize Window**, **Minimize Window**, **Close Window**, and **Resize Window** commands to search for the window on which you want to perform an operation. The equivalent actions in Automation 360 too can use regular expressions to search for the window on which you want to perform an operation.

See [Window package](#) on page 3174.

## XML

All commands of XML are migrated to its equivalent actions of the **XML** package in Automation 360.

The following command names have changed:

Enterprise 10/Enterprise 11	Automation 360
End XML session	End session
Start XML session	Start session
Delete Node/Attribute	Delete node
Update Node/Attribute	Update node
Get nodes action with the "Single Nodes" option selected	Get single node action
Get nodes action with the "Multiple Nodes" option selected	Get multiple node action

In Enterprise 11, when you set the XML command to **Get Node(s)** with the **Multiple Nodes** option selected, the **XPath Expression** returns only the last element of the matching expression. In Automation 360, the **XPath Expression** returns all the matching elements.

Enterprise 11 bots that extract nodes that contain namespaces from an XML file can be migrated to Automation 360. If you add a namespace to a node in an XML file, you must save and reload the XML file to reflect the changes.

See [XML package](#) on page 3186.

## Variable mapping for migration

In migration, some variables map directly from previous product versions to Automation 360 while others behave differently or contain configuration changes.

**Note:** In Enterprise 11, if a bot used a variable that was followed by a space and a string that began with a dollar sign character (\$) and enclosed in parentheses, brackets, or braces, after migration, the variable field encounters an error. The error occurs because, in Automation 360, two dollar sign characters (\$\$) are required in a string to display the dollar sign. To fix this error, add another dollar sign to the string. For example, if you are using the **prompt-assignment** variable to display a string followed by \$5 [`$Prompt-Assignment$ ($5)`], after migration, the variable field displays an error. To fix the error, edit the variable field to add another dollar sign, as follows: [`$Prompt-Assignment$ ($$5)`].

## User-defined variables

In Automation 360, all variables defined in bots are created as `Use as input` and `Use as output` types during migration to exchange values between parent bots and child bots.

If variables are mapped between a parent bot and a child bot in Enterprise 11 and some of the mapped variables are not available in either the parent bot or the child bot, the migration process removes these variables. The migration process removes such variables for child bots that are migrated along with the parent bots and for child bots that are already migrated.

For information about the list of variables supported, see [Variables support](#) on page 1001.

Review how the following user-defined variables are migrated.

- [Array](#)
- [Dictionary](#)
- [List](#)
- [Random](#)
- [Value](#)

### Array

This section explains how **Array** variable is migrated to Automation 360. In some cases, you might have to perform some actions or ensure a few things before or after migration.

Subtype "Value"

Variables with this subtype are migrated to **Table** with all column values as **String**.

Subtype "Read from text file"

Variables with this subtype are migrated to **Table** with all column values as **String**.

The following actions are added as part of migration to configure data in the variable:

Automation 360 actions	Function
CSV/TXT > Open	Opens the file for reading.

Automation 360 actions	Function
<b>CSV/TXT &gt; Read</b>	Returns the value in the Table variable.
<b>CSV/TXT &gt; Close</b>	Closes the file.

Subtype "Read from database"

Variables with this subtype are migrated to the **Table** package with all column values as **String**.

The following actions are added as part of migration to configure data in the variable:

Automation 360 actions	Function
<b>Database &gt; Connect</b>	Adds the <b>Connect</b> action with the respective connection string.
<b>Database &gt; Export to datatable</b>	Adds the <b>Export to datatable</b> action to return the results to the datatable variable.
<b>Database &gt; Disconnect</b>	Adds the <b>Disconnect</b> action to disconnect the database.

See also: [Database package](#) on page 2466.

Subtype "Read from Excel/CSV file"

Variables with this subtype are migrated to **Table** with all column values as **String**.

The following actions are added as part of migration to configure data in the variable:

Automation 360 actions	Function
<b>Advance Excel &gt; Open</b>	Opens the file for reading.
<b>Advance Excel &gt; Get multiple cells</b>	Returns the <b>Table</b> variable value if the <b>All Cells</b> or <b>Range</b> option is chosen in the variable declaration.



Automation 360 actions	Function
<b>Advance Excel &gt; Read now</b>	Returns the <b>Table</b> variable value if the <b>Entire Row</b> option is chosen in the variable declaration.
<b>Advance Excel &gt; Read column</b>	Returns the <b>Table</b> variable if the <b>Entire Column</b> option is chosen in the variable declaration.  Additionally, the <b>Assign list to datatable of list</b> package is used to store the returned valued to the variable.
<b>Advance Excel &gt; Close</b>	Closes the file.

---

**Important:** In Automation 360, an empty table variable returns a runtime error. If your migrated bot contains an empty table variable, you must resolve the issue in Automation 360.

---

Array variable: Input types accepted by DLL function

When the system passes an Array variable from an Enterprise 11 bot to a DLL function of a different type, the DLL function accepts the following as input types:

- UInt16[], Int16[], Int32[], Int64[], Int[], Char[], Single[], Decimal[], Float[], Double[], Boolean[], bool[], Byte[], String[], and Datetime[]
- UInt16, Int16, Int32, Int64, Int, Char, Single, Decimal, Float, Double, Boolean, bool, Byte, String, and Datetime
- List<UInt16>, List<Int16>, List<Int32>, List<Int64>, List<Int>, List<Char>, List<Single>, List<Decimal>, List<Float>, List<Double>, List<Boolean>, List<bool>, List<Byte>, List<String>, List<Date-Time>
- UInt16[,], Int16[,], Int32[,], Int64[,], Int[,], Char[,], Single[,], Decimal[,], Float[,], Double[,], Boolean[,], bool[,], Byte[,], String[,], and Datetime[,]

## More information

You can migrate your Enterprise 10 or Enterprise 11 bots that include Array variables.

The following are some key behavior differences:

- The index position starts with 1 in Enterprise 10 and Enterprise 11, while the index position starts with 0 in Automation 360. For example, `$arrayVariable(1,1)$` becomes `$arrayVariable[0][0]$`
- If an array has 10 rows/columns and a loop is running more than 10 times, then Enterprise 10/Enterprise 11 returns the name of the array variable with the index position.
- In Enterprise 11, if you pass a constant string value to an array index in any command (for example `$array(field1)`, where `field1` is not a variable), the value is used as is (for example, `$array(field1)`). However, after the bot is migrated to Automation 360, a compile time error occurs if the command has a non-variable value.
- In Enterprise 11, if you pass an array variable without any index (for example `"$array$"`, `"$array()$"`, where index is missing), the value is used as is (for example, `"$array$"`, `"$array()$"`). However, after the bot is migrated to Automation 360, a compile time error occurs.

---

**Important:** If an invalid index is used to access any arrays in Enterprise 11, ensure that you resolve the bot error before or after migration.

---

## Dictionary

This section explains how **Dictionary** variable is migrated to Automation 360. In some cases, you might have to perform some actions or ensure a few things before or after migration.

## Run Logic

In Enterprise 11, when you perform a **Run Logic** operation, you can select a specific key from the Dictionary variable and map it to the required value variable.

In Automation 360, you can only map variables directly and cannot map a Dictionary(key) variable to a string.

## Subtype "Value"

The system migrates these variables to the **Dictionary** type with the **String** subtype in Automation 360.

## Subtype "Read from CSV file"

The migration process adds actions to read the CSV file using the **CSV/Text** package and

Dictionary variable: Input types accepted by DLL function

stores the data in a table variable. The process also adds actions to perform a loop on the **Table** variable and uses the Put action of the **Dictionary** package to add the key and values in the **Dictionary** variable.

More information

When the system passes a dictionary variable from an Enterprise 11 bot to a DLL function of a different type, the DLL function accepts the following as input types: UInt16, Int16, Int32, Int64, Int, Char, Single, Decimal, Float, Double, Boolean, bool, Byte, String, and Datetime.

You can migrate your Enterprise 10 or Enterprise 11 bots that include Dictionary variables.

The following table describes some key behavior differences and how they work in Automation 360:

Enterprise 10 or Enterprise 11 behavior	Automation 360 behavior
Dictionary keys are not case-sensitive in Enterprise 10 or Enterprise 11.	Dictionary keys are case-sensitive in Automation 360.  To maintain the bot execution resilience, the migration process converts all dictionary keys to lowercase values. String express <b>Lower case</b> is used if a variable is used as a dictionary key to obtain the lowercase key name.

List

This section explains how **List** is migrated to Automation 360. In some cases, you might have to perform some actions or ensure a few things before or after migration.

Subtype "Value"

These variables are migrated to **List** with subtype **String**.

Sub-type Array

These variables are migrated to **List** with subtype **String**.

Subtype "Reading from text file"

Where a variable that is declared by reading a file is called, the **Import list from text file** action of the **Legacy automation** package is added above the action that is being migrated.

Declared as "Make Random"

The **List** variable can be declared as **Make Random** in Enterprise 10 or Enterprise 11 to return a random item from the list. The migration process adds the new **Size** action to the **List** package to get the list size and adds the **Assign a random number** action to the **Number** package to find the random position and use it to get a random list item.

---

**Important:** In Automation 360, an empty list variable used outside a loop returns a runtime error. If your migrated bot meets this criteria, you must resolve the issue in the Automation 360 environment.

---

More information

- In Enterprise 10 and Enterprise 11, **List** is accessible without specifying any index. In Automation 360, you must specify the respective index to retrieve the specific value from the list.

Example: **List** variables can be accessed by index in the following way:

```
$listVariable[0]$
```

Here, 0 represents the first value in the list.

- Index position starts with 1 in Enterprise 10 or Enterprise 11, whereas it starts with 0 in Automation 360.
- Enterprise 11 behavior: In Enterprise 11, when a list with a fixed index is used, the system returns the value available in the first index of the list.

Example: For example, consider that you have a list with values 1, 2, 3, and 4, and you use `$IntList (3) $` to retrieve the value in the third index position of the list. The system returns the value available in the first index position of the list (1) instead of the specified index position (3).

Automation 360 behavior: In Automation 360, the system returns the value available in the specified index position (for the above example, it returns 3).

Behavior of migrated bots: Enterprise 11 bots that use such expressions with fixed indexes in the list and are migrated to Automation 360 return the value available in the specified index position.

- If a list has 10 items and a loop is running for more than 10 times, then Enterprise 10 or

Enterprise 11 returns the first value of the list after the 10th iteration.

List variable: Input types accepted by DLL function

When the system passes a List variable from an Enterprise 11 bot to a DLL function of a different type, the DLL function accepts the following as input types:

- UInt16[], Int16[], Int32[], Int64[], Int[], Char[], Single[], Decimal[], Float[], Double[], Boolean[], bool[], Byte[], String[], and Datetime[]
- UInt16, Int16, Int32, Int64, Int, Char, Single, Decimal, Float, Double, Boolean, bool, Byte, String, and Datetime
- List<UInt16>, List<Int16>, List<Int32>, List<Int64>, List<Int>, List<Char>, List<Single>, List<Decimal>, List<Float>, List<Double>, List<Boolean>, List<bool>, List<Byte>, List<String>, List<Date-Time>
- UInt16[,], Int16[,], Int32[,], Int64[,], Int[,], Char[,], Single[,], Decimal[,], Float[,], Double[,], Boolean[,], bool[,], Byte[,], String[,], and Datetime[,]

See also: [List package](#) on page 2774.

Random

This section explains how **Random** variable is migrated to Automation 360. In some cases, you might have to perform some actions or ensure a few things before or after migration.

Subtype "Random String"

When there is a Random variable of the subtype **String**, the migration process adds the **Generate random string** action of the **String** package to generate a random string above the **If** condition and assigns the value to the respective migrated variable in Automation 360

Subtype "Random Number"

When there is a Random variable of the subtype **Number**, the migration process adds the **Assign a random number** action of the **Number** package to generate a random string above the **If** condition and assigns the value to the respective migrated variable in Automation 360.

Value

This section explains how **Value** is migrated to Automation 360. In some cases, you might have to perform some actions or ensure a few things before or after migration.

Subtype "Value"

These variables are always migrated as **String** in Automation 360, even if they have number, boolean, or datetime values in them.

Subtype "Read from text file"

Expressions are used in Automation 360 to convert a string to other types if required.

To maintain the integrity of bot execution during migration, where a variable that is declared by reading a file is called, the **Import string from text file** action of the **String** package is added just above the action being migrated.

If Enterprise 11 bots contain variables that read values from a text file, then these bots are migrated using the **Read variable** action.

If a specific variable does not exist in the text file, or if the specific variable is reading a value from a file that does not exist, then Automation 360 generates an exception error.

After migration, when you run the bot that contains the **Read from file** variable, the reading occurs only once in the **Read variables** action at the start of the bot running process. If the file that the variable is trying to read gets updated while the bot is running, then the **Read file** variable is not refreshed.

More information

Bots that use value type variables within a variable can be migrated to Automation 360. For Enterprise 11 bots that use a variable within a variable in the Insert Keystrokes command, the **Evaluate value** action of the String package is added in the migrated bot

See also: [String package](#) on page 3086 | [Number package](#) on page 2802 | [Boolean package](#) on page 2430 | [Datetime package](#) on page 2484

## System variables

In some cases, system variables such as Error Line Number, Error Description, and OS Name return a different value in Automation 360. Bots using these variables in a decision-making or string operation require a review after migration.

Some system variables used inside a loop are user-defined variables in the loop after migration. In some instances, the user-defined variable might require some configuration in the migrated bot.

Some system variables are migrated as actions in Automation 360. These actions are added just above the action that uses these variables.

If a variable is defined at the index position for the following system variables, you might have to resolve the migrated bots because the migration process could not determine if the variable contains an index or column name. If you do not resolve it, the bot might return a `Key not found in record` runtime error. The migration process treats the value of a variable as name; but if it is an index, you must change it accordingly.

- \$Filedata Column\$
- \$Dataset Column\$
- \$XML Data Node\$
- \$Excel Column\$

The following table provides information about the various system variables and how they are migrated to Automation 360. Some variables are part of actions, some become actions, and some are known as system variables but have syntax changes.

**Note:** Migrated bots do not preserve data outside of the loop for the following system variables:

- \$FolderName\$
- \$FileName\$
- \$Extension\$

System variable	How they are migrated to Automation 360
\$Day\$	Becomes \$System:Day.Number.toString\$ in Automation 360
\$FileName	After migration, the system automatically creates this variable according to the Automation 360 naming convention, to run the migrated bots successfully.
\$Error Description	After migration, the system automatically creates this variable according to the Automation 360 naming convention, to run the migrated bots successfully.
\$Error Line Number\$	After migration, the system automatically creates this variable according to the Automation 360 naming convention, to run the migrated bots successfully.
\$Extension\$	After migration, the system automatically creates this variable according to the Automation 360 naming convention, to run the migrated bots successfully.
\$Folder Name\$	After migration, the system automatically creates this variable according to the Automation 360 naming convention, to run the migrated bots successfully.
\$Month\$	Becomes \$System:Month.Number.toString\$ in Automation 360
\$Year\$	Becomes \$System:Year.Number.toString\$ in Automation 360
\$Date\$	Becomes \$System:Date\$ in Automation 360 The date format set for the variable in the Enterprise 11 or Enterprise 10 bot is stored in the <b>AADefaultDateFormat</b> global value.
\$Hour\$	Becomes \$System:Hour.Number.toString\$ in Automation 360
\$Minute\$	Becomes \$System:Minute.Number.toString\$ in Automation 360
\$Clipboard\$	Becomes \$System:Clipboard\$ in Automation 360
\$Machine\$	Becomes \$System:Machine\$ in Automation 360
\$MiliSecond\$	Becomes \$System:MiliSecond.Number.toString\$ in Automation 360

System variable	How they are migrated to Automation 360
\$ArrayColumns(\$arrayVariable)\$	Becomes an expression in Automation 360: \$arrayVariable.DataTable:columnCount\$
\$ArrayRows(\$arrayVariable)\$	Becomes an expression in Automation 360: \$arrayVariable.DataTable:rowCount\$
\$AACControlRoom\$	Becomes \$System:AACControlRoom\$ in Automation 360
\$RAMUsage\$	Becomes \$System:RAMUsage\$ in Automation 360
\$TotalRAM\$	Becomes \$System:TotalRAM\$ in Automation 360
\$OSName\$	Enterprise 10 or Enterprise 11 returns the <b>Microsoft Windows 10 Pro 64-bit</b> value. In Automation 360, this variable becomes \$System:OSName\$ and returns the <b>Windows 10 64-bit</b> .
\$CPUUsage\$	Becomes \$System:CPUUsage\$ in Automation 360
\$Counter\$	This system variable is deprecated in Automation 360. The migration process creates a user-defined variable type Number and modifies the bot to ensure it provides the same output as the 11.x bot.  If you have used the \$Counter\$ variable in a loop, the migration process replaces the variable with the \$Condition-Counter\$ variable in the migrated bot and sets its value to 1.
\$Dataset Column\$	This system variable is now part of the <b>For each row in a SQL query dataset</b> iterator in <b>Loop</b> . The system creates a new variable in the loop and uses it inside the loop wherever \$Dataset Column\$ is present.  If the variable is used outside a loop, it is converted to a record type user-defined variable and assigned to a <b>Record</b> action, which enables you to assign the value of the source record variable to the destination record variable. Therefore, when you run migrated bots that contain this variable, data from the last row is displayed.
\$Excel Column\$	This system variable is now part of the <b>For each row in worksheet</b> iterator in <b>Loop</b> . The system creates a new variable in the loop and uses it inside the loop wherever \$Excel Column\$ is present.  If the variable is used outside a loop, it is converted to a record type user defined variable and assigned to a <b>Record</b> action, which enables you to assign the value of the source record variable to the destination record variable. Therefore, when you run migrated bots that contain this variable, data from the last row is displayed.
\$Extension\$ and \$FileName\$	These system variables were used in the <b>For each file in a folder</b> iterator of <b>Loop</b> . However, in Automation 360, a dictionary type variable is used to capture the extension and file name, which can be retrieved with "extension" and "name" key name respectively.  <a href="#">Loop package</a> on page 2784.



System variable	How they are migrated to Automation 360
\$Email\$ \$Email From\$ \$Email Message\$ \$Email Received Date\$ \$Email Received Time\$ \$Email Subject\$ \$Email To\$ \$Email Sent date\$ \$Email Sent time\$	These system variables were used inside the <b>For each mail in mail box</b> iterator of <b>Loop</b> . In Automation 360, a dictionary type variable is used to capture all email values that can be retrieve with the respective keys.  See <a href="#">Using dictionary variable for email properties</a> on page 2547.
\$Filedata Column\$	This system variable is now part of the <b>For each row in CSV/TXT</b> iterator in <b>Loop</b> . The system creates a new variable in the loop and uses it inside the loop wherever <code>\$Filedata Column\$</code> is present.  If the variable is used outside a loop, it is converted to a record type user defined variable and assigned to a <b>Record</b> action, which enables you to assign the value of the source record variable to the destination record variable. Therefore, when you run migrated bots that contain this variable, data from the last row is displayed.
\$FolderName\$	This system variable is used inside the <b>For each folder in a folder</b> iterator of <b>Loop</b> . In Automation 360, the value is returned to the string variable specified in the loop.
\$Excel Cell Row\$	This system variable is migrated to the <b>Get row number</b> action of the <b>Excel</b> package in Automation 360 and added just above the action in which it is used.  In Enterprise 11, the last executed Excel session is used as a <b>Session Name</b> value in the <b>Excel Cell Row</b> variable. However, in Automation 360, the <b>Excel Cell Row</b> variable is not present. So, the last executed Excel session used before <b>Excel Cell Row</b> is taken as a value for <b>Get row number</b> during migration.  Workaround: Create a string variable, assign a name to it, and add it after the <b>Excel</b> command in the migrated bot. Use the newly created string variable in <b>Get row number</b> .

System variable	How they are migrated to Automation 360
\$Excel Cell Column\$	<p>This system variable is migrated to the <b>Get column name</b> action of the <b>Excel</b> package in Automation 360 and added just above the action in which it is used.</p> <p>Enterprise 10/Enterprise 11 returns the first column (for example column A) for the \$Excel Cell Column\$ even if the active cell is not column A (for example column F10) inside a loop. In Automation 360, the same configuration returns the active cell (for example column F10). Below are the use cases that result in the above behavior change:</p> <ul style="list-style-type: none"> <li>• Excel is opened with or without <code>contains header</code> checked containing 10 rows.</li> <li>• Set active cell as F10</li> <li>• A loop is performed to row read</li> <li>• Put a <b>Message Box</b> with \$Excel Cell Column\$ in it</li> <li>• Run the bot</li> </ul> <hr/> <p><b>Important:</b> Considering the behavior differences, you might have to change some bots.</p>
\$Excel Cell\$	<p>This system variable is migrated to the <b>Get cell address</b> action of the <b>Excel</b> package in Automation 360 and added just above the action in which it is used.</p>
\$AATaskExecutor\$	<p>This system variable becomes <b>\$AATaskExecutor\$</b> and <b>\$AATaskInvoker\$</b> in Automation 360.</p> <p>In Enterprise 11, this variables return various values about the task invoker and executor (for example, the invoker's and executor's first name, last name, email address, and username). In Automation 360, the <b>\$AATaskInvoker\$</b> variable returns the following values:</p> <ul style="list-style-type: none"> <li>• Invoker_Username</li> <li>• Invoker_Firstname</li> <li>• Invoker_Lastname</li> <li>• Invoker_Email</li> </ul> <p>The <b>\$AATaskExecutor\$</b> variable returns the following values:</p> <ul style="list-style-type: none"> <li>• Executor_Username</li> <li>• Executor_Firstname</li> <li>• Executor_Lastname</li> <li>• Executor_Email</li> <li>• Executor_Type</li> </ul>

System variable	How they are migrated to Automation 360
\$AATaskName\$	<p>This system variable becomes <b>\$System.AATaskName\$</b> in Automation 360.</p> <p>In Enterprise 10/Enterprise 11, this variable returns the value to your computer path directory (for example Automation Anywhere \My Tasks\My Folder\My Folder2\AATaskName.atmx). In Automation 360, it returns the value to the bot path relative to the Control Room (for example Bots/AATaskName).</p> <hr/> <p><b>Action required:</b> Considering the values returned are different between the versions, you might have to change some bots.</p>
\$AAApplicationPath\$	<p>Enterprise 11 specific: This Enterprise 11 system variable returns the path set by users in the <b>Tool &gt; Option</b> setting of what is known as the "client application". In Automation 360, the variable becomes a global value. The migration process maps this change automatically and the value set of each user in Enterprise 11 is copied to the global value variable @AAApplicationPath.</p> <hr/> <p><b>Note:</b> No action is required by a user for Enterprise 11 because the system variable is automatically mapped as a global value during migration if you have used the restored Enterprise 11 database when installing Automation 360.</p> <hr/> <p>Enterprise 10 specific: This Enterprise 10 system variable does not automatically migrate to Automation 360 as a global value, so some action is required after migration.</p> <hr/> <p><b>Important:</b></p> <ul style="list-style-type: none"> <li>Enterprise 10 users must create the AAApplicationPath global value in Automation 360 and update it with the Enterprise 10 path. This update ensures that when you run the bot in Automation 360, the AAApplicationPath folder value is uniquely resolved for each user.</li> </ul> <p>Example: If the Enterprise 10 path value for AAApplicationPath is D:\John.Doe\My Documents\Automation Anywhere Files, then you must create the AAApplicationPath global value in Automation 360 and update with this path.</p> <ul style="list-style-type: none"> <li>Ensure that the <b>CAN be changed</b> option is selected when creating the AAApplicationPath global value. Bot Creators and Bot Runners must set the value for the AAApplicationPath global value before they run the migrated bots.</li> </ul> <hr/> <p>See <a href="#">Global values</a> on page 2350.</p>

System variable	How they are migrated to Automation 360
\$AAInstallationPath\$	<p>This system variable becomes <b>\$\$System:AAInstallationPath\$</b> in Automation 360.</p> <p>Enterprise 10/Enterprise 11 behavior: Returns the Enterprise Client installation path (for example C:\Program Files (x86)\Automation Anywhere\Enterprise\Client).</p> <p>Automation 360 behavior: Returns the Bot Agent installation path (for example C:\Program Files\Automation Anywhere\Bot Agent).</p> <hr/> <p><b>Action required:</b> Considering the values returned are different between the versions, you might have to change some bots.</p>
\$Current Directory\$	<p>This system variable is deprecated in Automation 360 and automatically converted to a user-defined variable during migration. The value of the variable is set per the value defined in <b>Loop &gt; For each file in a folder</b> and <b>For each folder in a folder</b>.</p>
\$Date\$	<p>This system variable becomes <b>\$\$System:Date\$</b> in Automation 360.</p> <p>Enterprise 10 and Enterprise 11 behavior: The <b>\$Date\$</b> variable returns the current date and time in a format specified in the <b>AA.Settings.XML</b> file.</p> <p>Automation 360 behavior: The <b>\$\$System:Date\$</b> variable returns values of type <b>Datetime</b> and users must use an action to change it in to String. To minimize disruption to users, the migration process does the following to each <b>\$Date\$</b> instance:</p> <ul style="list-style-type: none"> <li>• Creates a temp variable <b>\$\$SystemDateInString\$</b> of type String.</li> <li>• Adds a <b>ToString</b> action of <b>Datetime</b> package to convert <b>\$\$System:Date\$</b> to string with customer format as "MM/dd/yyyy HH:mm:ss" and store the output into above string variable.</li> <li>• Uses this string variable where ever <b>\$Date\$</b> is used.</li> <li>• The above steps are repeated for each occurrence of <b>\$Date\$</b>.</li> </ul> <p>Depending on how your bot is configured, you might have to update the date/time configuration.</p> <hr/> <p><b>Action required:</b> Change the bot if the date format is not MM/dd/yyyy HH:mm:ss.</p>
\$Error Line Number\$ \$Error Description\$	<p>In Enterprise 10 or Enterprise 11, these system variables are used after the <b>Error Handling</b> command. In Automation 360, the value is returned to the user defined variables specified in the <b>Catch</b> action.</p>

System variable	How they are migrated to Automation 360
\$PDFFileName\$ \$PDFTitle\$ \$PDFAuthor\$ \$PDFSubject\$	<p>In Enterprise 10 or Enterprise 11, these system variables were used after any <b>PDF</b> command. In Automation 360, a Dictionary type variable is used to capture all PDF values that can be retrieve with the respective keys. Every PDF action returns this Dictionary variable with corresponding PDF values.</p> <p>See <a href="#">Using a dictionary variable for PDF properties</a> on page 2888.</p>
\$System\$	<p>In Enterprise 11 or Enterprise 10, this system variable is used to retrieve information about a device's settings and its performance. In Automation 360, the <b>Get environment variable</b> action of the System package is used.</p> <p>See <a href="#">Get environment variable action</a> on page 3106.</p>
\$WorkItem\$	<ul style="list-style-type: none"> <li>• \$WorkItem\$ is String: Migrated as is.</li> <li>• \$WorkItem\$ is Number <ul style="list-style-type: none"> <li>• If it is displaying or logging a Number, the number is changed to a String</li> <li>• If it is displaying as a Number, migrate as a Number type</li> </ul> </li> <li>• \$WorkItem\$ is DateTime: Migrated as is, but the migrated package results in an error, so you cannot migrate the package.</li> </ul> <hr/> <p><b>Note:</b> For the DateTime type, you cannot migrate the package yet, so the associated bot must be migrated at another time.</p> <hr/>
\$Trigger Value\$	<p>Becomes \$TriggerValue\$ in Automation 360. For Enterprise 11 bots that use this variable, perform the following tasks to run the migrated bots successfully:</p> <ul style="list-style-type: none"> <li>• Create the equivalent triggers in Automation 360 for all the triggers that were used in Enterprise 11 bots.</li> </ul> <p>The output of triggers in Automation 360 is stored in a record type variable.</p> <ul style="list-style-type: none"> <li>• Update the migrated bots to use the appropriate actions to assign the values from the record variable that contains output from triggers to the \$TriggerValue\$ variable.</li> </ul> <p>For example, if you want to assign a host and port key from the record variable of an email trigger to the \$TriggerValue\$ variable, use the \$EmailTriggerData(host)\$EmailTriggerData(port)\$ expression. Similarly, to retrieve location of a file use \$FileTriggerData(file)\$ expression and to retrieve location of a folder use \$FolderTriggerData(fromFolder)\$ expressions.</p>

System variable	How they are migrated to Automation 360
\$Table Column\$	<p>This system variable is now part of the <b>For each row in table</b> iterator in <b>Loop</b>. The system creates a new variable in the loop and uses it inside the loop wherever \$Table Column\$ is present.</p> <p>If the variable is used outside a loop, it is converted to a record type user defined variable and assigned to a <b>Record</b> action, which enables you to assign the value of the source record variable to the destination record variable. Therefore, when you run migrated bots that contain this variable, data from the last row is displayed.</p>
\$XML Data Node\$	<p>This system variable is used inside the <b>For each node in XML dataset</b> iterator of <b>Loop</b>. In Automation 360, the value is returned to the string variable specified in the loop.</p> <p>If the variable is used outside a loop, it is converted to a string type user defined variable and assigned to a <b>Record</b> action, which enables you to assign the value of the source record variable to the destination record variable. Therefore, when you run migrated bots that contain this variable, data from the last row is displayed.</p>

## Credential variables

The credential variables used for the **Username** and **Password** fields in Enterprise 10 and Enterprise 11 are migrated as **Credential variables** in Automation 360.

The method of migration differs for Enterprise 10 and Enterprise 11.

To learn how Enterprise 10 credentials are migrated, see the section on credentials in [How Enterprise 10 data is copied to Automation 360](#) on page 1578.

The credential variables used in fields other than the **Username** and **Password** fields are migrated as **Global Values**. These fields include hostname, port number, and so on. The migrated global values have the following syntax: <credentialname>\_<attributename>. For example in Enterprise 11, a credential FTPConnection with an attribute hostname is migrated as FTPConnection\_hostname.

The following table provides information about the packages and actions that support the migration of credential variables from Enterprise 11 to Automation 360:

Package	Actions
Active Directory	<ul style="list-style-type: none"> <li>• Create and Modify User</li> <li>• Create and Modify Group</li> <li>• Create and Modify Object</li> <li>• Search</li> <li>• Get Property</li> </ul>
Database	<ul style="list-style-type: none"> <li>• Connect with connection string</li> <li>• Username</li> <li>• Password</li> </ul>

Package	Actions
Email Automation	<ul style="list-style-type: none"> <li>• Hostname</li> <li>• Username</li> <li>• Password</li> </ul>
Excel	Open Spreadsheet
FTP / SFTP	Connect
Insert Keystrokes	All keystrokes that require use of credentials
Legacy Automation	Set Text in Manage Web Controls action
Manage Window Controls	<ul style="list-style-type: none"> <li>• Set Text</li> <li>• Append Text</li> </ul>
PDF	<ul style="list-style-type: none"> <li>• PDF to Image</li> <li>• Extract Form Fields</li> <li>• Extract Text</li> <li>• Split, Encrypt, and Decrypt Document</li> </ul>
PGP	<ul style="list-style-type: none"> <li>• Encrypt and Decrypt Files</li> <li>• Create Keys</li> </ul>
Recorder	<ul style="list-style-type: none"> <li>• Set Text</li> <li>• Append Text</li> </ul> <hr/> <p><b>Note:</b> Migrated from Object Cloning command as Capture action.</p> <hr/>
REST Web Service	<ul style="list-style-type: none"> <li>• URI</li> <li>• Username</li> <li>• Password</li> <li>• Headers</li> <li>• Operation parameters</li> </ul> <hr/> <p><b>Note:</b> Domain name is migrated as a global value.</p> <hr/>
SOAP Web Service	<ul style="list-style-type: none"> <li>• Username</li> <li>• Password</li> <li>• Headers</li> <li>• Operation parameters</li> <li>• Raw data parameters</li> </ul>

Package	Actions
Terminal Emulator	<ul style="list-style-type: none"> <li>• Connect command for SSH2 with User and Key file authentication options</li> <li>• Send Text</li> <li>• Set Field</li> </ul>
Web Recorder	Manage Web Controls with Set Text and Append Text functions

## Global values in migrated bots

After migration, bots use various global values to support different capabilities provided in Enterprise 11 or Enterprise 10. You must create or update these global values in Automation 360 to ensure that the migrated bots run successfully.

**Note:** Global values are created when you migrate bots for the first time using the Bot Migration Wizard or migration APIs. If you are using the Migration package to migrate bots, you must create the global values manually.

The following table lists the various global values that are used by the migrated bots to run successfully:

Global value	Description
AAApplicationPath	<p>Use this global value to specify the physical path of a bot or file that is used in the current bot.</p> <ul style="list-style-type: none"> <li>• Enterprise 11 : This global variable is automatically created by the system if you have used the restored the Enterprise 11 database when installing Automation 360.</li> <li>• Enterprise 10: You must create this global value in Automation 360 and update all the Enterprise 10 bots that have used the AAApplicationPath system variable to the AAApplicationPath global value in Automation 360 with the same value as Enterprise 10.</li> </ul> <p><a href="#">How AAApplicationPath variable is migrated on page 1607</a></p>



Global value	Description
AABasePath	<p>This global value is equivalent to the <b>Start In Path of Task</b> option in Enterprise 11 or Enterprise 10.</p> <p>In Enterprise 11 or Enterprise 10, this option is used to specify the location of new files or folders when a relative path for that file or folder is specified in a command. When you migrate Enterprise 11 or Enterprise 10 bots, keep in mind the following:</p> <ul style="list-style-type: none"> <li>• If the path in the Enterprise 11 or Enterprise 10 bot is an absolute path, the migration process does not make any change in the migrated bot.</li> <li>• If the path in the Enterprise 11 or Enterprise 10 bot is a relative path and does not contain any variable, the migration process prefixes the path with the AABasePath global value.</li> <li>• If the path in the Enterprise 11 or Enterprise 10 bot is a relative path and contains variables: <ul style="list-style-type: none"> <li>• If the variable contains an absolute path, the runtime execution process does not make any change in the migrate bot.</li> <li>• If the variable contains a relative path, the runtime execution process prefixes the path with the AABasePath global value.</li> </ul> </li> </ul>
AADefaultDateFormat	Use this global value to change the default date and time format for Date variables.
AAE_EmailSettings_auth	Use this global value to enable or disable authentication for the email server.
AAE_EmailSettings_clientId	Use this global value to specify the client ID that is generated when you registered the application in the Microsoft Azure portal.
AAE_EmailSettings_domainName	Use this global value to specify a domain name for the email server.
AAE_EmailSettings_host	Use this global value to specify the host name of the email server that you want to use to send email notifications about the status of a bot.
AAE_EmailSettings_port	Use this global value to specify the port that you want to use to connect to the email server.

Global value	Description
AAE_EmailSettings_ssl	Use this global value to specify whether the email account uses the secure connection.
AAE_EmailSettings_tenantId	Use this global value to specify the tenant ID that is generated when you registered the application in the Microsoft Azure portal.
AAProxyHost	Use this global value to specify the proxy host that will primarily be used by the REST Web Service and SOAP Web Service actions.
AAProxyPort	Use this global value to specify the proxy port that will primarily be used by the REST Web Service action.
AARestTimeOut	Use this global value to specify the timeout value, in milliseconds, for the REST Web Service action. This value can be used when the REST server takes a long time to respond.
AASoapTimeOut	Use this global value to specify the timeout value, in milliseconds, for the SOAP Web Service action. This value can be used when the SOAP server takes a long time to respond.
AAWaitForControl	Use this global value to specify the maximum wait time, in seconds, for the Control Room.
JcoDllPath	Use this global value to specify the DLL path for the Java connector used in SAP Business Application Programming Interface (BAPI).
JcoJarPath	Use this global value to specify the JAR path for the Java connector used in SAP BAPI.

## Verify the bot migration

It is important that you verify that the migration is complete and the migrated bot runs successfully in the Automation 360 environment. The bot might have been converted, but it might contain errors that prevent it from running successfully.

1. Log in to your Automation 360 environment from a machine with the Bot Agent installed using a Bot Creator account and the "View Migration" permission.
2. Verify that the migration completed successfully by clicking **Administration > Migration**.
3. Confirm that your migration instance has the `successful` status (green check mark) and the **Migrated Item** column shows 1 to indicate that 1 bot was migrated.

If the **Migrated Item** column shows 0, your bot has not migrated successfully and will not be available on the **Automation** page.

4. Verify that the bot runs successfully by clicking **Activity > In progress**.
5. Navigate to the migrated bot.

For example, if you migrated a bot from the **My Tasks** folder, then navigate to the same folder to find your migrated bot.

6. Click the bot and fix any errors.
7. Run the bot to confirm that all errors have been fixed.

Related concepts

[Migrate to Automation 360](#) on page 1496

Migration (upgrade) is the process of moving your data and bots from Enterprise 11 or Enterprise 10 to Automation 360. Migration includes but is not limited to replicating and updating your existing database and repository, converting your bots to the Automation 360 format, and migrating learning instances for IQ Bot and dashboards for Bot Insight.

Related tasks

[View changes to migrated bots using Bot Assistant](#) on page 1677

The Bot Assistant provides a comprehensive view of all the lines in a bot that require your review or action, or which have errors and therefore require you to address them. You can quickly identify areas of bots that require your attention and view changes in an Enterprise 11 or Enterprise 10 bot after migration Automation 360.

## View migration reports

Use the reports to analyze the status of individual bot migration, data migration, and audit log migration and identify the status and summary of the individual migration.

You must have the **View migration** permission to access these reports.

The migration reports provide summary and status based on following type of migration:

- The bot migration that includes details about the conversion of Enterprise 10 or Enterprise 11 bots to Automation 360.
- The data migration that include details about copying Enterprise 10 data to Automation 360.
- The audit migration includes details about migrated Enterprise 11 audit log data to Automation 360.

Access the reports from the **Administration > Migrations > View migration** icon associated with the migration instance for which you want to view the report.

- Bot migration reports: Applies to both Enterprise 10 and Enterprise 11.

View the following information:

- Migration details such as name of the migration instance, its description, and status.
- Migration results such as the start and end time of the migration process, status of the migration, and the number of items migrated.
- Settings: Whether the option to overwrite files was selected.
- Bot Runners: Information about the run-as user selected for the migration instance.
- Bot migration results such as all the bots (parent bots and their child bots) that are migrated and their status.

The bot migration result separately lists the bots that might require action or review after migration. Navigate to the each tab to view the list of bots that will require action or review and plan the post migration steps accordingly.

Click the View migration issues icon associated with an unsuccessfully migrated bot to see the unsupported commands or attributes.

- General details about the user who created the migration instance, last modification date, and its object type.
- Bot Insight Migration Results: Applies to Enterprise 11 only.

View Bot Insight results if you have migrated Enterprise 11 analytics bots. This tab displays information such as the status of the Bot Insight migration, number of Bot Insight dashboards, and data rows that are migrated, not migrated, or skipped.

- Data migration reports: Applies to Enterprise 10 only.

View the following information:

- Migration details such as name of the migration instance, its description, and status.
- Data migration results such as the start and end time of the migration process, status of migration, and number of items migrated.
- Roles that are copied and their status.
- Users that are copied and their status.
- Auto-login credentials that are copied and their status.
- Bots that are copied and their status.
- Schedules that are copied and their status. The copied schedules are disabled in Automation 360 because migration of the associated devices is not supported and therefore they are not available.
- General details about the user who created the migration instance, last modification date, and its object type.

- Audit log migration reports: Applies to Enterprise 11 only.

View the following information:

- Migration details such as name of the migration instance, its description, and overall status of migration such as in progress, successful, or unsuccessful.
- Migration results such as the start and end time of the migration process, duration, and number of items skipped, not migrated, or migrated.
- Audit log migration results such as file path of audit log JSON files, status of each `es_export.json` file if it was skipped, not migrated, migrated, or is pending for migration. It also displays the reasons because of which a particular `es_export.json` file was skipped or unsuccessful when migrating audit logs.
- General details about the user who created the migration instance, last modification date, and its object type.

View the following video on how to review the bot migration report:

## Export to CSV

You can export two sets of data to a CSV file: the migration instances on the **All migrations** page and bot migration results data, including any action mapping for each bot. Exported data can be used for offline analysis and to identify bots that failed the migration and their associated failed actions.

For migration instance data, the export process exports all data (including hidden data columns), but only for the current page. If you have migration instances on additional pages, you must navigate to those pages to export that data. For migration result data, all pages are exported, even if the data is paginated.

Users with the "View migration" permission can perform the export.

1. Click **Administration > Migrations**.
2. Export migration instances:
  - a) Use the checkboxes to select the migration instances you want to export.
  - b) Click the **Export checked items to CSV** icon.
3. Export migration results data:
  - a) Select the migration instance where **Type** is "Bot migration" that you want to export.  
Only bot migration results can be exported.
  - b) Click the **Export bot migration results** option to export the data.  
You can also export from inside the Migration report.
4. Open the CSV file to see the exported data.

## View changes to migrated bots using Bot Assistant

The Bot Assistant provides a comprehensive view of all the lines in a bot that require your review or action, or which have errors and therefore require you to address them. You can quickly identify areas of bots that require your attention and view changes in an Enterprise 11 or Enterprise 10 bot after migration Automation 360.

- Enterprise 11 or Enterprise 10 bots must be migrated to Automation 360.
- The user reviewing the migration review and action messages must have the Bot Creator or Bot Runner license assigned to them.
- Bot Creators must have the **View migration** permission to view the migration review and action messages in the Bot Assistant.

Review messages are available for bots that are successfully migrated to Automation 360 but with some changes in the migrated bots. These review messages indicate changes in the behavior of the Enterprise 11 or Enterprise 10 commands after they are migrated to Automation 360.

You can open the Bot Assistant for a migrated bot that is listed in the **Messages** tab of the **Bot Scanner** report. Review the messages about the changes in the commands after migration and mark these messages as reviewed after analyzing the change. The Bot Assistant also enables you to review all the changes made in a bot from the Bot editor.

1. On the left pane, click **Automation**.  
A list of available and forms is displayed.
2. Open the migrated bot for which you want to review the messages.
3. Click the Bot Assistant icon on the toolbar to open the Bot Assistant.
4. Click **Get started**.
5. On the Bot Assistant screen, click the **Need review** tab to list the messages that require review.
6. Click a message in the **Need review** tab to view detailed information about the change.
7. Click the **Mark as reviewed** option to mark the message as reviewed.  
The messages that are marked as reviewed are available in the **Reviewed** tab.

---

**Note:** You can mark a message as reviewed only for the migrated bots that are available in your private repository.

---

See the following video on how to use the Bot Assistant to review changes to migrated bots

## Migration messages

Migration messages might display at any stage of the migration or Internet Explorer bot conversion. You can review or act on migration messages from these possible sources: Bot Scanner report, Bot Assistant or Bot migration report.

---

**Note:**

- Some messages described on this page do not include a cause or action when the cause is provided as part of the message and do not require any further action.
  - This page also includes Internet Explorer conversion messages that are applicable only for customers impacted by the Internet Explorer end-of-life (EOL) and have chosen to convert IE bots.
- 

## Action required messages

These messages in the Bot Scanner report, Bot Migration Wizard, and Migration Assistant after you migrate the bots. You must perform certain actions to successfully run the bots. We recommend that you review the cause and action required to update and run these bots.

Code	A103
Message	For the migrated bot to run, update the <b>Task bot: Run</b> action in the <i>migrated bot</i> by specifying the <b>credential variable</b> for <b>input parameter</b> . A Credential Vault variable cannot be passed in an <b>insecure manner</b> .
Cause	The fields in the migrated Enterprise 11 or Enterprise 10 bot display the value as plain text, so to prevent the risk of a security breach in Automation 360, the Credential Vault variable is restricted from passing it in a nonsecure (or insecure) manner.  <a href="#">Unsupported features with workaround</a>

Code	A108
------	------

Message	<p>For the migrated bot to run, update the action in the <i>migrated bot</i> by specifying an appropriate <b>Credential Vault</b> Value.</p> <p>An Automation 360 <b>Credential Vault</b> Value needs to match version 10.x / 11.x <b>Credential Vault</b> value.</p>
Cause	The migrated bot does not have the <b>Credential Vault</b> value assigned to the corresponding action.
Action	To run the migrated bot, create or update the <b>Credential Vault</b> value and assign it to the corresponding action. Ensure that the <b>Credential Vault</b> value in Automation 360 is same as the Enterprise 10 or Enterprise 11 <b>Credential Vault</b> value.

Code	A109
Message	<p>Referenced variables are missing in the V10/11 bot.</p> <p>For the migrated bot to run, update the corresponding actions in the migrated bot by providing missing required variables.</p>
Cause	Enterprise 11 or Enterprise 10 bot references a non-existent variable in the <b>Variable Operation</b> command.
Action	Either create a variable with the same name and type, or remove the command that references the non-existent variable.

Code	A110
Message	<p>Referenced variables are missing in the V10/11 bot.</p> <p>For the migrated bot to run, update the <b>IF</b> action in the migrated bot by providing missing required variables.</p>
Cause	The Enterprise 11 or Enterprise 10 bot references a non-existent variable in the <b>If</b> command.
Action	Create a variable with the same name and type, or remove the command that references the non-existent variable.

Code	A111
------	------

Message	Referenced variables are missing in the V10/11 bot. For the migrated bot to run, update the <b>Assign To Clipboard</b> action in the <i>migrated bot</i> by providing missing required variables.
Cause	The Enterprise 11 or Enterprise 10 bot references a non-existent variable in the <b>Assign To Clipboard</b> command.
Action	Update the <b>Assign To Clipboard</b> action with the required missing variable in the migrated bot so that the referenced variables are of the same type.

Code	A112
Message	Referenced variables are missing in the V10/11 bot. For the migrated bot to run, update the <b>ElseIf</b> action in the <i>migrated bot</i> by providing missing required variables.
Cause	Enterprise 11 or Enterprise 10 bot references a non-existent variable in the <b>ElseIf</b> command.
Action	Either create a variable with the same name and type, or remove the command that references the non-existent variable.

Code	A113
Message	Referenced variables are missing in the V10/11 bot. For the migrated bot to run, update the <b>Loop</b> action in the <i>migrated bot</i> by providing missing required variables.
Cause	The Enterprise 11 or Enterprise 10 bot references a non-existent variable in the <b>Loop</b> command.
Action	Create a variable with the same name and type, or remove the command that references the non-existent variable.

Code	A116
Message	The MetaBot Logic referenced in the TaskBot is missing. For the migrated bot to run, ensure the referenced MetaBot logic bot is available at the required path in A360. Message code: A116
Cause	The Enterprise 11 or Enterprise 10 bot references a non-existent Taskbot.



Action	Ensure that the MetaBot Logic bot exists in Automation 360.
--------	---

Code	A117
Message	The MetaBot Logic referenced in the parent MetaBot Logic is missing. For the migrated bot to run, ensure the referenced MetaBot Logic bot is available at the required path in A360. Message code: A117
Cause	The Enterprise 11 or Enterprise 10 parent MetaBot Logic references are missing.
Action	Ensure that the MetaBot Logic bot exists in Automation 360.

Code	A118
Message	For the migrated bot to run, ensure the child bot is available at the required path.  A child metabot is required for the parent bot to run.
Cause	When migrating a parent bot, if you have not migrated the child bot or you migrated the child bot at a different location.
Action	Verify that you have successfully migrated the child bot. After your verification, perform one of the following actions: <ul style="list-style-type: none"> <li>• Update the link within the parent bot so that it points to the correct location of the migrated child bot.</li> <li>• Move the child bot to the same location as the parent bot location.</li> </ul>

Code	A119
Message	A referenced DLL file is missing in the V10/11 bot.  For the migrated bot to run, ensure the referenced DLL file is available at the required path.
Cause	When migrating a parent bot, if you have not migrated the DLL file or you migrated the DLL file to a different location, then this issue occurs.
Action	Verify that you have successfully migrated the reference DLL file. After your verification, perform one of the following actions: <ul style="list-style-type: none"> <li>• Update the link within the migrated bot so that it points to the right location of the migrated DLL file.</li> <li>• Move the DLL file to the same location as the migrated bot location.</li> </ul>

Code	A124
Message	'Play Sound' action has been migrated. File formats .mid, .wma and .avi formats are not supported.  Update the files to .mp3 or .wav format to run the migrated bot.

Code	A125
Message	Credential value of non string type is not supported for DLL Run function in the migrated bot.  For the migrated bot to run, update the "DLL - Run function" with a string type credential variable or a Global value of appropriate variable type and corresponding mapping.  Refer documentation for more details.
Cause	For the <b>DLL Run</b> action, the credential value of only string type is supported. If the credential value is deleted from the <b>DLL Run</b> command in the Enterprise 10 or Enterprise 11 bot, then this issue occurs.
Action	Update the <b>DLL Run</b> action in the migrated bot by specifying the string type credential value and map it to the corresponding parameters in the migrated bot for it to run. If you want to pass a variable type other than string, create a global value of the required variable and map it to the <b>DLL Run</b> action.

Code	A126
Message	Referenced variables are missing in the V10/11 bot.  For the migrated bot to run, update the 'String-BeforeAfter' action in the migrated bot by providing missing required variables.
Cause	In the Enterprise 10 or Enterprise 11 bot, if the referenced variable is deleted from the <b>String-BeforeAfter</b> command, there are no issues. However, after migration, the missing variable causes an issue because the reference variable is required to run the bot in Automation 360.
Action	Because the reference variable is required for the bot to run, create the missing variable and assign it to the <b>String-BeforeAfter</b> action.

Code	A127
------	------

Message	Referenced variables are missing in the V10/11 bot.  For the migrated bot to run, update the 'String-Compare' action in the migrated bot by providing missing required variables.
Cause	In the Enterprise 10 or Enterprise 11 bot, if the referenced variable is deleted from the <b>String-Compare</b> command, there are no issues. However, after migration, the missing variable causes an issue because the reference variable is required to run the bot in Automation 360.
Action	Because the reference variable is required for bot to run, create the missing variable and assign it to the <b>String-Compare</b> action.

Code	A128
Message	Referenced variables are missing in the V10/11 bot.  For the migrated bot to run, update the 'String-Find' action in the migrated bot by providing missing required variables.
Cause	In the Enterprise 10 or Enterprise 11 bot, if the referenced variable is deleted from the <b>String-Find</b> command, there are no issues. However, after migration, the missing variable causes an issue because the reference variable is required to run the bot in Automation 360.
Action	Because the reference variable is required for bot to run, create the missing variable and assign it to the <b>String-Find</b> action.

Code	A129
Message	Referenced variables are missing in the V10/11 bot.  For the migrated bot to run, update the 'String-Join' action in the migrated bot by providing missing required variables.
Cause	In the Enterprise 10 or Enterprise 11 bot, if the referenced variable is deleted from the <b>String-Join</b> command, there are no issues. However, after migration, the missing variable causes an issue because the reference variable is required to run the bot in Automation 360.
Action	Because the reference variable is required for bot to run, create the missing variable and assign it to the <b>String-Join</b> action.

Code	A130
------	------

Message	Referenced variables are missing in the V10/11 bot.  For the migrated bot to run, update the 'String-Length' action in the migrated bot by providing missing required variables.
Cause	In the Enterprise 10 or Enterprise 11 bot, if the referenced variable is deleted from the <b>String-Length</b> command, there are no issues. However, after migration, the missing variable causes an issue because the reference variable is required to run the bot in Automation 360.
Action	Because the reference variable is required for the bot to run, create the missing variable and assign it to the <b>String-Length</b> action.

Code	A131
Message	Referenced variables are missing in the V10/11 bot.  For the migrated bot to run, update the 'String-Lowercase' action in the migrated bot by providing missing required variables.
Cause	In the Enterprise 10 or Enterprise 11 bot, if the referenced variable is deleted from the <b>String-Lowercase</b> command, there are no issues. However, after migration, the missing variable causes an issue because the reference variable is required to run the bot in Automation 360.
Action	Because the reference variable is required for the bot to run, create the missing variable and assign it to the <b>String-Lowercase</b> action.

Code	A132
Message	Referenced variables are missing in the V10/11 bot.  For the migrated bot to run, update the 'String-Replace' action in the migrated bot by providing missing required variables.
Cause	In the Enterprise 10 or Enterprise 11 bot, if the referenced variable is deleted from the <b>String-Replace</b> command, there are no issues. However, after migration, the missing variable causes an issue because the reference variable is required to run the bot in Automation 360.
Action	Because the reference variable is required for the bot to run, create the missing variable and assign it to the <b>String-Replace</b> action.

Code	A133
------	------

Message	<p>Referenced variables are missing in the V10/11 bot.</p> <p>For the migrated bot to run, update the 'String-Reverse' action in the migrated bot by providing missing required variables.</p>
Cause	<p>In the Enterprise 10 or Enterprise 11 bot, if the referenced variable is deleted from the <b>String-Reverse</b> command,, there are no issues. However, after migration, the missing variable causes an issue because the reference variable is required to run the bot in Automation 360.</p>
Action	<p>Because the reference variable is required for the bot to run, create the missing variable and assign it to the <b>String-Reverse</b> action.</p>

Code	A134
Message	<p>Referenced variables are missing in the V10/11 bot.</p> <p>For the migrated bot to run, update the 'String-Substring' action in the migrated bot by providing missing required variables.</p>
Cause	<p>In the Enterprise 10 or Enterprise 11 bot, if the referenced variable is deleted from the <b>String-Substring</b> command, there are no issues. However, migration, the missing variable causes an issue because the reference variable is required to run the bot in Automation 360.</p>
Action	<p>Because the reference variable is required for the bot to run, create the missing variable and assign it to the <b>String-Substring</b> action.</p>

Code	A135
Message	<p>Referenced variables are missing in the V10/11 bot.</p> <p>For the migrated bot to run, update the 'String-Trim' action in the migrated bot by providing missing required variables.</p>
Cause	<p>In the Enterprise 10 or Enterprise 11 bot, if the referenced variable is deleted from the <b>String-Trim</b> command, there are no issues. However, after migration, the missing variable causes an issue because the reference variable is required to run the bot in Automation 360.</p>
Action	<p>Because the reference variable is required for the bot to run, create the missing variable and assign it to the <b>String-Trim</b> action.</p>

Code	A136
------	------

Message	Referenced variables are missing in the V10/11 bot.  For the migrated bot to run, update the 'String-Uppercase' action in the migrated bot by providing missing required variables.
Cause	In the Enterprise 10 or Enterprise 11 bot, if the referenced variable is deleted from the <b>String-Uppercase</b> command, there are no issues. However, after migration, the missing variable causes an issue because the reference variable is required to run the bot in Automation 360.
Action	Because the reference variable is required for the bot to run, create the missing variable and assign it to the <b>String-Uppercase</b> action.

Code	A137
Message	A variable is missing in the V10/11 bot.  For the migrated bot to run, update the 'String-BeforeAfter' action in the migrated bot by providing a valid variable.
Cause	The unsupported variable type is assigned to the <b>String-BeforeAfter</b> action in the migrated Enterprise 10 or Enterprise 11 bot.
Action	To run the migrated bot, create a valid string variable type and assign it to the <b>String-BeforeAfter</b> action.

Code	A138
Message	A variable is missing in the V10/11 bot.  For the migrated bot to run, update the 'String-Compare' action in the migrated bot by providing a valid variable.
Cause	The unsupported variable type is assigned to the action in the migrated Enterprise 10 or Enterprise 11 bot.
Action	To run the migrated bot, create a string variable type and assign it to the action.

Code	A139
------	------

Message	<p>A variable is missing in the V10/11 bot.</p> <p>For the migrated bot to run, update the 'String-Find' action in the migrated bot by providing a valid variable.</p>
Cause	<p>The unsupported variable type is assigned to the action in the migrated Enterprise 10 or Enterprise 11 bot.</p>
Action	<p>To run the migrated bot, create a string variable type and assign it to the action.</p>

Code	A140
Message	<p>A variable is missing in the V10/11 bot.</p> <p>For the migrated bot to run, update the 'String-Join' action in the migrated bot by providing a valid variable.</p>
Cause	<p>The unsupported variable type is assigned to the action in the migrated Enterprise 10 or Enterprise 11 bot.</p>
Action	<p>To run the migrated bot, create a string variable type and assign it to the action.</p>

Code	A141
Message	<p>A variable is missing in the V10/11 bot.</p> <p>For the migrated bot to run, update the 'String-Length' action in the migrated bot by providing a valid variable.</p>
Cause	<p>The unsupported variable type is assigned to the action in the migrated Enterprise 10 or Enterprise 11 bot.</p>
Action	<p>To run the migrated bot, create a string variable type and assign it to the action.</p>

Code	A142
Message	<p>A variable is missing in the V10/11 bot.</p> <p>For the migrated bot to run, update the 'String-LowerCase' action in the migrated bot by providing a valid variable.</p>

Cause	The unsupported variable type is assigned to the action in the migrated Enterprise 10 or Enterprise 11 bot.
Action	To run the migrated bot, create a string variable type and assign it to the action.

Code	A143
Message	A variable is missing in the V10/11 bot. For the migrated bot to run, update the 'String-Replace' action in the migrated bot by providing a valid variable.
Cause	The unsupported variable type is assigned to the action in the migrated Enterprise 10 or Enterprise 11 bot.
Action	To run the migrated bot, create a string variable type and assign it to the action.

Code	A144
Message	A variable is missing in the V10/11 bot. For the migrated bot to run, update the 'String-Reverse' action in the migrated bot by providing a valid variable.
Cause	The unsupported variable type is assigned to the action in the migrated Enterprise 10 or Enterprise 11 bot.
Action	To run the migrated bot, create a string variable type and assign it to the action.

Code	A145
Message	A variable is missing in the V10/11 bot. For the migrated bot to run, update the 'String-SubString' action in the migrated bot by providing a valid variable.
Cause	The unsupported variable type is assigned to the action in the migrated Enterprise 10 or Enterprise 11 bot.
Action	To run the migrated bot, create a string variable type and assign it to the action.



Code	A146
Message	A variable is missing in the V10/11 bot. For the migrated bot to run, update the 'String-Trim' action in the migrated bot by providing a valid variable.
Cause	The unsupported variable type is assigned to the action in the migrated Enterprise 10 or Enterprise 11 bot.
Action	To run the migrated bot, create a valid string variable type and assign it to the action.

Code	A147
Message	A variable is missing in the V10/11 bot. For the migrated bot to run, update the 'String-UpperCase' action in the migrated bot by providing a valid variable.
Cause	The unsupported variable type is assigned to the action in the migrated Enterprise 10 or Enterprise 11 bot.
Action	To run the migrated bot, create a valid string variable type and assign it to the action.

Code	A149
Message	MetaBot screen that is referenced in the Logic is not present in the MetaBot. For the migrated bot to run, update the object details in the Recorder action. Message code: A149
Cause	Screen details are missing in the Recorder package of the migrated bot. These screen details are required in Automation 360.
Action	You must manually capture the screen details in the migrated bot for it to run successfully.

Code

A151

---

**Note:** As of v.27, bots that contain non-referenced variables are not flagged as **Action Required** or **Review Required** in the Bot Scanner utility for the following variables:

- **\$Excel Column\$**
  - **\$Filedata Column\$**
  - **\$Dataset Column\$**
  - **\$Table Column\$**
  - **\$XML Data Node\$**
  - **\$PDFTitle\$**
  - **\$PDFSubject\$**
  - **\$PDFFileName\$**
  - **\$PDFAuthor\$**
- 

**Note:** As of v.25, bots that contain non-referenced variables are not flagged as **Action Required** in the Bot Scanner utility for the following variables:

- **'\$Error Description\$'**
  - **'\$Error Line Number\$'**
  - **'\$FileName\$'**
  - **'\$Extension\$'**
  - **'\$FolderName\$'**
-

## Messages

1. **'\$Error Description\$'** variable name has been migrated as **'\$Error-Description\$'**.

The '\$Error Description\$' variable used in version 10.x/ 11.x is not created in the A360 due to the absence of actions from corresponding packages.

For the migrated bot to run, create a variable with the same name '\$Error-Description\$' or remove the variable from the respective action.

2. **'\$Error Line Number\$'** variable name has been migrated as **'\$Error-LineNumber\$'**.

The '\$Error Line Number\$' variable used in version 10.x/ 11.x is not created in the A360 due to the absence of actions from corresponding packages.

For the migrated bot to run, create a variable with the same name '\$Error-LineNumber\$' or remove the variable from the respective action.

3. **'\$FileName\$'** variable name has been migrated as **'\$Loop-Files\$'**.

The '\$FileName\$' variable used in version 10.x/ 11.x is not created in the A360 due to the absence of actions from corresponding packages.

For the migrated bot to run, create a variable with the same name '\$Loop-Files\$' or remove the variable from the respective action.

4. **'\$Extension\$'** variable name has been migrated as **'\$Loop-Files\$'**.

The '\$Extension\$' variable used in version 10.x/ 11.x is not created in the A360 due to the absence of actions from corresponding packages.

For the migrated bot to run, create a variable with the same name '\$Loop-Files\$' or remove the variable from the respective action.

5. **'\$FolderName\$'** variable name has been migrated as **'\$Loop-FolderName\$'**.

The '\$FolderName\$' variable used in version 10.x/ 11.x is not created in the A360 due to the absence of actions from corresponding packages.

For the migrated bot to run, create a variable with the same name '\$Loop-FolderName\$' or remove the variable from the respective action.

6. **'\$PDFAuthor\$'** variable name has been migrated as **'\$PDF-Metadata-Dictionary\$'**.

The '\$PDFAuthor\$' variable used in version 10.x/ 11.x is not created in the A360 due to the absence of actions from corresponding packages.

For the migrated bot to run, create a variable with the same name '\$PDF-Metadata-Dictionary\$' or remove

7. **'\$PDFFileName\$'** variable name has been migrated as **'\$PDF-Metadata-Dictionary\$'**.

Cause	(Applies to all A151 messages): This issue occurs if a certain variable is not created in Automation 360 because actions are not present from the corresponding package.
Action	(Applies to all A151 messages): You must create a variable of the relevant variable type (string, number, dictionary, and so on) with the same name in Automation 360, or remove the variable from the respective action to run the migrated bot successfully.

Code	A152
Message	<p>This bot has been migrated.</p> <p>The size of Array type variables exceeds 160,000. Some of the Array type variables are migrated as Table type variables in A360 without the default values.</p> <p>Default value for the Table type variable may be required for the bot to give same results.</p>

Code	A154
Message	<p>For the migrated bot to run, update the 'Simulate keystrokes' action. The excel paste special behavior in A360 is different from the version 10.x/11.x. Message Code: A154</p>
Cause	The <b>Paste Special</b> dialog box varies between Automation 360, Enterprise 11, and Enterprise 10. As a result, the Simulate keystrokes command functions differently.
Action	Update the Simulate keystrokes command in the migrated bot.

Code	A155
Message	<p>For the migrated bot to run update the bot name in the Run Task command. The Metabot logic has been migrated by suffixing '-bot' to the file name</p>
Cause	When a Logic and a folder in the MetaBot have the same name in Enterprise 11, after migration the name of the Logic name is suffixed with -bot so that the Logic can be migrated.
Action	Update the bot name in the <b>Run Task</b> command.

Code	A156
------	------

Message	<p>The migrated bot contains DLL action that returns two dimensional arrays of type Single, Int, Int16, Int32, Int64, UInt, UInt16, UInt32, UInt64, Double, Decimal or Boolean and the output of it is mapped to an array type variable.</p> <p>Update the bot to convert the output array variable (mapped to the return of above listed DLL functions) to String while using it in any operation.</p> <p>E.g. <code>\$arrayoutput[0][0].Number:toString\$</code>  <code>\$arrayoutput[0][0].Boolean:toString\$</code></p>
Cause	<p>When RunDLL output of a function returns 2D array of type number or boolean and is mapped to an array, then Enterprise 11 saves those values as string even though they are number or boolean. However in Automation 360 the values are saved as number. Therefore, runtime error is displayed.</p>
Action	<p>To run the migrated bot, convert the output array variable that is mapped to the return of DLL functions to string when using it in bot.</p>

Code	A157
Message	<p>For the migrated bot to run, update the source string in the String command.</p> <p>The variable stored in a text file and assigned to the variable during bot run is not resolving to the expected value. Update the variable directly in the source string without storing it in a text file.</p>
Cause	<p>The size of the string variable is greater than 64 kb.</p>
Action	<p>Update the variable directly in the source string without storing it in a text file.</p>

Code	A158
Message	<p>Recorder action has been migrated. The object property values greater than 64kb have been truncated. Remove such properties from the object search criteria in the corresponding Recorder action or object condition inside the If or 'Loop While' action in the migrated bot.</p>
Cause	<p>The size of the object property value is greater than 64 kb during migration.</p>
Action	<p>To ensure that the search criteria works properly for the corresponding Recorder action, update the object property value that is truncated.</p>

## Review required messages

These messages are displayed in the Bot Scanner report, Bot Migration Wizard, and Migration Assistant after you migrate the bots. In such cases, the bot is successfully migrated but you still have to manually verify the migrated bots as described in the following messages.

Code	R101
------	------

## Messages

- 1. Excel: Switch to sheet** action has been migrated.  
Review the action session name and type to ensure the shared session name is correct.
- 2. Excel: Close** action has been migrated.  
Review the action session name and type to ensure the shared session name is correct.
- 3. Excel: Delete cells** action has been migrated.  
Review the action session name and type to ensure the shared session name is correct.
- 4. Excel: Find** action has been migrated.  
Review the action session name and type to ensure the shared session name is correct.
- 5. Excel: Get multiple cells** action has been migrated.  
Review the action session name and type to ensure the shared session name is correct.
- 6. Excel: Get single cells** action has been migrated.  
Review the action session name and type to ensure the shared session name is correct.
- 7. Excel: Get cell address** action has been migrated.  
Review the action session name and type to ensure the shared session name is correct.
- 8. Excel: Get column name** action has been migrated.  
Review the action session name and type to ensure the shared session name is correct.
- 9. Excel: Get row number** action has been migrated.  
Review the action session name and type to ensure the shared session name is correct.
- 10. Excel: Replace** action has been migrated.  
Review the action session name and type to ensure the shared session name is correct.
- 11. Excel: Run macro** action has been migrated.  
Review the action session name and type to ensure the shared session name is correct.
- 12. Excel: Save workbook** action has been migrated.  
Review the action session name and type to ensure the shared session name is correct.
- 13. Excel: Set cell** action has been migrated.  
Review the action session name and type to ensure the shared session name is correct.

Code	R102
Message	<p>System variable <b>OS Name</b> has been migrated. Review the value returned for the system variable <b>OS Name</b> in the <i>migrated</i> bot.</p> <p>The value returned by system variable <b>OS Name</b> may be different from version 10.x/11.x.</p>

Code	R103
Message	<p><b>Object Cloning</b> has been migrated. Review the <b>Image Recognition LeftClick</b> action in the migrated bot.</p> <p>Migration of <b>Object Cloning</b> configured with play mode <b>Image</b> with action <b>MiddleClick</b> has been migrated with <b>Image Recognition LeftClick</b> action.</p>

Code	R104
Message	<p><b>String operation - Split</b> action has been migrated. Review the <b>String operation - Split</b> action in the migrated bot.</p> <p>The <b>Limit</b> field is now divided into 2 fields: <b>All Options</b> and <b>Only</b>. <b>Limit</b> has been migrated to <b>Only</b> since it has a variable.</p>

Code	R105
Message	<p><b>App Integration</b> action has been migrated. Review the application type <b>Other</b> in the migrated bot.</p> <p>Migration of <b>App Integration</b> action with application type <b>Other</b> is supported.</p>

Code	R106
Message	<p><b>OCR</b> action has been migrated. Read the Automation 360 OCR package documentation for details.</p> <p><b>ABBYY</b> is the only OCR engine supported.</p>
Cause	<p>Only the ABBYY OCR engine is supported with Automation 360. Irrespective of which OCR engine you have been using in Enterprise 11, after migration your bots will run using only the ABBYY OCR engine.</p>
Action	<p>To learn more about the OCR package, see <a href="#">OCR package</a> on page 2804.</p>



Code	R107
Message	<p><b>Email - Connect with Exchange server</b> action has been migrated.</p> <p>The exchange server version 'Exchange 2013_SP1' is migrated as 'Exchange 2013'. Ensure this version of the <b>Exchange server</b> will work with your system.</p>

Code	R114
Message	<p><b>Terminal Emulator - Connect</b> action has been migrated.</p> <p>The connection type is configured as <b>SSH2</b> since <b>SSH1</b> is not supported in A360.</p> <p>No further action required.</p>
Cause	<p>Enterprise 11 and Enterprise 10 support both the <b>SSH1</b> and <b>SSH2</b> connection types. Automation 360 is upgraded to support only the <b>SSH2</b> connection type. However, your migrated bots that were configured with <b>SSH1</b> will work in Automation 360 and will be configured with the <b>SSH2</b> connection type by default.</p>

Code	R115
Message	<p><b>Terminal Emulator - Connect</b> action has been migrated.</p> <p>All bots now use the Advanced Technology setting. Please test and validate the bot.</p>
Cause	<p>In Enterprise 10 and Enterprise 11, you can choose whether to use the <b>Advanced Technology</b> for the <b>Terminal Emulator - Connect</b> command. Because Automation 360 is upgraded to support only <b>Advanced Technology</b>, all the migrated bots will be configured with Advanced technology for the <b>Terminal Emulator Connect</b> action by default.</p>

Code	R116
Message	<p>The value of the <b>Error Description</b> variable in the <i>migrated bot</i> may be different from version 10.x / 11.x.</p> <p>Review any action that uses the value of the <b>Error Description</b> variable.</p>

Code	R117
------	------

Message	<p><b>Workload: Insert work item</b> action has been migrated.</p> <p>The <b>date format</b> needs to be the same in version <b>10.x / 11.x</b> and Automation 360.</p>
Cause	<p>The <b>date format</b> field in the <b>Workload: Insert work item</b> action uses a default date format.</p>
Action	<p>If the date format is different from the global value <code>AADefaultDateFormat</code>, update the required format in the <b>Workload: Insert work item</b> action.</p>

Code	R118
Message	<p><b>Assign To Clipboard</b> action has been migrated.</p> <p>The referenced variable does not exist in version 10.x / 11.x and has been migrated as a string to Automation 360.</p> <p>The bot may not run as expected.</p>

Code	R119
Message	<p>The <b>Variable Operation</b> action has been migrated.</p> <p>Variable types do not match. The variable has been disabled in the <i>migrated bot</i>.</p> <p>No further action required.</p>
Cause	<p>In Enterprise 11 if you change the variable type (for example, from string to dictionary), the bot ignores the change and moves to the next line. However, in Automation 360, the change in the variable is not supported. So if there is a change in variable type in the migrated bot, the variable is disabled to maintain consistent behavior with Enterprise 11.</p>

Code	R120
Message	<p>'Wait for Window' action has been migrated. The negative value of the X1 coordinate has been set to 0. No further action required.</p>
Cause	<p>In Enterprise 10 and Enterprise 11, the negative value for the X1 coordinate is supported for the <b>Wait for Window</b> action. In Automation 360, the negative value is not supported, so the negative value of the migrated bot is set to 0 by default.</p>

Code	R121
Message	'Wait for Window' action has been migrated. The negative value of the X2 coordinate has been set to 0. No further action required.
Cause	In the Enterprise 10 and Enterprise 11, the negative value for X2 coordinate was supported for <b>Wait for Window</b> action. In Automation 360, the negative value is not supported, so, negative value of the migrated bot is set to 0 by default.

Code	R122
Message	'Wait for Window' action has been migrated. The negative value of the Y1 coordinate has been set to 0. No further action required.
Cause	In Enterprise 10 and Enterprise 11, the negative value for Y1 coordinate is supported for the <b>Wait for Window</b> action. In Automation 360, the negative value is not supported and so the negative value of the migrated bot is set to 0 by default.

Code	R123
Message	'Wait for Window' action has been migrated. The negative value of the Y2 coordinate has been set to 0. No further action required.
Cause	In Enterprise 10 and Enterprise 11, the negative value for Y2 coordinate is supported for the <b>Wait for Window</b> action. In Automation 360, the negative value is not supported and so the negative value of the migrated bot is set to 0 by default.

Code	R124
Message	'Terminal Emulator' action has been migrated. Review the action session name to ensure the shared session name is correct.

Code	R126
------	------

Message	<p>'Window title regex has been migrated.</p> <p>Review the Window title regex in the migrated bot if the window is not found during Bot run.</p>
---------	---

Code	R127
------	------

Message	<p>IfImageReco-FileInFile Command has been migrated.</p> <p>'.jpg, .jpeg, .jpe, .jfif, .bmp, .gif, .png' are the supported file formats for the field 'ImageFile1' action.</p>
---------	--

Code	R128
------	------

Message	<p>Variable with default value greater than 64kb is not supported. The value is stored in a text file and assigned to the variable during bot run.</p>
---------	--

Code	R129
------	------

Message	<p>This bot has been migrated.</p> <p>For the migrated bot to run, a dictionary variable is required in the input variable mapping of run task action. Review the temp dictionary variable created in the parent and mapped in the input variable.</p>
---------	--

Code	R130
------	------

Message	<p>'Run Task' action has been migrated.</p> <p>A credential variable is passed to a non-credential type variable in an unsecured manner. For enhanced security pass the credential variable to a credential type variable.</p> <p>No further action required.</p>
---------	---

Code	R133
------	------

Message	<p>Action with 'AAInstallationPath' has been migrated.</p> <p>The value of the 'AAInstallationPath' in the migrated bot may be different from version 10.x / 11.x.</p> <p>Review any action that uses the value of the 'AAInstallationPath' action.</p>
---------	---

Code	R134
Message	<p>Run Task action has been migrated.</p> <p>The child bot path in the Run Task action is passed through a variable during run time. The value of the variable should pass the correct path of the child bot during the bot run.</p>

Code	R135
Message	<p>Screen Capture action has been migrated along with Log to file action to capture the image and the error description.</p> <p>The file path in the Screen capture action is passed through a variable during run time. The file path in the Log to File action is set to \$AAApplicationPath\$/Temp/Error Handling/ErrorMessage.txt.\ No further action required.</p>

Code	R136
Message	<p>Metabot with logic has been migrated.</p> <p>The same name is used for the Metabot asset folder or logic folder in version 10.x/11.x. The Metabot logic has been migrated by suffixing '-bot' to its name. If any other existing bot matches this new name, the bot will be overridden.</p> <p>Review the migrated bot.</p>

Code	R137
------	------

Message	<p>Metabot with logic has been migrated.</p> <p>This bot has been migrated. The migrated bot has a circular dependency with another bot. Review the bot dependencies in the migrated bot and update the missing dependencies.</p> <p>Review the migrated bot.</p>
---------	---

Code	R138
Message	<p>This bot has been migrated.</p> <p>Object property ClickX or ClickY is variablized.</p> <p>Please recapture the UI object.</p>

Code	R139
Message	<p>This bot has been migrated.</p> <p>Object property SessionId or Id is variablized.</p> <p>Please recapture the UI object.</p>

Code	R140
Message	<p>The Value of the Error Line Number in the migrated bot may be different from the one in version 10.x/11.x. Review any action that uses the value of the Error Line Number in the migrated bot. Message code:R140</p>

Code	R1004
Message	<p>This bot has been migrated.</p> <p>A variable is used in the 'Host' property of this bot. If the variable is pointing to 'office365.com', this can potentially have an impact on the action since the Basic authentication mode that is used to connect to the email server is deprecated by Microsoft. You are advised to review the variable and update the authentication mode by selecting OAuth 2.0 and configuring the required parameters.</p>

## Error messages

These messages are displayed in the Bot Scanner report and Bot Migration Wizard. These messages are displayed when the bot migration is not successful.

Code	E101
Message	This bot cannot be migrated because it has a child bot that uses an unsupported action or system variable.
Cause	A child bot that uses a command that is currently unsupported for migration cannot be migrated. As a result, parent bots that use this child bot also cannot be migrated.
Action	To migrate these parent bots, remove references to the child bot from the parent bot and then migrate that parent bot.  To view unsupported commands that are used in the child bots, go to the list of bots that cannot be migrated and click the child bot name.

Code	E104
Message	This bot cannot be migrated. The Object Cloning command which automates Flash application is not supported in Automation 360. Delete the Object Cloning command which automates Flash application in Enterprise 10.x/Enterprise 11.x bot and then migrate. Message code: E104

Code	E106
Message	This bot cannot be migrated.  The migration of <b>MetaBot with Screens</b> having play mode as Text is not yet supported.  <b>Note:</b> This message is applicable only for Automation 360 v.25 and earlier releases.

Code	E109
Message	This bot cannot be migrated.  The migration of REST API call using SOAP web service with authentication through client certificate is not yet supported.

Code	E110
Message	This bot cannot be migrated. The migration of <b>OCTET DECIMAL BYTE STRING data type</b> is not yet supported.

Code	E112
Message	This bot cannot be migrated. The migration of <b>REST API</b> call using <b>SOAP web service</b> action with <b>Outer XML</b> is not yet supported.

Code	E113
Message	This bot cannot be migrated. The migration of <b>REST API</b> call using <b>SOAP web service</b> action with <b>Inner XML</b> is not yet supported.

Code	E114
Messages	<ol style="list-style-type: none"> <li>1. This bot cannot be migrated. The migration of <b>VariableOperation - ResetSysVariable</b> action is not yet supported.</li> <li>2. This bot cannot be migrated. The migration of <b>Internet - IntCon</b> action is not yet supported.</li> </ol>

Code	E115
Message	This bot cannot be migrated. The migration of <b>Variable Operation</b> action resetting system variable <b>\$WorkItem\$</b> is not supported.
	Resetting the system variable <b>\$WorkItem\$</b> is not supported for <b>Variable Operation</b> command.
	Use the <b>String &gt; Assign</b> operation and assign an empty string to the <b>\$WorkItem\$</b> system variable instead of resetting it.



Code	E116
Message	This bot cannot be migrated. The migration of <b>Variable Operation</b> action resetting system variable <b>\$WorkItemResult\$</b> is not supported.
Cause	Resetting the system variable <b>\$WorkItemResult\$</b> is not supported for <b>Variable Operation</b> command.
Action	Use the <b>String &gt; Assign</b> operation and assign an empty string to the <b>\$WorkItemResult\$</b> system variable instead of resetting it.

Code	E118
Message	Create the Credential or Locker in Automation 360 before migrating this version 10.x / 11.x bot. The credential variables for <b>MetaBot-DLL</b> cannot be migrated because the corresponding Credential or Locker is not present in the Control Room.
Cause	The associated Credential variable is not migrated for the <b>Metabot-DLL</b> because the associated credential or locker is not present in the Enterprise 11 Control Room.
Action	Manually create the credential or locker in the Automation 360 and then migrate the bot.

Code	E119
Message	This bot has an invalid path. Modify the bot path in version 10.x / 11.x and ensure that the bot runs before migrating. The path defined in the <b>Run Task</b> action using <b>\$AAApplicationPath\$</b> is not in a valid repository folder.
Cause	The Enterprise 11 or Enterprise 10 bot uses an invalid path in the <b>Run Task</b> command of the child bot.
Action	To migrate this bot, modify the Enterprise 11 bot to ensure a valid child bot path is provided after <b>AAApplicationPath</b> .

Code	E120
------	------

Message	<p>This bot has an invalid path.</p> <p>Modify the bot path in version 10.x / 11.x and ensure that the bot runs before migrating.</p> <p>The path defined in the <b>If - TaskSuccessful</b> action using <b>\$AAApplicationPath\$</b> is not in a valid repository folder.</p>
Cause	<p>The Enterprise 11 or Enterprise 10 bot uses an invalid path in the <b>If - TaskSuccessful</b> command of the child bot.</p>
Action	<p>To migrate this bot, modify the Enterprise 11 bot to ensure a valid child bot path is provided after <b>AAApplicationPath</b>.</p>

Code	E121
Message	<p>This bot has an invalid path.</p> <p>Modify the bot path in version 10.x / 11.x and ensure that the bot runs before migrating.</p> <p>The path defined in the <b>If - TaskUnsuccessful</b> action using <b>\$AAApplicationPath\$</b> is not in a valid repository folder.</p>
Cause	<p>The Enterprise 11 or Enterprise 10 bot uses an invalid path in the <b>If - TaskUnsuccessful</b> command of the child bot.</p>
Action	<p>To migrate this bot, modify the Enterprise 11 bot to ensure a valid child bot path is provided after <b>AAApplicationPath</b>.</p>

Code	E122
Message	<p>This bot has an invalid path.</p> <p>Modify the bot path in version 10.x / 11.x and ensure that the bot runs before migrating.</p> <p>The path defined in the <b>Elseif - TaskUnsuccessful</b> action using <b>\$AAApplicationPath\$</b> is not in a valid repository folder.</p>
Cause	<p>The Enterprise 11 or Enterprise 10 bot uses an invalid path in the <b>Elseif - TaskUnsuccessful</b> command of the child bot.</p>
Action	<p>To migrate this bot, modify the Enterprise 11 bot to ensure a valid child bot path is provided after <b>AAApplicationPath</b>.</p>

Code	E123
------	------

Message	<p>This bot has an invalid path.</p> <p>Modify the bot path in version 10.x / 11.x and ensure that the bot runs before migrating.</p> <p>The path defined in the <b>Elseif - TaskSuccessful</b> action using <b>\$AAApplicationPath\$</b> is not in a valid repository folder.</p>
Cause	<p>The Enterprise 11 or Enterprise 10 bot uses an invalid path in the <b>Elseif - TaskSuccessful</b> command of the child bot.</p>
Action	<p>To migrate this bot, modify the Enterprise 11 bot to ensure a valid child bot path is provided after <b>AAApplicationPath</b>.</p>

Code	E124
Message	<p>The value being passed to the DLL function is in an invalid format.</p> <p>Modify bot in version 10.x / 11.x before migrating.</p> <p>Validate the <b>array/list variable</b> and the column/index value passed in the <b>DLL function</b> and update the 10.x/11.x bot.</p>

Code	E125
Message	<p>Modify bot in version 10.x / 11.x before migrating.</p> <p>Update the version 10.x / 11.x bot to include referenced variables for the <b>Assign From Clipboard</b> action. A referenced variable was not found.</p>

Code	E127
Message	<p>Modify bot in version 10.x / 11.x before migrating.</p> <p>Variable types do not match or have been changed.</p> <p>Update the variable type in the <b>Variable Operation</b> action in the version 10.x/11.x bot.</p>

Code	E128
Message	<p>This bot cannot be migrated.</p> <p>The migration of 'MetaBot with Screens' using Silverlight technology is not yet supported.</p>

Code	E129
Message	This bot cannot be migrated. The migration of 'MetaBot with Screens' captured using Edge browser is not yet supported.

Code	E130
Message	This bot cannot be migrated. The migration of 'MetaBot with Screens' captured using Firefox browser is not yet supported.

Code	E131
Message	This bot cannot be migrated. The migration of 'MetaBot with Screens' with the 'GetAllChildrenData' action is not yet supported.

Code	E132
Message	This bot cannot be migrated. The migration of 'MetaBot with Screens' with the 'GetVisibility' action is not yet supported.

Code	E133
Message	This bot cannot be migrated. The migration of 'MetaBot with Screens' with linked objects is not yet supported.

Code	E134
Message	This bot cannot be migrated. The migration of 'MetaBot with Screens' with 'play mode as coordinate for linked objects' is not yet supported.

Code	E135
------	------

Message	<p>This bot cannot be migrated.</p> <p>The migration of 'MetaBot with Screens' with 'play mode as image for linked objects' is not yet supported.</p>
---------	---

Code	E136
------	------

Message	<p>This bot cannot be migrated.</p> <p>The migration of 'Object Cloning' action with the Edge browser is not yet supported.</p> <p>This bot cannot be migrated. The Object Cloning command which automates Legacy Edge browser is not supported in Automation 360 . Delete the object cloning command which automates Edge Legacy browser in 10.x/11/x bot and then migrate. Message code: E136</p>
---------	---

Code	E137
------	------

Message	<p>This bot cannot be migrated.</p> <p>The migration of 'Object Cloning' action with the Firefox browser is not yet supported.</p>
---------	--

Code	E138
------	------

Message	<p>This bot cannot be migrated.</p> <p>The migration of 'Object Cloning' action with Silverlight is not yet supported.</p>
---------	--

Code	E139
------	------

Message	<p>This bot cannot be migrated.</p> <p>The migration of 'Object Cloning' action with the 'GetDataofAllchildren' action is not yet supported.</p>
---------	--

Code	E140
------	------

Message	<p>This bot cannot be migrated.</p> <p>The migration of 'Terminal Emulator - Connect' action with 'Japanese (50939) Codepage' is not yet supported.</p>
---------	---

Code	E141
Message	This bot cannot be migrated. The migration of 'Terminal Emulator - Connect action with 'Japanese (51932) Codepage' is not yet supported.

Code	E142
Message	This bot cannot be migrated. The migration of 'Terminal Emulator - Connect' action with 'Japanese JIS (20932) Codepage' is not yet supported.

Code	E143
Message	This bot cannot be migrated. The migration of 'Terminal Emulator - Connect' action with 'Japanese JIS (50220) Codepage' is not yet supported.

Code	E144
Message	This bot cannot be migrated. The migration of 'Terminal Emulator - Connect' action with 'Japanese JIS (50221) Codepage' is not yet supported.

Code	E145
Message	This bot cannot be migrated. The migration of 'Terminal Emulator - Connect' action with 'Japanese JIS (50222) Codepage' is not yet supported.

Code	E146
------	------

Message	<p>This bot cannot be migrated.</p> <p>The migration of 'Terminal Emulator - Connect' action with 'Japanese Katakana (50930) Codepage' is not yet supported.</p>
---------	--

Code	E147
Message	<p>This bot cannot be migrated.</p> <p>The migration of 'Terminal Emulator - Connect' action with 'Japanese Katakana Extended (20290) Codepage' is not yet supported.</p>

Code	E148
Message	<p>This bot cannot be migrated.</p> <p>The migration of 'Terminal Emulator - Connect' action with 'US-Canada and Japanese (50931)' is not yet supported.</p>

Code	E149
Message	<p>This bot cannot be migrated.</p> <p>The migration of Walk command with type All is not supported.</p>

Code	E150
Message	<p>This bot cannot be migrated.</p> <p>The referenced Meta Bot is not available in the provided location. Provide the valid Meta Bot or location in version 10.x / 11.x and try again.</p>

Code	E151
Message	<p>This bot cannot be migrated.</p> <p>The migration of \$IsCognitiveCaptureSuccess\$ action is not supported.</p>

Code	E152
------	------

Message	<p>This bot cannot be migrated.</p> <p>Modify the password type variable in version 10.x/11.x bot before migrating.</p> <p>The migration of command with Password type variable is not supported. This action does not support credential vault variable.</p>
---------	---

Code	E153
Message	<p>This bot cannot be migrated.</p> <p>Modify the SMARTWndCtrl action field variable type in version 10.x/11.x bot before migrating.</p> <p>The migration of SMARTRecorder action SMARTWndCtrl with field 'SetDateRange_NotSupportedAction' of type 'String' is not supported.</p>

Code	E154
Message	<p>This bot cannot be migrated.</p> <p>The migration of 'MetaBot with Screens' with 'play mode as image for linked objects' and 'play mode as object for main objects' is not yet supported.</p>

Code	E155
Message	<p>This bot cannot be migrated.</p> <p>The migration of 'MetaBot with Screens' with 'play mode as image for linked objects' and 'play mode as text for main objects' is not yet supported.</p> <hr/> <p><b>Note:</b> This error is fixed in v.30 and later releases.</p> <hr/>

Code	E156
Message	<p>This bot cannot be migrated.</p> <p>The migration of 'MetaBot with Screens' with 'play mode as object for linked objects' and 'play mode as image for main objects' is not yet supported.</p>



Code	E157
Message	This bot cannot be migrated.  The migration of 'MetaBot with Screens' with 'play mode as object for linked objects' and 'play mode as coordinate for main objects' is not yet supported.

Code	E158
Message	This bot cannot be migrated.  The migration of 'MetaBot with Screens' with 'play mode as object for linked objects' and 'play mode as text for main objects' is not yet supported.

Code	E159
Message	This bot cannot be migrated.  The migration of 'MetaBot with Screens' with 'play mode as text for linked objects' and 'play mode as object for main objects' is not yet supported.

Code	E160
Message	This bot cannot be migrated.  The migration of 'MetaBot with Screens' with 'play mode as text for linked objects' and 'play mode as text for main objects' is not yet supported.

Code	E162
Message	This bot cannot be migrated.  The migration of 'MetaBot with Screens' with 'play mode as coordinate for linked objects' and 'play mode as text for main objects' is not yet supported.

Code	E163
Message	Network Error: Migration failed due to loss of connectivity between Control Room and Bot Runner machine.

Code	E164
Message	<p>This bot cannot be migrated.</p> <p>The migration of 'MetaBot with Screens' with 'play mode as text' and having Import Dataset command with action other than GetText, SetText, DoubleClick, LeftClick and RightClick is not yet supported.</p>

Code	E165
Message	<p>This bot cannot be migrated.</p> <p>The migration of 'MetaBot with Screens' with 'play mode as text' and having any OCR engine other than 'Abbyy' or 'Tesseract' will use 'Abbyy' OCR engine after migration.</p>

Code	E166
Message	<p>This bot cannot be migrated.</p> <p>The total number of 'If' conditions used in the bot exceed the number of 'If' conditions we currently support.</p> <p>For the migrated bot to run, split the bot into smaller units and try again.</p>

Code	E167
Message	<p>This bot cannot be migrated.</p> <p>The total number of 'ElseIf' conditions used in the bot exceed the number of 'ElseIf' conditions we currently support.</p> <p>For the migrated bot to run, split the bot into smaller units and try again.</p>

Code	E168
------	------

Message	<p>This bot cannot be migrated.</p> <p>The total number of 'Loop' conditions used in the bot exceed the number of 'Loop' conditions we currently support.</p> <p>For the migrated bot to run, split the bot into smaller units and try again.</p>
---------	---

## Internet Explorer conversion or scanning messages

These messages are displayed in the Bot Scanner report when bots that use Internet Explorer is run or scanned and are not migrated successfully to other supported browsers.

Code	R1001
Message	<p>A variable is used in the 'Location of the program/file' property of this bot. If the variable is pointing to Internet Explorer, update it such that it points to Chromium based Microsoft Edge browser instead. If not, no further action required.</p>

Code	R1002
Message	<p>Browser components such as Menu bar, Status bar, Favorites bar, Command bar and other non-webpage components differ in each browser, and this can potentially have impact on the captured screens in &lt;PACKAGE_NAME - ACTION_NAME&gt;.</p> <p>You are advised to review and recapture the screen if required.</p>

Code	R1003
Message	<p>RegEx variable used in the window title seems to have partial text corresponding to 'Internet Explorer' hence the title may not get converted as per 'Microsoft Edge' text that is used in the Edge browser window.</p> <p>You are advised to use 'Internet Explorer' text as a whole in the RegEx variable.</p>

## Basic authentication messages

Code	A1001
Message	The Basic authentication mode that is used to connect to the email server is deprecated by Microsoft. For the bot to run, update the authentication mode by selecting OAuth 2.0 and configuring the required parameters. Otherwise, a connection error will occur.
Cause	The Basic authentication mode that is used to connect to the email server is deprecated by Microsoft for Exchange Online.
Action	For the bot to run, update the authentication mode by selecting OAuth 2.0 and configuring the required parameters.

Code	A1002
Message	The Basic authentication mode that is used to connect to the EWS server is deprecated by Microsoft. For the bot to run, update the authentication mode by selecting OAuth 2.0 and configuring the required parameters. Otherwise, a connection error will occur.
Cause	The Basic authentication mode that is used to connect to the email server is deprecated by Microsoft for Exchange Online.
Action	For the bot to run, update the authentication mode by selecting OAuth 2.0 and configuring the required parameters.

## Differences while migrating APIs from Enterprise 11/Enterprise 10 to Automation 360

When you migrate from Enterprise 11 to Automation 360, review any Control Room APIs migration issues and their workarounds.

One difference between the Enterprise 11 and Automation 360 versions occurs in the Credential Value API - Get attributevalues.

```
GET https://{ControlRoomURL}/v2/credentialvault/credentials/{credentialId}/attributevalues
```

In Automation 360, the `CredentialAttribute` object is not available in the response of `GET attributevalues` API. If you are using any parameters in this object in your bot logic then you must modify your response parsing logic and use `GET /v2/credentials/{id}` (See [Credential Vault API](#)) to consume those parameters.

Sample responses for the GET `attributevalues` for both Enterprise 11 and Automation 360 versions:

Enterprise 11	Automation 360
<pre>{   {     "list": [{       "id": "2221",       "credentialAttributeId": "9271",       "value": "LNC2021132D",       "createdBy": "21",       "createdOn": "2021-09-29T12:37:48.765Z",       "updatedBy": "131",       "updatedOn": "2021-10-18T20:47:58.027Z",       "version": "3",       "credentialAttribute": {         "id": "2277",         "name": "ABCD Account",         "description": "",         "userProvided": false,         "masked": false,         "createdBy": "77",         "createdOn": "2021-09-29T12:37:48.638Z",         "updatedBy": "77",         "updatedOn": "2021-09-29T12:37:48.638Z",         "version": "0",         "passwordFlag": false       }     }   ] }</pre>	<pre>{   "list": [{     "id": "4008",     "credentialAttributeId": "1622",     "value": "LNC2021132D",     "createdBy": "21",     "createdOn": "2021-09-29T12:37:48.765Z",     "updatedBy": "274",     "updatedOn": "2021-10-18T20:47:58.027Z",     "version": "3",     "password": false   } ]</pre>

## Migrate Community Edition bots

Bots created in the Enterprise 11 Community Edition environment must be migrated to the Automation 360 Community Edition to allow users to use these bots in Automation 360. You use the Bot Migration package available in the Automation 360 Community Edition to manually migrate the bots.

Before you start migrating bots, do the following:

- Use the Bot Scanner utility to determine if your Enterprise 11 bots can be migrated successfully. [Bot Scanner for migration](#) on page 1529
- Get access to Automation 360 Community Edition.
- Register a device in Automation 360 Community Edition to run bots. [Install Bot Agent and register device](#) on page 1347

This procedure migrates one bot at a time. To migrate all bots within the same folder, you can create a complex bot by iterating files in a folder in a loop or add multiple **Migrate bot** actions for each `.atmx` file you want to migrate.

---

**Important:** If a bot has dependencies on other bots, you must migrate the dependent bots first and then the parent bot. For example, the `main.atmx` parent bot has a dependency on `child1.atmx`, which also has a dependency to `child2.atmx`, then add the **Migrate bot** actions in the following order: `child2.atmx`, followed by `{{child1.atmx}}` and then `{{main.atmx}}`.

---

1. Log in to Automation 360 Community Edition.
2. Use the Bot Migration package to migrate your bots.
  - a) Click **Automation** on the left pane.
  - b) Click **Create New > Bot**, specify the required details, and click **Create & edit**.
  - c) Expand the **Bot Migration** package and double-click the **Migrate bot** action.
  - d) Select **Desktop file** within the **Bot file path** section.
  - e) Enter the complete path of the Enterprise 11 `.atmx` file you want to migrate.
  - f) Optional: Enter the output folder path into the **Output folder path** field to specify where you want package conversion information and errors to be stored.  
A report showing relevant information is generated for each migrated bot.
  - g) Leave the **Overwrite the file if exists** option selected (default setting) if you want this migrated bot to overwrite any bots of the same name in the Automation 360 Community Edition environment.
  - h) Save the bot.
  - i) Run the bot on the connected device to perform the migration.

Successfully migrated bots are uploaded to the Automation 360 private repository of the user who performed the migration. Only successfully migrated bots are migrated. Use the reports in the specified **Output folder path** to see the migration errors.

#### Related tasks

[Scan Enterprise 11 or 10 bots using Bot Scanner](#) on page 1531

Before you migrate to Automation 360, it is important to verify the migration readiness of your bots. Scan the bots using Bot Scanner and analyze the generated report for information about the commands and variables used in these bots and how many of these commands and variables are supported for migration.

#### Related reference

[Bot migration package](#) on page 2433

The **Bot migration** package enables you to migrate Enterprise 10 and Enterprise 11 bots to Automation 360 format. The package also enables you to convert Enterprise 10, Enterprise 11, or Automation 360 bots that use Internet Explorer to Microsoft Edge with IE mode. This package is used internally by the Bot Migration Wizard and the Update Bot wizard.

## Migrate to Automation 360 IQ Bot

Migration is the process of upgrading from earlier versions of IQ Bot (Enterprise 11.x, 6.x, or 5.x) to the latest Automation 360 IQ Bot version. This includes replicating your existing database

and repository, converting your bots to Automation 360 format, and migrating all the learning instances.

## Check migration readiness

Automation 360 IQ Bot features and functionality are the same as IQ Bot Enterprise 11. The existing Enterprise 11 content also applies to Automation 360 IQ Bot.

- You can upgrade to any version of Automation 360 IQ Bot without any restrictions. However, ensure that you use the Database Migration Assistant of the target version to migrate.

For example, if you want to migrate to Automation 360 IQ Bot (Build 11513), you must use the Database Migration Assistant for Automation 360 IQ Bot (Build 11513), which is available as a separate utility in the Automation 360 IQ Bot installation folder.

- Compare some of the key features of Automation 360 IQ Bot deployment models with IQ Bot release.

[Automation 360 IQ Bot feature comparison matrix](#) on page 1005

- Review the IQ Bot version compatibility information.

[Automation 360 IQ Bot version compatibility](#) on page 1010

- Obtain the migration license: [Get migration license](#) on page 1545
- Before migrating from IQ Bot 11.x to Automation 360 IQ Bot On-Premises, ensure you have downloaded the latest version of the Database Migration Assistant from Automation Anywhere Support site.

This tool enables you to migrate data and is supported on the following Microsoft SQL Server versions:

- Microsoft SQL Server 2019 15.0 Developer Edition and Express Edition
- Microsoft SQL Server 2016 13.0 Express Edition
- Microsoft SQL Server 2012 Express Edition

---

**Note:** Database Migration Assistant does not support Azure PaaS Database Service. If you are using Azure PaaS Database Service, you must copy all IQ Bot databases to any of the versions supported above, and run the Database Migration Assistant. Unified databases created using the Database Migration Assistant can then be uploaded back to Azure PaaS Database Service.

- If you are migrating from IQ Bot 11.x to Automation 360 IQ Bot On-Premises, we recommend that you have a 3-node cluster to ensure high availability (HA) for IQ Bot.

[High availability and disaster recovery overview](#)

- For RabbitMQ v3.8.18 disaster recovery (DR), we recommend that you have the same number of nodes in the primary and secondary sites to achieve same load handling capability.

Similarly, the RabbitMQ v3.8.18 cluster setup of the secondary site must replicate the cluster setup of the primary site.

[Disaster recovery deployment model](#)

For RabbitMQ v3.8.18 cluster configuration with auto-recovery, see [RabbitMQ Cluster Configuration with Auto-recovery \(A-People login required\)](#)

## Choose your migration path

Choose your migration path based on the IQ Bot version you are currently using and the Automation 360 IQ Bot deployment model that meets your business requirements.

**Important:** In earlier IQ Bot versions, five databases were created, and in Automation 360 IQ Bot a single unified database is created. So ensure you back up your existing IQ Bot databases before you start the migration.

If you are on this version	Perform this migration procedure
IQ Bot 11.3.4 (or later)	Migrate to Automation 360 IQ Bot On-Premises or Cloud: <ol style="list-style-type: none"> <li>1. <a href="#">Migrate earlier IQ Bot versions to Automation 360 IQ Bot On-Premises</a> on page 1722</li> <li>2. <a href="#">Migrate from Automation 360 IQ Bot On-Premises to Cloud</a> on page 1724</li> </ol> Install the latest version of Automation 360 IQ Bot On-Premises before you migrate to IQ Bot Cloud.
IQ Bot 6.5.x	You can migrate to Automation 360 IQ Bot On-Premises only from IQ Bot Version 11.3.4. <ol style="list-style-type: none"> <li>1. Update IQ Bot Version 6.5 to IQ Bot Version 11.3.4 <a href="#">Update IQ Bot from 6.5 or earlier to 11.3.4</a></li> <li>2. <a href="#">Migrate earlier IQ Bot versions to Automation 360 IQ Bot On-Premises</a> on page 1722</li> <li>3. <a href="#">Migrate from Automation 360 IQ Bot On-Premises to Cloud</a> on page 1724</li> </ol> Install the latest version of Automation 360 IQ Bot On-Premises before you migrate to IQ Bot Cloud.
IQ Bot 5.3.x (or earlier)	<ol style="list-style-type: none"> <li>1. Update to IQ Bot Version 6.5 <a href="#">Update IQ Bot from 5.3.x or 6.0 to 6.5</a></li> <li>2. Update IQ Bot Version 6.5 to Version 11.3.4 <a href="#">Update IQ Bot from 6.5 or earlier to 11.3.4</a></li> <li>3. <a href="#">Migrate earlier IQ Bot versions to Automation 360 IQ Bot On-Premises</a> on page 1722</li> <li>4. <a href="#">Migrate from Automation 360 IQ Bot On-Premises to Cloud</a> on page 1724</li> </ol> Install the latest version of Automation 360 IQ Bot On-Premises before you migrate to IQ Bot Cloud.



Related concepts

[Install and update Automation 360 IQ Bot](#) on page 1426

This collection of topics guide you through the process of installing or setting up Automation 360 IQ Bot On-Premises and Cloud.

## Prepare for IQ Bot migration

Perform these tasks before you migrate to Automation 360 IQ Bot (On-Premises) from an earlier IQ Bot version (from Enterprise 6.x through 11.x).

1. If you are currently using any of the earlier versions of Automation Anywhere Enterprise (10.x or 11.x), ensure you migrate to the latest Automation 360 version.

[Migrate to Automation 360](#) on page 1496

2. Ensure the Automation 360 version corresponds to the Automation 360 IQ Bot that you are installing.

[Automation 360 IQ Bot version compatibility](#) on page 1010

3. Migrate to the latest Automation 360 IQ Bot On-Premises from IQ Bot Version 11.3.4 or later versions. If you are currently using any of the earlier IQ Bot versions (5.3.x), you must first perform these tasks:

- a) Update to IQ Bot Version 6.5.

See [Update IQ Bot from 5.3.x or 6.0 to 6.5](#)

- b) Update IQ Bot Version 6.5 to IQ Bot Version 11.3.4 before migrating to Automation 360 IQ Bot On-Premises.

See [Update IQ Bot from 6.5 or earlier to 11.3.4](#)

4. Back up your existing IQ Bot databases.

In the earlier IQ Bot versions, five databases were created. With Automation 360 IQ Bot On-Premises Build 2545, a single unified database is created.

- a) Ensure you back up all five databases:

- AliasData
- ClassifierData
- Configurations
- FileManager
- MLData

- b) Uninstall any earlier IQ Bot versions.

Uninstalling an existing IQ Bot build does not delete the databases.

5. Install Database Migration Assistant.

- a) Log into Automation Anywhere support site and download the Database Migration Assistant:

[A-People Downloads page \(Login required\)](#)

---

**Note:** Ensure that **OBDC Driver version 17.0 for SQL Server** is available on your system before you run the Database Migration Assistant.

---

- b) Double-click the file to run Database Migration Assistant.

- c) Click **Next** to continue.

- d) Accept the license agreement. and click **Next**.
- e) In the **Database Configuration** screen, enter your existing IQ Bot database host name and credentials, and click **Next**.

---

**Note:** The SQL Server Browser service must be running if you want to use the full name of the SQL Server as the host name.

---

- f) (Optional) Click **Browse** to change the default installation folder for the Database Migration Assistant.
- g) Click **Install**.  
After a successful installation, a new database called IQBot is created. You can use the following path to review the log files:

C:\Users\Public\Documents\Migration\_Assistant\_Logs

---

**Note:** After migration to Automation 360 IQ Bot completes, output files processed in IQ Bot 11x will not be available for download through the IQ Bot package in the Control Room.

---

## Migrate earlier IQ Bot versions to Automation 360 IQ Bot On-Premises

Migrate from an earlier IQ Bot version (from Enterprise 6.x through 11.x) to Automation 360 IQ Bot (On-Premises) for the latest features and enhancements.

1. Download Automation 360 IQ Bot
  - a) Log into Automation Anywhere support site to download the latest Automation 360 IQ Bot build:  
[A-People Downloads page \(Login required\)](#)
  - b) Extract (unzip) the Automation\_Anywhere\_IQ\_Bot\_A2019\_(Build number) folder and run the following .bat files:
    1. CleanupRabbitMQandErlang.bat
    2. CleanupRabbitMQErlangPython.bat
    3. UninstallPython.bat
    4. UninstallPython385.bat

These files remove the registry entries of RabbitMQ v3.8.18, Erlang/OTP relevant IQ Bot Python. No other Python versions are affected.
  - c) Restart your machine.
2. Install Automation 360 IQ Bot
  - a) Open Automation\_Anywhere\_IQ\_Bot\_A2019\_(Build number) folder and run the following files again:
    1. CleanupRabbitMQandErlang.bat
    2. CleanupRabbitMQErlangPython.bat

3. UninstallPython.bat
4. UninstallPython385.bat

This procedure removes any empty folders from RabbitMQ v3.8.18, Erlang, and Python.

- b) Install the Automation 360 IQ Bot build.
  - c) During installation, specify the same host name where the IQBot database was created. Automation 360 IQ Bot automatically connects to the IQBot database that was created by the Database Migration Assistant before migrating the data.
  - d) When the installation completes, unregister IQ Bot Enterprise 11.  
[Unregistering IQ Bot from the Control Room](#)  
Automation 360 IQ Bot automatically connects to the IQBot database that was created by the Database Migration Assistant before migrating the data.
  - e) Clear the browser cache.
  - f) (Optional) Restart the **Cognitive Console** service if IQ Bot fails to load.
3. Register Automation 360 IQ Bot
    - a) Register IQ Bot A360.x with the Control Room.  
x refers to the latest version of Automation 360 IQ Bot.  
[Registering IQ Bot with the Control Room](#)  
Troubleshooting:
      - If the login page is not displayed after registering IQ Bot A360.x, restart the Control Room services (Control Room and Control Room Reverse proxy).
      - If none of the domains or dashboards are displayed when you log in to Automation 360 IQ Bot after a successful migration, perform the following steps:
        - Press the F12 key and click the **Network** tab to view the APIs.  
If the APIs are unauthorized or display an error message, restart the IQ Bot service.
        - If the bots are not displayed in the learning instances, clear the browser cache.
    - b) After the registration, restart the Automation Anywhere Cognitive Application service.
4. Modify the output file name
    - a) After the data is migrated, ensure you modify the name of the output .csv file.  
The output .csv file in Automation 360 IQ Bot contains additional characters. If you are using the download command, use the following instructions to edit the output .csv filename:
      - Remove the brackets [ ].
      - Replace the underscore (\_) character with a hyphen (-).
      - Replace spaces with underscore (\_).For example, if the output .csv filename is [sales-7d6961f3d28]\_Invoice.tiff, rename it as sales-7d6\_961f3d28-Invoice.tiff.
5. Verify the migrated data

- a) Log in to the Automation 360 IQ Bot as a newly created IQ Bot user.
- b) Review the data displayed on the **Dashboard** to ensure that the IQ Bot 11.3.x data has been migrated.
- c) You can also verify the migrated data by checking the following pages:
  - Learning Instances
  - Domains
  - Bot Pages

Ensure that the current OCR version is supported in Automation 360 IQ Bot.

- ABBYY FineReader Engine - 12.2, 12.3, or 12.4 (use the version provided in the installation folder)

---

**Note:** To upgrade the OCR version, download the OCR package to the installation folder.

---

- Tesseract OCR - 4
- Google Vision API - version is updated automatically to match current release
- Microsoft Azure Computer Vision OCR engine - 2.0 or 3.2
- Tegaki API - check with your Cogent Labs sales representative

Related information

[IQ Bot migration with keys stored in external vault \(Login required\)](#)

## Migrate from Automation 360 IQ Bot On-Premises to Cloud

IQ Bot Cloud offers all the Automation 360 IQ Bot On-Premises features through a browser-based interface.

- Migrate Control Room before migrating to IQ Bot Cloud. If you have Control Room available on Cloud, you can migrate to IQ Bot Cloud.
- Install the latest version of Automation 360 IQ Bot On-Premises before migrating to IQ Bot Cloud.

See [Migrate earlier IQ Bot versions to Automation 360 IQ Bot On-Premises](#) on page 1722.

- Ensure that an active IQ Bot Cloud instance with the same version is available.
- If there is an incorrect IQ Bot registration data, ensure that you remove it before creating the correct registration data.

Keep in mind the following considerations when migrating from Automation 360 IQ Bot On-Premises to IQ Bot Cloud:

- IQ Bot Cloud is a single-node instance.

Before you start the migration, ensure that you review the document processing and concurrency requirements. Cluster setup is not supported on IQ Bot Cloud.

- Configuration files cannot be accessed in the IQ Bot Cloud.

Custom OCR settings in configuration files have to be uploaded into Automation 360 IQ Bot On-Premises database before migration.

[How to change OCR Settings in IQ Bot \(A-People login required\)](#)

- Python scripting is restricted to specific libraries on IQ Bot Cloud.

Customer-specific Python files, specific libraries, and methods are not allowed in IQ Bot Cloud.

[List of supported Pandas Libraries in Automation 360 IQ Bot \(A-People login required\)](#)

- Role-Based Access Control (RBAC) setup that you have configured on the Automation 360 IQ Bot On-Premises is not migrated to IQ Bot Cloud.

See [RBAC in Control Room](#) on page 1036.

- Transfer the `.iqba` files to IQ Bot Cloud.

Any custom roles that you have created are removed before `.iqba` files are created. Ensure that you add these roles after transferring the `.iqba` files to IQ Bot Cloud.

Users have the following options to upload the `.iqba` file to IQ Bot Cloud :

- Click **Migration Utility** > **Export/Import** in Automation 360 IQ Bot On-Premises (starting from Build 5931).

[Migrate learning instances](#) on page 1725

- Migrate learning instance in IQ Bot Cloud through API. Use the Migration Utility feature to generate `.iqba` learning instance files, transfer them between systems, and import them into new IQ Bot databases.

[Migrate Learning Instances in IQ Bot Cloud through API \(A-People login required\)](#)

1. Export custom domains from Automation 360 IQ Bot On-Premises to IQ Bot Cloud.

[Custom domains in IQ Bot](#) on page 3796

2. Use the Migration Utility feature to export learning instances from the Automation 360 IQ Bot On-Premises version.
3. Use the IQ Bot UI or API to upload the `.iqba` file to IQ Bot Cloud.
4. Open IQ Bot Cloud and import learning instances by using Migration Utility.

All your learning instances from Automation 360 IQ Bot On-Premises are imported and available on IQ Bot Cloud.

---

**Important:** Review the following points:

- If the learning instances are large, migrate them one at a time to avoid timeouts.
- If you use custom domains, migrate them.
- Import the custom domains in the same order as they were in in the Automation 360 IQ Bot On-Premises version.

---

## Migrate learning instances

Use the Automation 360 IQ Bot Migration Utility feature to migrate (export and import) learning instances between environments to avoid recreating similar learning instances and easily manage the lifecycle of the associated bots.

The learning instances can be migrated by the IQ Bot administrator or a user associated with custom role that has migration permissions. View a list of available learning instances by using **IQ Bot > Administrator > Migration** to go to the Migration Utility page.

## What is transferred across environments

When you export a learning instance, an IQBA file is created with the following assets:

- Document groups
- Training documents (one per document group)
- RPA bots (one per document group)
- Custom domain (contact Automation Anywhere Enterprise support for assistance with transferring this type of asset)

---

**Note:** Production documents cannot be exported.

---

## Transferring learning instances between IQ Bot environments

To move a learning instance from one environment to another, perform the following steps:

1. Ensure that the source and destination systems are running the same IQ Bot version. Learning instances from different IQ Bot versions cannot be imported because their database schemas will not match.
2. Back up your database and export the learning instances from the source IQ Bot environment: [Backup and export learning instance](#) on page 1726
3. Import the IQBA file into the destination IQ Bot environment: [Import learning instance](#) on page 1727

---

**Note:** From Automation 360 v.29 version, you can export, import, download, and upload an IQBA file with maximum size of 5 GB. You can follow these best practices or recommendations when the IQBA file size is 5 GB.

- When you export a 5 GB file, the system slows down significantly. This cannot be avoided since resources are utilized to support this export activity.
- You must perform an LI export activity during IQ Bot downtime or off-peak hours when you are not actively using the system. During the export process, you must not perform any other actions on IQ Bot which could lead to inconsistent results.

---

### Backup and export learning instance

Ensure you backup your existing learning instance before exporting it. A learning instance is exported as IQ Bot archive (IQBA) file. Groups, bots, and learnings associated with the learning instance are also exported.

When you export a learning instance, only a single document associated with every available bot (Group) training is exported. However, the production documents do not get exported.

---

**Note:**

- Ensure that you do not export a learning instance that has only unclassified groups.
- Due to reduced staging document size while exporting IQBA files, the training numbers in the table are not displayed correctly. Possible workaround for the issue are as follows:
  - Before import: Open the exported IQ Bot archive (IQBA) files, and delete all records from the `VisionBotRunDetails.csv` and `DocumentProcessedDetails.csv` files in it.

Doing this after import, results in the **files processed through test bot** value to be zero. The **training unprocessed** will not show the correct training files value instead of any negative value.

- After import: Run the **Test Bots** for bots that are showing negative **training unprocessed** values against them. After the successful execution of **Test Bot**, its **training unprocessed** value is 0.

1. Log into IQ Bot as an administrator.
2. Click **Administration > Migration**.
3. Click **Create Backup**.
4. Select the learning instances you want to back up and then click **Backup**.
5. Enter an appropriate name for the IQBA file and click **Backup** to begin the export process. The exported data file with the `.iqba` extension is available in the `BackupData` folder in your IQ Bot output directory. For example, `C:\Users\Public\Documents\Automation Anywhere IQBot Platform\Output\BackupData`.

#### Import learning instance

Import a learning instance to use the associated groups and bots in a different Automation 360 IQ Bot environment.

You can only import a learning instance into a similar or equivalent IQ Bot version. For example, you can only import an IQ Bot On-Premises (Build 9642) learning instance into an equivalent version of IQ Bot On-Premises or Cloud.

1. Log into IQ Bot as an administrator.
2. Click **Administration > Migration**.
3. Click **Upload**.
4. Select the `.iqba` file you want to upload from your file system.

Exported learning instances are stored as `.iqba` files. Ensure you select the correct file to import your learning instances into your new IQ Bot environment.

5. Select from the following import options:

Import option	Result
Option 1: Append imported groups and trained bots to duplicate existing learning instances:	Merges new document groups and bots in existing learning instances.  <b>Note:</b> When you import the <code>.iqba</code> file using this option, a trained group in the imported file overwrites an untrained group in the destination environment.

Import option	Result
Option 2: Import learning instances, and ignore duplicate learning instances:	Appends only new learning instances, where the learning instance ID in the <code>.iqba</code> file differs from the ID in the destination environment. If a learning instance ID in the <code>.iqba</code> file is the same as an ID in the destination environment, the learning instance from the file is not appended.
Option 3: Overwrite duplicate existing learning instances with imported learning instances:	All documents groups and bots in the existing learning instance in the destination environment are replaced with the ones from the imported file. This does not impact the dashboard metrics.  <b>Note:</b> You must use this option if the learning instance in the <code>.iqba</code> file was edited (for example, if fields or table columns were added).
Option 4: Remove all existing learning instances and replace with imported learning instances:	Only use this option if it is okay to lose all the work done so far in an IQ Bot environment.

#### Additional considerations

- If the `.iqba` file contains a document group that was previously deleted from the learning instance in the destination environment and you import it using Options 1,3, or 4, IQ Bot restores the deleted version of that group.
- Document groups in the `.iqba` file are imported in the same state as they were exported. For example, if you select Option 3 to overwrite a learning instance with a group in production mode with an imported learning instance that has a group in staging mode, that imported group remains in staging mode and incoming documents will not be automatically processed.

For more information on how each option impacts the groups, see [Example: Import options results](#) on page 1729.

#### 6. Click **Open**.

After your file is uploaded, click **Refresh** to manually refresh the page and use the uploaded file from the list.

#### 7. Click the import icon next to the backup entry in the list.

The imported learning instances are restored in the destination environment.



Example: Import options results

If the destination IQ Bot environment contains a learning instance with the same ID as the one in the IQBA file, you must select an import option to instruct IQ Bot how to handle the document groups in the learning instance. This page walks you through the most-common scenarios.

### Scenario 1: Destination environment is empty

In this scenario, the destination environment is empty, such as in the case of a new installation of a testing environment. For the simplicity of this example, the IQBA file contains one learning instance with two groups. The fourth column of the table shows the outcome of each import option.

G = group

Import option	Environment before importing IQBA file	IQBA file	Environment after importing the IQBA file
Option 1: Append imported groups and trained bots to duplicate existing learning instances:		G1, G2	G1, G2
Option 2: Import learning instances, and ignore duplicate learning instances:			G1, G2
Option 3: Overwrite duplicate existing learning instances with imported learning instances:			G1, G2
Option 4: Remove all existing learning instances and replace with imported learning instances:			G1, G2

### Scenario 2: Import a learning instance with new groups

In this scenario, the learning instance in the IQBA file has document groups which are not present in the learning instance in the destination environment. The fourth column of the table shows the outcome of each import option, with the groups already present in the environment italicized for emphasis.

Note that in option 3, the imported learning instance (IQBA file) overwrites the duplicate existing learning instance. To determine whether a learning instance is a duplicate, the system compares the IDs of the learning instances in the two environments, not the groups. As a result, the environment after the import only contains G3.

Import option	Environment before importing IQBA file	IQBA file	Environment after importing the IQBA file
Option 1: Append imported groups and trained bots to duplicate existing learning instances:	G1, G2	G3	G1, G2, G3
Option 2: Import learning instances, and ignore duplicate learning instances:			G1, G2
Option 3: Overwrite duplicate existing learning instances with imported learning instances:			G3
Option 4: Remove all existing learning instances and replace with imported learning instances:			G3

### Scenario 3: Import a learning instance with duplicate groups

In this scenario, the learning instance in the IQBA file has the same groups as the learning instance in the destination environment, for example, the groups were retrained. The fourth column of the table shows the outcome of each import option, with the groups already present in the environment italicized for emphasis.

Import option	Environment before importing IQBA file	IQBA file	Environment after importing the IQBA file
Option 1: Append imported groups and trained bots to duplicate existing learning instances:	G1, G2, G3	G3	G1, G2, G3
Option 2: Import learning instances, and ignore duplicate learning instances:			G1, G2, G3
Option 3: Overwrite duplicate existing learning instances with imported learning instances:			G3

Import option	Environment before importing IQBA file	IQBA file	Environment after importing the IQBA file
Option 4: Remove all existing learning instances and replace with imported learning instances:			G3

## Migration Utility enhancements

Starting from the Automation 360 IQ Bot.14 release, enhancements for importing learning instances (that were created using a custom domain) to the production server are available.

Migrating learning instances (that were created using a custom domain) from one system to another does not automatically import the associated domain to the target system. Therefore, when you run the imported learning instances on the production documents, the documents do not get classified because the associated field names and IDs for the custom domain do not work in the imported learning instance.

## Migrating single or multiple learning instances

Prerequisite: The same version of the custom domain must exist in the staging (source) and production (target) servers.

IQ Bot includes some checks for importing a learning instance to the production environment to ensure the custom domain associated with a learning instance is migrated to the production server first, so the learning instances do not fail after migration.

- You can import the same learning instance to the production server multiple times.  
However if you import a learning instance with an edited or updated domain and if the updated domain does not exist in the production server, the system will not allow you to import the learning instance.
- In this scenario, if the **Import** option is used (**IQ Bot > Migration** tab) to import the learning instance, a system-generated error message is displayed stating that the learning instance version is incompatible, and the import process is canceled.
- IQ Bot checks for the following when importing a learning instance to the production server:
  - Does the domain exist in the production server?
  - Do the same fields exist in the production server?
  - Do the same field aliases (available variations for a specific field in the documents) exist in the production server?
- Learning instance import fails if the system detects an issue with any of the checks.
- An import is successful when the user has maintained the same version of the custom domains, associated with the learning instance, in the staging and production servers.

If the learning instance import fails, the user can find the reason for the migration failure in the following locations:

- In the IQ Bot `Project service log` files, which will show an inconsistency in any of the following parameters:
  - domain name

- field names
  - project or learning instance name
  - field alias names
- In the **Control Room > Audit logs**

[Custom domains in IQ Bot](#)

## Migrating RBAC in IQ Bot

When you migrate learning instances that are associated with custom roles, you must also migrate the roles to enable users in the destination environment to access the learning instances. Before you start your migration, review the comparison matrix for in RBAC IQ Bot 11.3.5.x with Automation 360 IQ Bot.

## Comparing RBAC

The following table compares RBAC provided in IQ Bot 11.3.5.x with Automation 360 IQ Bot:

Feature	Supported in IQ Bot 11.3.5.x	Supported in Automation 360 IQ Bot
Separation of permissions to learning instances by departments using custom roles	Yes	Yes
Assigning roles to learning instances on creation	Yes	Yes
Support for system roles: <ul style="list-style-type: none"> <li>• Automation 360 IQ Bot administrator</li> <li>• IQ Bot services</li> <li>• IQ Bot Validator</li> </ul>	Yes	Yes
Changing assigned role for learning instances	Yes	No
User can have different access levels to different learning instances	Yes	No
Transfer of roles when learning instances are moved from one environment to another	No	No

However, you can use the **Assign Roles** functionality to assign roles to the learning instance.

Feature	Supported in IQ Bot 11.3.5.x	Supported in Automation 360 IQ Bot
All permissions of IQ Bot are implemented	Yes	No The following permissions are not implemented: <ul style="list-style-type: none"> <li>Edit learning instance</li> <li>Delete learning instance</li> <li>Send learning instance to production</li> <li>Import domain</li> </ul>

## Requirements before migrating RBAC

- Ensure that you do not associate the role of a user who can create a learning instance with any of the IQ Bot system roles. Instead, associate these users with a custom role.
- If a user who can create a learning instance has a custom role, a correct role corresponding to the department must be assigned to ensure a seamless RBAC operation on the learning instance. However, ensure that these users do not have any other role assigned other than the custom role for creating a learning instance and the corresponding department role.
- User who can create a learning instance must not be associated with any non IQ Bot roles. This restriction is not applicable to other users with custom roles.
- All users who can create a learning instance must not be assigned to one custom role (for creating learning instance). Instead, these users must be assigned to department-specific custom role (for creating learning instance).
- Ensure that the **View ALL learning instances** permission is not used in the custom role because it provides users with access to IQ Bot services.
- Ensure that any role other than the department role is not assigned to a learning instance, as this can increase the risk of unauthorized users accessing the learning instance.
- Users with the **Launch validator** permission in the custom role can only view IQ Bot if there is at least one learning instance with documents to validate.

## Plan your migration

RBAC functionality such as setup and features for custom roles differ between IQ Bot 11.3.5.x and Automation 360 IQ Bot. So keep the following in mind for migration:

- You can migrate RBAC to Automation 360 IQ Bot only from IQ Bot 11.3.5 or later versions.
- You can migrate IQ Bot 11.3.5.x to both Automation 360 IQ Bot On-Premises and Cloud.
- When you migrate RBAC, all the custom and user roles are also migrated from Control Room 11.3.5.x to Automation 360.
- Ensure you segregate the learning instances for RBAC use cases between departments, organization units, and so on.

## Choose your RBAC migration path

Choose your RBAC migration path based on the IQ Bot version you are currently using and the Automation 360 IQ Bot deployment model that meets your business requirements:

- [Migrate RBAC to On-Premises](#)
- [Migrate RBAC to Cloud](#)

If you are performing the migration steps using APIs, see [IQ Bot roles migration APIs \(A-People login required\)](#)

## Migrate RBAC to Automation 360 IQ Bot On-Premises

Migrate RBAC from an earlier IQ Bot version (11.3.5.x or later) to Automation 360 IQ Bot On-Premises for the latest features and enhancements.

1. Create new custom roles (department roles) corresponding to each department or organizational unit in Control Room.

Consider a scenario where you have setup the RBAC across various departments in your organization with HR\_Dept, Finance\_Dept and Sales\_Dept as the department roles. For sub-divisions within these departments, the roles can be Finance\_AP\_Payments, Finance\_Cash\_Payments, and so on.

2. Ensure you give the following permissions for each department role that you create:

- **View IQ Bot**
- **View learning Instances**
- **View learning instances for same role in Control Room**

3. Add the respective department roles to all of the IQ Bot users in Control Room.

For example, Sam from the Human Resource department is assigned the HR\_Dept role and Susan from the Finance department is assigned the Finance\_Dept role.

4. Associate users who create learning instances with the corresponding roles.

Users creating learning instances for a department can only be associated with IQ Bot roles. For example, these users cannot be associated with roles such as AA Basic, AA Bot Developer, and so on.

Additionally, only the IQ Bot custom role with **Create learning instance** permission must be assigned along with the corresponding department role.

5. Backup the `LearningInstanceRoles` table in the Automation 360 IQ Bot database.

The database schema name is `IQBot`.

6. Use the following database query to get the list of learning instances and the roles from the migrated Automation 360 IQ Bot database:

```
SELECT p.name as LearningInstance,
r.projectid as LearningInstanceID,
r.role as Role FROM [IQBot].[dbo].LearningInstanceRoles r inner join
[IQBot].[dbo].ProjectDetail p on r.projectid=p.id;
```

7. Download the output query of the database to a local CSV file.

For example, `learninginstanceroles.csv`

8. Remove all the role entries against the learning instances in the local CSV file.

For example, `learninginstanceroles.csv`. After removing the role entries, duplicate rows for each learning instance must be removed to keep just 1 row per learning instance in the CSV file.

---

**Note:** If there are learning instances which are not RBAC controlled, then role entries must not be changed

---

9. Assign the department role (Step 3) to each of the learning instance in the local CSV file and save your changes.
10. Remove all the entries from the `LearningInstanceRoles` table in IQBot database scheme. You can use the following SQL command to remove the entries:

```
DELETE from [IQBot].[dbo].LearningInstanceRoles;
```

11. Insert the modified learning instance role association defined in local CSV file (Step 8) into the `LearningInstanceRoles` table.

For example, use the following SQL statement:

```
INSERT INTO [IQBot].[dbo].LearningInstanceRoles
(projectid, role) values
('i13454546erty', 'HR_Dept');
```

12. Verify the RBAC setup in Automation 360 IQ Bot and ensure that only the correct users have the access to the learning instances.

## Migrate RBAC to Automation 360 IQ Bot Cloud

Migrate RBAC from an earlier IQ Bot version (11.3.5.x or later) to Automation 360 IQ Bot Cloud for the latest features and enhancements.

1. Create new custom roles (department roles) corresponding to each department or organizational unit in Cloud Control Room.

Consider a scenario where you have setup the RBAC across various departments in your organization with `HR_Dept`, `Finance_Dept` and `Sales_Dept` as the department roles. For sub-divisions within these departments, the roles can be `Finance_AP_Payments`, `Finance_Cash_Payments`, and so on.

2. Ensure you give the following permissions for each department role that you create:

- **View IQ Bot**
- **View learning Instances**
- **View learning instances for same role in Control Room**

3. Add the respective department roles to all of the IQ Bot users in Control Room.

For example, Sam from the Human Resource department is assigned the `HR_Dept` role and Susan from the Finance department is assigned the `Finance_Dept` role.

4. Associate users who create learning instances with the corresponding roles.

Users creating learning instances for a department can only be associated with IQ Bot roles. For example, these users cannot be associated with roles such as `AA Basic`, `AA Bot Developer`, and so on.

Additionally, only the IQ Bot custom role with **Create learning instance** permission must be assigned along with the corresponding department role.

5. Backup the `LearningInstanceRoles` table in the Automation 360 IQ Bot database.

The database schema name is IQBot.

6. Use the following database query to get the list of learning instances and the roles from the migrated Automation 360 IQ Bot database:

```
SELECT p.name as LearningInstance,  
r.projectid as LearningInstanceID,  
r.role as Role FROM [IQBot].[dbo].LearningInstanceRoles r inner join  
[IQBot].[dbo].ProjectDetail p on r.projectid=p.id;
```

7. Download the output query of the database to a local CSV file.

For example, `learninginstanceroles.csv`

8. Remove all the role entries against the learning instances in the local CSV file.

For example, `learninginstanceroles.csv`. After removing the role entries, duplicate rows for each learning instance must be removed to keep just 1 row per learning instance in the CSV file.

---

**Note:** If there are learning instances which are not RBAC controlled, then role entries must not be changed

---

9. Assign the department role (Step 3) to each of the learning instance in the local CSV file and save your changes.
10. As the `LearningInstanceRoles` table in IQBot Cloud will be empty, provide the CSV file (Step 9) to Automation Anywhere support so that they can update the Cloud database.
11. Insert the modified learning instance role association defined in local CSV file (Step 9) into the `LearningInstanceRoles` table.

For example, use the following SQL statement:

```
INSERT INTO [IQBot].[dbo].LearningInstanceRoles  
(projectid, role) values  
(\i13454546erty', 'HR_Dept');
```

---

**Note:** Ensure you perform this step for all the entries in the local CSV file.

---

12. Verify the RBAC setup in Automation 360 IQ Bot and ensure that only the correct users have the access to the learning instances.



# Configure Automation 360

Control Room administrators manage settings related to the database, Credential Vault, users, roles, action packages, licensing, and more.

Related tasks

[Create a role](#) on page 1748

As an administrator, you can configure roles with permissions to access features and perform operations such as create, edit, or delete a bot in the Control Room, and assign the role to a user.

[Create a user](#) on page 1739

Create a user and assign their specific license based role.

[Installing additional licenses](#) on page 1786

Upload new licenses to the Automation Anywhere Control Room to be distributed to users as required.

[Create credential](#) on page 1864

Create a credential and add the required attributes.

## Users

As an administrator, you can create, view, edit, delete, and enable or disable a user. Creating users steps vary depending on whether the user is a non-Active Directory, Active Directory, or single sign-on (SSO) user from an IdP server.

### Column actions

- Click a column header to sort by ascending or descending order.
- Drag and drop a column header to move the column left or right.
- Drag the end of a column corner to re-size.

---

**Note:** The **API key expiration** column displays the date and time when the API key expires for users who have generated their API keys. You can use this information to notify the users to renew their API keys before the API keys expire so that the users can run their automations seamlessly.

---

### Individual user actions

Perform the following tasks on an individual user:

View

Opens the **View user** page in read-only mode. It shows user details, assigned roles, and general details such as **Last Modified**, **Modified by**, **Object type**, and **User type**.

You can edit a user detail and enable or disable a user.

Edit	<p>Opens the <b>Edit user</b> page in write mode. You can update user details, device login credentials, assigned roles, and device licenses. When you edit a user, an email is sent notifying the user if SMTP is enabled.</p> <p>Only user devices with the Bot Agent installed at the system level are available for selection as the default device.</p>
Enable   Disable	<p>Activates or deactivates the user. When you enable or disable a user, an email is sent notifying the user if SMTP is enabled.</p>
Delete	<p>Deletes the user. This is useful when users leave an organization or move to another role. This frees both the device to which the user was attached and the allocated license.</p> <p>When you delete a user, an email is sent notifying the user if SMTP is enabled.</p> <hr/> <p><b>Note:</b> Before removing a user from the active RPA, administrators should make certain all unfinished development of bots are checked-in.</p> <hr/>

### Table-level actions

Perform the following tasks by hovering the mouse over the icons at the top-right of the **User** table. These actions can be performed only at a table-level and not on individual items.

Create role with checked items	<p>Adds a role and assigns the selected users.</p> <p><a href="#">Create a user</a> on page 1739</p>
Delete checked items	<p>Deletes the selected users. You cannot delete a user who is currently logged in.</p>
Export to CSV	<p>Exports the users listed in the table in CSV format.</p> <hr/> <p><b>Note:</b> You can view the API key expiration information for users who have generated their API keys. You can use this information to notify the users to renew their API keys before the API keys expire.</p> <hr/>
Refresh table	<p>Refreshes the table and reflects the latest data.</p>
Customize columns	<p>Select the columns to show or hide in the table.</p>

## Create a user

Create a user and assign their specific license based role.

Ensure that you are logged in to the as the administrator.

1. Navigate to **Administration > Users**.
2. Click **Create user**.
3. Enter the required general details as follows:

Field	Value
Enable User	Select for the user to be activated and log in immediately.  <b>Note:</b> If this option is not selected, user will be in the inactive state and cannot log in.
Username	Enter a unique user name.
Description	Enter a description for the user.
First name	Enter the first name for the user.  <b>Note:</b> The number of characters allowed in the <b>First name</b> field is 50.
Last name	Enter the last name for the user.  <b>Note:</b> The number of characters allowed in the <b>Last name</b> field is 50.
Password	Enter and confirm a password for the user. Ensure that the password follows all the necessary password policies.
Email	Enter and confirm the email address for the user.  If SMTP is enabled, an email is sent to this address to confirm the account. All important Control Room notifications are sent to this email address.

4. Select the required role from the list of **Available roles**.
5. Click the right arrow (→) to add your selection.
6. Select **Allow** to allow multiple sessions.  
You must be Control Room administrator to set a user as a multi-login service user. It is possible to set a user as a multi-login user either in the UI or API, however a user may only access multiple sessions through the API.
7. Assign a device license to the user.

**Note:** When you logged in as administrator, you cannot allocate any device license to the user and **None** option is selected by default.

License	Privilege
None	The user can access the Control Room only.
Bot Creator- Development license	Enables user to create and run bots. Auto login is enabled by default.
Unattended Bot Runner - Run-time license	Users with this license can perform all automation tasks that attended users can perform. Additionally, this license can also be used for Control Room deployment, centralized scheduling, and API-based deployment.
Attended Bot Runner - Run-time license	Users with this license can run bots on their devices and use any event trigger associated with their user account or role. However, these users cannot schedule bots.
Citizen Developer - Development license	Users with this license can create and run bots (including bots with triggers) on their devices.

The **Bypass legal disclaimer** option is automatically enabled to allow the user to run bots on a device without having to manually acknowledge a disclaimer.

After you select a device license, the **Device login credentials** are enabled. If you have the **Attest device credentials** permission, you can choose to attest the device credentials for this user to bypass credential validation when you deploy bots. The Bot Runner user should have an unlocked and active user session.

**Note:** This works only if the auto login setting **Reuse an existing session** is selected in the Control Room by the administrator.

8. Click **Create user**.

Watch the following video on how to create a user in Automation 360:

## Create an Active Directory user

Add the Active Directory user by selecting the AD domain, providing AD environment details, and assigning a role and device license.

Ensure that you are logged in to the as the administrator.

**Note:** Before removing a user, administrators should make certain all unfinished development of bots are checked-in.

1. Navigate to **Administration > Users**.

2. In the **General Details** section, enter the following information:

a) **Enable User**: Select this option so that the user can log in immediately.

b) **Active Directory domain**: Select the active directory name for the user.

The list displays all the domains that are available in the Active Directory domain controller.

---

**Note:** Control Room Active Directory supports single forest multi-domain environment.

---

c) **Username**: Click **CHECK NAME IN ACTIVE DIRECTORY**.

- If the user name is present in the Active Directory database, the **First name**, **Last name**, **Email**, and **Confirm email** fields are automatically populated.

If the data is not automatically populated, enter the details in the fields.

---

**Note:** You can use reserved characters, such as the comma (,), in the username.

---

- If the username is not present in the Active Directory database, an error message is displayed. Contact the network administrator to resolve the issue.

If SMTP is enabled, the user is sent an email to this address to confirm the account. All important Control Room notifications will be sent to this email address. You can use the "@" character to accommodate email user names.

---

**Note:** To support SSO over SAML, the User Principal Name (such as in Azure Active Directory) must match the corresponding username in the control room.

---

3. Select the required role from the list of **Available roles**.

4. Assign a device license to the user.

---

**Note:** When you logged in as administrator, you cannot allocate any device license to the user and **None** option is selected by default.

---

License	Privilege
None	The user can access the Control Room only.
Bot Creator- Development license	Enables user to create and run bots. Auto login is enabled by default.
Unattended Bot Runner - Run-time license	Users with this license can perform all automation tasks that attended users can perform. Additionally, this license can also be used for Control Room deployment, centralized scheduling, and API-based deployment.
Attended Bot Runner - Run-time license	Users with this license can run bots on their devices and use any event trigger associated with their user account or role. However, these users cannot schedule bots.

License	Privilege
Citizen Developer - Development license	Users with this license can create and run bots (including bots with triggers) on their devices.

The **Bypass legal disclaimer** option is automatically enabled to allow the user to run bots on a device without having to manually acknowledge a disclaimer.

After you select a device license, the **Device login credentials** are enabled. If you have the **Attest device credentials** permission, you can choose to attest the device credentials for this user to bypass credential validation when you deploy bots. The Bot Runner user should have an unlocked and active user session.

**Note:** This works only if the auto login setting **Reuse an existing session** is selected in the Control Room by the administrator.

## 5. Click **Create user**.

### Citizen Developer user

A Citizen Developer is a business user who can create and run bots, and share these automated tasks with peers. Citizen Developer is typically not a technical expert but a specialist such as a marketing analyst, HR manager, and accounts manager.

### Overview

Users with bot creation capability can create, edit, run, or schedule bots on their device. While users with bot execution capability can access a public folder to run or schedule published bots. Citizen Developer users combine these capabilities to create bots, access the public folder, and clone published bots and run them on their devices.

### Capabilities

In an organization, an administrator typically creates the Citizen Developer role with the necessary bot permissions and specifies the database or folder access. The administrator assigns this role to existing or new users and allocates the Citizen Developer license to them.

A Citizen Developer user can then perform the following tasks:

- Create bots and run them on their devices.
- Add and delete event triggers for bots on their devices.

Citizen developer user can create a private event trigger. However, the associated bot must be checked in to a public folder for other citizen developer or Bot Runner users to access that event trigger.

- Publish their bots to the public folder where other Citizen Developer users can access them.
- Access the public folder and clone published bots (including bots with triggers).
- Customize cloned bots and run them on their devices.
- Check in bots from their devices to the public folder.
- Check out bots from the public folder.

The following image illustrates the capabilities of a Citizen Developer user:

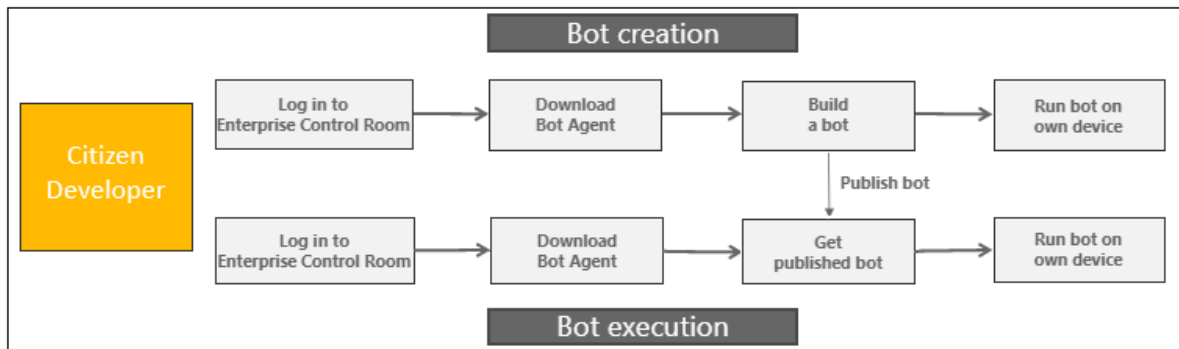

## Example

Consider a scenario where an organization has Marketing and Finance teams. The administrator creates the following two Citizen Developer roles:

- CD (Marketing): provides access to all Marketing team folders
- CD (Finance): provides access to all Finance team folders

The administrator then assigns the Citizen Developer license to users within each team. Citizen Developer users with the CD (Marketing) role can create and run bots on their devices. When a user with the CD (Marketing) role publishes a bot to a public folder, other Citizen Developer users within the Marketing team can clone and run this bot on their devices.

Similarly, Citizen Developer users with the CD (Finance) role will have the same capabilities within the Finance team folders. However, users from one team cannot access any folders and published bots from the other team.

## Comparing Citizen Developer and Bot Creator licenses

Understand the capabilities available for each user to help you choose license based on the automation requirements for your organization.

### Citizen Developer license

Citizen Developers are business users who can create simple automations with little to no coding knowledge. A Citizen Developer license is designed for a business user such as marketing analyst, HR manager, and accounts manager. They have limited technical knowledge but have strong practical experience in the business processes. This helps them create simple, easy-to-use applications to improve the business processes. Based on the business requirements, an administrator can restrict package access for bot development to a Citizen Developer to provide a simplified developer experience. Complex packages are hidden from Citizen

Bot Creator license

Developers so that they can focus on easy-to-complete automation.

Bot Creators are advanced developers who design, develop, and implement bots to improve business process efficiency and have substantial coding knowledge. A Bot Creator license is designed for professional developers who have strong technical knowledge and can build complex and critical applications. Depending on the privileges provided by the administrator, they can access more functionalities in the Automation 360 platform such as advanced and complex packages, ability to create API tasks, approve code reviews submitted by Citizen Developers, and so on.

Review the capabilities available for a Citizen Developer and Bot Creator license:

Citizen Developer	Bot Creator
Business user with strong process knowledge but limited coding skills	Professional developer with strong technical skills and knowledge of system architecture
Does not have access to advanced packages or features	Has access to advanced packages and features
Low coding knowledge	In depth knowledge about coding and system architecture
Builds simple applications to simply business processes	Build complex and critical applications for business processes
Does not have to follow the software development lifecycle to build applications	Follows software development lifecycle to build applications
Low cost and resource is easily available	High cost and resource not easily available

For more information (including advanced packages restricted for Citizen Developers), go to [Restricted User Terms for AAI Citizen Developer Licenses](#) → Citizen Developer Licenses section.

Related tasks

[Create a Citizen Developer user](#) on page 1745

A Citizen Developer is a business user who can build and run bots on their devices, which then function as their digital assistants.

[Create a Citizen Developer role](#) on page 1764

A Citizen Developer role enables the associated users to create and run bots on their registered devices.

[Adding event triggers](#) on page 2141

Any bot with triggers can be associated with users or role to enable event trigger. Control Room user (or role) with **Manage event triggers** permission can add event triggers.

Related reference

[Automation 360 licenses](#) on page 1407



The **All Licenses** page displays detailed information about current product and device licenses.

## Create a Citizen Developer user

A Citizen Developer is a business user who can build and run bots on their devices, which then function as their digital assistants.

Ensure that you are logged in to the as the administrator.

1. Navigate to **Administration > Users**.
2. Click **Create user**.
3. Enter the following user details:
  - a) Select the **Enable User** option if you want the user to be able to log in immediately.
  - b) Enter a unique user name.
  - c) Optional: Enter a description for the user.
  - d) Optional: Enter the first name and last name.

---

**Note:** The number of characters allowed for the first and last name is 50.

---

- e) Enter and confirm a password for the user.  
Ensure the password follows any necessary password policy.
  - f) Enter and confirm the email address for the user.  
If SMTP is enabled, the user is sent an email to this address to confirm the account. All Control Room notifications will be sent to this email address.
4. Select a Citizen Developer role from the list of **Available roles**.  
If there is no Citizen Developer role available, create one in Control Room.  
[Create a Citizen Developer role](#) on page 1764
5. Click the right arrow (→) to add your selection.
6. Assign the Citizen Developer license to the user.  
The license enables users access to the Control Room only and enables them to create and run bots.  
  
The **Bypass legal disclaimer** option is automatically enabled to allow the user to run bots on a device without having to manually acknowledge a disclaimer.
7. Click **Create user**.

## Multi-login user

A multi-login user can log in to multiple sessions of a Control Room through the API at the same time.

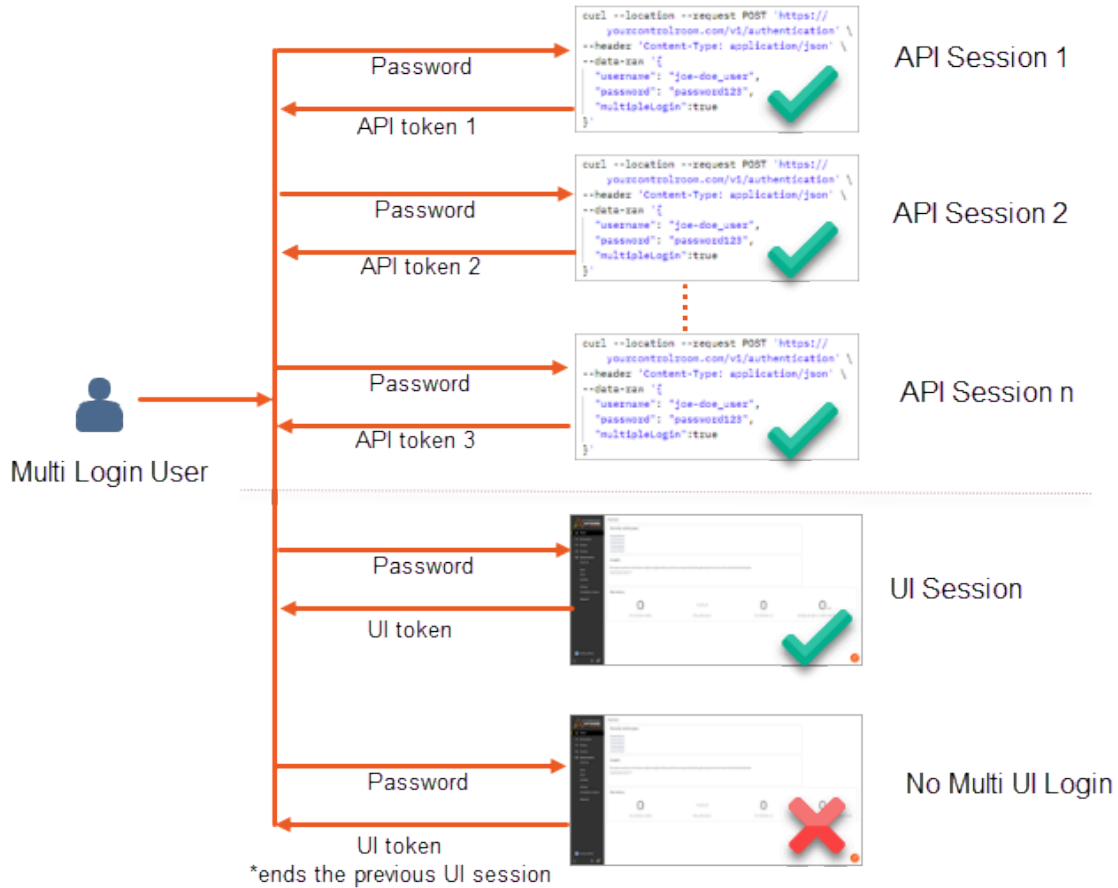

**Note:** Multiple sessions are not allowed for Control Room access through the UI.

A multi-login token is required if you want to configure a Control Room user to use different processes at the same time using multi tokens generate using the API. You need a Control Room administrator role to set a user as a multi-login service user. It is possible to set a user as a multi-login user either in the UI or API.

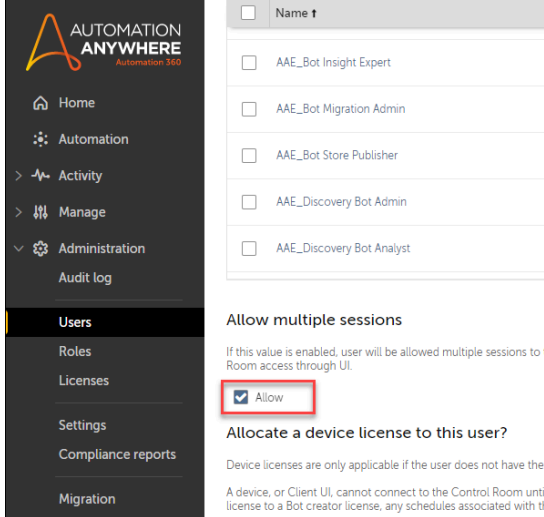
Authorize using UI	Authorize using API
<p>In the Control Room, go to <b>Administration &gt; Users</b> and select <b>Allow</b> under <b>Allow multiple sessions</b> to enable multi-login.</p> 	<p>Using the Authentication API</p> <p>Request</p> <pre>POST http://{{ControlRoomURL}}/v1/authentication</pre> <p>Request body to generate multi-login token:</p> <pre>{   "username": "jdoe",   "password": "mypassword@123",   "multipleLogin": true }</pre>

## Reset user password

The Control Room administrator generates an email process for the user to reset their password. Ensure that you are logged in to the as the administrator.

The change password email process.

1. Navigate to **Administration > Users**.
2. Select user from the list.
3. Click the **Edit** icon. (✎)
4. Select **Send reset password email**.

**Note:** If there is no email server configured, follow these steps to reset the password for a user:

- a) Open the URL for the Control Room in your browser.
- b) Enter the user name, click **Forgot Password**, and follow the prompts to reset or change the password.
- c) Enter the user name, click the **Forgot Password** button, and follow the prompts to reset or change the password.

The selected user receives an email with the necessary instructions to reset the password.

Related tasks

[Log in to Automation Anywhere Control Room](#) on page 1488

To log in to Automation 360, open the Control Room URL in your browser, enter your credentials in the login screen, and click **Log in**.

## Roles

The Control Room enforces role-based access control (RBAC). There are two types of roles: **System-created** and **User-created**.

RBAC enables users to access specific features based on the assigned roles and the accessibility provided to the user. The benefits of creating roles include:

- Increased security by controlling users access according to their specified roles.
- Ability to create user roles based on your organization's requirements.
- Ability to create user roles with all possible permissions that are supported in the Control Room.
- Ability to customize roles based on your needs without any permissions being disabled. You can select all the required permissions.
- Ability to assign permissions to a role based on your organization's requirements.

### System-created roles

These roles are preconfigured with the permissions necessary to perform the tasks within the scope of a system-created role. You can modify or delete system-created roles.

---

**Note:** It is optional to use system-created roles.

---

### User-created roles

These roles are created by authorized users. You can create a user-created role with all possible or available permissions.

---

**Note:** Before you create and assign roles that are similar to system-created roles, you should consider any potential security risks. For example, if you create a role with permissions similar to **AAE\_Admin**, such users will be able to make changes to the Control Room settings.

---

Before removing a user role from an active RPA, administrators need to verify that all unfinished bot development is checked-in.

## Create a role

As an administrator, you can configure roles with permissions to access features and perform operations such as create, edit, or delete a bot in the Control Room, and assign the role to a user.

Ensure that you have the **Mange roles** permission.

---

**Note:** You can create user roles with any or all permissions and user roles that are similar to the system roles. However, ensure that you understand the risks involved in creating and assigning such user roles. For example, if you create a role with permissions similar to **AAE\_Admin**, such users will be able to make changes to the Control Room settings.

---

Assign specific permissions to each user. You can only select active users.

1. Navigate to **Administration > Roles**.
2. Click **Create role**.
3. Enter the **Name**.
4. Optional: Enter a description.
5. Select the feature permissions.  
For more information about the available feature permissions by product, see [Feature permissions for a role](#) on page 1749.
6. Click **Next**.
7. Based on the option you select, perform the required action:

Option	Action
View my bots permission	Select the bots permissions. <a href="#">Bot permissions for a role</a> on page 1763
Run my bots permission	Select the Bot Runner devices.

8. Click **Next**.
9. Select user from the list.
10. Click **Create role**.

The following video shows how to create custom roles:

Related concepts

[Bot permissions for a role](#) on page 1763

Assign bot permissions when creating a role with the View my bots feature permission.

Related reference

[System roles](#) on page 1768

System roles are preconfigured with the permissions necessary to perform the tasks within the scope of that role. They cannot be modified or deleted. Administrators assign the roles to users to enable them to access features and perform operations in the Control Room.

## Feature permissions for a role

A user with the **Manage roles** permission can create and assign roles to users to provide them with access to features and operations.

We recommend that you create individual roles with specific permissions. You can then assign the limited roles to users with that specific permission requirement.

## Administration

Permission	Description
View users	<p>Allows users to only view all other users in the system. They cannot create, edit, or delete users.</p> <hr/> <p><b>Note:</b> You must assign this permission before assigning the <code>Create user</code>, <code>Update user</code>, or <code>Delete user</code> permission.</p> <hr/>
Create users	Allows users to create new users in the Control Room.
Edit users	Allows users to edit all users in the system.
Delete users	Allows users to delete other users the Control Room.
View roles	<p>Users with this permission are able to view the roles in the Control Room.</p> <hr/> <p><b>Note:</b> You must assign this permission before assigning the <code>Manage roles</code> permission.</p> <hr/>
Manage roles	Allows users to view and manage all roles in the Control Room.
View users and roles basic information	Allows users to view basic information on users and roles in the Control Room.
View Settings	Allows users to view all the administrator settings in the Control Room. However, users will be unable to edit the settings.
Manage Settings	Allows users to edit the administrator settings in the Control Room.
View and manage compliance reports	Allows users to view, create, and download compliance reports for users.
View migration	<p>Allows users to view new migrations, but not run them.</p> <hr/> <p><b>Note:</b> You must assign this permission before assigning the <code>manage migration</code> permission.</p> <hr/>
Manage migration	Allows users to view and run new migrations.
Allow a Bot Runner user to run migrations	Allows Bot Runner user to update the bot conversion status in the Control Room.

Permission	Description
View bot update	Allows a user to view the status and summary of each bot update instance when the bots are converted on the <b>Administration &gt; Update Bot wizard</b> page. However, the user cannot run the updates. To do that, a user needs the <b>Manage bot update</b> permission.
Manage bot update	Allows a user to run new bot updates by using the Update Bot wizard.
Allow a Bot Runner user to update bots	Allows Bot Runner users to send bot update status back to the Control Room so that it is visible in the Update Bot wizard report.  This permission is assigned by default to the user with the <b>AAE_Admin</b> role.
View licenses	Allows users to view the license details for the Control Room.
Manage user's device licenses	Allows users to assign device licenses to other users.
Install licenses	Allows users to install Automation 360 licenses for the Control Room.
View policies	Allows users to view the policies which define how automations can be built.
Manage policies	Allows users to view and manage the policies which define how automations can be built.
View operations data	Allows users to view operations related widgets on the Automation Command Center homepage.
View operations details	Allows users to select widgets on the Automation Command Center homepage to view their operations details.

## Automation Co-Pilot for Business Users

Table 3: Permissions

Permission	Product behavior
View and manage MY teams	Roles with this permission can view and manage Teams. This includes creating a new Team and adding and removing users on existing Team they created.
View and manage ALL teams	Roles with this permission can view and manage <b>ALL teams</b> .

Permission	Product behavior
View and manage ALL applications	Roles with this permission can access and manage applications created for their Automation Co-Pilot instance. The applications feature offers an iFrame widget of Automation Co-Pilot embedded in third party applications.
View and Manage ALL bots	Roles with this permission will be able to access and manage bots created for their Automation Co-Pilot.
View and Manage ALL extensions	Roles with this permission will be able to access and manage extensions created for their Automation Co-Pilot.
Extension API for Service Account	Roles with this permission can be used to set up a service account, required for the Automation Co-Pilot extension.

## API

Permission	Description
Bot Insight Data API	Allows access to Bot Insight RESTful APIs to the data logged by the Control Room and by a task during production runs.
Generate API-Key	<p>Users can generate an <b>apiKey</b> that can be used in the Authentication API.</p> <hr/> <p><b>Note:</b> Users without the <code>generateapikey</code> permission can use APIs by authenticating using their username and password. <a href="#">Authentication API</a></p> <hr/>

## Activity

Permission	Description
View my activity	Allows users to view their in progress and historical activities.
Manage my activity	Allows users to pause, resume, or cancel their in progress activity and move their finished activities to history.
View activity from user's folder	Allows user to view in progress and historical activity of bots from the assigned folders where the user has either run or schedule access.



Permission	Description
Manage activity from user's folder	Allows users to pause, resume or cancel in progress activity, and view historical activity for bots from the assigned folders where the user has either run or schedule access.
View everyone's activity	Allows users to monitor ongoing automations where the user has either run or schedule access on the respective bot.
Manage everyone's activity	Allows users to pause, resume, or cancel all in progress activities and move the finished activities to history.
View my scheduled bots	Allows users to view their own schedules only.
Schedule my bots to run	Allows users to schedule their bots to run when they have permission to view and manage Bot Runners.
Edit my scheduled activity	Allows users to edit their own schedules only.
Delete my scheduled activity	Allows users to delete their own schedules only.
View ALL scheduled activity from my Folders	Allows users to view all the schedules for the bot folders to which they have access. It includes their own schedules and schedules created by other users.
Manage ALL scheduled activity from my Folders	Allows users to view, edit, and delete all schedules for the bot folders to which they have access. It includes their own schedules and schedules created by other users.
View ALL scheduled activity	Allows users to view all the schedules in the system. This includes schedules that the user created or schedules created by other users.
Manage ALL scheduled activity	Allows users to view, edit, and delete all the schedules in the system. This includes schedules that the user created or schedules created by other users.
Set automation priority to high	Allows users to set the automation priority to high to run and schedule bots. Automations with high priority are given preference over the medium and low priority automations so that you can run and schedule the high priority automations.

## Audit log

Permission	Description
View everyone's audit log actions	Allows users to view all audit log activity for the Control Room.

## Bots

Permission	Description
View my bots	<p>Allows users to view the bots they created and bots that were assigned to them.</p> <hr/> <p><b>Note:</b> You must assign this permission before assigning any other bots permissions.</p> <hr/>
Run my bots	Allows users to run the bots they created and bots that were assigned to them.
Export bots	Allows users to export bots and related bot dependencies for which they have download permission.
Download exported files	Allows users to download exported zip files.
Import bots	Allows users to import bots and bot dependencies for which they have upload permission.
Label bots	<p>Allows users to create labels for a particular version of a bot. These labels allow the users to schedule, run, queue, export, and trigger bot development workflows with the version of their choice.</p> <hr/> <p><b>Note:</b> The <b>Set production version</b> permission is redundant in Automation 360 although it might be displayed when you migrate bots from Enterprise 11. The <b>Label bots</b> permission is the equivalent of <b>Set production version</b> in Automation 360.</p> <p>If you want to select the <b>Export bots</b> option, you must select the <b>Set production version</b> permission in such cases. Also, if you want to provide the ability to set production version, you must select the <b>Label bots</b> permission.</p> <hr/>

Permission	Description
Recover bots	Allows users to recover the private workspace of deleted users (Bot Creators or Citizen Developers)
Create folders	Allows users to create folders within the folders that they have access to.
Rename folders	Allows users to rename the folders to which they have access.  <b>Note:</b> Only empty folders can be renamed.
Cancel checkout	Allows users to cancel bot checkout and unlock the file from the public repository.
Restore from git	Allows users to restore bots and files from Git.

## Bot Insight

Permission	Description
View and manage default business dashboards	Allows users to perform operations such as view, save, save as, delete on default or custom dashboards from private folder bots.
View published dashboards	Allows users to view the published dashboards for all public folder bots.
Manage published dashboards	Allows users to perform operations such as save, save as, delete, add chart on published dashboards from public folder bots.
View operations data	Allows users to view operations data for all the bots irrespective of the folder permissions.

## Bot Store

Permission	Description
View Bot Store	Allows users to view Bot Store.
Add bots from Bot Store to My Bots	Allow users to add bot packages from Bot Store to their Control Room private workspace.
Submit bots to Bot Store	Allow users to submit bot packages to Bot Store.

## Code analysis policy enforcement

Permission	Description
Enable enforcement for bot check-in	Allows users to check in the automation file if it has no code analysis violations.
Allow check-in with low severity violations	Allows users to check in the automation file if it has low severity code analysis violations.
Allow check-in with high severity violations	Allows users to check in the automation file if it has high severity code analysis violations.

## Credentials

Permission	Description
Manage my credentials and lockers	Allows users to create, edit, and delete their own credentials. In addition, the user can interact with credentials from their assigned lockers.
Manage my lockers	Allows users to create and manage their own lockers.
Administer ALL lockers	Allows users to create, edit, and delete all lockers (including lockers created by other users) available in their Control Room.
Create standard attributes for a credential	Allows users to create a standard attribute for a credential that is shared across all users of that credential.
View and edit ALL credentials attributes value	Allows authorized users to access and modify attribute values for all credentials, including masked credentials, through APIs  <b>Important:</b> Be extremely cautious while granting this permission, as it will provide the user with access to all credential values including passwords.
Bot Auto-Login Credentials API	Allow users to automate the login process to run bots remotely.

**Note:** A user with the `AAE_Locker Admin` role can view all credentials and lockers in the Control Room. See [System roles](#) on page 1768.

## Dashboards

Permission	Description
View dashboards	Allows users to view the dashboard.

## Devices

Permission	Description
Register device	Allows users to register a local host device. <a href="#">Devices</a> on page 1873
Edit the devices	<p>Allows users to edit the devices that they have permission to see.</p> <p>Allows you to view and manage all (registered and non-registered) devices from a specific accessible group.</p> <hr/> <p><b>Note:</b> To view and manage registered and non-registered devices,</p> <ul style="list-style-type: none"> <li>The Control Room administrator must grant access to manage a specific set of devices.</li> <li>You must select <b>Devices from my device pool(s)</b> to edit devices from device pools and <b>Run as user(s) default device</b> to edit Run as user(s) default device options in the <b>Edit devices</b> permission.</li> </ul> <hr/>
Devices from my device pools	Allows users to view and edit devices from the device pools that they own.
Run as users default devices	Allows users to view and edit run-as users default devices that they have access to.
Delete the devices	Allows users to edit the devices that they have permission to see.
View and manage ALL devices	Allows users to view and manage all devices in the Control Room.
View all bot runner users	Allows users to view and add all run-as-users (unattended Bot Runner users) when creating a role, running bots, or scheduling bots.

Permission	Description
Attest device credentials	<p>Allows users to attest device credentials for Bot Runner users. You can deploy bots on user devices with unlocked and active user session without a system password to bypass credential validation.</p> <hr/> <p><b>Note:</b> This permission works only if the auto-login setting <b>Reuse an existing session</b> is selected in the Control Room by the administrator.</p> <hr/>
View and manage my Bot Runners, Bot Creators and device pools	<p>Allows users to view and manage Bot Creators, Bot Runners, and device pools.</p> <hr/> <p><b>Note:</b> All roles have this permission by default.</p> <hr/>
Create device pools	Allows users to create and manage their own device pools.
Administer ALL device pools	Allows users to manage all device pools.

**Note:** A user with the `AAE_Pool1_Admin` role can manage all device pools in the Control Room. See [System roles](#) on page 1768.

## Discovery Bot process

Permission	Description
View assigned process	<p>Allows users to view assigned processes.</p> <hr/> <p><b>Note:</b> This is the standard permission. You must assign this permission before assigning any process discovery permissions.</p> <hr/>
View all processes	Allows users to view all the defined processes.
Edit process	Allows users to create and edit processes.

## Discovery Bot recording

Permission	Description
View all recordings	Allows users to view all recordings.

Permission	Description
View own recording	Allows users to view their own recording.  <b>Note:</b> You must assign this permission before assigning any of the following permissions.
Run recorder and create recording	Allows users to run the recorder and create recording.
Edit own recording	Allows users to edit their own recording.
Delete own recording	Allows users to delete their own recording.

### Discovery Bot aggregation

Permission	Description
View all aggregation	Allows users to view all aggregations.
View own aggregation	Allows users to view their own aggregations.  <b>Note:</b> You must assign this permission before assigning any of the permissions below.
Create or delete own aggregation	Allows users to create and delete aggregations.
Edit aggregation	Allows users to update aggregations.
View system generated aggregation	Allows users to view system aggregations.

### Discovery Bot opportunity

Permission	Description
View all opportunities	Allows users to view all opportunities.
View opportunity	Allows users to view opportunities within assigned process.  <b>Note:</b> You must assign this permission before assigning any of the permissions below.
Create or delete opportunity	Allows users to create and delete opportunities within the assigned process.
Convert to bot	Allows users to convert an opportunity to a bot.
Export opportunity	Allows users to export an opportunity.

## Event triggers

Permission	Description
View event triggers	Allows users to view event triggers.
Manage event triggers	Allows users to view and manage event triggers.  <b>Note:</b> You must assign the <code>view</code> permission before assigning this permission.

## Global values

Permission	Description
View and manage global values	Allows users to view, create, edit, and delete global values.

## IQ Bot

Permission	Description
View IQ Bot	Allows users to view the default dashboards in the IQ Bot portal.  <b>Note:</b> You must assign this permission before assigning any of the other IQ Bot permissions.

## IQ Bot administration permissions

Permission ID	Description
View Administration	Allows users to access the <b>Administration</b> tab in the IQ Bot portal.  <b>Note:</b> You must assign this permission before assigning any other administration permissions.
View and manage settings	Allows users to manage the IQ Bot portal advanced configuration settings.
View and manage migration	Allows users to access the migration utility to import and export learning instances in the IQ Bot portal.



## IQ Bot domains permissions

Permission	Description
View domains	Allows users to view all domains in the IQ Bot portal.  <b>Note:</b> You must assign this permission before assigning any other domain permissions.
Create domains	Allows users to create domains in the IQ Bot portal.
Import domains	Allows users to import domains in the IQ Bot portal.
Export domains	Allows users to export domains in the IQ Bot portal.

## IQ Bot learning instance permissions

Permission	Description
View learning instances	Allows users to view their learning instances in the IQ Bot portal.  <b>Note:</b> You must assign this permission before assigning any other learning instance permission.
View learning instances from the same role	Allows users to view learning instances created by other users with the same role in the IQ Bot portal.
View ALL learning instances	Allows users to view all learning instances in the IQ Bot portal.
Launch validator	Allows users to access the IQ Bot Validator to review and update documents with exceptions.
Create learning instances	Allows users to create learning instances in the IQ Bot portal.
Edit learning instances	Allows users to edit learning instances in the IQ Bot portal.
Delete learning instances	Allows users to delete their learning instances in the IQ Bot portal.
Send learning instances to production	Allows users to send their learning instances to production in the IQ Bot portal.
Train learning instance groups	Allows users to train their learning instance groups in the IQ Bot portal.

## OAuth connections

Permission	Description
View connections	Allows users to view the configured OAuth connections and their respective attributes.
Manage connections	Allows users to create, edit, and delete OAuth connections.

## Package manager

Permission	Description
View packages	Allows users to view packages.
Manage packages	Allows users to view and manage packages.

## Workload

Permission	Description
Schedule my bots to run	Allows a user to run a bot with queue
View and manage all activities from my folders	Allows users to pause, resume, and stop all the WLM automations on the bot folders which they have access to.
View and manage all activities	Allows users to pause, resume, and stop all the WLM automations.
Create queues	Allows users to create and manage their own queues.
Manage ALL queues	Allows users to manage all queues.
Export queues	Allows users to export queues.
Import queues	Allows users to import queues.

---

**Note:** A user with the `AAE_Queue Admin` role has all the workload permissions. In addition, the `AAE_Queue Admin` can manage all the queues in the Control Room. See [System roles](#) on page 1768.

---

## Update Bot wizard permissions

You can assign feature permissions to access and convert a bot from Internet Explorer to Microsoft Edge with IE by using the **Update Bot wizard**. These permissions can be assigned from the **Administration > Roles > Create or edit roles** page.

Permission	Description
View bot update	Allows a user to view the status and summary of each bot update instance when the bots are converted on the <b>Administration &gt; Update Bot wizard</b> page. However, the user cannot run the updates. To do that, a user needs the <b>Manage bot update</b> permission.
Manage bot update	Allows a user to run new bot updates by using the Update Bot wizard.
Allow a Bot Runner user to update bots	Allows Bot Runner users to send bot update status back to the Control Room so that it is visible in the Update Bot wizard report.  This permission is assigned by default to the user with the <b>AAE_Admin</b> role.

## Bot permissions for a role

Assign bot permissions when creating a role with the View my bots feature permission.

Permission	Description
Select all	Enables users to check in, check out, view, delete, run, and schedule bots.
Run/Schedule/ Run and Schedule	Enables users to run and schedule bots when the role has the <b>Run my bots</b> and <b>Schedule my bots to run</b> feature permissions.  <b>Note:</b> <ul style="list-style-type: none"> <li>This permission is limited to running bots when the role has only the <b>Run my bots</b> feature permission.</li> <li>This permission is limited to scheduling bots when the user has only the <b>Schedule my bots to run</b> feature permission.</li> </ul>
Check in	Enables users to check in bot files or folders to the public workspace from their private workspace. When this permission is selected, the <b>Clone</b> and <b>View content</b> permissions are automatically enabled. These permissions can only be disabled by an user with the <b>AAE_Admin</b> role .
Check out	Enables users to check out bot files or folders from the public workspace. It creates an editable copy of the bot in the private workspace. A bot can be checked out by one user at a time. When this permission is selected, the <b>Clone</b> and <b>View content</b> permissions are automatically enabled. These permissions cannot be disabled.  <b>Note:</b> To check out dependent folders and files, you must have the <b>Check out</b> permission on the dependency folders.

Permission	Description
View content	<p>Enables users to view the contents of a bot. This permission applies to both the public and private workspaces. To create a copy of the cloned bot or file in the private workspace, you must have the <b>View content</b> permission on the same folder in the public workspace.</p> <hr/> <p><b>Note:</b> You must have the <b>View content</b> permission enabled to export a bot and its dependencies.</p> <hr/>
Clone	<p>Enables users to create a read-only copy of the bot from the public workspace to their private workspace. A bot can be cloned by multiple users. The <b>Clone</b> permission must be assigned at the folder level for the bot in the public workspace. To clone a dependency folder, you must have the <b>Clone</b> permission on the dependency folder.</p> <hr/> <p><b>Note:</b></p> <ul style="list-style-type: none"> <li>• If you have cloned a bot and the corresponding public folder is deleted, then there will be no classifications on the cloned bot in your private workspace. Copy, view, or delete permissions will be available at the bot level.</li> <li>• You cannot move or rename a cloned bot in your private workspace. You must have the <b>View content</b> permission on the same folder in the public workspace to view the contents of your cloned bot in the private workspace.</li> </ul> <hr/>
Delete	<p>Enables users to remove files and their dependencies from the public workspace.</p>

#### Related tasks

[Create a role](#) on page 1748

As an administrator, you can configure roles with permissions to access features and perform operations such as create, edit, or delete a bot in the Control Room, and assign the role to a user.

## Create a Citizen Developer role

A Citizen Developer role enables the associated users to create and run bots on their registered devices.

Ensure that you are logged in to the as the administrator.

Although you can create a Citizen Developer role and assign additional custom bot permissions, ensure the role has all the feature permissions mentioned in this procedure.

1. Navigate to **Administration > Roles**.
2. Click **Create role**.
3. Enter the **Name**.
4. Optional: Enter a description.
5. Select the following feature permissions:
  - Event triggers

Select the **View and manage my event triggers** option to allow the user to view, run trigger-based automation, or delete event triggers.

---

**Note:** The **View and Manage my event triggers** option is specific to the Citizen Developer license and can fail if it is assigned to users with Bot Creator or other licenses. Adding trigger events from the private repository is not supported.

---

- Bots

Select the **View my bots** option and the following permissions:

- **Run my bots**
- **Import bots**
- **Cancel checkout**

- Devices

Select the following permissions:

- **Register device**
- **View and manage ALL device(s)**
- **Edit the device(s)**

6. Click **Next**.

7. Click **Create role**.

A Citizen Developer role is created in the Control Room. You can create a Citizen Developer user and assign this role to that user.

[Create a Citizen Developer user](#) on page 1745

## Create API key generation role

As an Administrator, you can create a custom role to generate an API key and assign that custom role to users. By default, the `Generate API-Key` parameter is not enabled for any of the System-created roles.

To create and assign a custom role to generate an API key:

1. Log in as an Administrator to the Automation 360 Control Room.
2. Navigate to: **Administration > Roles**.
3. Click **Create role**. For more information, see [Create a role](#) on page 1748.
4. Scroll down to the **API** section.
5. Select **Generate API-Key**.

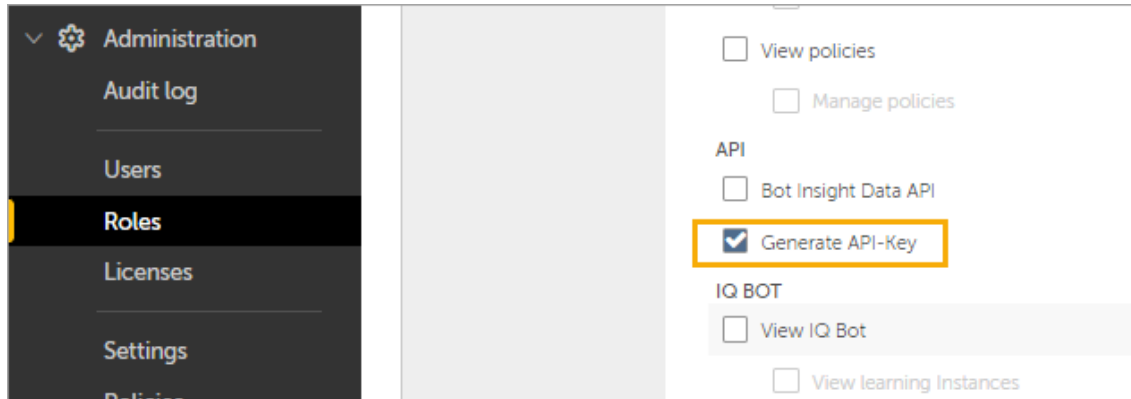

6. Enter a unique name in the **Role name** field.
7. Click **Create role**.
8. Navigate to: **Administration > Users**, and assign the custom role you just created to a non-Administration user.
9. Log in as the user you assigned the **Generate API-Key** role to.
10. Navigate to the username profile at the bottom left of the page and select **username > My settings**.
11. Click **Generate API-Key** at the top right of the page.

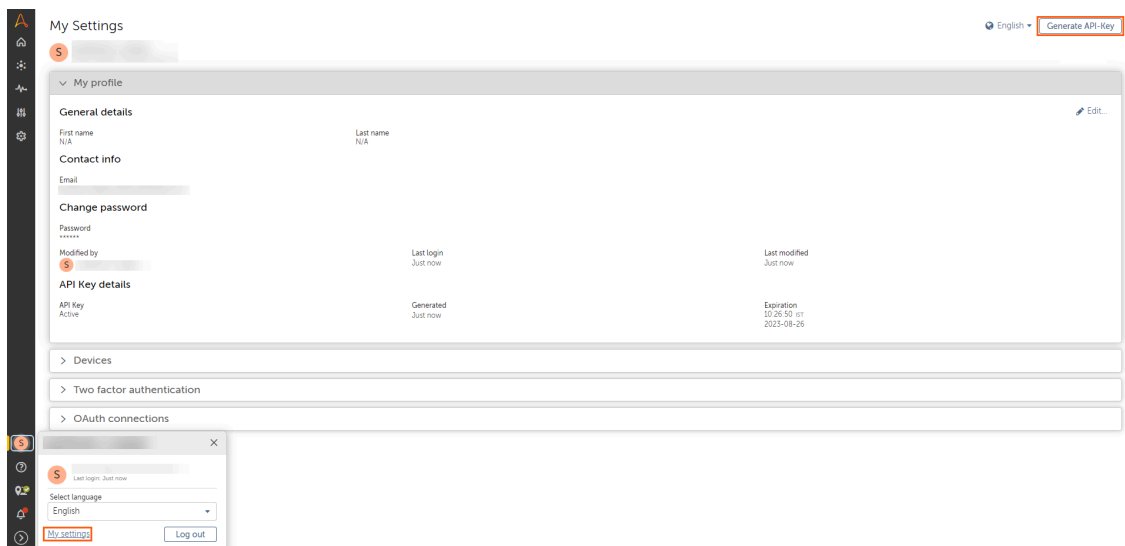

12. Copy the generated **API-Key** to your clipboard.

The API expiration field displays the date and time when the API key expires. Use this information to renew the API key so that you can run your automation seamlessly.

You can configure the validity of the API-key by setting the API-Key Duration. To set the API-Key duration,

- Navigate to: **Administration > Setting > Security Configuration** in your Control Room.
- Click **Edit**.

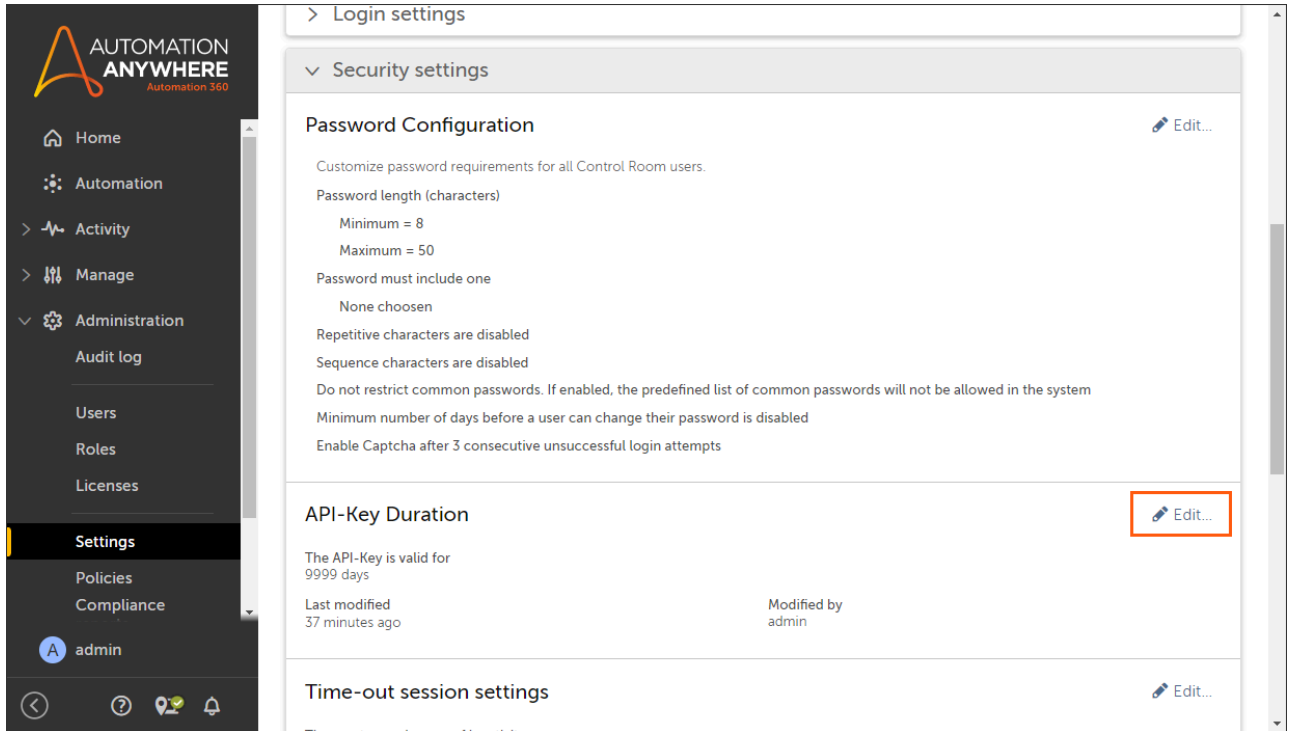

- Set the API-Key validity.

**Note:** You can set API-Key validity to a minimum of 1 minute or a maximum of 9999 days.

Use the **API-Key** to log in to a Control Room using SSO, or use the **API-Key** to log in as a user without a password.

## Assign a role

Roles grant specific permissions to users, such as Bot Creators and Bot Runners.

Ensure that you are logged in to the as the administrator.

Assign specific permissions to each user. You can only select active users.

1. Navigate to **Administration > Roles**.
2. Click **Create role**.
3. Enter the **Name**.
4. Optional: Enter a description.
5. Set the required permissions for the role associated with this repository.
6. Click **Bots**.
7. Select the desired repository folder and grant associating permissions.

Option	Action
Select all	Grant all associated permissions for the repository.
Run	Permission to run bots from the repository.

---

Option	Action
Check in	Permission to import bots to the repository.
Check out	Permission to export the bot from of the repository.
Delete from Public	Permission to permanently remove bots from the Public repository.

8. Optional: Click **RUN AS**.

This is where administrators select the specific device this role will have access to.

9. Click **Create role**.

Assign this role to the appropriate Bot Creator users.

## System roles

System roles are preconfigured with the permissions necessary to perform the tasks within the scope of that role. They cannot be modified or deleted. Administrators assign the roles to users to enable them to access features and perform operations in the Control Room.

---

**Note:** You can create your own roles as per your organizational requirements and use them instead of using system defined roles. You are no longer restricted to user system defines roles.

---



## Automation 360 roles

Role	Permissions	
<p><b>AAE_Admin</b></p> <p>This role allows access to all features, enables users to create other Admin users, and access to all folders and files in the public workspace, including permissions to Create/Edit/Delete Global Values. This is the only role that can access Control Room settings.</p>	Dashboard	View dashboards
	Activity	<ul style="list-style-type: none"> <li>• View my in-progress activity</li> <li>• Manage my in-progress activity</li> <li>• View in-progress activity from user's folder</li> <li>• Manage in-progress activity from user's folder</li> <li>• View everyone's in-progress activity</li> <li>• Manage everyone's in-progress activity</li> <li>• View my scheduled bots</li> <li>• Schedule my bots to run</li> <li>• Edit my scheduled activity</li> <li>• Delete my scheduled activity</li> <li>• View all scheduled activity from my folders</li> <li>• Manage all scheduled activity from my folders</li> <li>• View all scheduled activity</li> <li>• Manage all scheduled activity</li> <li>• Set automation priority to high</li> </ul>
	Event Triggers	<ul style="list-style-type: none"> <li>• View event triggers</li> <li>• Manage event triggers</li> <li>• View and manage my event triggers from private repository that are on local devices</li> </ul>
	Bots	<ul style="list-style-type: none"> <li>• View my bots</li> <li>• Run my bots</li> <li>• Download exported</li> </ul>

## IQ Bot roles

Role	Permissions	
<p><b>AAE_IQ Bot Validator</b></p> <p>For a Bot Runner with an IQ Bot license. Permissions to access the IQ Bot Validator screen. Limited access to Control Room features.</p>	<p>Credentials</p> <p>Code Analysis Policy Enforcement</p> <p>Administration</p> <p>IQ Bot</p>	<p>Create standard attributes for a credential</p> <p>Enable enforcement for bot check-in</p> <p>View Users and Roles basic information</p> <ul style="list-style-type: none"> <li>View IQ Bot</li> <li>View learning Instances</li> <li>Launch validator</li> </ul>
<p><b>AAE_IQ Bot Services</b></p> <p>Permissions to access the IQ Bot console. Limited access to Control Room features.</p>	<p>Activity</p> <p>Credentials</p> <p>Code Analysis Policy Enforcement</p> <p>Administration</p> <p>IQ Bot</p>	<p>Set automation priority to high</p> <p>Create standard attributes for a credential</p> <p>Enable enforcement for bot check-in</p> <p>View Users and Roles basic information</p> <ul style="list-style-type: none"> <li>View IQ Bot</li> <li>View learning Instances</li> <li>View all learning instances</li> <li>Launch validator</li> <li>Create learning instances</li> <li>Edit learning instances</li> <li>Delete learning instances</li> <li>Send learning instances to production</li> <li>Train learning instance groups</li> <li>Connect Learning Instance</li> </ul>
<p><b>AAE_IQ Bot Admin</b></p> <p>Allows access to all IQ Bot features.</p>	<p>Activity</p>	<p>Set automation priority to high</p>

## Bot Insight roles

See [Roles to access Bot Insight](#) on page 3927.

## Discovery Bot roles

Role	Permissions	
<p><b>AAE_Discovery Bot Admin</b></p> <p>Allows access to view all Discovery Bot processes. Manages the creation, deletion, and editing of processes.</p>	<p>Code Analysis Policy Enforcement</p> <p>Administration</p> <p>Discovery Bot</p>	<p>Enable enforcement for bot check-in</p> <ul style="list-style-type: none"> <li>View users</li> <li>View Users and Roles basic information</li> <li>View all processes</li> <li>Edit process</li> </ul>
<p><b>AAE_Discovery Bot Analyst</b></p> <p>Allows access to view and edit all approved recordings from assigned users for a given process. Permissions for system-generated aggregated view of recordings to view, create, edit, and delete views. Permissions to create, view, edit, and delete opportunities for assigned processes. Export the opportunity to a word document and convert to a bot.</p>	<p>Code Analysis Policy Enforcement</p> <p>Administration</p> <p>Discovery Bot</p>	<p>Enable enforcement for bot check-in</p> <p>View Users and Roles basic information</p> <ul style="list-style-type: none"> <li>View assigned processes</li> <li>View own aggregation</li> <li>Create or delete own aggregation</li> <li>Edit aggregation</li> <li>View system-generated aggregation</li> <li>View opportunity</li> <li>Create or delete opportunity</li> <li>Convert to bot</li> <li>Export opportunity</li> <li>View all recordings</li> <li>View all aggregation</li> </ul>
<p><b>AAE_Discovery Bot User</b></p> <p>Allows access to view the assigned Discovery Bot process assigned to a user. Create and run the Discovery Bot recorder for assigned business processes. Permissions to view, edit, and delete a user's own recordings.</p>	<p>Code Analysis Policy Enforcement</p> <p>Package Manager</p> <p>Devices</p> <p>Administration</p> <p>Discovery Bot</p>	<p>Enable enforcement for bot check-in</p> <p>View packages</p> <p>Register device</p> <p>View Users and Roles basic information</p> <ul style="list-style-type: none"> <li>View assigned processes</li> </ul>

- run recorder and create recording
- Edit own recording

### Automation Co-Pilot for Business Users roles

Role	Permissions	
<b>AAE_Robotic Interface Admin</b>	<p>Code Analysis Policy Enforcement</p> <p>Process Composer</p>	<p>Enable enforcement for bot check-in</p> <ul style="list-style-type: none"> <li>• View and Manage all processes</li> <li>• View all requests from public processes                             <ul style="list-style-type: none"> <li>• View all requests from public and private processes</li> </ul> </li> <li>• Delete my requests                             <ul style="list-style-type: none"> <li>• Delete my group requests</li> <li>• Delete all requests</li> </ul> </li> <li>• View all tasks from public processes                             <ul style="list-style-type: none"> <li>• View all tasks from public and private processes</li> </ul> </li> <li>• Reassign my group tasks                             <ul style="list-style-type: none"> <li>• Reassign all tasks</li> </ul> </li> </ul>
<b>AAE_Robotic Interface Manager</b>	Code Analysis Policy	Enable enforcement

- Edit users
- View Users and

## Export roles

You can export assigned users and **Run as user** roles to a CSV file to view folder permissions, and included in offline audits and records.

Ensure that you are logged in to the as the administrator.

You can export selected roles and their permissions to separate CSV files to view the following information:

- Role to user: Provides information about the users assigned to the role.
- Role to run-as user: Provides information about the run-as users assigned to the role.
- Role to permission: Provides information about the permissions assigned to the role.
- Role to folder permission: Provides information about the folder permissions assigned to the role.

You can download the CSV file with the exported roles from the **Activity > Historical** page.

1. Navigate to **Administration > Roles**.
2. Select the assigned users and **Run as user** roles that you want to export.
3. Click the **Export checked items to CSV** icon at the top-right corner of the table.  
A message is displayed indicating that the exported CSV file is available from the **Activity > Historical** page.
4. Click **Continue**.
5. Navigate to the **Activity > Historical** page and search for exported roles activity.

---

**Note:** You can search for role activity by username. The role activity name uses the following format: Role-Export: Roles\_admin\_03122022155910111.

---

6. Click the role activity that you want to download.
7. Click **Download exported zip file**.  
The CSV file downloads to your local system as a zip file.

## Manage Active Directory role mapping

An administrator or a user with permission to view and manage roles can view the details of the available Active Directory role mappings.

Ensure that you are logged in to the as the administrator.

By default, the Control Room will retrieve all security groups from the Users directory.

To create role mappings with filters for the Users directory along with other organizational units (OU), you must update the `um.properties` file. In the Control Room, the Users directory is considered similar to the OUs. Therefore, you must define the filter in the `um.properties` file.

For example, set the filter in the file as follows:

```
um.ldap.groupmapping.domain.filter='mydomain.com:OU1&groupFilter|
OU2&groupFilter|Users&groupFilter'
```

---

**Note:** Group filters such as `groupFilter` are optional.

---

In this example, by applying this change to the `um.properties` directs the Control Room to perform the following tasks:

1. Go to domain `mydomain.com`
2. Retrieve all security groups from Organization Unit OU1 that have the group name starts with `groupFilter`.
3. Retrieve all security groups from Organization Unit OU2 that have the group name starts with `groupFilter`.
4. Retrieve all security groups from Users directory that have the group name starts with `groupFilter`.

This setting ensures that the users from the organization units OU1 and OU2 will be retrieved in addition to the `Users` directory.

---

**Recommendation:** Use filters to narrow down the group display as displaying larger number of groups impacts the performance and makes troubleshooting difficult.

---

The filters defined in the `um.properties` file are stored in the database. When you update to a newer version of the Control Room, the Control Room references the filters stored in the database because the default `um.properties` file that comes with the installation will not contain these filters. If you define new filters in the default `um.properties` file, the Control Room references the filters defined in the `um.properties` file and overwrites the ones stored in the database.

#### Multiple Domain Mapping

Mapping supports multiple domains separated by a coma.

```
um.ldap.groupmapping.domain.filter='mydomain.com:OU1&groupFilter|
OU2&groupFilter|Users&groupFilter,mydomain2.com:OU3|OU4'
```

In the example above, the Control Room will perform the additional processes:

1. Go to domain `mydomain2.com`
2. Retrieve all security groups from Organization Unit OU3.
3. Retrieve all security groups from Organization Unit OU4.

#### Retrieving security groups from nested OUs

Example for retrieving security groups from nested OUs.

In the following example organization, consider "Marketing" as the parent OU with additional nested OUs and security groups located in each of these nested OUs.

- Marketing
  - Group 1
  - Group 2
  - US\_OU
    - Group 3
    - California\_OU
      - Group 4
      - NoCal\_OU

- Group 5
- SoCaLOU
- Group 6

By adding the following entry, Control Room will retrieve all groups, group1, group2, group3, group4, group5 and group6 from Marketing and the nested OUs.

```
um.ldap.groupmapping.domain.filter='mydomain.com:Marketing'
```

---

**Note:** Providing nested OU in the entry is not supported.

---

#### Active Directory role mapping

Navigate to **Administration > > Roles > Active Directory role mappings** and the page displays any role mappings that are created in the Control Room. You can view or edit the role mappings. You can also create new role mappings or restart the role synchronization process between the Control Room and Active Directory.

When enabled, this synchronization process is triggered once a day (1440 minutes) by default. You can trigger synchronizations in any interval by changing the number of minutes. We recommend that you set the interval settings larger than the default.

---

#### Recommendations:

- You should set the interval settings larger than the default setting of 1440 minutes.
- The synchronization process mappings and users is process intensive. We recommend that you maintain a short list of groups and assign specific users to each of these groups on the Active Directory so that you can avoid any scalability issues.
- Do not use both **Import** and **Do not import** mappings in the same system because it may complicate use cases and make troubleshooting more difficult to correct any issues.
- If both **Import** and **Do not import** mappings are defined and a user is included in both mappings, then the **Import** mappings take precedence over the **Do not import** mappings.

Consider these examples:

- AD Mapping A = Role A – Group A – Import users from this group into Automation 360
- AD Mapping B = Role B – Group B – Do not import users from this group

Where user D is included in both Groups A and B within Active Directory.

User D will be created in Automation 360 and will be assigned Role A.

- AD Mapping A = Role A – Group A – Import users from this group into Automation 360
- AD Mapping B = Role B – Group B – Do not import users from this group
- AD Mapping C = Role C – Group C – Import users from this group into Automation 360

Where user D is included in Groups A, B, and C in Active Directory (AD).

User D will be created in Automation 360 and will be assigned to Role A and Role C.

---

#### Device license conflict

---



When there are multiple mappings with different device licenses and a user is mapped to all of the mappings, it becomes difficult to determine which device license will be assigned to the user because one device license is allowed per user. For this scenario, the Control Room supports a preferred ordered list that you can define in the `um.properties` file. The default configuration for device licenses in the `um.properties` file is:

```
um.ldap.groupmapping.device.license.preferable.order=Development:Runtime:AttendedRuntime
```

The mapping assignment will choose the default license based on the following order of availability:

1. Development
2. Runtime
3. AttendedRuntime
4. CitizenDeveloper

You can change the default device license by adding the preferred keyword as a new entry in the `um.properties` file.

The following table lists the keywords for the device licenses that you need to use for the preferable order list:

Keywords	License
Development	Bot Creator
Runtime	Unattended Bot Runner
AttendedRuntime	Attended Bot Runner
CitizenDeveloper	Citizen Developer

If a user is mapped to multiple mappings and the mappings have the same device license for different auto-login options (enable or disable), then the auto-login configuration will override the settings. As a result, we recommend that you keep the auto-login option consistent across all the mappings for the same device licenses.

One or more available role mappings that match your search criteria appear in the **Role Mapping** table.

---

**Note:** The role mappings page displays only the list of mappings and does not validate the mappings by default. Because the changes in security groups and roles are infrequent and take more time in case of slow network or higher number of mappings, the page displays only the list of mappings. To configure default validation on the role mappings page, in the `um.properties` file, add the following entry: `um.ldap.groupmapping.sync.on.get.mappings=true`. Validation of role mappings occurs when you sync the role mappings between the Active Directory and the Control Room.

---

You can run automations either on the device which is set as your bot running device or from a device pool for which you have consumer privileges ([Create a user](#)). When using Active Directory role mapping, if you want any mapped Active Directory user to be able to use more than one device, you must configure a device pool ([Create device pools](#)).

## Sync Active Directory role mapping

Manually or automatically synchronize (sync) role mappings between the Active Directory and Control Room.

### Automatically synchronize Active Directory role mapping

By default, synchronizing between Active Directory and Control Room occurs by default at the time interval of 1440 minutes (one day). The time interval for synchronization can be changed in the Active Directory role mappings main page.

---

**Note:** As this can be a time-consuming and an expensive operation, set the role synchronization time period to the default value of 1440 minutes (1 day).

---

### Manually run or restart synchronizing Active Directory role mapping

To run or restart automatic synchronizing between the Active Directory and Control Room, do this: From the Control Room go to the **Active Directory role mappings** page and click the **Sync roles from Active Directory** option.

This starts the synchronizing process immediately and continues to run it automatically based on the time interval set.

### Cancel automatic synchronizing Active Directory role mapping

To cancel automatic synchronizing between Active Directory and Control Room, do this: From the Control Room go to the **Active Directory role mappings** page and click the **Cancel Sync** option to turn off the periodic automatic sync.

### Events that require Active Directory role mapping sync

Sync the role mappings whenever these events occur:

- Changes to AD groups

If any group that is mapped is deleted from the AD, the mappings must be validated before they are deleted because the group is no longer available.

- Update to the license file

Updating the license file can change the available roles. Mappings must be synchronized before updating the roles.

---

**Note:** After a sync, the user must wait a few seconds for the updated changes to appear.

---

## Create Active Directory role mapping

When users are created, they automatically inherit the roles assigned to their Active Directory security groups. Create the mapping before synchronizing the user and roles during the user login or background process.

To complete the task, you must have **AAE\_Admin** role assigned to you. Ensure you are logged in to the Control Room as the administrator.

In order to create a role mapping, as the administrator will have to provide the following information:

- Unique mapping name.
- The targeted domain where the security groups will pulling the credentials from (see `um.properties` for details).

---

### Note:

In order to avoid to import a long list of users, a specific security group should be created on the AD side that has only the users who will access Control Room is recommended.

---

Map a single AD security group to one or more Control Room roles. Create any roles you want to use with the Active Directory security groups. You can also use the default roles available in the Control Room. .

---

**Note:** It is recommended that the `AAE_Admin` role not be used.

- 
1. Log in to the Control Room.
  2. Navigate to **Administration > Roles**.
  3. Click **Active Directory Role Mapping**.
  4. Click **Create Role Mapping**.
  5. Enter the **Name**.
  6. Click the **Active Directory domain** drop-down and select an available domain.
  7. Use the **Active Directory security group** field to search for a group.  
For example, if you have a group named `Certified Publishers`, search for `Certified`. All the groups that contain `Certified` in their name are listed in **GROUPS**.
  8. Choose whether **Import users** or **Do not import users**.

Option	Outcome
Import users	<p>All the users who are assigned for the selected security group will be created and assign the mapped roles and licenses in Control Room. If users already exist in Control Room, they will be updated with the latest roles and licenses from the mapping.</p> <p>If synchronization process is enabled and triggered, the existing Control Room users will have the updated roles and licenses from the mapping.</p> <p>If there are new users added to the security group on the Active Directory side, these users will be created in the Control Room.</p> <p>If there are users removed from the security group, these users will be deleted from Control Room.</p>
Do not import users	<p>After the role mapping is created; no user will be created in Control Room. How this mapping is being used in this deployment:</p> <ul style="list-style-type: none"> <li>• On the Create user configuration page, when you create a new user, the role(s) will automatically be assigned to the new user if any of the user security group maps to the existing role mapping.</li> <li>• If synchronization process is enabled and triggered, any existing Control Room users whose security group maps to any role mappings will get the role assignment updated.</li> </ul>

When you create multiple Active Directory (AD) role mappings for multiple security groups, the roles used in the mappings are combined for the users who belong to the security groups.

Consider the following example:

- AD Mapping 1 = Role Y – Group Y – User A, User B, User C
- AD Mapping 2 = Role Z – Group Z – User A, User D, User E

Where User A is part of both Groups Y and Z within Active Directory. User A will be created in Automation 360 and will be assigned Role Y and Role Z. If you delete AD Mapping 2, then Role Z will be removed for User A. However, User A will continue to use Role Y.

---

**Note:** After a mapping is created and switched from the **Import user** to **Do not import users** option, the previously assigned licenses are retained for the users.

---

9. Click the right arrow (→) to add your selection.
10. Select the required role from the list of **Available roles**.
11. Click the right arrow (→) to add your selection.

12. Select the device licenses to assign to the security group.

License mapping is only supported when the **Import users** options is selected.

---

**Note:** The **Do not import users** option does not support license assignment. Administrators will be required to map the licenses manually for users. If any of the licenses that are defined in the mappings became unavailable during the synchronization process (not enough license), licenses will not be assigned to the users. Therefore, ensure that there is enough licenses before creating the mappings.

---

You can run automations either on the device which is set as your bot running device or from a device pool for which you have consumer privileges ([Create a user](#)). When using Active Directory role mapping, if you want any mapped Active Directory user to be able to use more than one device, you must configure a device pool ([Create device pools](#)).

13. Click **Create Mappings**.

When the synchronization runs, all users with the assigned roles are updated.

## Edit Active Directory role mapping

As an Automation Anywhere Control Room administrator, edit the Active Directory security group mappings assigned to roles in the Control Room.

Ensure that you are logged in to the as the administrator.

Ensure that the mapping name is unique and cannot be duplicated. If you rename a map with an existing mapping name, an error message appears stating that the same name already exists. Changes to mapping name or roles are updated in the audit log.

1. Navigate to **Administration > Roles**.
2. Click **Active Directory Role Mapping**.
3. Hover over the **Actions** icon for the role and select **Edit role mapping**.
4. Supply any required changes for Role Mapping.

Edit the roles by either adding or removing roles from the **Available roles** list, except Bot Insight roles. If you assign Bot Insight roles, an error message appears stating that the role mapping cannot be updated as it contains unsupported roles.

---

**Note:** You cannot edit the rest of the fields. The process to update mappings and synchronize users starts at a previously defined interval or when you manually update the mappings.

---

5. Click **Save changes**.

When the LDAP sync runs, all users with the assigned roles are updated.

## Delete Active Directory role mapping

An administrator or a user with permission to view and manage role can delete role mappings listed in the Role Mapping table.

Ensure that you are logged in to the as the administrator.

1. Navigate to **Administration > Roles**.
2. Click **Active Directory Role Mapping**.

3. Hover over the **Actions** icon for the role and select **Delete role mapping**.
4. Click **Yes, delete**.

## Manage licenses

The Automation Anywhere Control Room provides an automated mechanism for tracking the use of licensed software across multiple Control Room instances and share these entitlements in real-time.

**Note:** Ensure that you add the static IP address (192.124.249.160) of the Cloud license server to the safe recipients or trusted list to allow your On-Premises Control Room to connect to the Cloud license server.

The Control Room is capable of connecting to the Cloud license server using your network proxy. For more information, see [Configure forward proxy settings](#) on page 1812.)

## All licenses

Automation Anywhere Control Room administrators can view and manage user license entitlements for your account. Navigate to **Administration > License** to view a summary of product licenses.

The following image displays licenses information for a Control Room:

Licenses ☑ Sync license from server   ☑ Install license from server...

License mode Purchased **1**      Last updated Jun 14, 2023 **2**      Control Room license expires Wed, 11 Mar 2026 23:59:59 UTC **3**

Products **4**

- Control Room
- Document Automation Platform
- Document Automation Classifier
- Bot Insight
- Discovery Bot
- Automation Anywhere Robotic Interface (AARI)

Licenses <b>5</b>	Total purchased	Used in this Control...	Used in other Contro...	Remaining licenses
<a href="#">Bot creator (Development)</a>	1,000	2	0	998
<a href="#">Bot runner (Run time with Task Bot)</a>	--	--	--	--
<a href="#">Unattended bot runner</a>	1,000	1	0	999
<a href="#">Attended bot runner</a>	1,000	0	0	1,000
<a href="#">Citizen developer</a>	1,000	0	0	1,000
<a href="#">Bot Insight</a>	--	--	--	--
<a href="#">Business Analytics</a>	1,000	0	0	1,000
<a href="#">Discovery Bot</a>	--	--	--	--
<a href="#">Process analyzer</a>	1,000	0	0	1,000
<a href="#">Process recorder</a>	1,000	0	0	1,000
<a href="#">Automation Anywhere Robotic Interface (AARI)</a>	--	--	--	--
<a href="#">AARI User</a>	1,000	0	0	1,000

The **Licenses** page provides the following information:

Field/option	Description
1	Indicates whether the Control Room license is a purchased or trial license.
2	Displays when the <b>Licenses</b> page was last updated.

Field/option	Description
3	Displays the license expiration date and time.
4	Indicates whether the license is available for the specified product.
5	<p>When a license type is available, the link to the license is activated and you can click the link to view the license details.</p> <p>Displays license details for:</p> <ul style="list-style-type: none"> <li>• Total available: Displays the total number of available licenses.</li> <li>• Used in this Control Room: Displays the total number of licenses used in the Control Room where you are viewing the license information.</li> <li>• Used in other Control Room: Displays the total number of licenses used in other Control Rooms.</li> <li>• Remaining licenses: Displays the number of unassigned licenses.</li> </ul>

## License Cloud services

To edit and or update the license settings, via the License Cloud service, **Click Edit license settings** and supply the necessary information on the **Edit** page.

For more information on this subject, see these resources:

- [Licenses and cloud services](#) on page 1404
- [Managing Cloud and file licenses](#) on page 1406
- [View and edit Cloud Control Room instances](#) on page 1421

## License summaries

The License Summary table details the status of all licenses deployed, or available to be deployed, across any active Control Room. The details displayed are from the point-of-view of the current Control Room to which you are logged into. This real-time access to license information from multiple deployments across the network enable a seamless integration for allocation of needed RPA resources as the need arises.

## Updating licenses from a server

To add licenses for users, select the desired method of accessing the license by clicking **Install license from server** or **Install license from file**.

## View license details

You can view license details for the various licenses assigned to users in one place.

When a license type is available, the license link becomes activated on the **Licenses** page and you can click the activated license link to open the **License details** page.

The following image shows license details for Control Room instances:

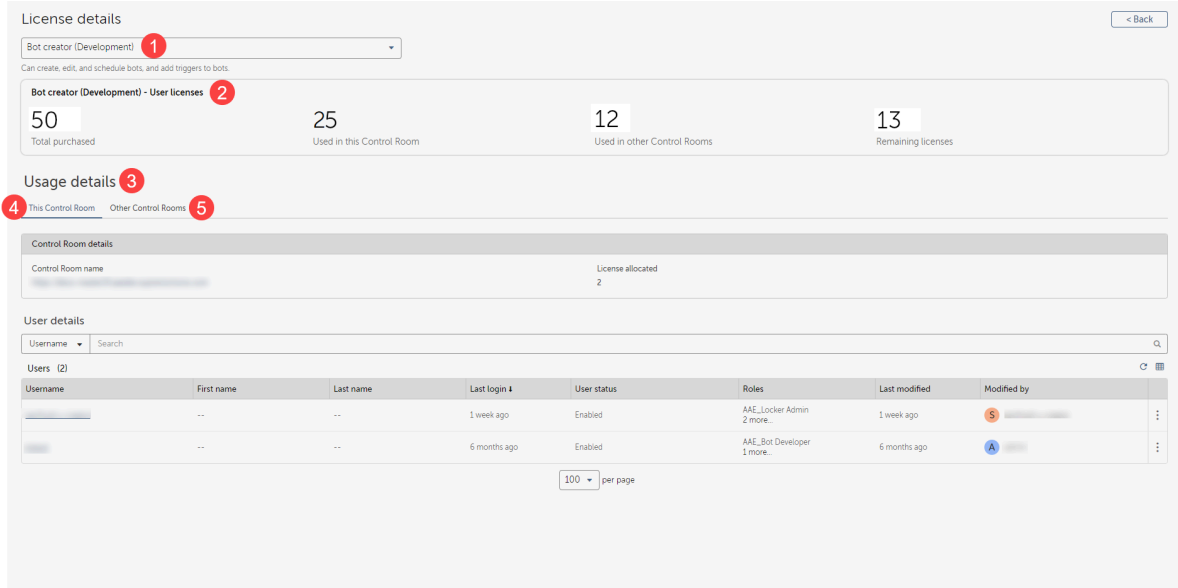

The **License details** page provides the following information:

Field/option	Description
1	Displays the selected license and its description. You can click the drop--down to select a different license to view the details.
2	Displays the following information: <ul style="list-style-type: none"> <li>• <b>User licenses:</b> Displays the license type.</li> <li>• <b>Total purchased:</b> Displays the total number of licenses purchased.</li> <li>• <b>Used in this Control Room:</b> Displays the total number of licenses used in this Control Room where you are viewing the license information.</li> <li>• <b>Used in other Control Rooms:</b> Displays the total number of licenses used in other Control Room instances.</li> <li>• <b>Remaining licenses:</b> Displays the number of remaining licenses.</li> </ul>
3	<b>Usage details:</b> Displays the license usage details by users in this Control Room and usage details for the license type across other Control Room instances.



Field/option	Description
4	<p><b>This Control Room:</b> Displays the Control Room name and the licenses allocated to the different users in this Control Room.</p> <p><b>Control Room details:</b> Displays the following information:</p> <ul style="list-style-type: none"> <li>• <b>Control Room name:</b> Displays the name of the Control Room where you are viewing the license information.</li> <li>• <b>Licenses allocated:</b> Displays the licenses used in the Control Room where you are viewing the license information.</li> </ul> <p><b>User details:</b> Displays the list of users using the license and their details. You can search for a specific user.</p> <p>The following information is displayed for the users:</p> <ul style="list-style-type: none"> <li>• <b>Username:</b> Displays the username.</li> <li>• <b>First name:</b> Displays the first name of the user.</li> <li>• <b>Last name:</b> Displays the last name of the user.</li> <li>• <b>Last login:</b> Displays when the user was last logged in.</li> <li>• <b>User status:</b> Displays if the user is enabled or disabled.</li> <li>• <b>Role:</b> Displays the roles assigned to the user.</li> <li>• <b>Last modified:</b> Displays when the user license was last modified.</li> <li>• <b>Modified by:</b> Displays the user who modified the user license.</li> </ul> <p>To view user details, click the menu button and click <b>View user</b> to view the user information.</p>

Field/option	Description
5	<p><b>Other Control Rooms:</b> Displays the other Control Room instances for the same account, and the number of licenses used in each Control Room instance.</p> <p><b>Other Control Rooms details:</b> Displays the Control Room instances and the licenses used in each Control Room instance. You can search for specific Control Room instances.</p> <ul style="list-style-type: none"> <li>• <b>Control Room names:</b> Displays the Control Room name. Click the name to view the Control Room.</li> <li>• <b>License allocated:</b> Displays the number of licenses used in the Control Room.</li> </ul>

## Installing additional licenses

Upload new licenses to the Automation Anywhere Control Room to be distributed to users as required.

Ensure that you are logged in to the as the administrator.

Designate the source of the license (server or filepath) to load into the Control Room. You may also take advantage of the License Cloud services from this page if enabled. Please see [Licenses and cloud services](#) on page 1404 for more information.

1. Navigate to **Administration > Licenses**.
2. Select **Install license from server** or **Install license from file** or **Edit license settings**.

Choose installation source.

Option	Action
<b>Install license from server</b>	<ol style="list-style-type: none"> <li>a) Supply the unique Control Room GUID.</li> <li>b) Click <b>Install license from server</b>.</li> </ol>
<b>Install license from file</b>	<ol style="list-style-type: none"> <li>a) Browse to and select the license.</li> <li>b) Click <b>Install license from file</b>.</li> </ol>
<b>Edit license settings</b>	<ol style="list-style-type: none"> <li>a) Enter you unique GUID in the filed provided.</li> </ol>

3. Click **Save changes**.

Related reference

[Users](#) on page 1737

As an administrator, you can create, view, edit, delete, and enable or disable a user. Creating users steps vary depending on whether the user is a non-Active Directory, Active Directory, or single sign-on (SSO) user from an IdP server.

[System roles](#) on page 1768

System roles are preconfigured with the permissions necessary to perform the tasks within the scope of that role. They cannot be modified or deleted. Administrators assign the roles to users to enable them to access features and perform operations in the Control Room.

[Settings](#) on page 1789

Use the **Settings** tab to configure the connection to the Credential Vault, enable email notifications, integrate the Control Room with a Git repository, enable secure recording mode, and configure user authentication.

## Create your users and assign their licensed roles

Create a user and assign their specific license based role.

Ensure that you are logged in to the as the administrator.

Create or otherwise edit the user information to assign the licensed role for accessing repositories, packages, and bot building tools and functionality.

1. Navigate to **Administration > Users**.
2. Click **Create user**.
3. Enter the required general details as follows:

Field	Value
Enable User	Select for the user to be activated and log in immediately.  <b>Note:</b> If this option is not selected, user will be in the inactive state and cannot log in.
Username	Enter a unique user name.
Description	Enter a description for the user.
First name	Enter the first name for the user.  <b>Note:</b> The number of characters allowed in the <b>First name</b> field is 50.
Last name	Enter the last name for the user.  <b>Note:</b> The number of characters allowed in the <b>Last name</b> field is 50.
Password	Enter and confirm a password for the user. Ensure that the password follows all the necessary password policies.

Field	Value
Email	Enter and confirm the email address for the user.  If SMTP is enabled, an email is sent to this address to confirm the account. All important Control Room notifications are sent to this email address.

4. Select the required role from the list of **Available roles**.
5. Click the right arrow (→) to add your selection.
6. Select **Allow** to allow multiple sessions.  
You must be Control Room administrator to set a user as a multi-login service user. It is possible to set a user as a multi-login user either in the UI or API, however a user may only access multiple sessions through the API.
7. Assign the device Bot Creator license to the user.  
The Bot Creator license enables user to create and run bots. Auto login is enabled by default.

**Note:** When you logged in as administrator, you cannot allocate any device license to the user and **None** option is selected by default.

License	Privilege
None	The user can access the Control Room only.
Bot Creator- Development license	Enables user to create and run bots. Auto login is enabled by default.
Unattended Bot Runner - Run-time license	Users with this license can perform all automation tasks that attended users can perform. Additionally, this license can also be used for Control Room deployment, centralized scheduling, and API-based deployment.
Attended Bot Runner - Run-time license	Users with this license can run bots on their devices and use any event trigger associated with their user account or role. However, these users cannot schedule bots.
Citizen Developer - Development license	Users with this license can create and run bots (including bots with triggers) on their devices.

The **Bypass legal disclaimer** option is automatically enabled to allow the user to run bots on a device without having to manually acknowledge a disclaimer.

After you select a device license, the **Device login credentials** are enabled. If you have the **Attest device credentials** permission, you can choose to attest the device credentials for this user to bypass credential validation when you deploy bots. The Bot Runner user should have an unlocked and active user session.

**Note:** This works only if the auto login setting **Reuse an existing session** is selected in the Control Room by the administrator.

## 8. Click **Create user**.

Update the Bot Creator packages and grant permissions to this user to build, test, and run bots. For more information, see

- [Automatic package updates for On-Premises Control Room](#) on page 1906
- [Automatic package updates for Cloud Control Room](#) on page 1907
- [Feature permissions for a role](#) on page 1749
- [Bot permissions for a role](#) on page 1763

## Settings

Use the **Settings** tab to configure the connection to the Credential Vault, enable email notifications, integrate the Control Room with a Git repository, enable secure recording mode, and configure user authentication.

### Bots

- Secure recording mode ensures that sensitive data is not stored in the bots. When secure recording mode is enabled, the bots do not capture values of certain properties or store application images. You can enable this setting for some or all users of the Control Room.

---

**Note:** Secure recording mode only applies to bots that are created or edited after the mode is enabled.

---

Click **Edit** in the **Bots** tab to enable or disable secure recording mode. See [Secure recording](#) on page 1042.

- Bot validation performs an additional compile time validation on migrated bots at the preprocessing stage to save your time and effort. By default, the Bot validation feature is set to **Off**.

---

**Note:** You must be a Control Room administrator to view and edit the validation option.

---

Navigate to **Administration > Settings > Bots** and set the bot validation option to **On** to detect compilation errors with bots.

Validation happens at the time of running the bot, for new bots. For migrated bots, this check is performed immediately after bot migration, per configuration.

For example, if a parent bot calls a child bot and the child bot has compilation errors, these errors are displayed when you try to run the parent bot. This ensures that an error does not occur in the middle of an automation or make it an incomplete automation.

In the Bot migration results page, select a bot that needs review. Click the three dots under **Reason** tab to see the details. With the Bot validation feature set to **On**, the bots that have compile time errors are displayed as a separate line entry in the migration report.

Migrated bots with compilation errors are shown in **Successful with Review** section of the migration report and ensures that you can get a list of bots that require your attention.

- Loop package enables you to run a sequence of actions repeatedly for a specific number of times or until a specific condition is met.

For bots that were created using the Loop action in Automation 360 v.26 or earlier releases, you can enable the **Legacy Loop behavior** option from the **Administration > Settings** to iterate the loop based on the specified value.

In the **Legacy Loop behavior** tab, click **Edit** to select one of the following options:

- 1. Enabled:** Loop is iterated based on the specified value. When you select this option and either increment or decrement the variable value in the end condition, loop iterations will not vary dynamically based on the new value generated.
- 2. Disabled:** Loop iterations will continue to vary dynamically based on the variable value generated in the end condition.

## Policies

Code Analysis: Enable the code analysis feature to run code analysis on your automations. This feature analyzes the code and displays a list of violations based on a set rules. You can review and fix any coding or stylistic errors for your automation.

[Code analysis](#) on page 2178| [Code analysis policy management](#) on page 2182

## Devices

When there is a new version of the Bot Agent, it is automatically updated.

## IQ Bot

View the website address where IQ Bot is currently installed, if applicable. Click **Edit** to update the IQ Bot URL.

## Document Automation Settings

Enable or disable external service connection for using generative AI capability in Document Automation Cloud instances based on region of deployment. Administrators can now enable the generative AI capability here, in the Control Room settings with a valid cloud license. When this setting is enabled, Professional Developers can create learning instances and process documents using Google Document AI, Google OCR, and Microsoft OpenAI services. Currently, you can select the region based on your region of deployment and choose between US and EU.

---

**Note:** This feature is available for Document Automation Cloud tenants only.

---

## Email

All users must confirm email accounts by clicking the confirmation link that they receive, set the password, and security questions before user can log in to the Automation Anywhere Control Room. By default, email notifications are disabled. Hover over the **Edit** icon to make changes.

[Edit email notifications](#) on page 1820

## Git integration

Remote Git repository must support Git LFS (Large File Support). Bots are synced using standard Git push over HTTPS.

## CoE Manager

Enable access to CoE Manager from the Control Room so that you can access CoE Manager from the quick links section on the Control Room home page.

[Enable CoE Manager](#) on page 2076

## Login settings

For security, privacy, or any other pertinent announcement, you can provide an additional statement, such as consent text, in the **Login settings** section. The statement is visible to users every time they log in to the Control Room.

This statement on the login page is disabled by default. If you enable it, you can also provide an option (using a check box) for users to read and accept the statement before logging in to the Control Room.

## Security settings

### Password Configuration

Administrators can configure password requirements for users to log in to the Control Room. This configuration prevents users from setting weak or most commonly used passwords that might prevent unauthorized access to the Control Room.

Password length (characters): Password length determines the strength of a password.

- **Minimum:** Set the minimum number of characters allowed for the password. By default, the minimum number of characters is set to eight and the number cannot be reduced further.
- **Maximum:** Set the maximum number of characters allowed for the password. By default, the maximum number of characters is set to 50 and cannot be set to more than 64 characters.

You can also enforce the users to include one of the following characters in the password:

- A number

- An alphanumeric letter
- A symbol
- A capital letter

---

**Note:**

- On-Premises users: The check-boxes for **Alphabetical character**, **Number**, **Capital letter**, and **Special character** are enabled, and the user can select or deselect the options.
- Cloud users: The check-boxes for **Alphabetical character**, **Number**, **Capital letter**, and **Special character** are disabled, and the user cannot select or deselect the options.

---

Repetitive Characters: Repetitive characters such as aaaa, bbbb, cccc, and so on in passwords make it easier for attackers to guess the password and are considered to be weak passwords.

- **Allow unlimited repetitive characters:** This option is set as default and allows users to use unlimited repetitive characters in their passwords. Selecting this option might allow users to set weak passwords and vulnerable to attacks.
- **Limit repetitive characters:** Select this option to restrict the users from using repetitive characters in their passwords. Set the repetitive characters limit in the **Maximum characters can be repeated** option. If you set this limit as one, then no characters in the password can be repeated. If you set this limit as two, users can use two repetitive characters in their passwords. For example, users can use aa, bb, and so on in their passwords.

Sequence Characters: Sequential characters such as qwerty, 123456, abc123, and so on in passwords make it easier for attackers to guess the password and are considered to be weak passwords.

- **Allow unlimited sequence characters:** This option is set as default and allows users to use unlimited sequential characters in their passwords. Selecting this option might allow users to set weak passwords and vulnerable to attacks.



- **Limit sequence characters:** Select this option to restrict the users from using sequential characters in their passwords. Set the sequential characters limit in the **Maximum characters can be used in sequence** option. If you set this limit as one, then no characters in the password can be used in a sequence. If you set this limit as two, users can use two sequential characters in their passwords. For example, users can use 12, ab, and so on in their passwords.

Restrict common passwords from the system: Allowing users to use common passwords such as 123456, qwerty123, 1q2w3e, and so on makes it easier for attackers to guess the passwords and are considered to be weak passwords.

- **Do not restrict common passwords:** This option is set as default and allows users to use commonly used passwords. Selecting this option might allow users to set weak passwords and vulnerable to attacks.
- **Restrict common passwords:** Select this option to restrict the commonly used passwords. Add the commonly used passwords on separate lines in the text box to avoid users using such passwords.

Set minimum number of days before a user can change their password: If you allow users to change their passwords anytime, they can continue to use the same password even if there is a restriction about not using the last few instances of their passwords. For example, if a user is prompted to change their password and restricted to not use any of their last three passwords, the user can change the password three times continuously and set their existing password the fourth time. Setting a minimum number of days before a user can change their password restricts the user from using the same password when they are prompted to change their password.

- **Disabled:** This option is set as default and allows users to change their passwords anytime. Selecting this option might allow users to use the same password and vulnerable to attacks.
- **Enabled:** Select this option to set the number of days users are restricted from

changing their passwords. The maximum number of days that you can set is 10. For example, if you set the days to five, a user can change their password again only after five days of changing their password.

Captcha and user lockout: This option prevents attackers from using scripts or bots to guess user credentials and locks the user account after certain unsuccessful login attempts.

- **Captcha on:** This option is set as default and prompts users to solve a captcha before logging into their account. Set the **Lock the user out after unsuccessful login attempts** option to lock the user after the set number of unsuccessful login attempts.
- **Lockout on:** Set the **Lock the user out after unsuccessful login attempts** option to lock the user after the set number of unsuccessful login attempts.

#### API-Key duration

The generated API-Key is used to authenticate users. You can customize how long the generated API-Key is valid to authenticate users until either:

- A selected duration is reached (in minutes or days), or
- A new API-Key is generated

---

**Note:** You determine the validity duration based on your organization's requirements. Maximum supported API-Key duration is 1 to 14,398,560 minutes, or 1 to 9,999 days.

---

#### Time-out session settings

You can enable time-out settings to automatically sign out users from the Control Room browser session after the specified minutes of inactivity. You can set the **Time-out session setting** field to one of the following values: 10 minutes, 20 minutes, 30 minutes, 40 minutes, 50 minutes, 1 hour, 2 hours, 4 hours, 8 hours, 12 hours, 24 hours, or 7 days. You can configure the session using increments of 10 minutes or 1 hour. The default value is 20 minutes, which means you will be logged out of the session after 20 minutes of inactivity.

#### File upload settings

As an Administrator, you can restrict the upload of executable files (dll files, media type application/x-msdownload) to prevent a security breach. To use this feature, enable

Two factor authentication (2FA)	the <b>File upload settings</b> in <b>Administration &gt; Settings &gt; Security settings</b> .
Historical activity retention	<p data-bbox="850 281 1414 499">Enable 2FA to provide an additional layer of defense against unauthorized users from accessing the Control Room. As an administrator, you can set up 2FA so that the users can validate their identity when logging in to the Control Room using both their user credentials and a second authentication factor.</p> <p data-bbox="850 520 1338 550"><a href="#">Two-factor authentication</a> on page 1809</p> <p data-bbox="850 590 1414 743">If you want to retain historical activities for only a limited period to save storage space or if you do not want to retain historical activities, configure your settings to automatically purge (delete) such activities.</p> <ul data-bbox="850 764 1414 1230" style="list-style-type: none"><li data-bbox="850 764 1414 917">• <b>Cloud:</b> By default, the historical activities are set to be deleted after 90 days. You can configure this value by setting a minimum value of 1 day to a maximum value of 90 days. This option is always enabled.</li><li data-bbox="850 926 1414 1230">• <b>On-Premises:</b> You can choose the following options:<ul data-bbox="889 1010 1414 1230" style="list-style-type: none"><li data-bbox="889 1010 1414 1066">• <b>Do not purge:</b> Historical activities are retained and never deleted.</li><li data-bbox="889 1075 1414 1230">• <b>Purge:</b> By default, the historical activities are set to be deleted after 365 days. You can configure this value by setting a minimum value of 1 day to a maximum value of 365 days.</li></ul></li></ul> <hr/> <p data-bbox="922 1266 1414 1388"><b>Note:</b> This feature is set to <b>Do not purge</b> when you update from a previous release to v.31 or later releases or when you directly set up v.31 or later releases.</p> <hr/>
Audit log retention	<p data-bbox="850 1486 1414 1640">If you want to retain audit log entries for only a limited period to save storage space or if you do not want to retain historical audit log entries, configure your settings to automatically purge (delete) such entries.</p> <ul data-bbox="850 1661 1414 1820" style="list-style-type: none"><li data-bbox="850 1661 1414 1717">• <b>Do not purge:</b> Audit log entries are retained and never deleted.</li><li data-bbox="850 1726 1414 1820">• <b>Purge older than 15 months:</b> Audit log entries that are older than 15 months are automatically deleted.</li></ul>

- If you are updating to v.30 release from a previous release, then you must manually enable the **Purge older than 15 months** option.
- If you are directly setting up v.30 or later releases, the **Purge older than 15 months** option is enabled by default.
- The audit log entries are deleted once a week from the time the **Purge older than 15 months** option is enabled.

See: [Audit log settings FAQ](#) on page 1857.

Bot promotion settings

Add the approved list of target URLs so that you can move bots and files between Control Room instances in a single flow, thus avoiding the multi-step export and import process.

[Move bots across environments](#) on page 2037

## Notification settings

Manage the notification settings for notification categories and channels. The notification settings defined by the Control Room administrator are applicable for all the Control Room users. Based on these defined settings, Control Room users will be notified about the events.

[Administer notifications for Control Room](#) on page 2205.

## User authentication

Configure the to authenticate users through the database option or switch to a SAML Identity Provider (IdP).

[Set up SAML authentication](#) on page 1390

## Network settings

Forward Proxy Configuration

Configure a forward proxy so that Control Room features can connect to Cloud-hosted Control Room services outside of customer's internal network.

[Configure forward proxy settings](#) on page 1812

## External key vault

[External key vaults](#) provide a way to securely store and retrieve credentials using a third-party key manager such as CyberArk, Azure, and AWS Secrets Manager.

Related tasks

[Set up SAML authentication](#) on page 1390

Switch user authentication for Control Room from Control Room database to SAML single sign-on (SSO).

[Edit email notifications](#) on page 1820

You can edit the email settings to select scenarios in which a Control Room sends email notifications.

## Manage device settings

Control Room administrator can configure the device settings to automatically set a user's default device when that user logs into Control Room.

Related tasks

[Configure screen resolution for a device session](#) on page 1801

For user devices, you can set the screen resolution of the Bot Runners for every bot deployment through the RDP in the Control Room.

[Configure temporary devices](#) on page 1803

Configure your device settings to automatically delete a temporary device when the device is disconnected from the Control Room after a certain time interval.

[Configure threshold settings for user devices](#) on page 1804

Configure the CPU utilization and device memory threshold values to control the concurrent bot deployment on user devices based on resource utilization.

[Configure auto-login settings](#) on page 1804

Configure auto-login settings in the Control Room to either create user sessions or reuse existing user sessions to reduce the bot startup time.

## Configure general settings

Configure the default device setting for temporary or non-persistent devices so that users of such devices users do not have to log in to the Control Room to mark their device as a temporary device.

1. Navigate to **Administration > Settings > Devices**.
2. Click **Edit** in the **General** tab.
3. To automatically set a logged-in user's device as the default device, verify that the **Enabled** option is selected.  
The option is selected by default. You can change it to **Disabled** if you do not want to set a logged-in user's device as the default device.
4. (Optional) While enabling users to switch Control Room
5. Click **Save changes**.

## Configure device registration

Control Room administrator can customize and configure the default device registration settings.

1. Navigate to **Administration > Settings > Devices**.
2. Click **Edit** in the **Device registration configuration**.
3. Use **Device type** to change the default setting:

- **Single user:** is the default setting and enables only a single user session on the device.

Use **Deployment type** to change the default setting:

- **Remote Desktop Protocol:** When you deploy a bot for an unattended Bot Runner from the Control Room, the Control Room handles the unattended Bot Runner session through Remote Desktop Protocol (RDP) setting and executes the bot.

---

**Note:** If your registered local device is a laptop or a desktop (local device) that does not support RDP, your bot execution will fail as local device does not support RDP. Additionally, this is applicable to the **Device type > Multiple users** since the multiple users are not supported on local devices.

---

- **Regular (Default):** For regular deployments, a Windows session is created using the existing resolution settings of the device. In this case, the screen resolution set in the Control Room is ignored.

- **Multiple users:** enables multiple users to concurrently log into a single device.

Enter the number of sessions in the **Concurrent sessions** field. The maximum number of allowed concurrent user sessions depends on your device license type and the hardware configuration. For example, if your device license permits 4 users, you can have up to 4 concurrent user sessions, and each session would require a minimum of 4 GB RAM for execution. If your system RAM is lower than this value, the bot execution might fail.

For information on Bot Agent device requirements, see [Bot Agent device requirements](#) on page 1340.

4. Use **Lifespan** to change the default setting:

- **Persistent:** is the default setting and the devices are created to support persistent virtual desktop infrastructure (VDI) and are not deleted after the device is disconnected from the Control Room.

---

**Note:** Non-persistent desktops are stateless desktops that get destroyed at the end of the session. Non-persistent VDIs do not exist when the user logs out.

---

- **Temporary:** devices are created to support non-persistent virtual desktop infrastructure (VDI) and are automatically deleted after a specified time when the device is disconnected from the Control Room. You can specify the time to automatically delete the temporary devices in the **Devices** settings of Control Room.

5. Optional: Select the **Use these settings while registering a device through registration wizard** check box.

If you enable this option, the device registration settings that you have configured are automatically applied during device registration. For example, if you have changed the device type from **Single user** to **Multiple users**, the device type will be set as **Multiple users** for all new device registrations.

6. Click **Save changes**.

## Configure browser extensions

You can customize the browser extension settings for user devices at the device level. Customizing the setting helps you to continue to use browser-based automations seamlessly even when there is an update to the browser extension.

- You must be a Control Room administrator to configure this setting.
- You must have installed Bot Agent version 21.222 or later.
- You must have installed the Bot Agent with installation type as system-wide.

By default, the Google Chrome and Microsoft Edge browser extensions are enabled on all Bot Agent devices. When this option is enabled, the browser extensions are automatically updated on all the connected devices through a single click.

1. In the Control Room, navigate to **Administration > Settings > Devices**.
2. In the **Browser extensions** settings, select **Edit** and then select one of the following options:
  - **Enabled**: Select this option to enable the Google Chrome or Microsoft Edge extensions on all the connected devices.
  - **Disabled**: Select this option to disable the automatic update of browser extensions. This option is applicable only when a Bot Agent is upgraded or a new Bot Agent is installed.
  - **Force disable Chrome and Edge extensions from all bot running devices**: Select this option when you want to manually upgrade the browser extension.

This option disables browser extensions on all the Bot Agent devices.

---

**Note:** These settings on the browser extension depends on the `ExtensionInstallForceList` group policy. None of these settings can be applied if the `ExtensionInstallForceList` group policy with Automation Anywhere extension is not available in the system.

---

**Note:** Selecting this option might disrupt the functioning of your browser-based automation.

---

Consider the following when configuring the browser extensions option:

- If the **Browser extensions** option is selected and you disable this option when the **Force disable extension on all bot running devices** option is unselected, then the `ExtensionInstallForceList` group policy is not applied on the devices that are newly registered or upgraded. You will have to enable the extension manually on the newly registered or upgraded devices.
- If the **Browser extensions** option is selected and you deselect it, with the **Force disable extension on all bot running devices** option selected, the `ExtensionInstallForceList` group policy is deleted from all the Bot Agent devices and you must manually update the browser extension.
- If the **Browser extensions** option is unselected and you select it, the group policy changes are pushed to all the Bot Agent devices.

---

**Note:** Automation Anywhere does not interfere with the `ExtensionInstallForceList` group policy if it is already present on the system, However, if a key by name **1** is already present in the `ExtensionInstallForceList` folder, create a key name with the

subsequent number, in this case, **2**. See [ExtensionInstallForcelist](#) for Google Chrome or [ExtensionInstallForcelist](#) for Microsoft Edge.

---

## Configure log collection

The log collection configuration enables you to collect log entries from the devices connected to the Control Room.

You can view the system log information on your device at the following locations:

- Bot Agent installed as admin user: `C:\ProgramData\AutomationAnywhere\BotRunner\Logs`
- Bot Agent installed as local user or non-admin user: `%userprofile%\AppData\Local\AutomationAnywhere\BotRunner\Logs`

The following logs are collected:

- Node manager logs
- Bot launcher logs
- Browser extension logs

---

**Note:** Starting from Automation 360 v.29 (Cloud), all the Bot Agent logs are retrieved and stored in the Amazon Simple Storage Service (Amazon S3) by default for all instances. This is only applicable to the Amazon Web Services (AWS). The Bot Agent logs are collected at a regular interval and might result in the slowness of Control Room.

Although a Control Room administrator can disable the log collection functionality, it is not available as part of the standard Automation 360 Cloud. Contact your Automation Anywhere Customer Success Manager (CSM) for assistance.

---

You can choose to collect one of the following log-level information:

---

**Note:** In the production (PROD) environment, we recommend that you set the log file configuration level to **INFO** for optimal performance.

---

- **Info (default):** Informational messages that highlight the progress of the application
- **Debug:** Fine-grained information that is useful for debugging an application
- **Trace:** Captures every behavior of the application in detail

1. Navigate to **Administration > Settings > Devices**.
2. Click **Edit** in the **Log collection configuration** tab.
3. To configure the level of log collection, select one of the following:
  - **Info** - to get informational messages that highlight the progress of the application.
  - **Debug** - to get detailed information that are useful for debugging an application
  - **Trace** - to capture the application behavior in detail.
4. Set the maximum log file size between 1 MB and 100 MB.



5. Set the maximum number of log files between 1 and 500.
6. Save the settings.

## Configure global cache settings

When automations are executed, various dependencies and configurations are downloaded from the Control Room and stored as global cache. Those entries in the global cache that have not been used in the last 30 days (default expiry time) are deleted.

Control Room administrator or a user with administrator role can change the default expiry period of the global cache.

---

**Note:** This feature requires the Enterprise Plus license. Contact your Automation Anywhere account representative for more information about this license.

---

1. Navigate to **Administration > Settings > Devices**.
2. Click **Edit** in the **Global cache expiry settings** tab.
3. From the **Use these settings to configure the expiry period** field, select one of the following options:
  - **Expire** - To change the default setting.  
Consider a scenario where you want to change the global cache expiry period to 60 days. Change the value in the **Deletes the cache in days specified below** field to 60.
  - **Never expire** - To cancel the periodic deletion of global cache.  
If you select this option, old or unused entries will be retained permanently and continue to occupy the storage space on the device.
4. Click **Save changes**.

## Configure screen resolution for a device session

For user devices, you can set the screen resolution of the Bot Runners for every bot deployment through the RDP in the Control Room.

This task is performed by the user who wants to build and deploy . You must have the necessary rights and permissions to complete this task, and authorization to log in to the as the licensed user.

The RDP session is created using the set screen resolution during bot deployment.

1. Navigate to **Administration > Settings > Devices**.
2. Edit the **Resolution settings for a device session** field.
3. Set the resolution by either selecting a predefined value from the **Screen resolution** drop-down list or by selecting **Custom** and entering the values you want.

Note that the screen resolution settings are applicable only when you use RDP-based deployments. For regular deployments, a Windows session is created using the existing resolution settings of the device. In this case, the screen resolution set in the Control Room is ignored.

---

**Note:** When resolution dependent packages are used to build bots, any screen resolution difference between the Bot Creator and Bot Runner device will impact the bots during

runtime. Therefore, ensure the resolution settings on devices match when you create and run bots. See [Screen resolution dependent packages](#) on page 1802.

4. Select one of the following options:

- **Enforce this screen resolution for existing device sessions**

To enforce the resolution settings at the device level.

**Note:** Option to enforce the screen resolution at a device or Control Room level only works for new device sessions and not on existing device sessions.

- **Do not allow devices to override resolution settings**

To ensure that the resolution settings cannot be changed at the device level.

5. Click **Save**.

## Screen resolution dependent packages

The screen resolution between the Bot Runner and Bot Creator device should be consistent as when resolution-dependent packages are used to build bots, any screen resolution difference between the Bot Creator and Bot Runner device will impact the bots during runtime.

Ensure the resolution settings on Bot Creator and Bot Runner devices match when you create and run bots. Review the table given below for information on the resolution-dependent packages and their attributes.

Package	Effects of display parameter changes	Resolution-dependent attributes
Image Recognition	<p>If we use the Image Recognition package in a computer that has a different resolution, scaling, or zooming than the resolution that was configured in the system, it can affect the output as it works on image pixel values and the features.</p> <p>For RDP machines, when you configure Image Recognition package in a different machine and run it on an RDP machine with same resolution and scaling, and if RDP is using a different display driver, the capture might not be accurate. It can render image with slightly different pixel values that can cause a reduction of matching percent.</p>	X, Y, width, and height

Package	Effects of display parameter changes	Resolution-dependent attributes
Mouse	The <b>Mouse &gt; Click</b> action requires X and Y co-ordinates to capture the UI element. If there is a change in screen resolution, scaling, or zooming, the coordinates might move, and it might click different coordinates. Due to this, the <b>Click</b> action will fail to capture the specific UI element. If you are using the RDP machine with the same resolution, scaling, or zooming then it will not create any issue as the Mouse package does not depend on the pixel value.	X, Y
App Integration	The <b>App Integration &gt; Capture area</b> action requires X and Y co-ordinates to capture the text from a window. Any change in screen resolution, scaling, or zooming might cause change in the coordinates, and the correct text is not captured. In the RDP machine, use same resolution, scaling, and zooming so that you do not encounter any issues.	X, Y, width, and height
Screen	The <b>Screen &gt; Capture area</b> action requires X and Y co-ordinates to capture the screenshot of the application window area. Use the same resolution and scaling in the RDP machine so that the output is not affected.	X, Y, width, and height
OCR	The <b>OCR &gt; Capture area</b> action uses the X and Y co-ordinates to extract text from a specified area in the selected window. Ensure you have the same resolution, scaling, and zooming in the RDP machine so that extraction of the text is not affected.	X, Y, width, and height

## Configure temporary devices

Configure your device settings to automatically delete a temporary device when the device is disconnected from the Control Room after a certain time interval.

Ensure that you are logged in to the as the administrator.

1. Navigate to **Administration > Settings > Devices**.
2. Edit the **Temporary devices - auto delete settings**.
3. Use plus (+) or minus (-) to select the number of **Days, Hours, or Minutes** to wait before the temporary device should be deleted automatically.

The default time is 24 hours.

You can also manually delete the temporary device from the **My devices** page in the Control Room.

4. Save the settings.

**Note:** Non-persistent desktops are stateless desktops that get destroyed at the end of the session. Non-persistent VDIs do not exist when the user logs out.

---

## Configure threshold settings for user devices

Configure the CPU utilization and device memory threshold values to control the concurrent bot deployment on user devices based on resource utilization.

Ensure that you are logged in to the [Control Room](#) as the administrator.

Based on the CPU utilization and device memory threshold values, you can determine whether to deploy bots on user devices. If the threshold value is the same or more than the value provided, bots are not deployed on user devices.

The default values for CPU utilization and device memory are based on the following parameters:

- When the frequency of data collection is 10 seconds, the system collects 6 data points in 1 minute.
- When time interval to upload data is 120 seconds, the system uploads 6 data points to the Control Room every 2 minutes.
- When the moving average time window is 2 minutes, the system uses the last 12 data points to calculate the average resource utilization.

1. Navigate to **Administration > Settings > Devices**.
2. Edit **Threshold settings for multi-user devices**.
3. Optimize the behavior for concurrent sessions by choosing one of the following options:
  - Do not enable threshold settings  
Use this option to deploy bots on single-user devices.
  - Enable threshold settings to set the maximum values:
    - a) Enter the CPU and memory utilization frequency of data collection.
    - b) Enter the time interval to upload data.
    - c) Enter the moving average time window.
    - d) Enter the CPU threshold limit for new bot deployments on a device.
    - e) Enter the memory threshold limit for new bot deployments on a device.

Use this option to deploy on multi-user devices.

You can either enter the values or click the plus (+) or minus (-) signs to increase or decrease the limit.

4. Save the settings.

## Configure auto-login settings

Configure auto-login settings in the Control Room to either create user sessions or reuse existing user sessions to reduce the bot startup time.

Ensure that you are logged in to the [Control Room](#) as the administrator.

Auto-login enables you to deploy a bot for unattended Bot Runners after automatically logging on to a machine and restoring the machine to its original locked/unlocked state after completing the deployment.

---

**Note:** The **Run as user** device credentials are used for Auto-login.

---

Configure auto-login settings to either create new user sessions or reuse existing sessions in the following scenarios:

- Before deploying a bot, some applications are kept running to accommodate a delay in the application launch.
- When Windows updates or Active Directory policy updates are pushed after a user logs in, changes in the automation environment might affect bot execution.
- Logging off from temporary or non-persistent devices stops bot execution.
- You can reuse existing user sessions when your company's IT policy prevents you from providing device user password for auto-login credentials.
- To bypass legal disclaimers on RDP-based deployments.

1. Navigate to **Administration > Settings > Devices**.

2. Edit the **Auto login settings**.

3. Optional: [External key vault setting](#).

4. Choose how to run bots on user sessions by selecting one of the following options:

- **Always create a new session**

Select this option for desktop deployments where it is possible to create user sessions on devices.

- **Reuse an existing session**

---

**Recommendation:** Select this option for auto-login settings in the Control Room to use event triggers on unattended Bot Runners and to run bots when a device is locked or is in a disconnected state (such as RDP).

---

Available options to lock or unlock the session are:

- An existing locked session
- An existing unlocked session
- A disconnected session
- Allow users to change these settings for each device

Use this option for deployments on devices where it is not possible to create user sessions.

---

**Note:** When you use the **Reuse an existing session** option, ensure user sessions are available. If there is no existing user session, triggers and bot deployments will fail.

---

- **Reuse an existing session, if available**

Use this option if you must create a new session or reuse an existing session. If a session does not exist, create a new session and leave it unlocked for next user session after bots complete their run from the following:

- A new session
- An existing locked session
- An existing unlocked session

- A disconnected session
5. To allow a user to change the auto-login settings at the device level, go to **Administration > Settings > Devices** and select **Allow changes** in the auto login section.  
The **Do not allow changes** option disables the user-level auto-login settings for user sessions.
  6. Save the settings.

Related reference

[Devices](#) on page 1873

The device is a machine through which a user connects to the Control Room to create or run bots. Manage devices that are registered to the Control Room through the **Devices** page located in the **Manage** tab.

## Configure advanced options

Configure the default settings for your device. For example, if you can change the default location of global cache as per your requirement.

A Control Room administrator can use any of the following optional instructions to change the default settings:

1. Navigate to **Administration > Settings > Devices**.
2. Click **Edit** in the **Advanced options** settings.
3. Click **Allow changes on the Edit device page** to change the default settings and enable users to make changes on the device page.
4. Enter a new filepath for global cache in the **Global Cache Location** field.  
This option is available in the Control Room for all devices but can be used only by devices that have the **All Users/System Level (Recommended)** option selected when installing the Bot Agent.

---

**Note:** If the specified path is not valid on the device, then the default path is used.

---

5. Use the following fields to enter custom values:
  - **Autologin timeout:** time duration within which a user can auto-login to the device.
  - **Bot launcher JVM options:** send dynamic properties supported for Java.  
For example, you can use this option to increase the memory of the bot launcher.
  - **Maximum simultaneous downloads:** set the number of simultaneous downloads.  
For example, 5 downloads including dependent files.
  - **Console readiness wait time:** set a wait time for the console to be displayed when you run a bot.
  - **Bot response wait time:** set a wait time for an active bot session.
  - **RDP command options:** provide different RDP-based commands.  
For example, ports-related commands.
6. Click **Save changes**.

## Switch device registration between Control Room instances

Configure the device settings in the Control Room to enable single-user devices to easily switch between different instances of the Control Room to run bots in multiple environments. This option enables you to register the Bot Agent on multiple Control Room instances without uninstalling the Bot Agent.

Ensure that you are logged in to the as the administrator.

- You must have the View and Manage ALL device permission to enable the switching option.
- You must enable the switching option on both Control Room instances.
- You can switch between Control Room instances only if the instances are on the same build.

For example, if one Control Room instance is on Build 9664 and another instance is on Build 8815, you cannot switch user device between the two Control Room instances. Both instances should be either on Build 9664 or Build 8815.

1. Navigate to **Administration > Settings > Devices**.
2. **Edit** the **General** settings.
3. Select **Enabled** to enable the local device as the default bot running device after a user logs into the Control Room.
4. Optional: Select the **Clear the user's existing bot running device if the bot agent is not present on the local device** checkbox to remove the existing default device.

By default, the **Clear the user's existing bot running device if the bot agent is not present on the local device** checkbox is not selected.

When no Bot Agent is available on the local device and if you select this checkbox, the existing default device for the logged-in Bot Creator, attended Bot Runner, or Citizen developer users is removed. Otherwise, the default available device is assigned for the bot deployment.

---

**Note:** If the local device is not enabled as the default bot running device and **Clear the user's existing bot running device if the bot agent is not present on the local device** checkbox is selected, then the existing default device is discarded. In this case, you must select the default device manually.

---

5. Select **Enabled** to enable a single-user device to be switched to another Control Room without reinstalling the Bot Agent.

Additionally, the **Allow fast switching** option allows you to switch the Bot Agent with a single click.

---

**Note:** Fast switching is recommended only if there is no change in the network configuration when connecting to a new Control Room. The first time you switch the Bot Agent to a new Control Room, the device lifespan information (that is, whether the device is **Persistent** or **Temporary**) is copied over to the new Control Room. No other configuration information is copied over.

---

If this setting is not enabled, you must uninstall Bot Agent first and then reinstall it to switch device registration to different Control Room instances.

6. Optional: For additional security, you can enable the following setting in the **Validate device credentials** field to validate the device credentials prior to bot deployment:

- **Device credentials for all users:** Validates the device credentials for Bot Creator, attended Bot Runner, Citizen Developer, and unattended Bot Runner users.
- **Device credentials for un-attended bot runner users only:** Validates the device credentials for unattended Bot Runner users only.

---

**Note:** This is applicable for all trigger-based bot deployments too.

---

7. Save the settings.
8. Log in as a Bot Creator user to a Control Room configured in a different environment to verify that users can switch between instances.  
The **Connect device** option is available when you click the device icon in the Control Room panel.

Related tasks

[Switch Bot Agent to a different Control Room](#) on page 1350

Switch the Bot Agent on a registered device to work with a different Control Room manually when you work on automations using different environments.

## Add access public IP addresses

Use this setting to limit user login access to the Control Room URL based on IP addresses or subnets that you specify in a list. You add IP address ranges using the Classless Inter-Domain Routing (CIDR) format, and you can add multiple CIDR ranges.

---

**Note:**

If a user attempts to log in to the Cloud Control Room using an IP address that is not included in the access list, an error message displays indicating invalid user or user credentials.

---

Ensure that you are logged in to the [Cloud Control Room](#) as the administrator.

You must have access to **Administration > Settings** page with view, add, or edit permissions.

Specify a list of IP addresses or IP subnets to permit access to the Cloud Control Room URL and API. If your network egress uses dynamic IP addresses, then the ranges you enter must include the entire range of dynamic IP addresses that can be assigned outbound traffic. For example, to specify a single IP address use, 11.10.10.12/32; or to specify an IP address range, use 192.169.20.0/24.

---

**Note:** When using SAML for authentication, use the network access capabilities of the Identify provider to restrict access to specific allowed IP addresses. Ensure all allowed IP addresses configured are removed before switching to SAML for authentication. For more information, see [A360 | Reset Network Access list](#).

---

Perform the following steps to add an IP address or subnet to the list of permitted network access addresses:

1. Log in to the [Cloud Control Room](#) as the administrator.
2. Navigate to **Administration > Settings > Network settings**.
3. Click **Edit** to add to or edit the listed IP addresses.



**Note:** There is a limit of 25 independent entries in the access permitted table. An entry can be a single IP address or an IP subnet.

4. Enter the IP address information:

Option	Description
Single IP address	Enter the necessary IP address in x.x.x.x format.
Range of IP addresses	Enter the address in x.x.x.x format and specify the subnet mask.

5. Enter the **Name**.
6. Optional: Enter a description.
7. Click **Save changes**.

Related reference

[Add IQ Bot cloud server IP addresses to allowed list](#) on page 1174

To ensure seamless connectivity of your IQ Bot cloud servers with the Cloud Control Room, specify a list or range of IP addresses that are allowed to access the Cloud Control Room URL.

[Add service URLs to trusted list for Cloud](#) on page 1170

For Cloud deployment, to ensure secure access to Automation 360 online services, add the service URL list to the safe recipients or trusted list.

[Add CoE Manager IP addresses to allowed list](#) on page 2076

Add the CoE Manager IP addresses to the allowed list to integrate with your On-Premises deployments.

## Set callback URLs

You can specify valid callback URLs, enabling the Control Room to post the results of the task execution only to defined and secure URLs for more granular security over the network.

Ensure that you are logged in to the as the administrator.

As a Control Room administrator, you can configure and audit specific, permitted URLs for more granular control of the network access points. Only the Callback URLs can be used in bot deployment APIs.

1. Navigate to **Administration > Settings > Network settings > Deployment settings > Callback URL**.
2. Click the **Edit** icon. 
3. Add the required URLs.  
Use the **Add** option for more URL fields.
4. Click **Save**.

## Two-factor authentication

Two-factor authentication (2FA) provides an additional layer of defense against unauthorized users from accessing the Control Room. As an administrator, you can set up 2FA so that the users can

validate their identity when logging in to the Control Room using both their user credentials and a second authentication factor.

## How 2FA works

2FA is an additional authentication mechanism added to your login process. 2FA is disabled by default. The Control Room administrator configures the 2FA for either all users or users with specific roles. Once 2FA is enabled, it is applicable to all Control Room users that it is intended for.

When you are assigned a role that requires 2FA, you must set up an authenticator application on your mobile or other device and establish a connection between the authenticator application and the Control Room. On subsequent logins, you will be prompted to enter, along with the username and password, a time-based one-time password (TOTP) from the authenticator application to complete the Control Room login.

**Note:** 2FA is not supported for Control Room setup using Active Directory (AD) or SSO. 2FA is supported only when the Control Room is the authentication provider.

## Components

Three main components are used in 2FA.

- Authenticator application: Installed on your mobile device, this application generates TOTP for verifying your identity. Any authenticator application that supports the TOTP protocol, such as DUO or Google Authenticator is supported.
- Registered device: This is the mobile or other device that you register with the Control Room during first login after 2FA is set up. The TOTP is generated through this registered device, which is required any time you log in to the Control Room. If your registered device is lost or unavailable, you must request the Control Room administrator to delete the device, and you can add another device later. Therefore, we recommend you to set up more than one device and register them with the Control Room.
- Time-based one-time password: This is a temporary password generated by an algorithm that uses the current time of the day as an authentication factor.

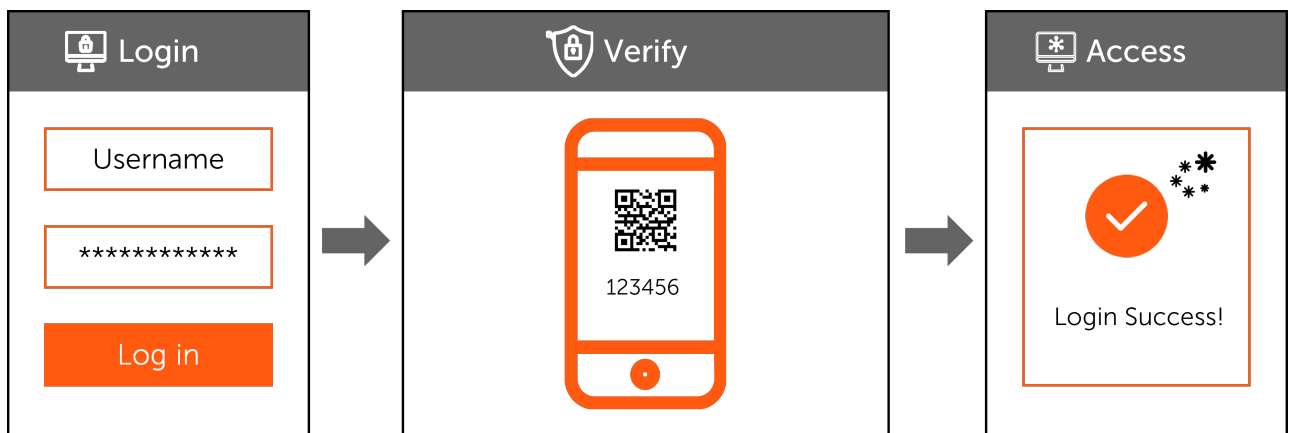

## Set up 2FA

1. Enable 2FA in the Control Room.
  - a) Log in to the Control Room as an administrator.
  - b) Navigate to **Administration > Settings > Security settings > Two factor authentication**.
  - c) Click **Edit** to configure the settings.
  - d) Select **Enable**. This is not enabled by default.
  - e) Choose the settings based on your requirements:

Option	Action
All users	Select this option to enable 2FA for all users who have access to the Control Room.
Selected roles	To enable 2FA for users with specific roles: <ol style="list-style-type: none"> <li>1. From the Available roles column, search and select roles for which you want to enable 2FA.</li> <li>2. Move these roles to the selected column.</li> </ol>

- f) Save your changes.
2. Optional: If a user's registered (mobile) device is unavailable or changed, delete the device and register a new one.
    - a) Log in to the Control Room as an administrator.
    - b) Navigate to **Administration > Users**.
    - c) Select the user that you want to edit. Hover over the action menu (vertical ellipsis) located to the right of the username and click **View user**.
    - d) In the **Authenticators** section, select the device that you want to delete, click the delete icon, and confirm deletion.
  3. Set up an authenticator application and establish a connection between the authenticator application and the Control Room.
    - a) Log in to the Control Room as a Citizen Developer or a Bot Creator (RPA Developer).  
Ensure that you have an authenticator application set up on your mobile device. During your first login, a QR code is displayed.
    - b) Either scan the QR code using your authenticator application or manually enter the code displayed in the authenticator application.

- c) Enter the name of your authenticator and the new code generated in your authenticator application.

This is a temporary code that is refreshed every few of minutes based on your authenticator application.

- d) Click **Confirm**.

Follow the next steps in the login flow, change your password and set the security questions. You will be successfully logged in to the Control Room. On subsequent logins, you must enter the code generated in your authenticator application and confirm.

4. Optional: You can manage (add or delete) your authenticator device.
- Log in to the Control Room as a Citizen Developer or a Bot Creator (RPA Developer).
  - On the **Home** page, click your username.
  - Navigate to **My settings** > **Two factor authentication**.
  - Click the plus (+) icon.
  - Perform steps 3.b on page 1811 through 3.d on page 1812.
  - Optional: Select the device that you want to delete, click the delete icon, and confirm deletion.

## Configure forward proxy settings

For On-Premises deployments that are using a proxy to connect to the internet, the forward proxy configuration feature enables Control Room features that require internet connectivity to function seamlessly.

In such deployments, Control Room features (such as license server, packages server, and audit log server) cannot easily connect to Cloud-hosted services for updates outside of their internal network. So configure forward proxy for such features so that the features can function seamlessly.

The following Control Room offered services and servers are supported to use the forward proxy hosts:

- License server
- OAuth services

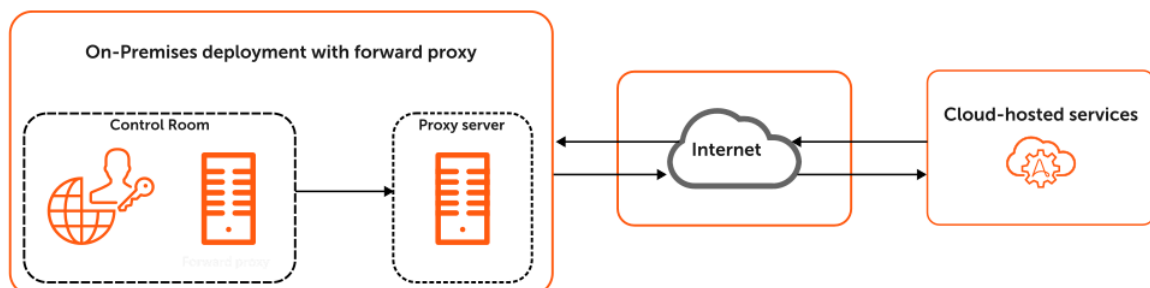

1. Log in to the Control Room as an administrator.

2. Navigate to **Settings > Network settings > Forward Proxy Configuration**.
3. Click **Edit** and then select **Enabled**.  
This feature is disabled by default.
4. From the **Type of connection/scheme** menu, select a connection.
5. In the **Host** field, enter the host IP address of the proxy host.
6. In the **Port** field, enter the port number of the proxy host.
7. Select an appropriate authentication type:
  - **None**: No authentication is used to connect to the proxy host.
  - **Basic Authentication**: Uses basic authentication to connect to the proxy host. Enter the **Username** and **Password** to connect to the proxy host.
8. **Ignore addresses**: Specify the IP addresses or host names (separated by comma) that need not use the proxy server to connect to the internet.

The following video shows how to configure forward proxy:

## Configure Credential Vault Connection mode

Credential Vault is a centralized location for securely storing credential information used by bots.

Configure the **Connection mode** to connect to the Credential Vault using a **Master key**.

---

**Note:** Provide this key every time you start or restart the Control Room.

---

To configure settings for Credential Vault, select **Express** or **Manual** mode.

Express mode

Auto connect to the Credential Vault with the **Master Key** that is stored in the system during Control Room configuration.

Manual mode

Use this to manually connect to the Credential Vault using the **Master Key** that was available during Control Room configuration.

When switching modes, provide the **Master Key** in the field and click **Save** for the changes to take effect.

---

**Tip:** Restart the server machine (on which the Control Room is installed) or services to allow changes to take effect.

---

All updates to the Credential Vault **Connection mode** are captured in the **Audit Log**.

- If you are facing Credential Vault connection issues while accessing the Control Room URL, see [CR fails to load with the Error Code 'cv.validation.secure.cv.locked' \(A-People login required\)](#).
- If the Credential Vault is configured to connect to the Control Room in **Manual** mode, and the **Master Key** is not added within a certain time period (for example, within 2 minutes), the devices might disconnect from the Control Room.

For more information, see [Bot agent device status remains disconnected post restart of Control Room server after windows maintenance \(A-People login required\)](#).

Related tasks

[Set up locker and assign credentials](#) on page 1863

Create a role, credentials, and locker to share related sensitive values with a group of users, so they can use those values to build or run bots.

## Manage domain

Administrators can use the **Display domain options** to hide a single domain or multiple domains, and use the **Select default domain** option to set any of the available (unhidden) domains as the default.

This applies to the visible domains on the Control Room login page, the **Create user** page, and the **Create an Active Directory role mappings** page. However, you can set the default domain on the **Create an Active Directory role mappings** page.

1. Navigate to **Administration > Settings > Active directory**.
2. Click **Edit** to edit the **Default domain**.
3. Select the default domain from the **Select default domain** drop-down list.

---

**Note:** If you did not set a default domain, then the first domain from the list is set as the default on the Control Room login page and the **Create user** page.

---

4. Click **Save changes**.
5. Click **Edit** to edit the **Allowed domains**.
6. Select the desired domains under the **Displayed domains** table and add it to the **Hidden domains** table.

---

**Note:** You cannot hide a domain for which users were added and mappings were created for the domain in the Control Room.

---

7. Click **Save changes**.

## Editing SQL user information

Edit Microsoft SQL configuration related settings, including username, password, database server name, database server IP, and port numbers.

To perform the task, you must have a administrator account with the required rights and permissions.

Download the latest Control Room utility and make certain this utility is installed on every server where Automation 360 is running.

---

**Note:** Stop all Automation 360 services on all nodes where a Control Room is installed before performing this task.

---

Users must make changes to the running configuration via the command-line interface.

1. Open the command line prompt and navigate to the Automation 360 application.

For example, C:\Program Files\Automation Anywhere\jdk11\bin.

2. Follow the prompts from the utility to select the SQL database and enter the required credentials.

---

**Note:** The password will not be displayed on the console.

---

3. Restart the Automation 360 services on the nodes.

The SQL user information is successfully updated.

## Syslog server integration

The Automation Anywhere Control Room supports ingesting tenants' audit log entries in Syslog format to any Syslog server.

---

**Important:** The options to specify or modify the Syslog configurations are available only for the On-Premises deployment.

---

By pushing syslog data to a Syslog server, you can integrate and leverage the advanced searching and reporting features of Syslog server solutions. When configured, the Control Room audit logs are forwarded to both the Transmission Control Protocol (TCP) and User Datagram Protocol (UDP) network protocols. You can use any syslog server. The following syslog servers are tested and certified by Automation Anywhere:

- Kiwi Syslog Server
- Splunk

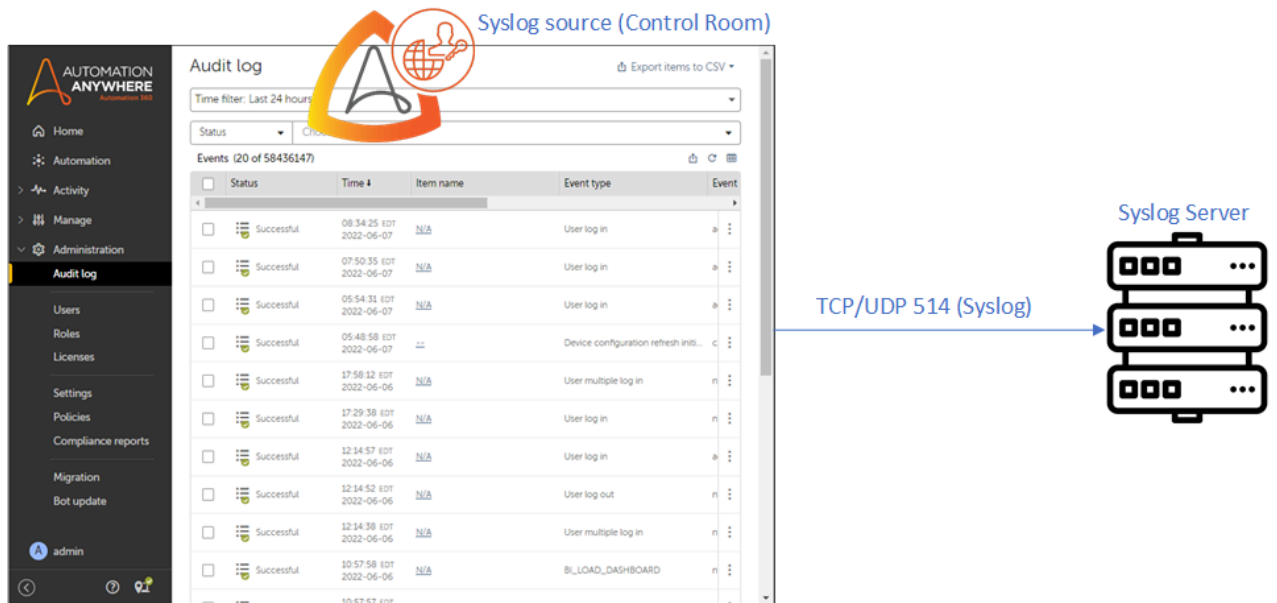

You can configure a Kiwi Syslog Server or a Splunk server that accepts data from a Control Room instance's syslog through a TCP or UDP port. The following example illustrates sending the Syslog data to Kiwi Syslog server through TCP or UDP ports.

## Configure Kiwi Syslog Server

Solarwinds Kiwi Syslog Server is a widely used commercial Syslog server. Kiwi Syslog Server Free Edition can monitor Syslog for up to five devices. Download Kiwi Syslog Server Free Edition from the following link: [Kiwi Syslog Server Free Edition](#). After installation, perform the following steps to configure the Kiwi Syslog Server:

1. Navigate to **File > Setup > Inputs**.
2. To forward the logs through UDP, click **UDP**.

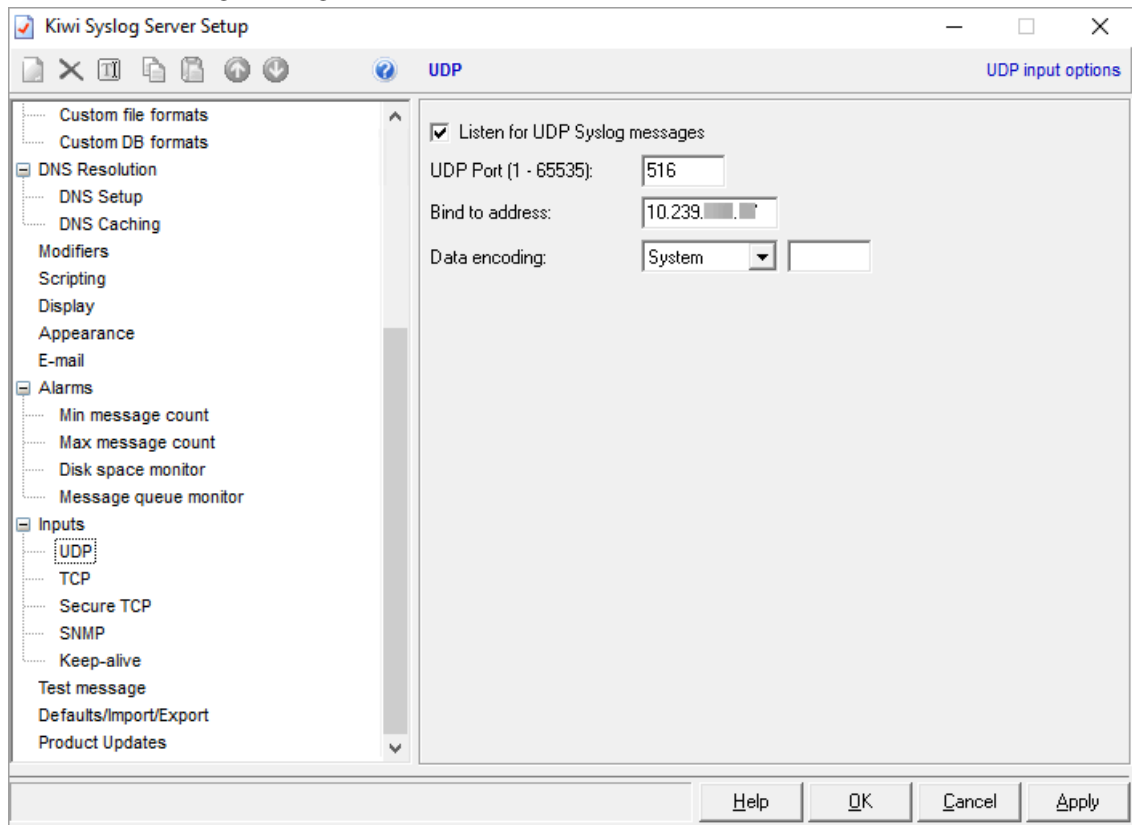

3. Enter the UDP port and the IP to which you want to forward the logs.
4. To forward the logs through TCP, click **TCP**.



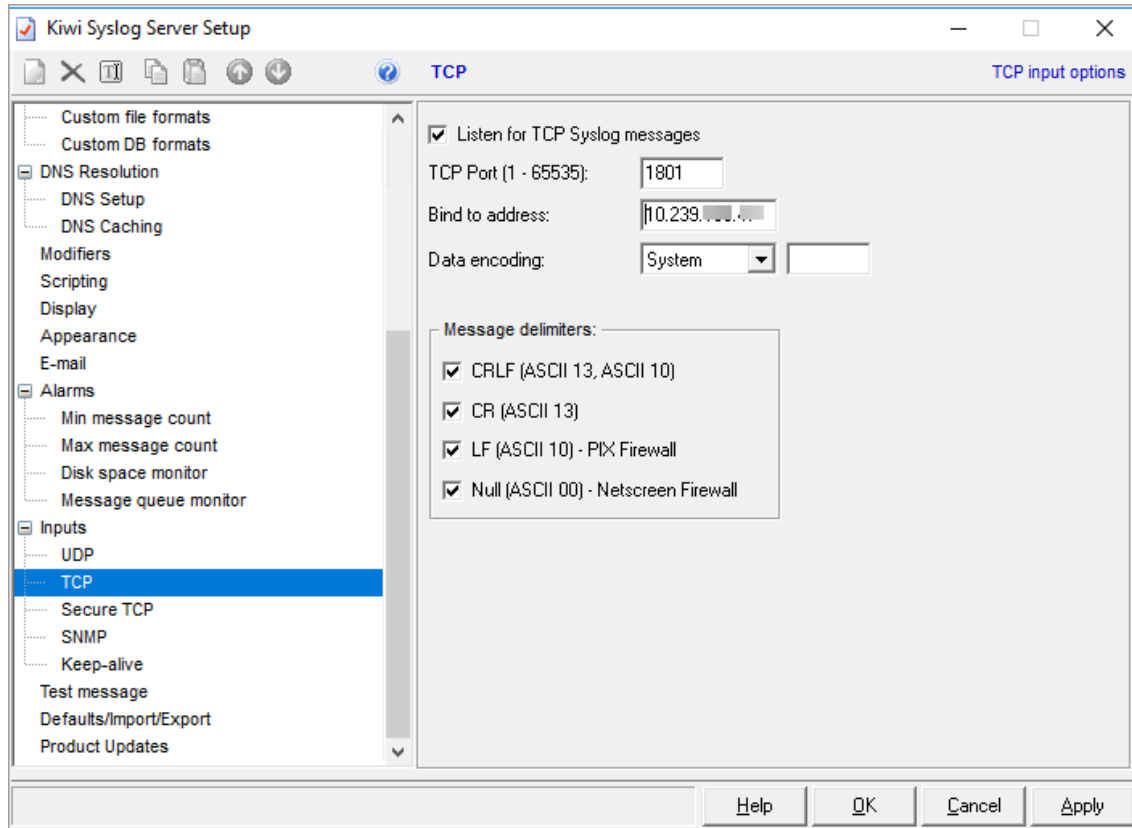

5. Enter the TCP port and the IP to which you want to forward the logs.

## Configure Control Room to send Syslog on UDP or TCP

To configure the Control Room to send Syslog on UDP or TCP, perform the following steps:

### Note:

To perform the task, you must have a administrator account with the required rights and permissions.

1. Navigate to **Administration > Settings > Network settings**.

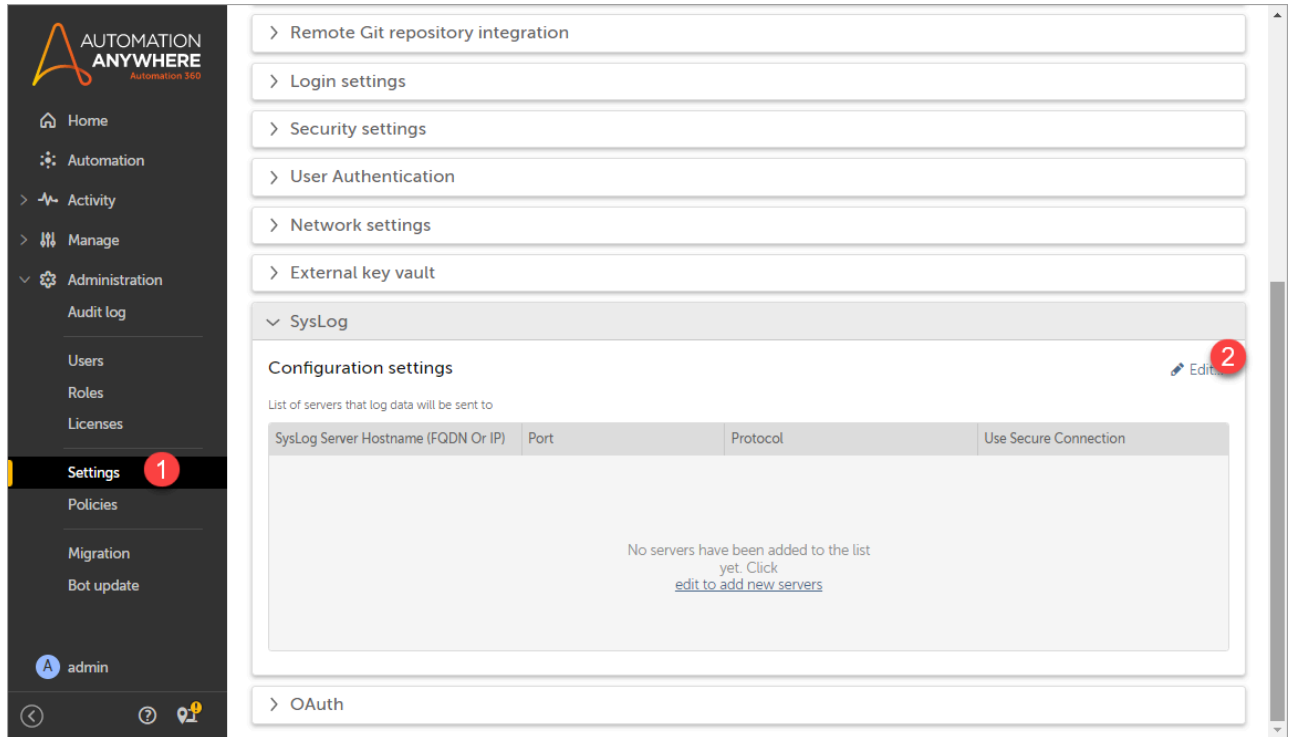

2. Click the **Edit** icon. 
3. To add more Syslog servers, click the plus (+) sign.
4. Enter the Syslog server information.

Option	Action
Syslog server hostname	Fully qualified domain name (FQDN) or the IP address of the Syslog server to deliver the log reports.
Port	Port that the remote Syslog server uses to receive incoming Syslog records (for example, port 514).
Protocol	TCP or UDP.
Use Secure Connection	Use a TLS encrypted channel to send Syslog records to the remote server. This option is available for TCP only.

- a) To forward the logs to a UDP port, enter the UDP settings (IP, port, and select UDP from **Protocol** drop-down).

---

**Note:** For information about specific settings, see the Kiwi Syslog Server documentation.

---

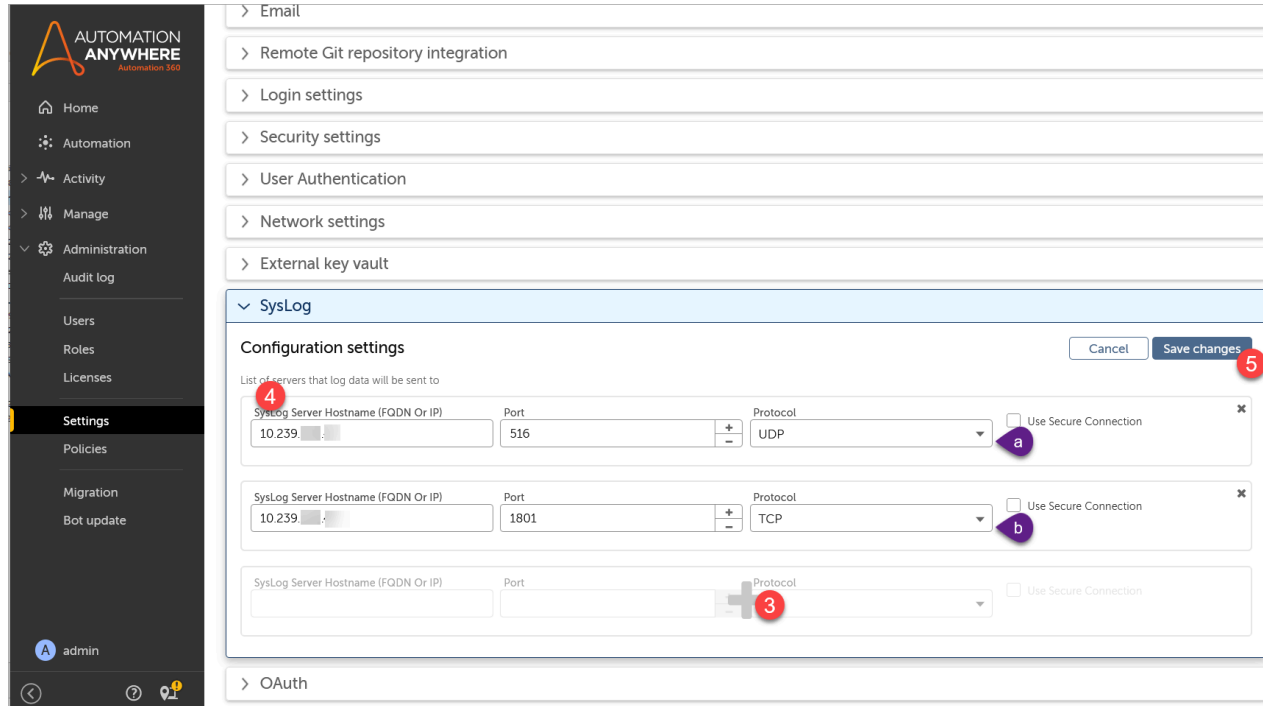

b) To forward the logs to an TCP port, enter the TCP settings (IP, port, and select TCP from **Protocol** drop-down) .

5. Click **Save changes**.

## Verifying data in the Syslog Server

Reception of logs is verified in the Syslog Server. Perform the following steps to verify the data in Syslog Server:

1. Generate a Syslog event by logging in or logging out of the Control Room.
2. Verify the logs in the Kiwi Syslog Server.

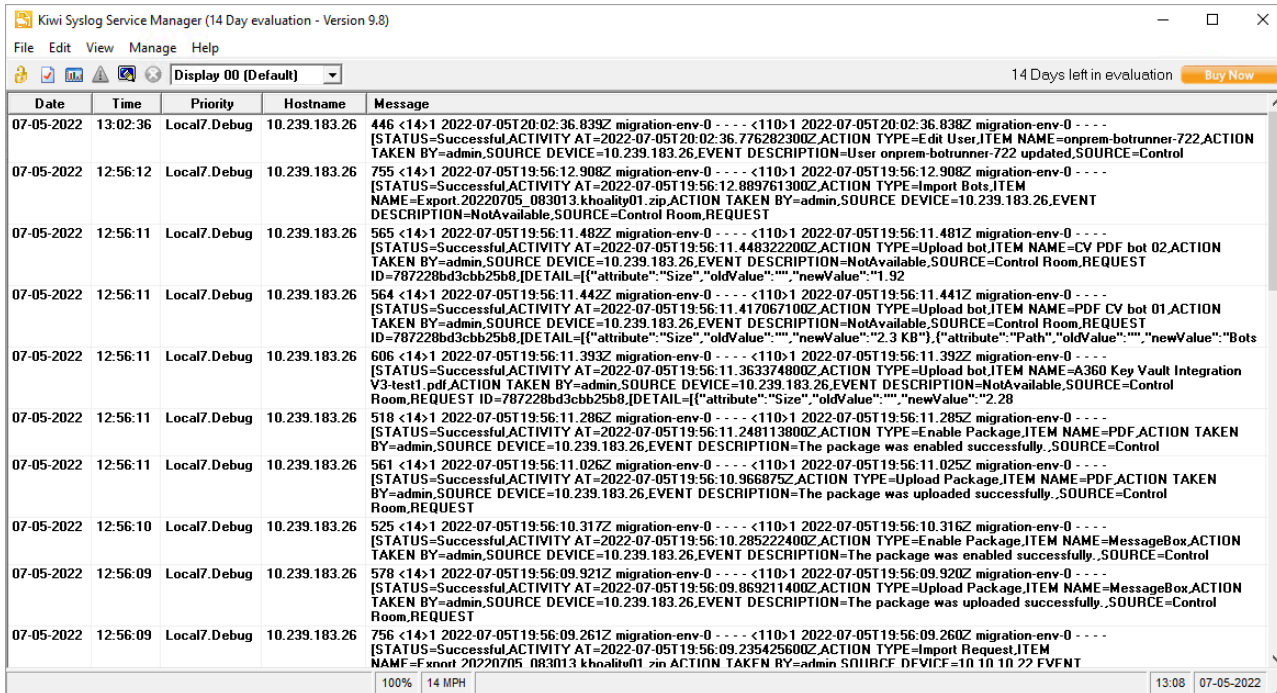

If you have configured Splunk as your Syslog server, then you will observe the syslog messages in the Splunk.

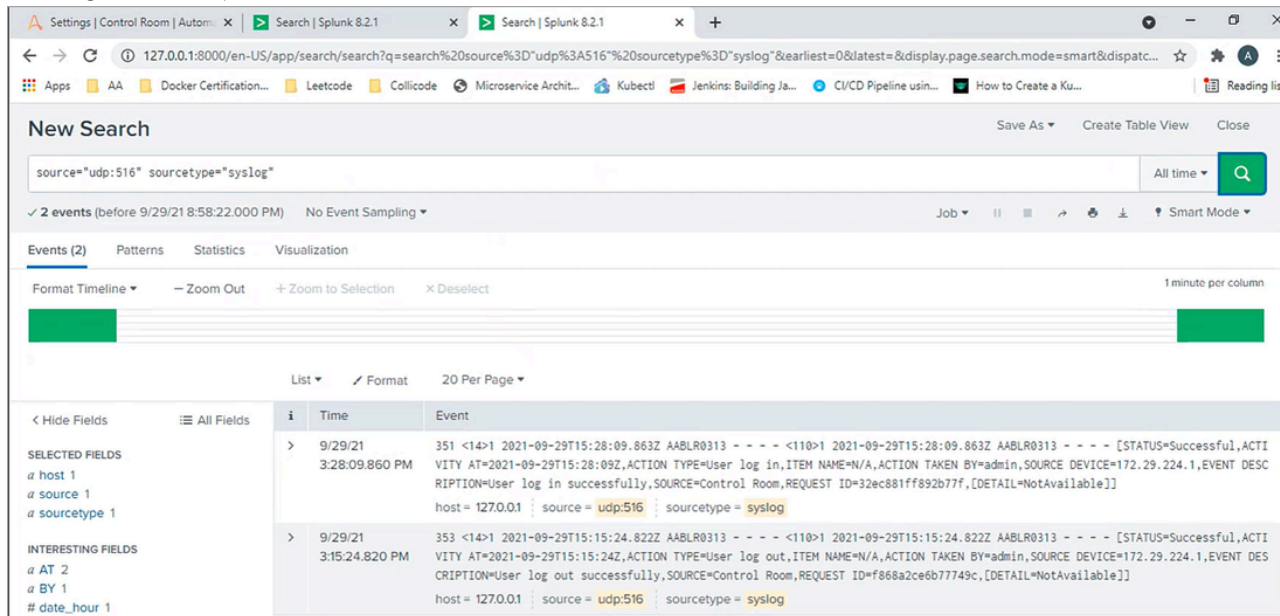

## Edit email notifications

You can edit the email settings to select scenarios in which a Control Room sends email notifications.

Ensure that you are logged in to the as the administrator.

Specify details about the email server you want to use and the events when the email notification must be sent. To configure **Email** settings, perform these steps:

1. Navigate to **Administration > Settings > Email**.

2. Click the **Edit** icon. 

3. Select **Send email notifications**.

By default, the email notifications are disabled. You might choose not to send a verification ("Welcome") to the created/edited users.

4. Specify the details of the server that you want to use to send email notifications.

Option	Description
<b>From this email address</b>	Enter the email address that you want to use to send email notifications.
<b>Email server host</b>	Specify the email server that you want to use to send email notifications.
<b>Email server port</b>	Specify the email port that you want to use to send email notifications.
<b>My server uses a secure connection (SSL/TLS)</b>	Select the option if the server uses a secured connection.
<b>My server requires authentication</b>	Select the option if the server requires credentials for access, such as for an external credential vault.
Specify the <b>Username</b> and <b>Password</b> that you want to use to access the server.	Specify the credentials.
<b>External Key Vault</b>	Specify the HashiCorp secret name to retrieve the credentials.

**Important:** The options to specify or modify the email server details are available only for the On-Premises deployment.

5. Select the required event for which you want to receive the email notification.

- **User initiates Forgot Password process from Login screen:** When a user clicks the **Forgot Password** option on the login screen
- **User information changes, to the user:** When a user's information is updated
- **A user is activated, deactivated or deleted, to the user:** When a user is enabled, disabled, or deleted
- **A Task Bot stops running because it is unsuccessful, to the user who started or scheduled it:** When a Task Bot execution is unsuccessful
- **A BLM package is exported or imported, to the user who performed BLM export or import:** When a BLM package is imported or exported
- **A checkin process fails :** When a check-in process fails
- **A schedule run is missed or automation doesn't run to schedule creator:** When a scheduled run fails to execute because of a Control Room shutdown
- **A compliance report has been generated to, the user who requested the report:** When a compliance report is generated

**Important:** If the **Require verification** option is not selected, an email notification without verification link is sent to the specified email ID. You can log in to the Control Room without verifying the email ID and setting the login credentials.

- Click **Save changes**.

## Version control in Automation 360

Version control helps you to manage the changes that you make to files that include Task Bots, documents, reports, scripts, executable files, and workflows. With version control, you can track and monitor changes to your bot logic.

With version control, you can identify the version of a bot that you want to modify and compare your recent changes against the changes made to the bot previously. As a Control Room admin, you can configure version control in the Control Room settings.

Automation 360 includes version control capabilities, and you can use these capabilities irrespective of whether you have integrated your Control Room with Git. Review the capabilities available in Automation 360 and Git.

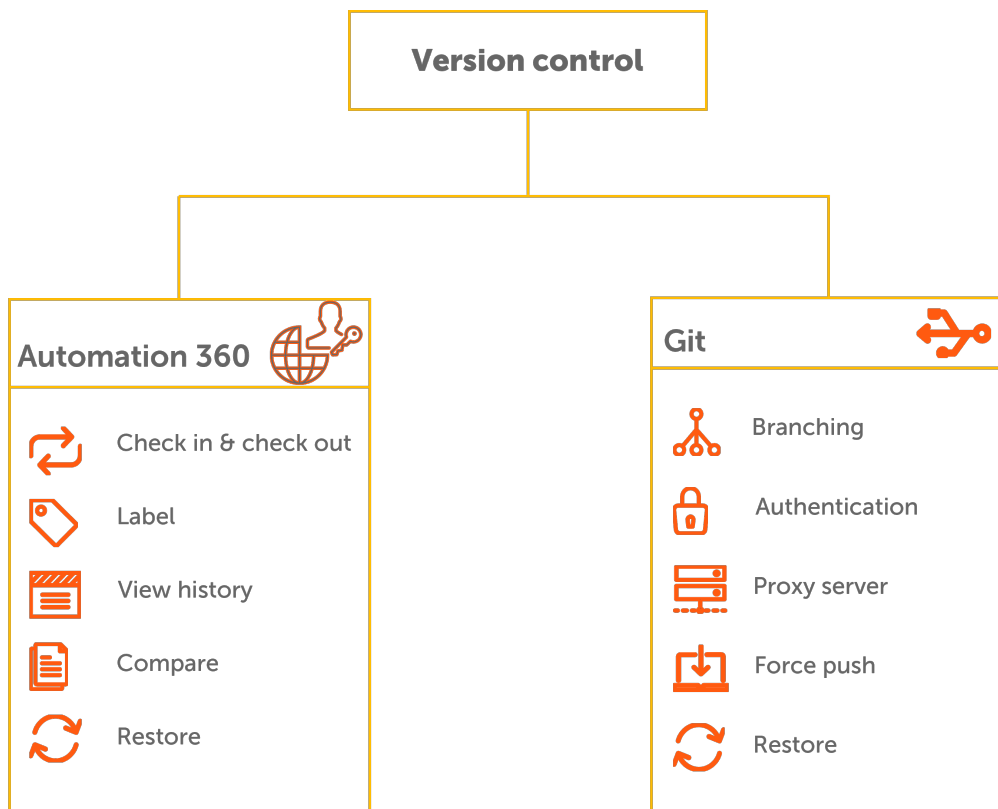

### Version control in Automation 360

- Check out and check in Task Bots: You can check out one version of a bot (version 1) from public to your private workspace, make changes to it, and then check in the bot to the public workspace. This creates a new version (version 2) of the bot, which is the latest version. Every

time you check out, make changes to, and check in a bot, a new version of the bot is created as the latest version.

---

**Note:** You can run either the latest version of a bot or the version that has the production label.

---

You can roll back to a particular version of a bot by selecting **Advanced options** in the check out action to select a specific version of the bot to check out. Also, you can select the dependencies to check out. By doing this, you can make changes to a specific version of a bot and its dependencies. When you check in this bot, it becomes the latest version. For example, if the latest version of a bot is version 8 and you want to roll back to version 3, you must first check out version 3 of the bot and then check it back in, which creates version 9. This latest version, which is identical to version 3, is now available in the public workspace for bot operations.

[Check in a bot](#) on page 2301 | [Check out a single bot](#) on page 2305

- Label Task Bot : You can also roll back to a specific version of a bot by assigning a label to that version of the bot. You can use this label to choose the version with which you want to perform certain bot operations. With the version of your choice, you can schedule, run, queue, export, and trigger bot development workflows.

[Assign label to a bot](#) on page 2312

- View Task Bot history: You can view the version history of your Task Bots in the public workspace. With **View history**, you can view the history of changes that have occurred in your Task Bots and identify the actions performed by a user. The list of all the versions of a bot is shown in reverse chronological order. The information displayed includes version number, check-in message, date and time of check-in, and the name of the user who checked in the version.

[View Task Bot version history](#) on page 2312

- Compare versions: You can compare any two versions of your Task Bots to view the differences between those two versions.

[Compare bot versions](#) on page 2313

- Restore bots from Git: Even if your Control Room is not integrated with Git, you can restore bots from Git to your public workspace. For example, if you have 50 bots in your public workspace and 75 bots in Git, you can restore the remaining 25 bots from Git to your public workspace.

---

**Note:** This restore option is available only for On-Premises deployments and not supported on Cloud deployments.

---

## Version control with Git

If your Control Room is integrated with Git, all the versions of the bots and files in Automation 360 are synced with Git, and you can use the following additional capabilities:

- Integrate with a Git branch.
- Integrate with Git through SSH authentication.
- Integrate with Git through a proxy server.
- Restore bots or files to an empty public repository from an existing Git configuration.
- Configure force push when connecting to Git.

[Integrating Control Room with Git repositories](#) on page 1824

## Integrating Control Room with Git repositories

Git integration with the Control Room ensures one-to-one mapping of the bots checked in to the public workspace of the Control Room and the remote Git file structure. Git commits enable you to enforce security, compliance, and code standards, and ensures that an organization's established best practices can be applied to their bot development processes.

The Control Room has Git Client that is connected to the Git repository that stores the file history of your public workspace. Each time a bot developer performs a bot check-in:

- The bot and the dependent files are checked in to the public workspace.
- The Control Room creates a commit that contains all the contents of the particular check-in within the Git repository.
- The comment entered in the check-in process is used as the Git commit message and the user details are recorded as the author of the Git commit.
- The Bot definitions are stored as JSON files in the Git repository.

---

**Note:** The Git repository must be configured to have write access only to the Control Room and not to any other Git client.

---

### Supported Git repositories

You can configure the Control Room to replicate the built-in Git repository with the remote Git host, and synchronize information using Git push. The following sources are certified for Git integration with the Control Room.

- GitHub
- BitBucket
- Azure DevOps

Exposing the files to your remote Git host enables you to review the bot code and files using third-party comparisons and static code analysis tools to help enforce compliance and maintain security standards.

### Configure a remote Git repository in Control Room

Configure a remote Git repository in the Control Room so that you can version all the bots and their dependencies and store them in the Git repository. In addition to the local Automation 360 repository in the Control Room, the remote Git provides a backup for the bots and their dependencies.

- In order to configure a remote Git repository in the Control Room, ensure that you have the `AAE_Admin` role.
- Based on your region, configure your network firewall to add outbound NAT gateway IP addresses to the allowed list.

[Control Room IP addresses for external integrations](#) on page 1829

When you are configuring a remote Git repository, keep the following considerations in mind:



- The Git repository must be configured to have write access only to the Control Room and not to any other Git client.
  - You cannot upload files greater than 100 MB to the Git repository.
  - Ensure that you integrate with an empty Git repository.
  - You should not check in any file manually into the Git repository from any other user, product, or application.
  - When you integrate with Git, the repository should not contain the `ReadMe.md` file.
  - Ensure your Git repository is private (internal). For security reasons, Automation 360 cannot connect to a public Git repository as all the bots and files are generally accessible in a public Git repository.
1. In the Control Room, navigate to **Administration > Settings > Remote Git repository integration**.
  2. Click **Edit**.
  3. Choose one of the following authentication methods and perform the corresponding steps to set up your Git configuration:

Authentication method	Steps
HTTPS Authentication	<p><b>a)</b> Enter the HTTPS repository path, including the username in the following format:</p> <pre>https://&lt;username&gt;@bitbucket.org/ companyname/product.git</pre> <hr/> <p><b>Note:</b> Use the Git host that you want to obtain the Git repository address.</p> <hr/> <p><b>b)</b> Enter the branch name.</p> <p>The changes are pushed to the branch selected. By default, the <b>master</b> branch is selected.</p> <p>You can use lower case characters for branch names, but they must not exceed 250 characters. Do not include ASCII control characters such as spaces, tildes, or colons in branch names. You can use hyphen to separate words. For more information on branch naming, see <a href="#">Create a new Git branch</a>.</p> <p><b>c)</b> Enter your Git repository password or a generated Git token.</p> <hr/> <p><b>Note:</b></p> <ul style="list-style-type: none"> <li>• The token length must be limited to 75 characters.</li> <li>• You must enter the password generated for your repository connection. It is recommended that you use tokens as they are more secure than passwords.</li> <li>• For GitHub, you must use only the Personal Access Tokens (classic). The Personal Access Tokens (fine-grained) do not work in GitHub.</li> <li>• For BitButcket, you must use only the App passwords.</li> </ul> <hr/> <p><b>d)</b> Re-enter the password or Git token to confirm.</p>

Authentication method	Steps
SSH Authentication	<p><b>a)</b> Enter the SSH repository path in the following format:</p> <pre>https:// git@bitbucket.org:companyname/ product.git</pre> <hr/> <p><b>Note:</b> Use the Git host that you want to obtain the Git repository address.</p> <hr/> <p><b>b)</b> Enter the branch name.</p> <p>The changes are pushed to the branch selected. By default, the <b>master</b> branch is selected.</p> <p>You can use lower case characters for branch names, but they must not exceed 250 characters. Do not include ASCII control characters such as spaces, tildes, or colons in branch names. You can use hyphen to separate words. For more information on branch naming, see <a href="#">Create a new Git branch</a>.</p> <p><b>c)</b> Enter your SSH authentication private key.</p> <p>You must create the private and public key pair by using the RSA algorithm.</p> <hr/> <p><b>Note:</b> Ensure that the private key entered in the Control Room contains the following string:</p> <pre>-----BEGIN RSA PRIVATE KEY----- AND -----END RSA PRIVATE KEY-----</pre> <p>You must generate the public key and enter it in your Git server.</p> <p>See the following topics for steps on how to generate the public key depending on your server:</p> <ul style="list-style-type: none"> <li>• <a href="#">Adding a new SSH key to your GitHub account</a></li> <li>• <a href="#">Set up an SSH key to your BitBucket account</a></li> </ul> <hr/> <p><b>d)</b> Optional: Enter the passphrase.</p>

4. Optional: Select the **Connect to Git via proxy** check box.
  - a) Enter the proxy host name or IP address.
  - b) Enter the port number.
  - c) Optional: Select the authentication check box and enter the user name and password.
5. Click **Connect and Save**.

The Control Room connects to the remote Git repository, and the following message is displayed: `Git integration settings successfully saved`. You can also check the audit log where the status for **Set git settings** is displayed as successful.

---

**Note:**

- The check-in operation might take longer if you have many bot files in your Git folder in the public workspace. This is because an increase in the repository size leads to a slowing down of the git commits. As a best practice, we recommend you delete your bot files that are not used from your public workspace.
- If the Git repository has any lock files such as `index.lock` or `master.lock`, delete these lock files as they might hinder the check-in and check-out operations.

---

You can connect to the same Git repository with a different username in the Control Room. For more information, see [How to change the remote Git repository username in the control room \(A-People login required\)](#).

See the following video for an overview of Git:

## Connect to Azure DevOps Git from Control Room

You can connect to Azure DevOps Git through the Control Room to check in and manage a bot and its dependent files to the remote Azure DevOps Git repository. It creates a back-up for all your checked-in bot and its dependent files on Azure DevOps.

- To connect to Azure DevOps Git from Control Room, ensure that you have the `AAE_Admin` role.
  - Make sure that you have an Azure DevOps account.
1. Log in to the Azure DevOps account.
  2. Create an Azure DevOps project. Provide a project name and description, select project visibility (public or private), and then click **Create**.
  3. Click **Repos**.
  4. Click **Generate Git Credentials**. Enter the username and the password or token. When you obtain a token to connect to Git, ensure that you have **Read** and **Write** permissions.
  5. Copy the Git repository path without any changes to **Administration > Settings > Git integration > Configuration > Setup Git integration > Edit > Git repository path (including username)** in the Control Room and enter the password/token.
  6. Click **Connect and Save**.
  7. To confirm whether your connection is successful, check in a file from the private repository to a public repository and verify that your changes are pushed to Azure DevOps Git repository.

## Remove Git integration configuration

If there is no longer a need to synchronize the bot information stored in your Control Room with the remote Git host, you can remove or disable it.

Ensure that you have the `AAE_Admin` role assigned to you.

1. Navigate to **Administrators > Settings > Git Integration**.
2. In the **Git Integration** window, click **Edit**.
3. Select **Do not set up Git integration**.
4. Click **Connect and Save**.

This setting removes the remote Git configuration, and the Control Room will no longer push the Git history to the remote Git host.

## Control Room IP addresses for external integrations

To ensure seamless connectivity to your Git instance, On-Premises key vault, or SIEM with the Cloud Control Room, configure your network firewall to include Automation Anywhere outbound Automation 360 IP addresses to the allowed list.

When you configure an Automation 360 Cloud deployment to connect to external systems or to capabilities such as a Git instance, On-Premises key vault, or SIEM with your Cloud Control Room, then you must provide connections to those systems or services for the Automation 360 Cloud instance.

The Automation 360 server instance initiates the connection by using one of the listed Automation 360 IP addresses. As a result, you must configure these IP addresses in your network firewall and add the regional outbound Automation 360 IP addresses to the allowed list.

The following diagram shows a typical Automation 360 Cloud deployment for external integrations:

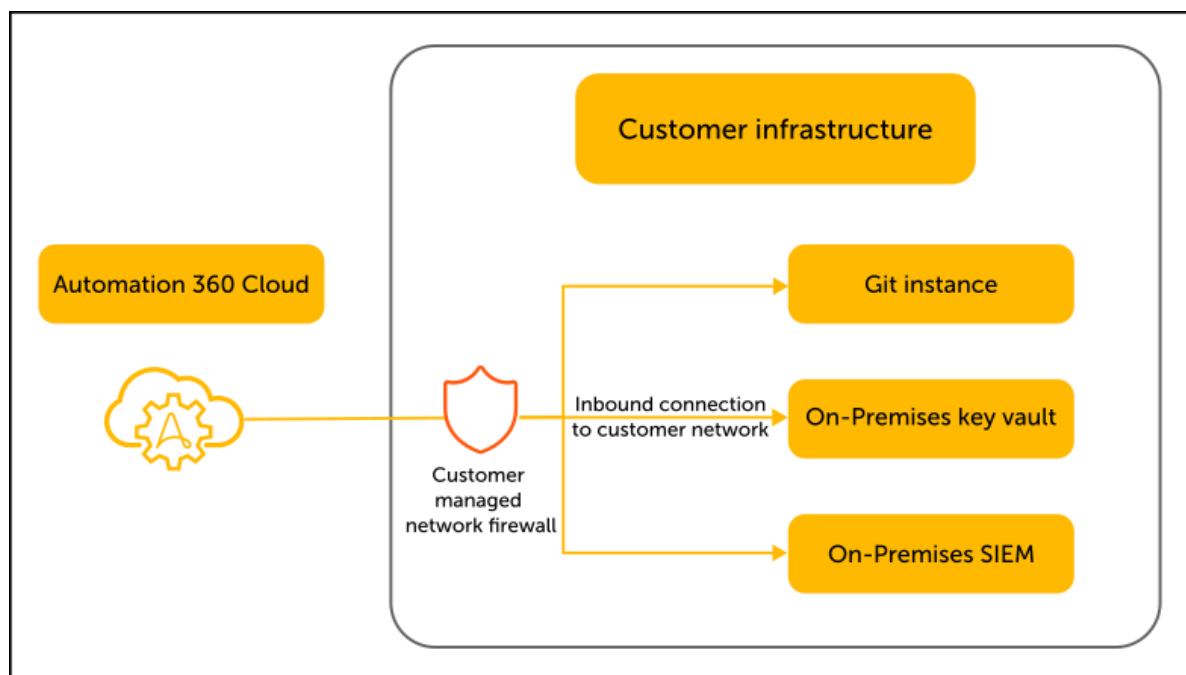

Based on your region, add the following outbound Automation 360 IP addresses to the allowed list:

Region	IP addresses
- Africa	<ul style="list-style-type: none"> <li>• 13.244.57.44</li> <li>• 13.244.197.159</li> <li>• 13.244.185.72</li> <li>• 54.228.5.1</li> <li>• 54.228.48.30</li> <li>• 54.217.103.248</li> </ul>
- Australia	<ul style="list-style-type: none"> <li>• 54.153.153.175</li> <li>• 52.65.8.56</li> <li>• 3.106.147.142</li> </ul>
- Canada	<ul style="list-style-type: none"> <li>• 35.203.94.19</li> <li>• 34.152.28.44</li> </ul>
- EU West 1	<ul style="list-style-type: none"> <li>• 108.128.188.103</li> <li>• 63.34.200.237</li> <li>• 52.30.160.238</li> <li>• 18.197.15.181</li> <li>• 18.195.27.35</li> <li>• 3.123.208.13</li> </ul>
- EU West 4	<ul style="list-style-type: none"> <li>• 35.204.101.230</li> <li>• 34.141.232.185</li> <li>• 34.141.55.27</li> <li>• 34.141.57.227</li> </ul>
India	<ul style="list-style-type: none"> <li>• 3.7.60.137</li> <li>• 3.6.235.61</li> <li>• 13.232.116.48</li> <li>• 18.136.73.65</li> <li>• 52.77.203.34</li> <li>• 18.136.8.15</li> </ul>
- Japan	<ul style="list-style-type: none"> <li>• 18.177.157.130</li> <li>• 18.176.174.19</li> <li>• 3.114.196.205</li> <li>• 54.169.202.27</li> <li>• 52.221.25.42</li> <li>• 18.140.96.19</li> </ul>

Region	IP addresses
- LATAM	<ul style="list-style-type: none"> <li>• 54.94.241.48</li> <li>• 18.229.39.93</li> <li>• 52.67.153.170</li> <li>• 34.195.218.48</li> <li>• 3.211.67.78</li> <li>• 3.228.163.41</li> </ul>
- Middle East	<ul style="list-style-type: none"> <li>• 15.185.153.52</li> <li>• 15.185.181.122</li> <li>• 157.175.32.98</li> <li>• 52.213.112.204</li> <li>• 54.154.112.221</li> <li>• 34.242.58.85</li> </ul>
- Sandbox Australia	<ul style="list-style-type: none"> <li>• 34.151.71.179</li> <li>• 35.189.24.10</li> </ul>
- Sandbox EU West	<ul style="list-style-type: none"> <li>• 54.228.82.108</li> <li>• 54.73.17.42</li> <li>• 54.228.85.241</li> <li>• 3.122.33.207</li> <li>• 35.156.216.8</li> <li>• 18.159.235.149</li> </ul>
- Sandbox US West	<ul style="list-style-type: none"> <li>• 35.164.189.142</li> <li>• 35.166.154.241</li> <li>• 35.160.254.91</li> <li>• 35.168.234.8</li> <li>• 34.204.215.165</li> <li>• 54.92.237.118</li> </ul>
- Singapore	<ul style="list-style-type: none"> <li>• 18.141.71.43</li> <li>• 54.251.139.55</li> <li>• 18.136.253.184</li> <li>• 18.176.165.62</li> <li>• 52.68.115.49</li> <li>• 54.168.135.182</li> </ul>
- US Central	<ul style="list-style-type: none"> <li>• 34.85.131.101</li> <li>• 35.245.151.203</li> <li>• 34.68.252.217</li> <li>• 34.123.71.95</li> </ul>

Region	IP addresses
- US East	<ul style="list-style-type: none"> <li>• 50.16.245.134</li> <li>• 35.174.84.76</li> <li>• 3.210.114.16</li> <li>• 54.244.136.23</li> <li>• 54.185.77.190</li> <li>• 44.234.224.213</li> </ul>
- US East 2	<ul style="list-style-type: none"> <li>• 18.222.104.223</li> <li>• 3.20.77.240</li> <li>• 3.138.227.220</li> </ul>
- US West	<ul style="list-style-type: none"> <li>• 54.213.119.159</li> <li>• 34.218.159.79</li> <li>• 52.33.16.117</li> <li>• 3.225.222.13</li> <li>• 34.197.160.162</li> <li>• 3.213.188.29</li> </ul>
- Sandbox US Central	<ul style="list-style-type: none"> <li>• 35.223.219.53</li> <li>• 34.133.80.165</li> <li>• 34.150.165.212</li> <li>• 35.245.150.192</li> </ul>
- Sandbox Singapore	<ul style="list-style-type: none"> <li>• 13.251.176.239</li> <li>• 54.169.33.175</li> <li>• 46.137.201.87</li> </ul>

## Restore bots from Git repository

You can restore all your bots and their dependent files from the Git repository to your server repository. This restore option is available only for On-Premises deployments and not supported on Cloud deployments.

Ensure the following before you restore your bots from Git:

- You must have a backup of the bots on Git.
- You must have the **AAE\_Admin** role assigned.

Keep the following considerations in mind while restoring bots from a Git repository:

- You can restore either all or differential bots and files from the external Git repository. You cannot selectively restore specific bots or files from the external Git repository.
- The Git restore process requires some downtime. When the restore process is running, the following public workspace operations are disabled:
  - Check-out



- Clone
  - Run and schedule bots
  - Run bots with queue
  - Import and export bots
- When the restore process is running, the check-in operation is not allowed from the private workspace. However, you can use the private workspace for the rest of the operations.
  - You can restore your bots to your empty or non-empty repository.
  - You cannot abort (cancel) an ongoing restore process.

The Git restore functionality is important in the following scenarios:

- The server repository is corrupted and you are starting with a new server repository.
- You want to restore bots to a different Git branch.

For example, consider there are two branches of Git: Dev and Test integrated with Dev and Test Control Room. The Test branch can pull the contents from the Dev branch and you can restore bots from Git in the Test Control Room.

1. Log in to the Control Room as an admin user.
2. On the left pane, click **Automation**.  
A list of available and forms is displayed.
3. Click the **Restore from Git** option in the **Public** workspace.  
The **Restore from Git** dialog box appears, displaying a warning that all the public repository operations will be disabled during the Git restore process.
4. If you have duplicate files in the Git repository, select to either **Overwrite existing files** or **Skip existing files** in the Git repository.
5. Based on whether the repository is empty or non-empty, choose one of the following options:
  - To restore files to a repository that is not fully empty, enter your Git credentials for the associated repository.

---

**Note:** You cannot use the existing Git configuration for a partially filled repository.

---

- To restore files to a fully empty repository, you can choose the Git repository from which you want to restore your files.

Option	Action
Use existing git configuration settings	Select this option to restore your data from the Git repository configured with the Control Room.  <hr/> <b>Note:</b> Ensure you connect your Control Room to the remote Git repository from <b>Administration &gt; Settings &gt; Remote Git repository integration</b> .  <hr/>

Option	Action
Use manual settings	<p>Select this option to restore data from any other repository.</p> <p><b>a)</b> Enter the HTTPS repository path including the username in the following format:</p> <pre>https:// &lt;username&gt;@bitbucket.org/ companyname/product.git</pre> <p><b>b)</b> Enter the branch name.</p> <p><b>c)</b> Enter your Git repository password or a generated Git token.</p> <p><b>d)</b> Re-enter the password or Git token to confirm.</p> <hr/> <p><b>Note:</b> If you are using the same settings as the existing Git configuration, you will encounter an error. To use the same configuration, first remove the remote Git repository integration setting in <b>Administration &gt; Settings &gt; Remote Git repository integration</b> before providing the same in this manual settings option.</p>

6. Optional: Select the **Connect to Git via proxy** check box.
  - a)** Enter the proxy host name or IP address.
  - b)** Enter the port number.
  - c)** Optional: Select the authentication check box and enter the user name and password.
  
7. Click **Continue** to proceed with the restore process.
 

The system starts restoring the bots and the dependent files from Git. This process takes some time.

After the restore process is completed successfully, you are automatically returned to the **Automation** page. The bots and the dependent files are restored in your new server repository, maintaining the original structure of the dependent files.

If the Git restore process fails after restoring some bots, you are redirected to the public workspace with the following options. Choose the required option to complete the restore process:

Option	Action
<b>Revert restoration bots</b>	<p>This option clears all the bots that were restored.</p> <hr/> <p><b>Note:</b> This option will delete the public bots that were restored from the Git repository.</p>

Option	Action
<b>Restart restoration</b>	The Git restore process restarts from where it ended.
<b>Keep only the restored files</b>	This option retains whatever files were restored and will exit the restore process.

## Usage statistics

Automation Anywhere collects usage statistics from Automation 360 for product improvements.

Usage statistics provides information on where users might be facing issues with the product, the most used or least used features, and so on. This information helps in product improvement which in turn helps in improving the customer experience.

By default, the **Usage statistics** option is enabled in the Control Room and usage data is collected. The data collected is stored in Automation 360 and the service provider cloud. The collected data is typically generic information such as anonymized user details, customer name, and user navigation workflows such as menus the users access and clicks.

An administrator can disable the **Usage statistics** option by changing the settings in the Control Room.

---

**Note:** The option can be disabled only for On-Premises installations.

If you disable the **Usage statistics** option, various in-product updates will be blocked such as:

- Product announcements
- User notifications
- Educational spotlights
- Contextual user assistance like tips on productivity boost

For more information on the impact of disabling the **Usage statistics** option, see [Blocking the platform](#) on page 1161.

---

## Disable usage statistics

An administrator can disable the **Usage statistics** option by changing the settings in the Control Room.

Ensure that you are logged in to the as the administrator.

1. Navigate to **Administration > Settings > General > Advanced settings**.
2. Click the **Edit** icon. 
3. Select the **Disabled** option.

---

**Note:** The option can be disabled only for On-Premises installations.

If you disable the **Usage statistics** option, various in-product updates will be blocked such as:

- Product announcements
- User notifications
- Educational spotlights

- Contextual user assistance like tips on productivity boost

For more information on the impact of disabling the **Usage statistics** option, see [Blocking the platform](#) on page 1161.

---

4. Click **Save changes**.

## Set up instances for Cloud-enabled deployments

Manage trust relationship between the cloud-deployed Automation 360 Cloud-enabled instance and the On-Premises applications.

Ensure that you are logged in to the as the administrator.

For Cloud-enabled deployment, the initial welcome email that you received from Automation Anywhere contains:

- URL to the Automation Anywhere Cloud-enabled instance
- Provisioning token needed to establish trust connectivity with the Automation Anywhere Cloud Control Room

Automation Anywhere deploys and configures an Automation Anywhere Automation 360 Cloud instance for this Cloud-enabled deployment option. The customer then installs the On-Premises application within their infrastructure for storing and processing customer data. After this is complete, you install the On-Premises application within your infrastructure for storing and processing customer data.

1. Log in to the On-Premises Control Room as the administrator.
2. Navigate to **Administration > Settings > Cloud-enabled**.
3. Provide the provisioning token to connect to the Control Room.
4. Click **Save changes**.
5. Optional: Test the Cloud-enabled functionality.  
Open a browser and enter the URL for the Cloud Control Room service instance. Click **Enter** to be redirected to the On-Premises Control Room.

## Generate registration key to install Bot Agent in bulk

The Control Room administrator can generate a registration key to install the Bot Agent on multiple devices at a time in bulk.

Ensure you have set up the Microsoft Active Directory group policy to remotely install the Bot Agent on multiple devices.

[Use Microsoft Active Directory Group Policy to remotely install software](#)

Generate and copy the key for use in an installation script or as part of the Active Directory group policy to install the Bot Agent on multiple devices at a time.

Also, download the latest Bot Agent MSI installer file to your default downloads path to install the Bot Agent in bulk.

1. Navigate to **Administration > Settings**.

2. Select the **Bot agent bulk install** option.
3. Generate a new registration key for installation.

---

**Note:** Before you generate a new key, keep in mind that the new key invalidates the previous key and any entries or references to the previous key must be replaced with the new key value. Therefore, we recommend that you generate a new key only if the previous key is compromised.

---

- a) To launch the setting in edit mode, click the **Edit** option.  
When you open this setting for the first time, the option **Generate a new key** is shown by default and the phrase `Key not set` appears.
  - b) To create a new registration key, select the **Generate a new key** option.
- 

**Note:** A generic registration key is valid for 10 years.

---

- c) To install the Bot Agent using an installation script or through a Active Directory group policy, click **Copy to clipboard**.
  - d) Save the settings.
4. Replace the registration key:
    - a) To launch the setting in edit mode, click the **Edit** option.  
The **Keep current key** option is displayed by default.
    - b) To generate a new registration key, select the **Generate a new key** option.
    - c) Select **Continue** on the **Current registration key replacement** message box.
    - d) To use the key, click **Copy to clipboard**.
    - e) Save the updates.
  5. To download the latest Bot Agent MSI installer file, click **Download installer**.  
The Bot Agent installer MSI file is downloaded to your default `Downloads` folder.

Edit the Bot Agent MSI file to remotely install the Bot Agent on multiple devices.

Related tasks

[Bulk install Bot Agent on devices](#) on page 1354

Installing Bot Agent across multiple devices such as on-premises machines, virtual machines (VM), and non-persistent virtual desktop infrastructure (VDI) including Amazon WorkSpaces is called Bulk install (or silent install). You must edit the Bot Agent MSI file for bulk installation.

## Edit the Bot Agent installer file

Edit the Bot Agent MSI installer file to add the registration key and Control Room URL to remotely install the Bot Agent on multiple devices.

To perform the task, you must have a administrator account with the required rights and permissions.

Ensure the Windows 10 Software Development Kit including Orca and Control Room are installed on your device. You can install Orca from `C:\Program Files (x86)\Windows Kits\10\bin\10.0.18362.0\x86\Orca-x86_en-us.msi`.

Set up the Microsoft Active Directory group policy to remotely install the Bot Agent on multiple devices.

### [Use Microsoft Active Directory Group Policy to remotely install software](#)

Edit the Bot Agent .msi file to enable the Control Room administrator to implement the auto-update Bot Agent policy.

1. Use the latest `AutomationAnywhereBotAgent.msi` file from the following locations:
  - Download the file from the Control Room (**Administrator > Settings > Bot agent bulk install**).  
The download option is available for On-Premises and Cloud deployments.
  - Select the file from the `<application filepath>\crui\asset` folder. For example `C:\Program Files\Automation Anywhere\crui\asset`  
This option is available only for On-Premises deployments.
2. Edit the `AutomationAnywhereBotAgent.msi` file using Orca tool.
3. Click the **Property** option.
4. Change the value for `AA_CRTOKEN` and `AA_CRURL`.  
The `AA_CRTOKEN` uses the registration key and the `AA_CRURL` uses the Control Room URL for which the registration key is generated.
5. Save your changes.

## Configure integration with SIEM

The Automation Anywhere Control Room supports security information and event management (SIEM) tools ingesting logs from your tenant's Audit logs.

---

### Note:

The Splunk mark and logo, the Sumo Logic mark and logo, and the Radar mark and logo are trademarks or registered trademarks of Splunk, Sumo Logic, and Radar, respectively, and are used for identification purposes only.

---

With SIEM integration, audit logs can be sent to analytic tools, such as [Splunk](#), [Qradar](#), [Sumologic](#), and [ArcSight](#). By pushing audit log entries to SIEM tools, you can integrate and leverage the advanced searching and reporting features of SIEM solutions. When configured, the Control Room audit logs are forwarded to the configured SIEM server.

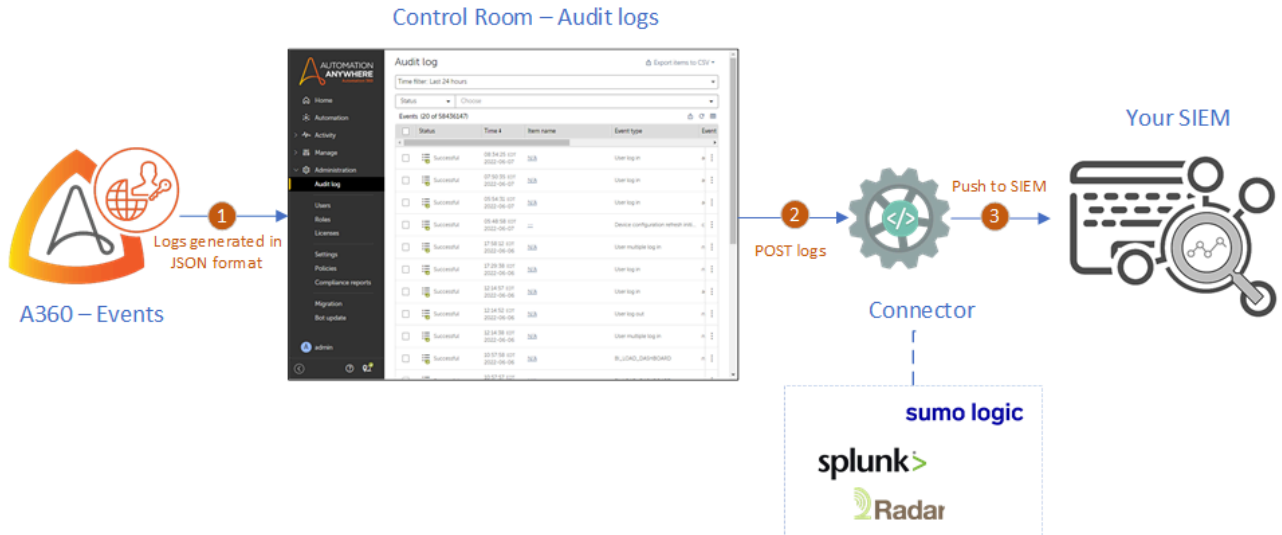

Configure an SIEM server step by step so that Automation 360 sends the audit messages to the SIEM server. In the following example, Sumo Logic is used as the SIEM provider. Use the same procedure to configure any other SIEM server.

## Setting up Sumo Logic

Setup the Sumo Logic as a SIEM tool to collect logs.

**Note:** The examples and graphics provided on this page are for representation purposes only and may not accurately reflect your specific instance. We do not assume responsibility for their maintenance or accuracy.

To use Sumo Logic as a logging endpoint, you will need to create a Sumo Logic account, add a new source, and save the HTTP source URL.

To add a new source in the Sumo Logic website, perform the following steps:

1. After you create your Sumo Logic account, the Sumo Logic Setup Wizard appears. If you already have an account, you can access the wizard by selecting **Setup Wizard** from the **Manage** menu at the top of the Sumo Logic application. In the **Setup Wizard**, click **Set Up Streaming Data**

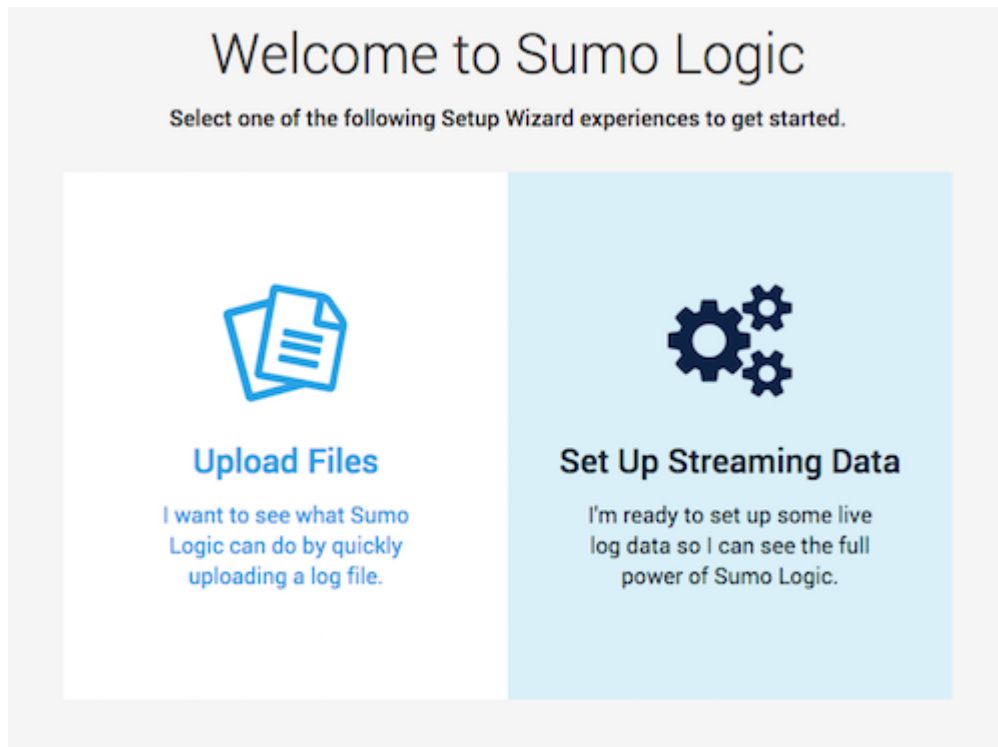

The **Select Data Type** window appears.

2. Click **All Other Sources**.



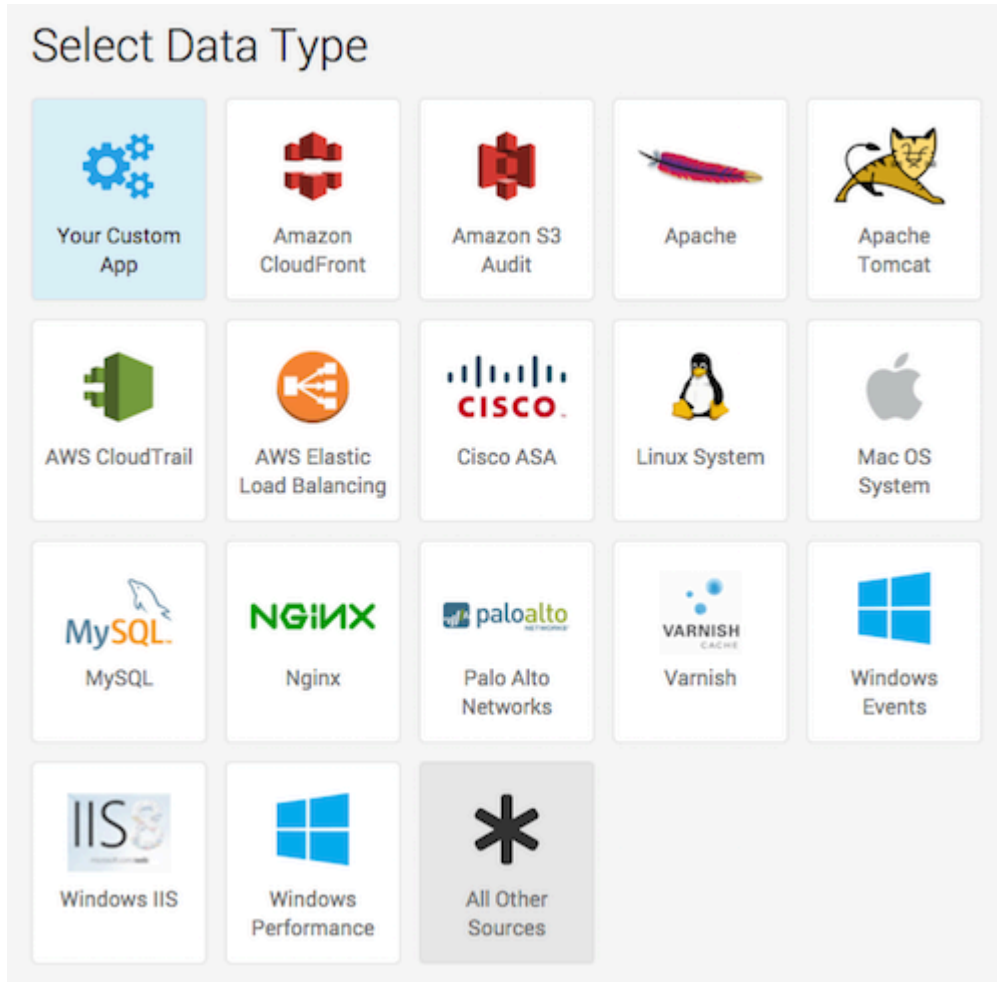

The **Set Up Collection** window appears.

3. Click **HTTP Source**.

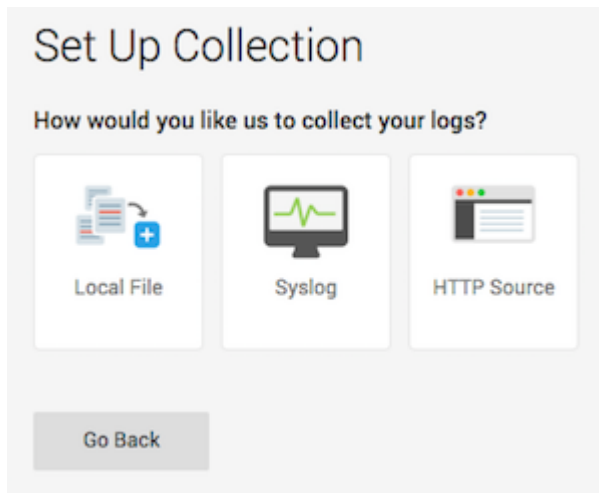

The **Configure Source: HTTP Source** window appears.

4. Enter a name in the **Source Category** (for example, Http Input), and select a timezone for your log files.

**Configure Source: HTTP Source**

1. Enter a Source Category that will help you search your logs later.

Source Category ?

custom\_http\_logs

2. Select a time zone for your log file.

Use time zone from log file. If none present use:

(UTC) Etc/UTC

Ignore time zone from log file and instead use:

(UTC) Etc/UTC

Go Back Continue

5. Click **Continue** to see a magic url such as the following:`https://endpoint1.collection.us2.sumologic.com/receiver/v1/http/ZaVnA4dhaV0nFJAEMuwFDGEEZUnDedm7hYhkdUJSAE44bmKKp1mp4LsYDCr2MzTA0C21czkqjz9UVjC1mk4`
6. Save this URL in an editor. You will need it when you add Sumo Logic as an SIEM logging endpoint. [Adding Sumo Logic as an SIEM logging endpoint](#) on page 1842

## Adding Sumo Logic as an SIEM logging endpoint

To configure the server where audit logs will be sent, add the Sumo Logic as an SIEM logging endpoint.

---

### Note:

To perform the task, you must have a administrator account with the required rights and permissions.

---

1. Navigate to **Administration > Settings > SIEM Integration Configuration**.

The screenshot displays the Automation Anywhere Administration console. On the left is a dark sidebar with the 'AUTOMATION ANYWHERE Automation 360' logo at the top. Below the logo are navigation items: Home, Automation, Activity, Manage, and Administration. Under Administration, there are sub-items: Audit log, Users, Roles, Licenses, Settings (highlighted with a red circle '1'), Policies, Compliance reports, Migration, and Bot update. At the bottom of the sidebar is a user profile for 'admin' and navigation icons. The main content area on the right shows a list of settings categories: Bots, Packages, Devices, IQ Bot, Bot agent bulk install, Email, Remote Git repository integration, Login settings, Security settings, User Authentication, Network settings, and External key vault. The 'SIEM Integration Configuration' section is expanded, showing a 'Configuration' card with an 'Edit' icon (highlighted with a red circle '2'). The configuration text reads: 'The cloud SIEM Intergration will allow you to configure integration with and external SIEM Server. External SIEM Integration Configuration Disabled'.

2. Click the **Edit** icon. 
3. Select **Enabled** and paste the **SIEM server endpoint** that you copied previously, from [Adding Sumo Logic as an SIEM logging endpoint](#).

**Note:** Ensure that you refer to your SIEM provider's documentation to get the information regarding the HTTP headers and requirements around JSON attributes (request body).

4. Select **POST** HTTP method, because Sumo Logic accepts the inputs as a POST method.

**Note:** The SIEM tool certificate is optional and depends on the SIEM provider. Some SIEM providers require you to enter a valid SIEM tool certificate.

5. Enter a name for **Event attribute**(for example, audit). All the log messages will be logged under this category and will act as key to locate all the event logs.

**Note:** The timestamp attribute is an optional field and depends on the SIEM provider's mapping for this field. For example, Splunk requires the value to be time and mapped to one of its timestamp fields. The maximum length allowed is 256 characters. All special characters are allowed except the backslash (\) and double quotation marks ("). These characters have to be escaped.

6. Click on plus (+) sign to enter a few **key-value pairs for body** (static attributes) that are sent out along with the logs. The key-value pairs also take special characters as inputs. You will be able to configure a maximum of 50 attributes.

- Click on plus (+) sign to enter a few **key value pairs for header** to be sent with every event data log. The header data is specific to the SIEM provider. For example, with Sumo Logic, it supports header names starting with the letter X (for example, X-Sumo-Fields). You will be able to configure a maximum of 50 headers.

**Key value pairs for header**  
Additional key value pairs to attached to event headers for events sent from this Control Room.

Header	Value
X-Sumo-Fields	environment=devcloud,cluster=aaedev

For more information about header data, see the corresponding SIEM provider's documentation.

## Verifying data in Sumo Logic

Reception of audit logs are verified using the Sumo Logic web interface. One way to do this is to search for events using the name of the collector and source.

**Note:** The examples and graphics provided on this page are for representation purposes only and may not accurately reflect your specific instance. We do not assume responsibility for their maintenance or accuracy.

Perform the following steps to verify the data in Sumo Logic:

- Generate an audit log by generating an event. For example, create a user ([Create a user](#) on page 1739).
- Go to [Audit log](#) on page 2143 to see the entry in the logs.  
In Sumo Logic, you will notice the event logged in the source that you configured when setting up Sumo Logic. [Setting up Sumo Logic](#) on page 1839
- Navigate to **Manage Data > Collections**
- On the **Collection** tab, click **Open in Log Search** icon next to the respective log source.

The screenshot shows the Sumo Logic 'Collection' page. The table below represents the data visible in the interface:

Name	Health	Type	Status	Source Category	Sources	Last Hour	Messages
test	Healthy	Hosted			1	[Line Graph]	1
test	Healthy						
HTTP	Healthy						
devops-global	Healthy	Hosted			10	[Line Graph]	2,783,483
(default-metrics)	Healthy						
HTTP	Healthy						
apiserver-metrics	Healthy						
HTTP	Healthy						
control-plane-metrics	Healthy						
HTTP	Healthy						
events	Healthy			test-global-us-east-1-eks/events			
HTTP	Healthy						

It displays events filtered by collector and source. A user creation event in JSON format sent to Sumo Logic through HTTPS is displayed.

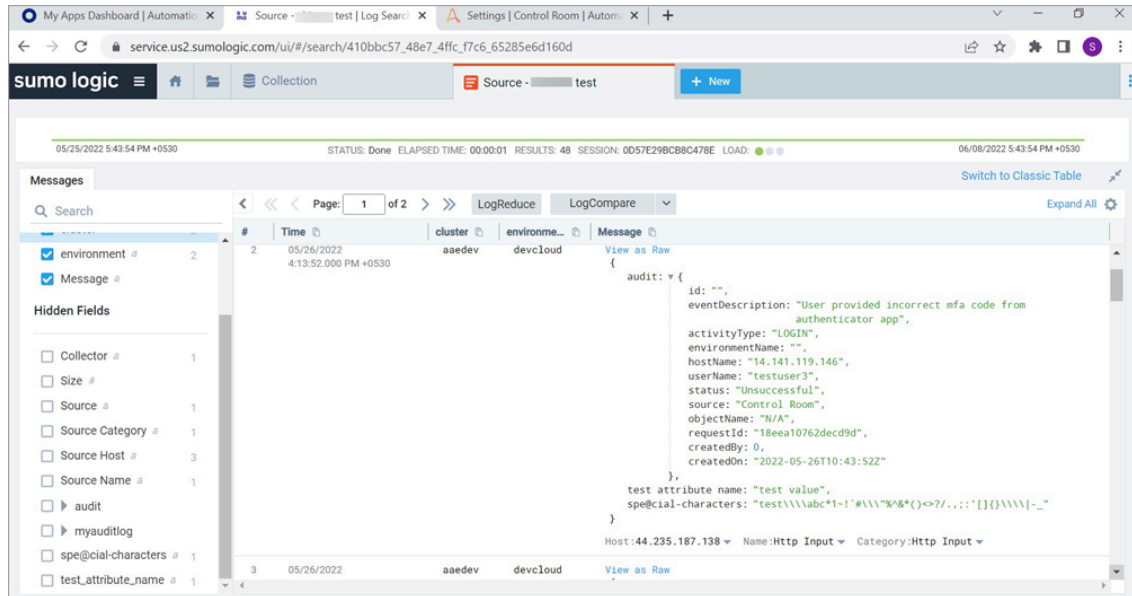

## Use AuthConfig App to enable OAuth2 services

As an Organization Administrator with access to the Licenses and Cloud Services portal, you use the AuthConfig App to manage the relationship between a set of Automation 360 Control Room instances and our OAuth2 (Open Authorization) services. OAuth2 services are used to interact with the Automation 360 Control Room by third-party applications. Currently, you can only use the PixieBrix extension to use the OAuth services to interact with the Control Room.

**Note:** The availability of this feature is based on your region.

For more details regarding licenses and the PixieBrix extension, click:

- [Licenses and cloud services](#) on page 1404
- [PixieBrix and Automation Anywhere](#)

You use OpenID tokens to authenticate to the AuthConfig App.

## Token overview

Automation Anywhere and the AuthConfig App support the following token types:

- **Control Room registration token:** The AuthConfig App generates this token which you enter in the **OAuth Settings** panel of the Automation 360 Control Room. The Control Room registration token establishes the identity of your Control Room to the AuthConfig App. After you register and enable the token, the Control Room can consume access tokens to call APIs.
- **Access token:** A JSON web token generated from an authorization provider after authenticating with an Identity Provider (IdP). Access tokens contain claims that provide information to a resource server. API calls use access tokens to enable an authorized client to gain access to data on the resource server.

- Refresh token: Refresh tokens provide a method to get new access tokens without having to collect and authenticate credentials every time an access token expires.

The AuthConfig App generates Control Room registration tokens to enable OAuth2 services. The following diagram shows how a registration token flows between the AuthConfig App and the Automation 360 Control Room:

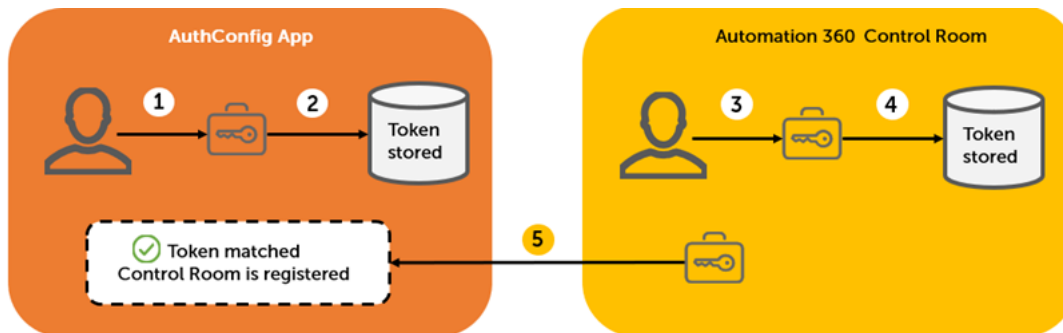

1. The Administrator uses the AuthConfig App to generate a registration token.
2. The registration token is stored in the database.
3. The Administrator enters the generated registration token into the OAuth Settings in the Automation 360 Control Room.
4. The registration token is stored in the database.
5. The registration token is then sent to the AuthConfig App where if the token matches the token stored in the database, the Control Room is registered.

**Note:** Authorization code flow with PKCE is currently supported.

## Benefits

You use the AuthConfig App to:

- Enable or disable OAuth2 services for an Automation 360 Control Room (On-Premises or Cloud).
- Configure an Identity Provider (IdP) configuration using a SAML authentication connection for your organization to use with OAuth2 services.
- Generate registration tokens for each Control Room to securely enable OAuth2 services.

For details about accessing automations in a web scenario with Automation Co-Pilot (extensions) and using a custom widget through Google Chrome extensions, click [here](#).

## Prerequisites

Before you use the AuthConfig App:

- Create your Automation Anywhere community (Apeople) credential: [A-People home page \(login required\)](#).
- From the Automation 360 Control Room:

- To enable an IdP authenticated user to use an access token to call a Control Room API, you must also add the IdP authenticated user as a Control Room user.
- To use access tokens, you must register and enable Control Room instances with OAuth2 services.

After you complete the prerequisites, you can [access the AuthConfig App](#).

## Access the AuthConfig App

The AuthConfig App generates Control Room registration tokens to enable OAuth2 services.

To access the AuthConfig App:

1. Log in to the Automation 360 Control Room as the Administrator.
2. To obtain the AuthConfig App login URL, you can either:
  - From the Control Room, navigate to: **Administration > Settings > OAuth**, and then click the link provided in the Registration text area, or
  - Copy and paste this URL (default URL) into a browser window: `https://oauthconfigapp.automationanywhere.digital`
3. The **AuthConfig App Log in** dialog box displays:

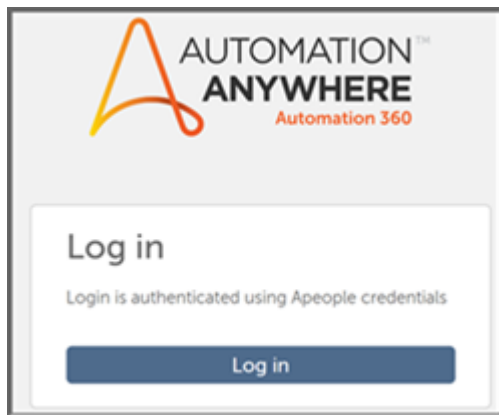

Click **Log in** to log in with your existing Apeople credentials. You are re-directed to the [A-People home page \(login required\)](#) page.



- From the A-People home page, enter your credentials (username and password) and click **Log in**. You are re-directed to the AuthConfig App

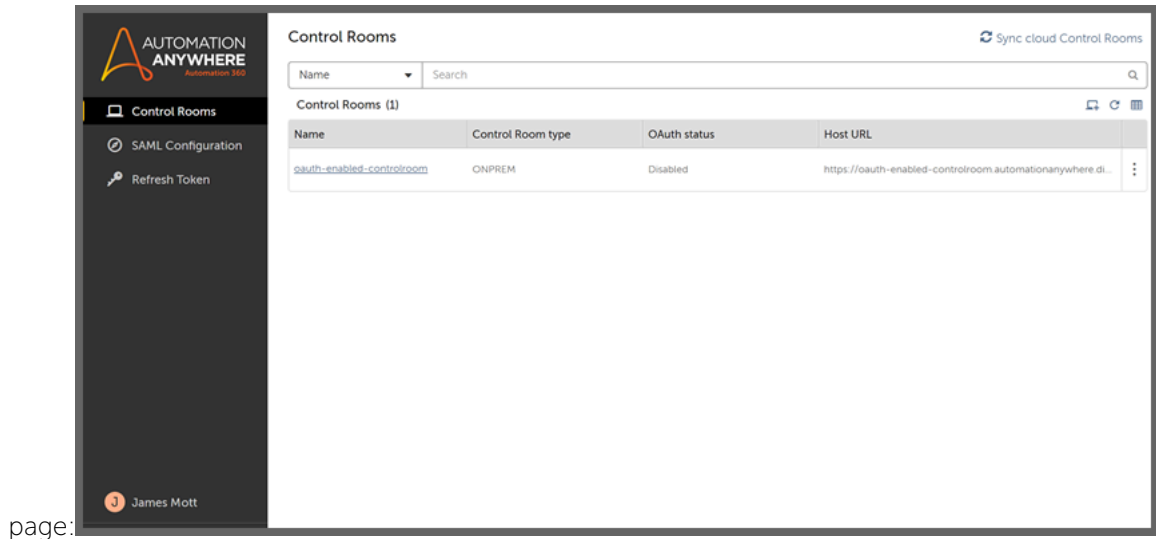

From AuthConfig App page, you can:

- [Review existing On-Premises and Cloud Control Room instances to enable OAuth2 services](#)
- [Configure SAML](#)
- [Manage refresh tokens](#)

To log out of the AuthConfig App:

- Click your username profile at the bottom of the page to open the **Log Out** dialog box:



- Click **Log Out**.

## Review Control Rooms

If not already displayed on the AuthConfig App page, select **Control Rooms** on the left side of the page to display a list of all your On-Premises and Cloud Control Rooms.

If new Control Room instances were added through the [Licenses and cloud services](#) on page 1404 portal, click Sync cloud Control Rooms at the top of the page to update and display them in the list.

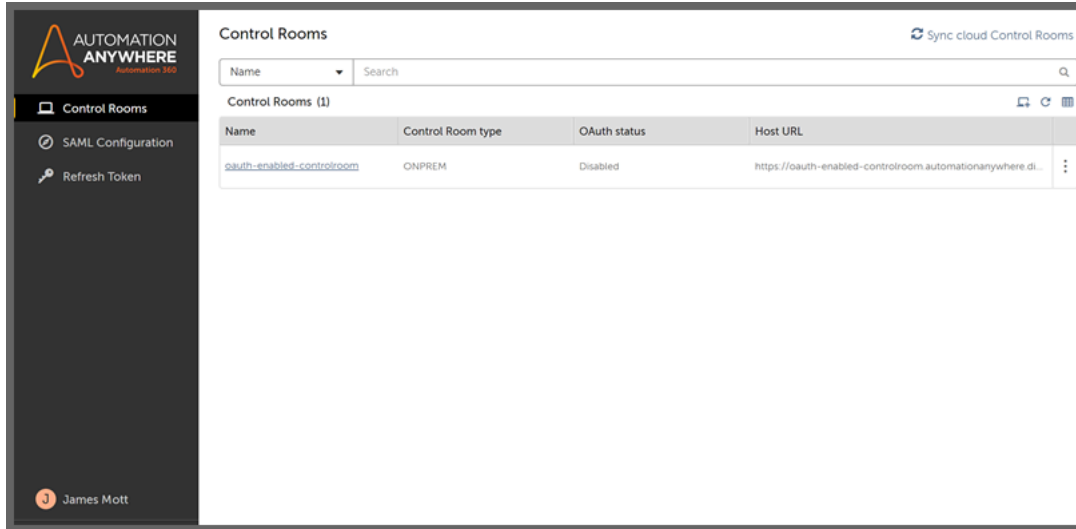

**Note:** If you delete a Cloud Control Room from the AuthConfig App (which still has a valid license), then the Cloud Control Room will re-appear in the Control Room list after syncing.

From the **Review Control Room** page, you can:

- [Generate a registration token for a Control Room](#)
- [Enable or disable OAuth2 services for a Control Room](#)
- [Add or delete an On-Premises Control Room](#)

## Generate a registration token for a Control Room

To generate a registration token for a Control Room:

1. Click the Control Room name or hover over the actions menu (three vertical ellipses) located to the right of the Control Room name and click the **Binoculars** icon. The Control Room details page displays.

- To generate a registration token for the Control Room to enable OAuth2 services, click **Generate token** at the top right of the

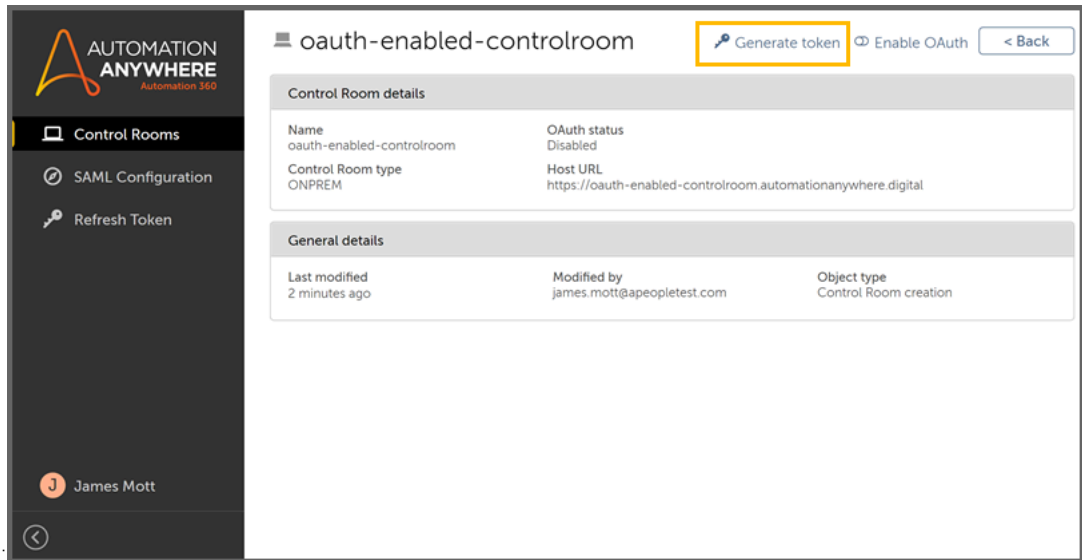

page:

- A confirmation message displays asking if you want to generate the token. The generated token is required to register your Control Room tenant with OAuth2. Click **Generate**.
- A dialog box displays the newly generated registration token. Click **Copy token**.

**Note:** You should store this token in a safe place for future use. You cannot retrieve this token after you close the window.

- Navigate to: **Administration > Settings >**

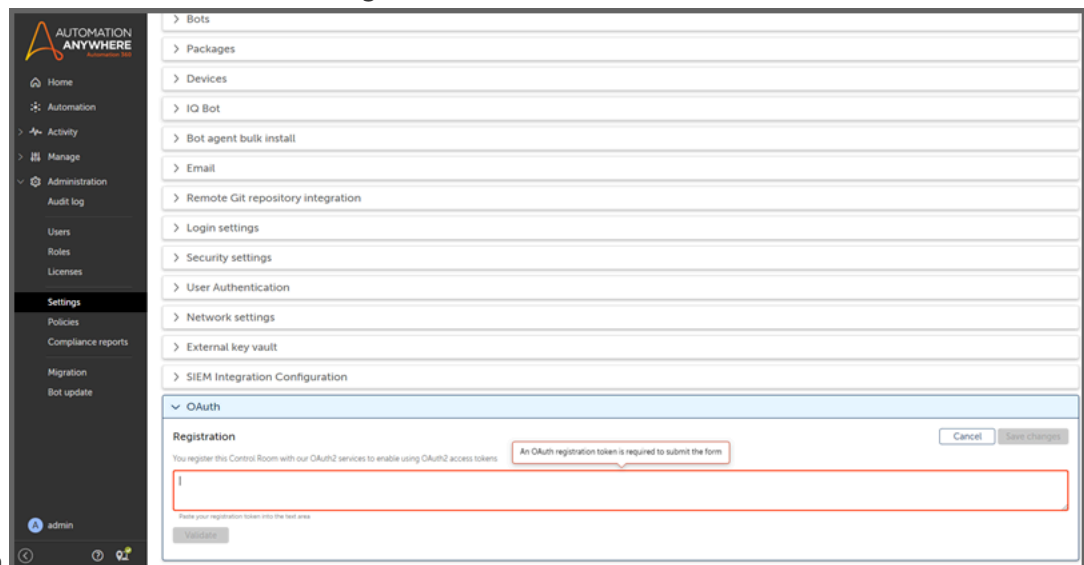

OAuth2.

In the text area, paste the token you copied to register the Control Room with our OAuth2 services to enable using OAuth2 access token.

- Click **Validate** and review the data to ensure that it matches the Name and Host URL you were expecting.

## 7. Click **Save changes**.

Saving the registration token will automatically enable OAuth2 for the selected Control Room tenant.

## Enable or disable OAuth2 services for a Control Room

To enable or disable OAuth2 services for a Control Room:

1. Click the Control Room name or hover over the actions menu (three vertical ellipses) located to the right of the Control Room name and click the **Binoculars** icon. The Control Room details page displays.
2. By default, the OAuth2 services for a Control Room are disabled. To enable OAuth2 service, click the **Enable OAuth** toggle at the top right of the

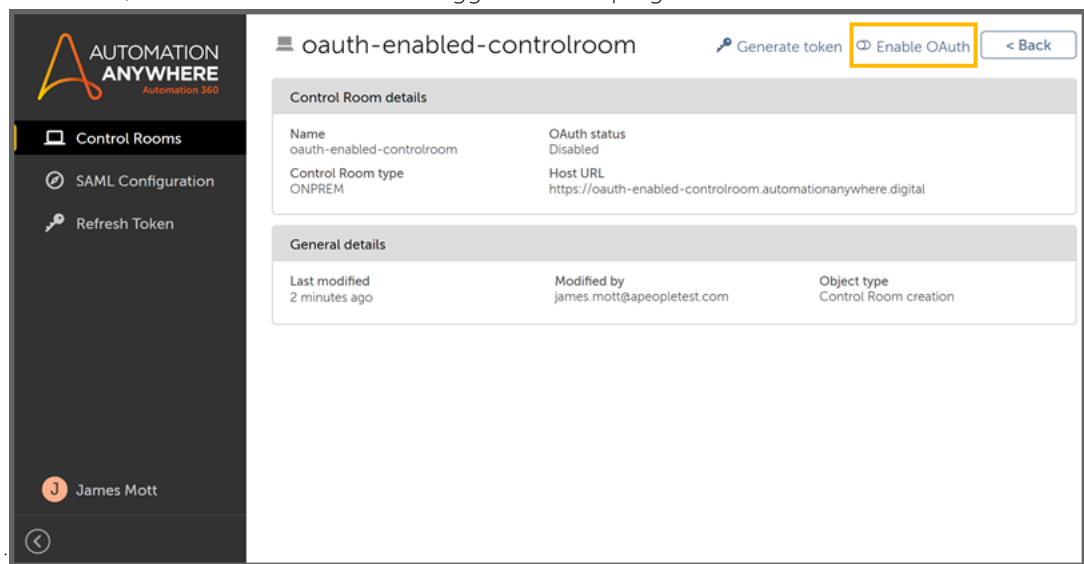

page:

The OAuth status changes to Enabled.

3. Click **< Back** to return to the Control Room list.

## Add or delete an On-Premises Control Room

**Note:** You cannot add a Cloud Control Room because it is consumed automatically by the AuthConfig App.

To add an On-Premises Control Room:

1. Click the **Add Control Room** icon at the top right of the page:

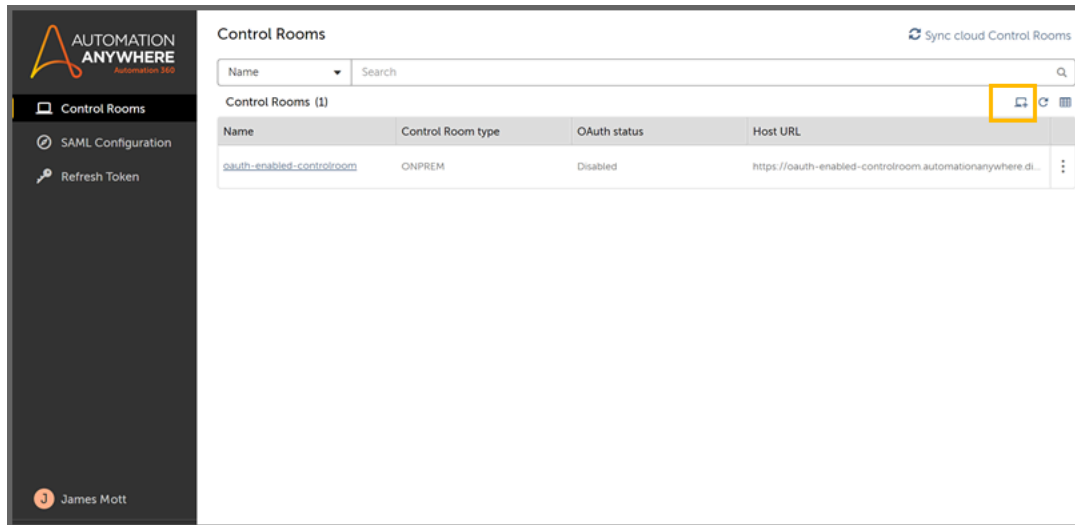

2. The **Add an On-Premises Control Room** dialog box displays:

The dialog box is titled 'Add an On-premises Control Room'. It contains the following fields and buttons:

- Name:** oauth-enabled-controlroom
- Host URL:** https://oauth-enabled-controlroom.automationanywhere.digital
- Buttons:** Cancel, Submit

Below the Host URL field, there is a small text: eg : https://.....

- a) Enter a unique **Name** and **Host URL** (for example: `https://digital.automationanywhere.com/nextbank`) for the new On-Premises Control Room. The host URL you enter must match the URL you provided to your external OAuth client (for example: PixieBrix).
- b) Click **Submit** when finished.

To delete an On-Premises Control Room:

1. Hover over the actions menu (three vertical ellipses) located to the right of the Control Room name and click the **Delete** icon:

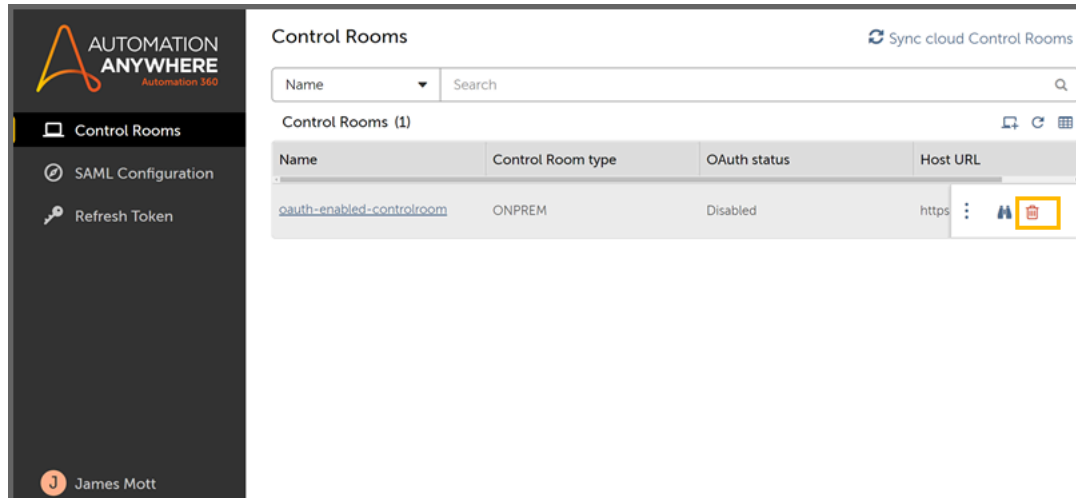

2. A confirmation message displays asking if you want to permanently delete the Control Room. Click **Yes, delete** to remove the registered Control Room from the AuthConfig App.

## Configure SAML connection details

You configure SAML to authenticate to your Identity Provider (IdP) to obtain OAuth access tokens.

**Note:** To configure OAuth, you must create a separate SAML web app. Ensure that you do not use the SAML web app that you use to connect to the Control Room to configure OAuth.

To configure SAML connection details:

1. From **AuthConfig App** page, select **SAML Configuration** on the left side of the page.
2. Click **New SAML configuration** at the top of the page.
3. The **New SAML configuration** dialog box displays:

- a) Enter the connection name. The connection name is user defined.
- b) Enter the sign-in URL. This URL information is provided in your external authentication provider and is typically referred to as IdP URL by most providers.
- c) Click **Browse** to locate your IdP public key. This key must be in the PEM format (.pem). The public key validates the IdP's signed response.
- d) Click **Create**.  
The SAML configuration is created and provides the configuration details.
- e) From the SAML configuration details section, select and copy the **Entity ID** and **ACS URL** values.
- f) Navigate to the SAML configuration page of your IdP.

- g) Enter the **Entity ID** value in the **SP Entity ID** field of your IdP.

**Note:** Most IdPs use the **SP Entity ID** field to identify the entity ID field. However, some IdPs might use a different name. In such a scenario, identify the entity ID field for the IdP and enter the **Entity ID** value.

- h) Enter the **ACS URL** value in the ACS (Assertion Creation Service) URL field of your IdP.

**Note:** You can perform step e to step h by downloading the SAML metadata from the AuthConfig App and uploading it directly into your IdP SAML configuration.

The connection name configuration details

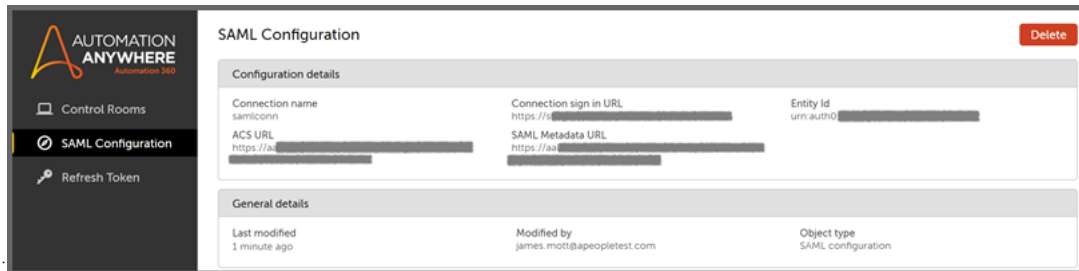

display:

The ACS (Assertion Creation Service) URL directs your IdP where to send its SAML response after authenticating a user, and the Entity ID is the unique identifier of the IdP.

To delete the SAML configuration, click **Delete** at the top right of the page. A confirmation message displays asking if you want to delete the SAML configuration.

**Note:** If you delete the SAML configuration, Control Room users will not be able to obtain new access tokens using our OAuth2 service.

Click **Delete** to continue.

## Manage refresh tokens

One SAML connection can have multiple tokens.

To manage the refresh tokens:

1. From **AuthConfig App** page, select **Refresh Token** on the left side of the page. The Refresh Token Management page displays:

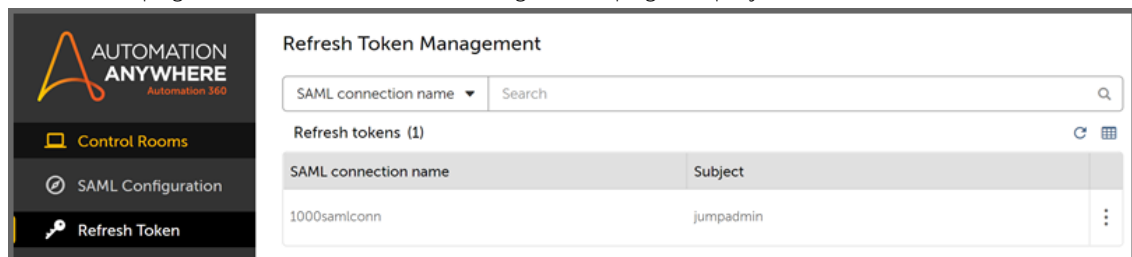

2. You can enter SAML connection name or subject search parameters in the **Search** box.
3. To revoke a refresh token, hover over the actions menu (three vertical ellipses) located to the right of the token name and click the **X (Revoke)** icon.

- A confirmation message displays asking if you want to revoke the token.

**Note:** By revoking the refresh token, the associated application will not be able to obtain a new access token using the refresh token.

Click **Revoke**.

## Cloud device management (API Task)

The Automation Anywhere Control Room settings page allows you to set the API Tasks concurrency (within form and process) and add API Tasks that are called within forms.

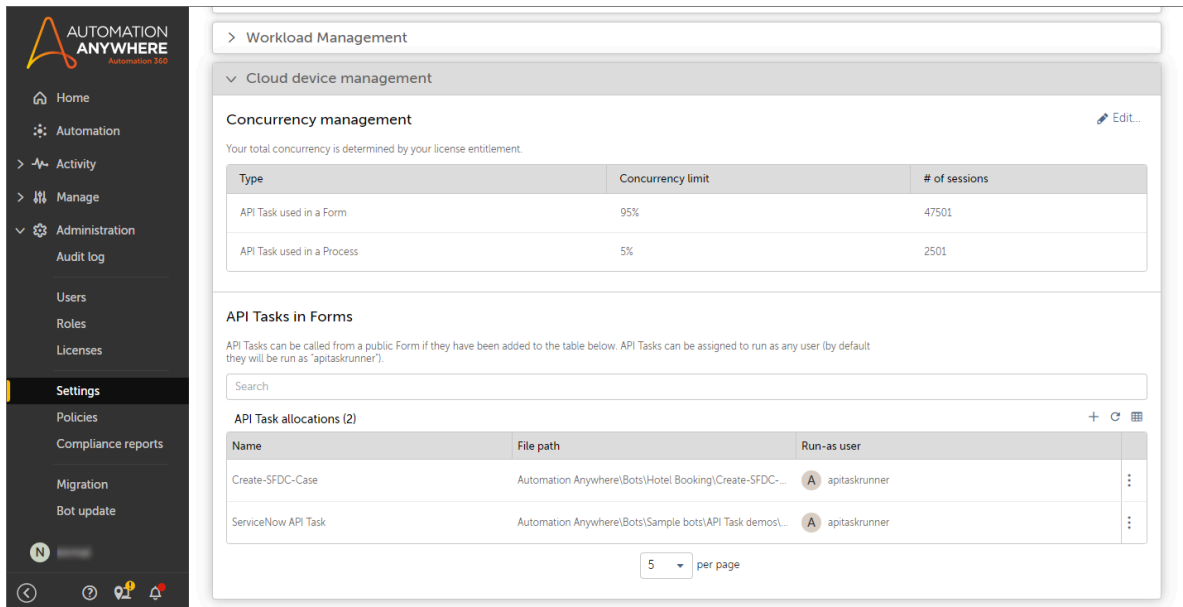

The screenshot displays the 'Workload Management' section, specifically 'Cloud device management'. It includes a 'Concurrency management' section with a table showing concurrency limits and session counts for different API Task types. Below this is the 'API Tasks in Forms' section, which includes a search bar and a table of API Task allocations.

Type	Concurrency limit	# of sessions
API Task used in a Form	95%	47501
API Task used in a Process	5%	2501

Name	File path	Run-as user
Create-SFDC-Case	Automation Anywhere\Bots\Hotel Booking\Create-SFDC-...	apitaskrunner
ServiceNow API Task	Automation Anywhere\Bots\Sample bots\API Task demos...	apitaskrunner

### Concurrency management

API Task licenses govern the maximum number of API devices that can execute concurrently, ensuring optimal resource allocation and preventing performance bottlenecks.

Configure API Task concurrency to align with your specific workload and workflow patterns:

- Navigate to **Administration > Settings > Cloud device management**.
- Click **Edit** to increase or decrease the concurrency limits of API Tasks within forms or processes.
- Use the plus (+) or minus (-) sign to modify concurrency limits accordingly.
- Click **Save changes**.



## API Tasks in Forms

After checking in an API Task, an admin must add it to the cloud to enable testing or use within Automation Co-Pilot. To add API Tasks:

1. Within **API Tasks in Forms**, hover over the plus sign and click **Add API Task allocation**.
2. In the **Find an API Task**, click **Browse** to locate and select the desired API Task.

## Audit log settings FAQ

Answers to frequently asked questions (FAQ) and related information provide insight into various aspects related to Control Room settings.

Do all Automation 360 deployments support retention of audit logs?

The option to retain audit logs is available only on On-Premises deployments. For Automation 360 Cloud Data Retention Policy, see [Automation 360 Cloud FAQ](#) on page 1058.

Which all Automation 360 releases support audit log retention?

The **Audit log retention** option is available starting from the Automation 360 v.30 release.

Is audit log retention enabled when I update to the On-Premises release v.30 release or later?

The **Audit log retention** option is disabled (**Do not purge**) when you update to On-Premises release v.30 release or later. You can enable this option if required.

See [Settings](#) on page 1789.

Is audit log retention enabled when I install a new version of the On-Premises release v.30 release or later?

Audit log retention is enabled (**Purge older than 15 months**) when you install a new version of the On-Premises release v.30 release or later. You can disable audit log retention if required.

See [Settings](#) on page 1789.

How does audit log retention work?

- When the option is enabled, all audit log entries are retained for a period of 15 months (5 quarters).  
After 15 months, all the entries are deleted.
- When the option is disabled, all audit log entries are retained.

If the audit log retention option is enabled and if I later disable this option, what happens to audit log entries?

Audit log entries are not deleted from the time you disabled the retention option.

Can I change the duration for retaining audit log entries?

No, the duration cannot be changed. When the option is enabled, audit log entries older than 15 months are deleted.

How frequently are the audit log entries deleted?	Audit log entries older than 15 months (5 quarters) are deleted once every week (168 hours).
Are the audit log entries deleted immediately after the retention option is enabled?	Audit log entries are not deleted immediately. Audit logs that are older than 15 months are deleted after a week (168 hours) from the time the option was enabled. Subsequently, the deletion process is run every week.
Will I be able to recover the deleted audit log entries?	No, you cannot recover audit log entries that are deleted.
If there is a significant number of audit log entries, will they all be deleted?	Irrespective of the number or quantity of audit log entries, all entries older than 15 months (5 quarters) are deleted.
Will there be any impact if my configuration includes security information and event management (SIEM)?	<ul style="list-style-type: none"><li>• If your SIEM implementation stores the audit logs on a separate server for data analysis, then there is no impact on the behavior.</li><li>• If your SIEM implementation reads the data directly from the Control Room and if the <b>Audit log retention</b> option is enabled, audit logs that are older than 15 months are not considered in SIEM because such audit logs are deleted.</li></ul>
Will there be any impact if my setup has an audit log server integration?	As long as you store audit logs on your audit log server, there is no change in the behavior.

## Edit My settings

The **My settings** page provides user profile specific information.

### My profile

Each RPA user is required to have an active profile in the Control Room to built, run and schedule the deployment of bots as well as for security authorization. Profile information includes user names, email addresses, passwords, and so on.

To access this information, click the **My Settings** navigation tab.

The **My Settings** page displays an expandable **My profile** tab that shows specific and configurable user details. Click the **Edit** icon to update this profile information.

Related tasks

[Edit profile settings](#) on page 1859

Update your user profile settings in the Control Room.

## Edit profile settings

Update your user profile settings in the Control Room.

Ensure that you are logged in to the as the administrator.

Each RPA user is required to have an active profile in the Control Room to built, run and schedule the deployment of bots as well as for security authorization. Profile information includes user names, email addresses, passwords, and so on.

**1. Navigate to **My Settings**.**

The **My Settings** page displays the expandable **My profile** tab for specific and configurable user details. Click the **Edit** icon to update this profile information.

**2. Update any or all of the general details for your profile.**

Option	Description
First name	Maximum character length is 50.
Last name	Maximum character length is 50.
Contact email	Maximum character length is 255.
Change password	8-15 characters: a-z (lowercase), A-Z (uppercase), 0-9, and the following special characters are allowed: @, -, _, !, #, \$, %, ,, and &

**3. Click **Save changes**.**

## Set up your bot repository

Administrators create repositories for Bot Creators to develop and build bots .

Ensure that you are logged in to the as the administrator.

Administrators create repositories for Bot Creators to develop , test, and debug bots. After configuring the repository, the administrator creates the role for the Bot Creator.

**1. Log in to the as the administrator.**

**2. On the left pane, click **Automation**.**

**3. Click **Create subfolder**.**

**4. Provide the repository folder name and navigation path.**

This repository folder is where the bots created by Bot Creators will be stored.

---

**Important:** Based on limits requirement in the Windows operating system (primarily Windows Server 2019 and 2016), ensure your folder, file names, and the nested folder structure is not long; otherwise, your bot execution or repository backup can be impacted.

---

**5. Click **Create folder**.**

Create roles for users. Roles grant specific permissions to users, such as Bot Creators and Bot Runners.

## Working with repositories, credentials and roles

Control room administrators configure repositories for Bot Creators to develop RPA bots. Administrators create roles, assign users, and grants permission to action packages used in creating bots.

This topic is intended for experienced Automation Anywhere Automation 360 users.

### Administrator tasks

Control room administrators setup repositories for Bot Creators to develop bots. For this process, administrators create users and assign these users specific roles, such as Bot Creators or Bot Runners. Bot Creators are granted access to specific RPA action packages to create, test, and run bots. Completed bots are transferred to the public repository for other users to deploy. The following is a breakdown of control room administrator related tasks to complete this process.

[Set up your bot repository](#) on page 1859

Administrators create repositories for Bot Creators to develop , test, and debug bots. After configuring the repository, the administrator creates the role for the Bot Creator.

[Assign a role](#) on page 1767

Roles grant specific permissions to users, such as Bot Creators and Bot Runners.

[Create your users and assign their licensed roles](#) on page 1787

Create or otherwise edit the user information to assign the licensed role for accessing repositories, packages, and bot building tools and functionality.

[Add packages to the Control Room](#) on page 1908

Administrators can add packages to the Control Room for use by Bot Creators.

[Set up lockers and credentials in Credential Vault](#) on page 1862

The credentials assigned are typically those where the administrator is granting some internal, business-related access to a Bot Creator or Bot Runner for RPA development, for example to a Salesforce account.

### Bot Creator task

Bot Creators often require access to protected data to automate a process. Each Bot Creator is given credentials governing the data they are permitted to access. The administrator creates the credential and assigns it to individual users by configuring specific roles for the Bot Creator to access those credentials. Bot Creators must add their own specific attributes to the credentials after they have been assigned by the administrator.

## Manage user credentials

Bot Creators and Bot Runners rely on credentials to access necessary data relevant to the bot building process.

This task is performed by the user who wants to build and deploy . You must have the necessary rights and permissions to complete this task, and authorization to log in to the as the licensed user.

Bot Creators often require access to protected data to automate a process. Each Bot Creator is given credentials governing the data they are permitted to access.

---

**Note:** Administrators are required to have created the necessary roles and entitlements assigned to the user in order to update and use any granted permissions.

---

1. Navigate to **Manage > Credentials**.
2. From the list of credentials, select the one you want to manage, and click **Edit**.  
The configurable fields for the credential are displayed, based on the user granted permissions.  
For example, a bot is built that requires the authentication username and password to log in to a specific URL. The user will create a custom credential for this operation by amending the credential governed by the administrator, adding the additional security details. This way, the Bot Creator can authorize only that protected data deemed necessary for the automation.
3. Click **Save changes**.

## Credentials and lockers in the Credential Vault

The Credential Vault securely stores sensitive information such as passwords, account numbers, and social security numbers in credentials and lockers for use in automation tasks. It facilitates role-based access for users of a Control Room and ensures that sensitive values are not stored in bots or on devices.

The Credential Vault consists of two main features: credentials and lockers.

Best Practices:

- Each credential should contain a single password used for authentication to a specific system.
- The credential may have additional attributes such as user name or hostname depending upon what is required in the authentication process that the credential is used for.
- Credentials for applications that process data which requires the highest confidentiality have the least number of consumers where credentials for applications that require lower confidentiality can have a higher number of consumers. Segregate credentials based on applications and data confidentiality.
- Lockers are created to hold credentials that are related to a specific business purpose or class of application based on confidentiality.

Credentials

A credential holds the sensitive information in attributes. An attribute can have a value that is standard for all users or it can accept a user-input value. For example, an `Email` credential can hold three attributes: `host` `name` (standard

## Lockers

value), `username` (user input), and `password` (user input).

By default, all users can create, manage, and use their own credentials. A user is granted access to another user's credentials by receiving access to a locker that holds the credential. If the credential requires a user-input value, it appears in the **CREDENTIAL REQUESTS** tab.

A credential must be assigned to a locker to be used for building and running a bot.

A locker specifies which users can view, modify, or access the credentials. For example, a human resources (HR) locker can hold `Email`, `Database`, and `Training website` credentials and allow only specific employees of the HR department to use the credentials in their bots.

A user with either the `AAE_Locker Admin` role or a user-created role with the **Manage my credentials and lockers** permission configures lockers, adds credentials, and grants access to other users.

## Benefits of using the Credential Vault

Apart from providing a secure and centralized location for storing credentials, using the Credential Vault also:

- Minimizes credential fraud.
- Provides an environment to enable improved security.
- Enables businesses to adhere to the processes and credential management compliance standards.
- Offers increased automation opportunities with secure data applications.

Related concepts

[RBAC for Credential Vault credentials management](#) on page 1037

Credentials created in the Control Room are used across Bot Creators and Bot Runners.

[Configure Credential Vault Connection mode](#) on page 1813

Credential Vault is a centralized location for securely storing credential information used by bots.

## Set up lockers and credentials in Credential Vault

Assign credentials to lockers for Bot Creators to access during the bot building process.

Ensure that you are logged in to the `as` as the administrator.

The credentials assigned are typically those where the administrator is granting some internal, business-related access to a Bot Creator or Bot Runner for RPA development, for example to a Salesforce account.

**Note:** Credential and attribute names are not case-sensitive and are stored as "lower-case".

1. Navigate to **Manage > Credentials**.
2. Click **Create credential**.
3. Enter the **Credential name** and a **Description** for the configured credential or select **External key vault**.  
If integrating with an external key vault, then proceed to [Select External key vault](#) .
4. Enter the **Attribute name** and supply the **Description** for the attribute.
5. Select one of the following **Input** options:

Input	Value
Standard	Enter the value. All users see the same credential value set by the credential owner.
User-provided	The value field is not available because the values are not preset during creation. Only users of the locker containing this credential can provide the value.

6. Set **Security** for the attribute.

**Note:** When the **Masked** option is selected, the attribute value is hidden for security purpose.

7. Click **Create credential**.
8. Click the **MY LOCKERS** tab.
9. Click **Create locker**.
10. Enter the **Name**.
11. Optional: Enter a description.
12. Click **Create locker**.

## Set up locker and assign credentials

Create a role, credentials, and locker to share related sensitive values with a group of users, so they can use those values to build or run bots.

Do the following to set up the locker and assign credentials:

1. [Create a role](#) on page 1748  
Define a role and assign permissions to access various features for building bots.

**Note:** You must have the **AAE\_Admin** role or the **Manage roles** permission to create a role and assign it to users.

2. [Create credential](#) on page 1864  
Create a credential and add the required attributes.

**Note:** You must have the **Manage my credentials and lockers** and **Create standard attributes for a credential** permission to create a credential and attributes.

3. [Create locker](#) on page 1866  
Create a locker to group similar credentials and share with other users.

---

**Note:** You must have the **AAE\_Locker Admin** role or the **Manage my credentials and lockers** permission to create a locker and assign users and roles to it.

---

Related concepts

[RBAC for Credential Vault credentials management](#) on page 1037

Credentials created in the Control Room are used across Bot Creators and Bot Runners.

Related tasks

[Edit a credential](#) on page 1865

Modify credential details and add or remove attributes.

[Edit a locker](#) on page 1868

Add or remove credentials, owners, managers, participants, or consumer roles.

## Create credential

Create a credential and add the required attributes.

This task is performed by the Automation Anywhere Control Room administrator. You must have the necessary rights and permissions to complete this task. Ensure you are logged in to the Control Room as the administrator, or a user with either the **AAE\_Locker Admin** role, or a user-created role with the **Manage my credentials and lockers** permission to configure lockers, add credentials, and grants access to other users.

Assign the credential when adding the credential details. If no locker was created, create a locker and then assign the credential. Add up to 50 attributes to a credential.

1. Log in to the Control Room as the administrator.
2. Navigate to **Manage > Credentials** and click **Create credential**.
3. Enter the **Credential name** and a **Description** for the configured credential or select **External key vault**.

If integrating with an external key vault, then proceed to [Select External key vault](#).

4. Enter the **Attribute name** and supply the **Description** for the attribute.
5. Select **External key vault**.

If integrating with an external key vault, such as AWS, Microsoft Azure, CyberArk, or HashiCorp, enter the required credentials for the specified external vault as follows:

AWS

Enter the secret name.

CyberArk

Enter the object name.

---

**Note:** Optionally, you can add attributes and enter property set using CyberArk properties to use in your automation.

The following examples show how to create property sets in different scenarios:

- If you want to use a username in the format `domain\username` where the domain is stored in the CyberArk property called **Address** and the username is stored in the CyberArk property called



**UserName**, then enter the property set in the format `$$Address$$\$$UserName$$` in the credential attribute and use this attribute in your automation.

- If you want to use a username in the format `username@example.com` where the username is stored in the CyberArk property called **UserName** and the address (`example.com`) is stored in the CyberArk property called **Address**, then enter the property set in the format `$$UserName$$@$$Address$$` in the credential attribute and use this attribute in your automation.

Microsoft Azure

Enter the secret name.

HashiCorp

Enter the HashiCorp secret name.

6. Select one of the following **Input** options:

Input	Value
Standard	Enter the value. All users see the same credential value set by the credential owner.
User-provided	The value field is not available because the values are not preset during creation. Only users of the locker containing this credential can provide the value.

7. Set **Security** for the attribute.

**Note:** When the **Masked** option is selected, the attribute value is hidden for security purpose.

8. Optional: Select **Use attribute ONLY on Password or Masked fields**.

This option ensures that bots input the attribute value only into fields that are identified as password fields.

**Note:** When this option is selected, an attribute is available only for the commands in Automation Anywhere Enterprise client that support credential variables and where the fields are of **Password** type.

9. Click **Create credential**.

Assign this credential to a locker.

## Edit a credential

Modify credential details and add or remove attributes.

A credential can be edited by the owner when the credential is not assigned to a locker. If a credential input type is user-provided, then locker consumers can edit the credential to input a value.

[Role-based access and locker permissions](#)

**Note:** A user with the **AAE\_Locker Admin** role can assign a credential to a new owner. For more information, see [Transfer credential ownership](#) on page 1866.

---

1. Navigate to **Manage > Credentials**.
2. Hover over the **Actions** icon for the credential.
3. Click the **Edit** icon. 
4. Edit the credential.

If the email notification setting is enabled and credentials are added to a locker, then all the locker consumers receive an email.

The maximum limit of credential attributes that is allowed is 50. If you have upgraded to the current version and have migrated credentials that have more than 50 attributes, when editing that particular credential, the following message displays: `Credentials can only have a maximum of 50 attributes`. To continue, remove the additional attributes that cannot be saved and add those to a new credential.

5. Click **Save changes**.

Related reference

[Credential Vault email notifications](#) on page 1869

When the email notification setting is enabled, it ensures that users are notified of any changes to credentials and lockers.

## Transfer credential ownership

A user with the **AAE\_Locker Admin** role can transfer a credential to a different owner.

A credential can only be reassigned to a different owner if it is in a locker. The new owner can be either the locker owner, manager, or participant.

1. Navigate to **Manage > Credentials**.
2. Use the search bar to find the credential.
3. Hover over the vertical ellipses to the right of the credential.  
The actions menu opens.
4. Click **Transfer credential ownership**.  
A list of users with access to the locker appears.
5. Select the new credential owner.
6. Click **Yes, submit**.

## Create locker

Create a locker to group similar credentials to share with other users.

You must either have the `AAE_Locker Admin` role or **Manage my credentials and lockers** permission and the necessary permission to View Users and Roles.

---

**Note:**

- You must have the View Users and Roles basic information permission to view information about other users to add them as locker owners/Managers/participants. Without this permission, an "Access denied" error will occur.

See [RBAC for Credential Vault credentials management](#) on page 1037

- Ensure that you do not use a locker name starting with `oauth_` (case insensitive, for example, `OAuth_`, `oAuth_`, and so on) as it is a reserved namespace.

There is no limit on the number of credentials that can be stored in a locker. A credential can only belong to one locker. See [Create credential](#) on page 1864. Credentials are further divided in logical groups called lockers.

To create a locker, follow these steps:

1. Navigate to **Manage > Credentials**, and then click the **Lockers** tab.
2. Click **Create locker**.
3. Enter the **Name**.
4. Optional: Enter a description.
5. Select the **Credentials** to add to the locker or select **External key vault**.
6. Enter **External key vault** credentials.

If integrating with an external key vault, such as AWS, Azure, CyberArk, or HashiCorp, enter the required credentials for the specified external locker:

AWS

Enter the prefix of secrets stored in the locker.

CyberArk

Enter the safe name where the credential lockers are stored and optionally enter the property set to your CyberArk username. The `$$attribute$$` property is used to retrieve information from the CyberArk object property. You can create a property set by combining multiple CyberArk object properties.

The following examples show how to create property sets in different scenarios:

- If you want to use a username in the format `domain\username` where the domain is stored in the CyberArk property called **Address**, and the username is stored in the CyberArk property called **UserName**, then enter the property set in the format `$$Address$$\$$UserName$$` in the credential attribute and use this attribute in your bot automation.
- If you want to use a username in the format `username@example.com` where the username is stored in the CyberArk property called **UserName** and the address (`example.com`) is stored in the CyberArk property called **Address**, then enter the property set in the format `$$UserName$$@$$Address$$` in the

credential attribute and use this attribute in your bot automation.

Azure

Enter the prefix stored in the locker.

HashiCorp

Enter the prefix of secrets stored in the locker. For example, enter the prefix `prfusr1` for secret that is stored as `prfusr1_obj1_usr1`.

7. Click **Next**.

8. Add the **Owners**.

A locker must have at least one owner. The locker owner can edit, view, and delete a locker and also add or remove other owners.

9. Click **Next**.

10. Optional: Add the **Managers** and click **Next**.

The locker manager can view, edit and delete the locker, and add participants but cannot add owners or managers to the locker.

11. Optional: Add the **Participants** and click **Next**.

A locker participant has access to view a locker and add their own credentials to a locker.

---

**Note:** A **locker participant** does not have access to or visibility of credentials created by other users.

---

12. Add the **Consumers**.

Select one or more roles. Users with these roles have access to the locker. System-created roles are not shown in the **Consumers** list.

Type	Permission
Standard	Locker consumers can view the locker and all the credentials inside the locker. All consumers see the same credential value set by the credential owner.
User-provided	Locker consumers can input their information in user-provided credentials with user-provided attributes.

13. Click **Create locker**.

If the email notification setting is enabled, users receive an email confirming the locker name and their permissions to that locker.

## Edit a locker

Add or remove credentials, owners, managers, participants, or consumer roles.

Only a locker owner, locker manager, or locker admin can edit a locker. To edit a locker, follow the steps mentioned below:

---

**Note:** Credential, owner, managers, participants, and consumers are separate entities associated with the locker to grant permission. These are not locker entity attributes and modifying these

does not change locker objects. Therefore when you edit these fields inside a locker, the locker object is not modified and thereby locker's last modified field is also not updated.

1. Navigate to **Manage > Credentials**, and then click the **Lockers** tab.
2. Hover over the **Actions** icon for the locker.
3. Click the **Edit** icon. 
4. You can make changes to the following:

Option	Description
Credentials	Add or remove credentials that are assigned to a locker.
Owners	Add or remove locker owners.  <b>Note:</b> A locker must have at least one owner.
Managers	Add or remove locker managers.
Participants	Add or remove locker participants.
Consumers	Add or remove locker consumers.

If email notification setting is enabled and credentials are added to a locker, then all the locker consumers will receive an email.

5. Click **Save changes**.

## Credential Vault email notifications

When the email notification setting is enabled, it ensures that users are notified of any changes to credentials and lockers.

### Overview

Email notifications are sent for the following scenarios:

Credential is added to a locker	When credential is added to a locker, a notification is sent to all consumers of the locker to their email address registered in the Control Room. The email consists of a link to the credential that is added to the locker. The consumers are redirected to edit the credential page wherein they input the credential value.
Member is added or removed from a locker	An email notification is sent when a new member (co-owner or participant) is added to a locker or removed from the locker as a member of participant.
Change in permission for locker members	When a locker owner/admin grants or removes locker membership permissions from a locker, an email notification is sent to the locker

Locker consumer gets added or removed from a role assigned to a locker, or consumer role gets added or removed from a locker

members at their email address. This ensures that members are notified of their membership changes within the locker.

When a role assigned to a locker is modified by addition or removal of users, an email notification is sent to the new or existing user at their email address so that the consumers are notified that credentials are pending for their input in the locker.

Also when a new role added to a locker or an existing role is revoked from the locker, an email notification is sent to the new or existing consumers at their email address so that the consumers are made aware of the changes.

# Manage Automation 360

As a Control Room administrator, create users and roles, and configure devices that access Automation 360. From the Control Room, you can also monitor and manage all activities to ensure a secure and seamless bot execution environment for your users.

## Activity and audit log

Monitor and manage automations, such as bot execution, scheduled and event trigger activities using the Activity console (**Activity** from the left menu). You can also review and troubleshoot any failed activities using the Audit log console (**Administration > Audit log**).

See the following pages for more information:

- [Historical activity](#) on page 2123
- [Scheduled activities](#) on page 2129
- [Event triggers](#) on page 2139
- [Audit log](#) on page 2143

The following short video shows how to check your bot runs:

## Users, roles, and permissions

You can configure users and roles (role-based access control or RBAC) to provide access to specific features and operations, based on their assigned roles. Creating users depends on whether the user is a non-Active Directory, Active Directory, or single sign-on (SSO) user from an IdP server.

- [Users](#) on page 1737
- [Roles](#) on page 1748
  - [Feature permissions for a role](#) on page 1749
  - [Bot permissions for a role](#) on page 1763
- [Credentials and lockers in the Credential Vault](#) on page 1861

## Devices and queues

A device is the machine through which a user connects to the Control Room to create or run bots. Manage devices that are registered to the Control Room from **Manage > Devices**.

A queue is a logical group of Work Items that are processed for automation by the Bot Runners from a pool based on priority selected in the device pool and sort criteria configured in the queue.

- [Devices](#) on page 1873
- [Workload management](#) on page 1996
- [Device pools](#)
- [Add queue, Bot Runner, and device pool](#) on page 1888

## Settings

After initial setup of the Control Room, you (as an administrator) might have to set up and edit some of the initial configurations to enable certain features. Go to **Administration > Settings** to configure and edit settings for bots, packages, devices, email, network, user authentication, security, Git repository, external key vault and so on.

The following image shows some of these

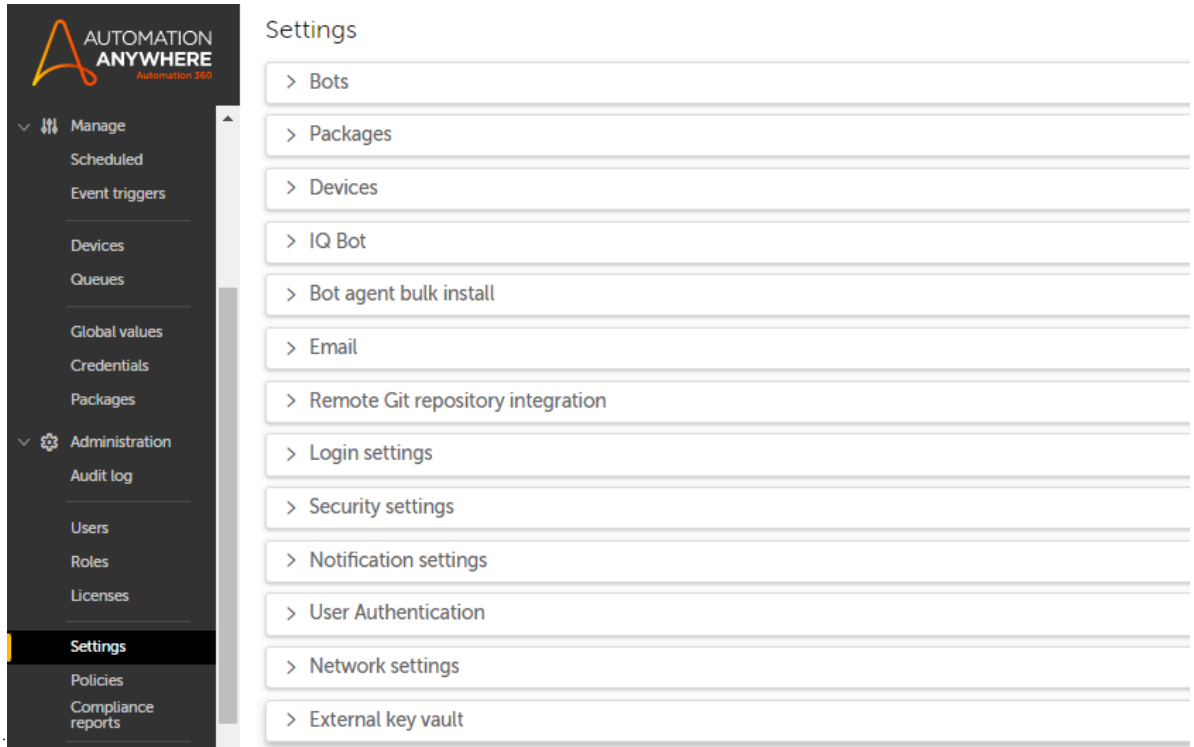

settings:

See [Settings](#) on page 1789.

## See also

See the following pages for information on other features and settings:

- [Bot Lifecycle Management](#) on page 2030
- [Code analysis](#) on page 2178
- [CoE Manager](#) on page 2047
- [Bot Store](#) on page 3607

### Related tasks

[Schedule a bot](#) on page 2129

Schedule a bot to run at a specific time.

[Set up locker and assign credentials](#) on page 1863

Create a role, credentials, and locker to share related sensitive values with a group of users, so they can use those values to build or run bots.

[Create a role](#) on page 1748



As an administrator, you can configure roles with permissions to access features and perform operations such as create, edit, or delete a bot in the Control Room, and assign the role to a user.

[Create a user](#) on page 1739

Create a user and assign their specific license based role.

[Set user device credentials](#) on page 1353

To enable a device for running bots, set the local device credentials.

[Edit profile](#) on page 1397

Manage user profiles.

[Installing additional licenses](#) on page 1786

Upload new licenses to the Automation Anywhere Control Room to be distributed to users as required.

## Devices

The device is a machine through which a user connects to the Control Room to create or run bots. Manage devices that are registered to the Control Room through the **Devices** page located in the **Manage** tab.

### Tasks performed from the Devices page

As a Control Room user with Bot Runner, Bot Creator, and Device pools privileges, use the **Devices** page to perform the following actions:

- View a list of devices registered and connected to the current instance of the Control Room.
- Create and view a list of device pools available from the current instance of the Control Room.
- Run bots immediately on selected Bot Runners.

If the device is already registered by another user other than the Bot Creator and the Bot Creator does not have the `Register` device permission or the associated device assigned to it, when you run a bot from the bot editor window, the deployment fails with an `insufficient permission` error message.

- Schedule bots to run on selected Bot Runners.
- Run bots on selected device pools.

---

#### Note:

- Only an admin user has access to view all the devices in the Control Room. A non-admin user does not have access to view Bot Creators.
- Only one Bot Creator can be logged in to a device to run bots at any one time. For a new user as a Bot Creator on the same device, the first Bot Creator has to be removed.

---

## Devices

The **Devices** page lists all configured devices and the current state for each device listed. Devices are identified by IP and hostname. A device can be in one of the following states:

Connected

Device is logged in to the Control Room.

**Note:** Wait for 35 seconds for a device to show as connected in the devices list after you remove and re-register the device.

---

Disconnected

Device is not logged in to the Control Room.

Offline

Device has been unregistered or disabled by the Control Room administrator.

The following actions are enabled:

Connect local device

Install Bot Agent on your local device and connect it to Control Room. In order to run bots on that local device, ensure that you add it to the list of enabled host devices.

Run bot now with checked items

Runs the bot on selected device.

Export checked items to CSV

Exports the data to a CSV file based on:

- Filters
- Selection

Refresh table

Refreshes the table contents to view the updated status.

Customize columns

Show or hide specific columns.

View and edit device

With the **View and manage ALL device(s)** permission, you can view and edit the following device settings:

- Name
- Status
- Bot Agent version
- Device pool name
- Nickname (optional)
- Description
- Device type (single user or multiple users)

In case of a multi-user device, you can edit the **Concurrent sessions supported** field.

- Add or edit device permissions
- Screen resolution

You can set the screen resolution by either selecting a value from the predefined resolution drop-down list or by selecting custom and entering the values.

- You can edit only the nickname, description, device type, and screen resolution fields.
- Ensure that you have selected the **Allow devices to override resolution settings**

option in the Control Room settings for the device level resolution to take effect.

---

**Note:** The screen resolution settings are applicable only when you use RDP-based deployments. For regular deployments, a Windows session is created using the existing resolution settings of the device. In this case, the screen resolution set in the Control Room is ignored.

---

- Lifespan

Device lifespan can be **Persistent** or **Temporary**. Temporary devices are created to support non-persistent virtual desktop infrastructure (VDI) and are automatically deleted after a specified time when the device is disconnected from the Control Room. You can specify the time to automatically delete temporary devices in the Control Room devices settings.

Persistent devices are created to support persistent virtual desktop infrastructure (VDI) and are not deleted after the device is disconnected from the Control Room.

---

**Note:** Non-persistent desktops are stateless desktops that get destroyed at the end of the session. Non-persistent VDIs do not exist when the user logs out.

---

- Auto-login settings

You can customize the auto-login settings for each device. Choose between the settings configured in the Control Room or at the selected device level to either create new user sessions or use existing user sessions after a bot finishes running.

- Installation type

This setting is based on whether the Bot Agent is installed at user level or system level on the user device.

- Deployment type

This setting is based on the user type and installation type. For single users installed at the system level, the default deployment type is regular. For multi-users installed at system level, the default deployment is RDP.

Preload packages

Use preloaded packages to download the most commonly used or customized packages

on your local device. As the packages are saved offline on your device, when you run a bot, the system skips the package download process and starts executing the bot, thereby reducing the bot execution time. You can download specific versions of the package to the user device folder `C:\ProgramData\AutomationAnywhere\AAPreloadedPackages`.

## Device pools

Device pools provide a logical grouping of similar Bot Runners to run bots with the work items from a queue. For example, group devices of a particular department or unit and create a device pool for it.

Related tasks

[Install Bot Agent and register device](#) on page 1347

Install Bot Agent on your local device and connect it to Control Room. In order to run bots on that local device, ensure that you add it to the list of enabled host devices.

[Set user device credentials](#) on page 1353

To enable a device for running bots, set the local device credentials.

[Configure auto-login settings](#) on page 1804

Configure auto-login settings in the Control Room to either create user sessions or reuse existing user sessions to reduce the bot startup time.

## About multi-user devices

A multi-user device is any Windows terminal server device (Windows 2019, Windows 2016, Windows 2012, Windows 10 Enterprise on Azure) which enables multiple users to concurrently log in to a single device.

The multi-user device server enables multiple users to access the same operating system and share the hardware, performing the tasks for each user concurrently. In multi-user devices, bots are deployed using RDP.

### Benefits of a multi-user device

A multi-user device ensure that each machine in an organization is fully used, reducing the hardware and software cost by enabling different users to access the same device. Bot Creator users and Bot Runner (attended or unattended) users can be configured on a multi-user device. The multi-user device also provides security and authentication for every user. Each user is assigned unique login credentials for the device and can access only the assigned applications and device settings.

---

**Note:** In a multi-user device, if two user sessions with the same device credentials try to deploy a bot, the deployment will fail for one of the user sessions. An appropriate failure message is recorded in the audit log.

---

## Multi-user device in a device pool

A multi-user device can be part of a device pool and the device can be set as the default device for Bot Creator users and Bot Runner (attended and unattended ) users.

### Set as default device

As a licensed user, when you log in to a non-default device, you can set that device as your default device. You must have the **View and manage ALL device(s)** permission if you want to set another device that is not registered by you as your default device: To set it as the default device, follow these steps:

1. Click the device icon on the top-right of your screen.
2. Select the **Make default device** option from the menu.

If you do not have the necessary permission, a message prompt appears, stating that you will lose access to your current default device.

Related concepts

[Bot Agent device requirements](#) on page 1340

Review the Bot Agent device requirements such as hardware components, compatible devices, supported operating systems and browser extensions.

## Configure RDP-based deployment for multi-user devices

RDP-based deployment is used for multi-user devices. When a bot is deployed for an unattended Bot Runner from the Control Room, the Control Room handles the unattended Bot Runner session through RDP and executes the bot.

Ensure that you are logged in to the Control Room as the administrator.

Ensure the following requirements are completed:

- Active Directory Domain Services are set up (Optional).
- Remote Desktop Services (RDS) are set up on the machine ready to host multiple (RDS) bot runner sessions (Mandatory).
- Active Directory/Local users are created (Mandatory).
- Users are provided access to RDS (Mandatory).

When registering your device, you can register it as a multi-user device.

1. Change device type to multiple users.
  - a) Navigate to **Manage > Devices**.
  - b) Hover over the actions menu (three vertical ellipses) located to the right of the device name and click the **Edit device** icon.
  - c) Under **Deployment** tab, change the **Device type** to **Multiple users**.
  - d) Enter a value for the **Concurrent sessions supported** field.

The maximum number of allowed concurrent sessions depends on your device license type and the hardware configuration. For example, consider that concurrent sessions is set to 10 and each bot requires 4 GB RAM for execution. If your system RAM is lower than this value, the bot execution might fail.

Also, if the maximum number of sessions allowed in your device is 10 and the multi-user device is set as the default device for 3 Bot Creator users and 2 attended Bot Runner users, then the value for the concurrent sessions supported will be 5. Therefore, at a time, only 5 bots can be deployed concurrently by the unattended Bot Runner users. So ensure that your hardware and device license type support the number of sessions you set.

e) Click **Save changes**.

2. Set the RDP screen resolution.

This ensures your automation runs seamlessly during RDP-based deployment, even if the resolution of the screen varies between the Bot Runner and Control Room.

You can set it in the following ways:

- At the Control Room level: [Configure screen resolution for a device session](#) on page 1801.
- At the device level: [Devices](#) on page 1873.

Note that you can update the screen resolution at device level only if the option to override screen resolution is enabled in **Administration > Settings > Devices**.

3. Configure the RDP settings.

a) Select **Devices** option from **Administration > Settings**.

b) Edit the **RDP settings for multiple user devices** field.

c) Enter the **Port**.

---

**Note:** Use the default port 3389 for RDP-based bot deployments.

---

d) Enter the **RDP session timeout** value.

The default session timeout value is 60.

e) Click **Save changes**.

4. By default clipboard data is shared across RDP sessions. Follow the below steps to prevent sharing of clipboard data across multi-user RDP sessions:

a) Select **Devices** option from **Administration > Settings**.

b) Edit the **Advanced options** field.

c) In the **RDP command options** field, enter `-clipboard`.

d) Click **Save changes**.

For more information about troubleshooting black screen and lock screen images, see

- [Black screenshot while running the bot in unattended mode \(A-People login required\)](#)
- [Black screen and lock screen images being captured \(A-People login required\)](#)

1. Create users in the Control Room.

These users can be unattended Bot Runners, Attended Bot Runners, or Bot Creators. You can select the multi-user option when you register the device for the first time. See [Create a user](#) on page 1739.

2. Associate the correct device and session login credentials based on the Active Directory users that you create before configuring the multi-user device settings.

You can register an Active Directory user one time as an admin user and the sessions are created when you deploy bots. You do not have to create an RDP session on the Bot Runners server and register the device under an Active Directory user name and user credentials.

3. Deploy the bots on parallel sessions.

---

**Note:** If the multi-user device per sessions count provided is less than the actual bot deployment, then the additional bot deployments are queued until the current deployments are in progress.

---

## Configure legal disclaimer timeout for RDP-based deployment

Changing the default value for the legal disclaimer screen timeout enables the RDP-based deployment session to retry device access. You must configure the `rdp.legal.disclaimer.max.attempts` settings to change the default value.

Any user who has access to the device where the Bot Agent is installed can configure the `rdp.legal.disclaimer.max.attempts` settings and change the timeout value of the legal disclaimer screen.

1. Navigate to `C:\Program Files\Automation Anywhere\Bot Agent\config`.
2. Edit the `nodemanager.properties` file.
3. Set the `rdp.legal.disclaimer.max.attempts` settings value to 20.
4. Save the file and restart the Bot Agent service.

## Convert an existing device to a multi-user device

If you have a server OS, multi-user OS, or hosted VMs such as AWS, Microsoft Azure, or VMware as the Bot Runner machine, you can convert your existing device to a multi-user device.

Ensure that you are logged in to the as the administrator.

Converting a device enables you to share the same device between Bot Runner and Bot Creator users because they can coexist in different sessions simultaneously. Also, multiple parallel executions of a bot can be performed on the same machine.

If you encounter Auto Login issues because multiple users are sharing the device or because it is a remote device, convert your device to a multi-user device.

If you have a single-user device and want to use multi-user or terminal server deployment, then set the **device type** as **Multiple users**.

1. Navigate to **Manage > Devices**.
2. Hover over the actions menu (three vertical ellipses) located to the right of the device name and click the **Edit device** icon.
3. Under **Deployment** tab, change the **Device type** to **Multiple users**.
4. Enter a value for the **Concurrent sessions supported** field.

The maximum number of allowed concurrent sessions depends on your device license type and the hardware configuration. For example, consider that concurrent sessions is set to 10 and each bot requires 4 GB RAM for execution. If your system RAM is lower than this value, the bot execution might fail.

Also, if the maximum number of sessions allowed in your device is 10 and the multi-user device is set as the default device for 3 Bot Creator users and 2 attended Bot Runner users,

then the value for the concurrent sessions supported will be 5. Therefore, at a time, only 5 bots can be deployed concurrently by the unattended Bot Runner users. So ensure that your hardware and device license type support the number of sessions you set.

5. Click **Save changes**.

## Edit multiple devices simultaneously

You can edit multiple devices (or bulk edit devices) to change the settings across these devices at the same time.

Editing multiple devices is supported only for On-Premises Bot Runner devices (Virtual Machines or local devices created by users). However, the Cloud Bot Runner devices are not supported.

You must be a Control Room administrator or a user with **View and manage all devices** role to be able to perform this task.

1. Log in to the Control Room.
2. Click **Manage > Devices**.  
A list of all the available devices in the Control Room is displayed.
3. Select the **Check all** check box at the top of the list to select all the devices and click the **Edit checked items** icon (as shown in the following image).

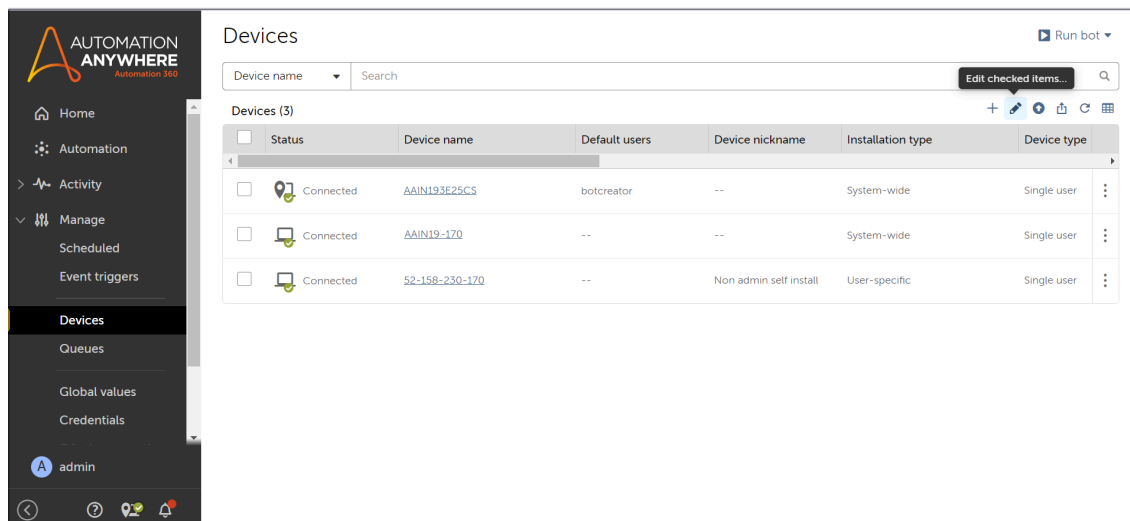

4. Use any of the following tabs to change these settings:
  - **Devices**  
Enables you to select the devices that you want to edit.
  - **Device registration configuration**  
Enables you to change the registration configuration of the registered devices. Use the **Device type** field to select the **Enable device registration configuration** check box to change the default setting.  
  
Changing the default device registration configuration settings is not supported on registered devices where the **Installation type** is **User-specific**. If you select the **Enable device registration configuration** check box for user-specific device, a warning message is displayed.



- **Single user:** This is the default setting and enables only a single user session on the device.

Use the **Deployment type** field to select one of the following options:

- **Remote Desktop Protocol:** If your registered local device is a laptop or a desktop that does not support Remote Desktop Protocol (RDP), your bot execution will fail as RDP is not supported on local device. This is applicable to the **Device type > Multiple users** as well since the multiple users are not supported on local devices.
- **Regular:** Is the default setting.
- **Multiple users:** Enables multiple users to concurrently log in to a single device.  
Enter the number of sessions in the **Concurrent sessions** field. The maximum number of allowed concurrent user sessions depends on your device license type and the hardware configuration. For example, if your device license permits 4 users, you can have up to 4 concurrent user sessions, and each session will require a minimum of 4-GB RAM for execution. If your system RAM is lower than this value, bot execution might fail.
- Use the **Lifespan** field to select the **Enable Lifespan configuration** and choose of the following options:
  - **Persistent:** This is the default setting. The devices are created to support persistent virtual desktop infrastructure (VDI) and are not deleted after the device is disconnected from the Control Room.
  - **Temporary:** Devices are created to support non-persistent virtual desktop infrastructure (VDI) and are automatically deleted after a specified time when the device is disconnected from the Control Room.

You can specify the time to automatically delete the temporary devices in the **Devices** settings of Control Room.

- **Log collection configuration**

Enables you to collect log entries from the devices connected to the Control Room. For more information, see [Configure log collection](#) on page 1800.

- **Review**

Review the list of devices and the associated settings.

5. Click **Submit**.

All the changes are applied across all the selected devices.

## About device pools

Device pools are a logical grouping of devices or similar unattended Bot Runner machines on which you can run your workload management automations or scheduled unattended

automations. For example, you can group the devices (system-wide type) of a specific department or unit and create a device pool.

## Overview

You can use a device pool to restrict bot deployments to a specific set of devices that are available from your Control Room instance and take advantage of any device available in a device pool because any device in the device pool can run the bot.

You can also use a device pool to process work items from workload management queues. Workload management distributes work items across various devices in a device pool. This distribution of work items ensures efficient bot processing through optimal usage of devices and Automation 360 licenses. Device pools can contain different types of devices, such as single-user devices or multi-user devices.

You can share the device pool between multiple automations such as workload management, **Run bot**, and **Schedule bot**, thus improving the device utilization.

## How a device pool works

When you deploy an unattended bot to a device pool at run time, system identifies the available devices from the pool. System starts with first device from the pool, if the first device is busy, it checks for next device and then the bot is automatically sent to the available device from the list of system-wide devices. As the other bots are deployed, they can run concurrently on the other devices in the device pool. By dynamically allocating devices when bots are deployed, bot deployments are executed quickly and efficiently.

## High availability (HA) in device pools

Device pools provide built-in (HA) for the Bot Runner machines if your unattended license is free to use. You are not tied to a single Bot Runner machine, so if your Bot Runner machine is unavailable for any reason and your unattended license is free for deployment, your automation is not affected. The scheduled automation will automatically run on the next available Bot Runner machine, thereby providing high availability.

---

**Note:** Consider the following points when working with user credentials:

- Only one user credential can be attached to a licensed user.
- If all devices in a device pool are domain integrated and Active Directory users have access to all devices, licensed users can login to any device by using attached user credentials.
- For more information about running bots in device pool, see [Considerations for running a bot](#) on page 2283.

---

## Managing device pools

As a device pool administrator, you can create, edit, and view all device pools that can be used for scheduling automations and workload management.

As a device pool owner or consumer, you can view only those device pools of which you are the owner or consumer. Only users with the **AAE\_Pool Admin** role or users with custom role containing the **Administer ALL device pools** permission can perform device management tasks.

---

**Note:** You have to create device pools to view those in the list.

---

To easily access your device pool, you can search by a device pool name.

- Click a column to sort it in ascending and descending order. You can sort up to three columns by holding the Shift key when you click two more columns. This enables you to sort two additional columns. The sorting is done on the entire table and not just the data that is currently visible to you. The last sorting is stored in memory applied by a user per session.
- Use a drag-and-drop operation to move the column left or right.
- Move your mouse cursor at the end of the column and drag to resize.

## Create device pools

Create a device pool with a unique name and add Unattended Bot Runners to the device pool.

- Ensure that you have one of the following roles to view the **Device Pools** tab:
  - **Device pool owner**
  - **Device pool admin**
- Ensure that you have a role with **Create device pools** permission to create a device pool.

---

**Note:** A Control Room administrator without device pool admin rights cannot view or create a device pool.

---

- To add a device in the device pool, you must install it as a system-wide device (Bot Agent).
- After you add the device, you cannot add the same device to another device pool.
- You can add only those Unattended Bot Runners that are not part of any other pool.

---

**Restriction:** Unattended Bot Runners that are a part of other device pools are disabled for selection.

---

- You can use the **Scheduled automations** and **Run with Queue automations** options to run bots on that device.
- You can add Control Room user roles as consumers. Only users with these roles can use the pool for any automation.
- You can select only those devices with the Bot Runner installed at the system wide.
- If the devices in a device pool are more than the number of work items added to a queue, multiple entries equal to the number of devices are shown in the Control Room **In-progress activity** and **Historical** pages. For details, refer to the **View queue details** page on the actual user device on which the workload automation is deployed.

To create a device pool, perform the following steps:

1. Navigate to **Manage > Device pools**.
2. Click **Create device pool**.
3. Enter the **Name**.
4. Optional: Enter a description.

5. Select the **Devices** from the list of .
6. Click the right arrow (→) to add your selection.
7. Click **Next**.
8. Select the Device Pool **Owners**.
9. Select user(s) from the **Available users** list.

---

**Tip:** Search the list of users based on their **Username, First name, or Last name**.

---

10. Click the right arrow (→) to add your selection.
11. Click **Next**.
12. Optional: Select the Device Pool Consumers.  
Complete this step to enable device pool consumers to view the device pool when they run the automation for the bot with a queue by following the next set of steps.
13. Optional: Select a Role from the list of **Available roles**.
14. Click the right arrow (→) to add your selection.
15. Click **Create device pool**.

The device pools for which you have consumer privileges are listed in the Device pools page.

[View device pool details](#) on page 1884

Related tasks

[Run bot with queue](#) on page 2006

Collectively process all work items of a queue across all the Bot Runners present in one or more device pools.

## View device pool details

As a Control Room user with device pool management privileges or as a device pool owner, you can view device pool details to ensure the information provided is correct and if required customize as per your automation requirement.

Ensure you are logged in to the Control Room as an administrator or as a user with custom role containing the **Administer ALL device pools** permission.

Use the **Device pool details** page to view automations that are scheduled to run with or without workload. The following information is displayed as part of device pool data:

Automations

Shows the automations that are using the device pool and the order that is chosen to run those. This is shown as the default view. To find an automation quickly, use the search option using Status, Automation name, Queue, or Activity type.

You can perform the following actions on a table column:

- Click a column to sort it in ascending and descending order. You can sort up to three columns by holding the Shift key when you click two more columns. This enables you to sort two additional columns. The sorting is done on the entire table and not just the

data that is currently visible to you. The last sorting is stored in memory applied by a user per session.

- Use a drag-and-drop operation to move the column left or right.
- Move your mouse cursor at the end of the column and drag to resize.

Devices	Shows list of unattended Bot Runner devices that are part of the device pool.
Owners	Shows list of device pool owners that are granted permission to view, edit, and delete the device pool. <a href="#">Create device pools</a> on page 1883
Consumers	Shows the list of device pool consumers who are granted permission to view the device pool as an option to running automations. <a href="#">Create device pools</a> on page 1883
General Details	Shows the last modified date and time, name of the user who modified device pool details, and the Object Type which is the component on which modification was done.

The **Scheduled Automations** tab is selected by default. Automations that are created using **Run bot now** or **Schedule bot** (upcoming schedules) on that device pool are listed.

The second tab, **Run with Queue Automations** lists the automations that are scheduled to run for **Workload** using the option **Run bot with queue**.

To view device pool details:

1. Navigate to **Manage > Device pools**.
2. Hover over the **Actions** icon for the device pool and select **View**.  
Select each tab to view the related details.

[Edit device pools](#) on page 1885 , or [Run bot with queue](#) on page 2006 .

Related tasks

[Create device pools](#) on page 1883

Create a device pool with a unique name and add Unattended Bot Runners to the device pool.

[Delete device pools](#) on page 1887

Delete a device pool comprising of unattended Bot Runners after your entity's automation goals are achieved and the device pools are no longer required.

## Edit device pools

As a Control Room user with device pool management privileges or as a device pool owner, you can edit device pool details to customize your automation requirements.

- You must have **Device pool owner**, **Device pool admin**, or a custom role containing the **Administer ALL device pools** permission to edit a device pool.

- Users without **AAE\_Admin** role must have the following permissions to edit a device pool:
  - **View and manage ALL device(s)** to add or delete the devices
  - **View Users and Roles basic information** to add or delete the owners and consumers
- To add a device in the device pool, you must install it as a system-wide device (Bot Agent).
- After you add the device, you cannot add the same device to another device pool.

When you open the device pool in edit mode, you can update the queue details such as Bot Runner, Owners, Participants, and Consumers.

**1. Go to [Manage > Device Pools](#).**

The **Device Pools** tab is visible only if you have **Device pool admin** role or you are an owner of any device pool.

**2. Locate the device pool you want to edit, hover over the actions menu (vertical ellipsis), and click [Edit](#).**

You can also edit the device pool details in view mode. For more information, see [View device pool](#)

The **Device pool details** page is displayed with the default **Scheduled Automations** tab.

**3. Set the Queue Execution mode to edit workload automations.**

Go to the **Run with queue automations** tab, then choose one of the following options to define the order in which your automations run in the queues:

- **Round robin:** Runs your automations at equal time intervals in the **Time slice** field. For more information, see [Round robin](#) on page 1887.
- **Priority as shown in table:** Runs your automations based on a priority defined in the priority table. For more information, see [Priority as shown in table](#) on page 1887.

**4. Update the list of unattended Bot Runner devices that are included in the device pool.**

**5. Update the list of device pool owners who are granted permission to view, edit, and delete the device pool.**

**6. Update the list of device pool consumers who are granted permission to view the device pool.**

**7. Click [Save changes](#).**

Related tasks

[Create device pools](#) on page 1883

Create a device pool with a unique name and add Unattended Bot Runners to the device pool.

[Delete device pools](#) on page 1887

Delete a device pool comprising of unattended Bot Runners after your entity's automation goals are achieved and the device pools are no longer required.

[View device pool details](#) on page 1884

As a Control Room user with device pool management privileges or as a device pool owner, you can view device pool details to ensure the information provided is correct and if required customize as per your automation requirement.

## Order of the automation queue

You can define the order in which your automations run in the queues.

This topic describes options of orders in which you can run the automation queues.

## Round robin

This option runs your automations at equal time intervals specified in the **Time slice** field. You can set a **Time slice** in seconds, minutes, or hours and you can calculate or estimate the time for each automation, and then provide this number.

- The default time slice is **60 minutes**.
- The time slice cannot be set to zero.

Automations are executed for 60 minutes first, then the system checks for other automations in queue for execution. If there are other automations in the queue, that automation is paused and the next automation is executed. This method continues until all automations in the queue are executed.

## Priority as shown in table

With this option, automations run based on a priority defined in the priority table. You can run automations in the order of priority and set the individual priorities for each of the queues. Priority 1 is the highest priority and that queue is processed first and completely by the device pool. Then the device pool moves onto the processing queue with Priority 2. When the queue with Priority 2 is processed completely, the device pool proceeds to processing queue with Priority 3, and so on. Automations are processed until all automations are consumed from the specified automation queue.

---

**Note:** This option is available only on the **Run with queue automations** tab.

---

## Delete device pools

Delete a device pool comprising of unattended Bot Runners after your entity's automation goals are achieved and the device pools are no longer required.

Ensure you are logged in to the Control Room as an administrator or as a user with custom role containing the **Administer ALL device pools** permission.

You can choose to delete your device pools in either of two ways:

- Delete one device pool
- Delete multiple or all device pools

If the device pool is being used for workload automation, you will not be allowed to delete it.

1. Navigate to **Manage > Device pools**.
2. Select the device pool(s) to delete.  
Select the device pools to delete or select all device pools by selecting the **Select All** check box in the header.
3. Hover over the **Actions** icon for the device pool.
4. Click **Delete**.  
Confirm or cancel.

Related tasks

[View device pool details](#) on page 1884

As a Control Room user with device pool management privileges or as a device pool owner, you can view device pool details to ensure the information provided is correct and if required customize as per your automation requirement.

[Create device pools](#) on page 1883

Create a device pool with a unique name and add Unattended Bot Runners to the device pool.

## Add queue, Bot Runner, and device pool

Add a queue, Bot Runner, and device pool to the automation from the **Run bot with queue** page.

Ensure that you are logged in to the as the administrator.

Automation processes are queued until the specified **Run as user** and devices become available. Queuing permits other automation processes for that specific **Run as user** until the specified device becomes available. Any **In use** queues are shown as disabled in the **Available queues** list.

You can deploy the automation on the number of users that you choose with the **Run as** option and not on the total number of devices available in a device pool. Select only those queues that are not in use.

---

**Note:** You cannot use multiple queues to add Bot Runners.

---

1. Select a **Queue** from the **Queues** list.

The queues for which you have consumer access and same work item template as the selected bot are listed.

2. Click **Next**.

3. In the **Run as** tab, from the **Available bot runners** list, select a **Bot Runner**.

- a) Optional: Select the **Run on bot running devices** option.

If you want to select Bot Runners that are mapped one-on-one to their default (single-user) devices, select the **Run on bot running devices** option. This option enables the Work Items to be deployed only to the user's default device, whereby the security policy does not allow a user to log in to any other device or when applications for automation are installed on the default device.

If you select this option, ensure that all the default devices are part of the same device pool when you select from the **Device Pool** tab in Step 5.

---

**Tip:** Do not select this option if the run as users (Bot Runners) are configured to use multiple devices. In that configuration, if any device in the pool is processing an automation, the run as user can log in to another device, and the work items will be processed on that device. This enables optimal utilization of licenses (run as user) and devices.

---

For information on scenarios for choosing bot running devices for run as users, see [Considerations for running a bot](#) on page 2283.

4. Click **Next**.

5. In the **Device pool** tab, select a **Device Pool** from the **Available device pools** list.

6. Click **Add**.



The queue and device pool are added to the run bot with the queue list.

7. Optional: Click **Remove** to replace the queue or the device.
8. Click **Run bot with queue**.  
The queue status changes to **In use** on the **Queues** page.

---

**Note:** In a Workload management (WLM) automation when you select the **Run on bot running devices** and

- If your device changes, ensure that the device is also part of the WLM device pool.
  - If you edit the device pool, ensure that all devices in the device pool are default devices for the WLM run-as users.
- 

Related concepts

[Considerations for running a bot](#) on page 2283

There are certain considerations you have to keep in mind when running a bot.

## Configure OAuth connections in Control Room

OAuth is a secure, efficient, and easy-to-use open standard authorization protocol that helps you protect user privacy. It defines how to delegate or provide authorization to applications to access resources (such as remote or third-party APIs, or user data) without the user having to provide their username and password credentials.

---

**Note:** The Salesforce mark and logo, the Microsoft SharePoint mark and logo, the Apigee mark and logo, ServiceNow mark and logo, and the Genesys mark and logo are trademarks or registered trademarks of Salesforce, Inc., Microsoft Corp., Google LLC, ServiceNow, Inc., and Genesys, respectively, and are used for identification purposes only.

---

For more information, see [OAuth 2.0](#).

OAuth supports a set of predefined methods called grant types. Each grant type has specific requirements and flow depending on the scenario. Control Room OAuth connections support the following grant types:

- Authorization Code Flow
- Authorization Code Flow with Proof Key for Code Exchange (PKCE)

---

**Note:** In scenarios where the user context is not required or a token is shared across multiple bots (such as unattended bot runs) ensure that you use a shared token (the **Save login credentials** option) to run unattended automations. For more information, see [Create OAuth connection](#) on page 1893.

---

### OAuth architecture

With OAuth connections managed in the Control Room, you can manage connections and token lifecycle centrally through the Control Room. Additionally, you can securely store the tokens required to authenticate and authorize access to enterprise applications without having to obtain them at every automation run-time. The Control Room supports the following options:

- Create and manage connections for every SaaS application used within automations.
- Manage token lifecycle for shared and user-specific tokens.
- Secure token storage by using industry standard encryption levels.
- Grant permissions and role-based access to manage and consume the OAuth connections within automations.

OAuth workflow example: The following example describes how to configure, create, and use the OAuth connection:

1. [Configure enterprise applications](#) on page 1892
2. [Create OAuth connection](#) on page 1893
3. [Use OAuth connection](#) on page 1896

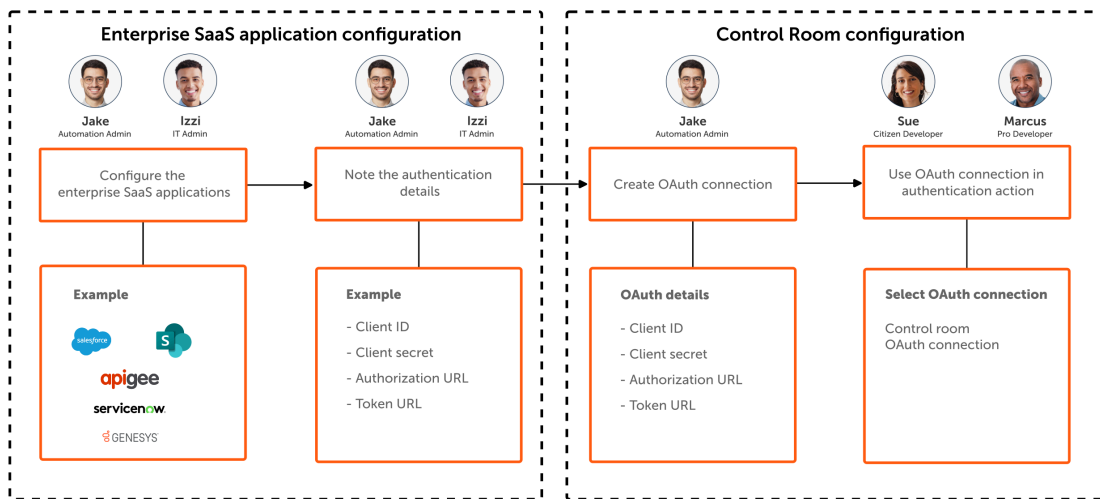

Roles and responsibilities: Administrators perform the following tasks:

1. Create a connection for an enterprise SaaS application.
2. Enter the authentication details such as: client ID, client secret, authorization URL, and so on.
3. (Optional) Save the login credentials and test the connection.
4. Invite roles to use this connection or authenticate for unattended Bot Runners.
5. Save and manage the connection.

See: [Create OAuth connection](#) on page 1893.

Pro developers or citizen developers perform the following tasks:

---

**Note:** To build and execute an API bot successfully, pro developers or citizen developers need to authenticate to the enterprise application unless the administrator has saved the login credentials for the developers (users) to use the connection.

---

1. Create an API Task or Task Bot.
2. Add authentication action for packages.

3. Select the authentication type (**Control room OAuth connection**), connection name, and enterprise application information.

See: [Use OAuth connection](#) on page 1896.

## OAuth tokens

OAuth provides the following token types:

Access token or shared token	A long string of characters that serves as the credential used to access protected resources. This token type is typically used in unattended automations where user authentication and consent is not required to run automations.
Refresh token	A long-lived special token used to obtain a new access token when the existing access token expires. The refresh token provides a short-lived access token instead of collecting credentials from the user every time a new access token is required. The Control Room uses the refresh token to get a new access token from the authorization server (AS).

When using OAuth, the access token and refresh token are returned in the same response during the token exchange process called Access Token Response.

## Benefits of integrating OAuth with Control Room

When you integrate OAuth with the Control Room, you:

- Provide a secure and standard model for automations to authenticate and authorize enterprise applications.
- Eliminate the need to manually enter the credentials at runtime or hard code the credentials in automations.
- Ensure that the access tokens are always valid and available for automations at runtime by obtaining them before they expire; therefore, eliminating the need for users to go through the authentication process to obtain them.
- Avoid repetitive task of configuring the OAuth parameters for every automation using the OAuth connection. The connections are referenced in automations using the enterprise application provider type.

## Token lifecycle management

All access tokens have an expiration time dictated by the authorization server (AS). Tokens are refreshed using the token refresh mechanism to extend the token validity (by issuing a new token). With a centralized approach, the Control Room manages the token lifecycle and validates each token before a bot execution.

## Configure enterprise applications

You must configure the enterprise applications (such as Salesforce, Apigee, ServiceNow, and so on) and make note of the authentication details (such as such as client ID, client secret, authorization URL, and so on) to use the OAuth connection in the Control Room.

To configure the third-party enterprise applications, review the following topics:

- [Apigee Connect](#) on page 2414
- [Genesys authentication action](#)
- [Salesforce Authentication action](#) on page 2973
- [ServiceNow authentication action](#) on page 3019
- [SharePoint authenticate action](#) on page 3038
- [Connect action for Google packages](#) on page 2717

The following table provides information about the enterprise application access and refresh tokens:

Third-party providers	Maximum duration of access token	Can you configure the access token duration?	Maximum duration of refresh token	Can you configure the refresh token duration?	Can the Control Room auto renew the access token?
Apigee	1 hour (3,600 seconds)	No	—	No	Yes
Genesys	48 hour (172,800 seconds)	Yes	—	No	Yes
Salesforce	24 hours (86400 seconds)	No	Valid until revoked	Yes	Yes
ServiceNow	30 minutes (1,800 seconds)	Yes	100 days	Yes	Yes
SharePoint	1 hour (3,600 seconds)	No	Up to 90 days	Yes	Yes

Third-party providers	Maximum duration of access token	Can you configure the access token duration?	Maximum duration of refresh token	Can you configure the refresh token duration?	Can the Control Room auto renew the access token?
Google packages (Google Calendar, Google Drive and Google Sheets)	By default, Google Cloud API tokens expire after 1 hour (3,600 seconds).	You can request a longer expiration time of up to 12 hours by specifying the <code>expires_in</code> parameter when you authenticate.	The refresh tokens granted by the Google Auth server never expire. However, there are a few reasons why a granted refresh token might not work. See <a href="#">Refresh token expiration</a> .	No	Yes

## Create OAuth connection

A Control Room administrator can create OAuth connections for users to use these connections in the authentication action for packages without having to enter any authentication details.

Note: The Salesforce mark and logo, the Microsoft SharePoint mark and logo, the Apigee mark and logo, ServiceNow mark and logo, and the Genesys mark and logo are trademarks or registered trademarks of Salesforce, Inc., Microsoft Corp., Google LLC, ServiceNow, Inc., and Genesys, respectively, and are used for identification purposes only.

- Ensure that you are using a user role that has the **Manage connections** option enabled for the **OAuth Connections** feature. See [Feature permissions for a role](#) on page 1749.
- Ensure that you have configured an enterprise application and made a note of the Client ID, Client secret, Authorization URL, Token URL, and scope. See [Configure enterprise applications](#) on page 1892.

The following table provides the format of the Authorization URL, Token URL, and scope for the supported enterprise applications:

Enterprise applications	Authorization URL	Token URL	Scope
Apigee	<code>https://accounts.google.com/o/oauth2/auth?prompt=consent&amp;access_type=offline</code>	<code>https://accounts.google.com/o/oauth2/token</code>	<code>https://www.googleapis.com/auth/cloud-platform</code>
Genesys	<code>https://login.&lt;yourinstance&gt;.pure.cloud/oauth/authorize</code>	<code>https://login.&lt;yourinstance&gt;.pure.cloud/oauth/token</code>	Not required
Salesforce	<code>https://&lt;yourinstance&gt;.salesforce.com/services/oauth2/authorize</code>	<code>https://&lt;yourinstance&gt;.salesforce.com/services/oauth2/token</code>	<code>api,refresh_token,offline_access</code>
ServiceNow	<code>https://&lt;yourinstance&gt;.service-now.com/oauth_auth.do</code>	<code>https://&lt;yourinstance&gt;.service-now.com/oauth_token.do</code>	Not required
SharePoint	<code>https://login.microsoftonline.com/&lt;tenant-id&gt;/oauth2/v2.0/authorize</code>	<code>https://login.microsoftonline.com/&lt;tenant-id&gt;/oauth2/v2.0/token</code>	<code>https://&lt;domain-name&gt;/AllSites.Manage, offline_access, openid</code>

Enterprise applications	Authorization URL	Token URL	Scope
Google packages (Calendar, Drive and Sheets)	https://accounts.google.com/o/oauth2/auth?prompt=consent&access_type=offline	https://oauth2.googleapis.com/token	<ul style="list-style-type: none"> <li>Google Sheets https://www.googleapis.com/auth/drive, https://www.googleapis.com/auth/spreadsheets</li> <li>Google Drive https://www.googleapis.com/auth/drive</li> <li>Google Calendar https://www.googleapis.com/auth/calendar</li> </ul>

**Note:** We recommend that you use refresh tokens that are configured for a longer expiry duration.

To create a connection:

1. Navigate to **Manage > OAuth connections**.
2. Click **Create connection**.  
The **Connection settings** screen appears.
3. Select a **Provider type**.

**Note:** The **Callback URL** is used in your enterprise application configuration settings to connect to the Control Room.

4. Enter a unique **Connection name** to identify the connection.
5. Optional: Enter a **Description** for the connection.

6. Click **Next**.  
The **Authentication details** screen appears.
7. Select a **Grant type**.  
If you are configuring for a Google Cloud Platform (GCP) account, select **Authorization Code Flow** because Google Cloud Platform (GCP) does not support Authorization code flow with PKCE.
8. Enter the **Client ID** that is provided by the provider for your account.
9. Enter the **Client secret** that is provided by the provider for your account.
10. Enter the **Authorization URL** used to obtain an authorization code for your account.

**Note:** For Apigee or Google Cloud Platform (GCP) account, you must append `&access_type=offline` to the authorization URL. For example: `https://accounts.google.com/o/oauth2/v2/auth?prompt=consent&access_type=offline`.

11. Enter the **Token URL** used to exchange an authorization code for an access token.
12. Optional: Enter **Scope**.

Edit connection Cancel Save changes

Connection settings  Authentication details  Test connection and save credentials  Invite roles (optional)

**Authentication details**

Grant type: Authorization Code Flow Client ID:

Client secret:  Maximum = 255 characters

Authorization URL:  Authorization server endpoint for obtaining an authorization code

Token URL:  Authorization server endpoint for exchanging an authorization code for an access token

Scope (optional):  Used as claims in an access token for the resource server to limit access

< Back Next >

This information is used as claims (information about the user) in an access token and forwarded to the resource server to limit access.

**Note:** If you are adding more than one scope, ensure that you separate the scopes using commas or space separated delimiter.

13. Click **Next**.  
The **Test connection and save credentials** screen appears.
14. Optional: Select the **Save login credentials**.

**Note:** When you select this option, an access or shared token is generated which grants permission to users or roles who have view or manage OAuth connection permission. When this option is not selected, such users or roles will not be able to use this connection. For information about access or shared connection, see [Configure OAuth connections in Control Room](#) on page 1889.

15. Optional: Click **Save changes and test connection**.

Edit connection Close Save changes

Connection settings  Authentication details  Test connection and save credentials  Invite roles (optional)

**Test connection and save credentials**

Test your connection to ensure that the provider has been correctly added. Optionally save these credentials to generate a shared token for unattended bot runners to use.

**Warning:** Saved credentials will generate a shared token  
The credential that you log in with to test connection will generate the shared token

Save login credentials

Test connection

Test connection succeeded

< Back Next >

**Note:** If you are using the **Authorization Code Flow** grant type, after you click the **Save changes and test connection** option and if the connection is successful, the **Next** button is disabled. Click the **Back** button, enter the **Client secret** again, and then click **Next**. You need not test the connection again unless you have made any changes to the previously provided authentication details.

16. Click **Next**.  
The **Invite roles** screen appears.
17. Optional: Select the custom roles that you want to invite to use this connection.

When you invite roles to use the OAuth connection, the users who are using the role get notified about the assigned connection if they have subscribed to event notifications. See [Notifications](#) on page 2194.

18. Click **Create connection**.

The following video shows how to create an OAuth connection:

[Use OAuth connection](#) on page 1896

## Use OAuth connection

You can use the established OAuth connections to enable users or roles to use the connections without having to enter the authentication details every time they want to use the corresponding authentication action.

Note: The Salesforce mark and logo, the Microsoft SharePoint mark and logo, the Apigee mark and logo, ServiceNow mark and logo, and the Genesys mark and logo are trademarks or registered trademarks of Salesforce, Inc., Microsoft Corp., Google LLC, ServiceNow, Inc., and Genesys, respectively, and are used for identification purposes only.

Ensure that you have configured the following options:

1. [Configure enterprise applications](#) on page 1892.
2. [Create OAuth connection](#) on page 1893.

For example, if you are an administrator, you can create an enterprise application connection and make it available for users or roles. The users can then use this connection to authenticate the enterprise application having to request the authentication details from the administrator.

1. Open the bot that is using the enterprise application authentication action.
2. In the action properties panel, select the **Control room OAuth connection** option from the **Authentication type** drop-down.



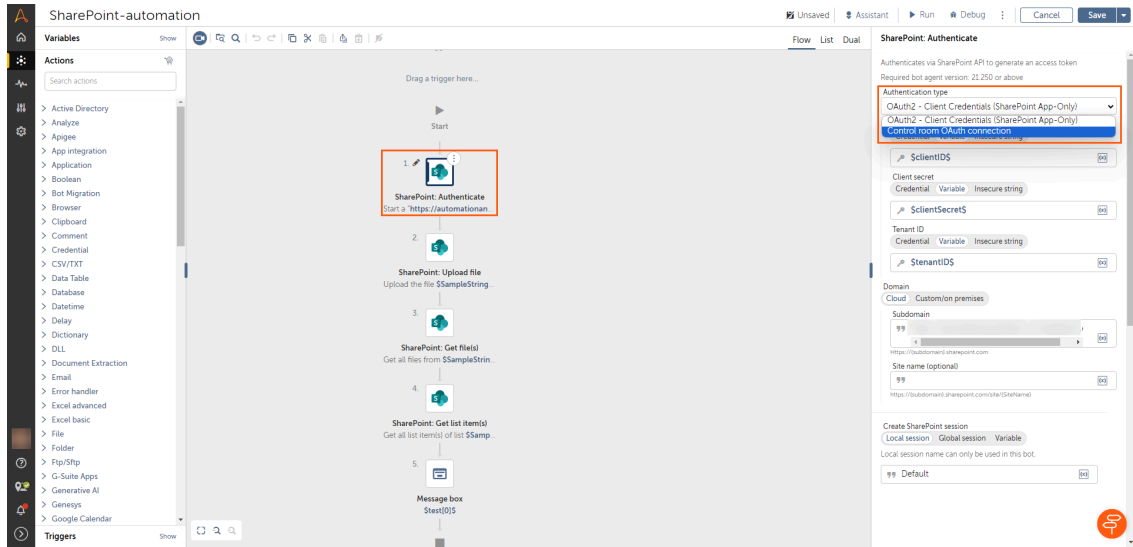

3. Click the **Pick** option to select a connection type.
4. In the **Pick a connection** window, select a **Provider type**, **Connection name**, and **Token type**.
  - In scenarios where the user context is not required or a token is shared across multiple bots (such as unattended bot runs) ensure that you select the **Shared** token type option to run unattended automations.
  - In scenarios where the user context is required, ensure that you use the **User-specific** token type option.
5. Click **Confirm**.

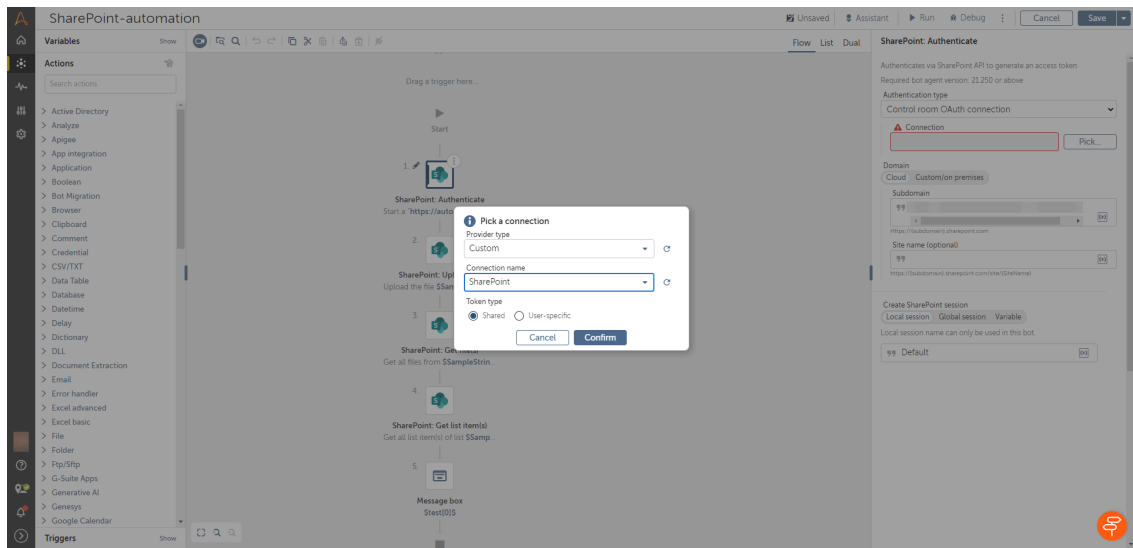

The following video shows how to use OAuth connection in an enterprise application:

# Packages

A package in Automation 360 is a collection of actions that you use and configure to build automations.

## What is a package

A package provides the following building blocks for automation:

- Actions (also called commands in v11 and v10)
- Conditional statements (used to set If conditions)
- Iterators (used to set the number of times something has to be run)
- Triggers (conditions that cause an automation to run)
- Variables (system or custom)

As a developer, you can access the packages in the Bot editor in the following ways:

- Go to **Automation > Files and folders list**, and click an automation. In the **Actions** pane on the left, view packages and actions, variables, and triggers. Add new actions or modify the existing property values in the automation.
- Go to **Automation > Create new > Task Bot**. In the **Actions** pane on the left, view packages and actions, variables, and triggers that you use to build your automations.

Watch the following video for an overview on packages:

## How packages are updated in Control Room

Updates to packages are available with each release of Automation 360. As an administrator, you can configure Control Room settings to get package updates. You can also enable or disable automation updates of packages in the Control Room.

See [Updating packages in Control Room](#) on page 1905.

## Package permissions

Users must have the appropriate administrative permission (PACKAGE MANAGER role) to view or manage packages.

- **View packages:** A user with **View packages** permission can view the packages that are available to Bot Creators. Go to the **Manage > Packages** page to view all the packages in the Control Room that are available for Bot Creators. Packages can have multiple versions.
- **Manage packages:** A user with the **Manage packages** permission can add new packages to the Control Room and manage which packages versions are available in the Control Room. Go to **Manage > Packages** page and use the **Add** icon (plus sign) on the top-right of the packages list to add packages.

See [Add packages to the Control Room](#) on page 1908.

To manage Control Room packages by setting a package as default, disabling it, or deleting it, see [Manage Control Room packages](#) on page 1913.

If a specific version of the package is disabled, a **Disabled package** alert is displayed against any of the actions from that package that you might have used in your existing bots.

## Configuring RBAC on packages

As an administrator, you can configure package availability for specific users for which you want to give access, select **View package** from the menu for that package and in the **Availability** tab, edit the settings as required.

See [RBAC on packages](#) on page 1899.

## Updating package versions

You can choose and select which package version to set as default in the Control Room. You can also quickly update bots to a secure, stable, and default package version across multiple bots.

---

**Note:** We recommend that developers update their bots to use the latest version of a package.

---

See [Updating package versions](#) on page 1909.

## Usage notes

- On the packages landing page **Manage > Packages** ( On premises and Cloud), if all versions of a package are disabled, the status is displayed as **Disabled**.

All related fields, such as recommended Control Room version, Bot Agent version, and Last modified, will show the status as **Not Available**.

---

**Note:** The **Version** column is renamed to **Default version**.

---

- When you update to Automation 360 v.24, the Apache log4j2 library is no longer bundled in the packages. Note that earlier packages (from Automation 360 v.23 and earlier) might continue to have the log4j2 library bundled within them. If you want to use packages without the log4j2 library, we recommend that you use the newer Automation 360 v.24 packages in your autotmations.

## RBAC on packages

Based on the business requirements and expertise of developers, administrators can restrict package access for a simplified developer experience, along with the capability to enforce access policies for custom groups.

### Overview

The RBAC feature helps you to set access at the package level to restrict usage and execution of packages to improve security. This feature can be applied to all package types, including custom packages where you can control assigning and managing the packages to your users.

RBAC access to packages applies only to the task of creating bots. If a user role does not have access to a particular package, these users cannot view the package on the **Actions** palette and therefore cannot use it when creating bots. However, these users can run bots (created by a different user who has access to the package) that uses the package.

- Each developer sees only the approved list of packages in their workspace.
- Some packages might be available for all users, while some are available only for certain groups.

The following image shows how RBAC can be set for user roles and groups:

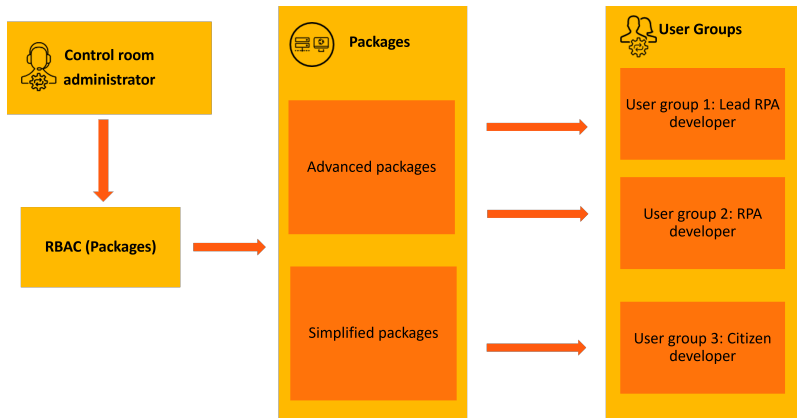

## Benefits of packages RBAC

- Centralized policy enforcement for secure, user-friendly developer access: Role-based access to automation provides enhanced security, confidence, and ease of use for developers.
- Enterprise-wide access policy: Establish group-based package access with clear policies restricting package access to all the users or users with specific roles.
- Access based on business needs: Create required access groups, expose group-appropriate library of packages, and manage the phased rollout of package access.
- Simplified automation for citizen developers: Hide complex packages from the action palettes for citizen developers so that they can focus on easy-to-complete automation.
- Automation reuse with compliance: Enable users to create utility bots from complex packages to use as cloned bots in the a private workspace or inside public bots.

The following image lists the benefits of packages RBAC:

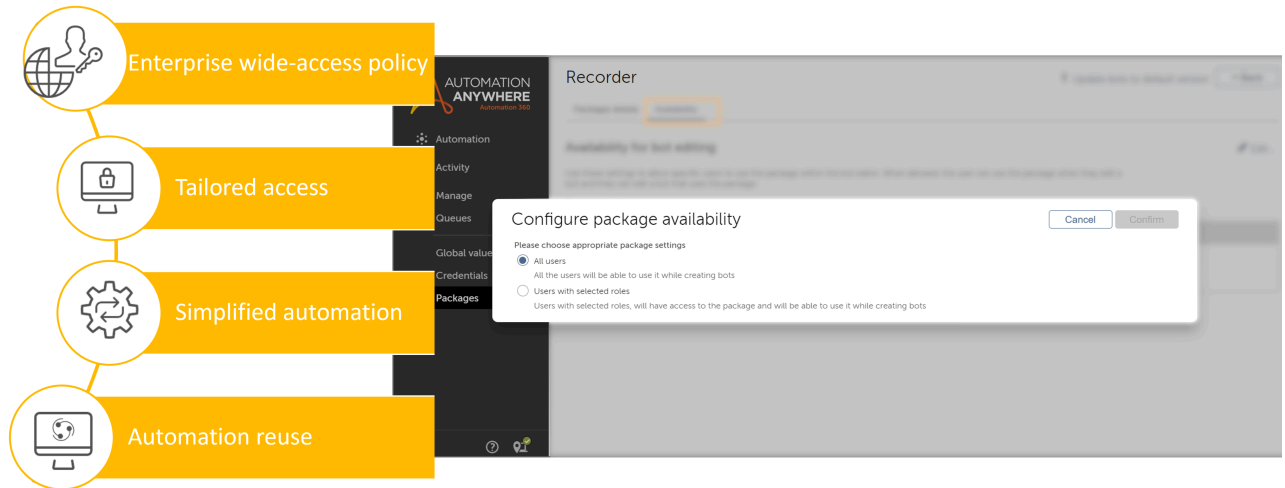

## User types

### Administrator

- Customizes packages so that they are accessible to developers based on the developers' expertise, skill, business group, and more.
- Creates custom groups and assign access per group.
- Rolls out packages in a phased manner to different types of developers.
- Provides better control over how packages are made available to developers. For example:
  - New developers can avoid causing security risks as they do not have access to complex packages.
  - Advanced developers can get broader access to packages.

An organization can enforce centralized control over package access and best practices through this feature.

Roles and permission required: Administrators with the **View Users and Roles basic information** and **Manage packages** permission.

### Bot developer

- Gets a customized view of packages in their workspace.
- Simplified (easy-to-use) packages are enabled for Citizen Developers so that they can build a basic functional task bot

using actions and packages available in their actions palette.

- Advanced developers can get access based on the entitlements or privileges provided by the administrator.

Roles and permission required: Users with the **View Users and Roles basic information** and **Manage packages** permission.

See the following video for an overview of how RBAC is configured:

## Configure RBAC for packages

Restrict packages usage based on your business needs and roles for a secure and simplified developer experience. An administrator can customize access to packages based on developers' expertise, experience, and so on, while bot developers get a customized view of packages in their workspace based on their expertise and needs.

You must be an administrator or a user with the **View Users and Roles basic information** and **Manage packages** permission.

1. Log in to the Control Room.
2. Navigate to **Manage > Packages**.
3. From the list of packages, search for the package for which you want to give access to the users.
4. Click the selected package.

Status	Name ↑	Vendor	Version	Bot agent (recommen...	Control Room (reco...	# of a
Enabled	<a href="#">AARI Web</a>	Automation Anywhere	7.0.1-20220727-162102	21.134 or above	12316 or above	7
Enabled	<a href="#">Active Directory</a>	Automation Anywhere	3.5.0-20220416-233339	20.11 or above	8750 or above	3
Enabled	<a href="#">Analyze</a>	Automation Anywhere	2.4.4-20220615-020937	20.11 or above	8750 or above	2
Enabled	<a href="#">App Integration</a>	Automation Anywhere	4.8.0-20220616-123118	21.88 or above	10195 or above	3
Enabled	<a href="#">Application</a>	Automation Anywhere	3.5.0-20220416-233350	20.11 or above	8750 or above	1
Enabled	<a href="#">Boolean</a>	Automation Anywhere	2.5.0-20220118-153154	20.11 or above	8750 or above	6
Enabled	<a href="#">Bot Migration</a>	Automation Anywhere	9.1.3-20220805-200018	21.220 or above	15224 or above	2

For example, when you click the **Recorder** package, the selected package window opens.

5. To allow specific users to use the package from the Bot editor, go to the **Availability** tab and click **Edit**.
6. On the **Configure package availability** page, choose one of the following options:

- **All user:** Select this option to allow the user to use the package while creating bots. By default, this option is selected for all the packages.
- **User with selected roles:** Select this option if you want users with selected roles to access the package and use it while creating bots.

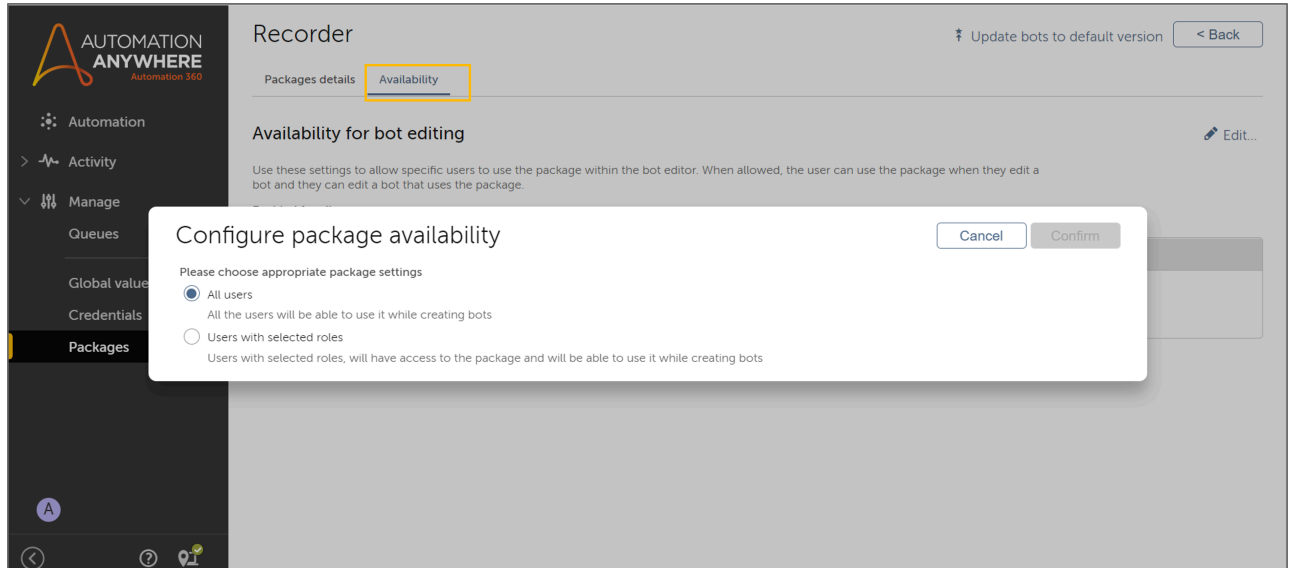

7. To configure access for specific users, perform these steps:
  - a) Select the **User with selected roles** option.
  - b) From the available roles, select the roles you want to assign.
  - c) Move the selected roles to the right panel.  
This step enables you to define users who will have access to the package in the Bot editor.
  - d) Click **Confirm**.

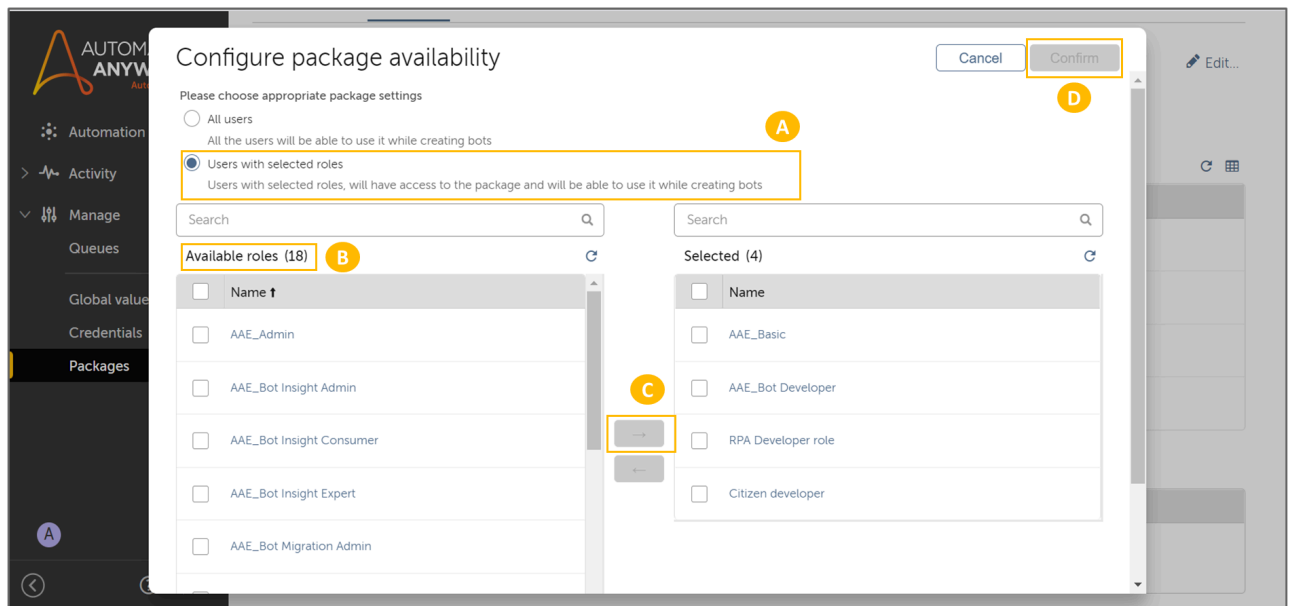

The availability tab shows the selected roles for whom the specific package is now enabled.

The screenshot displays the 'Recorder' interface in Automation Anywhere. The 'Availability' tab is active, showing settings for 'Availability for bot editing'. A table titled 'Roles (4 of 22)' lists the roles enabled for the package: AAE\_Basic, AAE\_Bot Developer, RPA Developer role, and Citizen developer. The table is highlighted with a yellow border. The interface also includes a sidebar with navigation options and a bottom navigation bar.

## Packages RBAC for bot developer

As a Bot Creator (RPA developer) or Citizen Developer, you can create bots based on the packages that are available to you.

You can only use the package-defined actions, triggers, variables, and customized packages for which you have access. Your access to these packages are set by the administrator based on user roles. If you do not have access to a package, you cannot view that package on the **Actions** palette.

RBAC on packages applies when you create or edit bots in your private workspace. You cannot run bots with restricted packages directly. However, you can use a cloned bot as a sub bot in another main bot and run this bot in a public or private workspace.

When a bot contains packages (or packages that you cannot access), keep in mind these considerations:

- You cannot perform these bot actions:
  - Run a bot: Either a new bot or a checked-out bot with changes
  - Check in a bot

If you try to perform these actions, an error message is displayed that the bot contains packages that are restricted.

- While editing variables, you cannot use variable property options related to restricted packages.

An error message is displayed that the variable is related to a package that is restricted.

- You cannot run a bot with triggers:

- From the Bot editor, when you run a bot with a trigger that contains a restricted package, see an error message is displayed that the bot with triggers contains a restricted package.



- When a trigger event is configured for a user and a device, and the trigger event occurs on the device, access to the bot package is verified. If the bot contains a restricted package, the bot fails, and an audit log entry is recorded.

## Updating packages in Control Room

The delivery of packages is developed to be separate from the main platform updates. This will help us respond quickly to changes and fixes required and provide the flexibility to deliver updates in packages, going forward.

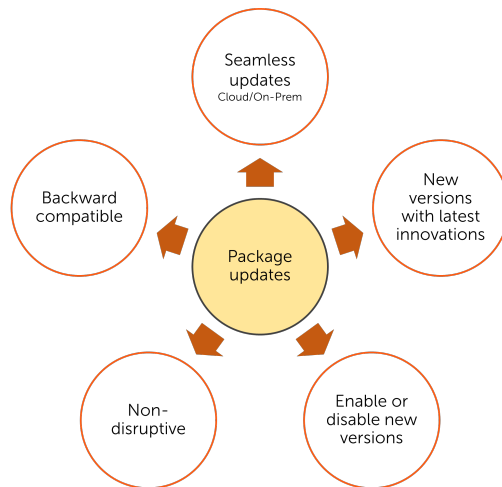

A new package and new package version is downloaded and installed if it is compatible with your Control Room version.

- Cloud users cannot turn off this automatic installation of a new package and new package version, but the package administrator can control the status of the new package version.
- For On-Premises users, the automatic package download capability is disabled by default, but package administrators can enable it.

---

**Note:** From Automation 360 v.27, the automatic package download capability is enabled by default for any On-Premises new installation. As a package administrator, you can disable this feature.

---

This capability is enabled differently for Cloud and On-Premises Control Room instances, as listed in the following table:

Seamless package update capability	Cloud Control Room	On-Premises Control Room
Download packages from Automation Anywhere Cloud	Enabled by default and cannot be disabled.	Disabled by default and can be enabled.  <b>Note:</b> From Automation 360 v.27, it is enabled for new installation and can be disabled.
Set downloaded package to default version	Enabled by default and can be disabled.	Enabled by default and can be disabled.

- Cloud users: [Automatic package updates for Cloud Control Room](#) on page 1907
- On-Premises users: [Automatic package updates for On-Premises Control Room](#) on page 1906

We recommend bot developers always use the latest version of the packages because that version provides the latest innovations and all the code and security fixes from previous versions. Note that this capability does not impact existing bots, which continue to run unchanged. Bots developed with a particular package version will continue to do so unless explicitly changed by the bot developer. However, if you want to modify existing bots to use the default version of a package, you can use the **Update bots to default package version** feature. For more information, see [Update bots to default package version](#) on page 1910.

Related reference

[Periodic package updates - summary list](#) on page 836

We will be updating specific packages in the Control Room to enable you to get early access to critical updates and fixes.

[Package updates overview](#) on page 835

Packages are typically updated in Automation 360 releases as part of new Control Room builds. We also plan to release some updates between these releases for early delivery of critical updates and fixes as package-only updates.

## Automatic package updates for On-Premises Control Room

Configure the On-Premises Control Room settings to get package updates from the Cloud automatically or only when the Control Room is upgraded manually.

Seamless package update capability is part of our effort to make innovations and enhancements readily available to you. This capability in the Automation 360 platform provides you predictable, qualitative, and non-disruptive access to the latest innovations and enhancements.

When this seamless update capability is enabled, the Control Room can download new packages and new versions of existing packages from Automation Anywhere Cloud when they are released on a regular and predictable release cadence. Newly downloaded package versions are automatically set as default packages so that customers can start using these package versions on an ongoing basis as the packages become available.

**Note:** To automatically download newly released package versions, the Control Room uses the following URL and port number:

- URL: `https://aai-artifacts.my.automationanywhere.digital/packages/<package-jar-file-name>`
  - Port number: TCP 443 (HTTPS)
- 

Note that this capability has no impact on existing bots. Existing bots continue to run unchanged. These new package versions are also backward-compatible with the existing platform version.

## Configure packages for On-Premises

Ensure that you are logged in to the On-Premises Control Room as administrator.

1. Navigate to **Administration > Settings > Packages**.
  2. Click the **Edit** option.
  3. Select one of the following options for updating the packages:
    - **Enable and set as default:** Is enabled by default and is used to automatically set the latest version of the packages as the default version.
- 

**Note:** The new package version is downloaded and installed only if it is compatible with your Control Room version.

---

- **Enable:** To manually set the default version when the packages are updated.
- **Disable:** To prevent any automatic update of a newer version of the packages.

If this automatic package update is disabled, a notification is displayed for these packages in the **Manage > Packages** page to notify you that an updated version is available. Such notifications are displayed only for packages that are part of your Control Room installation.

This is applicable for new packages downloaded from the Cloud and the Control Room upgrade.

4. Click **Save changes**.

## Automatic package updates for Cloud Control Room

Configure the Cloud Control Room settings to get package updates from the Cloud automatically.

Ensure that you are logged in to the as the administrator.

When a new package or a new package version is released in the Cloud, the package version will automatically get installed on Control Room. This automatic installation of a new package version cannot be turned off by cloud users and can only control the status of the new package version after it is installed.

1. Navigate to **Administration > Settings > Packages**.
2. Edit the **Packages** option. The page opens in edit mode.
3. Enable the settings to set the status of the new package.
  - **Enable and set as default:** Select this option to automatically set the new version of a package as the default version.

- **Enable:** Uploads and enables the package, but the package is not set as the default package. Bot Creators have to specifically select non-default packages to use them for creating bots.
- **Disable:** Choose this option to automatically disable the new version of a package.

#### 4. Save the settings.

Related concepts

[Preload packages](#) on page 2310

You can preload packages on your local device to shorten the bot runtime.

## Add packages to the Control Room

Administrators can add packages to the Control Room for use by Bot Creators.

Ensure that you are logged in to the as the administrator.

- You can add a package from either Bot Store or another source.
- For updated packages made available periodically, go to A-People and download the files: [Automation 360 package releases \(A-People login required\)](#).

For more information about periodic package updates, see [Package updates overview](#) on page 835.

To add a package from a source other than Bot Store, follow these steps:

1. Navigate to **Manage > Packages**.
2. Click **Add package**.
3. Click **Browse**.
4. Locate and select the package to add to the Control Room.  
Packages are Java Archive (JAR) files that contain actions used to create bots.
5. Click **Upload package**.
6. On the **Packages > Confirm package** page, choose any of the following options:
  - **Accept, enable and set as default:** Uploads and enables the selected package, and sets it to the default package for the Control Room.
  - **Accept and enable:** Uploads and enables the package, but the package is not set as the default package. Bot Creators have to specifically select non-default packages to use them for creating bots.
  - **Accept but disable:** Uploads and disables the new package.

Choosing **Reject** stops the upload process.

To add a package from Bot Store, see the following video:

7. After installation, click **Administration > Packages** to verify that the package is added.  
When you add or update a package in the Control Room, a notification is also sent through the **Notifications** icon. This notification is sent to the Control Room users who have the **View package** permission. For more information, see [Capabilities supporting notifications](#) on page 2208.

Related concepts

[Build and test a demo package and bot](#) on page 3569

This practical how to section demonstrates that creating, changing, and managing packages allow you to customize actions and efficiently manage packages for all Control Room users.

Related tasks

[Manage Control Room packages](#) on page 1913

Manage packages in the Control Room by setting a package as default, disabling it, or deleting it.

## Updating package versions

You can update multiple packages to default version for multiple bots. This feature enables you to update multiple package versions across all available bots with one action thereby increasing the efficiency of a bulk package update. Additionally, you can review the bots and dependencies before a bulk update.

In an enterprise business, maintaining a large number of bots with default and up-to-date packages is a tedious and time-consuming process. You cannot update those packages manually because you need to check the latest released package version and then update them for any required bots.

The **Bot update** feature in the Automation 360 platform provides a multiple package version update for multiple bots with dependencies. With one action, you can update multiple packages, bots that contain selected packages, and dependent bots.

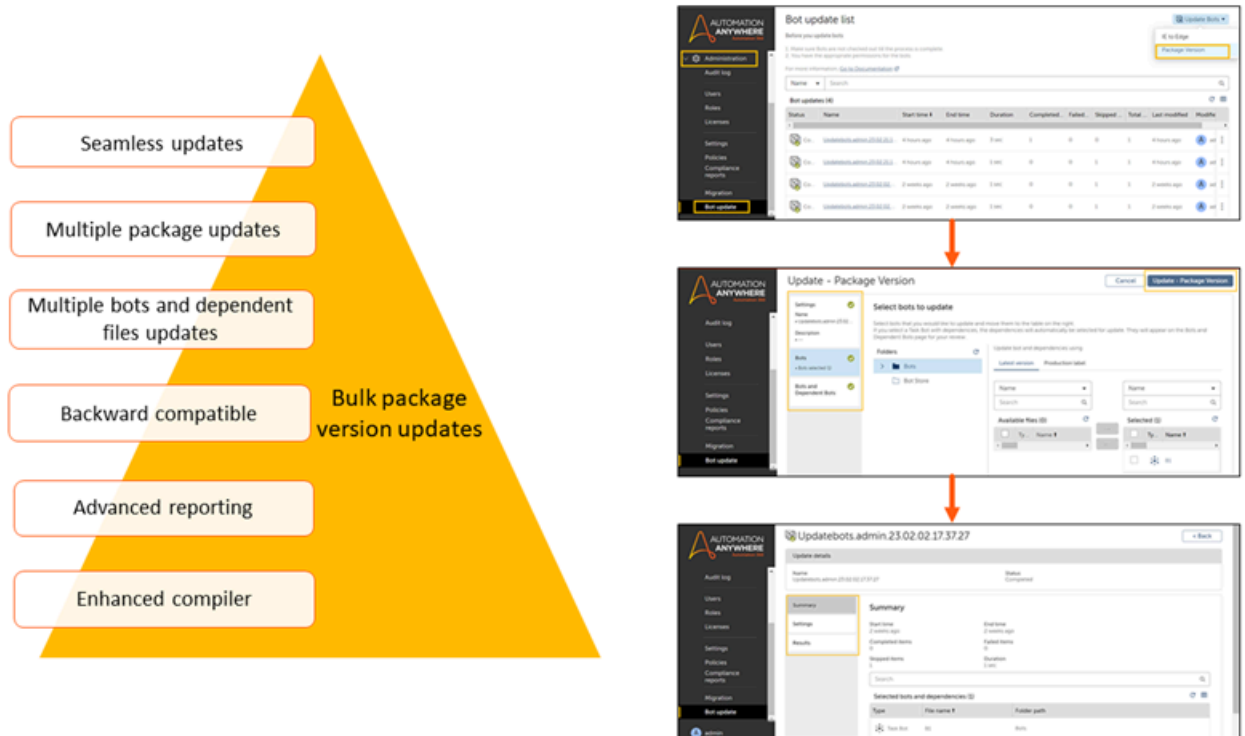

The **Bot update** feature provides the following benefits:

- Ability to select more than one package  
You can view a list of all the available packages and select to update all the required packages instead of updating one package at a time. Also, you can update packages to their default versions for the required bots.
- Ability to select only required and multiple bots

You can select only the required bots that you want to update with default package version instead of selecting all bots for update. This decreases the time required to complete the update functionality.

- Advanced reporting to view progress of bulk package updates

The Automation 360 platform provides a comprehensive report to view the progress of a bulk update of a package with the user's information. It also provides the following details:

- Number of packages considered for the update
  - Number of bots updated with default package version
  - Number of bots for which package version is updated successfully
  - Number of bots for which package version update is unsuccessful
  - Number of bots for which package version update is pending
  - Total time elapsed in bulk package version update
  - User who started the bulk package update operation
  - All packages, bots, and dependencies selected by the user
- Enhanced compiler for accurate results

With an upgraded compiler, the Automation 360 platform improves the overall accuracy and outcome of the bulk package version update processes.

Related tasks

[Update bots to default package version](#) on page 1910

You can quickly update bots to a secure, stable, and default package version across multiple bots.

## Update bots to default package version

You can quickly update bots to a secure, stable, and default package version across multiple bots.

- To update bots to the default package version, ensure you have the View packages permission and the permission to edit bots .

When you begin the bulk update process, this action updates the bots in a **Public** workspace for which you have check-out permission, and any bots using the non-default version of the specific package.

- To view the **Bot update** page in the Control Room and to view the bulk update reports, ensure that you have the **View bot update** permission.
- To perform the bulk package update action, ensure that you have the **Manage bot update** permission.
- Verify the bots are compatible with the current default version of the package.
- Navigate to **Administration > Settings > Bots > Bot validation** to turn on the bot validation.
- When you update the bots to the default package version, ensure that the bots are not checked out until the process is completed.
- Do not disable the package while the bulk update process is running.

1. Navigate to **Administration > Bot update**.
2. Click the **Update Bots** drop-down and click **Package Version**.
3. On the **Update - Package Version** page, define the settings.
  - a) **Name**: Shows a system-generated name for the update function.
  - b) Optional: **Description**: Add a description for the update package version function.

- c) If the current version is higher than the default version, then downgrade the current version by selecting the **Downgrade version if the current version is greater than default** option.
- d) View and search the list of available packages by the **Status, Name, and Version**.
- e) Select the required packages and click the right arrow (→) to add your selection.
- f) Select the required packages from the selection list and click **Next**.

You are redirected to the **Bots** section.

4. On the **Select bots to update** page, update bots and dependencies.
  - a) Select a Task Bot to process in the queue from the list.
    - Latest version: Click the **Latest version** tab to select the latest version of the bot.
    - Production label: Click the **Production label** tab to select the labeled version of the bot.

By default, the Bots folder is selected.

---

**Tip:** Use the search field to find a Task Bot quickly.

---

If you select the **Production label** option for the parent bot, then the corresponding dependent bots with the **Production label** are also automatically selected. If any of the dependent bots do not have the **Production label** applied, then the latest version of the bot is selected.

- b) Select a Task Bot to process in the queue from the list.
- c) From the list of available bots, select the required bots for which you want to update the package version.

---

**Note:** You can select a maximum of 100 bots with the dependencies for bulk package update.

---

You can select bots based on the following parameters:

- Type: Select one of these values: Folder, Task Bot, .ATMS Task Bot, .MBOT Task Bot, Form, and Process.
  - Name: Search the required bot by its name.
  - Code Analysis results: Select one of these values: N/A, Not scanned, No violations, Low severity, and High severity.
- d) Click the right arrow (→) to add your selection.
  - e) Select the required bots from the selection list and click **Next**.

You are redirected to the **Bots and Dependent Bots** section.

5. Review the selected bots and dependencies that you selected for the update.
6. Click **Update-Package Version**.

The system starts updating all the selected bots and dependencies in the Control Room repository which contain the selected packages. If any of the bots are not using the default version of the packages, those bots are updated.

The **Bot update list** page displays status, name, start and end time, and duration required for the update. It also displays the number of completed, failed, skipped, and total items with last modified time, and user details (such as username) who initiated the package update.

7. On the **Bot update list** page, click the three dot icon next to the required update and click **View update bot details** to view a detailed report.

A report displays the following information:

- **Summary:** Summary of the package update process with selected bots and dependencies.
- **Settings:** Settings defined in the package update process with selected packages.
- **Results:** Result of the package update process with these details such as status, type of bot, name of the bots and dependent files, folder path, name of the Bot Runner, and reason why the bot skipped or failed status.

For an example of this procedure, see [Example of updating default package version across bots](#) .

Related tasks

[View audit log for bulk package updates](#) on page 1912

You can view audit log details for bulk package updates and bots. It also provides detailed information of updated bots and events that you can download to a CSV file.

[Example of updating default package version across bots](#) on page 3259

This example shows how to perform a bulk update of multiple bots in the Control Room repository and use the default version of the Excel advanced and Message Box packages.

## View audit log for bulk package updates

You can view audit log details for bulk package updates and bots. It also provides detailed information of updated bots and events that you can download to a CSV file.

1. Navigate to **Administration > Audit log**.
2. On the **Audit log** page, search the package update entry by the **Update default package** event type.

You can also view and search the **Update-Package Version** details by using the following filters in the **Audit log**:

- **Status:** Status of the update package version request
  - **Time:** Time at which the update had completed
  - **Item name:** Name of the update package version request
  - **Event type:** Type of the event such as **Update default package to bot requested**
  - **Event started by:** Name of the user (username) who initiated the update package version request
  - **Source device:** Device on which the update package version request was initiated
  - **Source:** Source of the request such as Control Room
  - **Request ID:** Unique ID for the update package version request
3. To view the event details, click the three dots icon next to the required event and click **View event details**.
    - **Event details:** Displays information such as status, details of the user who started the event, the user's device details, the request ID number, date and time of the initiated request, event type, and source of the request.



- **Update default package details:** Displays information such as name of the request, change in package version, name of the package being updated, and version of the package you are currently on.
4. Click the required bot to view the following information:
    - **Request name:** Displays the name of the initiated request
    - **Bot path:** Displays the file or folder path where the bot is located
    - **What changed:** Displays information on what was changed for the bot
    - **Package name:** Displays the name of the package
    - **Old package version:** Displays the previous version of the package
    - **Target package version:** Displays the version to which the package is being updated
    - **Old bot version:** Displays the previous version of the bot
    - **New bot version:** Displays the current version of the bot that is being updated
    - **Remark:** Displays any comments or remarks

During the bulk update process, some bots might fail to update the default package version. The failed bot displays an unsuccessful status on the **Audit log** page. For example, if the bots are checked out during the update package process, the package version update is not performed for these bots and they fail.

5. To download the audit data to a CSV file, select the required entry and click **Export checked items to CSV**.  
A CSV file containing the audit log details is downloaded to your local system.

Related tasks

[Update bots to default package version](#) on page 1910

You can quickly update bots to a secure, stable, and default package version across multiple bots.

[Example of updating default package version across bots](#) on page 3259

This example shows how to perform a bulk update of multiple bots in the Control Room repository and use the default version of the Excel advanced and Message Box packages.

## Manage Control Room packages

Manage packages in the Control Room by setting a package as default, disabling it, or deleting it.

Ensure that you are logged in to the as the administrator.

To manage packages in the Control Room, users must have **Manage package** permission.

Package management actions apply to all users; however, the user can select specific package versions within a bot.

1. Navigate to **Manage > Packages**.
2. Hover over the **Actions** icon for the package.
3. Click **View**.
4. Choose any of the following options:

Option	Description
Set as default	<p>Select a package and set it as the default. As soon as a package is set to default, it is the package that all Bot Creators in the Control Room use.</p> <hr/> <p><b>Note:</b> By default, new versions of packages become the default version and will only be used the first time that package is used in editing a bot. If a bot already uses the package, it continues to use an earlier version.</p> <hr/>
Disable	<p>Disable a package so that users cannot use it to create new bots. Bots that were created using a disabled package continue to work.</p>
Delete	<p>Deleting a package removes the actions contained in the package from the Control Room for all users.</p> <p>You can delete a package version if:</p> <ul style="list-style-type: none"> <li>• A Control Room user with <b>Manage package</b> permission added the package version. However, you cannot delete any package versions that were automatically installed by the system, or through a Control Room new installation or upgrade; you can only disable them.</li> <li>• The package version is not in <b>Default</b> status.</li> <li>• The package has only one version, but its status is <b>Default</b>.</li> </ul>

**Important:** A package cannot be deleted if it is being used by a bot.

Related concepts

[Packages](#) on page 1898

A package in Automation 360 is a collection of actions that you use and configure to build automations.

Related tasks

[Add packages to the Control Room](#) on page 1908

Administrators can add packages to the Control Room for use by Bot Creators.

## External key vaults for Automation 360

Key vaults provide a secure, encrypted storage space for sensitive data used by automation.

Customers' sensitive data can be accessed and used by their automation platform by storing the

data in corporate-approved key vaults such as CyberArk Password Vault, AWS Secrets Manager, Azure Key Vault, or HashiCorp Vault.

Automation Anywhere provides a secure key vault called Credential Vault. Requirements for external key vault usage are generally related to certain compliance standards and corporate security policies implemented by your IT and IT security groups. As part of their data security policies, these groups select and maintain corporate key vault services, and define the standards for the protection of sensitive data. Integrating Automation 360 Control Room with external key vaults enables you to store credentials for security and compliance.

---

**Note:** External key vault integration is not supported on Oracle Database.

---

## Users and roles

The following users typically configure and work with external key vaults:

Automation Administrators	Automation Administrators who have AAE_Admin and AAE_Locker_Admin roles with permissions to administer Automation 360 Control Room and Credential Vault instances. The Automation Admin works with the customer External Key Vault Admin.
Customer External Key Vault Administrators	Customer External Key Vault Administrators who are responsible for the administration and management of the external key vault tasks (for example, setting up, managing, and creating access policies).

## Benefits

The Automation Anywhere Credential Vault is secure and provides deep integration with the automation platform. However, because corporate IT must provide secure data services as part of their IT security policies, the automation platform might be required to use external key vault technology to comply with corporate standards.

External key vaults enable the automation platform to fully comply with corporate requirements and can provide these additional benefits:

- Deep integration with the Identity Provider (IdP) and corporate authentication platforms such as single sign-on (SSO) and Directory Services (such as Microsoft Active Directory).
- Support of password rotation and synchronization with the systems used with the automation platform.
- Administration of the key vault and security best practices are performed by the IT group who manages the external key vault instead of the automation administrators. As a result, the automation platform becomes a consumer of the credential service.

## Guidelines

External key vault integration guidelines support the operation of the automation platform relating to the coordination, configuration, and consumption of credentials and sensitive data from the external key vault technology.

- **Coordination:** Establish designated contacts for the key vault and automation platform technologies and identify the individuals responsible for communicating operational guidelines, security policy, and compliance requirements for credential management.
- **Configuration:** Designated contacts collaborate on the use case implementation and configuration requirements of the automation platform and the external key vault.
- **Consumption:** Based on which use cases are implemented, designated contacts monitor the integration of the automation platform and the external key vault and coordinate credential rotation and naming requirements.

## Integrating external key vault with Control Room

Automation Anywhere Control Room supports these external key vaults: CyberArk Password Vault, AWS Secrets Manager, Azure Key Vault, and HashiCorp Vault.

---

**Note:** The CyberArk mark and logo, the Amazon Web Services mark and logo, the Microsoft Azure mark and logo, and the HashiCorp mark and logo, are trademarks or registered trademarks of CyberArk Software Ltd, Amazon Web Services, Inc, Microsoft Corp., and HashiCorp, Inc., respectively, and are used for identification purposes only.

---

## Use cases

The following use cases are supported:

Control Room bootstrap	Retrieval of credentials used by the Control Room to authenticate to supporting services such as database and Control Room software service account.
Control Room system	Retrieval of credentials used by the Control Room for Active Directory (AD) and email (SMTP) integration.
Agent auto-login	Retrieval of credentials used by the RPA platform to launch automations on designated Automation 360 Bot Agent devices.
Agent automation	Retrieval of credentials that the automation (bot) uses during runtime to perform authentications to the applications that are being automated.

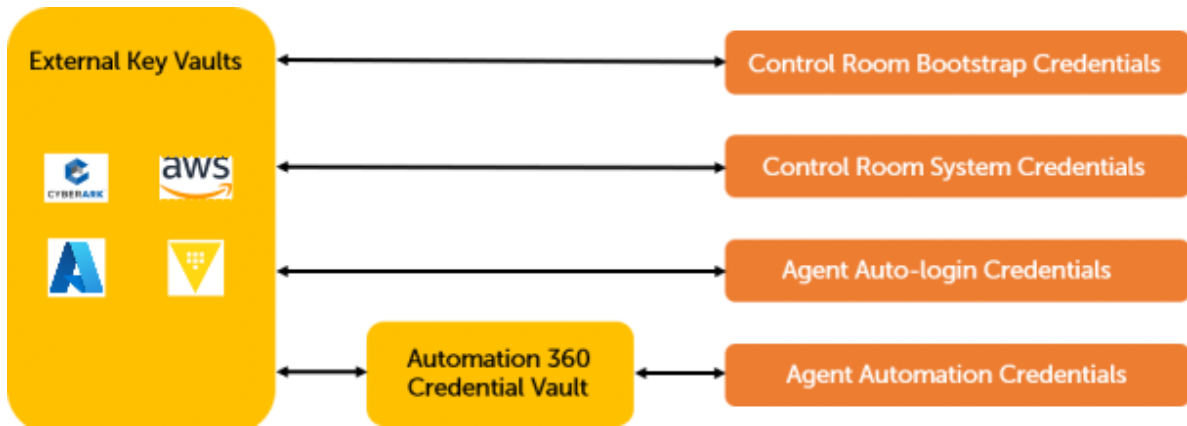

## Plan your integration

Before you integrate your external key vault with the Automation 360 Control Room, you need to develop an overall external key vault strategy.

The answers to these questions will help determine the integration requirements for the external key vault.

What type of Automation 360 Control Room deployment do you have: On-Premises or Cloud?

- On-Premises: The Control Room and external key vault are hosted at the customer's site and environment.

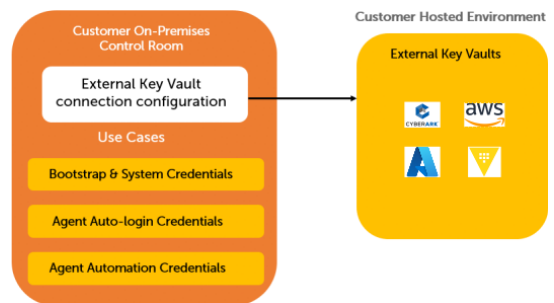

The external key vaults might contain these external key vaults hosted within the customer site (customer-controlled datacenter or environment):

- CyberArk Password Vault – Customer On-Premises environment
- AWS Secrets Manager – Customer AWS environment
- Azure Key Vault – Customer Azure environment
- HashiCorp Vault – Customer HashiCorp environment

You can configure the external key vault connection during initial installation or post-installation using the key vault utility.

- Cloud: The Control Room is hosted on the Automation 360 Cloud environment and the external key vault is hosted within the customer site (where the customer-controlled datacenter is either On-Premises or in a Cloud environment such as AWS):

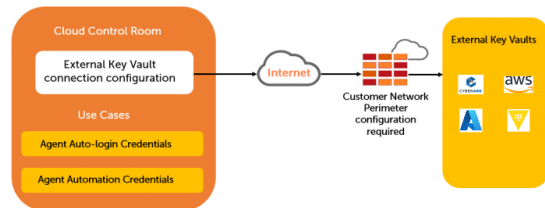

The key vault in the customer network requires connection to the Automation 360 Cloud Control Room. You configure the connection to the external key vault from the Automation 360 user interface. Customer network perimeter configuration is required.

What type of third-party external key vault do you have?

CyberArk Password Vault, AWS Secret Manager, Azure Key Vault, or HashiCorp Vault.

Each external key vault has their own specific requirements. Review all configuration requirements with RPA and external key vault administrators before starting the integration.

What type of credentials do you need to retrieve from the external key vault based on the supported use cases?

By integrating the Automation 360 Control Room with your external key vault, you can retrieve credentials that support these use cases:

Use case	Credenti:	Supporte	Credenti:	Credenti:
		deplym	caching	rotation
Control Room bootstrap and start the Control Room services (Service account)	Used to authenticate the database (optionally)	On-Premises only	Caches the retrieved values	You should rotate the database credential during scheduled downtimes

Use case	Credential deployment	Supported	Credential caching	Credential rotation
Control Room system	Used to authenticate Active Directory (AD), Service account, and SMTP	On-Premises only	Caches the retrieved values	You should rotate the AD, Service account, and SMTP credentials during scheduled downtimes
Agent auto-login	Used by Bot Agent to perform auto-login on a Bot Agent device before launching an automation	On-Premises and Cloud	Does not cache values from external key vault	Always retrieves the latest available credential rotated in the external key vault
Agent automation	Used by the automation to authenticate to the applications being automated	On-Premises and Cloud	Does not cache values from the external key vault	Always retrieves the latest available credential rotated in the external key vault

### Coordinate with external key vault admin team

To ensure a productive, efficient, and rapid integration with the external key vault, you must coordinate with the external key vault administration team and exchange the technical requirements of the RPA platform. By carefully planning and coordinating with the external key vault administration team, you can quickly integrate the Automation Anywhere Control Room with the external key vault and avoid time-consuming troubleshooting issues.

We suggest you follow these guidelines to structure your integration process:

- Review the supported credential use cases to determine which credentials the RPA platform requires to retrieve from the external key vault.
- Schedule a kick-off meeting with the external key vault administration team to exchange information for these details:
  - Which key vault to use?
  - Which use cases to configure?
  - What are the credential naming conventions required by the RPA platform?
  - How are the credentials configured and updated on the external key vault?
  - Does the external key vault have multiple instances (multiple instances of the external key vault can be used for different Automation Anywhere Control Room instances)?
  - Who are the designated contacts for the RPA platform and key vault administration?
- Review the configuration requirements for the Control Room:
  - Are you installing a new Control Room with key vault integration?  
If so, then review the installation procedure for the external key vault integration.
  - Are you configuring an existing Control Room to use external key vault integration for the first time?  
If so, then review the key vault utility usage procedure to configure key vault integration post-installation.
  - Is the Control Room an Automation 360 Cloud Control Room that will connect to an on-premises key vault?  
If so, then you must coordinate with your IT networking team to configure connectivity between the Cloud Control Room and your internal network.
- Review the external key vault configuration procedure and note all integration settings requirements:
  - Key vault configuration requirements to configure on the external key vault before integration
  - Control Room operating system configuration
  - Authentication method that the Control Room will use to connect to the external key vault
- Schedule integration meetings to coordinate these configuration and set up tasks for the Control Room and external key vault administrators:
  - Configuration of the key vault connection
  - Configuration of each use case
  - Testing of each use case

---

**Note:** These integration meetings should be ongoing until you have configured and tested all use cases.

---

- Add the external key vault integration to regular IT cadence meetings to monitor the operation of the Control Room and the external key vault, specifically credential rotation coordination.



## External key vault naming conventions

Specific authentication credentials and external key vaults have restrictions on the use of certain characters in usernames, phrases, and other text. Also, there are different naming conventions to follow based on the external key vault and the credential use cases: Agent auto-login or Agent automation.

### Agent auto-login naming conventions

For CyberArk, all Agent auto-login credentials are retrieved from the specified safe name and assumed to exist within the Auto-login Credential Safe. For AWS Secrets Manager, Azure Key Vault, and HashiCorp Vault, the Agent auto-login credentials must adhere to the required naming conventions detailed on this page.

If the Control Room performs an auto-login credential retrieval but no credential exists in the Auto-login Credential Safe that matches that user name, then the auto-login will fail. For any unattended automations, all robotic or digital worker user IDs must have an auto-login credential configured for each Control Room user within the external key vault.

The Control Room retrieves auto-login credentials based on the object naming convention within the external key vault. The Control Room searches for an object where the object name (the credential name in the external key vault) matches the Control Room username for which it is performing auto-login.

The prefix `autologin_` is required as part of the naming convention for auto-login credentials for all external key vaults: CyberArk, AWS, Azure, and HashiCorp. The name of the auto-login credential in the external key vault must contain `autologin_` followed by the Control Room username. In some cases, certain key vaults have restrictions on the characters that can be used in credential object names. Additionally, to support how different use cases encode credentials, Automation 360 requires that certain characters be reserved or encoded.

The following table lists examples of the object naming conventions expected in the Control Room:

Control Room username	Expected object name format
ABCD\user123	autologin_ABCD--user123
user123@rpa.abcd.com	autologin_user123-40-rpa-2e-abcd-2e-com
ABCD\user123	autologin_ABCD\user123
user123@rpa.abcd.com	autologin_user123@rpa.abcd.com
john	autologin_john

**Note:** For On-Premises customers using AD authentication, you must format auto-login usernames using the UPN format or `domain\username` postfix.

For auto-login credentials, keep these in mind:

- The object name in the external key vault must contain `autologin_` as a prefix.
- The auto-login credential names must map to the Control Room username (login ID) for the credential being retrieved.

Some external key vaults have usage restrictions of certain characters, such as backslash (\) and ampersand (@) in the secret name (object name), and restrictions on how special characters are interpreted within API calls. If the user ID contains special characters, then you must encode the secret name (object name) in the external key vault using ASCII code character substitutions, as listed in the following table.

This character	Changes to this ASCII code character substitution
\ (backslash)	--
- (dash)	-2d-
_ (underscore)	-5f-
@ (ampersand)	-40-
. (period)	-2e-

---

**Note:** Except for the backslash being mapped to double dashes, the dash, period, underscore, and ampersand are mapped using their ASCII code bracketed in dashes.

---

## Agent automation naming conventions

Agent automation credentials are credentials retrieved by the automation during runtime and used by the automation bot to authenticate with applications. Automation credentials retrieved from external key vaults are mapped in the Automation Anywhere Credential Vault using the **External Key Vault** option when configuring lockers and credentials.

The Automation Anywhere locker is mapped to either of the following:

- Safe Name (CyberArk)
- Secret Name Prefix (AWS, Azure, and HashiCorp)

A credential is mapped to either of the following:

- An Object Name (CyberArk)
- A Secret Name body (AWS, Azure, and HashiCorp)

---

**Note:** You can map any Automation Anywhere locker to any CyberArk Safe Name. The Safe Names used to map Automation Credentials should be distinct from the Safe Name used for auto-login.

---

To support the Automation Anywhere user-defined credentials functionality, you can create credentials using a Control Room\_username postfix because these credentials are retrieved based on the user context of the running bot. If you do not create user-defined credentials, then the automation bot credential retrieval process retrieves the system credential.

---

**Note:** For On-Premises customers using AD authentication, you must format Agent automation usernames using the UPN format or domain\username postfix.

---

External key vaults prohibit different special characters in secret names. As a result, you must encode some characters in the credential (secret) name in the external key vault based the type of external key vault (CyberArk, AWS, and Azure) you are using and its specific requirements.

HashiCorp secret naming convention

By default, the Control Room integration with HashiCorp allows the following characters without encoding:

- Uppercase characters (A–Z)
- Lowercase characters (a–z)
- Numerals (0–9)
- Special characters (+=)

For other special character, the secret name should have the ASCII encoded value for the special character. For example, an underscore character (\_) must be used as `-5f-`.

On-Premises deployments: To override the default characters encoded by the Control Room, add the following property and regex value in the `keyvault.properties` file located in the Automation Anywhere configuration directory. For example, use the following expression if you do not want to encode special characters: `name.encoding.characters.allowed.regex.hashicorp=[A-Za-z0-9/_+=.@-]+$`.

## CyberArk Password Vault automation example

The following table shows CyberArk external key vault examples using naming conventions for automation.

**Note:** The Safe Name maps to the locker for the Control Room, and the Object Name maps to the credential for the Control Room.

Automation credential example	Control Room username	Safe Name	Object in locker
System credential in locker mapped to Safe Name	None - system credential	finance	glaccess
User-defined credential in locker mapped to Safe Name	ABCD\RPA\user123	finance	glaccess_ABCD--RPA--user123
User-defined credential in locker mapped to Safe Name where username is encoded with ASCII mapping	ABCD\RPA.user123	finance	glaccess_ABCD--RPA-2e-user123

Configure username for different Automation 360 services using the CyberArk secret response

When configuring CyberArk settings for some of the Automation 360 services such as auto-login, Lightweight Directory Access Protocol (LDAP), and service credentials, you can optionally configure the username for the `Enter` property set to your CyberArk username option. Usernames can be a combination of values from the secret response or string literals.

The CyberArk secret response contains field values that you must enclose within dollar signs (\$) to construct the username. For example, to configure the username in the format `domain\username`, you must enter: `$$domain$$\$$username$$`. The domain and username values in this expression will be replaced with the corresponding values from the secret response.

## AWS Secrets Manager automation example

The following table shows AWS Secrets Manager external key vault examples using naming conventions for automation.

**Note:** The AWS Secret Name Prefix maps to the locker for the Control Room, and the AWS Secret Body maps to the credential for the Control Room.

Automation credential example	Control Room username	AWS Prefix	AWS Secret Body	Secret in AWS
accounting_pdf System credential in locker mapped to AWS Secret Name prefix <code>accounting</code>	None - system credential	accounting	pdf	accounting_pdf (system)
accounting_pdf_ABCD--user123 User-defined credential in locker mapped to AWS Secret Name prefix <code>accounting</code>	ABCD \user123	accounting	pdf	accounting_pdf_ABCD--user123

## Azure Key Vault automation example

The following table shows Azure Key Vault external key vault examples using naming conventions for automation.

**Note:** The Azure Prefix maps to the locker for the Control Room, and the Azure Secret Body maps to the credential for the Control Room.

Automation credential example	Control Room username	Azure Prefix	Azure Secret Body	Secret in Azure
accounting_cv1 System credential in locker mapped to Azure Secret name prefix <code>accounting</code>	None - system credential	accounting	cv1	pdf-5f-cv1 (system)

Automation credential example	Control Room username	Azure Prefix	Azure Secret Body	Secret in Azure
accounting_cv1_ABCD\user123  User-defined credential in locker mapped to Azure prefix	ABCDEF\user123	accounting	cv1	pdf-5f-cv1-5f-ABCD--user123

When deploying Azure credentials, the Azure Key Vault character underscore ( \_ ) is a reserved character and cannot be used in credential names. You must substitute any underscore ( \_ ) usage with the ASCII code value 5f bracketed by dashes:

This character	Changes to this ASCII code character substitution
\ (slash)	--
- (dash)	-2d-
_ (underscore)	-5f-
@ (ampersand)	-40-
. (period)	-2e-

### HashiCorp Vault automation example

The following table shows HashiCorp Vault automation examples using external key vault naming conventions.

**Note:** The HashiCorp prefix maps to the Control Room locker and the HashiCorp secret name maps to the Control Room credential.

Automation credential example	Control Room username	Locker prefix	Credential secret name	Secret name in HashiCorp
accounting_cred01  System credential in locker mapped to HashiCorp secret name prefix accounting	None - system credential	accounting	cred01	accounting-5f-cred01(system)

Automation credential example	Control Room username	Locker prefix	Credential secret name	Secret name in HashiCorp
accounting_cred01-ABCD\user123  User-defined credential in locker mapped to HashiCorp prefix	ABCD\user123	accounting	cred01	accounting-5f-cred01-5f-ABCD--user123
accounting_cred01_john  User-defined credential in locker mapped to HashiCorp prefix	john	accounting	cred01	accounting_cred01_john
<p><b>Note:</b> This example shows values without encoding.</p>				

## CyberArk Password Vault integration

You can integrate Automation 360 to retrieve credentials from the CyberArk Password Vault. The credentials become resident within the CyberArk Password Vault where they are managed, rotated, and synchronized.

**Note:** The CyberArk mark and logo are trademarks or registered trademarks of CyberArk Software Ltd and are used for identification purposes only.

You integrate the Automation 360 Control Room by connecting it to the CyberArk Password Vault through the CyberArk Central Credential Provider (CCP) APIs. No additional licensing is required to integrate with the CyberArk Password Vault or use the CCP APIs.

**Note:** We recommend that you control access to the CyberArk Password Vault through an IP address.

You can integrate Automation 360 with the CyberArk Password Vault using either of these deployments:

- Cloud
- On-Premises

The following diagram shows an Automation 360 Cloud deployment where the Control Room is hosted on AAI Cloud:

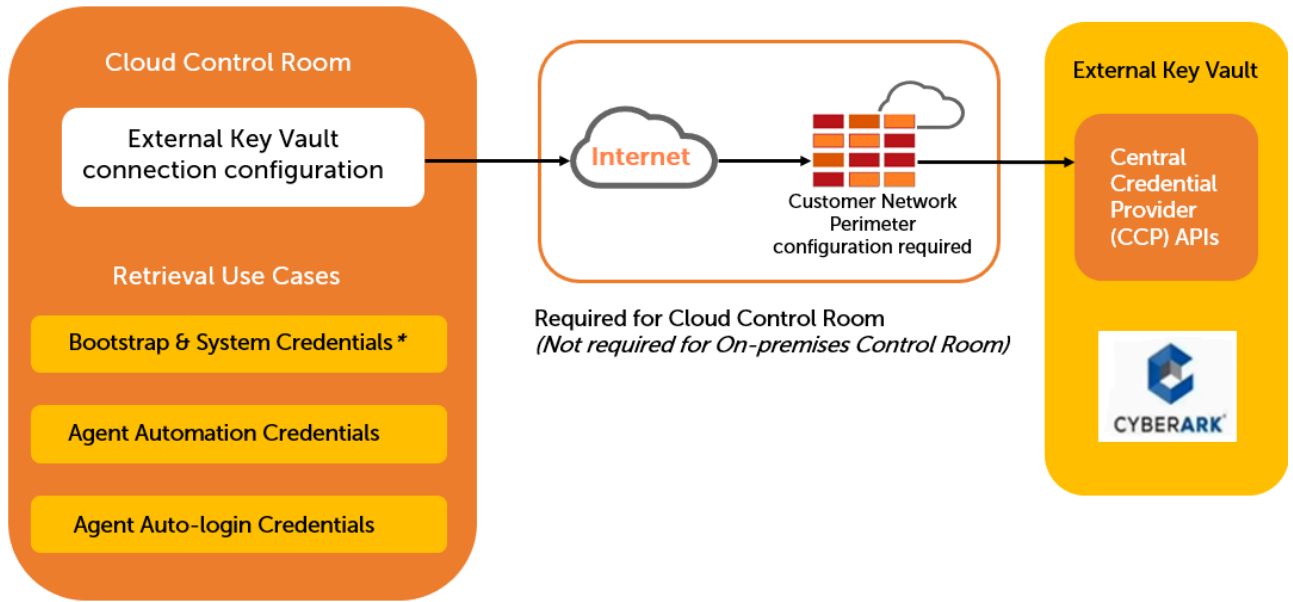

\*On-premises only

For On-Premises deployments, you deploy the following:

- Control Room as software within your customer environment.
- Bot Agent within your customer environment where automations run and access customer applications.

**Important:** You can edit the external key vault connection settings through the user interface in Cloud deployments only. External key vault settings in On-Premises deployments are only configurable during installation or with the key vault utility post-installation.

## CyberArk Password Vault integration requirements

- [Install CyberArk Central Credential Provider](#) on page 1927
- [Implement X.509 client certificate authentication method](#) on page 1928
- [CyberArk Central Credential Provider API configuration requirements](#) on page 1929
- [Review CyberArk Credential terminology and identifiers](#) on page 1930
- [Define CyberArk application ID](#) on page 1931
- [Provision accounts in CyberArk Password Vault](#) on page 1932
- [Set up access to the application and password providers](#) on page 1932

## Install CyberArk Central Credential Provider

You must install and configure the CyberArk Central Credential Provider on the CyberArk server. See [CyberArk Central Credential Provider installation](#).

## Implement X.509 client certificate authentication method

An X.509 client certificate is a type of digital certificate used by client systems to make authenticated requests to a remote server and uses the widely accepted international X.509 public key infrastructure (PKI) standard to verify that a public key belongs to the user, computer, or service identity contained within the certificate.

The Automation 360 Control Room uses a client certificate as the authentication method when connecting to the CyberArk CCP APIs.

This authentication method is highly secure and leverages the system's truststore to store the client certificate, server certificate, and private key. The truststore is a certificate storage location provided by the operating system's software and it contains the issuing Certificate Authority's (CA) certificate. You can import individual server certificates into the truststore. However it is more efficient to import the issuing Certificate Authority (CA) certificate.

The following image provides an overview of certificate-based authentication:

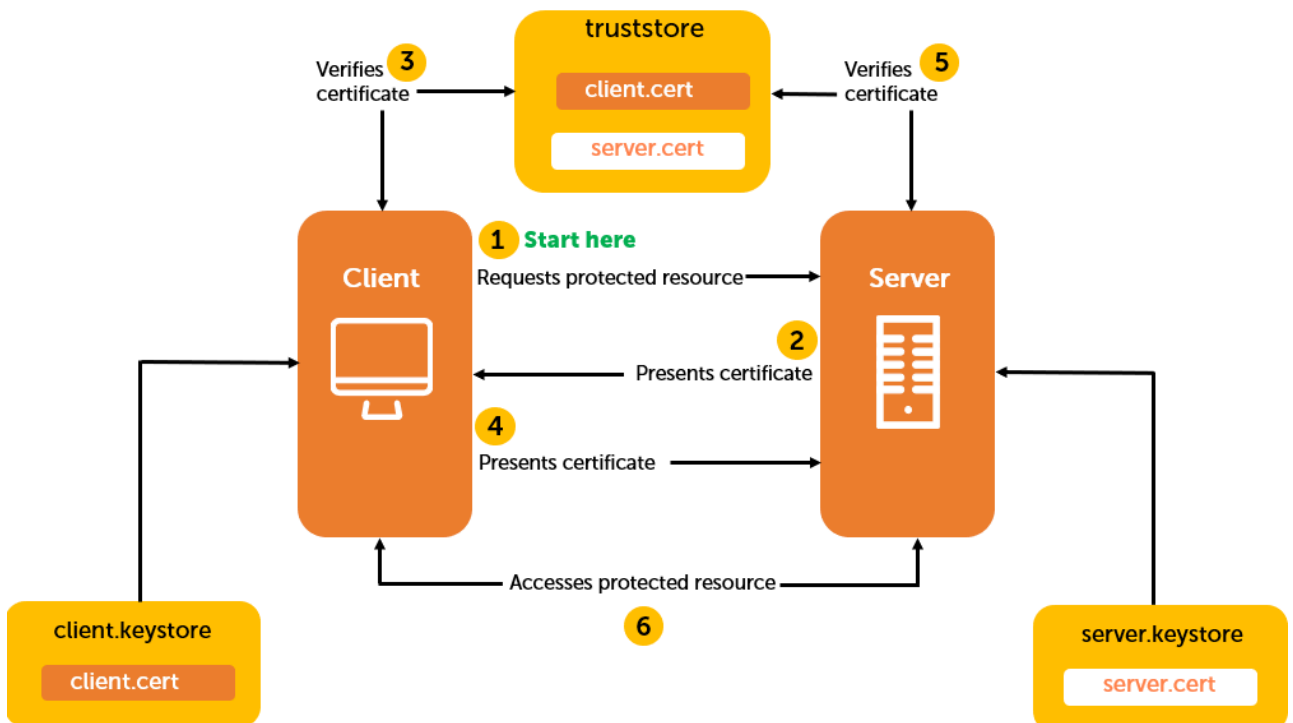

1. The client (Automation 360 Control Room) sends a request to the CyberArk AIM server (protected resource).
2. The server then responds by sending a certificate back to the client.
3. The Automation 360 Control Room verifies the certificate sent by the CyberArk AIM server by validating it against the trusted server certification information stored in the public part of the Control Room truststore.
4. After validating the information in the truststore, the Automation 360 Control Room resends the certificate back to the CyberArk AIM server.
5. The CyberArk AIM server then validates the certificate sent by Automation 360 Control Room against the trusted client certification information stored in the public part of the AIM server truststore.



Because client certificates (those with their private key) are generally distributed in password protected format, the certificate file (using .p12 format, such as: `c:\PATH\aaeCyberArkCertificate.p12`) requires a passphrase.

6. Both parties (client and server) gain access to the protected resources if the certificates pass validation based on the following:
  - The Control Room certificate must be trusted by the CyberArk AIM server
  - The Control Room must trust the certificate on the CyberArk AIM server
  - The Subject field in the certificate matches the calling system's Fully Qualified Domain Name (DNS Name)
  - The certificate has not expired

---

**Important:** As part of the integration planning phase, coordinate certificates and requests for certificates. You will have to request that certificates be issued by the Public Key Infrastructure (PKI) team before you can begin integration configuration. The certificate files are stored in the PKI folder and accessed with the Control Room passphrase when required. The Control Room passphrase is stored encrypted in the `keyvault.properties` file.

---

## CyberArk Central Credential Provider API configuration requirements

You must have network connectivity between the Automation 360 Control Room and the CyberArk AIM server. The Automation 360 Control Room is connected to the CyberArk Password Vault through the CyberArk Central Credential Provider (CCP) APIs for both On-Premises or Cloud deployments.

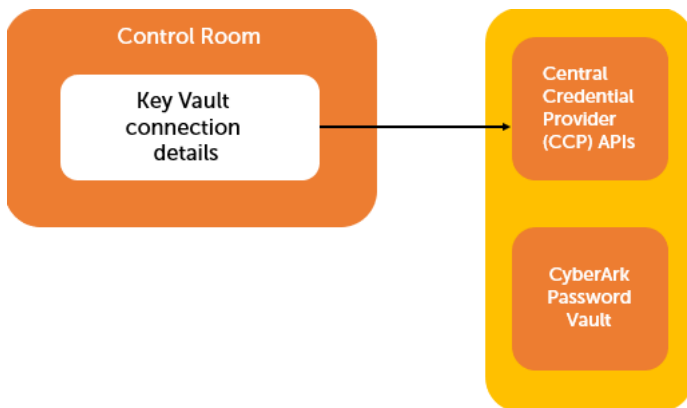

---

**Note:** No additional licensing is required to use the CCP APIs.

---

To use the CCP API, you must set these required parameters:

- Automation 360 v.20 (supports bootstrap credentials with On-Premises deployment only)
- Automation 360 v.21 or later (supports all bootstrap and system use cases for On-Premises deployments, auto-login, and automation credentials for both On-Premises and Cloud deployments)
- The Control Room Key Vault contains these connection details:
  - CCP API vault connection URL – For example: `https://<host:port>/AIMWebService/api/Accounts?`

- CCP API AppID – You must configure the CyberArk AIM server with an Application ID (AppID). For example: AACompanyControlRoom1.  
See [Define CyberArk application ID](#) on page 1931.
- X.509 client certificate with private key issued to the Automation 360 Control Room (The Control Room Fully Qualified Domain Name is in the Subject: field of the certificate) and configured with the CyberArk AIM server for authentication. For example: c:\PATH\aaeCyberArkCertificate.p12

---

**Note:** The .p12 format is required.

---

## Review CyberArk Credential terminology and identifiers

CyberArk and Automation Anywhere use different terminology to describe and identify credentials:

Description	CyberArk	Automation Anywhere
Where credentials are stored	object	credentials
Primary partitioning of the key vault	safe (contains objects)	locker (contains credentials)

- Credentials in CyberArk are stored in objects, and each object is contained in a safe. A single CyberArk instance can have multiple safes, where each safe has access controls for users.
- Credentials in Automation Anywhere are stored in lockers, where each locker has access controls for Control Room users.

CyberArk identifies credentials by safe name AND object name. The CCP API uses a CyberArk safe name and CyberArk object name to access credentials within the CyberArk Password Vault (the credential must exist in CyberArk).

The following is a code sample CCP API call and corresponding response:

```
https://<host:port>/AIMWebService/api/Accounts?
AppID=BillingApp&Query=Safe=Billing;Object=MonthlyBilling
```

Response

```
{
  "Content": "",
  "PolicyID": "CyberArk",
  "CreationMethod": "PVWA",
  "Folder": "Root",
  "Address": "address tbd",
  "Name": "Application-CyberArk-address tbd-vb",
  "Safe": "aa_vb_safe",
  "DeviceType": "Application",
  "UserName": "vb",
  "PasswordChangeInProgress": "False"
}
```

The credential value or secret (for example, the password) is stored in the `Content` attribute and the User ID (the Control Room user name, for example `vb`) is stored in the `UserName` attribute.

## Define CyberArk application ID

Automation 360 integrates with CyberArk Password Vault through the CyberArk Central Credential Provider (CCP) API. The application ID (AppID) is a required configuration parameter.

As a CyberArk Administrator, use the CyberArk Password Vault Web Access (PVWA) interface to define the application ID by following the specified procedure to prepare the CyberArk AIM server for integration with the Control Room. See [CyberArk Password Vault Web Access](#).

1. You must log in as a user allowed to manage applications on the CyberArk platform (requires Manage Users authorization).
2. From the **Applications** tab, click **Add Application**.
3. From the **Add Application** panel, enter the following information:

Option	Action
Name	Specify the unique name (ID) of the application. We recommend using a name based on the Control Room name or function, for example: <code>AACompanyControlRoom1</code> .
Description	Enter a short application description used to help identify it.
Business owner	Enter contact information about the application's business owner.
Location	Select the application location in the Vault hierarchy. If a location is not selected, the application will be added in the same location as the user who is creating this application.

4. Click **Add** to add the new application and display it on the **Applications Details** page.
5. From the **Applications Details** page, select the **Allow extended authentication restrictions** check box to specify an unlimited number of machines and Windows domain OS users for a single application.
6. From the **Authentication** tab, click **Add** to add details to the new application.

A list of available authentication characteristics are displayed, which the Credential Provider uses to verify before retrieving the application password.

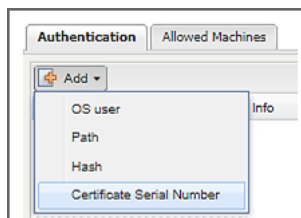

7. Optional: Select **OS user** and enter the name of the user who will run the application, and then click **Add** to add the OS user to the list of users in the **Authentication** tab.

8. Select **Certificate Serial Number** and enter the certificate serial number for the Control Room client certificate, and then click **Add**.
9. (Automation 360 recommended): From the **Allowed Machines** tab, click **Add**, and specify the IP/host name/DNS address where the application is allowed to run and request passwords.  
CyberArk AIM uses this address to ensure that only applications which run from specified machines can access their passwords.
10. Click **Add** to add the IP address to the list of allowed machines.

## Provision accounts in CyberArk Password Vault

Before an application can function, you must give the application access to existing user accounts or to new user accounts to provision in the CyberArk Password Vault.

Use the Password Safe to provision the privileged user accounts required by the application. You can provision accounts using one of these methods:

- Manually add accounts one at a time, and then specify all the account details.
- Automatically add multiple accounts using the Password Upload feature. To add account automatically, you must have authorization to the **Add accounts** feature in the Password Safe.

For details about adding and managing privileged accounts, see [Privileged Access Manager - Self-Hosted](#).

## Set up access to the application and password providers

After the user accounts have been provisioned by CyberArk, you must set up access to both the application and to CyberArk Application Password providers who are serving the application.

From where the Central Credential Provider is installed, add the provider user and application users as members of the Password Safes (where the application passwords are stored). You can add the users using one of these methods:

- Manually from the **Safes** tab
- By specifying the Safe names in the CSV file when adding multiple applications

To add users as safe members, from the **Add Safe Member** dialog box, add the provider as a safe member with these access authorizations selected, and then click **Add**:

- Retrieve accounts (Access)
- List accounts (Access)
- View Safe Members (Monitor)

**Add Safe Member**

Search:  Search In: **Vault**

Selected Search: Vault

Name	Business Email	Full Name
------	----------------	-----------

**Access**

- Use accounts
- Retrieve accounts
- List accounts

**Account Management**

**Safe Management**

**Monitor**

- View Audit log
- View Safe Members

**Note:** When installing multiple providers for the CyberArk Password Vault integration, we recommend that you first create a group for them, and then add that group to the safe with the same selected access authorizations.

To add application (AppID) as a safe member, perform these steps:

1. From the **Add Safe Member** dialog box, add the (AppID) as a safe member with Retrieve accounts (Access) selected as the access authorization.
2. Click **Add**.

If the safe is configured for object level access, ensure that both the provider user and the application have access to the passwords to retrieve. For details about adding and managing privileged accounts, see [Privileged Access Manager - Self-Hosted](#).

## Cloud integration using CyberArk Password Vault

You connect and integrate the external CyberArk Password Vault to the Automation 360 Control Room.

**Note:** The CyberArk mark and logo are trademarks or registered trademarks of CyberArk Software Ltd and are used for identification purposes only.

The following image shows CyberArk Cloud integration with the Control Room:

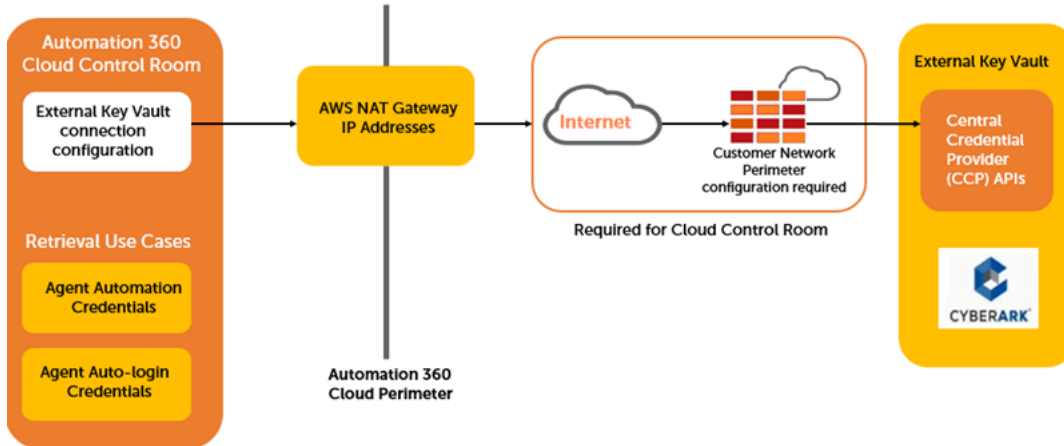

You must configure the customer network perimeter firewall to allow access to the `CyberArk_CCP_hostname:port` from the Automation 360 Cloud AWS NAT Gateway IP addresses.

The following table provides an example of how to configure the customer perimeter firewall:

From	To	Protocol used
Control Room in Automation 360 Cloud: Three AWS NAT Gateway IP addresses	CyberArk_CCP API_hostname:port For example: cyberarkpww.dev.abcd.com:4043	TLS Encrypted CCP API (TLS mutually authenticated)

For more details, see [Control Room IP addresses for external integrations](#) on page 1829.

For Cloud integrations, you can configure the Control Room and external key vault integration using the Automation 360 Control Room user interface.

The Agent auto-login and Agent automation use cases are only supported on Automation 360 Cloud Control Room instances. Neither of these use cases affect the Control Room boot sequence or Control Room functionality.

**Note:**

- Bootstrap and service account credential retrieval use cases are not supported on Cloud Control Room instances because the database and services are managed internally by Automation Anywhere. There is no compliance use case (requirement) for these credentials to be stored in the customer external key vault.
- If you are using CyberArk in an Automation 360 Cloud deployment, then the CyberArk external key vault must be reachable from the Cloud Control Room through the network perimeter firewall rules. For external firewall rules configuration details, see [Control Room IP addresses for external integrations](#) on page 1829.

1. Gather the specific CyberArk information required to configure the external key vault connector using the Automation 360 Control Room.

Item	Description
Vault URL	<p>The CyberArk AIM server CCP API URL (for example: <code>https://&lt;hostname&gt;:&lt;port_num&gt;/</code>)</p> <hr/> <p><b>Note:</b> To access the CCP APIs, the Control Room will automatically append <code>/AIMWebService/api/Accounts?</code> to the vault URL you enter. As a result, you must configure the Web Service on the CyberArk AIM server as <code>AIMWebService</code></p> <hr/>
Application ID	<p>The CCP API AppID (for example: <code>AAEControlRoom</code>).</p> <p>For details, see <a href="#">Define CyberArk application ID</a> on page 1931.</p>
Certificate file	<p>Enter the path to the client certificate issued to the Control Room server.</p> <p>The client certificate file that is issued for the Control Room is a .p12 file that contains the private key. CyberArk admins configure this file on the CyberArk server. After configuring the certificate file, it is used to authenticate every client request that is sent from the Automation 360 Cloud Control Room to the CyberArk server.</p> <p>The certificate will be issued to the Cloud Control Room (Subject: field of the certificate will contain fully qualified domain name (FQDN) of the Control Room) by the customer internal certificate authority.</p>
Certificate file password	<p>A password used to open the certificate file.</p>

Item	Description
Server certificate - PEM format	<p>(Required only for Cloud integration): The server certificate without the private key of the CyberArk AIM server (Subject: field of the certificate will contain the FQDN of the CyberArk AIM server).</p> <p>This server certificate is a public certificate for the URL where CyberArk is hosted. This certificate is in the PEM text format and contains the Subject Alternative Names (SAN) on which the CyberArk is listening to requests. For more information, see <a href="#">CyberArk CACert</a>.</p>

2. Log in to the Automation 360 Control Room as the Administrator.
3. From the Control Room, navigate to **Administration > Settings > External key vault**.
4. Click the **Edit** icon to open the **Configuration settings** pane.
5. Click **CyberArk** and then enter the specific CyberArk information described in the preceding table.
6. Click **Save changes** to connect the external key vault.

## On-Premises integration using CyberArk Password Vault

As an Automation 360 administrator, you can configure the CyberArk On-Premises integration using one of these methods: initial installation or post-installation using a command-line interactive key vault utility.

Within the On-Premises installation wizard, bootstrap credential retrieval from external key vault configuration options are only available if you first configure the key vault connection. The configuration options vary based on the external key vault you select.

---

**Note:** If you are using CyberArk in an Automation 360 Cloud deployment, then the CyberArk external key vault must be reachable from the Cloud Control Room through the network perimeter firewall rules. For external firewall rules configuration details, see [Control Room IP addresses for external integrations](#) on page 1829.

---

Choose your integration method:

- [Initial installation](#)
- [Post-installation using key vault utility](#)

## On-Premises initial installation using CyberArk Password Vault

Using the initial installation method, you can connect and configure the external key vault connector, service account credential (Active Directory administrator password), and bootstrap (database) credential identifier.

---

**Note:** You must select Microsoft SQL Server Authentication as the database; other database authentication methods are not supported for this use case.

---



The initial installation supports a `password-less` installation regarding the Control Room bootstrap credentials. The password-less installation identifies the bootstrap credentials by the Safe name and Object name within CyberArk.

You can configure the SMTP and AD credential identifier to retrieve from the external key vault using the Automation 360 user interface.

1. After you start the Automation 360 installation wizard, select **On-premises** as the **Deployment Option** and click **Next**.
2. Accept the license agreement and click **Next**.
3. Select **Custom** as the **Installation Type Preference** and click **Next**.
4. Accept the default locations for the destination folders and click **Next**.
5. To connect and configure the external key vault integration, select **CyberArk**.
  - a) In the **Vault URL** field, enter the CyberArk AIM server CCP API URL (for example: `https://<hostname>:<port_num>/`).

---

**Note:** To access the CCP APIs, the Control Room will automatically append `/ AIMWebService/api/Accounts?` to the vault URL you enter. As a result, you must configure the Web Service on the CyberArk AIM server as `AIMWebService`.

---

- b) In the **Application ID** field, enter the CCP API AppID (for example: `AAEControlRoom`).
  - c) Enter the path to the CyberArk AIM server certificate (in `.pem` format using `.p12`) issued to the Control Room server (The certificate Subject: field contains the Control Room fully qualified domain name (FQDN)).

This certificate must be trusted by and configured within CyberArk.
  - d) Click **Upload Certificate** to store on the Automation 360 Control Room server.
  - e) Enter the certificate file passphrase used to access the Control Room certificate file.
  - f) Optional: If the issuing Certificate Authority (CA) of the CyberArk server certificate is not trusted by the Control Room, then enter an optional server certificate.

This is the server certificate for the CyberArk server without a private key (the certificate Subject: field contains the CyberArk AIM Server FQDN). The installer will add the optional CyberArk Server certificate to the truststore used by the Control Room.
  - g) Click **Next**.
6. Accept the default settings from the **TLS Configuration** dialog box and click **Next**.
  7. From the **Service Credentials** dialog box, select an option to specify the **Safe name** and **Object name** from CyberArk instead of manually entering the user name and password for the **Service Account** used by the Control Room.
  8. Click **Service Account (retrieve credential from external key vault)**, and then enter the **Safe name** and **Object name** values. Optionally, you can enter the property that is set to your CyberArk username. For example, to configure the username in the format `domain \username`, you must enter: `$$domain$$\$$username$$` where the values for domain and username are retrieved from the CyberArk secret response.

The installer will query CyberArk for the credential to validate that the object exists in the specified safe.

---

**Note:** If the **Service Account** option to specify **Safe name** and **Object name** is not available, then this indicates that the CyberArk Password Vault was not previously configured and connected properly as the external key vault. Contact your AAI Support team or review.

---

See also: [Troubleshooting external key vaults](#) on page 1994.

- 
9. Click **Next**.
  10. From the **Database Server** dialog box, select your **Database Server** and enter the name of your Control Room database, and then click **Next**.
  11. From the **Database Authentication** dialog box, select an option to specify the **Safe name** and **Object name** from CyberArk instead of manually entering the user name and password the Control Room uses to authenticate to the database.
    - a) Click **SQL Server authentication (retrieve credential from external key vault)**, and then enter the **Safe name** and **Object name** values.

---

**Note:** Enter the same **Safe name** you previously entered for the **Service Account** safe name.

---
    - b) Click **Next** to continue and complete the initial installation.

After you successfully complete the initial installation, the Automation 360 Control Room can access and retrieve credentials within the CyberArk Password Vault.

### On-Premises post-installation using CyberArk Password Vault

You use the command-line interactive key vault utility during a scheduled system downtime and you must stop all running Control Room services. You should coordinate any key vault configuration changes that might impact connectivity parameters (such as App ID, vault URL, port numbers, and certificate) during downtimes with the CyberArk administrative team.

---

**Note:** If you use the key vault utility to disable CyberArk Password Vault integration, you must first unmap any mapped credentials that are in use.

---

Using the post-installation method, you can perform these actions:

- Modify or configure the external key vault connection parameters.
- (If not configured during initial installation) Modify or configure the service account credential (Active Directory administrator password).
- (If not configured during initial installation) Modify or configure the database (bootstrap) credential identifier (retrieved when authenticating the database).

---

**Note:** Retrieving bootstrap credentials from an external key vault might cause the Control Room to fail if the external key vault is not accessible during boot-up, or if the external key vault is not accessible when the Control Room refreshes database connections and authenticates users with Active Directory.

---

- Recover the Control Room for these reasons:
  - By modifying the external key vault connection parameters, the service account, and database credential safe and object identifiers.
  - If CyberArk Password Vault connection parameters changes caused the Control Room to experience connectivity issues.
  - When credential identifiers for bootstrap passwords change.

You can address any initial configuration settings that were not set correctly and recover the system.

You can configure and edit SMTP and AD credential identifiers to retrieve information from the external key vault from the Automation 360 Control Room by navigating to **Administration > Settings > Active Directory**.

**1.** Run the key vault utility for the CyberArk Password Vault

---

**Note:** You must import the CyberArk server certificate (the certificate issued to the CyberArk server) to the Java truststore before invoking the dB utility commands. The certificate can be in `.cer` (PEM) format and does not contain a private key.

---

To run the key vault utility and update key vault connection settings:

- a)** As the Control Room administrator, access the Automation Anywhere Control Room installation directory that was created during the initial Automation 360 installation. For example: `C:\Program Files\Automation Anywhere\Enterprise`
  - b)** Download the latest version of the key vault utility. To download the jar file used to update the directory, open a browser and access the A-People site: [A-People Downloads page \(Login required\)](#).
- 

**Note:** If DB authentication is configured to use external key vault, the utility returns the following exception: Database currently configured to retrieve credentials from key vault. Update database authentication to WINDOWS/SQL to proceed further and exit.

---

The utility requests the user to confirm the action: Disable/update of key vault might impact functionalities using key vault (for example, Active Directory configuration, Email Settings configuration). Make sure to update these settings (if any). Are you sure you want to continue?

- c)** Enter `Y` to continue.
- d)** Enter the following:  

```
> jdk11\bin\java -jar certmgr.jar -appDir . -importTrustCert <Full path of the certificate>
```
- e)** Add these `jvm` arguments to the command to run the key vault utility:
  - 1.** `-Djavax.net.ssl.trustStore="C:\Program Files\Automation Anywhere\Enterprise\pki\trust\store.ks"`
  - 2.** `-Djavax.net.ssl.trustStorePassword=changeit --module-path lib -jar crutils.jar -configPath "C:\Program Files\Automation Anywhere\Enterprise\config" -action [UPDATE_KEY_VAULT_CONFIGURATION or UPDATE_DB_AUTHENTICATION_CONFIGURATION]`

You can update either of these configuration actions:

- Enter `UPDATE_KEY_VAULT_CONFIGURATION` to edit the CyberArk key vault configuration.

- Enter `UPDATE_DB_AUTHENTICATION_CONFIGURATION` to change to database authentication using external key vault.
2. Based on which configuration action you used, choose the appropriate action:
- Update key vault configuration for CyberArk: If you entered `UPDATE_KEY_VAULT_CONFIGURATION` as the configuration action:
    - a) After the utility loads the current key vault configuration and properties, and this prompt is displayed: `Enter key vault [AWS/CYBERARK/AZURE/NONE] :`, enter `CYBERARK`
    - b) At the `Please enter Vault URL:` prompt, enter (for example): `https://services.uscentral.skytap.com:19516`
    - c) At the `Please enter Application ID:` prompt, enter (for example): `AAEControlRoom`
    - d) At the `Please enter Certificate path:` prompt, enter (for example): `C:\Users\Admin\Downloads\client_combined_cert_key_Adminat1234.p12`

---

**Note:** The client certificate issued to the Control Room for authenticating to CyberArk must be in .p12 (pkcs#12) format with the private key.

---

    - e) At the `Passphrase will not be displayed on the console Passphrase:` prompt, enter your passphrase.

The key vault utility runs. If the configuration was successful (the utility was able to connect to the external key vault using the configured parameters), these messages are displayed on the console:

```
Connection configurations valid
Key Vault configurations successfully updated
```

- Update database authentication for CyberArk: If you entered `UPDATE_DB_AUTHENTICATION_CONFIGURATION` as the configuration action:
  - a) After the utility loads the current database configuration information, this prompt is displayed:
 

```
Database authentication configurations loaded
Currently configured database authentication [SQL]

Change database authentication. Available options:
WINDOWS: Connect to database using windows authentication
SQL: Connect to database using SQL server authentication,
manually enter username and password
KEY_VAULT: Connect to database using SQL server
authentication, retrieve username and password from external
key Vault

Enter database authentication [WINDOWS/SQL/KEY_VAULT]:

Enter KEY_VAULT
```
  - b) At the `Please enter Safe name:` prompt, enter (for example): `aa_vb_safe`

- c) At the Please enter Object name: prompt, enter (for example): Database-MSSql-administrator-admin

The key vault utility runs. If the database configuration was successful (the utility was able to connect to CyberArk, retrieve the designated credential and then use the credential to connect to the database), these messages are displayed on the console:

```
Database Credentials are valid
Database authentication configurations successfully updated
```

## CyberArk credential retrieval use cases

You can retrieve CyberArk credentials for these use cases: bootstrap, system, auto-login, and automations.

### Retrieve Control Room bootstrap credentials with CyberArk

The Automation 360 Control Room uses bootstrap credentials to access supporting services such as database, service account, and Active Directory (AD). You configure these credentials during the initial On-Premises installation or post-installation (using the key vault utility) by specifying the safe name and object name.

The following images shows the process of retrieving the Control Room bootstrap credentials with CyberArk:

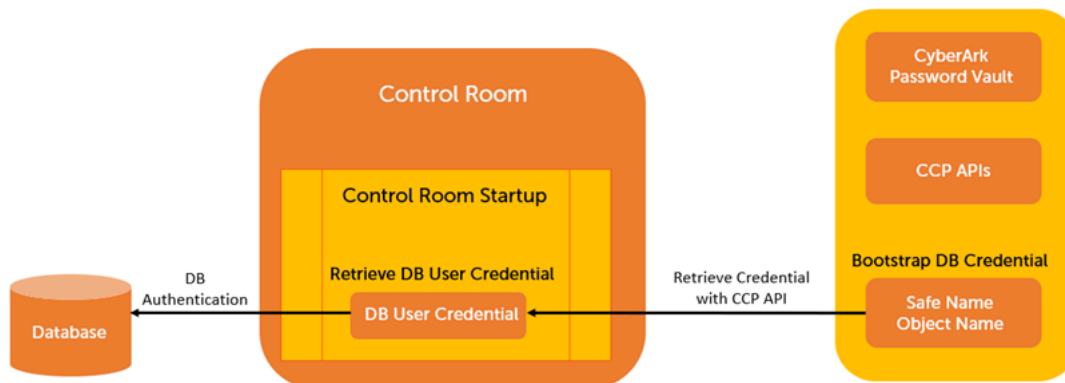

When required during the bootup sequence or normal operations (such as refreshing a service authentication), the Control Room uses the key vault connection to retrieve the credential and perform the required authentication.

**Note:** You must select the Microsoft SQL Server Authentication for this use case; other database authentication methods are not supported for bootstrap.

### Retrieve Control Room system credentials with CyberArk

**Note:** You can configure the service account only during the initial installation.

If you configured an external key vault during the initial installation, you can then use the Automation 360 user interface (post-installation) to configure SMTP and Active Directory (AD) credentials.

1. Log in to the Automation 360 Control Room as the Administrator.
2. From the Control Room, navigate to: **Administration > Settings > Email Settings**.
3. You can map the AD primary account credential from the external key vault, configure external credentials, or set to manual (switch modes of AD primary account credential retrieval).

## Retrieve auto-login credentials with CyberArk

Auto-login credentials are used to authenticate to an Automation 360 Bot Agent device and start an active Windows session. Robotic Process Automation (RPA) requires an active Windows session to function. Auto-login occurs prior to the automation running when automations are launched from a remote Bot Agent device.

The following image shows the process of retrieving the auto-login credentials with CyberArk:

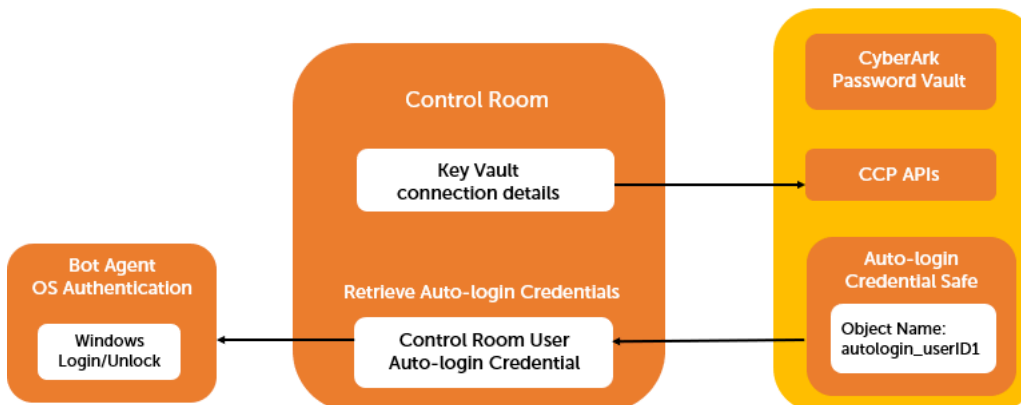

A Control Room administrator can manually launch or schedule a job to launch an automation on a Bot Agent device by specifying these details:

- Automation (bot) name
- Device name
- User context

The system performs auto-login to the specified device with the user name and password associated with the user context, and then runs the automation on the device.

To configure retrieval of auto-login credentials from the external key vault, perform these steps:

1. Log in to the Automation 360 Control Room as the Administrator with the view and manage setting permission set.
2. From the Control Room, navigate to **Administration > Settings > Devices**.
3. Scroll down to the auto-login settings section and click **Edit**.
4. If you previously configured CyberArk as the external key vault connection, click **Enabled** to retrieve the auto-login credentials from that external key vault.

If this option is disabled, then the external key vault connection was not configured.

**Note:** If you disable auto-login from the external key vault, then credentials are retrieved using the AAI Credential Vault and its stored credentials instead.

5. Enter the **Safe name** (for example: AA\_Auto-login\_Safe).  
The safe name you enter is also known as the Auto-login Credential Safe.
6. Enter the property set to your CyberArk username. For example, to configure the username in the format `domain\username`, you must enter: `$$domain$$\$$username$$` where the values for domain and username are retrieved from the CyberArk secret response.
7. To add an optional safe, click **Add optional safe**, enter the **Safe name**, and then select roles. You can add up to 25 safes.
8. Click **Save changes**.  
If successful, then the auto-login settings successfully saved message is displayed.

## CyberArk auto-login credential example

For this auto-login credential retrieval example, consider a Control Room user who wants to deploy a bot on a device as a specific user. This example uses the following details:

- Automation (bot) name run on a device = ProcureToPayGeoEast
- Agent device name = WinVDI1138
- Agent user context = roboticworker2112@automation.abcd.com

The following image shows this an example of retrieving auto-login credentials with CyberArk:

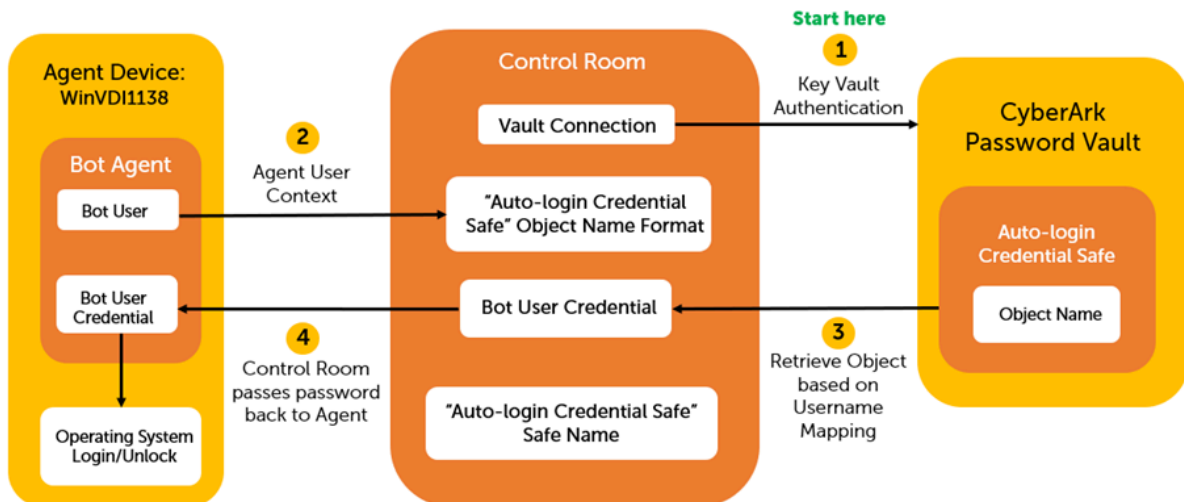

Before starting the automation, ensure the following:

1. The Control Room connection details have been successfully configured, and the Control Room uses these connection details to connect to CyberArk and performs authentication.
2. The Control Room queries the Bot Agent device running on device WinVDI1138 to check if there is an active Windows (operating system) session currently on device WinVDI1138, and if that session belongs to Agent user roboticworker2112.

If there is an existing session on the device for user `roboticworker2112`, then there is no need to perform auto-login and the bot continues with the deployment.

3. However, if there is no active session or if there is an active session that does not belong to `roboticworker2112`, then the Control Room retrieves the auto-login credential from the CyberArk Password Vault.
4. The Control Room passes the credential (password) to the Bot Agent. The Bot Agent performs a Windows login on device `winVDI1138` as `roboticworker2112` (first, logging off any other user login session) using the auto-login credential for `roboticworker2112`. The automation (Bot) `ProcureToPayGeoEast` then starts to run on device `winVDI1138` as `roboticworker2112`.

## Retrieve automation credentials with CyberArk

Automation credentials are variables used by bot developers within automation (bot) actions that define and retrieve data from encrypted storage. The automation uses the credentials to authenticate to applications (for example: finance application). Automation credentials are retrieved by the Automation 360 Bot Agent during runtime. Within CyberArk, a safe is a locker, and an object is a credential.

The following image shows the process of retrieving automation credentials with CyberArk:

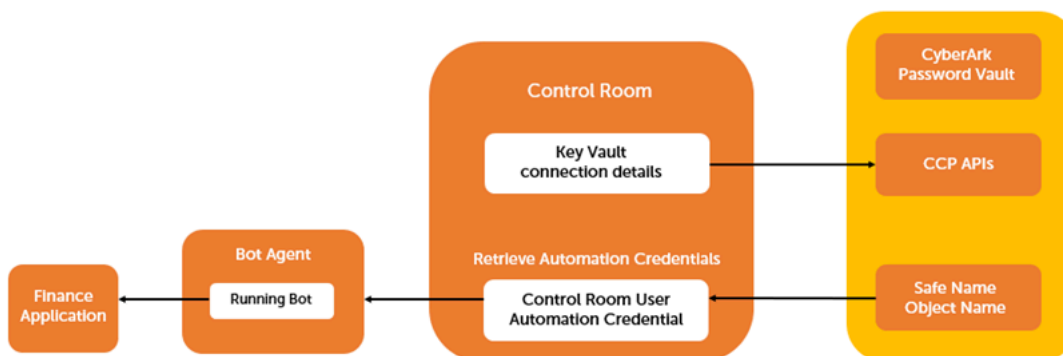

Automation credentials retrieved from the CyberArk Password Vault are mapped in the Automation Anywhere Credential Vault. The Credential Vault supports these two types of automation credentials:

System credentials

Credentials where the value returned by the credential variable is the same for any automation that uses that variable.

User-defined credentials

Credentials where the value returned by the credential variable is distinct based on the user context in which the automation is running.

For both system credentials and user-defined credentials, the bot developer specifies the same credential variable within the bot code. Then, the system determines which credential to retrieve during bot runtime.

User-defined credentials simplify automation development by enabling bot developers to write code using a single credential variable where the RPA platform substitutes the value returned during runtime with a unique user-specific value. Developers can avoid writing duplicate code with different user-specific credential variables.



The following image shows the relationship between the Automation Anywhere Credential Vault objects and the CyberArk credentials for system and user-defined credentials:

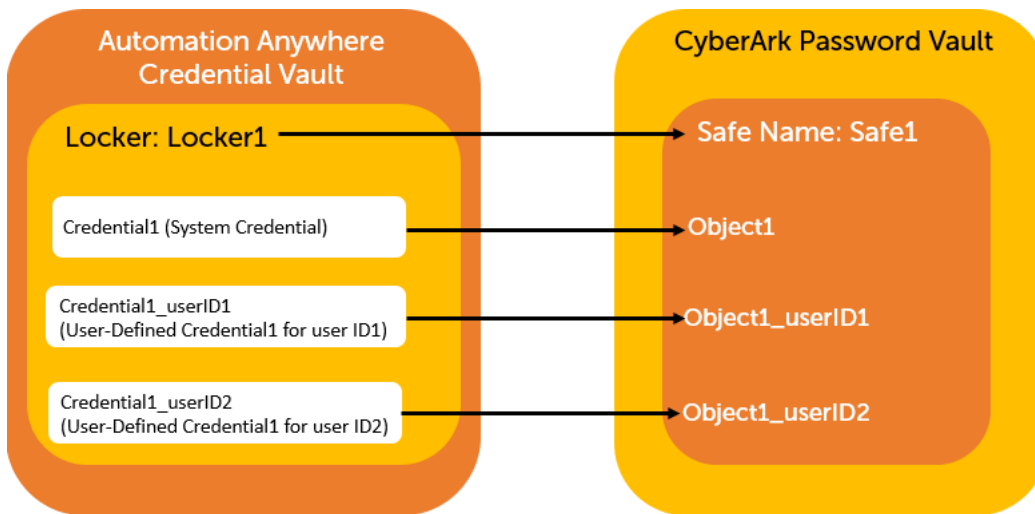

- The Control Room locker (Locker1) is mapped to the CyberArk safe name (Safe1).
- The Control Room system credential (Credential1) is mapped to the CyberArk object (Object1).

As an administrator, you create and configure a locker and credentials using the external key vault feature in the Automation 360 Control Room. Within the Control Room, an administrator maps the Automation Anywhere locker (Locker1) to a safe name (Safe1) and maps the credential (Credential1) to an object name (Object1). The credentials available to Control Room users are determined by what is configured in the external key vault (CyberArk Password Vault).

If you want to use user-defined credentials with the CyberArk integration, then the CyberArk administrator must create objects for each user-defined credential by naming those objects with the `Control Room_username` postfix. During runtime, the RPA platform retrieves the object name that is named with a postfix that matches the user context (user-defined credential) in which the automation is running. If there is no user-defined credential, then the RPA platform retrieves the object name without a username postfix (and uses the system credential).

---

**Note:** You can map any Automation Anywhere locker to any CyberArk Safe Name. However, any safe names you use to map automation credentials should be distinct from the safe names you use for auto-login.

---

As an administrator, you can use the access controls in the Automation 360 Control Room to separate access to credentials by providing users access to a locker. You control access to credentials by assigning different Control Room users to different roles and then associating different lockers with those roles. By mapping different CyberArk safes to different lockers, access to credentials in the CyberArk safes is mapped to and enforced by the access controls in the Control Room.

---

**Note:** The same permissions and privileges (assigned through roles) in the Control Room apply to credentials mapped to the external key vault.

---

## CyberArk automations credentials retrieval example

To configure automation credentials retrieval and integrate with the CyberArk Password Vault, you first create a locker and then create credentials.

To create a locker to integrate with the CyberArk Password Vault, perform these steps:

1. From the Automation 360 Control Room, navigate to **Manage > Credential**.  
A user with Manage my credentials and lockers permissions is authorized to create credentials.
2. Click the **Lockers** tab.
3. Click **Create locker**.
4. Enter a name for the locker.  
This name is local to the Control Room and does not have any dependency on the CyberArk safe name.
5. Click **External Key Vault** and enter the CyberArk safe name in the **Safe name** field (for example: `Finance_Safe`).
6. Click **Next**.
7. Configure Owners, Managers, Participants, and Consumers for the locker.
8. Click **Create locker**.  
See [Create locker](#) on page 1866.

The Control Room is now ready to retrieve credentials and enforce access controls on the mapped CyberArk safe. To continue, you now create the credentials.

To create a credential to integrate with the CyberArk Password Vault, perform these steps:

1. From the Automation 360 Control Room, navigate to **Manage > Credentials**.  
A user with Manage my credentials and lockers permissions is authorized to create credentials.
2. From the **Credentials** tab, select **Create Credential**.
3. Enter the credential name in the **Credential name** field.  
This name is local to the Control Room and does not have any dependency on the CyberArk safe name.
4. Click **External key vault** below the name field.
5. From the list of available lockers, select the appropriate locker that was previously mapped to the safe name for the credential you are now mapping to the object (credential).
6. Enter the CyberArk object name in the **Object name** field.
7. Click **Validate and retrieve attributes**.  
The system validates the mapping by attempting to retrieve from the CyberArk Password Vault the combination of safe name (locker) and object name (credential). Within the safe name mapped to the locker, Automation 360 expects objects to use the correct naming conventions. . See [External key vault naming conventions](#) on page 1921.

If validation fails, then no object exists in the CyberArk Password Vault with the name that matches the combination of safe name (locker) and object name (credential).

When the system successfully retrieves the object details, it will display the CyberArk Password Vault object attributes (the fields within the secret).

8. From the list of attributes, select attributes to map to the credential.
9. Click **Create credential**.

If successful, then the credential successfully created message is displayed.

## Azure Key Vault integration

You integrate the Automation 360 Control Room to retrieve credentials from the Azure Key Vault. The credentials become resident within the Azure Key Vault where they are managed, rotated, and synchronized.

Note: The Microsoft Azure mark and logo are trademarks or registered trademarks of Microsoft Corp. and are used for identification purposes only.

You can integrate Automation 360 with the Azure Key Vault using either of these deployments:

- Cloud
- On-Premises

The following diagram shows an Automation 360 Cloud deployment where with Azure Key Vault:

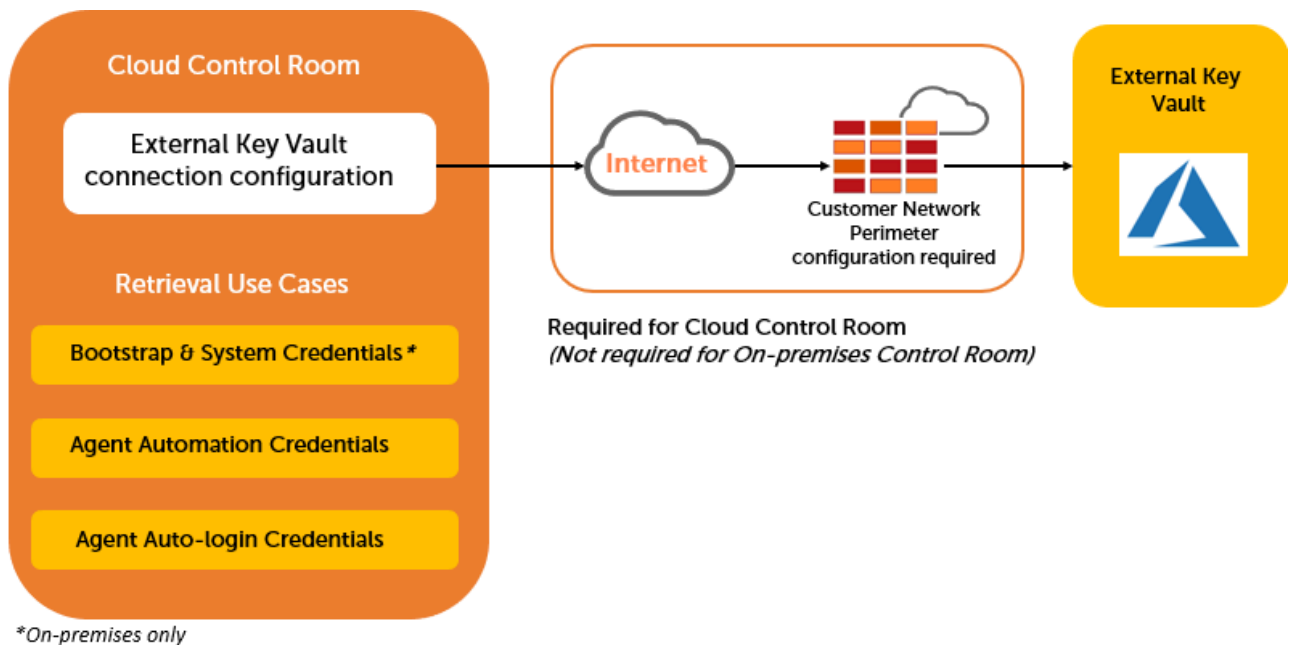

For On-Premises deployments, you deploy the following:

- Control Room as software within your customer environment.
- Bot Agent within your customer environment where automations run and access customer applications.

**Important:** You can edit the external key vault connection settings through the user interface in Cloud deployments only. External key vault settings in On-Premises deployments are only

configurable during installation or with the key vault utility post-installation. Customers will need to ensure connectivity to the external key vaults from their On-Premises deployed Control Room instances.

---

## On-Premises integration using Azure Key Vault

As an Automation 360 administrator, you can configure the Azure On-Premises integration using one of these methods: initial installation or post-installation using a command-line interactive key vault utility.

Within the On-Premises installation wizard, bootstrap credential retrieval from external key vault configuration options are only available if you first configure the key vault connection. The configuration options vary based on the external key vault you select.

Choose your integration method:

- [Initial installation](#)
- [Post-installation using key vault utility](#)

## On-Premises post-installation using Azure Key Vault

You use the command-line interactive key vault utility during a scheduled system downtime and you must stop all running Control Room services. You should coordinate any key vault configuration changes that might impact connectivity parameters (such as `AZURE_CLIENT_ID`, `AZURE_CLIENT_SECRET`, and `AZURE_TENANT_ID`) during downtimes with the Azure administrative team.

---

**Note:** If you use the key vault utility to disable Azure Key Vault integration, you must first unmap any mapped credentials that are in use.

---

Using the post-installation method, you can perform these actions:

- Modify or configure the external key vault connection parameters.
- (If not configured during initial installation) Modify or configure the service account credential (Active Directory administrator password).
- (If not configured during initial installation) Modify or configure the database (bootstrap) credential identifier (retrieved when authenticating the database).

---

**Note:** Retrieving bootstrap credentials from an external key vault might cause the Control Room to fail if the external key vault is not accessible during boot-up, or if the external key vault is not accessible when the Control Room refreshes database connections and authenticates users with Active Directory.

---

- Recover the Control Room for these reasons:
  - By modifying the external key vault connection parameters, the service account, and database credential safe and object identifiers.
  - If Azure Key Vault connection parameters changes caused the Control Room to experience connectivity issues.
  - When credential identifiers for bootstrap passwords change.You can address any initial configuration settings that were not set correctly and recover the system.

You can configure and edit SMTP and AD credential identifiers to retrieve information from the external key vault from the Automation 360 Control Room by navigating to **Administration > Settings > Active Directory**.

1. Run the key vault utility for the Azure Key Vault: To run the key vault utility and update key vault connection settings:
  - a) As the Control Room administrator, access the Automation Anywhere Control Room installation directory that was created during the initial Automation 360 installation. For example: `C:\Program Files\Automation Anywhere\Enterprise`
  - b) Download the latest version of the key vault utility. To download the jar file used to update the directory, open a browser and access the A-People site: [A-People Downloads page \(Login required\)](#).

---

**Note:** If DB authentication is configured to use external key vault, the utility returns the following exception: Database currently configured to retrieve credentials from key vault. Update database authentication to WINDOWS/SQL to proceed further and exit.

---

The utility requests the user to confirm the action: Disable/update of key vault might impact functionalities using key vault (for example, Active Directory configuration, Email Settings configuration). Make sure to update these settings (if any). Are you sure you want to continue?

- c) Enter `Y` to continue.
- d) Enter the following:
 

```
> jdk11\bin\java -jar certmgr.jar -appDir . -importTrustCert <Full path of the certificate>
```
- e) Add these `jvm` arguments to the command to run the key vault utility:
  1. `-Djavax.net.ssl.trustStore="C:\Program Files\Automation Anywhere\Enterprise\pki\trust\store.ks"`
  2. `-Djavax.net.ssl.trustStorePassword=changeit --module-path lib -jar crutils.jar -configPath "C:\Program Files\Automation Anywhere\Enterprise\config" -action [UPDATE_KEY_VAULT_CONFIGURATION or UPDATE_DB_AUTHENTICATION_CONFIGURATION]`

You can update either of these configuration actions:

- Enter `UPDATE_KEY_VAULT_CONFIGURATION` to edit the Azure Key Vault configuration.
- Enter `UPDATE_DB_AUTHENTICATION_CONFIGURATION` to change to database authentication using external key vault.

2. Based on which configuration action you used, choose the appropriate action:
  - Update key vault configuration for Azure: If you entered `UPDATE_KEY_VAULT_CONFIGURATION` as the configuration action:
    - a) After the utility loads the current key vault configuration and properties, and this prompt is displayed: `Enter key vault [AWS/CYBERARK/AZURE/NONE] :,` enter `AZURE`

- b)** At the `Please enter Vault URL:` prompt, enter (for example): `https://user-db-vault.vault.azure.net/`

The key vault utility runs. If the configuration was successful (the utility was able to connect to the external key vault using the configured parameters), these messages are displayed on the console:

```
Connection configurations valid
Key Vault configurations successfully updated
```

- Update database authentication for Azure: If you entered `UPDATE_DB_AUTHENTICATION_CONFIGURATION` as the configuration action:
  - a)** After the utility loads the current database configuration information, this prompt is displayed:

```
Database authentication configurations loaded
Currently configured database authentication [SQL]

Change database authentication. Available options:
WINDOWS: Connect to database using windows authentication
SQL: Connect to database using SQL server authentication,
manually enter username and password
KEY_VAULT: Connect to database using SQL server
authentication, retrieve username and password from external
key Vault

Enter database authentication [WINDOWS/SQL/KEY_VAULT]:
```

Enter `KEY_VAULT`

- b)** At the `Please enter Secret name:` prompt, enter (for example): `testDB`

The key vault utility runs. If the database configuration was successful (the utility was able to connect to Azure, retrieve the designated credential and then use the credential to connect to the database), these messages are displayed on the console:

```
Database Credentials are valid
Database authentication configurations successfully updated
```

## On-Premises initial installation using Azure Key Vault

Using the initial installation method, you can connect and configure the external key vault connector, service account credential (Active Directory administrator password), and bootstrap (database) credential identifier.

---

**Note:** You must select Microsoft SQL Server Authentication as the database; other database authentication methods are not supported for this use case.

---

You can configure the SMTP and AD credential identifier to retrieve from the external key vault using the Automation 360 user interface.

- 1.** [Configure the Azure Key Vault requirements from the Microsoft Azure portal.](#)

2. [Integrate the Azure Key Vault and Automation 360 Control Room.](#)
3. [Set up the authentication type for Automation 360 Control Room users and Azure Key Vault.](#)

After you successfully complete the initial installation, the Automation 360 Control Room can access and retrieve credentials within the Azure Key Vault.

## Configure Azure Key Vault requirements for initial installation

Before you can integrate the Automation 360 Control Room with the Azure Key Vault, you must configure Azure Key Vault requirements using the Microsoft Azure portal.

1. Sign in to the Microsoft Azure portal: [Azure portal](#)
2. Create a key vault in Azure.  
See [Quickstart: Create a key vault using the Azure portal.](#)
3. From the Azure Home page, navigate to **Home > selected key vault**. Generate or import secrets for the use cases you will be using with the Azure Key Vault.  
For example, if you will be using the bootstrap use case, you should generate a secret that contains the correct database credential that the Control Room will use to authenticate to the database.
4. Collect the following required Azure environment variables that must be set in the environment of the Control Room Server Microsoft operating system:
  - AZURE\_CLIENT\_ID: The client (application) ID of an App Registration in the tenant.
  - AZURE\_CLIENT\_SECRET: A client secret that was generated for the App Registration.
  - AZURE\_TENANT\_ID: The Azure Active Directory tenant (directory) ID.
5. After you set the environment variables in Azure, you must then add them to the Server Environment on the Automation 360 Control Room:

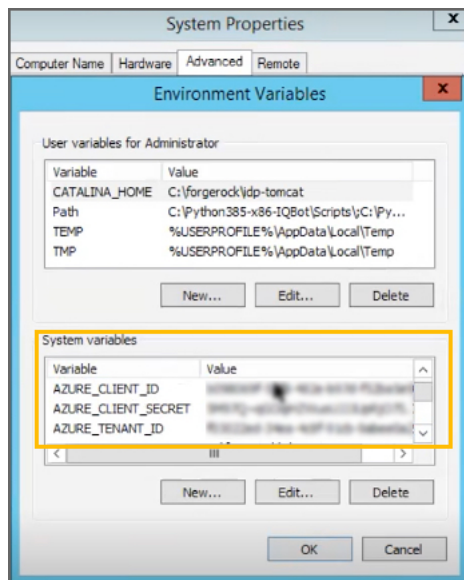

The Azure Key Vault has a flat name space with no organizational containers. There is no safe or locker within the Azure Key Vault and all credentials are stored together in the same container. Credentials are stored in objects which only have a secret name.

For RBAC policies and best practices, see [What is Azure RBAC?](#)

## Integrate Azure Key Vault and Control Room

After you configured the Azure Key Vault requirements using the Microsoft Azure portal, you can integrate the Azure Key Vault and the Automation 360 Control Room.

1. After you start the Automation 360 installation wizard, select **On-premises** as the **Deployment Option** and click **Next**.
2. Accept the license agreement and click **Next**.
3. Select **Custom** as the **Installation Type Preference** and click **Next**.
4. Click **Change...** to change the destination folder of where to install Automation 360. Browse to select the folder destination you want and click **Next**.
5. To connect and configure the external key vault integration, select **Azure**.

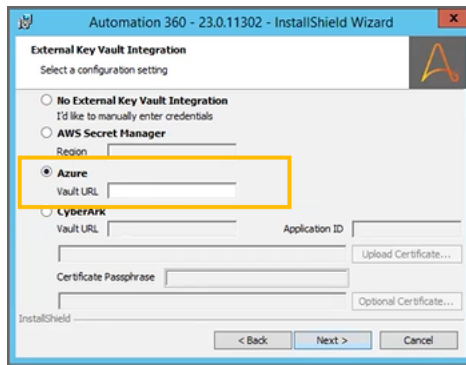

6. In the **Vault URL** field, enter the Azure Key Vault URL (for example: `https://user-db-vault.vault.azure.net/`).
7. Accept the default settings from the **TLS Configuration** dialog box and click **Next**.
8. From the **Service Credentials** dialog box, select an option to specify the **Azure Secret name** used by the Control Room and click **Next**.

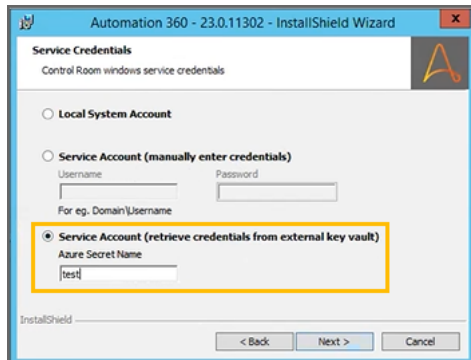

9. From the **Database Authentication** dialog box, select an option to specify the **Secret name** from Azure instead of manually entering the secret name the Control Room uses to authenticate to the database.



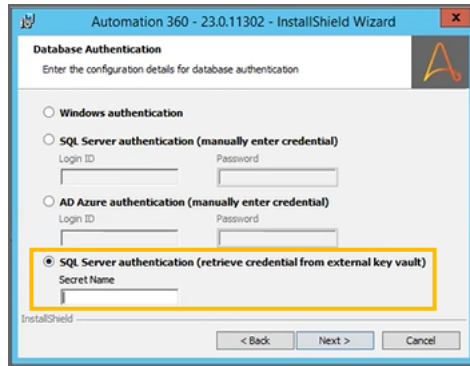

- a) Click **SQL Server authentication (retrieve credential from external key vault)**, and then enter the Azure **Secret Name** value.
- b) Click **Next** to continue and complete the initial installation.

After you successfully complete the initial installation, the Automation 360 Control Room can access and retrieve credentials within the Azure Key Vault.

## Set up authentication type for Azure Key Vault

After you complete the initial installation and configure Azure Key Vault as the external key vault, you can set up the authentication type for Automation 360 Control Room users in the Initial Setup (this occurs directly after the initial installation completes).

1. From the **Authentication type for Control Room users** dialog box, click **Active Directory**.

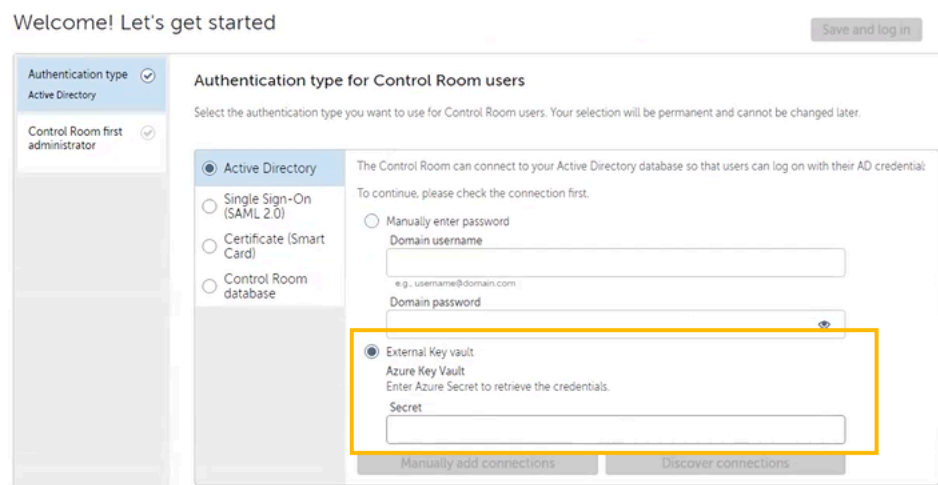

2. Optional: Configure the Active Directory integration credential (this is the credential that the Control Room uses to authenticate users with Active Directory) to be retrieved from Azure Key Vault. Click **External Key vault** and enter the Azure secret to retrieve credentials in the field (for example: `userAD`).
3. Click **Discover connections**. The available domains and sites display.
4. Click **Next** and continue to create the Control Room first admin. Save the Admin user information.

The Control Room will attempt to retrieve the credential from the Azure Key Vault and then authenticate to the Domain Controller. If this fails, cause might be one of the following:

- There is no secret with that name in the Azure Key Vault

- There is a secret with that name, but it does not contain a username and password that is authorized for authentication with Active Directory

You can now log in to the Control Room as admin and add users and roles.

**Note:** The passwords within the Azure Key Vault are masked so ensure that you copy and save them after you create them.

## Cloud integration using Azure Key Vault

For Cloud integrations, you can configure the Control Room and external key vault integration using the Automation 360 Control Room user interface.

The Agent auto-login and Agent automation use cases are only supported on Automation 360 Cloud Control Room instances. Neither of these use cases affect the Control Room boot sequence or Control Room functionality.

**Note:** Bootstrap and service account credential retrieval use cases are not supported on Cloud Control Room instances because the database and services are managed internally by Automation Anywhere. There is no compliance use case (requirement) for these credentials to be stored in the customer external key vault.

### Prerequisites

Ensure that you add your regional outbound Cloud IP addresses to the trusted or allowed list in your Azure Key Vault network settings.

See: [Control Room IP addresses for external integrations](#) on page 1829.

1. Gather the specific Azure information required to configure the external key vault connector using the Automation 360 Control Room.

Item	Description
Vault URL	The Azure Key Vault URL of the resource group (for example: <code>https://user-db-vault.vault.azure.net/</code> ).
Client ID	The client (application) ID of an App Registration in the tenant.
Client Secret	A client secret that was generated for the App Registration.
Tenant ID	The Azure Active Directory tenant (directory) ID.

2. Log in to the Automation 360 Control Room as the Administrator.
3. From the Control Room, navigate to **Administration > Settings > External key vault**.
4. Click the **Edit** icon to open the **Configuration settings** pane.
5. Click **Azure** and then enter the specific Azure information described in the preceding table.
6. Click **Save changes** to connect the external key vault.

## Azure credential retrieval use cases

You can retrieve Azure credentials for these use cases: bootstrap, system, auto-login, and automations.

### Retrieve Control Room bootstrap credentials

**Note:** This use case applies to On-Premises deployments only.

The Automation 360 Control Room uses bootstrap credentials to access supporting services such as database, service account, and Active Directory (AD). You configure these credentials during the initial On-Premises installation or post-installation (using the key vault utility) by specifying the object name.

The following image shows the process of retrieving the Control Room bootstrap credentials with Azure:

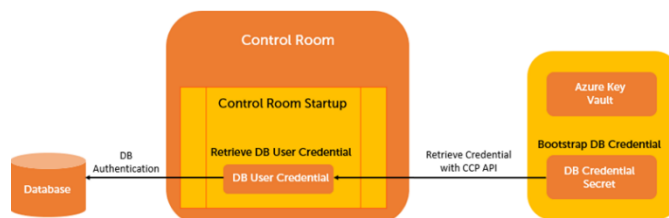

When required during the bootup sequence or normal operations (such as refreshing a service authentication), the Control Room uses the key vault connection to retrieve the credential and perform the required authentication.

**Note:** You must select the Microsoft SQL Server Authentication for this use case; other database authentication methods are not supported for bootstrap.

### Retrieve Control Room system credentials

**Note:** This use case applies to On-Premises deployments only, and you can configure the service account only during the initial installation.

If you configured an external key vault during the initial installation, you can then use the Automation 360 user interface (post-installation) to configure SMTP and Active Directory (AD) credentials.

1. Log in to the Automation 360 Control Room as the Administrator.
2. From the Control Room, navigate to: **Administration > Settings > Email Settings**.
3. You can map the AD primary account credential from the external key vault, configure external credentials, or set to manual (switch modes of AD primary account credential retrieval).

## Retrieve auto-login credentials

**Note:** This use case applies to both On-Premises and Cloud deployments.

Auto-login credentials are used to authenticate to an Automation 360 Bot Agent device and start an active Windows session. Robotic Process Automation (RPA) requires an active Windows session to function. Auto-login occurs prior to the automation running when automations are launched from a remote Bot Agent device.

The following image shows the process of retrieving the auto-login credentials with Azure:

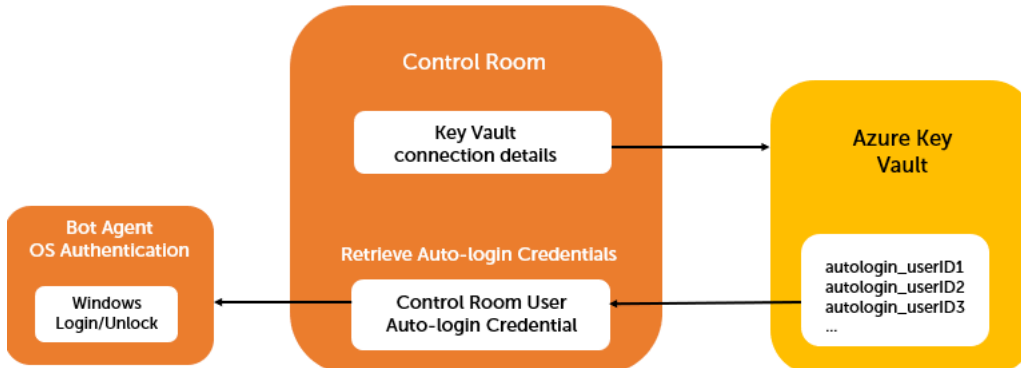

A Control Room administrator can manually launch or schedule a job to launch an automation on a Bot Agent device by specifying these details:

- Automation (bot) name
- Device name
- User context

The system performs auto-login to the specified device with the user name and password associated with the user context, and then runs the automation on the device.

You must have a secret for each Control Room user for whom the auto-login credentials will be retrieved from the external key vault, and the secret name in the Azure Key Vault must match the Control Room username.

To configure retrieval of auto-login credentials from the external key vault, perform these steps:

1. Log in to the Automation 360 Control Room as the Administrator.
2. From the Control Room, navigate to **Administration > Settings > Devices**.
3. Scroll down to the auto-login settings section and click **Edit**.
4. If you previously configured Azure Key Vault as the external key vault connection, click **Enabled** to retrieve the auto-login credentials from that external key vault.

If this option is disabled, then the external key vault connection was not configured.

**Note:** If you disable auto-login from the external key vault, then credentials are retrieved using the AAI Credential Vault and its stored credentials instead.

5. The Azure Key Vault has a flat name space without any organizational containers, so you do not need to enter a Safe name. Click **Save changes**.

If successful, then the auto-login settings successfully saved message displays.

## Auto-login naming conventions

The Control Room retrieves auto-login credentials based on the object naming convention within the external key vault. The Control Room searches for an object where the object name (the credential name in the external key vault) matches the Control Room username for which it is performing auto-login.

The prefix `autologin_` is required as part of the naming convention for auto-login credentials for all external key vaults: CyberArk, AWS, and Azure. The name of the auto-login credential in the external key vault must contain `autologin_` followed by the Control Room username. In some cases, certain key vaults have restrictions on the characters that can be used in credential object names. Additionally, to support how different use cases encode credentials, Automation 360 requires that certain characters be reserved or encoded.

The following table lists examples of the object naming conventions expected in the Control Room:

Control Room username	Expected object name format
ABCD\user123	autologin_ABCD--user123
user123@rpa.abcd.com	autologin_user123-40-rpa-2e-abcd-2e-com

**Note:** For On-Premises customers using AD authentication, you must format auto-login usernames using the UPN format or `domain\username` postfix.

For auto-login credentials, keep these in mind:

- The object name in the external key vault must contain `autologin_` as a prefix.
- The auto-login credential names must map to the Control Room username (login ID) for the credential being retrieved.

Some external key vaults have usage restrictions of certain characters, such as backslash (\) and ampersand (@) in the secret name (object name), and restrictions on how special characters are interpreted within API calls. If the user ID contains special characters, then you must encode the secret name (object name) in the external key vault using ASCII code character substitutions, as listed in the following table.

This character	Changes to this ASCII code character substitution
\ (backslash)	--
- (dash)	-2d-
_ (underscore)	-5f-
@ (ampersand)	-40-
. (period)	-2e-

**Note:** Except for the backslash being mapped to double dashes, the dash, period, underscore, and ampersand are mapped using their ASCII code bracketed in dashes.

## Azure auto-login credential example

For this auto-login credential retrieval example, consider a Control Room user who wants to deploy a bot on a device as a specific user. This example uses the following details:

- Automation (bot) name run on a device = ProcureToPayGeoEast
- Agent device name = WinVDI1138
- Agent user context = rpauserCR1@abcd.com

The following image shows this an example of retrieving auto-login credentials with Azure:

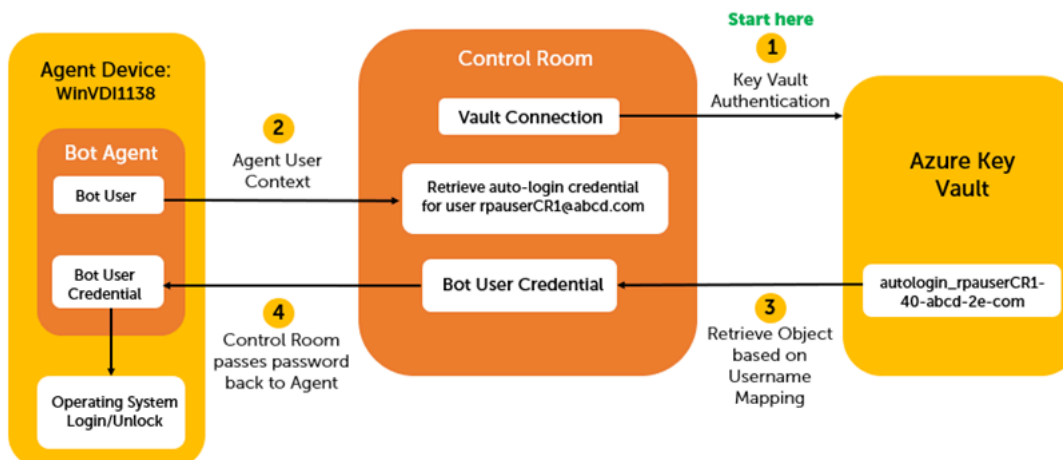

Before starting the automation, ensure the following:

1. The Control Room connection details have been successfully configured, and the Control Room uses these connection details to connect to Azure and performs authentication.
2. The Control Room queries the Bot Agent device running on device WinVDI1138 to check if there is an active Windows (operating system) session currently on device WinVDI1138, and if that session belongs to Agent user rpauserCR1.  
If there is an existing session on the device for user rpauserCR1, then there is no need to perform auto-login and the bot continues with the deployment.
3. However, if there is an no active session or if there is an active session that does not belong to rpauserCR1, then the Control Room retrieves the auto-login credential from the Azure Key Vault.
4. The Control Room passes the credential (password) to the Bot Agent. The Bot Agent performs a Windows login on device WinVDI1138 as rpauserCR1 (first, logging off any other user login session) using the auto-login credential for rpauserCR1. The automation (Bot) ProcureToPayGeoEast then starts to run on device WinVDI1138 as rpauserCR1.

## Retrieve automation credentials

**Note:** This use case applies to both On-Premises and Cloud deployments.

Automation credentials are variables used by bot developers within automation (bot) actions that define and retrieve data from encrypted storage. The automation uses the credentials to authenticate to applications (for example: finance application). Automation credentials are retrieved by the Automation 360 Bot Agent during runtime.

The following image shows the process of retrieving automation credentials with Azure:

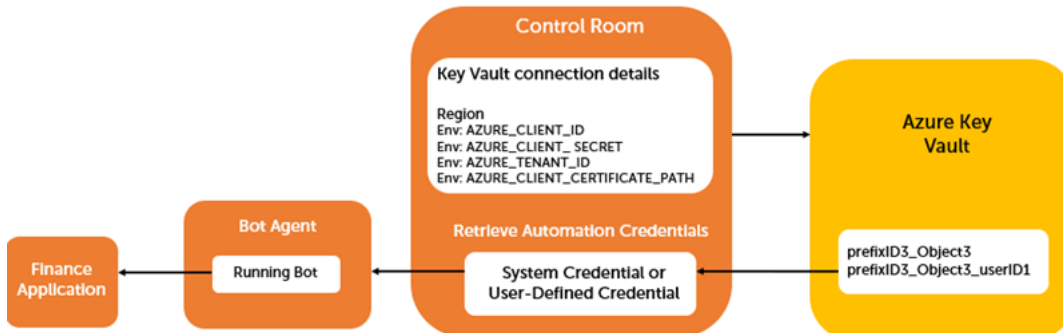

Automation credentials retrieved from the Azure Key Vault are mapped in the Automation Anywhere Credential Vault. The Credential Vault supports these two types of automation credentials:

System credentials

Credentials where the value returned by the credential variable is the same for any automation that uses that variable.

User-defined credentials

Credentials where the value returned by the credential variable is distinct based on the user context in which the automation is running.

For both system credentials and user-defined credentials, the bot developer specifies the same credential variable within the bot code. Then, the system determines which credential to retrieve during bot runtime.

User-defined credentials simplify automation development by enabling bot developers to write code using a single credential variable where the RPA platform substitutes the value returned during runtime with a unique user-specific value. Developers can avoid writing duplicate code with different user-specific credential variables.

The following image shows the expected naming convention for Azure credentials:

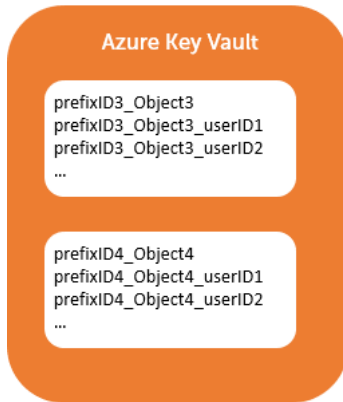

The diagram shows six secrets in the Azure Key Vault which can be mapped to two credentials within the Control Room Credential Vault

- Object3
- Object4

For example, you can map a locker in the Control Room to either `prefixID3` or `prefixID4`. Then, you map the secret to a credential. For each credential, the secrets will be consumed (retrieved by the Control Room) as a system-defined credential (without username postfix) and two user-defined credentials (one each for the Control Room users whose usernames are `User1ID1` and `User1ID2`).

---

**Note:** Within the Control Room Credential Vault, the name of the locker and the name of the credential are arbitrary and local to the Control Room. You map these names to specific secrets in the external key vault.

---

Within Azure Key Vault, each automation credential is stored with a name that contains specific identifiers including: a prefix, object identifier, and an optional postfix which identifies a username. This is a required naming convention that assures retrieval of the correct credential. The name of the secret (the credential) in Azure Key Vault encodes information about the mapping within the Automation Anywhere Credential Vault.

As an administrator, to map a Control Room to Azure Key Vault, you create and configure a locker and a credential using the external key vault option within the **Create Locker** and **Create Credential** features in the Automation 360 Control Room:

- You configure a locker in the Credential Vault to map to an Azure secret name prefix.
- You configure credentials in the Credential Vault that map to an Azure secret object identifier (optional postfix for user-defined credential).

During runtime, the RPA platform retrieves the secret that is named with a postfix that matches the user context (user-defined credential) in which the automation is running. If there is no user-defined credential, then the RPA platform retrieves the secret without a username postfix (system credential).

The Control Room implements access controls to the external credentials through permissions within roles. You control access to credentials by assigning different Control Room users to different roles and then associating different lockers with those roles.

The following image shows the Control Room Credential Vault locker and credential mapped to an Azure secret:



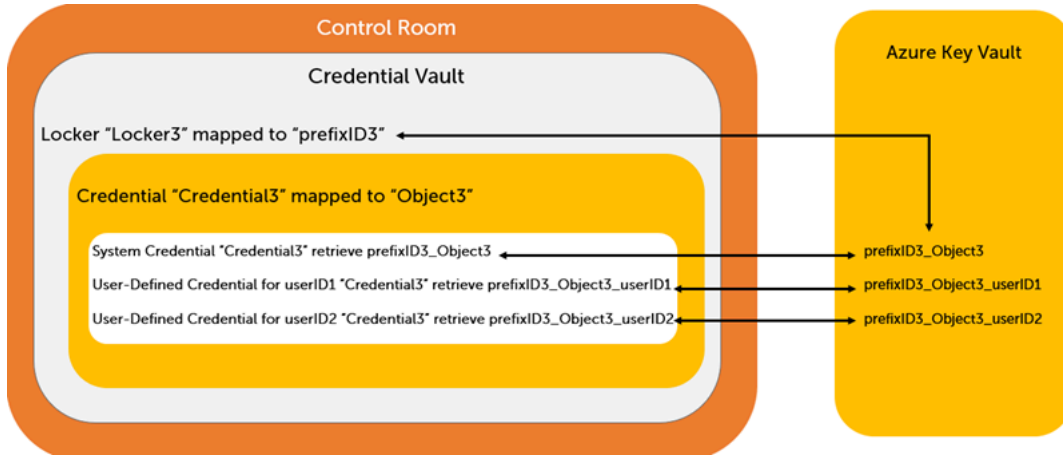

**Important:** When creating an externally mapped credential, you must place the credential in the appropriate externally mapped locker (the locker is mapped to the prefix in the secret name). The Azure secret name will have a naming convention: `Prefix + Secret_Name_Body + Postfix` (optional for user-defined credentials).

**Note:** The same permissions and privileges (assigned through roles) in the Control Room apply to credentials mapped to the external key vault.

## Automation naming conventions

The following table shows Azure Key Vault external key vault examples using naming conventions for automation.

**Note:** The Azure Prefix maps to the locker for the Control Room, and the Azure Secret Body maps to the credential for the Control Room.

Automation credential example	Azure Prefix	Azure Secret Body	Secret in Azure	Control Room username
accounting_cv1 System credential in locker mapped to Azure Secret name prefix accounting	accounting	cv1	pdf-5f-cv1 (system)	None - system credential
accounting_cv1_ABCD\user123 User-defined credential in locker mapped to Azure prefix	accounting	cv1	pdf-5f-cv1-5f-ABCD--user123	ABCD\user123

When deploying Azure credentials, the Azure Key Vault character underscore (\_) is a reserved character and cannot be used in credential names. You must substitute any underscore (\_) usage with the ASCII code value 5f bracketed by dashes:

This character	Changes to this ASCII code character substitution
\ (slash)	--
- (dash)	-2d-
_ (underscore)	-5f-
@ (ampersand)	-40-
. (period)	-2e-

## Azure automations credentials retrieval example

To configure automation credentials retrieval and integrate with the Azure Key Vault, you first create a locker and then create credentials.

To create a locker to integrate with the Azure Key Vault, perform these steps:

1. From the Automation 360 Control Room, navigate to **Manage > Credential**.  
A user with Manage my credentials and lockers permissions is authorized to create credentials.
2. From the **Credentials** tab, select **Create Locker**.
3. Enter a name for the locker (for example, `Locker3`).  
This name is local to the Control Room and does not have any dependency on the Azure secret name.
4. Click **External Key Vault** and enter the Azure secret name prefix (for example: `prefixID3`). You must name secrets within the Azure Key Vault using the name prefix for the configuration of the mapping to complete successfully.
5. Click **Next**.
6. Configure Owners, Managers, Participants, and Consumers for the locker.
7. Click **Create locker**.  
See [Create locker](#) on page 1866.

The Control Room is now ready to retrieve credentials and enforce access controls on all Azure secrets with the prefix `prefixID3`. To continue, you now create the credentials.

To create a credential to integrate with the Azure Key Vault, perform these steps:

1. From the Automation 360 Control Room, navigate to **Manage > Credentials**.  
A user with Manage my credentials and lockers permissions is authorized to create credentials.
2. From the **Credentials** tab, select **Create Credential**.
3. Enter the credential name in the **Credential name** field.

This name is local to the Control Room and does not have any dependency on the Azure secret name.

4. Click **External key vault** below the name field.
5. From the list of available lockers, select the appropriate locker that was previously mapped to the secret name prefix for the secrets you are now mapping to the credential.
6. Enter the Azure `Secret_Name_Body` in the **Secret name** field (for example: `Object3`).
7. Click **Validate and retrieve attributes**.

The system validates the mapping by attempting to retrieve from the Azure Key Vault a secret with the name `Prefix_Secret_Name_Body_LoggedInUser` (for example: `prefixID3_Object3_testuser1`).

If validation fails, check for the following parameters:

- Verify that no secret exists in the Azure Key Vault with the name that matches the combination of locker (prefix) and credential (`Secret_Name_Body`). In this example, there is no secret in the Azure Key Vault named `prefixID3_Object3`.
- Verify that there are no special characters or encoding in the username or secret name.

See: [External key vault naming conventions](#) on page 1921.

When the system successfully retrieves the secret, it will display the Azure Key Vault secret attributes (the fields within the secret).

---

**Note:** The secret value must be in the following JSON format:

```
{
  "username": "dummyUserName",
  "password": "dummyPassword"
}
```

- 
8. From the list of attributes, select attributes to map to the credential.
  9. Click **Create credential**.

If successful, then the credential successfully created message displays.

## AWS Secrets Manager integration

You integrate the Automation 360 Control Room to retrieve credentials from the AWS Secrets Manager. The credentials become resident within the AWS Secrets Manager where they are managed, rotated, and synchronized.

Note: The Amazon Web Services mark and logo are trademarks or registered trademarks of Amazon Web Services and are used for identification purposes only.

You can integrate Automation 360 with the [AWS Secrets Manager](#) using either of these deployments:

- Cloud
- On-Premises

The following diagram shows an Automation 360 Cloud deployment where with AWS Secrets Manager:

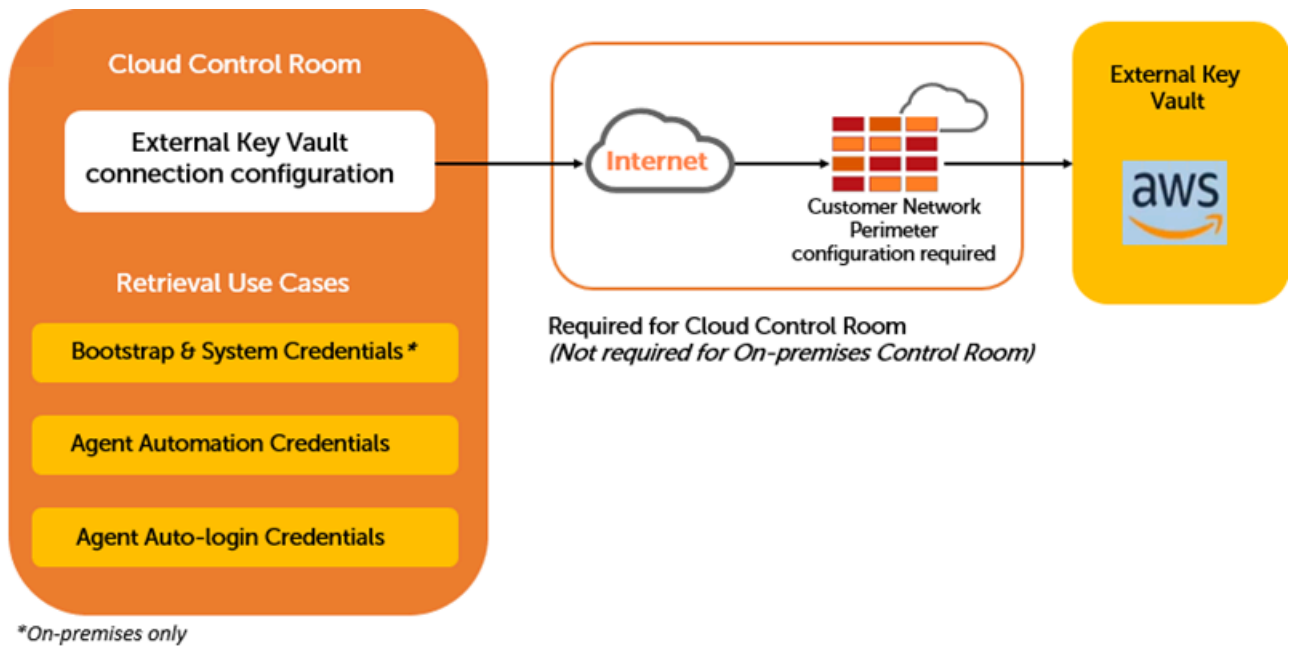

For On-Premises deployments, you deploy the following:

- Control Room as software within your customer environment.
- Bot Agent within your customer environment where automations run and access customer applications.

**Important:** You can edit the external key vault connection settings through the user interface in Cloud deployments only. External key vault settings in On-Premises deployments are only configurable during installation or with the key vault utility post-installation. Customers will need to ensure connectivity to the external key vaults from their On-Premises deployed Control Room instances.

## Cloud integration using AWS Secrets Manager

For Cloud integrations, you can configure the Control Room and external key vault integration using the Automation 360 Control Room user interface.

The Agent auto-login and Agent automation use cases are only supported on Automation 360 Cloud Control Room instances. Neither of these use cases affect the Control Room boot sequence or Control Room functionality.

**Note:** Bootstrap and service account credential retrieval use cases are not supported on Cloud Control Room instances because the database and services are managed internally by Automation Anywhere. There is no compliance use case (requirement) for these credentials to be stored in the customer external key vault.

1. Gather the specific AWS information required to configure the external key vault connector using the Automation 360 Control Room.

Item	Description
AWS_ACCESS_KEY_ID	The AWS environment variable that specifies an AWS access key associated with an IAM user or role.
AWS_SECRET_ACCESS_KEY	The AWS environment variable that specifies the secret key associated with the access key.
Region	A separate geographic area that AWS uses to house its infrastructure.

2. Log in to the Automation 360 Control Room as the Administrator.
3. From the Control Room, navigate to **Administration > Settings > External key vault**.
4. Click the **Edit** icon to open the **Configuration settings** pane.
5. Click **AWS** and then enter the specific AWS information described in the preceding table.
6. Click **Save changes** to connect the external key vault.

## On-Premises integration using AWS Secrets Manager

As an Automation 360 administrator, you can configure the AWS On-Premises integration using one of these methods: initial installation or post-installation using a command-line interactive key vault utility.

Within the On-Premises installation wizard, bootstrap credential retrieval from external key vault configuration options are only available if you first configure the key vault connection. The configuration options vary based on the external key vault you select.

Choose your integration method:

- [Initial installation](#)
- [Post-installation using key vault utility](#)

## On-Premises initial installation using AWS Secrets Manager

Using the initial installation method, you can connect and configure the external key vault connector, service account credential (Active Directory administrator password), and bootstrap (database) credential identifier.

---

**Note:** You must select Microsoft SQL Server Authentication as the database; other database authentication methods are not supported for this use case.

---

You can configure the SMTP and AD credential identifier to retrieve from the external key vault using the Automation 360 user interface.

1. [Configure the AWS Secrets Manager requirements](#) from the AWS Administrative Console.
2. [Integrate the AWS Secrets Manager and Automation 360 Control Room](#).
3. [Set up the authentication type for Automation 360 Control Room](#) users and the AWS Secrets Manager.

After you successfully complete the initial installation, the Automation 360 Control Room can access and retrieve credentials within the AWS Secrets Manager.

Configure AWS Secrets Manager requirements for initial installation

Before you can integrate the Automation 360 Control Room with the AWS Secrets Manager, you must configure AWS Secrets Manager requirements using the AWS Administrative Console.

1. Use the AWS Administrative Console to collect these AWS environment variables which you must set in the environment of the Control Room Server Microsoft Operating System:
  - AWS\_ACCESS\_KEY\_ID
  - AWS\_SECRET\_ACCESS\_KEY
  - AWS\_SESSION\_TOKEN

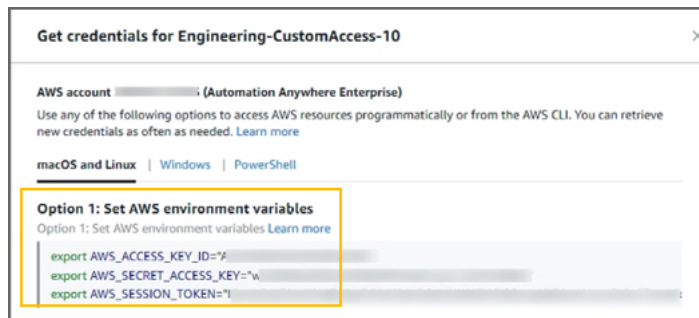

2. After you set the environment variables in AWS, you must then add them to the Server

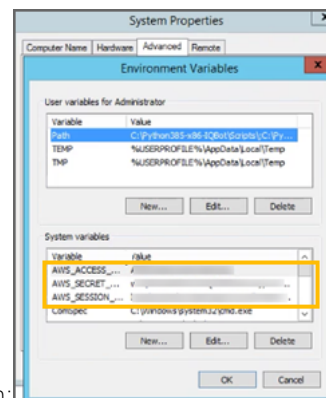

Environment on the Automation 360 Control Room:

The AWS Secrets Manager has a flat name space with no organizational containers. There is no safe or locker within the AWS Secrets Manager and all credentials are stored together in the same container. Credentials are stored in objects which only have a secret name.

Integrate AWS Secrets Manager and Control Room

After you configured the AWS Secrets Manager requirements using the AWS Administrative Console, you can integrate the AWS Secrets Manager and the Automation 360 Control Room.

1. After you start the Automation 360 installation wizard, select **On-premises** as the **Deployment Option** and click **Next**.
2. Accept the license agreement and click **Next**.
3. Select **Custom** as the **Installation Type Preference** and click **Next**.
4. Accept the default locations for the destination folders and click **Next**.

- To connect and configure the external key vault integration, select **AWS Secret Manager**

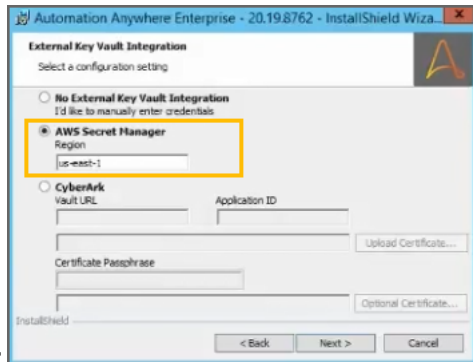

Manager.

- In the **Region** field, enter the AWS region code (for example: us-east1 and click **Next**.
- Accept the default settings from the **TLS Configuration** dialog box and click **Next**.
- Accept the default settings from the **Service Credentials** dialog box, and click **Next**.
- From the **Database Authentication** dialog box, select an option to specify the **Secret name** from AWS instead of manually entering the secret name the Control Room uses to

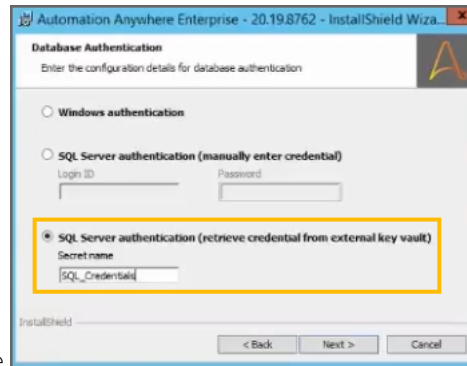

authenticate to the database.

- Click **SQL Server authentication (retrieve credential from external key vault)**, and then enter the **Secret Name** value.
- Click **Next** to continue and complete the initial installation. The installer will query AWS Secrets Manager for the credential to validate that the secret exists.

After you successfully complete the initial installation, the Automation 360 Control Room can access and retrieve credentials within the AWS Secrets Manager.

Set up authentication type for AWS Secrets Manager

After you complete the initial installation and configure AWS Secrets Manager as the external key vault, you can set up the authentication type for Automation 360 Control Room users in the Initial Setup (this occurs directly after the initial installation completes).

1. From the **Authentication type for Control Room users** dialog box, click **Active**

**Directory.**

2. You can optionally configure the Active Directory integration credential (this is the credential that the Control Room uses to authenticate users with Active Directory) to be retrieved from AWS Secrets Manager. Click **External Key vault** and enter the AWS secret to retrieve credentials in the field (for example: `userAD`). The Control Room will attempt to retrieve the credential from the AWS Secrets Manager and then authenticate to the Domain Controller. If this fails either:
  - There is no secret with that name in AWS Secrets Manager, or
  - There is a secret with that name, but it does not contain a username and password that is authorized for authentication with Active Directory.
3. Click **Discover connections**. The available domains and sites display.
4. Click **Next** and continue to create the Control Room first admin. Save the Admin user information.

You can now log in to the Control Room as admin and add users and roles.

## On-Premises post-installation using AWS Secrets Manager

Use the command-line interactive key vault utility during a scheduled system downtime and you must stop all running Control Room services. You should coordinate any key vault configuration changes that might impact connectivity parameters (such as `AWS_ACCESS_KEY_ID`, `AWS_SECRET_ACCESS_KEY`, and `AWS_SESSION_TOKEN`) during a downtime with the AWS administrative team.

**Note:** If you use the key vault utility to disable AWS Secrets Manager integration, you must first unmap any mapped credentials that are in use.

Using the post-installation method, you can perform these actions:

- Modify or configure the external key vault connection parameters.
- (If not configured during initial installation) Modify or configure the service account credential (Active Directory Domain Admin password).



- (If not configured during initial installation) Modify or configure the database (bootstrap) credential identifier (retrieved when authenticating the database).

---

**Note:** Retrieving bootstrap credentials from an external key vault might cause the Control Room to fail if the external key vault is not accessible during boot-up, or if the external key vault is not accessible when the Control Room refreshes database connections and authenticates users with Active Directory.

---

- Recover the Control Room for these reasons:
  - By modifying the external key vault connection parameters, the service account, and database credential safe and object identifiers.
  - If AWS Secrets Manager connection parameters changes caused the Control Room to experience connectivity issues.
  - When credential identifiers for bootstrap passwords change.You can address any initial configuration settings that were not set correctly and recover the system.

You can configure and edit SMTP and AD credential identifiers to retrieve information from the external key vault from the Automation 360 Control Room by navigating to **Administration > Settings > Active Directory**.

1. Run the key vault utility for the AWS Secrets Manager: To run the key vault utility and update key vault connection settings:
  - a) As the Control Room administrator, access the Automation Anywhere Control Room installation directory that was created during the initial Automation 360 installation. For example: `C:\Program Files\Automation Anywhere\Enterprise`
  - b) Download the latest version of the key vault utility. To download the `.jar` file used to update the directory, open a browser and access the A-People site: [A-People Downloads page \(Login required\)](#).

---

**Note:** If DB authentication is configured to use external key vault, the utility returns the following exception: Database currently configured to retrieve credentials from key vault. Update database authentication to WINDOWS/SQL to proceed further and exit.

---

The utility requests the user to confirm the action: Disable/update of key vault might impact functionalities using key vault (for example, Active Directory configuration, Email Settings configuration). Make sure to update these settings (if any). Are you sure you want to continue?

- c) Enter `Y` to continue.
- d) Enter the following:

```
> jdk11\bin\java -jar certmgr.jar -appDir . -importTrustCert <Full path of the certificate>
```
- e) Add these `jvm` arguments to the command to run the key vault utility:
  1. `-Djavax.net.ssl.trustStore="C:\Program Files\Automation Anywhere\Enterprise\pki\trust\store.ks"`
  2. `-Djavax.net.ssl.trustStorePassword=changeit --module-path lib -jar crutils.jar -configPath "C:`

```
\Program Files\Automation Anywhere\Enterprise
\config" -action [UPDATE_KEY_VAULT_CONFIGURATION or
UPDATE_DB_AUTHENTICATION_CONFIGURATION]
```

You can update either of these configuration actions:

- Enter `UPDATE_KEY_VAULT_CONFIGURATION` to edit the AWS Secrets Manager configuration.
- Enter `UPDATE_DB_AUTHENTICATION_CONFIGURATION` to change to database authentication using external key vault.

**2.** Based on which configuration action you used, choose the appropriate action:

- Update key vault configuration for AWS: If you entered `UPDATE_KEY_VAULT_CONFIGURATION` as the configuration action:
  - a) After the utility loads the current key vault configuration and properties, and this prompt is displayed: `Enter key vault [AWS/CYBERARK/AZURE/NONE] :`, enter `AWS`
  - b) At the `Please enter Vault URL:` prompt, enter (for example): `https://services.uscentral.skytap.com:19516`

The key vault utility runs. If the configuration was successful (the utility was able to connect to the external key vault using the configured parameters), these messages are displayed on the console:

```
Connection configurations valid
Key Vault configurations successfully updated
```

- Update database authentication for AWS: If you entered `UPDATE_DB_AUTHENTICATION_CONFIGURATION` as the configuration action:
  - a) After the utility loads the current database configuration information, this prompt is displayed:

```
Database authentication configurations loaded
Currently configured database authentication [SQL]

Change database authentication. Available options:
WINDOWS: Connect to database using windows authentication
SQL: Connect to database using SQL server authentication,
manually enter username and password
KEY_VAULT: Connect to database using SQL server
authentication, retrieve username and password from external
key Vault

Enter database authentication [WINDOWS/SQL/KEY_VAULT]:
```

Enter `KEY_VAULT`

- b) At the `Please enter Secret name:` prompt, enter (for example): `testDB`

The key vault utility runs. If the database configuration was successful (the utility was able to connect to AWS, retrieve the designated credential and then use the credential to connect to the database), these messages display on the console:

```
Database Credentials are valid
Database authentication configurations successfully updated
```

## AWS credential retrieval use cases

You can retrieve AWS credentials for these use cases: bootstrap, system, auto-login, and automations.

### Retrieve Control Room bootstrap credentials

**Note:** This use case applies to On-Premises deployments only.

The Automation 360 Control Room uses bootstrap credentials to access supporting services such as database, service account, and Active Directory (AD). You configure these credentials during the initial On-Premises installation or post-installation (using the key vault utility) by specifying the object name.

The following image shows the process of retrieving the Control Room bootstrap credentials with AWS:

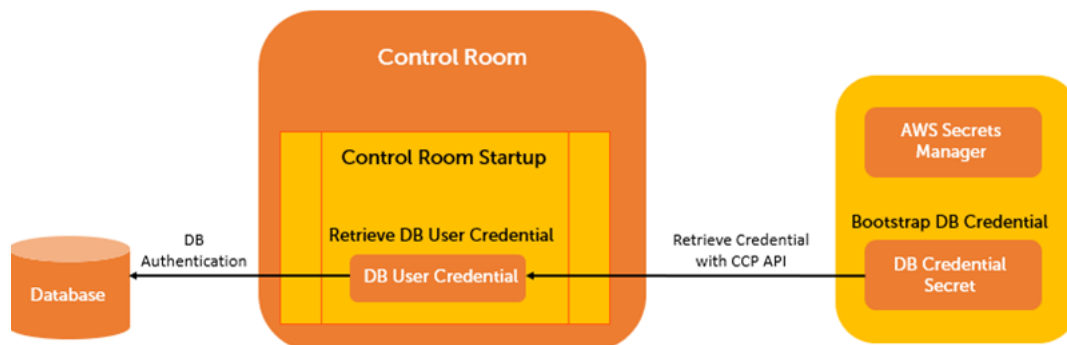

When required during the bootup sequence or normal operations (such as refreshing a service authentication), the Control Room uses the key vault connection to retrieve the credential and perform the required authentication.

**Note:** You must select the Microsoft SQL Server Authentication for this use case; other database authentication methods are not supported for bootstrap.

### Retrieve Control Room system credentials

**Note:** This use case applies to On-Premises deployments only, and you can configure the service account only during the initial installation.

If you configured an external key vault during the initial installation, you can then use the Automation 360 user interface (post-installation) to configure SMTP and Active Directory (AD) credentials.

1. Log in to the Automation 360 Control Room as the Administrator.
2. From the Control Room, navigate to: **Administration** > **Settings** > **Email Settings**.
3. You can map the AD primary account credential from the external key vault, configure external credentials, or set to manual (switch modes of AD primary account credential retrieval).

## Retrieve auto-login credentials

**Note:** This use case applies to both On-Premises and Cloud deployments.

Auto-login credentials are used to authenticate to an Automation 360 Bot Agent device and start an active Windows session. Robotic Process Automation (RPA) requires an active Windows session to function. Auto-login occurs prior to the automation running when automations are launched from a remote Bot Agent device.

The following image shows the process of retrieving the auto-login credentials with AWS:

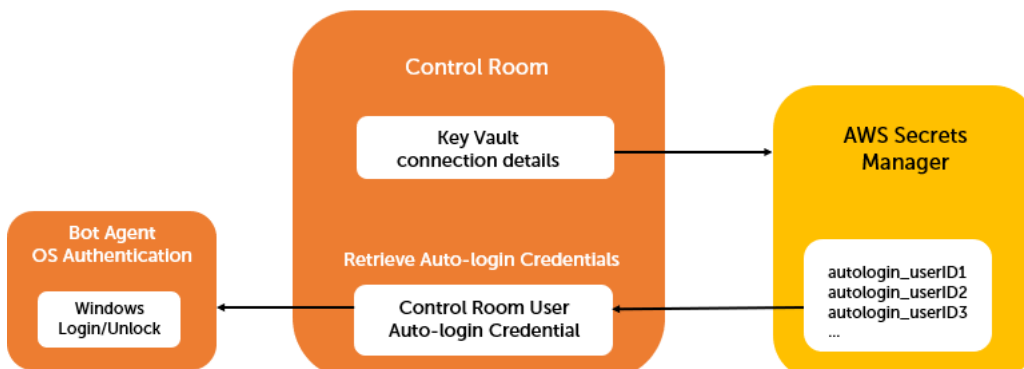

A Control Room administrator can manually launch or schedule a job to launch an automation on a Bot Agent device by specifying these details:

- Automation (bot) name
- Device name
- User context

The system performs auto-login to the specified device with the user name and password associated with the user context, and then runs the automation on the device.

You must have a secret for each Control Room user for whom the auto-login credentials will be retrieved from the external key vault, and the secret name in the AWS Secrets Manager must match the Control Room username.

To configure retrieval of auto-login credentials from the external key vault, perform these steps:

1. Log in to the Automation 360 Control Room as the Administrator.
2. From the Control Room, navigate to **Administration** > **Settings** > **Devices**.
3. Scroll down to the auto-login settings section and click **Edit**.

4. If you previously configured AWS Secrets Manager as the external key vault connection, click **Enabled** to retrieve the auto-login credentials from that external key vault.

If this option is disabled, then the external key vault connection was not configured.

---

**Note:** If you disable auto-login from the external key vault, then credentials are retrieved using the AAI Credential Vault and its stored credentials instead.

---

5. The AWS Secrets Manager has a flat name space without any organizational containers, so you do not need to enter a Safe name. Click **Save changes**.

If successful, then the auto-login settings successfully saved message displays.

## Auto-login naming conventions

The Control Room retrieves auto-login credentials based on the object naming convention within the external key vault. The Control Room searches for an object where the object name (the credential name in the external key vault) matches the Control Room username for which it is performing auto-login.

The prefix `autologin_` is required as part of the naming convention for auto-login credentials for all external key vaults: CyberArk, AWS, and Azure. The name of the auto-login credential in the external key vault must contain `autologin_` followed by the Control Room username. In some cases, certain key vaults have restrictions on the characters that can be used in credential object names. Additionally, to support how different use cases encode credentials, Automation 360 requires that certain characters be reserved or encoded.

The following table lists examples of the object naming conventions expected in the Control Room:

Control Room username	Expected object name format
ABCD\user123	autologin_ABCD--user123
user123@rpa.abcd.com	autologin_user123-40-rpa-2e-abcd-2e-com

---

**Note:** For On-Premises customers using AD authentication, you must format auto-login usernames using the UPN format or `domain\username` postfix.

---

For auto-login credentials, keep these in mind:

- The object name in the external key vault must contain `autologin_` as a prefix.
- The auto-login credential names must map to the Control Room username (login ID) for the credential being retrieved.

Some external key vaults have usage restrictions of certain characters, such as backslash (\) and ampersand (&) in the secret name (object name), and restrictions on how special characters are interpreted within API calls. If the user ID contains special characters, then you must encode the secret name (object name) in the external key vault using ASCII code character substitutions, as listed in the following table.

This character	Changes to this ASCII code character substitution
\ (backslash)	--
- (dash)	-2d-
_ (underscore)	-5f-
@ (ampersand)	-40-
. (period)	-2e-

**Note:** Except for the backslash being mapped to double dashes, the dash, period, underscore, and ampersand are mapped using their ASCII code bracketed in dashes.

### AWS auto-login credential example

For this auto-login credential retrieval example, consider a Control Room user who wants to deploy a bot on a device as a specific user. This example uses the following details:

- Automation (bot) name run on a device = ProcureToPayGeoEast
- Agent device name = WinVDI1138
- Agent user context = rpauserCR1@abcd.com

The following image shows this an example of retrieving auto-login credentials with AWS:

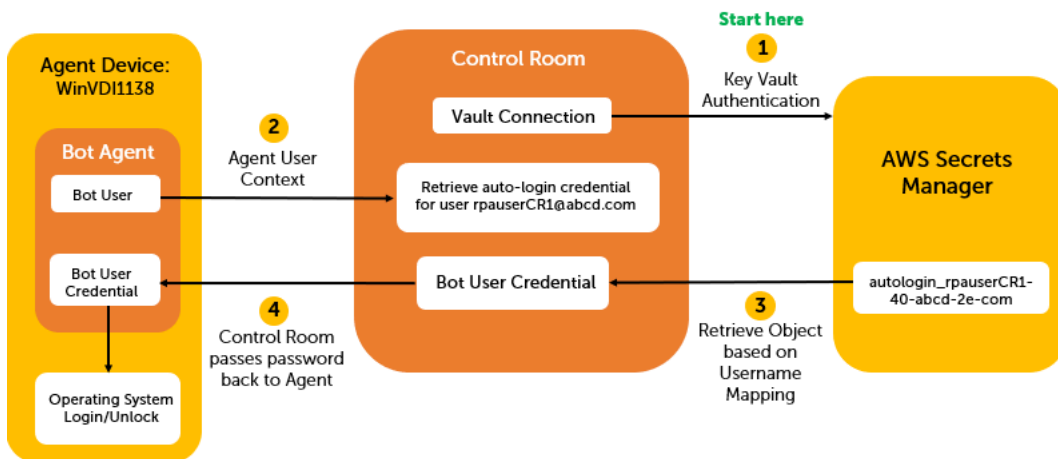

Before starting the automation, ensure the following:

1. The Control Room connection details have been successfully configured, and the Control Room uses these connection details to connect to AWS and performs authentication.
2. The Control Room queries the Bot Agent device running on device WinVDI1138 to check if there is an active Windows (operating system) session currently on device WinVDI1138, and if that session belongs to Agent user rpauserCR1.

If there is an existing session on the device for user rpauserCR1, then there is no need to perform auto-login and the bot continues with the deployment.

3. However, if there is an no active session or if there is an active session that does not belong to `rpouserCR1`, then the Control Room retrieves the auto-login credential from the AWS Secrets Manager.
4. The Control Room passes the credential (password) to the Bot Agent. The Bot Agent performs a Windows login on device `winVDI1138` as `rpouserCR1` (first, logging off any other user login session) using the auto-login credential for `rpouserCR1`. The automation (Bot) `ProcureToPayGeoEast` then starts to run on device `winVDI1138` as `rpouserCR1`.

## Retrieve automation credentials

**Note:** This use case applies to both On-Premises and Cloud deployments.

Automation credentials are variables used by bot developers within automation (bot) actions that define and retrieve data from encrypted storage. The automation uses the credentials to authenticate to applications (for example: finance application). Automation credentials are retrieved by the Automation 360 Bot Agent during runtime.

The following image shows the process of retrieving automation credentials with AWS:

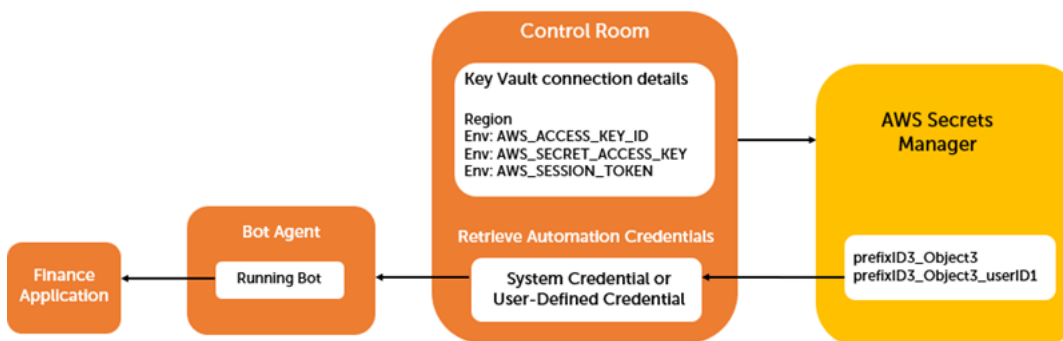

Automation credentials retrieved from the AWS Secrets Manager are mapped in the Automation Anywhere Credential Vault. The Credential Vault supports these two types of automation credentials:

System credentials

Credentials where the value returned by the credential variable is the same for any automation that uses that variable.

User-defined credentials

Credentials where the value returned by the credential variable is distinct based on the user context in which the automation is running.

For both system credentials and user-defined credentials, the bot developer specifies the same credential variable within the bot code. Then, the system determines which credential to retrieve during bot runtime.

User-defined credentials simplify automation development by enabling bot developers to write code using a single credential variable where the RPA platform substitutes the value returned during runtime with a unique user-specific value. Developers can avoid writing duplicate code with different user-specific credential variables.

The following image shows the expected naming convention for AWS credentials:



The diagram shows six secrets in the AWS Secrets Manager which can be mapped to two credentials within the Control Room Credential Vault

- Object3
- Object4

For example, you can map a locker in the Control Room to either `prefixID3` or `prefixID4`. Then, you map the secret to a credential. For each credential, the secrets will be consumed (retrieved by the Control Room) as a system-defined credential (without username postfix) and two user-defined credentials (one each for the Control Room users whose usernames are `User1ID1` and `User1ID2`).

---

**Note:** Within the Control Room Credential Vault, the name of the locker and the name of the credential are arbitrary and local to the Control Room. You map these names to specific secrets in the external key vault.

---

Within AWS Secrets Manager, each automation credential is stored with a name that contains specific identifiers including: a prefix, object identifier, and an optional postfix which identifies a username. This is a required naming convention that assures retrieval of the correct credential. The name of the secret (the credential) in AWS Secrets Manager encodes information about the mapping within the Automation Anywhere Credential Vault.

As an administrator, to map a Control Room to AWS Secrets Manager, you create and configure a locker and a credential using the external key vault option within the **Create Locker** and **Create Credential** features in the Automation 360 Control Room:

- You configure lockers in the Credential Vault that map to an AWS secret name prefix.
- You configure credentials in the Credential Vault that map to an AWS secret object identifier (optional postfix for user-defined credential).

During runtime, the RPA platform retrieves the secret that is named with a postfix that matches the user context (user-defined credential) in which the automation is running. If there is no user-defined credential, then the RPA platform retrieves the secret without a username postfix (system credential).

The Control Room implements access controls to the external credentials through permissions within roles. You control access to credentials by assigning different Control Room users to different roles and then associating different lockers with those roles.

The following image shows the Control Room Credential Vault locker and credential mapped to an AWS secret:



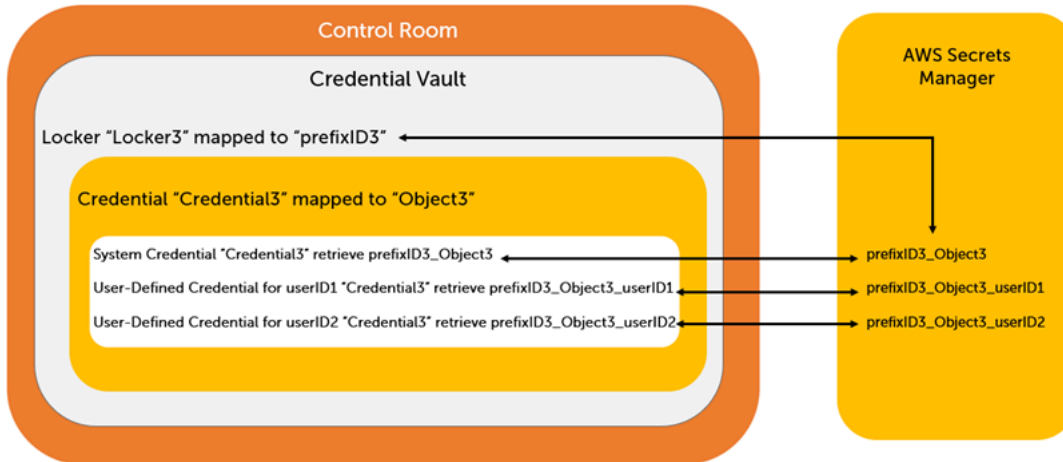

**Important:** When creating an externally mapped credential, you must place the credential in the appropriate externally mapped locker (the locker is mapped to the prefix in the secret name). The AWS secret name will have a naming convention: Prefix + Secret\_Name\_Body + Postfix (optional for user-defined credentials).

**Note:** The same permissions and privileges (assigned through roles) in the Control Room apply to credentials mapped to the external key vault.

### Automation naming conventions

The following table shows AWS Secrets Manager external key vault examples using naming conventions for automation.

**Note:** The AWS Prefix maps to the locker for the Control Room, and the AWS Secret Body maps to the credential for the Control Room.

Automation credential example	AWS Prefix	AWS Secret Body	Secret in AWS	Control Room username
accounting_pdf System credential in locker mapped to AWS Secret name prefix accounting	accounting	pdf	accounting_pdf (system)	None - system credential

Automation credential example	AWS Prefix	AWS Secret Body	Secret in AWS	Control Room username
accounting_pdf_ABCD\user123  User-defined credential in locker mapped to AWS Secret Name prefix accounting	accounting	pdf	accounting_pdf_ABCD\user123	ABCD\user123

### AWS automations credentials retrieval example

To configure automation credentials retrieval and integrate with the AWS Secrets Manager, you first create a locker and then create credentials.

To create a locker to integrate with the AWS Secrets Manager, perform these steps:

1. From the Automation 360 Control Room, navigate to **Manage > Credential**.  
A user with Manage my credentials and lockers permissions is authorized to create credentials.
2. From the **Credentials** tab, select **Create Locker**.
3. Enter a name for the locker (for example, `Locker3`).  
This name is local to the Control Room and does not have any dependency on the AWS secret name.
4. Click **External Key Vault** and enter the AWS secret name prefix (for example: `prefixID3`). You must name secrets within the AWS Secrets Manager using the name prefix for the configuration of the mapping to complete successfully.
5. Click **Next**.
6. Configure Owners, Managers, Participants, and Consumers for the locker.
7. Click **Create locker**.  
See [Create locker](#) on page 1866.

The Control Room is now ready to retrieve credentials and enforce access controls on all Azure secrets with the prefix `prefixID3`. To continue, you now create the credentials.

To create a credential to integrate with the AWS Secrets Manager, perform these steps:

1. From the Automation 360 Control Room, navigate to **Manage > Credentials**.  
A user with Manage my credentials and lockers permissions is authorized to create credentials.
2. From the **Credentials** tab, select **Create Credential**.
3. Enter the credential name in the **Credential name** field.

This name is local to the Control Room and does not have any dependency on the AWS secret name.

4. Click **External key vault** below the name field.
5. From the list of available lockers, select the appropriate locker that was previously mapped to the secret name prefix for the secrets you are now mapping to the credential.
6. Enter the AWS `Secret_Name_Body` in the **Secret name** field (for example: `Object3`).
7. Click **Validate and retrieve attributes**.

The system validates the mapping by attempting to retrieve from the AWS Secrets Manager a secret with the name `Prefix_Secret_Name_Body` (for example: `prefixID3_Object3`).

If validation fails, then no secret exists in the AWS Secrets Manager with the name that matches the combination of locker (prefix) and credential (`Secret_Name_Body`). In this example, there is no secret in the AWS Secrets Manager named `prefixID3_Object3`.

When the system successfully retrieves the secret, it will display the AWS Secrets Manager secret attributes (the fields within the secret).

8. From the list of attributes, select attributes to map to the credential.
9. Click **Create credential**.

If successful, then the credential successfully created message displays.

## HashiCorp Vault integration

You can integrate Automation 360 to retrieve credentials from the HashiCorp Vault. The credentials reside in the HashiCorp Vault where you can manage, rotate, and synchronize them.

Note: The HashiCorp mark and logo are trademarks or registered trademarks of HashiCorp, Inc. and are used for identification purposes only.

---

**Note:** No additional Automation Anywhere license is required to integrate with the HashiCorp Vault or use the HashiCorp APIs.

---

You integrate the Control Room by connecting it to the HashiCorp Vault through the HashiCorp HTTP APIs.

The following table lists the features supported by the different deployment types:

Feature	Cloud	On-Premises
Agent automation credentials	Supported	Supported
Agent auto-login credentials	Supported	Supported
Bootstrap and system credentials	Not supported	Supported

You can integrate the Control Room with the HashiCorp Vault using either of these deployments:

- Cloud

The following diagram shows a Cloud deployment where the Control Room is hosted on the AAI

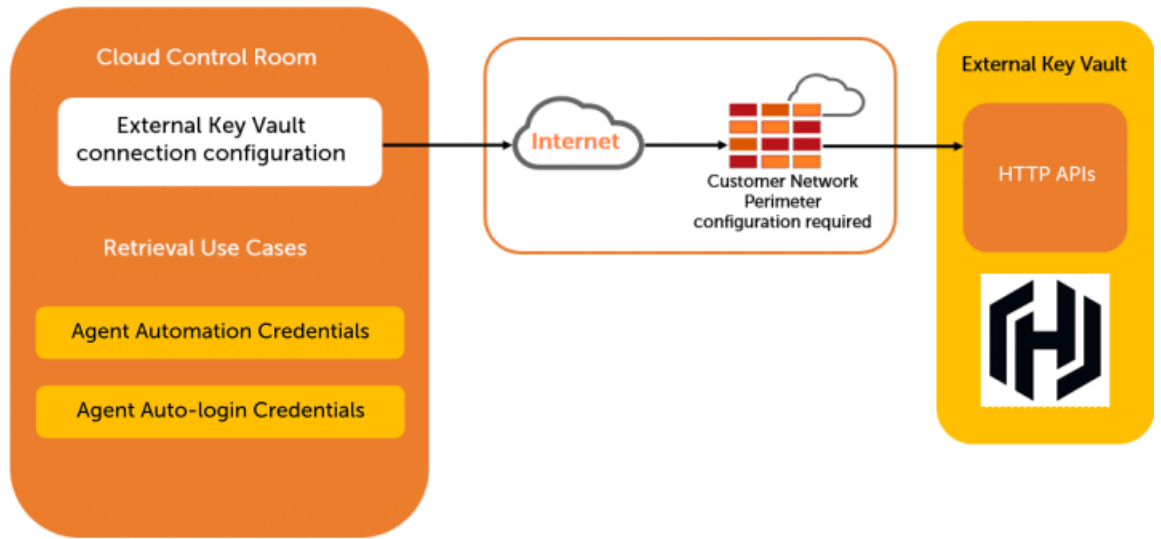

Cloud:

- On-Premises

For On-Premises deployments, you deploy the following:

- Control Room as software within your customer environment.
- Bot Agent within your customer environment where automations run and access customer applications.

---

**Note:** You can also connect your On-Premises Control Room to HashiCorp Cloud via the internet.

---

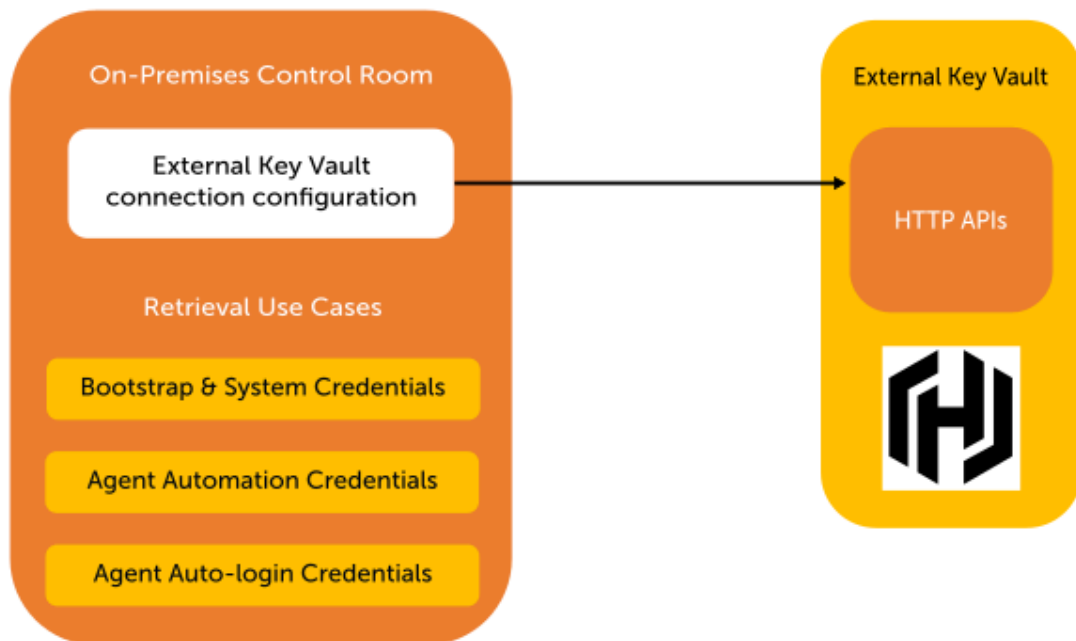

## HashiCorp Vault integration requirements

- HashiCorp service should be accessible from the Control Room.
- The HashiCorp external key vault must be reachable from the Cloud Control Room through the network perimeter firewall rules. For external firewall rules configuration details, see [Control Room IP addresses for external integrations](#) on page 1829.
- Ensure that you have the following values configured in the HashiCorp Vault because you will use these values when you configure the vault in the Control Room. For information on how to configure these values in HashiCorp, see [AppRole Auth Method](#).

**Note:** For On-Premises deployments, you can configure the external key vault settings during installation or with the key vault utility post-installation. For more information, see the following topics:

- [On-Premises initial installation using HashiCorp Vault](#) on page 1984
- [On-Premises post-installation using HashiCorp Vault](#) on page 1989

Field name	Description
<b>Vault URL</b>	Specifies the HashiCorp vault URL. For example: <code>https://&lt;host&gt;</code> or <code>https://&lt;host or IP&gt;:&lt;port&gt;</code>
<b>Role ID</b>	Specifies the RoleID of the configured HashiCorp server. For example: <code>675a50e7-cfe0-be76-e35f-49ec009731ea</code> . See <a href="#">AppRole Pull Authentication</a> .
<b>Role Name</b>	Specifies the role name of the configured HashiCorp server. For example: <code>jenkins</code> . See <a href="#">AppRole Pull Authentication</a> .
<b>Secret ID</b>	Specifies the SecretID of the configured HashiCorp. For example: <code>ed0a642f-2acf-c2da-232f-1b21300d5f29</code> . See <a href="#">AppRole Pull Authentication</a> .
<b>Namespace</b>	(Optional) Specifies the namespace for the organization (tenant). For example: <code>teant1</code> .
<b>Optional Certificate</b>	Upload the HashiCorp server public certificate to the Control Room. The certificate must be in the PEM format (.pem or .cer). For example: <code>C:\John\certs\hashicorpserver.pem</code> .

## Install HashiCorp Vault

You must install and configure the HashiCorp Vault. See [HCP Vault Quick Start](#).

## Use AppRole in HashiCorp Vault

AppRole is an authentication method used in the HashiCorp Vault for applications to interact with the vault. AppRole uses the following values for authentication:

- RoleID: A unique identifier for AppRole. You can use the Role ID with any number of instances of an application.
- SecretID: A randomly generated value that is used to authenticate the AppRole. The secret ID is intended for a single instance of an application, is short-lived, and can be used by authorized applications only.

---

**Important:** We recommend that you do not share this value.

---

- Role name: Roles are listed by the role name.
- Namespace: Allows you to create groups of secrets and apply policies to those namespaces to ensure that each tenant can only access the secrets they have permission to.

For information on how to configure AppRole, see [AppRole Auth Method](#).

## Import server certificate

In On-Premises deployments, you can import individual server certificates into the truststore. However, we recommend that you import the issuing Certificate Authority (CA) certificate. For more information, see [Import HTTPS, intermediate, and CA certificates](#) on page 1387.

1. The client (Automation 360 Control Room) sends a request to the HashiCorp Vault (protected resource).
2. The server then responds by sending a certificate back to the client.
3. The Control Room verifies the certificate sent by the HashiCorp server by validating it against the trusted server certification information stored in the public part of the Control Room truststore.
4. Both parties (client and server) gain access to the protected resources if the certificates pass validation based on the following:
  - The Control Room must trust the certificate on the HashiCorp server
  - The Subject field in the certificate matches the Fully Qualified Domain Name (DNS Name) of the calling system.
  - The certificate has not expired.

## HashiCorp HTTP API configuration requirements

You must have network connectivity between the Control Room and the HashiCorp server. The Control Room is connected to the HashiCorp Vault through the HashiCorp HTTP APIs for both On-Premises or Cloud deployments.

To use the HashiCorp API, you must set these required parameters:

- **Vault URL**
- **Role ID**
- **Role Name**
- **Secret ID**
- **Namespace** (optional)
- **Optional Certificate**

## Review HashiCorp credential terminology and identifiers

HashiCorp and Automation Anywhere use different terminology to describe and identify credentials:

Description	HashiCorp	Automation Anywhere
Where credentials are stored	secrets	credentials

- Credentials in HashiCorp are stored as secrets.
- Credentials in Automation Anywhere are stored in lockers, where each locker has access controls for Control Room users.

For database, service account, SMTP, and AD credentials, the key vault secret data should use the following format:

- username: john
- password: 2zR%#sX#g

For automation, the key vault secret data should use the following format:

- email: john@email.com
- passcode: my-long-passcode

## HashiCorp secret ID rotation

The Control Room runs a scheduled job to proactively rotate the HashiCorp secret ID for a tenant. This process ensures that the automation involving key vault credentials runs uninterrupted. By default, the secret ID rotation frequency is every hour. The secret ID is changed based on the secret ID's expiration time. You can change the secret ID when two-thirds of the secret ID has expired.

If the HashiCorp secret ID rotation fails, you can manually change the secret ID using the following Cloud or On-Premises procedures:

- Cloud: [Cloud integration using HashiCorp Vault](#) on page 1984

- On-Premises: [On-Premises post-installation using HashiCorp Vault](#) on page 1989.

## Cloud integration using HashiCorp Vault

As an administrator, you can configure the HashiCorp Cloud integration in the Control Room.

- You must have administrator role to configure these settings.
- Ensure that you have configured the AppRole authentication and have the RoleID, SecretID, role name, and namespace values available. For more information, see [HashiCorp Vault integration](#) on page 1979.

1. Navigate to **Settings > External key vault**.
2. Select the HashiCorp Key Vault option.
3. Enter the **Vault URL**.
4. Enter the **Role ID**.
5. Enter the **Role Name**.
6. Enter the **Secret ID**.
7. Optional: Enter the **Namespace**.
8. Optional: Enter the **Server Certificate - PEM format**.
9. Click **Save changes**.

You can configure HashiCorp Vault for the following features:

- Email notifications: [Edit email notifications](#) on page 1820
- Create a locker: [Create locker](#) on page 1866
- Create credential: [Create credential](#) on page 1864

## On-Premises integration using HashiCorp Vault

As an administrator, you can configure the HashiCorp On-Premises integration using one of these methods: initial installation or post-installation using a command-line interactive key vault utility.

Within the On-Premises installation wizard, bootstrap credential retrieval from external key vault configuration options are only available if you first configure the key vault connection. The configuration options vary based on the external key vault you select.

Select your integration method:

- [On-Premises initial installation using HashiCorp Vault](#) on page 1984
- [On-Premises post-installation using HashiCorp Vault](#) on page 1989
- [On-Premises post-installation for secret ID rotation](#) on page 1992

### On-Premises initial installation using HashiCorp Vault

Using the initial installation method, you can connect and configure the external key vault connector, service account credential (Active Directory administrator password), and bootstrap (database) credential identifier.

---

**Note:** You must select Microsoft SQL Server Authentication as the database; other database authentication methods are not supported for this use case.

---



The initial installation supports a `password-less` installation for the Control Room bootstrap credentials. The password-less installation identifies the bootstrap credentials identified by the secret name configured in the vault.

You can configure the SMTP and AD credential identifier to retrieve from the external key vault using the Automation 360 user interface.

1. After you start the Automation 360 installation wizard, select **On-premises** as the **Deployment Option** and click **Next**.
2. Accept the license agreement and click **Next**.
3. Select **Custom** as the **Installation Type Preference** and click **Next**.
4. Accept the default locations for the destination folders and click **Next**.
5. Select **Microsoft SQL Server** as the **Database Type** and click **Next**.
6. Select **HashiCorp** from the **External Key Vault Integration** drop-down.
  - a) In the **Vault URL** field, enter the HashiCorp server API URL (for example: `https://<host>` or `https://<host or IP>:<port>`).
  - b) In the **Role ID** field, enter the HashiCorp RoleID (for example: `675a50e7-cfe0-be76-e35f-49ec009731ea`).
  - c) In the **Role Name** field, enter the HashiCorp role name (for example: `jenkins`).
  - d) In the **Secret ID** field, enter the HashiCorp SecretID (for example: `ed0a642f-2acf-c2da-232f-1b21300d5f29`).
  - e) Optional: In the **Namespace** field, enter the namespace.
  - f) Optional: If the issuing Certificate Authority (CA) of the HashiCorp server certificate is not trusted by the Control Room, then enter an optional server certificate.

This is the server certificate (.pem format) for the HashiCorp server without a private key (the certificate Subject: field contains the HashiCorp server FQDN). The installer will add the optional HashiCorp server certificate to the truststore used by the Control Room.
  - g) Click **Next**.

Automation 360 - [blurred]

### External Key Vault Integration

Select a configuration setting

HashiCorp

Details

Vault URL [blurred]

Role ID [blurred]

Role Name [blurred]

Secret ID [blurred]

Namespace (Optional) /tenant1

[blurred] Optional Certificate...

InstallShield

< Back Next > Cancel

7. Accept the default settings from the **TLS Configuration** dialog and click **Next**.
8. From the **Service Credentials** dialog, select an option to specify the **HashiCorp Secret Name** from HashiCorp instead of manually entering the user name and password for the **Service Account** used by the Control Room.
9. Click **Service Account (retrieve credentials from external key vault)**, and then enter the **HashiCorp Secret Name** value.  
The installer will query the HashiCorp server for the credential to validate the configuration.

Automation 360 -

**Service Credentials**

Control Room windows service credentials

**Local System Account**

**Service Account (manually enter credentials)**

Username Password

For ex. Domain\Username

**Service Account (retrieve credentials from external key vault)**

HashiCorp Secret Name

InstallShield

< Back Next > Cancel

**Note:** If the **Service Account** option to specify **HashiCorp Secret Name** is not available, then this indicates that the HashiCorp Vault was not previously configured properly. Contact your AAI Support team.

See: [Troubleshooting external key vaults](#) on page 1994.

10. Click **Next**.
11. From the **Database Server** dialog, select your **Database Server** and enter the name of your Control Room database, and then click **Next**.

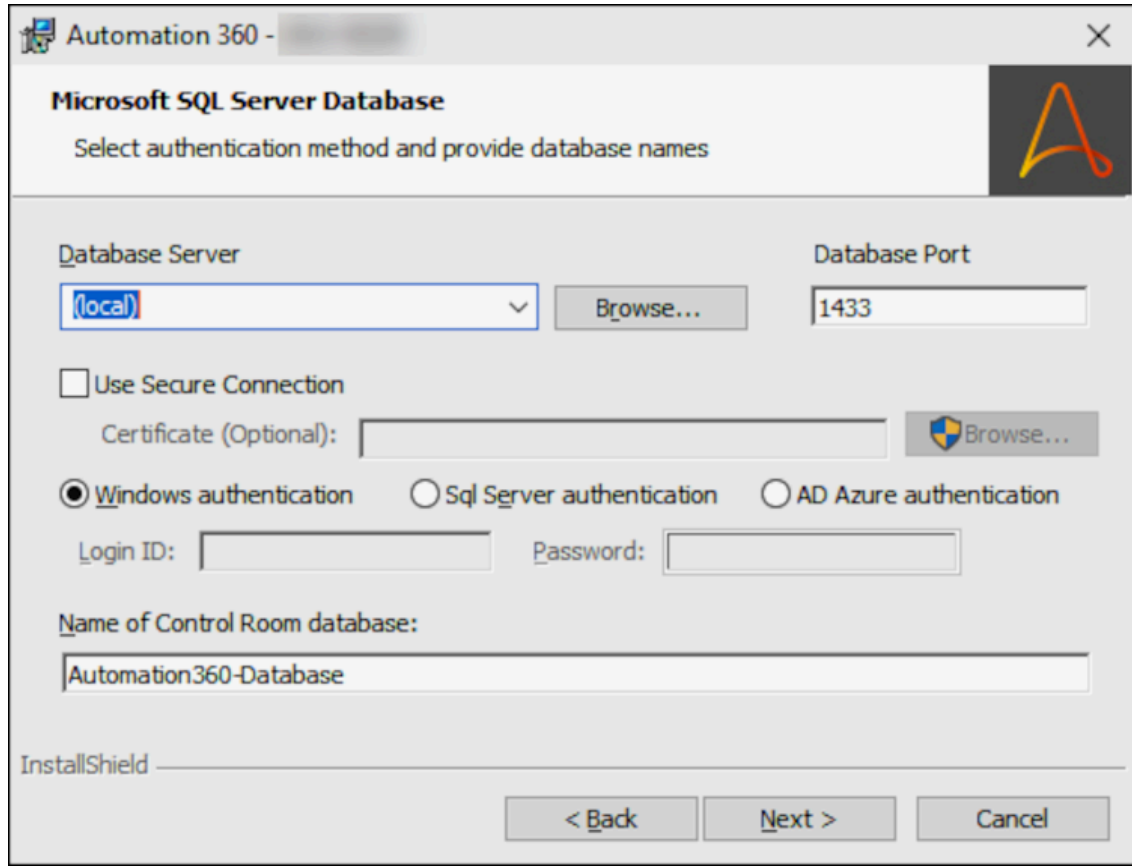

12. From the **Database Authentication** dialog, select an option to specify the **HashiCorp Secret Name** from HashiCorp instead of manually entering the user name and password the Control Room uses to authenticate to the database.
- Click **SQL Server authentication (retrieve credential from external key vault)**, and then enter the **HashiCorp Secret Name** value.
  - Click **Next** to continue and complete the initial installation.

After you successfully complete the initial installation, the Automation 360 Control Room can access and retrieve credentials within the HashiCorp Vault.

## On-Premises post-installation using HashiCorp Vault

You use the command-line interactive key vault utility during a scheduled system downtime where you must stop all running Control Room services. You should coordinate with the HashiCorp administrative team for any key vault configuration changes that might impact connectivity parameters (such as App ID, vault URL, port numbers, and certificate) during downtimes.

**Note:** If you use the key vault utility to disable HashiCorp Vault integration, you must first unmap any mapped credentials that are in use.

Using the post-installation method, you can perform these actions:

- Modify or configure the external key vault connection parameters.
- (If not configured during initial installation) Modify or configure the service account credential (Active Directory administrator password).
- (If not configured during initial installation) Modify or configure the database (bootstrap) credential identifier (retrieved when authenticating the database).

**Note:** Retrieving bootstrap credentials from an external key vault might cause the Control Room to fail if the external key vault is not accessible during boot-up; or if the external key vault is not accessible when the Control Room refreshes database connections and authenticates users with Active Directory.

- Recover the Control Room for these reasons:
  - If the external key vault connection parameters, the service account, and database credential safe and object identifiers were modified.
  - If the HashiCorp Vault connection parameters changes caused the Control Room to experience connectivity issues.
  - If credential identifiers for bootstrap passwords changed.

You can update any initial configuration settings that were not set correctly and recover the system.

---

**Note:**

You can configure and edit SMTP and AD credential identifiers to retrieve information from the external key vault from the Automation 360 Control Room by navigating to **Administration > Settings > Email** and **Administration > Settings > Active Directory**.

---

1. Run the key vault utility for the HashiCorp Vault.
- 

**Note:** You must import the HashiCorp server certificate (the certificate issued to the HashiCorp server) to the Java truststore before invoking the dB utility commands. The certificate can be in .cer (PEM) format and does not contain a private key.

---

To run the key vault utility and update key vault connection settings:

- a) As the Control Room administrator, access the Automation Anywhere Control Room installation directory that was created during the initial Automation 360 installation. For example: C:\Program Files\Automation Anywhere\Enterprise
  - b) Download the latest version of the key vault utility. To download the jar file used to update the directory, use the following instructions:
    1. Open a browser and access the A-People site: [A-People Downloads page \(Login required\)](#).
    2. Click the link to the latest On-Premises build.
    3. Click the **Installation Setup** folder.
    4. Download the `crutils.jar` file.
- 

**Note:** If DB authentication is configured to use external key vault, the utility returns the following exception: Database currently configured to retrieve credentials from key vault. Update database authentication to WINDOWS/SQL to proceed further and exit.

---

The utility requests the user to confirm the action: Disable/update of key vault might impact functionalities using key vault (for example, Active Directory configuration, Email Settings configuration). Make sure to update these settings (if any). Are you sure you want to continue?

- c) Enter `Y` to continue.
  - d) Enter the following:
-

```
> jdk11\bin\java -jar certmgr.jar -appDir . -importTrustCert <Full
path of the certificate>
```

e) Add these JVM arguments to the command to run the key vault utility:

1. `-Djavax.net.ssl.trustStore="C:\Program Files\Automation Anywhere\Enterprise\pki\trust\store.ks"`
2. `-Djavax.net.ssl.trustStorePassword=changeit --
module-path lib -jar crutils.jar -configPath "C:
\Program Files\Automation Anywhere\Enterprise
\config" -action [UPDATE_KEY_VAULT_CONFIGURATION or
UPDATE_DB_AUTHENTICATION_CONFIGURATION]`

You can update either of these configuration actions:

- Enter `UPDATE_KEY_VAULT_CONFIGURATION` to edit the HashiCorp key vault configuration.
- Enter `UPDATE_DB_AUTHENTICATION_CONFIGURATION` to change to database authentication using external key vault.

2. Based on the configuration action you used, select the appropriate action:

- Update key vault configuration for HashiCorp: If you entered `UPDATE_KEY_VAULT_CONFIGURATION` as the configuration action:
  - a) After the utility loads the current key vault configuration and properties, this prompt is displayed: `Enter key vault [AWS/CYBERARK/AZURE/HASHICORP/NONE] :.`  
Enter `HASHICORP`
  - b) At the `Please enter Vault URL:` prompt, enter (for example): `https://services.uscentral.skytap.com:19516`
  - c) At the `Please enter Role Name:` prompt, enter (for example): `jenkins`
  - d) At the `Please enter Role ID:` prompt, enter (for example): `675a50e7-cfe0-be76-e35f-49ec009731ea`
  - e) At the `Please enter Secret ID:` prompt, enter (for example): `ed0a642f-2acf-c2da-232f-1b21300d5f29`
  - f) At the `Please enter Namespace:` prompt, enter (for example): `tenant1`

The key vault utility runs. If the configuration was successful (the utility was able to connect to the external key vault using the configured parameters), these messages are displayed on the console:

```
Connection configurations valid
Key Vault configurations successfully updated
```

- Update database authentication for HashiCorp: If you entered `UPDATE_DB_AUTHENTICATION_CONFIGURATION` as the configuration action:
  - a) After the utility loads the current database configuration information, this prompt is displayed:

```
Database authentication configurations loaded
Currently configured database authentication [SQL]
```

```
Change database authentication. Available options:  
WINDOWS: Connect to database using windows authentication  
SQL: Connect to database using SQL server authentication,  
manually enter username and password  
KEY_VAULT: Connect to database using SQL server  
authentication, retrieve username and password from external  
key Vault
```

```
Enter database authentication [WINDOWS/SQL/KEY_VAULT]:
```

```
Enter KEY_VAULT
```

**b)** At the Please enter Secret name: prompt, enter (for example): aadbuser

The key vault utility runs. If the database configuration was successful (the utility was able to connect to HashiCorp, retrieve the designated credential and then use the credential to connect to the database), these messages are displayed on the console:

```
Database Credentials are valid  
Database authentication configurations successfully updated
```

On-Premises post-installation for secret ID rotation

The default secret ID rotation frequency is one hour. You can set the secret ID rotation frequency to less than an hour in your environment.

If you set the secret ID rotation frequency to less than an hour in your environment, then you must configure the following options:

1. Set an appropriate frequency for the following key in the `cv.properties` file located in the Automation Anywhere configuration directory:

```
rotate.hashicorp.secret.id.job.interval.milliseconds=300000
```

For example, if you set the secret ID expiry in your environment to 15 minutes, then set the key value to 180000 (3 minutes) or 240000 (4 minutes) so that you provide enough time for the scheduled job to run before the next secret ID rotation begins.

---

**Note:** You need to manually create the file and the key if they do not exist.

---

2. Update the new frequency value in the following database entry:  

```
UPDATE QRTZ_SIMPLE_TRIGGERS set REPEAT_INTERVAL=300000 where  
TRIGGER_NAME='HashiCorpAppRoleRotateSecretIdJob'
```
3. Manually trigger the scheduled job to enable the new frequency by updating the following database entry:

```
UPDATE QRTZ_TRIGGERS set NEXT_FIRE_TIME='1683733949000' where  
TRIGGER_NAME='HashiCorpAppRoleRotateSecretIdJob'
```

---

**Note:** The `NEXT_FIRE_TIME` is a time stamp value in milliseconds.

---



## Changing external key vault to another

If you did not integrate the external key vault during the initial installation and you want to configure it without re-installing, you must use the key vault utility. Also, to change the external key vault connection details or to change the bootstrap credentials, you must use the key vault utility.

You use the key vault utility for each of these scenarios:

- To initially configure the external key vault connection if it was not configured during initial installation and you do not want to re-install the external key vault.
- To change external key vault connection details:
  - Example 1: CyberArk Password Vault is migrating to a server with a different name
  - Example 2: CyberArk Password Vault authentication certificate is changing
  - Example 3: You want to change from one AWS Secrets Manager instance to another
  - Example 4: You want to change from one Azure Key Vault instance to another
  - Example 5: HashiCorp Vault authentication certificate is changing
- The Automation 360 Control Room is malfunctioning because the external key vault connection has changed, and the Control Room is no longer able to retrieve credentials from the external key vault.
- The Control Room is malfunctioning because the credentials defined for bootstrap or Active Directory integration have changed names.
- To change the KEY\_VAULT from one external key vault to another, or to NONE, you must first manually set the database and service account credentials that are currently being retrieved from the external key vault.

For example, to change from an AWS Secrets Manager key vault to a CyberArk Password Vault, you must perform these actions:

1. Set the external KEY\_VAULT attribute to NONE.
2. Set the external key vault to the new key vault type.

The following table provides guidelines on acceptable state changes for the KEY\_VAULT attribute:

New key vault	Original key vault				
	AWS	CyberArk	Azure	HashiCorp	None
AWS	Yes	No	No	No	Yes
CyberArk	No	Yes	No	No	Yes
Azure	No	No	No	No	Yes
HashiCorp	No	No	No	Yes	Yes
None	Yes	Yes	Yes	Yes	Yes

- To change from an AWS Secrets Manager key vault to a CyberArk Password Vault (or vice-versa), you must first change the KEY\_VAULT attribute to NONE.
- To change an AWS Secrets Manager key vault or a CyberArk Password Vault to NONE, ensure that the database is not connected with the KEY\_VAULT attribute.

## Verify external key vault configuration

Use the Automation 360 Control Room to verify external key vault configuration and database authentication changes you made using the key vault utility.

1. Log in to the Automation 360 Control Room as the administrator.
2. Go to **Administration > Settings > General > Configuration settings**.
3. Go to the **Control Room Database & Software** tab and scroll down to the Control Room database information to verify its details.
4. Navigate back to **Settings > External key vault** and review its configuration settings for external vault, vault URL, and Application ID.
5. Navigate back to **Settings > Email**, and click the **Edit** icon to open the **Notifications** pane.
6. Scroll down to verify that the external key vault settings reflect the SMTP credential identifier in the external key vault
7. Click **Close**.

## Troubleshooting external key vaults

You can use the `keyvault.properties` file and application log files to review configuration and integration information for external key vaults.

### Use the `keyvault.properties` file

You can use the `keyvault.properties` file to review configuration attributes for these external key vaults:

- CyberArk Password Vault
- AWS Secrets Manager
- Azure Key Vault
- HashiCorp Vault

The following `keyvault.properties` file shows an example with the CyberArk Password Vault:

```
keyvault.type=CYBERARK_PASSWORD_VAULT
keyvault.cyberark.ccp.url=https://services-uscentral.skvtap.com:19516/
keyvault.cyberark.ccp.appid=vb_test_app
keyvault.cyberark.ccp.client.certificate.path=D:\\CyberArk\\client_combined_cert_key_Adminat123.p12
keyvault.cyberark.ccp.client.certificate.passphrase>Password
```

To review the AWS Secrets Manager `keyvault.properties` file, enter these AWS attributes (for example):

- `keyvault.type=AWS_SECRETS_MANAGER`
- `keyvault.aws.region=us-west-2`

---

### Note:

- The certificate passphrase attribute contains the encrypted Control Room certificate file passphrase. Do not modify the certificate passphrase attribute directly; instead, you should use the key vault utility.

- You can modify the `keyvault.properties` file. However, any modifications will require a service restart. So we recommend that you always use the key vault utility to make modifications.

For HashiCorp Vault, Vault servers are configured using a file that is in HashiCorp configuration language (HCL) or JSON format. For information about using the file, see [Vault Configuration](#).

## Use the application log files

You can use these application log files to review external key vault integration information:

- `WebCR_CredentialVaultlog`
- `WebCR_RestException`

You can use these log messages to troubleshoot external key vault integration or configuration issues:

Log message description	Cause or reason
Unable to send an email Unable to connect to SMTP server because either your SMTP username or password is incorrect	Retrieved SMTP credential is incorrect.
Logs indicate failure connecting to LDAP	Failure to authenticate through Active Directory.
WebCR.1log file shows database connectivity error, and the Control Room fails to boot up correctly	Retrieved database password is incorrect.
Either your username or your password is incorrect	Retrieved auto-login credential is incorrect for the user (correlates to the bot deployment log for user ID).
Logs indicate connection failure to CyberArk	A possible certificate expiry issue exists if failure occurs after a period of proper functioning for (3, 6, or 12) months.
Unable to retrieve secret, and detail exception will have cause	A non-existent credential identifier (safe name, object name, or secret name) is in use. Might also indicate the credential identifier was removed from the external key vault (if it was previously working properly).
	Might also indicate that the key vault connection is down or unreachable. Or, connection details (API URL, AppID, certificate, region name, AWS keys) are incorrect, have been changed on the key vault, or expired.

## Workload management

The workload management module enables users to upload Microsoft Excel and CSV files to the Control Room so that it feeds the records from the files into the bot deployments.

These records contain highly sensitive information, for example, PII, PCI, PHI, and more. This data is carefully protected by the data encryption key and is at rest in the file share and database.

Divide your automations into small, logical Work Items from the **Workload** page. Process the Work Items simultaneously to ensure that your automation goals are achieved with optimum resource utilization.

### Prerequisites

To manage your workload automation, ensure that you are allocated a combination of any or all of the following roles and permissions:

Feature type	Privileges
User roles	<ul style="list-style-type: none"> <li>AAE_Queue_Admin</li> <li>AAE_Pool_Admin</li> </ul>
Activity permissions	<ul style="list-style-type: none"> <li>View my in progress activity</li> <li>View my scheduled bots</li> <li>Schedule my bots to run</li> <li>View and manage all scheduled activity from my folders</li> </ul>
Device permissions	<ul style="list-style-type: none"> <li>View and manage my Bot Creator, Bot Runner, and device pools</li> <li>Create device pools</li> <li>Administer all device pools</li> </ul>
Bots permissions	<ul style="list-style-type: none"> <li>View my bots</li> <li>Run my bots</li> </ul>
Workload permissions	<ul style="list-style-type: none"> <li>View and manage my queues</li> <li>Create queues</li> <li>Administer all queues</li> </ul>

### Database

Workload automations are supported on the following databases:

- SQL
- PostgreSQL

- Oracle

## Other resources

Workflow map: Click the following schematic image to view this workload management workflow



in an interactive visual format:

### 1. [Workload management process](#)

Watch the following video on how to use the Workload feature in the Control Room:

Related tasks

[Attach work item template to bot](#) on page 2315

Attach a work item template to a bot to use the bot in workload automation.

[Use Work Item variables](#) on page 2343

You can use the Work Item variables to pass the Work Item attributes or values to the Task Bot from the Control Room when you run the bot with the option **Run bot with queue**.

Related reference

[Workload package](#) on page 3184

The Workload package enables you to insert work items in a queue for workload automation. It also enables data chaining between multiple queues. You can orchestrate multiple bots, and enable optimal device utilization through the queueing mechanism of workload management.

## Create workload queues

A queue is one of the main building blocks of Workload Management. A queue holds data known as Work Items for further processing. The system distributes these Work Items to individual unattended Bot Runners in a device pool for processing.

For workload automation create and attach a work item template to a bot, create device pools, add Bot Runners to the pool, create queues, add queue owners, participants, or consumers, define the work item structure, insert work items, and finally run the automation with the queue.

**Note:** In a multi-user environment, if there are two queues A and B, and multiple work items are in queue A, the device will process work items in queue A first, and then move to queue B. To process both the queues in parallel in a multi-user environment, you must perform one of the following actions:

- Add another device to the existing device pool.

- Create another device pool on the same device.

See the following table for details of the tasks you can perform as a queue owner, participant, or consumer.

Owners	Participants	Consumers
Can perform <ul style="list-style-type: none"> <li>• View the queue</li> <li>• Edit the queue</li> <li>• Add other owners, participants, or consumers to the queue</li> <li>• Add work items to the queue</li> </ul>	Can perform <ul style="list-style-type: none"> <li>• View the queue</li> <li>• Add work items to the queue</li> </ul>	Can perform <ul style="list-style-type: none"> <li>• View the queue</li> <li>• Run bot with queue</li> </ul>
Cannot perform: Run bot with queue	Cannot perform: Run bot with queue	Cannot perform: Add work items to the queue

Queue owners and participants: Note that queue owners can edit a queue (change the queue name, description, add or remove owners, participants, or consumers), but participants cannot edit the queue.

You can create a workload queue in one of the following modes:

- [Express mode](#)
- [Standard mode](#)

## Express mode

To create queues in express mode with default parameters for workload automation in the Control Room. For more information, see [Create express queues using default workload parameters](#).

## Standard mode

The following diagram describes the flow in which you can create a workload queue in standard mode.

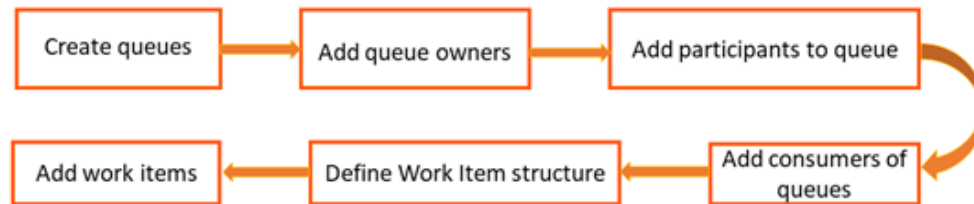

To create a workload queue in standard mode,

1. [Create queues](#) on page 2000

Create queues that hold specific sets of data your bot is expecting for automation. To create queues, a Control Room administrator assigns the **AAE\_Queue Admin** role with **View and manage my queues**, **Create queues**, **Administer all queues**, and **View my in progress activity** permissions.

2. [Add queue owners](#) on page 2001

Add queue owners who can create, edit, and view queues.

3. [Add participants to queue](#) on page 2001

Add queue participants from different roles defined in the Control Room. This is an optional step.

4. [Add consumers of queues](#) on page 2002

Add queue consumers from different roles defined in the Control Room. This is an optional step.

5. [Define Work Item structure](#) on page 2002

Define the Work Item structure for processing in a queue. This enables you to manually upload the Work Items from the system in the absence of ready data in a file.

6. [Insert Work Items](#) on page 2004

Add Work Items from a CSV file to the queue after you define the structure.

Related tasks

[Run bot with queue](#) on page 2006

Collectively process all work items of a queue across all the Bot Runners present in one or more device pools.

[Attach work item template to bot](#) on page 2315

Attach a work item template to a bot to use the bot in workload automation.

## Create express queues

Create queues with default parameters for workload automation using the express queue option in the Control Room.

Ensure that you are logged in to the as the administrator.

You must have the **Create queues** permission to create queues using the express mode.

When you create a queue with default parameters, note the following:

- All .CSV file columns will be available in a workload bot.
- The first 10 columns of the .CSV file will be displayed in the queue.
- All data type will be text.
- Queue sorting will not be available.

1. Navigate to **Manage > Queues**.
2. To create queues with default workload parameters, click **Create express queue**.
3. Enter the queue name.  
The queue name is the same as the workitem template name by default.
4. Optional: Enter the queue description.
5. To select a data file in .CSV format, click **Browse**.
6. Click **Create**.  
The queue is saved and available for workload automation in the **Queues** list.

You can now view queue details, edit a queue, and run a bot with queue.

Related tasks

[View queue details](#) on page 2011

Use the **View queues details** page to view the details of a particular queue.

[Edit queues](#) on page 2013

Edit a queue using two methods - from the **Queues** list, or from the **View queue** page.

[Run bot with queue](#) on page 2006

Collectively process all work items of a queue across all the Bot Runners present in one or more device pools.

## Create queues

Create queues that hold specific sets of data your bot is expecting for automation. To create queues, a Control Room administrator assigns the **AAE\_Queue Admin** role with **View and manage my queues, Create queues, Administer all queues, and View my in progress activity** permissions.

Ensure that you are logged in to the as the administrator.

A queue is processed until all work items are completed. When new work items are added to the queue, the Reactivation Threshold value specifies the minimum number of new work items required to resume queue processing. Work items are those items with a **Ready to Run** status.

Create a queue by providing details such as the queue name, queue owners, participants, consumers, work item structure, and auto-retry for failed work items.

---

**Note:** You can choose to **Create draft of queue** and add the remaining information later.

---

1. Navigate to **Manage > Queues**.
2. Click **Create queue**.
3. Enter the **Name**.
4. Optional: Enter a description.
5. Set the **Reactivation Threshold** to resume queue processing.



Default threshold is **1** (one).

6. Optional: **Time required for a person to complete one work item**: Leave this field blank as it is not supported.
7. To process the failed work items, specify the **Max auto retry attempt**.  
The failed work items are processed for the specified number of times after all the work items in a queue are processed.

The default value of **Max auto retry attempt** is 0 which means the auto retry is not attempted by default. The maximum **Max auto retry attempt** value is 10.

---

**Note:** The failed work items are processed at the end of the staging queue for auto retry.

---

Based on the specified **Max auto retry attempt** number, the **Queues** page shows the remaining auto-retry attempts in the **Retries left** column.

8. Click **Next**.

[Add queue owners](#) on page 2001

Related tasks

[Edit queues](#) on page 2013

Edit a queue using two methods - from the **Queues** list, or from the **View queue** page.

[Delete queues](#) on page 2015

Delete a selected queue, multiple selected queues, or all queues of work items.

## Add queue owners

Add queue owners who can create, edit, and view queues.

Ensure that you are logged in to the as the administrator.

Queue owners are allowed to edit the queue and add new work items to the queue.

The queue creator is the default queue owner and is able to add other Control Room users as queue owners, if required.

1. Select user(s) from the **Available Users** list from the **Owners** tab.
2. Click the right arrow (→) to add your selection.
3. Click **Next**.

[Add queue participants](#)

## Add participants to queue

Add queue participants from different roles defined in the Control Room. This is an optional step.

Ensure that you are logged in to the as the administrator.

Participant roles can add new work items and view the queue. However, they are not allowed to edit other queue properties.

1. Select role(s) from the **Available Roles** list from the **Participants** tab.
2. Click the right arrow (→) to add your selection.
3. Click **Next**.

[Add consumers of queues](#) on page 2002

## Add consumers of queues

Add queue consumers from different roles defined in the Control Room. This is an optional step.

Ensure that you are logged in to the as the administrator.

There are certain mandatory checks that are to be done for unattended bots to be deployed from Control Room to a device:

- The device where the bot is to be deployed should be set as a default device to only the specific bot runner account.
- Ensure that all necessary privileges have been granted to the Bot Runner.
- Ensure that nobody is signed into the device at the time of bot deployment with the Run As permission from a different device.
- Ensure that the console is currently inactive on default device.

Queue consumers can view the queue and all the work items in the queue. In addition, they can use this queue for running bots on Unattended Bot Runners.

1. Select role(s) from the **Available Roles** list from the **Consumers** tab.
2. Click the right arrow (→) to add your selection.
3. Click **Next**.

[Define Work Item structure](#) on page 2002

## Define Work Item structure

Define the Work Item structure for processing in a queue. This enables you to manually upload the Work Items from the system in the absence of ready data in a file.

Define a Work Item structure using any one of the following methods:

1. Using an Excel/CSV file.
2. Using an existing work item template.
3. Manually

---

**Note:** The work flow to process Work Items differs for a queue based on the method that you choose in the **Define Work Item Structure** tab.

---

1. Select a method to add header columns for Work Item processing:
  - **Use an Excel/CSV file:** Add the header columns from an existing Excel or CSV file. You can point to the Excel spreadsheet or CSV file you are using in one or more Task Bots you will run in this queue.
    - a) Enter a unique name for the Work Item structure in the **Work item template** field.  
For example, if the queue contains employee information, you can specify the **Work item template** as Employee Data.
    - b) Select a column for inclusion in the Work Item structure from the list of column names. The columns are defined based on the header rows of the selected Excel or

CSV file. A maximum of ten (10) columns are allowed for selection and viewing in the Control Room.

For example, you can select column headers Employee Name, Employee ID, and Designation. You can then select the **Data Type - Text, Number, or Date** for that column. You can also choose to view these columns being processed in the **Activity** page.

**Note:**

- The system allows you to filter/sort Work Items on the columns for viewing the Work Item data in the Control Room.

[Actions allowed on view queue page](#) on page 2016

- When you upload work items from an xls or xlsx file with data type as text, the Excel file column populated with a date in any format (for example, 8/6/2019) is converted to its corresponding workload management date format (for example, Sat Jun 08 00:00:00) in the Control Room Work Item. However, the same is not applicable to a csv file.

- c) Select up to three columns for sorting in an ascending or descending order.

When the system processes the Work Items from the queue, it uses the sort criteria specified to retrieve the work items in that order.

For example, consider the use case of credit card application processing. The work item structure has the headers **firstName, lastName, creditLimit, cardType** as given in the table below:

firstName	lastName	creditLimit	cardType
John	Smith	10000	<b>Master</b>
Tom	Jones	10000	<b>Visa</b>
Mike	Williams	13000	<b>Master</b>
Aamir	Khan	5000	<b>Master</b>
Salman	Khan	13000	<b>Visa</b>
Akshay	Kumar	10000	<b>Visa</b>

To process the work items from maximum creditLimit to minimum creditLimit followed by cardType from **Master to Visa**, specify creditLimit in descending order and cardType in ascending order. The work items are processed as given in the table below:

firstName	lastName	creditLimit	cardType
Mike	Williams	13000	<b>Master</b>
Salman	Khan	13000	<b>Visa</b>
John	Smith	10000	<b>Master</b>
Tom	Jones	10000	<b>Visa</b>
Akshay	Kumar	10000	<b>Visa</b>

firstName	lastName	creditLimit	cardType
Aamir	Khan	5000	Master

---

**Note:** Work items are processed on sorting order internally. For example, if you add 3 work items a, c, b to be sorted by name, then on the user interface they will be shown as a, c, b. However, the work items will be processed as per the sorting order a, b, c.

---

- **Use work item template:** Add header columns by searching for an **Existing work item template** or from the **Available work item templates**.

This allows you to pass the values or attributes from the template to a Task Bot with the help of Work Item variables when you use the option **Run bot with queue**.

---

**Tip:** Search for an existing Work Item template when there are a large number of templates available for selection.

---

[Use Work Item variables](#) on page 2343

- **Manually:** Define the Work Item structure manually. You do not have to select from an existing structure.

a) Type a name for the Work Item structure in the **Work item template** field.

For example, if the queue contains employee information, add the **Work item template** as Employee Data.

b) Add column header names for the Work Item and select the data type for each column: **Text**, **Number**, or **Date**

c) Select the display and sorting for the columns in the Control Room.

When the system processes the Work Items from the queue, it uses the sort criteria specified to retrieve the work items in that order.

2. Click **Next** to add the Work Items.

[Insert Work Items](#) on page 2004

Related reference

[Work item status and actions](#) on page 2025

Based on the Work Item status, you can do only certain actions on a Work Item.

## Insert Work Items

Add Work Items from a CSV file to the queue after you define the structure.

- Ensure that you are logged in to the Control Room as an administrator.
- The maximum number of characters you can insert in a work item value is 1000.
- Add Work Items from a CSV file to the queue.

---

**Note:** Adding work items from an Excel (xls orxlsx) file is not supported. We recommend that you convert the xls orxlsx file to CSV and then add work items from the CSV file.

---

- You can also add Work Items later by editing the queue, see [Edit queues](#) on page 2013.
- If the Work Item data type is defined as **Date**, the date format must be **ISO\_INSTANT**. For more information on date formats, see [Datetime formats](#) on page 2489.

1. Click **Browse**.
2. Select the CSV file.
3. Optional: Select the **Disallow duplicates** check box.

---

**Note:**

- Only unique work items from the CSV file are added. If the CSV file contains any duplicate work items, then the entire CSV file is ignored. Two work items are considered to be duplicate of each other if all the entries of the two work items are an exact match. If there is a single unique value within the work item (row), the work items are considered unique even if some of their values are duplicate. The work item entries are case sensitive, that is John Smith and john smith are considered two unique entries.

Consider the below table which contains the following work items.

Work item	First Name	Last Name	Department	Employee status
1	John	Smith	Finance	Active
2	Will	Smith	Finance	Active
3	Betty	Williams	Accounts	Inactive
4	john	smith	Finance	Active
5	Jane	Wilson	Accounts	Active
6	Thomas	Moore	Finance	Active

All the work item entries in the above table are considered unique and are added to the queue as no two work items have entries that are an exact duplicate of each other.

- This option is available only when you create a new queue.
-

**Create queue** Cancel Create queue

**General** ✓  
Name  
• test  
Threshold  
• 1 work item(s)  
Time it takes  
• ...

**Owners** ✓  
• 1 user selected

**Participants** ✓  
(optional)  
• 1 role selected

**Consumers** ✓  
(optional)  
• 1 role selected

**Define work item structure** ✓  
Get column headers from:  
• Loan-Q

**Work items structure** ✓  
Work item template  
• Loan-Q  
• 6 columns

**Add work items** ✓  
(optional)

**Do you want to add work items now?**  
This is an optional step. You can add an Excel/CSV file (with headers) with work items now or later.

**Choose an Excel/CSV file**  
Select a file... Browse...

Disallow duplicates

< Back

#### 4. Click **Create queue**.

- Now that you have created a queue, it is now ready for deployment from a bot.
  - [Run bot with queue](#) on page 2006
- Manage Work Items of a queue to fix the discrepancies before queue processing and reduce your automation-related errors.
  - [Manage Work Items](#) on page 2025

## Run bot with queue

Collectively process all work items of a queue across all the Bot Runners present in one or more device pools.

To run a bot with queue, ensure that you are allocated the following roles and permissions:

Feature type	Privileges
Activity permissions	<p>Provide the following permissions for all bots and its dependencies:</p> <ul style="list-style-type: none"> <li>• <b>View my in progress activity</b></li> <li>• <b>View my scheduled bots</b></li> <li>• <b>Schedule my bots to run</b></li> <li>• <b>View ALL scheduled activity from my Folders</b></li> <li>• <b>Manage ALL scheduled activity from my Folders</b></li> <li>• <b>Schedule</b> permission at the folder level.</li> </ul> <hr/> <p><b>Note:</b> The bot must be linked to the same work item structure as the queue.</p>
User role	<p>Your custom role must have the following:</p> <ul style="list-style-type: none"> <li>• <b>Consumer</b> access to the queue you want to process</li> <li>• <b>Consumer</b> access to the device pool on which you want to process the queue</li> <li>• <b>Run as user</b> assigned to the role</li> </ul>

To **Run bot with queue**, note the following:

- You can run bots only on unattended Bot Runners. You cannot run bots on attended Bot Runners from the Control Room.
- The bots have to be checked in to the public folder in order for the bots to qualify to be run with queue.
- Work item sorting is done on the batch added to the queue. For example, if you add 2 batches of work items a, c, b and a, c, b to be sorted by name, the work items will be processed for queuing as a, b, c and a, b, c.
- If you use the same device pool for inserting and processing work items for the same queue, you will see duplicate entries in the **In-progress activity** and **Historical** page. To resolve this issue, use one device pool to insert work items and a different device pool to process work items in a queue.

Use the **Run a bot with queue** option from any of the following pages:

- Activity > In progress**
- Manage > Scheduled**
- Manage > Devices**
- Manage > Device pools**
- Manage > Queues**

The procedure for running a bot with a queue is the same in all these pages.

1. Select the bot to run with queue.
  - Latest version: Click **Latest version** tab to select the latest version of the bot.
  - Labeled version: Click **Production version** tab to select the labeled version of the bot.

Available bots are displayed along with any **Input values** and dependencies. If the production label option is selected for the parent bot, the corresponding dependent bots with the production label are also automatically selected. If any of the dependent bots do not have the production label applied, the latest version of the bot is selected.

2. Optional: Select **Run with administrative privileges** if the bot has actions that require administrative privileges to run.
  3. Select a queue with which to run the bot.
- 

**Note:** Ensure the following to see the list of available queues:

- You do not have the AAE\_Admin role
  - Your role is added to **Queue > Consumers**
  - The bot and queue work item templates are identical
- 

4. Optional: Set the queue running time.
    - a) Click **Add running time** in the **Processing time** tab.
    - b) Select the days from **Days of the week** field.
    - c) Enter the **Start time** and **End time**.
    - d) Click **Add time** to add another time period for the days selected.  
You can add up to three time periods which cannot overlap with each other.
    - e) Click **Add running time** to add another running time and provide the day and time details.  
You can add up to three running times. If the running time is not set, the queue runs for 24 hours.
    - f) Optional: Click **Remove running time** to delete any running time.
  5. Select the Bot Runner user from the **Available bot runners** list.  
To enable a device, it must be connected to the Control Room.
- 

**Note:** If a device does not appear in the list, ensure the user running the bots is assigned a role that provides access to the appropriate Run-As Users.

---

6. Optional: Select the option to run on bot running devices.  
If you want to select Bot Runners that are mapped one-on-one with their default (single-user) devices, select the **Run on bot running devices** option. This option enables the Work Items to be deployed only to the user's default device, whereby the security policy does not allow a user to log in to any other device or when applications for automation are installed on the default device.

If you select this option, ensure that all the default devices are part of the same device pool when you select from the **Device Pool** tab.

---

**Tip:** Do not select this option if the run as users (Bot Runners) are configured to use multiple devices. In that configuration, if any device in the pool is processing an automation, the run as user can log in to another device, and the work items will be processed on that device. This enables optimal utilization of licenses (run as user) and devices.

---

For information on scenarios for choosing bot running devices for run as users, see [Considerations for running a bot](#) on page 2283.

---



7. Select **Device pools**.  
Select the pool from the list of available device pools.
8. Optional: Click the up or down arrow to set the selected device pools in preferred order.  
When a is deployed, the selects the first available device based on the order in which you organized the device pools. If none of the devices are available at the time of deployment, the is queued.
9. Select the **Automation priority** from the **General** tab.  
Set the priority to high, medium, or low based on your requirements for resource optimization. The default permission is set to medium.
10. Click **Run bot with queue**.

---

**Note:**

- If a user who created the WLM automation using the **Run bot with queue** option is deleted, the automation is also affected and queues cannot be processed.
- Bots are not deployed when Bot Runners are mapped one-on-one with their default (single user) devices with **Run on bot running devices** option selected and one or more devices in the selected device pool is disconnected.
- If you have more number of resources (devices and run-as users) than the number of work items added, you might observe the proxy deployments on the **Activity > Historical** page. To view the appropriate work item status, refer [Work item status and actions](#) on page 2025.
- Historical activity displays only the bots that are processing the work items, while each bot deployment can include multiple work items processed as one activity.

---

The following video demonstrates how to run a bot with queue.

**Related tasks**

[View automation of a queue](#) on page 2018

Use the **View activity in progress** page to view the automation details of the selected queue, **Pause**, **Resume**, or **Stop** the in-progress automation.

**Related reference**

[Capacity and performance planning](#) on page 1182

Scale your automation by planning for capacity and performance requirements. To plan your capacity and performance for Control Room On-Premises, review the requirements, limits, and defaults that determine the number of simultaneous bots, user sessions, and processing rates.

## Add Task Bots and dependent files

Add a Task Bot, and review the input values and dependent files for the automation.

1. Navigate to **Activity > Scheduled, Automation**, or the **Workload > Queues** page.
2. Click **Run bot with queue**  
The **Activity > Run bot with queues Create** page is displayed.
3. Enter a name for the automation.
4. Optional: Enter a description.  
For example, you can describe the purpose of running the Task Bot with a queue.
5. Go to the folder that contains the required Task Bot.
6. Select a Task Bot to process in the queue from the list.

- Latest version: Click **Latest version** tab to select the latest version of the bot.
- Production label: Click **Production label** tab to select the labeled version of the bot.

By default, the Bots folder is selected.

---

**Tip:** Use the search field to find a Task Bot quickly.

---

The **Input values** and **Dependencies** options are displayed at the bottom of the page.

If the production label option is selected for the parent bot, the corresponding dependent bots with the production label are also automatically selected. If any of the dependent bots do not have the production label applied, the latest version of the bot is selected.

7. Optional: Select the **Input values** check box to add the values of variables to the bot during runtime.

This is enabled only if the selected Task Bot has **Input values**.

---

**Note:** In workload automation, input to the bot is provided by the workload queue, the input type variable is not supported in workload automation.

---

8. Optional: Review the list of dependent files, if available.

This list is enabled only if the selected Task Bot has dependencies. The Task Bot dependencies that are uploaded in the Control Room are available only for review.

9. Click **Next** to add a queue, Bot Runner and device pool.

[Add queue, Bot Runner, and device pool](#) on page 1888

If the selected Task Bot does not contain a work item template, an error message appears at the top of the page. The Task Bot also shows an icon to indicate a missing work item template.

[Define Work Item structure](#) on page 2002

Related reference

[Bot dependencies](#) on page 2359

Bots dependencies are files and other bots that are required to run that bot successfully.

## Manage workload queues

For workload maintenance tasks such as view the details of queues to pause, stop, or resume its automation, edit the queues, manage the work items in the queue, and delete the queues.

---

**Note:** In a multi-user environment, if there are two queues A and B, and multiple work items are in queue A, the device will process work items in queue A first, and then move to queue B. To process both the queues in parallel in a multi-user environment, you must perform one of the following actions:

- Add another device to the existing device pool.
  - Create another device pool on the same device.
-

## Workload maintenance tasks

For workload automation maintenance, do the following (in any order):

[View queue details](#) on page 2011

Use the **View queues details** page to view the details of a particular queue.

[Edit queues](#) on page 2013

Edit a queue using two methods - from the **Queues** list, or from the **View queue** page.

[Delete queues](#) on page 2015

Delete a selected queue, multiple selected queues, or all queues of work items.

[Manage Work Items](#) on page 2025

Manage Work Items of a queue to fix the discrepancies before queue processing and reduce your automation-related errors.

Related reference

[Actions allowed on view queue page](#) on page 2016

Use different actions such as sorting, searching, or filtering on the table view of the queues.

## View queue details

Use the **View queues details** page to view the details of a particular queue.

Ensure that you are logged in to the as the administrator.

Permissions required:

1. **Queue Owner** or **Queue Participant** or **Consumer** rights
2. **View and manage my Queues** feature permission
3. A user with **AAE\_Admin** role can view all the queues and manage (pause, resume, and stop) all the WLM automations.

---

**Note:** If you are not an owner, participant, or consumer of that queue, you can view only queue names and not the queue details.

---

The **View queues** page shows the following queue details:

- **New** when the work item is added to the queue recently.
- **On hold** when the work item is deferred from processing by a Queue owner, participant, or consumer.
- **Failed** when the work item processing failed on an unattended bot.
- **Completed** when the work item is successfully processed by a Bot Runner or marked Completed by a queue owner, participant or consumer.
- **Data error** when there is an error in loading data from the file.
- **Active** when the work item is currently being processed or staged for processing.
- **Ready to run** when the work item is successfully processed for execution does not have any data errors and can be staged for processing.

Queue contents in different tabs such as:

1. **Work items:** This is the default view. This allows you to view all work items in a tabulated form. You can use the filter to view specific work items. For example, all work items with

status as **Completed**. You can **View**, **Edit**, or **Delete** the individual work items in each row. You can also change the status of the work items in bulk. For example, change the status of all the work items in **Data error** to **On hold**.

---

**Note:** When auto-purge setting is enabled, the **Work items** tab for queues in edit and view mode shows a message that informs days after which the completed work items will be deleted. For example, `Completed work items older than 30 days will be automatically purged.`

---

2. **General:** View the Reactivation Threshold and **Time** required to complete one work item.
3. **Owners:** View the user names of queue owners who can edit the queue and add new work items.
4. **Participants:** View the user names of queue participants who can add new work items and view the queue.
5. **Consumers:** View the user names of consumers who can view the queue and all the work items in the queue. In addition, they can use this queue when running bots.
6. **Work Item Structure:** View the work item structure that you defined when creating the queue.

---

**Tip:** Edit any of these details by either clicking the **edit this queue** link or the **Edit** button. Also, delete the queue by clicking the **Delete** button.

---

1. Navigate to **Manage > Queues**.
2. Hover over the **Actions** icon for the queue.
3. Click **View**.

[View automation of a queue](#) on page 2018

Related concepts

[Manage Work Items](#) on page 2025

Manage Work Items of a queue to fix the discrepancies before queue processing and reduce your automation-related errors.

Related tasks

[Create queues](#) on page 2000

Create queues that hold specific sets of data your bot is expecting for automation. To create queues, a Control Room administrator assigns the **AAE\_Queue Admin** role with **View and manage my queues**, **Create queues**, **Administer all queues**, and **View my in progress activity** permissions.

[Edit queues](#) on page 2013

Edit a queue using two methods - from the **Queues** list, or from the **View queue** page.

[Delete queues](#) on page 2015

Delete a selected queue, multiple selected queues, or all queues of work items.

Related reference

[Actions allowed on view queue page](#) on page 2016

Use different actions such as sorting, searching, or filtering on the table view of the queues.

## Edit queues

Edit a queue using two methods - from the **Queues** list, or from the **View queue** page.

Ensure that you are logged in to the as the administrator.

Permissions required:

1. **AAE\_Queue Admin** role.
2. **Queue Owner** rights to edit queues that you created.
3. **Queue Participant** rights to edit queues that are created by other queue owners.

You are allowed to edit a work item only if it is in **New, Data error, On hold, Ready to run, or Failed** state.

Edit a queue from the **View queue** page or from the **Queues** list.

1. Navigate to **Manage > Queues**.
2. Hover over the **Actions** icon for the queue.
3. Click the **Edit** icon. 
4. Click one of the following options to launch the **Edit Queue** page.
  - **edit this queue** link.
  - **Edit** button.
5. Edit the queue details, such as queue name (applicable only if in draft), description, work items, threshold and time values, auto retry attempt (applicable only if queue is not in use), owners, participants, and consumers.

---

### Note:

- The Work Item structure cannot be edited after it is defined.
- When you edit a queue and set new auto retry number, the new number is only applicable to the new failed work items. If the queue owner changes the auto retry attempt value to a number less than the existing number, the work item will not be retried.
- The queue name must be unique and not be shared by another queue.

- 
6. Upload a file for the work item that will be used for processing in this queue.  
The **Work Items** tab is shown by default.

---

**Tip:** You can search for a work item quickly based either on **Status** or Status details using the search option.

- 
7. Click **Browse**.
  8. Select the file to upload.

---

**Note:** You can upload only an Excel or CSV file.

- 
9. Optional: Put work items on hold.
    - a) Select the work items and click **On hold** from the table level icons list.

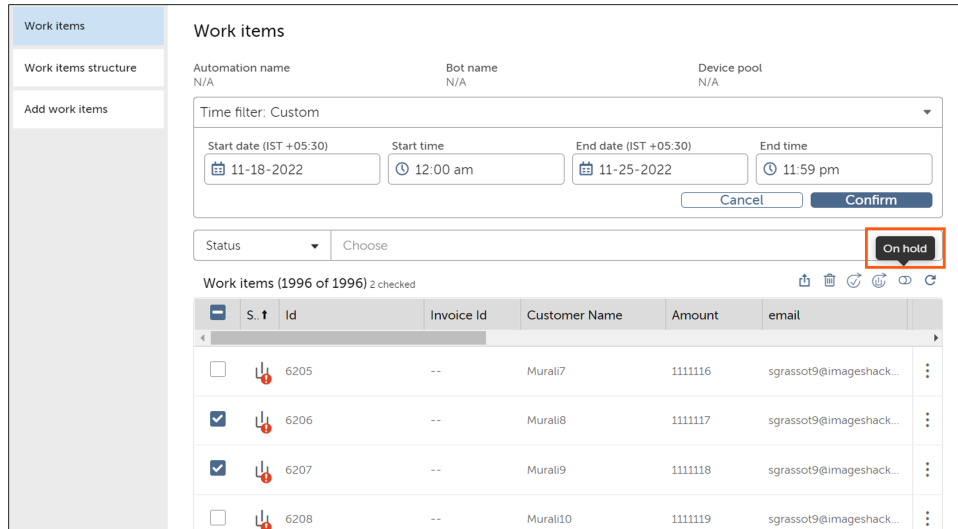

- b) In the **To update** screen, select one of the following options:
- **Indefinitely**: The work item is put on hold until you manually move it for re-processing.
  - **Until**: The work item is put on hold until the specified date and time. Enter the **Date**, **Time**, and **Time zone** in their respective fields.

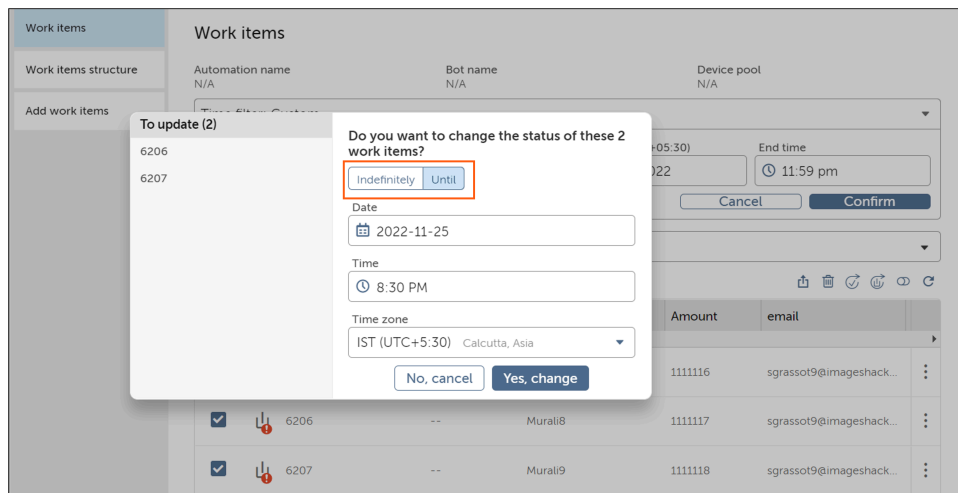

- c) Click **Yes, change**.  
The selected work items are put on hold.

**Note:** The column **On hold until** in the **Edit queue** page displays the work item hold status (indefinitely or specific date and time). The status of the work items which are not on hold are shown as **N/A**.

10. Click **Save changes**.
11. Edit the name and save the changes made to the queue.  
An edit successful message appears.

Related concepts

[Manage Work Items](#) on page 2025

Manage Work Items of a queue to fix the discrepancies before queue processing and reduce your automation-related errors.

Related tasks

[Create queues](#) on page 2000

Create queues that hold specific sets of data your bot is expecting for automation. To create queues, a Control Room administrator assigns the **AAE\_Queue Admin** role with **View and manage my queues, Create queues, Administer all queues**, and **View my in progress activity** permissions.

Related reference

[Actions allowed on view queue page](#) on page 2016

Use different actions such as sorting, searching, or filtering on the table view of the queues.

## Delete queues

Delete a selected queue, multiple selected queues, or all queues of work items.

You must have the following rights and permissions to complete the task. Ensure you are logged in to the Control Room as the administrator. To complete the task, you must have **AAE\_Queue Admin** role and **Queue Owner** permission assigned to you.

**Note:** You cannot delete a queue if it is being used for processing a work item. An error message appears for that particular queue.

1. Log in to the Control Room.
2. Go to **Manage → Queues**.
3. Select one of the following options to delete selected or multiple queues:

Option	Steps
Delete selected queue	<p><b>a)</b> Hover over a queue that you want to delete.</p> <p><b>b)</b> Click <b>Actions</b> and then click <b>Delete</b></p> <p>A confirmation message to permanently delete the queue appears.</p>
Delete multiple selected or all queues	<p><b>a)</b> Select the check box before the required queues.</p> <hr/> <p><b>Note:</b> You can select the check box in the header to select all queues.</p> <hr/> <p><b>b)</b> Click the <b>Delete</b> button above the header.</p> <p>A confirmation message to permanently delete multiple queues appears.</p>

**Note:** You cannot delete a queue that is in the **In use** status. An error message displays to indicate that only queues that are not in **In use** status can be deleted.

4. Click **Yes, delete** to confirm the selection. Otherwise, click **No, cancel** to discard the action. A confirmation message appears after you delete the queue.

Related tasks

[View queue details](#) on page 2011

Use the **View queues details** page to view the details of a particular queue.

[View automation of a queue](#) on page 2018

Use the **View activity in progress** page to view the automation details of the selected queue, **Pause**, **Resume**, or **Stop** the in-progress automation.

[Edit queues](#) on page 2013

Edit a queue using two methods - from the **Queues** list, or from the **View queue** page.

## Actions allowed on view queue page

Use different actions such as sorting, searching, or filtering on the table view of the queues.

### Searching and filtering

For ease of access, apply search parameters to **ID**, **Start Time**, **Work item result**, **Status**, and **Queue Name** columns.

- Specify the search parameters in the search bar for **Queue Name**. When you specify search parameters for the same column, the system searches using **OR** operator. When you specify search parameters for different columns, the system searches using **AND** operator.
- Choose the search parameters from a list in the search bar for Work Item **Status**.
- Apply filters to **Work Item Result** to quickly track the final status of the work item. For example if the work item was completed or skipped.
- Use the **Work Item ID** to search for specific work items and combine with the **Start Time** to monitor the progress of the work items that you search based on the **ID**. The **Start Time** filters the list of all work items that start between two given **Start Date** and **Start Time**. For example, all work items started between 01/08/2021 13:00 hrs. and 31/08/2021 15:00 hrs.

**Note:** Use a hyphen (-) as separator between IDs as any other symbol gives an error. For example, 100-250.

### Table items

The following describes the list of items that can be viewed in the table:

Table Item	Description
ID	Shows the system generated id for a work item. When a work item is added to a queue, system generates an id for that work item.



Table Item	Description
Status	Shows Work item status: Use the <b>View queues details</b> page to view the details of a particular queue.
Start Time and End Time	Shows the work item's processing start/end time and date.
Modified by	Shows the name of the last user who had modified the work item.
Last Modified	Shows the time and date when the work item was modified last.

**Note:** Apart from the above system generated columns, the fields that you define in your work item are also displayed as columns.

### Actions on table column

Use the following actions on a table column:

- Click a column to sort it in ascending and descending order. You can sort up to three columns by holding the Shift key when you click two more columns. This gives you the option of sorting two additional columns. This way the sorting is done on the entire table and not just the data that is currently visible to you. The last sorting is stored in memory applied by a user per session.
- Drag a column to the left or right
- Move your mouse cursor at the end of the column and drag to re-size

### Actions on work items

Use the following tasks on specific work items:

Table Item	Description
Refresh	Allows you to refresh the table contents so that you can view the latest work item status
Delete	Allows you to delete one or multiple work items.
Mark complete	Allows you to mark one or more work items as <b>Complete</b> whose status is <b>On hold, Data Error</b> , or Ready to run.
New	Allows you to mark one or more work items as <b>New</b> whose status is <b>On hold</b> , or <b>Data Error</b>

Table Item	Description
On hold	Allows you to mark one or more work items as <b>On hold</b> whose status is <b>New</b>
Customize columns	Allows you to show or hide specific columns. By default, all columns are displayed including the ones defined in the work item.

Alternately, select work items and use the following actions. Note that these actions can be performed only at a table level and not on individual work items.

Table Item	Description
View	Allows you to view details of selected work item.
Edit	Allows you to edit details of selected work item. You can see this icon only if you are the <b>Queue Owner</b> or <b>Participant</b> or <b>Consumer</b> and the status of the work item is <b>Unsuccessful</b> , <b>On hold</b> , or <b>Data error</b>
Delete	Allows you to delete the selected work item. Note that if a work item is in <b>Active</b> state, you are not allowed to delete it.

Related tasks

[Define Work Item structure](#) on page 2002

Define the Work Item structure for processing in a queue. This enables you to manually upload the Work Items from the system in the absence of ready data in a file.

## View automation of a queue

Use the **View activity in progress** page to view the automation details of the selected queue, **Pause**, **Resume**, or **Stop** the in-progress automation.

You must have the following permissions to view automation of a queue:

- **AAE\_Queue Admin** role
- **Queue Consumer** or **Queue Participant** rights
- **Manage everyone's In progress activity** feature permission
- **View and manage all scheduled activity from my folders** activity permission (if you have access to the folder which has the WLM bot)
- **View and manage all scheduled activity** permission (if you do not have access to the folder which has the WLM bot)

---

### Note:

- Though the **View automation** page is accessible from the **Workload** module, the page is launched from the **Activity** module.

- You cannot **Pause/Resume** or **Stop** actions directly from the **Activity > In progress** page. For these actions, the **Manage > Queues > View automation** action is used.
- Bots that are in the **Queued** status do not appear automatically on the **In progress activity** page. You must click the **Refresh table** button on the top-right corner of the activity table to view the queued bots.

1. Log in as administrator to the Control Room.
2. Go to **Manage → Queues**.
3. Hover over a queue with the **In use** status.
4. Click the Actions menu (vertical ellipsis) and select **View automation**. This launches the **Activity > Run bot with queue > View** page.
5. Choose one of the following options to view automation of a queue:

Options	Description
Automation details of the queue	<ul style="list-style-type: none"> <li>• The Bot name, path, dependencies, and if it requires administrative privileges to run in the <b>Task Bot</b> tab.</li> <li>• The Queue used to run the automation in the <b>Queue</b> tab.</li> <li>• Bot Runner details such as username, device, and user status in the <b>Run as</b> tab.</li> <li>• Details of the device pool in use to run the automation in the <b>Device pool</b> tab.</li> <li>• Details such as number of work items that were active, failed, pending, or completed processing in the <b>Run history</b> tab.</li> </ul>
Pause	<p>The system pauses the distribution of work items from this queue to available bot runners in the device pool.</p> <hr/> <p><b>Note:</b> Until you resume this automation, any work items with <b>Ready to Run</b> status from this queue are not sent for processing.</p> <hr/>
Resume	<p>The system starts distributing the work items from this queue.</p> <hr/> <p><b>Note:</b> Bots will fail to deploy if the WLM automation is paused and resumed when Bot Runners are mapped one-on-one with their default (single user) devices with <b>Run on bot running devices</b> option selected and one or more devices in the selected device pool is disconnected while the WLM automation is in paused state.</p> <hr/>

Options	Description
Stop	<ul style="list-style-type: none"> <li>The system stops distributing the work items from the queue associated with this automation.</li> <li>Select <b>No, cancel</b> to return to the details page or <b>Yes, stop</b> to stop the work item processing and return to the <b>Queues</b> page.</li> </ul>
Edit	Update the automation details such as processing time, queue, and device pool.

[Edit queues](#) on page 2013

Related tasks

[View queue details](#) on page 2011

Use the **View queues details** page to view the details of a particular queue.

[Delete queues](#) on page 2015

Delete a selected queue, multiple selected queues, or all queues of work items.

## Edit workload management automations

You can edit a workload management (WLM) automation (in use queue) and update processing time, run-as users, and device pool details.

You must have the following roles and permissions to edit the workload management automation (in use queue):

Feature type	Privileges
Activity permissions	<p>Provide the following permissions for all bots and its dependencies:</p> <ul style="list-style-type: none"> <li><b>View my in progress activity</b></li> <li><b>View my scheduled bots</b></li> <li><b>Schedule my bots to run</b></li> <li><b>View ALL scheduled activity from my Folders</b></li> <li><b>Manage ALL scheduled activity from my Folders</b></li> <li><b>Schedule</b> permission at the folder level.</li> </ul> <hr/> <p><b>Note:</b> The bot must be linked to the same work item structure as the queue.</p>
User role	<p>Your custom role must have the following:</p> <ul style="list-style-type: none"> <li><b>Consumer</b> access to the queue you want to process</li> <li><b>Consumer</b> access to the device pool on which you want to process the queue</li> <li><b>Run as user</b> assigned to the role</li> </ul>

When you select the **View and manage automation** option for the **In use** queues, you can edit a paused or active automation to update details.

When you edit a workload management automation:

- You cannot edit the **Bot and dependencies**, **Queue**, **Run history**, and **General** details.
- The automation ID does not change.
- You can edit any paused or active automation.

1. Log in as administrator to the Control Room.
2. Navigate to **Manage > Queues**.
3. Hover over or click the three dots icon next to the queue that is in the **In use** status and click **View and manage automation**.  
The queue details are displayed.
4. Click **Edit** to update the following details:
  - a) **Processing time**: Add or update the running time, days, and time slots for the selected queue.
  - b) **Run as**: Select or update the Bot Runner devices for the selected queue.

---

**Note:** If you select the **Run on bot running devices** option, you must include all the run-as users' default devices in the same device pool (which will be available to select on the **Device pools** page).

---

- c) **Device pool**: Select or update the device pool for the selected queue.
- 

**Note:**

- The workload management automation is processed based on the order of the automation queue. If the device pool has priority-based deployment, then the automation will be processed at the end of the priority.
  - If you do not change the device pool, then the order of the automation queue does not impact the automation deployment.
- 

5. Click **Save**.  
The existing automation is stopped and automation details are updated immediately.
- 

**Note:**

- When you stop the existing automation, it does not impact bots which have been deployed on the Bot Runners.
  - When you edit the automation, the audit log entries are recorded on the **Administration > Audit log** page with the **Update automation** event type. You can view the old and new automation values in the audit log entries.
  - During the execution of the WLM automation, bots are not deployed when Bot Runners are mapped one-on-one with their default (single user) devices with **Run on bot running devices** option selected and one or more devices in the selected device pool is disconnected.
-

## Export queues

Export queues for flexible usage that ensures efficient processing of WLM automations. With export queues feature, you can reuse queues across environments such as Dev, QA, and production.

- You must have the **AAE\_Queue\_Admin** role to export queues.
- Ensure that the target Control Room user has create users, create roles, and install license permissions.
- The source and target Control Room instances must be running the same version.
- The source and target Control Room instances must be of same setup type: SSO with SSO, AD with AD, and non-AD with non-AD.
- To receive an email notification on successful export of a queue, ensure that the following notification is selected in **Administration > Settings > Email: A BLM package is exported or imported, to the user who performed BLM export or import**.

For more information see [Edit email notifications](#) on page 1820.

When exporting a queue, consider the following factors:

- You can export only the queues that are in the Not in use state. The queues in the New or Draft state cannot be exported.
- Before you export a queue, you must pause all the running WLM automations or queues.

To export a queue, perform the following steps:

1. Navigate to **Manage > Queues**.
2. Select the required queue and click **Export queues**.
3. In the **Export queues** page, select a queue that you want to export, click the right arrow (→), and then click **Next**.

You can select the **Include work items** option to export work items along with the queues. By default, the **Include work items** option is not selected.

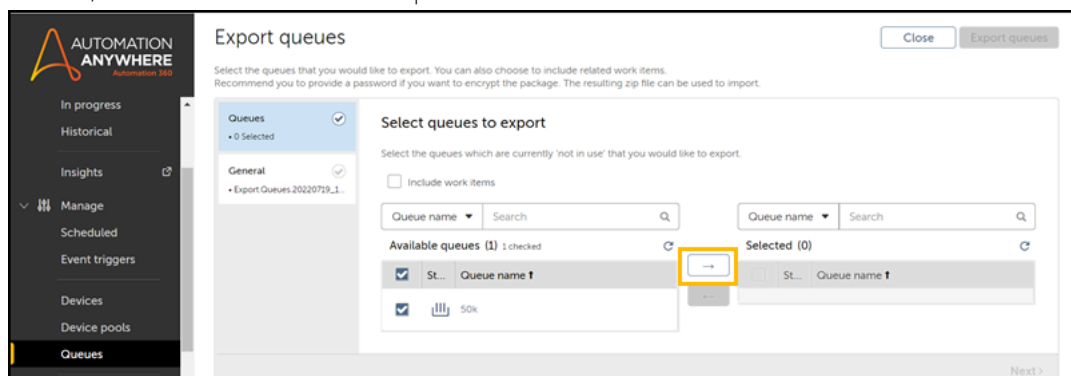

**Note:** When you export a queue along with a large number of work items, the export or import process might take time up to 30 minutes.

4. In the **General** section on the left pane, perform the following steps:
  - a) Required: Specify an **Export name** for the queue that you want to export.
  - b) Optional: Specify a password for the exported queue.  
If you specify a password, confirm the password in the **Confirm password** field.

## 5. Click **Export queues**.

The selected queue is exported and available in the **Activity > Historical** page. The exported queue is in the following file format: Queue Export:Export.Queues.20220715\_162251.<username>>

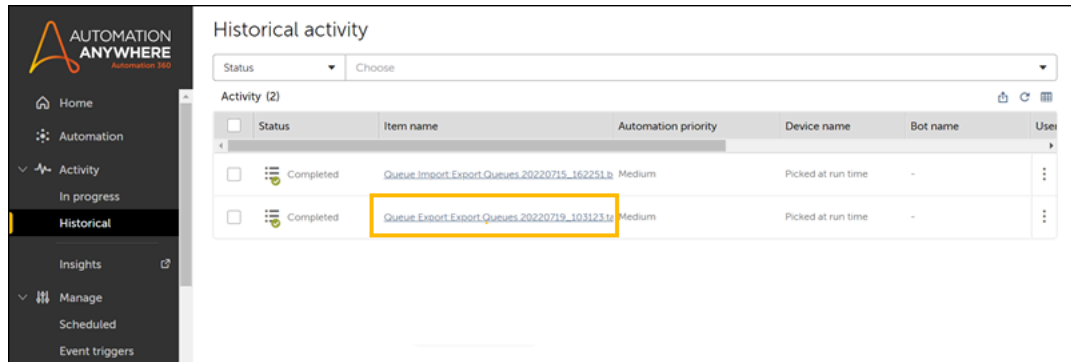

**Note:** If Automation 360 is email-enabled and the **A BLM package is exported or imported, to the user who performed BLM export or import**, notification in **Settings > Email** is selected, an email notification is sent to your registered email ID. The email body contains a link to the **Activity > Historical** page to download the exported queue.

## 6. Select the queue and click **Download exported zip file**.

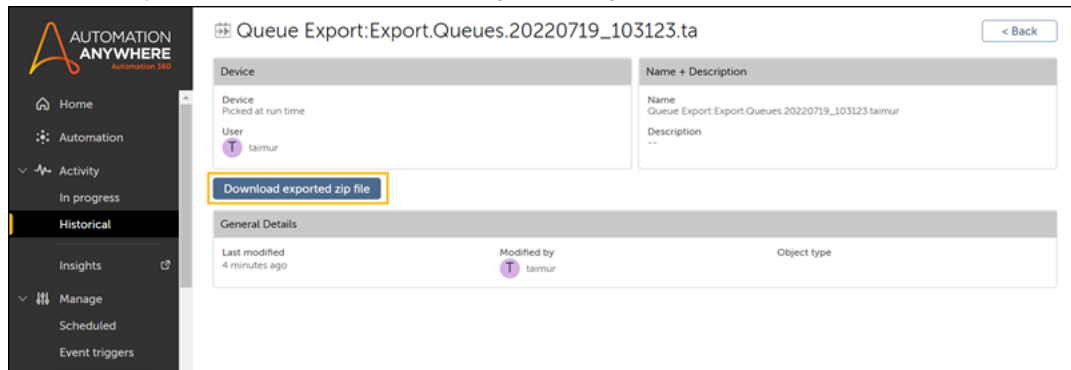

The exported queue zip file is downloaded to your local system, with details such as Queue general settings, Queue work item template, and Work items (if included during export).

**Note:** Data such as queue owners, consumers, and participants is not exported.

## Import queues

Import queues for flexible usage that ensures efficient processing of WLM automations. You can also import queues along with work items.

- You must have the **AAE\_Queue\_Admin** role to import queues.
- Users and roles associated with the queues are imported, and the license assigned to the users is also imported.
- Ensure that the target Control Room user has create users, create roles, and install license permissions.
- Ensure that queue names are unique for importing. Queues with the same name are skipped and not imported in the target Control Room.

- The source and target Control Room instances must be running the same version.
- The source and target Control Room instances must be of same setup type: SSO with SSO, AD with AD, and non-AD with non-AD.

When importing a queue, consider the following factors:

- Before you import a queue, you must pause all the running WLM automations or queues.
- Users and roles associated with the queues are imported. Licenses (for example, Bot Creator and Bot Runner) that are assigned to the users associated with the queues are also imported.
- All the queue entities associated with the queue, for example, general settings, owners, participants, consumers, Work Item structure, and optionally Work Items are imported to your Control Room.
- When you import Work Items with the queues, the state of the Work Items (Completed, Failed, Data error, and so on) are maintained in your target Control Room.

To import a queue, perform the following steps:

1. Navigate to **Manage > Queues**.
2. Select the required queue and click **Import queues**.
3. In the **Import queues** page, click **Browse** to select the required queue from your local system.
4. Optional: Enter a password for the queue that you want to import.

If a queue already exists in your environment, you can select one of the following options:

- **Skip the queue (don't import it)**: The selected queue is skipped and is not imported.
- **Make a copy of the queue (a suffix of "copy" will be added to the queue name)**: A copy of selected queue is created and imported to your environment, with copy suffixed to the name of the queue.

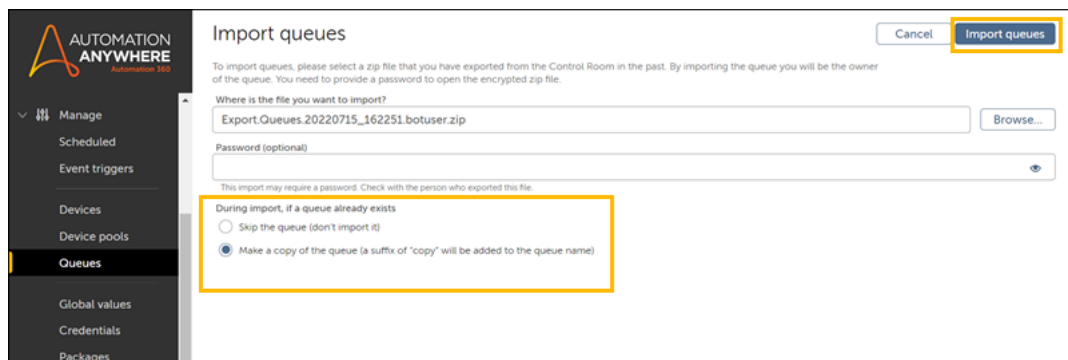

5. Click **Import queues**.

The selected queue is imported and available in the **Manage > Queues**

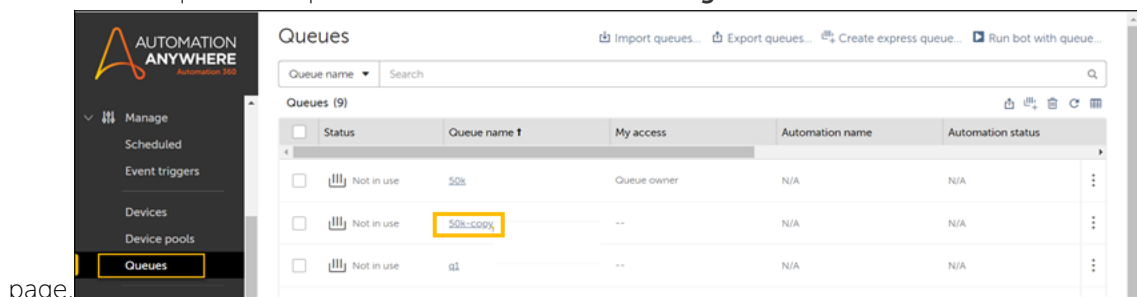

page.



## Manage Work Items

Manage Work Items of a queue to fix the discrepancies before queue processing and reduce your automation-related errors.

### Permissions required

You need any of the following permissions to manage the work items:

1. **AAE\_Queue Admin** role
2. **View and manage my Queues** feature permission
3. **Queue Owner, Queue Consumer,** and/or **Queue Participant** permissions

### Work item status and actions

Based on the Work Item status, you can do only certain actions on a Work Item.

#### Work item - status and actions

The following table provides a description of each Work Item status and the action you can do on a Work Item having that status:

Work Item Status	Description	Actions
Data Error	Data type mismatch when adding Work Items to the queue	View, Edit, and Delete
New	New Work Item is added	View, Edit, and Delete
Ready to run	Work Item is successfully processed for execution	View, Edit, and Delete
On hold	Work Item is deferred for use by the Queue admin	View, Edit, and Delete
Active	Work Item is currently being processed	View and Edit
Completed	Work Item successfully processed by a Bot Runner	View and Delete
Failed	Work Item processing has failed to execute on unattended Bot Runners	View, Edit, and Delete

### Work item lifecycle

You can create work items in bulk by uploading them through a CSV file or by using the REST API. When you upload a large number of work items using a CSV file, they are inserted in multiple

batches and status of newly inserted work items is marked as Draft until all of them are inserted from the file. Following is the work item lifecycle through various statuses:

- **Data error:** When work items fail while inserting from a CSV file, they are marked as **Data error**.
- **New:** When all the work items are inserted from the CSV file, the work item status marked as **New**.
- **Ready to run:** When a work item is cached and ready to process, the work item status changes from **New** to **Ready to run**.
- **On hold:** When a user does not want to process a work item, it is marked as **On hold**.
- **Active:** When work item is sent to the Bot Runner, the status is changed to **Active**.
- **Completed:** When work item is processed successfully, the status is marked as **Completed**.
- **Failed:** When a work item fails during processing, the status is marked as **Failed**.
- **Unknown:** When a device fails to report back on the status of work item processing, it is marked as **Unknown**.

Related tasks

[Edit work items](#) on page 2027

Use the **Queues** page or the **Work item** page to edit the work items of a queue.

[Define Work Item structure](#) on page 2002

Define the Work Item structure for processing in a queue. This enables you to manually upload the Work Items from the system in the absence of ready data in a file.

## View work items

View work items with a status of Completed, Unsuccessful, On hold, Active, or Data Error in the **View work item** page.

Ensure that you are logged in to the as the administrator.

From the **Workload > Queues** page, you can perform the following actions on either one queue or multiple queues, including:

- **Delete:** This will delete the work item permanently.
- **Mark complete:** This will mark the work item as complete.
- **Re-process:** This will mark the work item in **New** state.
- **On hold:** This will mark the work item as **On hold**.

---

**Note:** The **Start time** and **End time** are shown when the work item is being processed.

---

Select a queue to **View**, **Edit**, or **Delete** a queue.

1. Navigate to **Manage > Queues**.
2. Hover over the **Actions** icon for the queue.
3. Click **View**.

[Edit work items](#) on page 2027

[Delete work items](#) on page 2027

Related reference

[Work item status and actions](#) on page 2025

Based on the Work Item status, you can do only certain actions on a Work Item.

## Edit work items

Use the **Queues** page or the **Work item** page to edit the work items of a queue.

Ensure that you are logged in to the as the administrator.

You can edit a work item only if it is in a **New**, **On hold**, **Data error**, or **Failed** state.

1. Navigate to **Manage > Queues**.
2. Hover over the **Actions** icon for the queue.
3. Click the **Edit** icon. 
4. Select one of the following options to filter the work items.
  - **Status**
  - **Id**
  - **Name**
  - **Work item result**
5. Change the work item status to **Mark complete**, **Defer**, **Re-process**, or **Failed** in the Work item attributes and automation details section.

You can reprocess the failed Work Items by editing and modifying from **Failed** to **Re-process**. The system will set the status to **Data Error** during the data load if there is any issue with the data. For example, if a user enters a text value for a number field, or an invalid date string for an attribute of date type, the status will be displayed as **Data Error**.

[Work item status and actions](#) on page 2025
6. Click **Save changes**.

[Delete work items](#) on page 2027

## Delete work items

Delete work items one at a time or **in bulk** in the **View work item** page.

Ensure that you are logged in to the as the administrator.

You can delete a work item only if it is in a **Data error**, **On hold**, **Ready to run**, **Complete**, or **Failed** state. For work items in the **Ready to run** state, the work item should not be in a queued state. To delete such work items, **Pause** the automation.

---

**Note:** You can also delete a work item one at a time or **in bulk** using the **Delete** option provided above the Work items table.

---

1. Navigate to **Manage > Queues**.
2. Select the queue.
3. Hover over the **Actions** icon for the queue.
4. Click **Delete**.

Confirm or cancel.

Related reference

[Work item status and actions](#) on page 2025

Based on the Work Item status, you can do only certain actions on a Work Item.

## Export work items to CSV file

Export work items to a CSV file for offline audits and records. The CSV file with the exported work items is available for download in the **Activity > Historical** page.

- You must have the **AAE\_Queue\_Admin** role to export or import work items.
- The source and the target Control Room instances must be running the same version.
- The source and the target Control Room instances must be of the same setup type: SSO with SSO, AD with AD, and non-AD with non-AD.

You can export selected, filtered, or all work items to a CSV file by using the following options:

- **Export checked items**
- **Export filtered items**
- **Export all items**

1. Navigate to **Manage > Queues**.
2. Click the required queue and go to the **Work items**.  
A list of available work items is displayed.
3. Click the **Export items to CSV** icon.

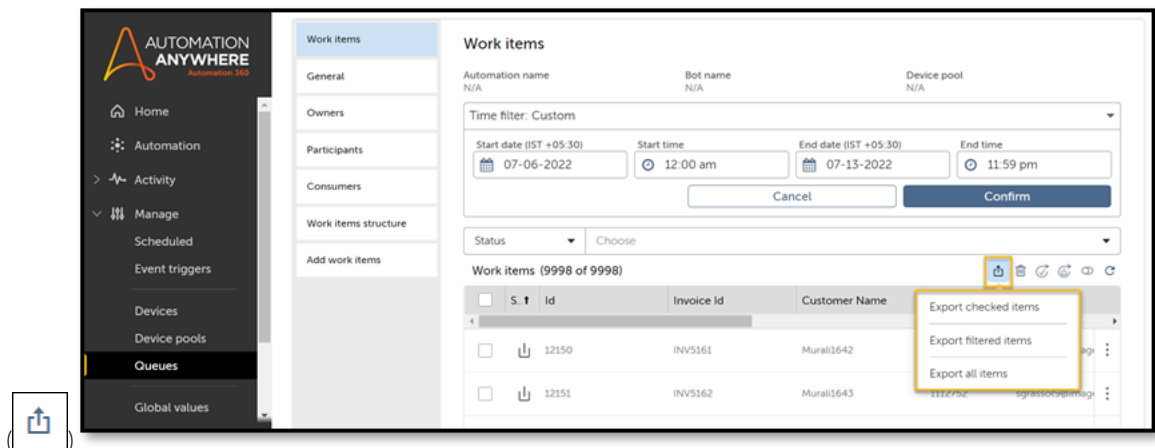

4. Click one of the following required options:
  - **Export checked items:** Exports only the selected work items

**Note:** You must select items to use this option.

- **Export filtered items:** Exports only the filtered work items
- **Export all items:** Exports all the available work items

A message is displayed, informing that the exported CSV file is available in the **Activity > Historical** page.

5. Navigate to the **Activity > Historical** page and search for exported work items activity.

**Note:** You can search for a work item activity by the username. The work item activity name is in the following format: Work items Export:cr-work-items-20220713-104704.csv. You can change the work item activity name by using **File > Save**.

6. Select the work item activity and click **Download exported CSV file**.  
The CSV file is downloaded to your local system as a zip file.

## Workload guidelines

To optimally use your work items and queues in Automation 360, review the guidelines.

### Do's

- Ensure that the queue has at least 2 owners so that there is no deadlock if an owner is deleted or disabled.
- If work items are added frequently to a queue, set the reactivation threshold to 1 so that when a work item is added, the work item is added quickly.
- Up to 10 work item columns can be displayed in the Control Room. Use this feature to get maximum visibility in to your work item data.
- Optimally use work item values that can accept up to 1000 characters, especially for work item result values.
- To prioritize certain work items, ensure that you sort the work item data when you create queues.
- To insert work items in a loop, use the `v3/wlm/workitems` API because this API accepts a list of work items in JSON format.
- Ensure that the time (clocks) in all the machines in a cluster are synchronized. This is important for the Apache Ignite cache server to function properly.
- Persistent and continual database connectivity is critical for the functioning of workload automation. Therefore, ensure that you perform a periodic network scan or use tools that can detect or avoid network issues.
- Apply the pagination filter to retrieve more than 200 work items when you retrieve them using the work item API.

```
"page":  
    {  
      "offset":0,  
      "length":1000  
    }
```

### Don'ts

- To ensure the system works efficiently, do not use the `v3/WLM/workitems` API in a loop to insert work items in bulk.
- If the Bot Runner is part of a device pool, do not create local schedules on that Bot Runner so that the Bot Runner runs only the work items.
- If a user has a queue in use, do not remove the **Run bot** permission from that user (role).
- If a work item is in progress, do not shut down a Bot Runner.

To take a Bot Runner offline for maintenance, ensure that you pause the queue and verify no work item is in progress on the Bot Runner.

- If a work item queue is being processed, do not stop or restart the Automation Anywhere Control Room Service. Instead, pause the queue automation, and then restart the service.

## Understanding automation priority

The priority decides the processing order of the automations. You can set the automation priorities at the various levels:

- Bot: When you schedule a bot (**High, Medium, or Low**). For more information, see [Set automation priority for your bots](#).
- Queue (at device pool level): Define the order in which your automations run in the queues (**Round robin or Priority as shown in table**). For more information, see [Order of the automation queue](#) on page 1886.
- Work Item (at Queue level): Set the priority for **Work Item** column value. For example, **First Name** column ascending order and **Email** column descending order.

To understand how the automation priority works, let's see the following scenario:

Consider you have Q1 with 1st priority at the device pool level and Q2 with 2nd priority. Q1 has work items such as **InvoiceAmount** and **Total** with the following work item level priority:

- Q1 workitem level priority -> **InvoiceAmount** column ascending order
- Q2 workitem level priority -> **Total** column ascending order

When you add multiple workitems to Q1 and Q2 at the same time, Q1 workitem which has the lowest **InvoiceAmount** will run first.

In such scenario, queue priority at device pool level has precedence over the work item priority.

## Bot Lifecycle Management

The Bot Lifecycle Management feature enables you to move a bot from one environment to another. For example, you can move a bot from the development or testing environment to the production environment.

### Overview

Bot Lifecycle Management easily integrates with the DevOps workflow, which supports separate development, testing, acceptance, and production environments and enables you to move bots along with their dashboards from one environment to another.

Bot Lifecycle Management provides a framework for continuous testing and deployment of bots and their dependencies in separate software development life cycle (SDLC) environments, allowing bots to seamlessly transition between lifecycle stages defined by an organization before they are released to production.

You can use the feature to move bots within different environments and help you prevent failure or disruption of data. You have to export a bot from one environment and then import it to another environment or use the promote bot feature to move it between environments. You can also bundle all the dependencies of a bot when transitioning it through the different environments.

The following image shows a typical Bot Lifecycle Management workflow:

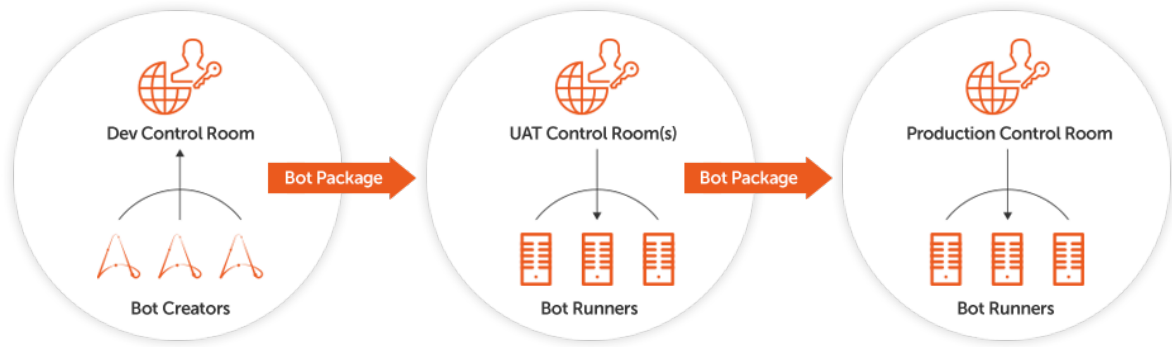

## What is exported across environments

The following entities are included when you perform an export operation from one Control Room to another:

- Bot files
- Dependent files
- Action packages and dependencies
- Bot Insight dashboards

The following entities are not included when you perform an export from one Control Room to another:

- Credentials and credential lockers
- Workload management queues
- Bot Runner accounts and permissions

## Permissions required to move bots across environments

To export bots from the Control Room, you must have the following permissions:

- **Export bot** and **View packages** feature permissions
- **Check in** or **Check out** folder permissions

To import bots to the Control Room, you must have the following permissions:

- **Import bot** and **Manage package** feature permissions
- **Check in** folder permission

To promote bots across environments you must have the following permissions:

- **Export bot** for the user performing the bot promotion in the source Control Room
- All folder level permissions (**Run and schedule**, **Check in**, **Check out**, **View content**, **Clone**, and **Delete from Public**) on the folders containing the bots which you want to promote in the source Control Room.
- The target Control Room user must have **Import bots** permission.

## Importing Enterprise 11 bots when migrating to Automation 360

You can import your Enterprise 11 bots from the Enterprise 11 Control Room instance to Automation 360. This method enables you to consolidate the Enterprise 11 bots from multiple Control Room repositories to a single Automation 360 repository. After importing the bots to Automation 360, use the Bot Migration Wizard to convert the bots to the Automation 360 supported format (.bot).

### Modes to move bots across environments

You can use one of the following two modes to move bots across different Control Room instances. Choose a method that best suits your environment and requirements.

#### Manual mode

- Involves exporting and importing bots using the user interface.

[Export bots](#) on page 2033 | [Import bots](#) on page 2035

- Use the promote bots feature.

[Promote bots](#)

#### Automated mode

Involves exporting and importing bots using Control Room APIs.

[BLM API](#)

### Moving a bot

To move a bot from one environment to another, use one of the following options:

- Export and import bot
  1. Export the bot from the Control Room in the source environment.
  2. Import the bot into the Control Room in the destination environment.
- Promote bot

---

**Note:** You cannot copy a bot to a shared folder to move them between different Control Room environments. You must use either the export and import, or the promote bot feature to move bots across environments.

---



## Guidelines for exporting and importing bots

Review the guidelines before you export or import bots.

### Guidelines for exporting bots

- Export the action packages along with the bot because the packages in the target Control Room to which you are importing the bot might be different.
- Export the bots folder-wise by moving all the bots from one folder first before moving to the next folder. So do not select the bots from the different folders
- Ensure your SMTP (email) server is integrated with the Control Room so that you can receive a link to the exported package through email.

[Email server settings](#) on page 2528

- Ensure that the source and target Control Rooms have the same set of global values.
- Ensure that the source and target Control Rooms have the same set of lockers and credentials that are referred in the bots.

### Guidelines for importing bots

- Recommended: When importing bot from the **Automation** page, use the **Skip the bot or file (don't import it)** option because you might want to check the bot first before overwriting it with the imported bot.
- Recommended:: First import the bots to your private repository (if you are a bot developer), verify the bot, and then check it in to the public workspace.
- The bot directory path is case-sensitive, so ensure that the export and import paths use the same letter case in the Control Room.
- Before importing a bot file of size 200 MB or more, check your load balancer configuration. In few environments, the bot import might fail with an error.

## Export bots

You can export a bot from one Control Room to another.

- Only bots in the public workspace can be exported. If your bots are in the private workspace, check in the bots to the public workspace.
- Ensure that you have the `view` package permissions.
- Ensure that you have the `view content` rights at the folder level from which you want to export the bots.
- Ensure that the Control Room builds and packages in the source and target Control Room instances are the same for export as well as import.

Review the guidelines before you export bots.

[Guidelines for exporting and importing bots](#) on page 2033

1. On the left pane, click **Automation**.  
A list of available and forms is displayed.

2. Click **Manage bots Export** in the public workspace.
3. Select the bot you want to export.
  - Latest version: Click **Latest version** tab to select the latest version of the bot.
  - Labeled version: Click **Production version** tab to select the labeled version of the bot.
4. Click **Next**.

The bot dependencies are displayed in the **Select dependencies** window. If the production label option is selected for the parent bot, the corresponding dependent bots with the production label are also automatically selected. If any of the dependent bots do not have the production label applied, the latest version of the bot is selected.
5. Select the dependencies to export and click **Next**.

All related packages are displayed.
6. Select the necessary packages associated with the bot to export.

Select **Exclude bot packages** to remove all packages from the export.
7. Optional: Create and confirm a password.

Password enhances the security for your bot or file when exporting from one Control Room to another.
8. Click **Export bots and files**.

All the selected bots are exported into a zip file.

Based on the result (failure or success) of the export bot functionality, a notification is also displayed in the Control Room **Notifications** icon. For more information, see [Automation events](#) on page 2209 event notification.

---

**Note:** If you have analytics bots in your Control Room, all the Bot Insight dashboards (default, custom, and published) associated with the bots are also exported into the zip file.

---

If you have configured SMTP, an email is sent that contains a link to the zip file of the exported package.

If you have not configured SMTP, perform the following steps to access the link to the zip file of the exported package:

- a) Navigate to **Activity > Historical**.
- b) Search and view the historical activity of the exported package.
- c) Click **Download exported zip file**.

A link to download the zip file is displayed.

9. Use the link to download the zip file and save it to a location for importing it to another Control Room.

---

**Note:**

- If you are exporting a large size bot or dependency, there might be a delay in the download of the export zip file from the **Activity > Historical** page.
  - All the exported zip files older than 30 days will be automatically deleted.
- 

Import the bots into an Control Room.

#### Related tasks

[Import bots](#) on page 2035

You can import bots with their dependencies from one Control Room to another. The source environment can be Automation 360 Control Room, Enterprise 11 , or Enterprise 10 Control Room instance.

#### Related reference

[System roles](#) on page 1768

System roles are preconfigured with the permissions necessary to perform the tasks within the scope of that role. They cannot be modified or deleted. Administrators assign the roles to users to enable them to access features and perform operations in the Control Room.

## Import bots

You can import bots with their dependencies from one Control Room to another. The source environment can be Automation 360 Control Room, Enterprise 11 , or Enterprise 10 Control Room instance.

- Ensure that the following rights are enabled to import bots:
  - Import bots permission
  - Create folder permission, if it is required
  - Check-in to public workspace permission if you are importing to the public workspace
- Ensure that the version of Control Room and packages in the source and target Control Room are same for export as well as import.
- You must have a Bot Creator license to import bots either into the private workspace or public workspace.

You can import bots into the public workspace if you have the required permissions, regardless of your license.

- To import the Enterprise 11 bots into your Automation 360 Control Room, consider the following additional requirements:
  - You must have the required `aapkg` package that you created using the Bot Lifecycle Management export feature in the Enterprise 11 Control Room instance.
  - The `aapkg` package must be present in the same Automation 360 machine where you want to import the Enterprise 11 bots.
  - You can import the password protected `aapkg` packages using the Bot Lifecycle Management Import API only. See Import repository bots in [BLM API](#)

- Review the guidelines before you import bots.

[Guidelines for exporting and importing bots](#) on page 2033

- When importing bots, ensure that the target Control Room version is same or later than the source Control Room version. If you import bots from a later version of the Control Room to an earlier version, the bot might be corrupted.
- To import bots from one Control Room to another, use the exported `zip` file (or `aapkg` file, in case of Enterprise 11 or Enterprise 10 bots). If the SMTP is configured, you will receive a link to download the `zip` or `aapkg` file on your configured email address. If SMTP is not configured, you can access the download link by navigating to **Activity > Historical** page.

**Note:** You can import the Enterprise 11 bots (.aapkg file) with or without the dependent MetaBots only into the public workspace. If you are importing the file into the private workspace, ensure that the dependent MetaBots dependencies are included.

1. On the left pane, click **Automation**.  
A list of available and forms is displayed.
2. Click **Manage bots > Import**.
3. Browse and select the required zip file or aapkg file based on your source environment:

Source environment	Action
Automation 360 bots	Select the required zip file.
Enterprise 11 or Enterprise 10 bots	Select the required aapkg file.

4. Select the private workspace or public workspace based on your following source environment:

Source environment	Action
Automation 360 bots	<p>You can select either the private or public workspace as required.</p> <p>If you have analytics bots in your source Automation 360 environment, then all the associated Bot Insight dashboards are also imported based on the following selection:</p> <ul style="list-style-type: none"> <li>• If you select the private workspace, you can view only default and custom dashboards. To view published dashboards, you must check in the bots to the public workspace.</li> <li>• If you select the public workspace, you can view only published dashboards. To view default and custom dashboards, you must check out the bots to the private workspace.</li> </ul>
Enterprise 11 or Enterprise 10 bots	<p>Select the public workspace.</p> <p>This selection enables you to migrate Enterprise 11 or Enterprise 10 bots to the Automation 360 environment later during migration.</p>

5. Optional: Enter the password in the **Password** field.  
If your exported bot or file is password protected, you will be prompted to enter a password. Obtain the password from the user who has exported this bot or file.
6. If some of the files that are being imported from the package are already available in your Control Room, choose one of the following options:
  - **Skip the bot or file (don't import it)**

- **Overwrite the bot or file with the imported one**

7. Click the **Import bots** option.

Based on the success or failure of the import bot, a notification also displays in the Control

Room **Notifications** with the (  ) icon. For more information, see [Automation events](#) on page 2209 event notification.

8. After the import is complete, based on your source environment, navigate to the corresponding repository to find and use the imported bot:

Source environment	Action
Automation 360 bots	Navigate to the corresponding workspace (private or public, based on your selection in Step 4).
Enterprise 11 or Enterprise 10 bots	<p>Navigate to the public workspace in the <b>Bots &gt; My Tasks</b> folder or <b>Bots &gt; My Metabots</b> folder.</p> <hr/> <p><b>Note:</b> Enterprise 11 and Enterprise 10 bots are imported in <code>.atmx</code> and <code>.mbot</code> format. Use the migration wizard to convert the Enterprise 11 and Enterprise 10 bots files to the <code>.bot</code> format, which is supported in Automation 360.</p> <p><a href="#">Migrate Enterprise bots</a> on page 1590</p> <hr/>

Related tasks

[Export bots](#) on page 2033

You can export a bot from one Control Room to another.

Related reference

[System roles](#) on page 1768

System roles are preconfigured with the permissions necessary to perform the tasks within the scope of that role. They cannot be modified or deleted. Administrators assign the roles to users to enable them to access features and perform operations in the Control Room.

## Move bots across environments

You can move bots and files, their dependencies, and packages between Control Room instances in a single flow. The promote bot feature simplifies the process by avoiding the multi-step export and import process when moving bots across different Control Room environments (Dev to UAT).

- You must have the administrator license, or have a Bot Creator or Citizen Developer license with the following permissions:
  - **Export bots** for the user performing the bot promotion in the source Control Room.
  - All folder level permissions (**Run and schedule**, **Check in**, **Check out**, **View content**, **Clone**, and **Delete from Public**) on the folders containing the bots which you want to promote in the source Control Room.

- The target Control Room user must have **Import bots** permission.
- The target Control Room must have a valid URL.
- The source Control Room APIs must be able to access the target Control Room.
- For Automation 360 Cloud deployments, ensure that the IP addresses of the target Control Room instances are added to the allowed list.

See [Control Room IP addresses for external integrations](#).

- Add the list of approved target URLs.
  - a) Log in to the Control Room as an administrator.
  - b) Navigate to **Administration > Settings > Security settings > Bot promotion settings** and click **Next**.
  - c) Click **Edit**.
  - d) Enter the Control Room URL in the **Verified target Control Room URLs** field and click the **plus** icon.

---

**Note:** Only `https` URLs are accepted. You can add up to 25 target Control Room instances.

---

The validated target Control Room URLs will be displayed in the **validated URLs** field.

- e) Click **Save changes**.

---

**Note:** You can remove any URL by selecting the delete option in the vertical ellipsis next to the URL.

---

See the following video to understand how to add the list of approved target URLs.

- Move bots across Control Room instances.
  - a) Log in to the Control Room either as an administrator or a Bot Creator with the permissions previously described.
  - b) Navigate to the **Automation > Public** tab.
  - c) Click **Manage bots > Promote**.
  - d) In the **Promote bots and files** page, select the bots, files, processes, or forms you want to move and then click **Next**.
  - e) Select dependencies (if any) and click **Next**.
  - f) Select packages and click **Next**.

---

**Note:** To exclude packages, select the **Exclude bot packages** check box.

---

- g) Provide a meaningful name for the promotion.
- h) If some of the files that are being moved are already available in the target Control Room, select one of the following:
  - **Skip the bot or file (don't import it)**
  - **Overwrite the existing bot or file**
- i) Click **Next**.
- j) Select the target Control Room URL from the drop-down.

- k) Enter the **Username** and **API key** for the target Control Room to authenticate.

---

**Note:**

- To prevent authentication errors, ensure that you provide the correct username and API key.
- If the API key you generate is of longer duration, you can re-use the same and need not generate the API key every time you promote a bot. If the API key expires, you must generate it again during bot promotion. Duration of the API key is configured by the admin.

For details about generating an API key, see [Create API key generation role](#) on page 1765.

---

- l) Click **Promote bots and files**.

- The promoted bots and files appear in the target Control Room. If the Control Room is enabled for email notifications, you will receive an email regarding the bot promotion status.
- When bots are promoted, they are checked in to the target Control Room. If you choose the overwrite option, their version increments in the targetControl Room.

---

**Note:**

- Bots and files are promoted from and to the public workspace only.
  - You can promote up to 1000 bots.
  - You can promote bots from one Control Room to another if the source and target Control Room instances belong to the same domain. For example, you cannot promote a bot from AWS to GCP domain, both the source and target Control Room instances must belong to either AWS or GCP domain.
- 

See the following video to understand how to move bots across Control Room instances.

## Recover bots and files

You can recover the bots and files created in the private repository of a deleted user (Bot Creator or Citizen Developer) and transfer them to an existing user's repository. When users leave the organization, the automations they created are not lost and can be used by other users.

- You must be logged in to the Control Room as an administrator or a user with **Recover bots** permission.
- The target user must have the following permissions for the folders that are being transferred:
  - Clone
  - Check in
  - Check out
- The target user must have the same folder level permissions as the deleted user.
- The target user must be logged in and out of the Control Room at least once before the recovery process activity.

- The target user must have an empty private repository.

The recovery process is a one-time activity. Once you have transferred the bots and files from a deleted user, you cannot recover the private repository of the same user again.

You cannot restore a deleted bot either from public or private workspace, so ensure that you no longer require a bot before deleting it.

1. Log in to the Control Room as an administrator.
2. Click **Manage bots > Recover**.
3. In the **Recover bots and files** page, select the deleted user whose private repository you want to recover and click **Next**.
4. Select the target user and click **Next**.
5. Provide a meaningful name for the recovery.
6. Click **Recover bots and files**.
  - The private repository of the deleted user is replicated in the private repository of the target user using the same folder hierarchy.
  - These automation details are retained: name, status (**New**, **Cloned**, **Checked out**, and **Checked out and edited**), source versions, code analysis results, size last modified, and modified by.
  - The audit log will contain details of the deleted user, new user, and the list of bots and files that are transferred.



# Monitor Automation 360

## Automation Command Center

In the constantly developing automation landscape, the role of data-driven decision-making is essential. Dashboards providing actionable insights are crucial for organizations to monitor, evaluate, and optimize automated processes.

The Automation Command Center (ACC) home page provides comprehensive visibility, actionable insight, and oversight capability into all aspects of automation domain.

### Benefits and capabilities

The ACC home page provides the following benefits and capabilities:

- Effective monitoring of the automation landscape, leading to:
  - Improved reliability
  - Improved utilization
- Ensures compliance by highlighting results of code analysis
- Helps CoEs scale efficiently and achieve automation success
- Helps with informed decision making for process optimization
- Identifies bottlenecks and areas of improvement
- Easier navigation to other areas such as Automation Co-Pilot, CoE Manager, and Bot Insight

### Components

ACC homepage consists of the following components:

- Visualization: Provides graphical visualization of data in the form of line charts, bar graphs, and pie charts.
- Widgets: Displays real-time information about automation status, utilization data, and compliance data.
- Filters: Provides ability to view data for specific time frame.
- Navigation: Provides easy navigation to various other components or domains.
- Resources: Provides easy access to development resources such as Automation Anywhere University and Pathfinder Community.

### ACC - user roles

Automation Administrator

An automation administrator with **View operations data**, **View and manage ALL devices (s)**, and **View licenses** permission and

**AAE\_Queue\_Admin** role, can view operations-related widgets on the ACC home page. These widgets provide information on the automation statuses, license and device utilization. This enables the administrator to focus on the progress of the automation, drive optimal utilization of resources, and make efficient decisions.

[ACC home page for administrators](#) on page 2042

Professional developer or Citizen Developer

A Professional developer or a Citizen Developer has a personalized view of their recent work across repositories. In addition, help is just a click away with direct links to Pathfinder Community and Automation Anywhere University which also help improve developer productivity.

[ACC home page for Pro and Citizen Developers](#) on page 2044

## ACC home page for administrators

As an automation administrator you can view operations-related widgets on the Automation Command Center (ACC) home page. These widgets provide information on the automation statuses, license and device utilization. This enables you to focus on the progress of the automation, drive optimal utilization of resources, and make efficient decisions.

### Permissions

You must have the following permissions to access the operation-related widgets on the ACC home page.

- **View operations data**
- **View and manage ALL devices (s)**
- **View licenses**
- **AAE\_Queue\_Admin**

The ACC homepage provides you a holistic view of the automation landscape. The information is distributed within various specific sections.

- You can see the consolidated dashboard details which displays all the information at a single glance.
- The development details provides a quick glance at the automations run or scheduled by you. You can also view the automations which you have labeled or canceled the check-out operation.
- The operational insights provides you comprehensive and statistical information about automation metrics and the device and license statuses. By default, you can view these data for

the last 24 hours. The maximum time duration for which you can view automation details is for the last 90 days. For more details, see [Time filter](#) on page 2123.

#### Automation data

The various widgets provide you data that includes automation schedule and status, automation run time, most failed and most run automations, as well as the currently running automation details. You can use this information to:

- Analyze recent executions.
- Take corrective action for failed automations.
- Plan capacity for the upcoming scheduled automations.
- Work efficiently, improve reliability, and scale your automation program.
- Understand the impact of automations, ensure all operations are running as required.
- Monitor devices that are in use.

#### Device data

The widgets provide information about resource utilization of devices on which automations are executed. The information includes device status, device details, average utilization of each device, and insights on KPIs related to queues and work items such as queue status and the number of work items processed in a queue. You can use this information to:

- Plan the optimum usage of devices in the Control Room. For example, if the average utilization achieved over the last 24 hours on a set number of devices is very low, you can identify the total number of devices that are idle and deploy automations on those devices, thus improving their utilization.
- Plan your automation deployments thus improving the efficiency. For example, if the number of active queues at a given point differs from the data 24 hours ago, you can check for any issue and proactively take action. Similarly, with the help of this data, you can restart paused queues and delete inactive queues if they are not required.
- Understand the capacity available for additional automation scheduling, scaling automation program, and for planning the infrastructure budget.

- Distribute the load for better performance, thus reducing the wait time for devices.

#### License data

Provides license allocation information for all users and all Control Room instances. It also provides details on purchased license counts and available licenses.

This helps you realize the available capacity, drive optimal utilization of the licenses, and deliver value.

For more information, you can navigate to the licenses page. See [Manage licenses](#) on page 1782.

- You can view the compliance details in the form of a graphical insight. This helps you analyze the code quality of automations such as the total number of automations with high or low severity violations. It also shows the number of automations for which code analysis has not been performed.

You can use this information to improve code readability and quality and control the structure of your automation code. This helps you improve the productivity of the developer and also enable complex automations to be more accessible.

You can further navigate to manage policies page for more information. See [Manage policies | Configure and assign code analysis policy](#) on page 2191.

- You can use the links to quickly and easily navigate to other components or domains such as the pathfinder program, Automation Anywhere University, and pathfinder community. You can also use these links to navigate to other areas such as Automation Co-Pilot, CoE Manager, Bot Insight, and so on.

## ACC home page for Pro and Citizen Developers

As an automation developer (Pro or Citizen Developer), you can have a centralized view of your automations on the Automation Command Center (ACC) home page. This quick access to the automations and other dev resources in the form of direct links to pathfinder community and Automation Anywhere University helps in improving the productivity.

The ACC homepage provides a comprehensive view of the automation landscape. The information is distributed within various specific sections.

- You can see the consolidated dashboard details which displays all the information at a single glance.
- The development details provides a quick glance at the automations you have been working on for the last 7 days. Clicking any of these automations opens them in the bot editor for further action.
- If code analysis is enabled, you can view the compliance details in a graphical format that provides insight on the code quality of automations created by you such as the total number of automations with high or low severity violations.
- You can navigate to other components or domains of Automation Anywhere such as the Automation Pathfinder Program, Automation Anywhere University, and pathfinder community. You can also use the quick links to navigate to other areas which you have access to such as Automation Co-Pilot, CoE Manager, and Bot Insight.

You can use this information to:

- Improve productivity. Easy and quick access to the automations you have been working on has a great impact on your productivity as it reduces navigation time, enhances focus, and streamlines your workflow.
- Maintain a higher standard of code quality by reducing the defects. Helps identify the issues earlier on and provide resolution. Helps maintain a standard code structure which makes the code easier to read and understand, especially when working in collaboration.
- Reduce the need to reinvent the wheel by providing efficient access to valuable information, knowledge, best practices, and solutions in the Pathfinder Community. Help is just a click away enabling faster resolutions to problems. Engaging with the developer community also helps inspire innovative ideas.

The following video shows the personalized ACC home page for a Pro and Citizen Developer user.

## Export Automation data

Use the **Export** option on the **Automations** dashboard to export automation data in a CSV file.

**Important:** This feature requires the Enterprise Plus license. Contact your Automation Anywhere account representative for more information about this license.

Control Room administrator or the user role with **View operations data** (Export operations details and View operations details) permissions can export the automation data.

You can export automation data to gather business analytic and gain insight from these automation statuses. You can export a maximum of 10,000 records in a CSV file. The data provides the following details: each individual bot, each individual run, start and end time, and reasoning information on bots that had failed. Using the data enables you to analyze the performance of your automations and take corrective measures to improve it

1. Navigate to **Home page > My dashboard**.
2. Select **Automation status** and click **Automation details**. The **Automations** page appears.
3. Click the **Export** button to download the data in a CSV file for the selected time range.

A1	A	B	C	D	E	F	G	H
	Automation Name	Repo Path	Device Name	Start Time	End Time	Duration (milliseconds)	Status	Failure Reason
1	TCBot1minMigBot	Automation Anywhere\Bots\TCBot1j.m-cr2		2023-09-19T02:30:08Z	2023-09-19T02:31:08Z		60000 RUN_TIMED_OUT	Runtime time out This may be
2	TCBot1minMigBot	Automation Anywhere\Bots\TCBot1j.m-cr2		2023-09-19T01:30:08Z	2023-09-19T01:31:08Z		60000 RUN_TIMED_OUT	Runtime time out This may be
3	TCBot1minMigBot	Automation Anywhere\Bots\TCBot1j.m-cr2		2023-09-19T03:30:08Z	2023-09-19T03:31:08Z		60000 RUN_TIMED_OUT	Runtime time out This may be
4	TCBot1minMigBot	Automation Anywhere\Bots\TCBot1j.m-cr2		2023-09-19T03:30:08Z	2023-09-19T03:31:08Z		60000 RUN_TIMED_OUT	Runtime time out This may be
5	TCBot1minMigBot	Automation Anywhere\Bots\TCBot1j.m-cr2		2023-09-18T23:30:10Z	2023-09-18T23:31:10Z		60000 RUN_TIMED_OUT	Runtime time out This may be
6	TCBot1minMigBot	Automation Anywhere\Bots\TCBot1j.m-cr2		2023-09-18T22:30:08Z	2023-09-18T22:31:08Z		60000 RUN_TIMED_OUT	Runtime time out This may be
7	TCBot1minMigBot	Automation Anywhere\Bots\TCBot1j.m-cr2		2023-09-18T21:30:08Z	2023-09-18T21:31:08Z		60000 RUN_TIMED_OUT	Runtime time out This may be
8	10 Minute MigBot	Automation Anywhere\Bots\10 Minu.jm-cr2		2023-09-18T06:32:15Z	2023-09-18T06:42:16Z		602000 COMPLETED	
9	TCBot1minMigBot	Automation Anywhere\Bots\TCBot1j.m-cr2		2023-09-18T06:30:08Z	2023-09-18T06:31:08Z		60000 RUN_TIMED_OUT	Runtime time out This may be
10	10 Minute MigBot	Automation Anywhere\Bots\10 Minu.jm-cr2		2023-09-18T05:32:14Z	2023-09-18T05:42:16Z		602000 COMPLETED	
11	TCBot1minMigBot	Automation Anywhere\Bots\TCBot1j.m-cr2		2023-09-18T05:30:08Z	2023-09-18T05:31:08Z		60000 RUN_TIMED_OUT	Runtime time out This may be
12	10 Minute MigBot	Automation Anywhere\Bots\10 Minu.jm-cr2		2023-09-18T04:32:15Z	2023-09-18T04:42:16Z		602000 COMPLETED	
13	TCBot1minMigBot	Automation Anywhere\Bots\TCBot1j.m-cr2		2023-09-18T04:30:08Z	2023-09-18T04:31:08Z		60000 RUN_TIMED_OUT	Runtime time out This may be
14	TCBot1minMigBot	Automation Anywhere\Bots\TCBot1j.m-cr2		2023-09-18T03:30:08Z	2023-09-18T03:31:08Z		50000 RUN_TIMED_OUT	Runtime time out This may be
15	TCBot1minMigBot	Automation Anywhere\Bots\TCBot1j.m-cr2		2023-09-18T02:30:08Z	2023-09-18T02:31:08Z		60000 RUN_TIMED_OUT	Runtime time out This may be
16	TCBot1minMigBot	Automation Anywhere\Bots\TCBot1j.m-cr2		2023-09-18T01:30:08Z	2023-09-18T01:31:08Z		60000 RUN_TIMED_OUT	Runtime time out This may be
17	TCBot1minMigBot	Automation Anywhere\Bots\TCBot1j.m-cr2		2023-09-18T00:30:08Z	2023-09-18T00:31:08Z		60000 RUN_TIMED_OUT	Runtime time out This may be
18	TCBot1minMigBot	Automation Anywhere\Bots\TCBot1j.m-cr2		2023-09-17T23:30:08Z	2023-09-17T23:31:08Z		60000 RUN_TIMED_OUT	Runtime time out This may be
19	TCBot1minMigBot	Automation Anywhere\Bots\TCBot1j.m-cr2		2023-09-17T22:30:08Z	2023-09-17T22:31:08Z		60000 RUN_TIMED_OUT	Runtime time out This may be
20	TCBot1minMigBot	Automation Anywhere\Bots\TCBot1j.m-cr2		2023-09-17T21:30:08Z	2023-09-17T21:31:08Z		60000 RUN_TIMED_OUT	Runtime time out This may be
21	TCBot1minMigBot	Automation Anywhere\Bots\TCBot1j.m-cr2		2023-09-17T06:41:18Z	2023-09-17T06:42:18Z		60000 RUN_TIMED_OUT	Runtime time out This may be
22	10 Minute MigBot	Automation Anywhere\Bots\10 Minu.jm-cr2		2023-09-17T06:30:09Z	2023-09-17T06:40:11Z		602000 COMPLETED	

## Automation program lifecycle with CoE Manager

CoE Manager and CoE Manager Plus provide capabilities that enable you to govern, track, and measure automation program performance.

Scaling automation programs requires expert-led guidance and planning, governance, and the ability to demonstrate and measure the value delivered. CoE Manager offerings help you maximize the value of your automation program with a tool that enables you to manage the end-to-end program lifecycle, centralize governance, increase collaboration, and provide a platform where growth can be measured.

### CoE Manager

CoE Manager provides an out-of-the-box solution to manage the automation program lifecycle. You can measure program success, chart your automation path, and engage your workforce in building an automation pipeline with a purpose-built, plug-and-play suite to fuel center of excellence performance.

[CoE Manager](#) on page 2047

### CoE Manager Plus

CoE Manager Plus provides all the capabilities of CoE Manager and in addition also offers advanced capabilities, customizations, and integrations to truly optimize automation program performance across any team, regardless of which automation platform you use. CoE Manager Plus can be tailored to track ROI and capture key insights from multiple automation program vendors, enabling a holistic view of your ROI across a more complex automation landscape.

[CoE Manager Plus](#) on page 2049

### Comparing the CoE offerings

Capabilities	CoE Manager	CoE Manager Plus
Pipeline management and ROI	Yes	Yes
Seamless integration with Automation 360 Control Room instances	Yes	Yes
Template customizations	No	Yes
Advanced configuration capabilities for new modules and integrations	No	Yes
Integrations with Microsoft Power Automate	No	Yes
Count of supported orchestrators	3	Unlimited

## CoE Manager

Automation Anywhere CoE Manager helps you achieve visibility into your end-to-end automation lifecycle while accelerating the pipeline generation. It helps scale the automation programs more quickly and efficiently, while maximizing the value realization from the investment in your automation program.

CoE Manager is available out of the box and requires minimal configurations for first-time use. In addition to program management capabilities, it provides a consistent and repeatable way of assessing automation opportunities in order to minimize variations and maximize return on investment (ROI). ROI can be measured in terms of time and cost saved as well as user-defined KPIs such as operational agility, cash flow, sustainability, and so on.

CoE Manager is powered by Shibumi platform, a leading provider of enterprise program management solutions.

### Benefits

CoE Manager helps you in the following ways:

- Scale automation programs more quickly and efficiently.
- Forecast business results, identify metrics for success, and track them through the entire automation lifecycle.
- Create single view of portfolio status, risks, and interdependencies.
- Informed decision making with timely and accurate data.
- Assess all automation ideas across expected savings, strategy alignment and automation complexity to enable prioritization.
- Reduce manual effort on multi-level tracking, computing, and reporting.
- Maximize the value (ROI) from your automation investment.
- Boost the value of the pipeline of automation opportunities to build the business case for additional investment.

### Capabilities

CoE Manager is a cloud-based platform which helps manage the automation pipeline and delivery.



Key capabilities of CoE Manager are:

- Accelerate the automation lifecycle journey with a purpose-built automation CoE management solution where everyone can share automation ideas.
- Enable the leadership team to make focused decisions by providing dashboards that help maximize the ROI from the automation program.
- Enable tracking and managing the pipeline by tracking automation program data, set targets, and tracking the progress. It helps manage the pipeline from idea to delivery to value realization.
- Track automation ROI via native integration with Automation Anywhere.
- Seamless reporting via dashboards and automated report creation.
- Efficient governance with role-based access control with in-built approval workflows and user notifications.

## Components

The CoE Manager includes the following components:

- **Dashboard:** Provides graphical insight to help you view the adoption and progress of the automation program. It displays information on idea velocity, opportunities by stage, forecasted savings versus program target, value by stage, as well as benefits at various stages.
- **Opportunities:** Displays all opportunities across idea, pipeline, in-progress, and deployed stages.
- **Ideas:** Displays new opportunities submitted into CoE Manager.
- **Pipeline:** Displays approved opportunities.
- **In Progress:** Displays opportunities currently in design/build stage.



- Deployed: Displays opportunities that are live.
- Risks: Track program risks and their resolutions.
- Reporting: View and export the status of entire automation program or drill-down into each business unit.
- Admin: Configure program details and targets, questionnaire and weightages, cost estimates, benefit types, and so on.

## CoE Manager Plus

CoE Manager Plus supports all capabilities of CoE Manager and in addition provides advanced capabilities, customizations, and integrations to optimize your automation program performance. You can track transaction-level ROI metrics and capture key insights regardless of the platform you use.

CoE Manager Plus provides you a holistic view of your ROI across a more complex automation landscape.

To have a consistent and reiterative idea for the implementation cycle, you require a scalable platform that provides association with multiple stakeholders and real-time visibility into your automation program. End-to-end automation requires interaction between people and processes to enable seamless execution flow. Opportunities can be sourced from a process intelligence tool or manually submitted by business users and COE team members. CoE Manager Plus supports all these scenarios.

CoE Manager Plus enables the opportunity lifecycle (**Idea > Prioritize > Build > Deploy**) and allows both COE team members and business users to collaborate to arrive at value realization. This results in a good quality opportunity pipeline and gives a real-time visibility into automation program status by tracking the automation success.

Once the opportunity is created and is in the Idea stage, navigate to the details tab to select the automation vendor (Automation Anywhere or Microsoft Power Automate).

## Capabilities

Key capabilities of CoE Manager Plus are:

- Make value-focused decisions with a holistic view of ROI across the automation landscape with integrations to other automation vendors like Microsoft Power Automate.
- Connect to unlimited Control Room instances and track ROI from all of them.
- Make informed decisions with the information received from customized dashboards. For example, you can track which business unit is generating more value; Finance, Marketing, Sales, and so on and make decision based on that.
- Provision of two environments, production and development enables you to test before publishing to the live environment.

## Getting started with CoE Manager

CoE Manager provides clear visibility into the backlog of automation ideas, their position in the lifecycle, and how much value they will deliver back to the business. The following is a high-level overview of how to get started with CoE Manager:

Add the following email domains to your email client's safe-senders list to ensure users receive the notifications generated by CoE Manager.

- US - notifications come from @mail.app.shibumi.com
- Europe - notifications come from @mail.eu.shibumi.com
- Asia-Pacific - notifications come from @mail.ap.shibumi.com

As an administrator, you can perform the following tasks in CoE Manager.

### Register and access CoE Manager

You must be invited to use CoE Manager. When you respond to your first invitation, you will set up a login account. You will use this account for all future use.

---

**Recommendation:** Automation Anywhere team uses the account, `aacoemanager@automationanywhere.com` to help update your CoE Manager instance and also for troubleshooting. It is recommended that you do not remove the access for this account.

---

[Create and manage your account](#) on page 2051

### Setting up CoE Manager for first-time use

- Configure CoE Manager: CoE Manager provides program-level administration tabs to tailor the solution for your use.  
[Configure CoE Manager](#)
- Enable CoE Manager: You can enable access to the CoE Manager from the Control Room so that you can access the CoE Manager from the quick links section on the Control Room home page.  
[Enable CoE Manager](#) on page 2076
- Integrate CoE Manager with Control Room: You can integrate the CoE Manager with the Control Room to monitor your automations and calculate the savings achieved. You can link up to three Control Room instances with one instance of CoE Manager.  
[Integrate CoE Manager with Control Room](#)
- Add users: Add participants to specific roles within your CoE Manager.  
[Participant window](#) on page 2078
- Export and import: You can bulk import previously created opportunities into a program in the CoE Manager.  
[Export and import opportunities in CoE Manager](#) on page 2065

## Link a Task Bot to an opportunity

You can review digital worker information from the **Deployed** tab and add automations directly on an opportunity. To register a digital worker with an opportunity, you can either use the **Opportunities** tab to search for the opportunity you would like to update or use the search option (magnifying glass icon) on the Navigation Sidebar.

[CoE Manager - Link automation to opportunity](#) on page 2092

## Create and manage opportunity

All users can create and manager opportunity in the CoE Manager. You can submit an opportunity, build a business case for it, and track its progress through the approval stage gates.

[Create and manage opportunity](#) on page 2083

## Create and manage your account

To get started with Shibumi, you will be sent an invite to join Shibumi when an admin adds you to an item in the system. Accept the invite, set up your profile, create a password, and you will be set to start achieving goals in Shibumi.

You can further customize your experience by adding favorites and tailoring your homepage to pull up items and dashboards that matter the most to you.

## Set up account

After the Shibumi administrator has set up an app to support your client engagement, you will receive an email inviting you to collaborate. Click **Start Collaborating**. Shibumi helps organizations manage strategic business initiatives, measure performance, and ensure success.

If this is your first invitation, you will be prompted to set up an account. When you set up an account you must create a password. Once you log into Shibumi, the Shibumi workspace will be displayed. Your ability to view and collaborate on work items is determined by your participation access for the work items.



The image shows a registration form for Shibumi. At the top, the word "shibumi" is written in a blue, lowercase, sans-serif font. Below the logo are four input fields: "First Name \*", "Last Name \*", "Create Password \*", and "Confirm Password \*". The password fields have a small icon of a crossed-out eye to the right, indicating a password strength indicator or toggle. Below the "Confirm Password \*" field, there is a text requirement: "Password must be at least 10 characters, include at least 1 uppercase letter, 1 lowercase letter, 1 digit, and 1 symbol." At the bottom of the form is a blue button with the text "Create Account" in white.

---

**Note:**

- The registration link in your invitation email is only valid for 14 days.
- Passwords must be 10-20 characters and include at least 1 uppercase character, 1 lower case character, 1 special character, and 1 number.

---

### Log in to Shibumi

From the login page, enter your email address and password. If you forget your password, click **Forgot Password?** and Shibumi will send a link to your email with instructions on how to reset your password.

The image displays two sequential screenshots of the Shibumi login process. Both screens feature the 'shibumi' logo at the top. The left screen shows an 'Email Address \*' input field and a blue 'Next' button. The right screen shows a 'Password \*' input field with a toggle icon, a blue 'Sign in' button, and a 'Forgot Password?' link. Both screens have 'Help | Privacy | About' links at the bottom.

## Log in with SSO

If your enterprise requires SSO login, you will be directed straight to your SSO Identity Provider after entering your email and clicking **Next**. If SSO login is optional in your enterprise, after clicking **Next**, you can click **Login with SSO** to access your SSO login flow.

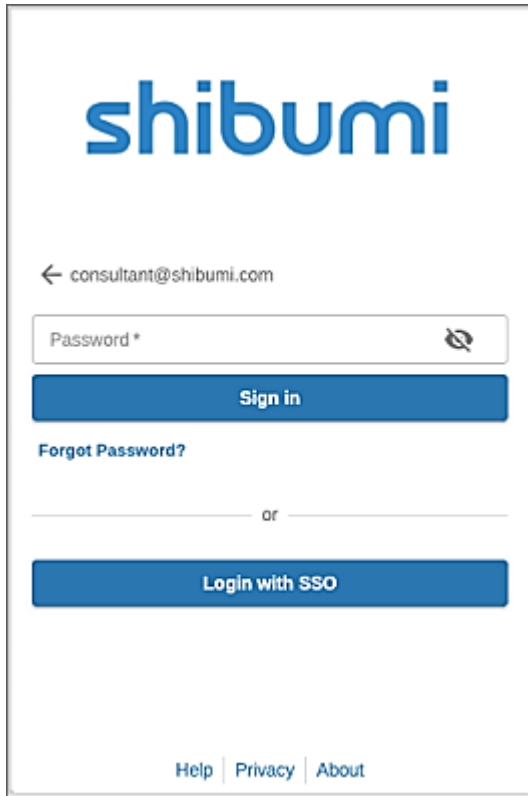

The image shows a login form for Shibumi. At the top is the Shibumi logo in blue. Below it is a back arrow and the email address 'consultant@shibumi.com'. There is a password input field with a 'Password \*' label and a toggle icon. Below the password field is a blue 'Sign in' button. Underneath is a link for 'Forgot Password?'. A horizontal line with 'or' in the center separates this from a blue 'Login with SSO' button. At the bottom are links for 'Help', 'Privacy', and 'About'.

## Log in with Multi-Factor Authentication

If you have previously configured Multi-Factor Authentication (MFA), you will see an MFA token field below the password field. Open a supported authenticator app on a mobile device and enter the 6-digit token for your Shibumi account.

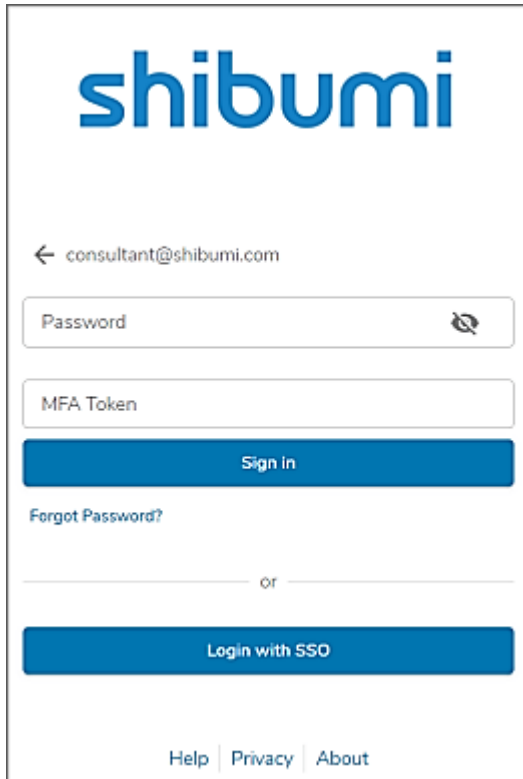

The image shows the Shibumi login interface. At the top is the 'shibumi' logo in blue. Below it is a back arrow and the email address 'consultant@shibumi.com'. There are two input fields: 'Password' with a toggle icon and 'MFA Token'. A blue 'Sign In' button is below the fields. A link for 'Forgot Password?' is under the button. A horizontal line with 'or' in the center separates the sign-in section from the SSO section. Below the line is a blue 'Login with SSO' button. At the bottom are links for 'Help', 'Privacy', and 'About'.

## Change your password

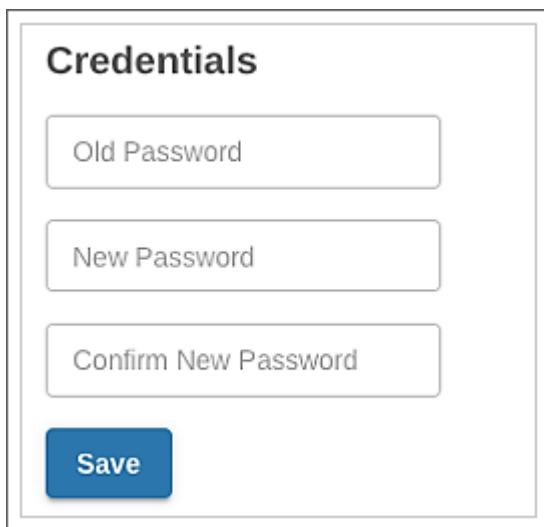

The image shows a 'Change your password' form. It has a title 'Credentials' in bold. Below the title are three input fields: 'Old Password', 'New Password', and 'Confirm New Password'. At the bottom of the form is a blue 'Save' button.

To change your password:

1. Click the **User** icon from the navigation sidebar.
2. Click **Edit My Account**.
3. Navigate to the password section.
4. Enter your old password.

5. Enter your new password.
6. Enter your new password again.
7. Select the **Save** button to change your password.

## Enterprise administration

As an administrator, you can configure and manage the administrative tasks such as managing your enterprise branding, managing allowed list of email domains, users, and default homepages using the enterprise administration tab.

You must have the Admin role to access the **Enterprise Administration** tab on the navigation sidebar. You can access the various tabs in this section to manage your enterprise settings.

### General

The general tab displays general information such as the name of your enterprise and the fiscal year end date for your enterprise. This gives the breakpoint for yearly metric calculations. Both the name and the end date cannot be edited after creating the enterprise.

### Branding

You can customize the logo, theme, and colors as per your requirements. You can upload your enterprise logo by selecting the **Upload New** button. This logo will be displayed when the navigation sidebar is expanded. The theme section allows you to configure the color of multiple elements within your solution and the data in your charts. You can customize the color to match your enterprise branding colors.

- Branding: Defines the color of the navigation sidebar.
- Primary: Defines the color of clickable UI elements such as tabs, buttons, links, and so on.
- Secondary: Defines the color of the page level filter bar.
- Info: Defines the color of the alerts and other information prompts.
- Success, Warning, and Error: Defines the color of the messages displayed for success, warning, or error.
- Chart colors: Defines the colors used as the data series for your charts. Use the Copy Chart Colors to Clipboard option to change the order of the color codes.

---

**Important:** The links section in the branding tab provides in-product links to the documentation and the help section. It is recommended that you do not make any changes to these links as you will not be able to access any in-product support if you change these links.

---

### Security

You can customize the security preferences for your organization. You can define the number of login attempts allowed before users are locked out of their accounts. You can set your file control preferences by defining whether the users can upload attachments, add images, export data, or use box integration.



If you disable exporting of data in this section, it prevents data export from lists, views, and tables, scheduled exports, downloading published dashboards, and removes the export and import section.

---

**Note:** If you have configured scheduled exports and have disabled the data export in this section, all scheduled exports are deleted.

---

You can grant or restrict access to specific users or domains by adding them to the safelist. Users or domains not part of this safelist cannot access the enterprise. For better management and to avoid lengthy list, you can add safe-listed domains.

---

**Recommendation:** Along with the users or domains from your enterprise, you will find the domains from Shibumi (\*@shibumi.com) and Automation Anywhere (\*@automatoinanywhere.com) added to your safelist by default. The domain from Shibumi cannot be removed, and we recommend not removing the domain from Automation Anywhere.

---

## Users

You can perform user management actions to all the users displayed in this tab. You can remove, enable, disable, lock, or unlock users, and provide or revoke admin rights to a user. Select the user, hover over the actions menu (three vertical ellipses) located on the top right and perform appropriate action.

Given below are the list of options available within the action menu. Depending on the user's role some options are restricted (grayed out).

- Send Password Reset: In instances where users forget their password, an administrator can start a password reset email that is sent to the email address on record.
- Disable MFA: When users cannot access their MFA authentication, the administrator can disable and reset the user's MFA requirements.
- Get Registration Link: If the user's email client blocks the invitation email or if they have accidentally deleted the invitation email, the administrator can retrieve the invitation registration link and provide it to the selected user.
- Remove From Enterprise: As an administrator, you can remove users from the enterprise. When you remove a user, you are prompted to select a user who will inherit the work items that are assigned to the user being removed. This ensures smooth continuity of work. You can re-assign work to multiple people by navigating to the org hierarchy and re-assign using Participant Window.
- Enable: Authenticate a user into the enterprise.
- Disable: Disable a user's account from the enterprise.
- Unlock: Unlock a user who is locked out.
- Lock: Lock out a user from the enterprise. When the user account is locked, the user cannot authenticate into any enterprise in the CoE Manager.
- Make Admin: Assign the enterprise administrator permissions to the selected user. This action can only be performed by the enterprise administrator or an account owner.
- Revoke Admin: Revoke the enterprise administrator permissions assigned to a user.

---

### Note:

- As an administrator, you can export user data from the Users tab. You can export either the user list or the registration link history of the enterprise.

- Users tab always displays one user from Shibumi (Account Owner) and one user from Automation Anywhere(Admin). The Shibumi user cannot be removed. This user is only an account owner and does not have any visibility into the application section or to the instance where the actual data is displayed. There is no global access control, and each section has its own access control. Therefore, the person who is an enterprise admin here, cannot manage or view other sections.

---

**Recommendation:** Automation Anywhere team uses the account, `aacoemanager@automationanywhere.com` to help update your CoE Manager instance and for troubleshooting. It is recommended that you do not remove access to this account.

---

## Notifications

Use this tab to configure options to control what notifications should come through the CoE Manager. By default, all the notifications are enabled, and it is recommended that you keep the default settings to ensure users are notified in a timely manner ensuring smooth workflow.

Given below are the list of notification options.

- Role assignment notifications: Users receive a notification when they are invited into a work item. This setting applies to all except the first invitation email.
- Remove user access notifications: Users receive a notification when they are removed from roles in a work item.
- Discussion notifications: Users holding roles in a work item are sent a notification email each time a discussion is added to the work item.
- Notifications icon in sidebar: Determines whether the notifications queue is made available on the left pane navigation sidebar in the enterprise.

---

**Note:** The notifications are deleted after 180 days.

---

## Homepages

You can configure a work item or dashboard to be the application-specific homepage for users. If a user does not have a personal homepage defined and has access to the configured homepage, this will be the landing page for the user after authentication. This is also displayed by selecting the **Home** icon on the navigation sidebar. To add a homepage, type the name of the appropriate work item or dashboard in the search field. Choose from the list of options displayed.

To add a homepage, type the name of the appropriate work item or dashboard in the search field. Choose from the list of options displayed.

---

**Note:** Only the options which you have access to are displayed.

---

Select the appropriate option from the list and click the **Add** button to add the homepage. When multiple homepages are configured, you can re-order the list by dragging and dropping them in the desired order. The list order defines the order of the homepage the user sees. Save your changes.

Users are not automatically granted access to homepages you have added. You must select the **Auto-assign Viewer Role** option to automatically grant access to the users to the appropriate homepage as they are added to the enterprise. Save your changes.

---

**Note:** Permissions to the homepage can be managed directly on the work item or dashboard. If a user's access rights are revoked from the work item or dashboard, they are no longer routed to this item as their homepage.

---

Upon authentication, the homepage to be displayed depends on the following factors:

- If a user has a personal homepage defined, they are routed to their personal homepage.
- If the user does not have a personal homepage, CoE Manager will check whether the user has access to an enterprise configured homepage. If there are multiple homepages configured for the enterprise, CoE Manager begins from the top of the list and displays the first homepage to which the user has access.
- If there are no enterprise configured homepages or if the user has no access to any of the listed homepages, the CoE Manager default homepage is displayed.

## Configure CoE Manager

The CoE Manager provides several program-level administration tabs to configure it as per your requirements. You must have an admin permission to configure the CoE Manager.

You can configure these various administration level tabs to define the following:

- The program level details such as the number format, currency, and start and end time for the program; define the weighted benefit at each stage; what should be displayed in your advanced views, complexity cost estimates; and creating opportunity and business unit sources.
- The complexity of an opportunity, its strategic alignment, and benefit types. You can also define how to configure the program dashboard, idea, pipeline, in-progress, and deployed tabs.
- Control Room integrations; Cloud or On-Premises.
- Opportunity and role assignments, you can view the participants associated with each opportunity.

The administration level tabs you can configure are given below:

- [Admin - Program](#)
- [Admin - Users](#)
- [Admin - Tech](#)
- [Admin - Advanced](#)

### Admin - Program

You can configure the general settings for the overall program.

In the **Admin- Program** tab, you can define the start and end date of your program, the weighted benefits at each stage, the target values to use while calculating overall score for your opportunities, the complexity of cost estimates, and so on.

## Program Details

Program Details
Cancel Save

Program Start Date

Currency Symbol

Number Format

Formatted Decimal Places

Track Program Risks?

Program End Date

Primary Benefit Measure

Number Suffix

Assign Intake Submitter as Opp Owner

Show Oppty Activities as

**i** Indicate which target value(s) should be used in calculating the overall score for opportunities

Opp Target - Overall Score Calculation

Opp Target - Amount Saved

Opp Target - Hours Saved

The table below describes what can be defined in each option.

Option	Details
Program Start and End Dates	Displays the start and end dates for the program.
Currency Symbol	Displays the currency symbol alongside savings values. This setting applies to all opportunities.
Primary Benefit Measure	Displays the primary quantitative measure for the CoE Manager as either hours or currency. For example, if you select currency, the program dashboard tab displays forecasted savings on the top-left corner of the page. If you select hours, the program dashboard tab displays the forecasted hours saved.
Number Format	Controls how large numbers are abbreviated. The options are full number, thousands, and millions.
Number Suffix	Automatically assigned based on the number format selected, has a value of $\text{K}$ for thousands and $\text{M}$ for millions.
Formatted Decimal Places	Specifies how many decimal places to display in numbers formatted with $\text{M}$ or $\text{K}$ based on the number format selection described above.

Option	Details
Assign Intake Submitter as Opp Owner	Determines whether the system should create an account for the user submitting the opportunity. This is applicable for users who currently do not have an account with the CoE Manager. If set to <b>Yes</b> , the email address in the opportunity submission form is used to create the user account. Ensure the email domain is added to the trusted list within the CoE Manager.
Track Program Risks	Specifies whether or not to show the risks tab at the program level.
Show Opp Activities As	Specifies how opportunities activities are displayed on the activities tab. You can choose between a List and a Gantt-Chart.
Opp Target – Overall Score Calculation	Choose whether you want to use amount or hours to calculate opportunity targets.
Opp Target – Amount and Hours Saved	Specifies the target amount and hours saved for individual opportunities. For calculating the Overall Score for an opportunity, the percentage achievement toward these targets as well as the business alignment percentage is used.

## Weighted Benefit per Stage

Weighted Benefit per Stage
Stage 1 Weight 0%
Stage 2 Weight 25%
Stage 3 Weight 50%
Stage 4 Weight 100%

Determines the weightings to calculate the weighted benefits for opportunities at each stage in CoE Manager. The weighted benefit is calculated by multiplying the estimated value for each opportunity with the corresponding factor to reflect the confidence of the benefit being achieved. Typically, opportunities in the idea stage are weighted lightly and gain in weighted value as they progress toward deployment. The weighted value is used to estimate total program savings.

## Advanced Views

You can set the visibility of the below-mentioned admin tabs:

- Admin - Advanced
- Admin - Users
- Admin - Tech

## Complexity Cost Estimates

Specifies the default implementation cost estimate to be assigned for an opportunity when either a low, medium, or high complexity assessment is specified for that opportunity. You can override the default cost estimate by typing a new value in the implementation cost field on the details tab for the opportunity.

## Business Unit List and Opportunity Sources

Lists the business units and opportunity sources for the automation program. Use the Create Business Unit and Create Opportunity Source buttons at the top of the section tabs respectively to create the business unit and opportunity sources.

[Set up organization hierarchy and link opportunities](#) on page 2062

## Monthly Targets

Lists the program and business unit targets. You can enter the targets for the program as a whole and individual business units in this list.

Set up organization hierarchy and link opportunities

You can set up an organization hierarchy by creating business units and their sub-level units and link opportunities to them. This provides a better understanding of how many opportunities were submitted from different areas of the organization, how many were automated, and measures the ROI generated from them.

You must have an administrator role.

- Create a business unit.
  - a) In the CoE Manager, navigate to the **Admin-Program** tab.
  - b) Click **Create Business Unit**.
  - c) Enter a name for the business unit.
  - d) Click **Create**.

A new business unit is created under the root folder which you can verify in the navigation pane on the left.
- Create a sub-level unit for the organization hierarchy structure.
  - a) In the CoE Manager, select the business unit for which you want to create sub-levels.
  - b) In the business unit details page, navigate to the **Org Hierarchy Admin** tab.
  - c) Click **Create Org Hierarchy**.

- d) Enter a name for the sub-level unit.
- e) Click **Create**.

---

**Note:** You can create an unlimited amount of business units and sub-levels units.

---

A sub-level is created under the business unit which you can verify in the navigation pane on the left. A new **Org Hierarchy Path** column in the **Opportunity** and **Org Hierarchy Admin** tab displays the path (including the business unit and its sub-levels) this opportunity belongs to.

- Map opportunity to the business unit or its sub-level unit.
  - a) Select the business unit or the sub-level unit for which you want to map an opportunity.
  - b) Navigate to the **Opportunities** tab.
  - c) Click **Create Opportunity**.  
The intake form page is displayed.
  - d) Select the business unit or the sub-level unit from the drop-down to which you want to map this opportunity.
  - e) Enter the rest of the details in the intake form and click **Finish**.  
After a page refresh, the opportunity is displayed under the business unit or its sub-level unit to which this opportunity is mapped.

## Admin - Advanced

You can define the detailed prompts for additional benefits, complexity and strategic alignment questions for automation opportunities. You can also specify the display icons across the CoE Manager.

## Label Settings

You can change the labels for workstream, complexity and strategic alignment attributes in the details section of an opportunity.

Label Settings	
Workstream Label Business Unit	Workstream Label (CAPS) BUSINESS UNIT
Complexity Label Complexity	Complexity Label (CAPS) COMPLEXITY
Strategic Alignment Label Alignment	Strategic Alignment Label (CAPS) ALIGNMENT

## Opportunity - Addl Benefit Types

You can define up to five categories of benefits in the additional benefits section on the details tab for opportunities. You can track benefit amounts and comments for each benefit category for the opportunities.

**Opportunity - Addl Benefit Types**

Additional Benefit Type 1  
**Cost Avoided**

Additional Benefit Type 2  
**Risk Avoided**

Additional Benefit Type 3  
**Revenue Enabled**

Additional Benefit Type 4  
**Productivity Improvement**

Additional Benefit Type 5  
--

## Opportunity - Complexity

Defines up to five complexity questions, weighting for each question and the scoring scale. You can rate each opportunity on a scale from none to very high to drive a complexity score (based on the weightings) for the opportunity.

## Opportunity - Strategic Alignment

Defines up to five strategic alignment questions and the weighting for each question. You can rate each opportunity on a scale from none to very high to drive an alignment score (based on the weightings) for the opportunity.

## Export and Import

You can bulk import opportunities into a program. You can import your previously created opportunities into the CoE Manager.

See [Export and import opportunities in CoE Manager](#) on page 2065.



Export and import opportunities in CoE Manager

As an administrator, you can bulk import previously created opportunities into a program in the CoE Manager.

1. In the CoE Manager, navigated to **Admin - Advanced > Export / Import Opportunities**.
2. Download the opportunity template.
  - a) Click the **Export** button. An excel file is downloaded.

---

**Note:** This is a pre-filled template with existing opportunities in the CoE Manager. If there is no data in the CoE Manager, the exported excel file will only contain headers in it.

---

- b) Open the downloaded template and click **Enable Editing**.
  - c) For each row of new opportunity to be created, enter the data as outlined below:
    - Column A: Default to `Opportunity_t`
    - Column B: Do not fill
    - Column C: Enter the **Business Unit** for the opportunity being created
    - Column D through AE: Fill the details as required
  - d) Optional: Enter the submitter email address.
  - e) Save the excel file.
3. Import the file.
  - a) Click the **Import** button.
  - b) Browse and choose the file to import and click **Import**.

## Admin - Tech

You can manage the integration of automation platforms for the program. CoE Manager enables you to track process level return on investment (ROI) of your automations with real-time dashboards.

The ability to measure the ROI of automations helps you to:

- Create a robust pipeline of automations to move your business forward.
- Understand the impact of your automation program across the enterprise.
- Track both the transaction and the process ROI.

You can connect up to three Control Room instances with one instance of CoE Manager. These Control Room instances can be either Cloud or On-Premises.

Control Room Integrations		
Name	Automation Anywhere URL	Hosting Type
<a href="#">Cloud CR</a>	aa-saleseng-v2-eu-1-1.my.automationanywhere.digi...	Cloud
<a href="#">Control Room EU</a>	ssarkaraa.ae.dev.supremomono.com	On-Prem
<a href="#">QA on-prem CR</a>	rscr003.automationanywhere.net	On-Prem

1-3 of 3 < >

**For Cloud Integrations**

**Enabled** integrations run every four hours starting at 2AM UTC. If any settings are missing (URL, Username, API Key) the integration will be automatically disabled.

**For On-Prem Integrations**

Download the Bot, install into your Control Rooms, configure with the generated URL provided and schedule the Bot to run.

## Cloud Control Room integration

When you enable the integration between the CoE Manager and the Cloud Control Room, the enabled integrations run periodically. This ensures that the CoE Manager automatically pulls the automation data from the Cloud Control Room for ROI calculation.

To retain the enabled integration enabled without any disruption, enter the correct Control Room URL, username, and API key.

The enabled integration ensures that all the bot execution and transactional data is pushed from the Control Room to the CoE Manager every four hours. Each push includes the current day's data plus the previous day's data in full. This overlap of data is done to ensure there are no data gaps in the case of API call failures. All duplicate data is automatically corrected in the CoE Manager before publishing them on the dashboards.

### Architecture

The following image shows the architecture of integrating CoE Manager with a Cloud Control Room:

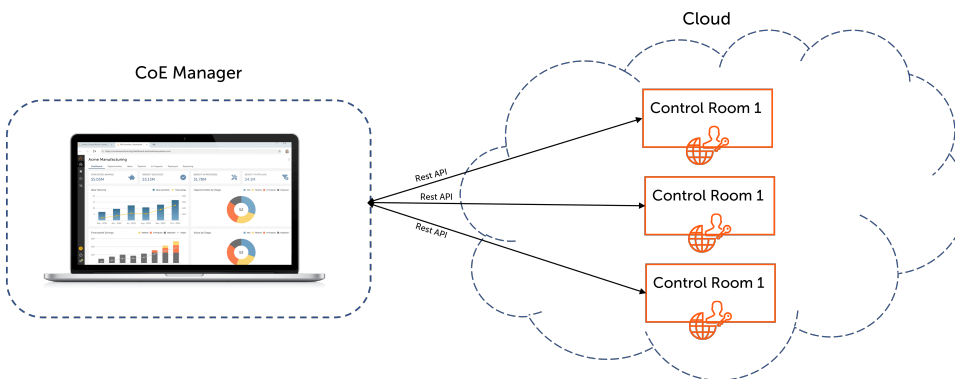

## On-Premises Control Room integration

To track the ROI of your automations on an On-Premises Control Room, you need to run a bot to push the automation data from the Control Room to CoE Manager on the Cloud. The bot checks the activity logs for the specified time and sends the data to CoE Manager. For the bot to execute successfully, you must provide the following information:

- Control Room URL - This is the URL of the Control Room instance on which the bot executes.
- API Key username - This is the Control Room user with **View everyone's activity** and **Generate API-Key** permissions and who creates the API key.
- API key - This is the key generated using the above credentials.
- CoE Manager URL - This is the destination URL which is retrieved from the **Admin - Tech** tab in the CoE Manager. The activity log data is sent to this URL.

---

**Important:** The data collected from the Control Room does not include any personally identifiable information (PII) or sensitive data.

---

**Recommendation:** Schedule your bot that pushes data to the CoE Manager to run at least once a day to avoid data gaps in the CoE Manager dashboards. Each data push will include the current day's data plus the previous day's data in full. This overlap of data is done to ensure there are no data gaps in case of API call failures or network issues. All duplicate data is automatically corrected in the CoE Manager before publishing them on the dashboards.

---

The following data is pushed from the Control Room to CoE Manager:

- Automation name
- File name
- File path
- Start date time
- End date time
- Status
- Progress
- Automation ID
- User ID
- Device ID
- Modified by
- Created by
- Device name
- Username
- Automation priority

### Architecture

The following image shows the architecture of integrating CoE Manager with an On-Premises Control Room.

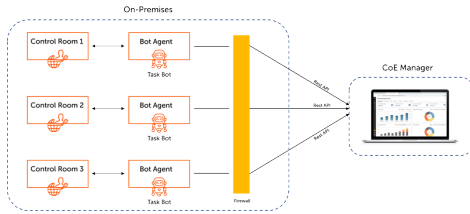

## Setting up integrations

You can calculate the ROI for automations running both in the Cloud and On-Premises Control Room.

- [Cloud Control Room](#)
- [On-Premises Control Room](#)

## Troubleshooting

If you are unable to see the ROI or activity data in the **Opportunities > Execution Tracking** tab in CoE Manager, see below for possible reasons:

- There might be Control Room configuration setup issues in CoE Manager. Ensure that you have correctly set up the following:
  - The Automation Anywhere URL must be in `xyz...abc` format. It should not be in `https://xyz...abc/` format.
  - Automation Anywhere username and API Key are correctly set up in the Control Room and entered correctly in CoE Manager.
- There might be a problem with the Control Room user account or the API key. To troubleshoot, review the audit logs and the logs for the Control Room user account. See the following examples.

**User log in**

Event details	
Status	Item name
Unsuccessful	N/A
Event started by	Time
[redacted]@automationanywhere.com	23:30:34 IST
Object type	Event type
Event	User log in
Source device	Source
3.225.63.178	Control Room
Request ID	
35ae00b2d6620f59	

**Results**  
User does not exist in Control Room.

**User log in**

Event details	
Status	Unsuccessful
Item name	N/A
Event started by	[REDACTED]
Time	19:30:29 IST 2023-02-07
Object type	Event
Event type	User log in
Source device	34.235.57.253
Source	Control Room
Request ID	ec91d1c46d826e94
Results	User provided incorrect API Key.

- Activity API is unable to retrieve the run data for Task Bots. You can verify this by running the activity API and checking whether it pulls data for your bot. If the activity API cannot find these bots, it cannot push their activity logs to CoE Manager. As a result, no ROI will be calculated.
- API key might have expired. Ensure that API key has not expired by checking the API key expiry duration in the Control Room settings.
- CoE Manager has not yet performed the batch extraction of activity data from the Control Room. Check the run schedule in the **Admin – Tech** tab and recheck the ROI data after the integration has run.

#### CoE Manager Plus - Integrate with Cloud Control Room

You can integrate the CoE Manager Plus with the Cloud Control Room to monitor your automations and calculate the savings achieved. There are no limitations on the number of Control Room instances you can link to with one instance of CoE Manager Plus.

- In the Control Room, perform the following steps:
  - a) Create a custom role with **View everyone's activity** and **Generate API-Key** permissions.
  - b) Create a user and assign the custom role created above.
  - c) Generate API Key for the user.  
For details about generating API key, see [Create API key generation role](#) on page 1765.
- In the CoE Manager Plus, perform the following steps:
  - a) Navigate to **Admin - Tech** tab.  
You must have RPA admin or RPA tech-admin role to access the **Admin - Tech** tab.
  - b) Click **Add Automation Integration**.
  - c) In the Create Control Room Integration screen, provide the following details:
    - a) Provide a name for your integration.
    - b) Select Automation Anywhere in the **Vendor** field.
    - c) Provide the vendor URL.
  - d) Enter the username in the **Vendor Username** field.
  - e) Enter the API key in the **Vendor API Key** field.
  - f) Click **Save**.

---

**Note:** For Cloud Control Room, the enabled integrations run every four hours and thus data is pushed from Control Room to the CoE Manager Plus periodically.

---

The **Enabled** column automatically changes to **Yes** when you save the URL, username, and API key.

### CoE Manager Plus - Integrate with Microsoft Power Automate

You can integrate CoE Manager Plus with the Microsoft Power Automate environment to monitor your automations and calculate the savings achieved. There are no limitations on the number of Microsoft Power Automate environments you can link to with one instance of CoE Manager Plus.

1. In the Microsoft Azure, register a new application and generate client and tenant ID.
  - a) Navigate to **App registrations > New registration**.
  - b) Provide a name for the application.
  - c) For the supported account types, select the option **Accounts in this organizational directory only (Automation Anywhere only – single tenant)**.
  - d) In the redirect URI field, select **Web** as the platform.  
Leave the URL blank. You must add the generated CoE Manager callback URL here.
  - e) Click **Register**.

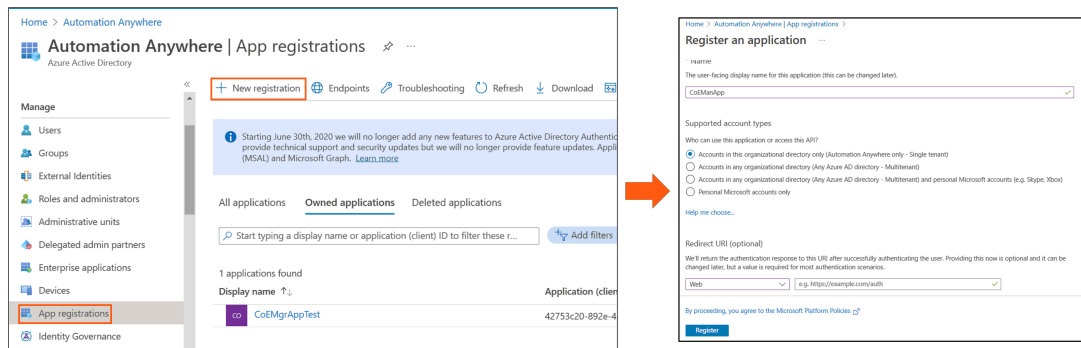

- f) Copy the unique Client ID and tenant ID to clipboard.

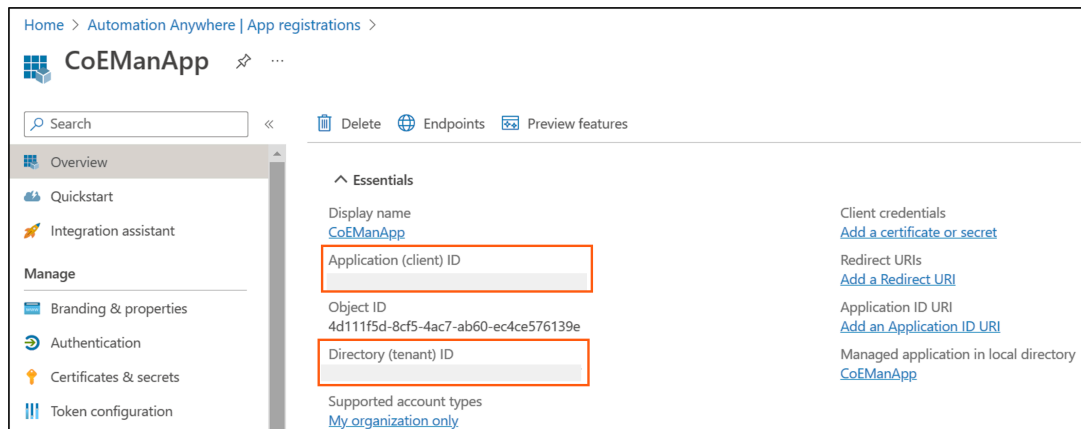

2. Generate client secret.
  - a) Navigate to **Certificates & secrets**.
  - b) Click **new client secret**.
  - c) Enter a description.

- d) Select the validity period of the client secret.

**Recommendation:** Choose 180 days (6 months).

- e) Click **Add**.

- f) Copy the generated client secret to clipboard.

**Note:** The client secret will not be available once you move away from this screen.

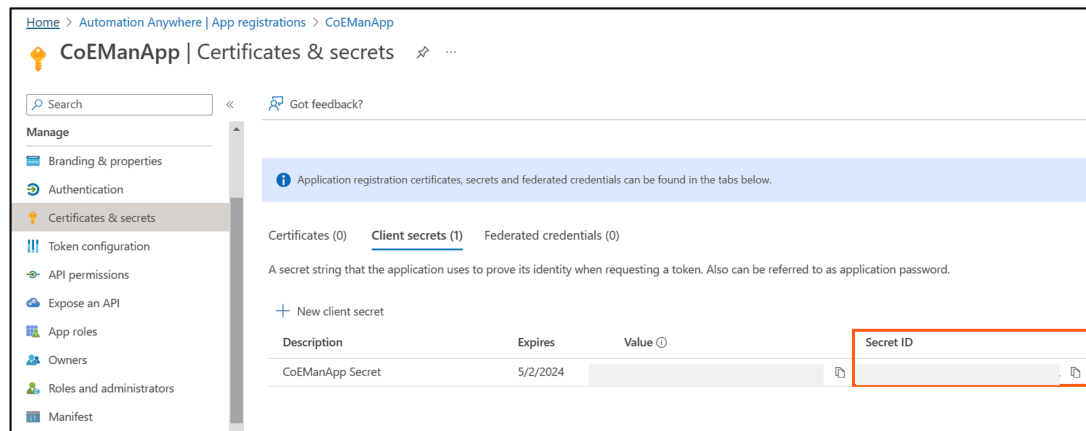
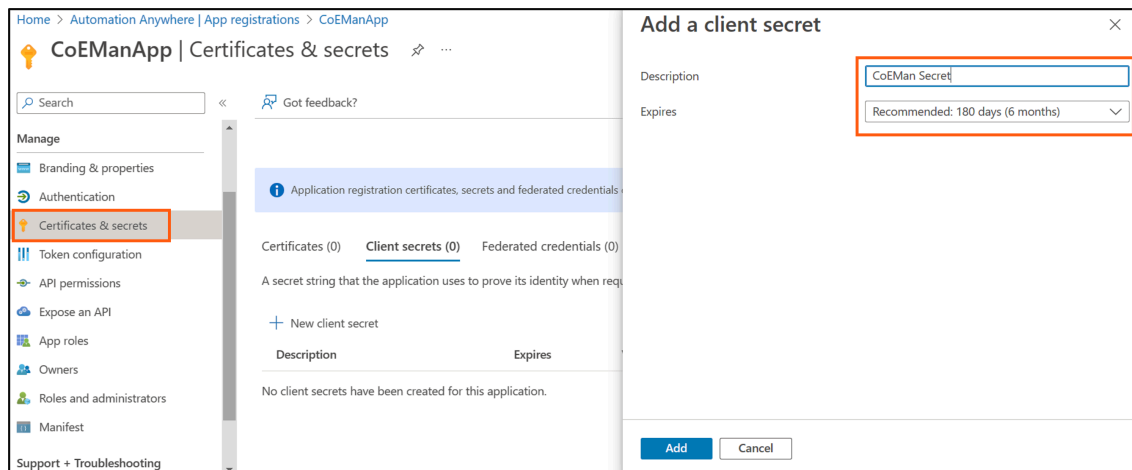

3. Set the API permissions.

- a) Navigate to **API permissions**.

- b) Select **Power Automate** in the **Request API permissions** tab.

- c) In **Flows permission** field, select **Read All** permission.

- d) Click **Add permissions**.

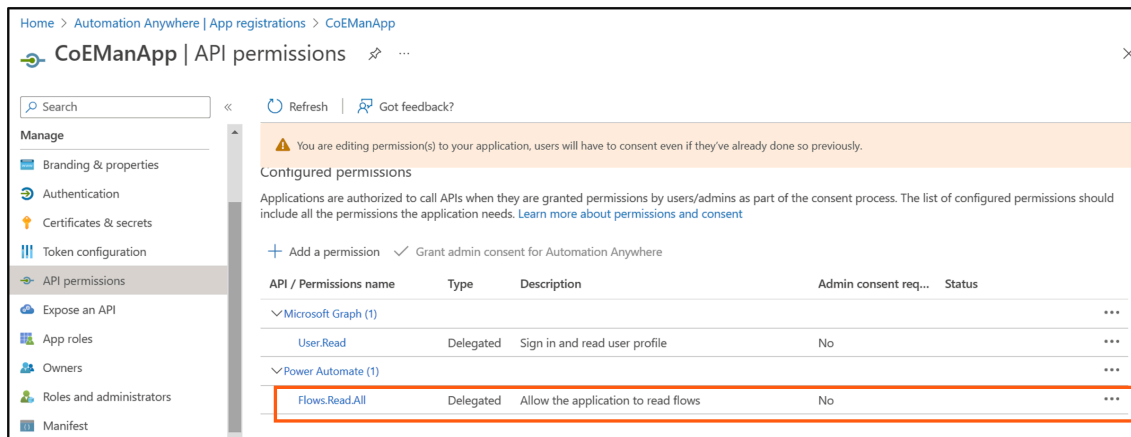
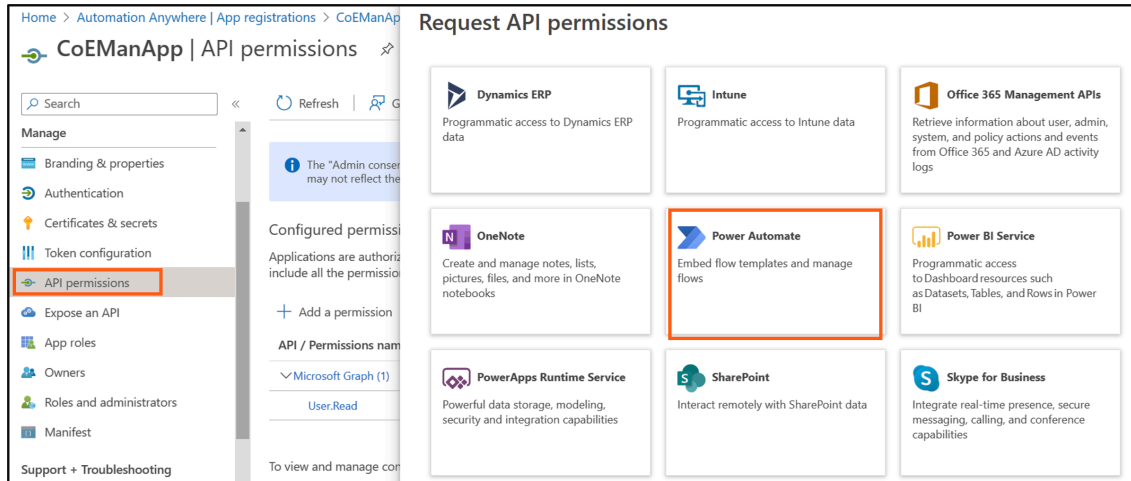

4. In CoE Manager Plus, navigate to **Admin-Tech** tab.  
You must have RPA admin or RPA tech-admin role to access the **Admin - Tech** tab.
5. Click **Add Automation Integration**.
6. In the **Create Control Room Integration** screen, provide the following details:
  - a) Provide a name for your integration.
  - b) Select **Microsoft Power Automate** in the Vendor field.
  - c) Provide the vendor URL.
  - d) Click **Create**.



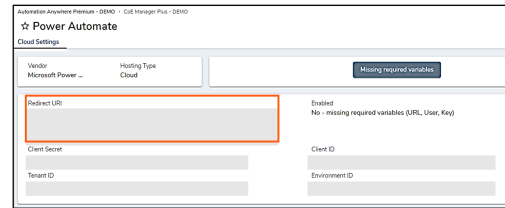
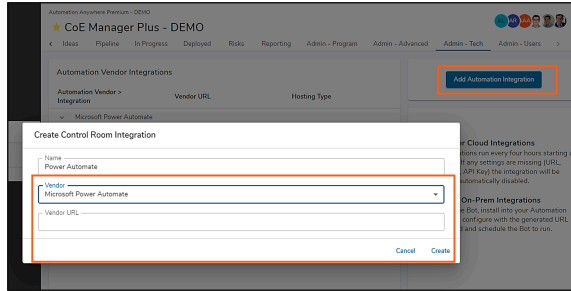

7. Copy the generated redirect URI to clipboard.
8. In the Microsoft Azure portal, navigate to **Authentication**.
  - a) In **Configuration platforms**, select **Web**.
  - b) Provide the redirect URI generated in CoE Manager Plus.

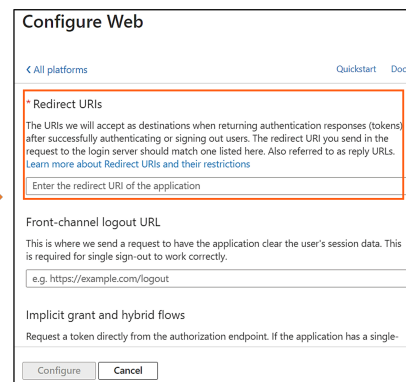
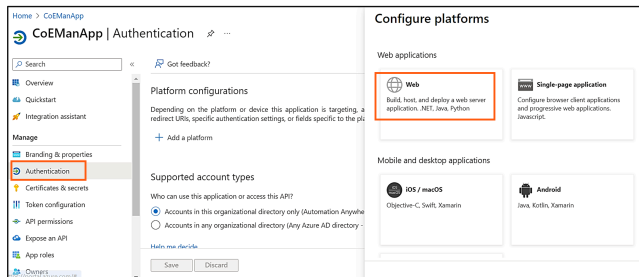

9. In CoE Manager Plus, enter the Client Secret, Client ID, and Tenant ID generated from Microsoft Azure portal.
10. Enter the Environment ID from your Power Automate environment.
11. Click the **Click to Authorize** to authenticate.

**Note:** The enabled integrations run every four hours and thus data is pushed from the Power Automate environment to the CoE Manager Plus periodically.

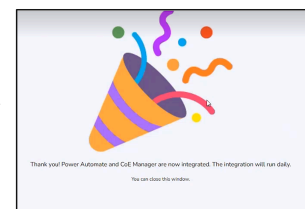
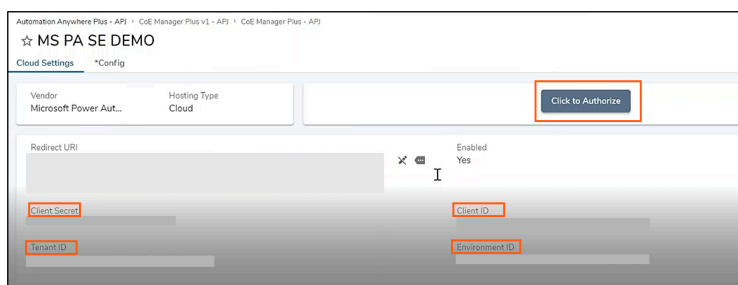

A connection is now established between CoE Manager Plus and Power Automate, and a success screen displays confirming the successful connection. The **Enabled** column automatically changes to **Yes** when you save the Client secret, Client ID, Tenant ID, and Environment ID.

### CoE Manager - Integrate with Cloud Control Room

You can integrate the CoE Manager with the Cloud Control Room to monitor your automations and calculate the savings achieved. You can link up to three Control Room instances with one instance of CoE Manager.

To link a Cloud Control Room to the CoE Manager, follow the steps mentioned below.

- In the Control Room, perform the following steps:
  - a) Create a custom role with **View everyone's activity** and **Generate API-Key** permissions.
  - b) Create a user and assign the custom role created above.
  - c) Generate API Key for the user.
- In the CoE Manager, perform the following steps:
  - a) Navigate to **Admin - Tech** tab.  
You must have RPA admin or RPA tech-admin role to access the **Admin - Tech** tab.
  - b) Click the placeholder URL in the **Automation Anywhere URL** column.
  - c) Click **Edit** in the **Hosting Type** field and select **Cloud**.
  - d) Click **Edit** in the **Automation Anywhere URL** field and enter the Control Room URL.
  - e) Enter the username in the **Automation Anywhere Username** field.
  - f) Enter the API key in the **Automation Anywhere API Key**.
  - g) Click **Save**.  
The **Enabled** column automatically changes to **Yes** when you save the URL, username, and API key.

---

**Note:** The enabled integration ensures that all the bot execution and transactional data is pushed from the Control Room to the CoE Manager every four hours. Each push includes the current day's data plus the previous day's data in full. This overlap of data is done to ensure there are no data gaps in case of API call failures. All duplicate data is automatically corrected in the CoE Manager before publishing them on the dashboards.

---

See the following video to understand how to integrate CoE Manager with Cloud Control Room.

If you do not see ROI or activity data in the **Execution Tracking** tab of your opportunity, see [Troubleshooting](#) on page 2068.

### CoE Manager - Integrate with On-Premises Control Room

You can integrate the CoE Manager with the On-Premises Control Room to monitor your automations and calculate the savings achieved. You can connect up to three Control Room instances with one instance of CoE Manager.

To link an On-Premises Control Room to the CoE Manager, follow the steps mentioned below.

- In the Control Room, perform the following steps:
  - a) Create a custom role with **View everyone's activity** and **Generate API-Key** permissions.
  - b) Create a user and assign the custom role created above.
  - c) Generate an API Key for the user.
- In the CoE Manager, perform the following steps:

- a) Navigate to the **Admin - Tech** tab.  
You must have RPA admin or RPA tech-admin role to access the **Admin - Tech** tab.
- b) Click the placeholder URL in the **Automation Anywhere URL** column.
- c) Click **Edit** in the **Hosting Type** field and select **On-Prem**.
- d) Click **Edit** in the **Automation Anywhere URL** field and enter the Control Room URL.
- e) Using the link in the **Bot Store Link** field, navigate to the Bot Store and download the bot.
- f) Follow the instructions in the ReadMe file to set up the bot.

---

**Important:** For an On-Premises Control Room, a bot deployment is required to push the data from Control Room to the CoE Manager. You must have a valid license such as a Bot Creator, Bot Runner, or a Citizen Developer to run the bot. To run this bot, you must also add the CoE Manager URL to trusted list. For more details on adding the URL to trusted list, see [Add service URLs to trusted list for On-Premises](#) on page 1322.

---

**Recommendation:** Schedule your bot that pushes data to the CoE Manager to run at least once a day to avoid data gaps in the CoE Manager dashboards. Each data push will include the current day's data up to the current time plus the previous day's data in full. This overlap of data is done to ensure there are no data gaps in case of API call failures or network issues. All duplicate data is automatically corrected in the CoE Manager before publishing them on the dashboard.

---

See the following video to understand how to integrate CoE Manager with On-Premises Control Room.

If you do not see ROI or activity data in the **Execution Tracking** tab of your opportunity, see [Troubleshooting](#) on page 2068.

## Admin - Users

You can manage role assignments on individual opportunities.

## Opportunity Role Assignments

Opportunity	Role	Participant
<a href="#">*Foster Human Resources Metrics</a>	Owner	Doe, John
<a href="#">*Onboarding of temporary/part-time workers</a>	Collaborator	Anywhere, Automation
	Collaborator	Dev, Citizen
	Owner	Doe, John
<a href="#">*Streamline Reviewing and Reconciling Transactions</a>	Owner	Doe, John
<a href="#">*Weekly Data Reconciliation</a>	Admin	Dev, Citizen
	Owner	Anywhere, Automation
<a href="#">Accounts Payable Automation</a>	Collaborator	Dev, Citizen
	Collaborator	Doe, Jane
	Owner	Anywhere, Automation

Displays the list of opportunities and their participants along with the role of the participant (owner, admin, or collaborator) in that opportunity.

## Enable CoE Manager

As an administrator, you can enable access to CoE Manager from the Control Room so that you can access CoE Manager from the quick links section on the Control Room home page.

1. In the Control Room, navigate to **Administration > Settings > CoE Manager**.
2. Click **Edit**.
3. Click **Enable**.  
By default, this feature is disabled.
4. Select the relevant URL from the **Web URL being used to access CoE Manager** field.
5. Click **Save changes**.  
The CoE Manager link appears in the **Home page > Quick links** section. Clicking this link redirects you to the CoE Manager login page.

## Add CoE Manager IP addresses to allowed list

Add the CoE Manager IP addresses to the allowed list to integrate with your On-Premises deployments.

Based on your region, add the following IP addresses to the allowed list:

Region	IP addresses
Australia	<ul style="list-style-type: none"> <li>• 3.105.16.38/32</li> <li>• 13.239.101.172/32</li> <li>• 13.236.61.98/32</li> <li>• 13.55.74.225/32</li> <li>• 52.64.225.51/32</li> <li>• 13.238.247.129/32</li> <li>• 13.210.60.187/32</li> <li>• 52.64.179.80/32</li> <li>• 13.210.140.62/32</li> </ul>
EU	<ul style="list-style-type: none"> <li>• 35.158.196.131/32</li> <li>• 18.184.19.254/32</li> <li>• 18.156.98.76/32</li> <li>• 35.156.15.80/32</li> <li>• 35.158.157.214/32</li> <li>• 18.194.176.117/32</li> <li>• 3.124.250.102/32</li> <li>• 35.158.20.10/32</li> <li>• 18.184.130.68/32</li> </ul>

Region	IP addresses
US	<ul style="list-style-type: none"> <li>• 34.235.57.253/32</li> <li>• 52.4.93.113/32</li> <li>• 100.26.125.232/32</li> <li>• 3.225.63.178/32</li> <li>• 52.200.7.94/32</li> <li>• 35.172.176.237/32</li> <li>• 35.168.155.121/32</li> <li>• 52.201.70.75/32</li> <li>• 34.232.227.184/32</li> </ul>

## Roles and user management

To interact (create, edit, view, delete) with a work item in Shibumi, you must be assigned a role that has permission to access the work item.

### Overview

Permissions are inherited downwards, that is, a user assigned to a role on a work item will have access to the work item and all the descendent work items. The default permission (access level) that the user has on the work item is defined by the role assigned. Each role is assigned to one of three access levels: admin, edit, or view.

Five out-of-the-box roles are available on every template. The following table identifies these role and their associated access levels.

Role	Access level	Manage roles	Read	Edit	Create	Copy	Move	Delete
Owner, Sponsor, Admin	Admin	#	#	#	#	#	#	#
Collaborator	Edit	#	#	#	#	#	-	-
Viewer	View	-	#	-	-	-	-	-

Your solution can have additional custom roles. When creating the custom role, the app admin will select an access level for it.

For roles with the edit access level, when the app admin enables the role on a template, that is the role will be available on instances of the template, they can further define whether the role can manage role assignments. If the ability to manage roles is allowed, any user with this role will be able to assign users to any roles with access level of edit or view. They will not be able to manage assignments to admin access level roles.

You can see the access level of each role on the **Roles** tab of either the template or the app.

---

#### Note:

- The access level defines the default permission for the role on a work item. With additional configuration logic; however, the app admin can further restrict permissions. For example, the app admin can define tab visibility logic allowing only users holding the finance team role to see the finance tab. Even though users hold other roles with admin access level, if they do not hold the finance team role, they will not see the tab.
- Roles are multi-user. There is not a limit on the number of users that can be assigned to a role.
- Users can be assigned to multiple roles on a single work item.
- When a user holds multiple roles, the default access level for the user will be the highest level of their assigned roles. This logic applies to inherited roles as well. For example, if a user is assigned to an admin access level role at the program level and then assigned to an edit access level role to a descendent project within the program, the default access level for the user on the project will be the admin access level.

## Participant window

The **Participant** window enables the management of role assignments on a work item.

Assign users to roles

1. Click the avatar icons to open the **Participant Window**.



2. Enter the email address of the user you want to add.
  - For first-time users, Shibumi will email an invitation to the user to set up an account and log in.
  - For existing users, when you start typing the user's name or email, it will automatically complete.
3. Select one or more roles for the user. Roles that have been enabled on the template will be available in the drop-down list.
4. Select the blue **Add** option to add the user to the item.

### Note:

- Pressing down the command or ctrl key on your device (Mac vs. PC) will allow you to

select multiple roles without the drop-down closing.

- **Visible To** includes all users that do not directly have a role on the work item but that have inherited permissions to see the work item from an ancestor work item role assignment.

Permissions are inherited to descendent work items. For example, if a user is assigned to a role on a program that includes five projects, the user will have access to the program and all of the projects.

- Users can also be assigned from a role column included on a list, view, or table or from a role field on an edit or create form.

---

## Manage role assignments

To manage role assignments for a user, open the **Participant** window and click the user name. A floating menu is displayed with three options: **Manage**, **Replace All**, **Remove All**.

---

**Note:** If you do not have a role with the ability to manage roles, you will not see the floating menu.

---

- Manage

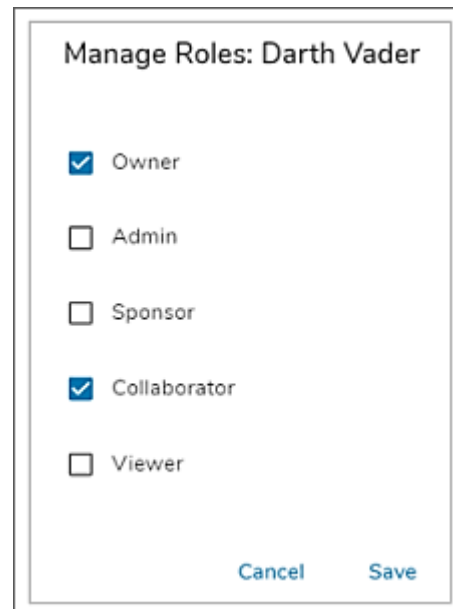

- The **Manage Roles** window displays all roles enabled for the work item. The roles provided to the user will be selected.

- Select or deselect roles to add or remove the user to or from roles on the work item and click **Save**.
- Replace All
  - The **Replace All** option replaces a user in all roles they hold on the current work item as well as on any roles they hold on descendant work items.
  - On the window, select another user to replace the current one in all roles. Click **Replace**.
- Remove All

The **Remove All** option removes the user from all roles on the current work item. It does not remove the user from roles provided for descendant items. A dialog box will ask you to confirm the removal. Click **Remove**.

## Permissions

Permissions are inherited downwards. For example, a user assigned to an admin access level role on a program work item will have admin access to the program as well as on all descendent project work items.

Conversely, permissions are never inherited upwards. No users will have access to the items above the highest level to which they are directly assigned a role.

For example, in the following image, Jane Doe has been assigned as collaborator on the \*IT workstream within the digital transformation program. Jane has access to all of the descendent projects and milestones within the workstream. When Jane opens the business logic development milestone, the breadcrumb trail above the title of the milestone will not extend past the \*IT workstream level.

**Note:** The (unavailable) app name is listed to the left of the highest level the user has access to.

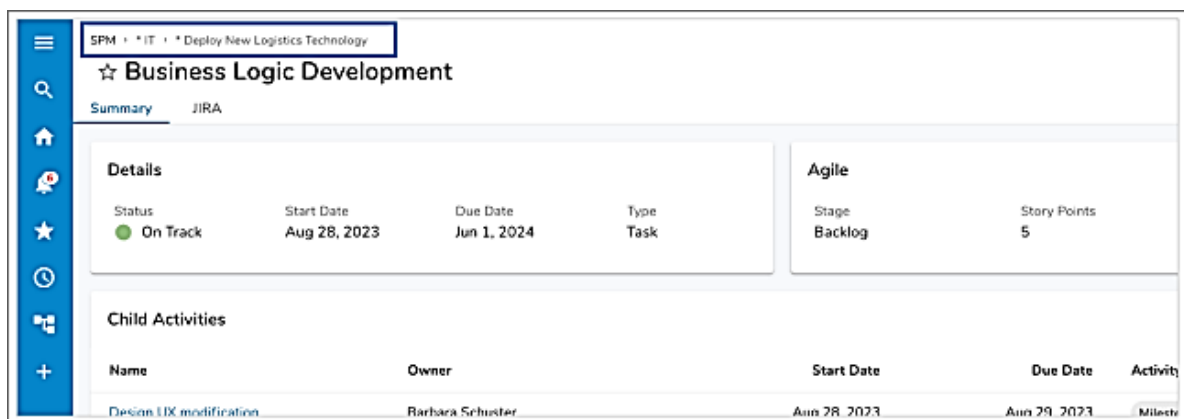



## Additional role functionality

Owner role: Owner is an out-of-the-box, admin access level role. The creator of a work item will automatically be assigned to the owner role in the follow scenarios:

- The work item is created from a **List** section. For these sections, the owner field cannot be included on the **Add Item** dialog box so the creator is assigned by default.
- The work item is created using **Bulk Edit on a List** section and the owner role is not included on the bulk edit form or is on the form but is left empty.
- The work item is created through a create form or sidebar create and the owner role is not included on the form or is on the form but is left empty.

An owner is not automatically assigned for work items created through the following methods, but can still be assigned manually:

- Create work item business rule (can use an **Assign Role Action** to assign owner, if required)
- Import or export section (can include owner as a column to assign owner, if required)
- Child work items populated from a template
- Dashboards or presentations that came from a template
- The GraphQL API

## Placeholders or open resources

- Shibumi provides the ability to define a placeholder role. This is referred to as an open resource and can be defined in the **Participant** window for any work item in the solution.

It allows for a placeholder role assignment on work items without assigning a user. Open resources are often used when the details for a work items are not yet ready to be shared with all users but it is valuable to understand which roles will be participating.

- Until the open resource is filled with values, it will be displayed with a gray background.
- To enter values in open resource, click the **Open Resource**, select the **Assign All** option, and select the user that will be assigned. This will apply to all roles the placeholder has on the current item as well as on all descendant items.

The screenshot displays the user management interface in Automation Anywhere. At the top, there are user avatars (KP, DS, GS, JD, +6). Below them are search filters: 'Name or Email' and 'Role(s)'. A blue 'Add' button is present. The user list includes:

- Owner:** Ken Pellegrino (KP)
- Collaborator:** owner (O), Sam Turnbull (ST)
- RPA Admin:** (AS)
- RPA Approver:** (AS)

A context menu is open over Sam Turnbull, showing options: Manage, Assign All, and Remove All. A modal dialog titled 'Assign Open Resource in All Roles' is open, showing a search field 'Assign owner to', a dropdown indicating '4 items will be affected', and 'Cancel' and 'Assign' buttons.

**Note:** One common application of the open resource capability is for the program admin to assign roles to the open resource throughout the program. Only when the solution is fully defined, assign a user to the open resource. All items in the program assigned to the open resource are then assigned to the designated user and summarized into a single email invitation.

## Create and manage opportunity

Submit and build a business case for an opportunity and track its progress through the approval stages. Measure the results of the opportunity after it has been automated.

### Opportunity owner

As an Opportunity owner, you propose and build the business case for new opportunities, track the progress of opportunities through stage gates, and oversee opportunity implementations. When an opportunity has been delivered, you also track the benefit provided by the opportunity to ensure that the achieved benefit matches the anticipated benefit outlined in the business case.

It is important for you to provide up-to-date information about the opportunity to the automation CoE and your executive team. The investment made into each opportunity is justified by the anticipated value to be achieved when the opportunity is delivered. The opportunity information you provide helps your CoE and leadership team understand the current state and make strategic decisions.

Before you can access the RPA Accelerator to enter and update opportunity information, you must create an account. See [Create and manage your account](#) on page 2051.

### Access the program

After creating an account, you will be authenticated into the RPA Accelerator with the program content displayed by default.

The program or the opportunity dashboard is defined as the homepage. In addition to the **Home** icon, you can use the navigation tree to view and access the opportunities. You can access these from any page (both routes are highlighted in the following image).

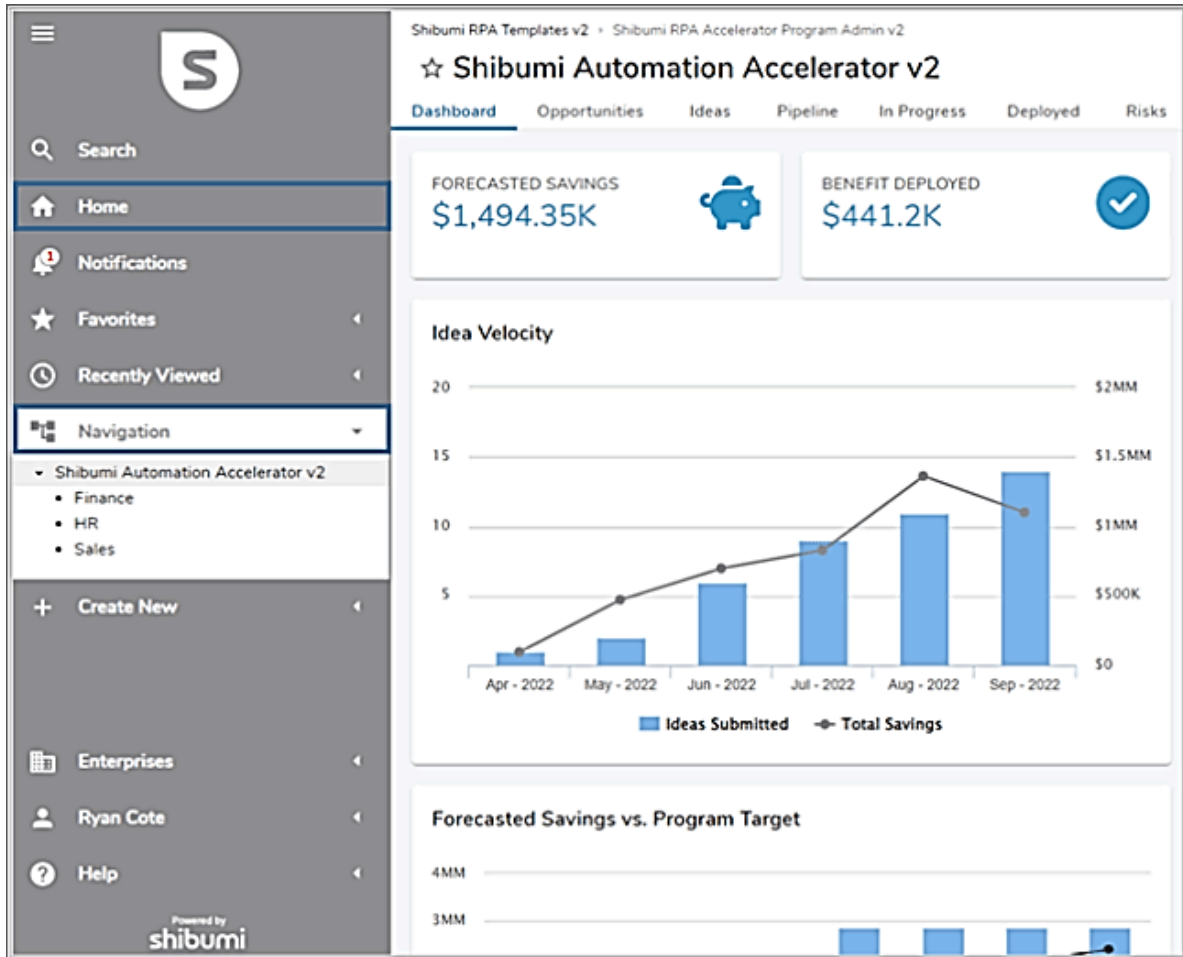

**Note:** when your automation lead sets up the RPA Accelerator, they will have invited you into the program level or into an opportunity that triggered the email prompting you to join Shibumi. Permissions are inherited downwards within the RPA Accelerator. If you were invited into the top-level Program, you have the ability to access and edit all unlocked data in the workstreams and opportunities. However, if you were invited into a specific, lower-level opportunity, you will be able to edit information specific to that opportunity.

## Create an opportunity

To create a new opportunity, click **Create Opportunity** on the **Opportunities** tab or the **Opportunity** dashboard.

The screenshot shows the 'Shibumi Automation Accelerator v2' dashboard. At the top, there is a navigation bar with tabs for Dashboard, Opportunities, Ideas, Pipeline, In Progress, Deployed, Risks, and Reporting. A 'Create Opportunity' button is prominently displayed. Below this is a table titled 'RPA Opportunities' with the following columns: Opportunity Name, Workstream, Overall Score, Alignment, Total Savings, Total Costs, Complexity, Implementation Date, Stage, and Submitted Date. The table lists 14 different automation opportunities across various workstreams like HR, Sales, and Finance.

Opportunity Name ↑	Workstream	Overall Score	Alignme...	Total Savings	Total Costs	Complexity	Implementati...	Stage	Submitted
*Onboarding of temporary/part-t...	HR	74%	52%	256,800	15,000	2 - Medium	Aug 16, 2022	4 - Deployed	May 16, 2022
Accounts Payable Reconciliation	Sales	70%	28%	96,000	15,000	2 - Medium		1 - Idea	Sep 12, 2022
Adjust Preparing and Amending De...	HR	65%	80%	24,300	30,000	3 - High		1 - Idea	Sep 13, 2022
Auto-populate leads across outboc...	Sales	77%	72%	88,400	30,000	3 - High	Sep 2, 2022	4 - Deployed	Jun 9, 2022
Auto-track the completion of compa...	HR	46%	28%	5,184	15,000	2 - Medium	Jan 13, 2023	2 - Pipeline	Aug 26, 2022
Automate Customer Outreach	Finance	80%	80%	63,360	15,000	2 - Medium	Dec 5, 2022	2 - Pipeline	Jun 23, 2022
Automate Envelope Mail Out	Finance	69%	44%	55,440	30,000	3 - High		1 - Idea	Sep 3, 2022
Automate Payroll Tax Filings	Sales	81%	80%	864,000	15,000	2 - Medium		1 - Idea	Aug 12, 2022
Automated Postage Stamp Liker	Sales	81%	68%	60,000	15,000	2 - Medium	Feb 13, 2023	3 - In Progress	Jul 7, 2022
Automatic Quote Generation	Sales	82%	88%	57,600	15,000	2 - Medium	Dec 13, 2022	3 - In Progress	Jun 23, 2022
Call Meeting Scheduler	Sales	68%	92%	14,400	15,000	2 - Medium	Dec 13, 2022	2 - Pipeline	Aug 26, 2022
Consolidate Automate Payroll Tax Fil...	Finance	81%	72%	142,560	20,000	2 - Medium	Dec 9, 2022	3 - In Progress	Jul 30, 2022
Consolidate Preparing and Amendin...	HR	61%	48%	17,496	15,000	2 - Medium	Oct 28, 2022	3 - In Progress	Aug 26, 2022

When the create opportunity process is initiated, you will be prompted to answer questions used to categorize and define the anticipated value of your proposed opportunity.

After you have submitted the responses to the questions, a new opportunity is created and you are provided a link to it so that you can continue to edit opportunity information and monitor the approval process.

See an example of the questions included in the opportunity creation process in the following image:

The screenshot shows a form for creating an opportunity. It includes a dropdown menu for 'Workstream' with a '-- Select --' option. Below this are three text input fields with prompts: 'Let's start with the name of your idea', 'Now let's describe it in more detail', and 'Please provide your e-mail address'. A blue 'CONTINUE' button with a right-pointing arrow is at the bottom.

## Manage opportunity data

On the **Opportunity** window, key information is organized and grouped in tabs. You can access the tabs by clicking the tab names. The name of the currently displayed tab is highlighted in blue. By default, the **Opportunity Summary** tab is displayed.

The following table lists the tabs:

Tab	Description
Opportunity Summary	Monitor overall delivery status and advance the opportunity to new stages
Details	Review costs, benefits, and the alignment of the opportunity to the program's strategic goals
Activities	Create and track the status of activities required to implement the opportunity
Execution Tracking	View the automation process and digital worker information associated with the opportunity
Workflow	Review delivery status of opportunity, submit for approval/approve, retire and cancel the opportunity
History	Audit field edits, status changes, and stage approvals

## Opportunity summary tab

The screenshot displays the Opportunity Summary tab for the project '\*Onboarding of temporary/part-time workers'. The interface includes a navigation bar with tabs: Opportunity Summary (active), Details, Activities, Execution Tracking, Workflow, and History. A progress bar shows four stages: Idea, Pipeline, In Progress, and Deployed. Key performance indicators are shown as follows:

OVERALL SCORE	% ALIGNMENT	EXPECTED ANNUAL BENEFIT	BENEFIT REALIZED TO DATE
74%	52%	\$256,800	\$96,300

The Status section indicates 'Things are going well.' with a message from Robert Aung on Sep 20, 2022, and an 'Update Status' link. The Details section provides the following information:

Submission Date	2022-05-16
Implementation Date	2022-08-16
Submitted By	Robert Aung

An 'Approvals Complete' button is located in the top right corner of the main content area.

1. Edit the status message by clicking the **Update Status** hyperlink.

- Submit the opportunity for stage gate approval by clicking **Submit for Approval**.

## Details tab

Shibum RPA Templates v2 - Shibum RPA Accelerator Program Admin v2 - Shibum Automation Accelerator v2 - HR

☆ **\*Onboarding of temporary/part-time workers**

Opportunity Summary **Details** Activities Execution Tracking Workflow History

**Labor Savings Details**

% of Tasks Automated	# of Personnel	Hours per Person	Times per Month	Avg Pay / Hr
80%	5	0.50	350.00	27

**Additional Benefits**

Benefit	Note
Error Reduction 10,000	---
Productivity Improvement 20,000	---
Other ---	---

**Complexity**

Integrations - Degree to which multiple systems are involved in the process? (1=Very Low, 2=Low, 3=Medium, 4=High, 5=Very High)  
**Medium**

Documentation - Degree to which the process has multiple handoffs (potentially across business areas)?

**EXPECTED LABOR BENEFIT**  
\$226,800 / 8,400 hours

**ADDITIONAL EXPECTED BENEFIT**  
\$30,000

**TOTAL EXPECTED BENEFIT**  
\$256,800 / 8,400 hours

**COMPLEXITY SCORE**  
2.4 (out of 5)

The details initially displayed for the opportunity are what is entered on the opportunity intake form. Edit any data by clicking the **Edit** icon for the field. After you have clicked the icon, the form toggles to edit mode. Update the content and then click **Save** on the form to save the newly entered or edited values.

As you change details on the left, the value summaries on the right will update to reflect the modifications. The overall prioritization score for the opportunity is derived from the expected benefit, estimated cost, complexity, and alignment.

## Workflow tab

Shibum RPA Templates v2 - Shibum RPA Accelerator Program Admin v2 - Shibum Automation Accelerator v2 - HR

☆ **\*Onboarding of temporary/part-time workers**

Opportunity Summary Details Activities Execution Tracking **Workflow** History

Idea Pipeline In Progress Deployed

Approvals Complete Approval Not Pending Disapproval Reason Retire Opp Cancel Opp

The Workflow tab displays the following options (blue buttons):

- Submit for Approval:** This option notifies the approvers that the opportunity is ready for review and approval. After you have submitted the opportunity, the label on this option will change to **Approve**.

- **Approve:** If you have the permission to approve opportunities, you can click this option to approve the opportunity to move it to the next stage gate. Depending on which gate the opportunity currently resides, this might be disabled.
- **Disapprove:** This option is disabled until a disapproval reason is entered. When this option is clicked, the opportunity does not progress forward and a notification email is sent to the opportunity owner. The opportunity owner can then either address the disapproval reason or cancel the opportunity.
- **Retire Opp:** The retire and cancel options both set an inactive disposition for the opportunity. The retire option indicates that the automation opportunity was deployed but has now been retired.
- **Cancel Opp:** The retire and cancel options both set an inactive disposition for the opportunity. The cancel option indicates that the automation opportunity was not approved to be deployed.

## History tab

The screenshot shows the 'History' tab for an opportunity titled '\*Onboarding of temporary/part-time workers'. The interface includes a navigation menu on the left and a top navigation bar with tabs for Opportunity Summary, Details, Activities, Execution Tracking, Workflow, and History. The 'History' tab is active, displaying two sections: 'Status History' and 'Audit History'.

**Status History**

Created	Created By	Status	Status Message
Sep 20, 2022	Robert Aung	●	Things are going well.
Sep 20, 2022		●	
Sep 20, 2022		●	

**Audit History**

Attribute Name	Old Value	New Value	Modified By	Modified Date / Time (UTC)
Additional Benefit # 1	--	10000	Robert Aung	Sep 21, 2022, 1:50:21 PM
Additional Benefit # 2	--	20000	Robert Aung	Sep 21, 2022, 1:50:21 PM
Cost per Execution Failure	--	7500	Robert Aung	Sep 20, 2022, 7:46:11 PM
Opportunity Source	--	Business Leadership Workshop	Robert Aung	Sep 20, 2022, 7:17:56 PM
Submitter Email	--	robert.aung@shburns.com	Robert Aung	Sep 20, 2022, 7:17:56 PM
RPA Status Date	--	Sep 20, 2022	Robert Aung	Sep 20, 2022, 7:15:44 PM
RPA Status Message	--	Things are going well.	Robert Aung	Sep 20, 2022, 7:15:44 PM

Review the status history and modification made to the opportunity data on this tab.

## Create and manage activities

After the opportunity is approved and moves to the in-progress stage, the automation implementation activities begin. While implementing, you can create, edit, and assign activities from the **Activities** tab.

1. Activities are created by navigating to the **Activities** tab and selecting the plus (+) icon (grey) located on the right-side of the opportunity name on the **Activities Gant** section.



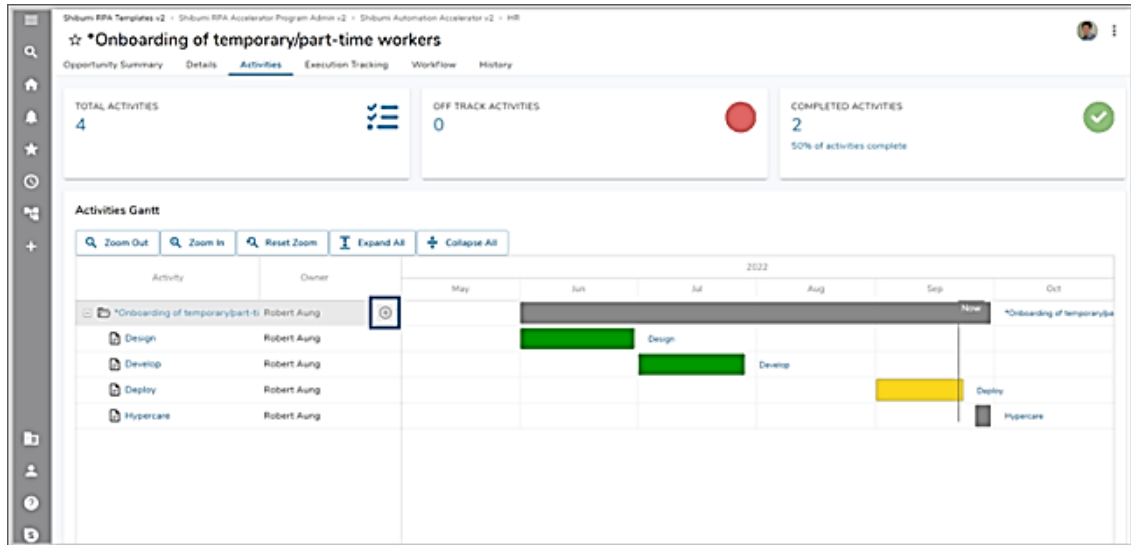

2. Add the name, start date, and due date in the **Create a new Automation Activity** dialog box. When these updates are saved, the activity will be generated on the **Activities Gantt** section.
3. From the Gantt, you can hover over and select one of the activities to open the preview pane for the specific activity. The preview pane allows for quick tracking and editing of certain features of the activity, such as the completion date.
4. To delete an activity, select the blue hyperlink name for the intended activity. When the automation activity opens in a new tab, select the three dots on the top-right of the page and choose the **Delete** option.

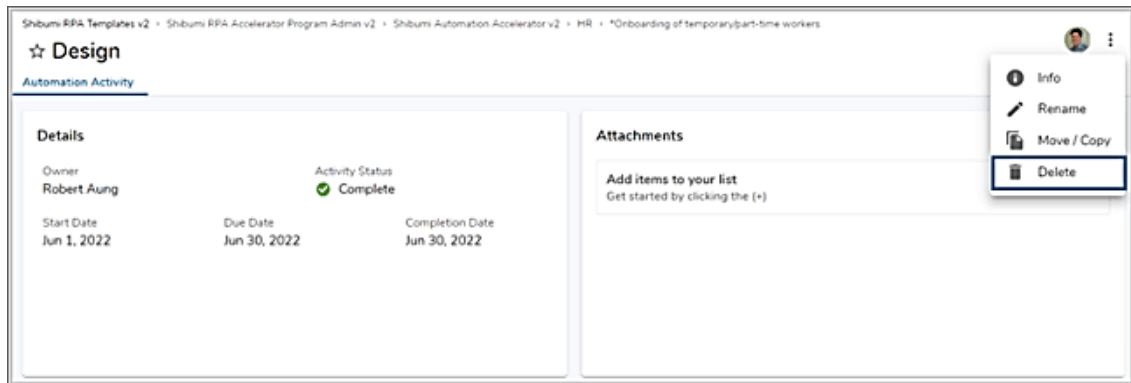

## Managing team members

To invite people into the RPA Accelerator, use the **Participant** window. Start by navigating to the work item to which you want grant access, then click the person silhouette icon at the top right of the page.

From the **Participant** window, you can invite a user to a role on the opportunity.

- If you are adding an existing RPA Accelerator user,
  1. Type the user's name (the intelligent type ahead will propose matches).

2. Select the correct match.
  3. Select the role the person will fill.
  4. Click **Add**.
- If you are adding a new RPA Accelerator user,
    1. Type the user's email address.
    2. Select the role the person will fill.
    3. Click **Add**.

The new user will receive an email inviting them to set up an account. When the user has set up the account, they will have access to the work item.

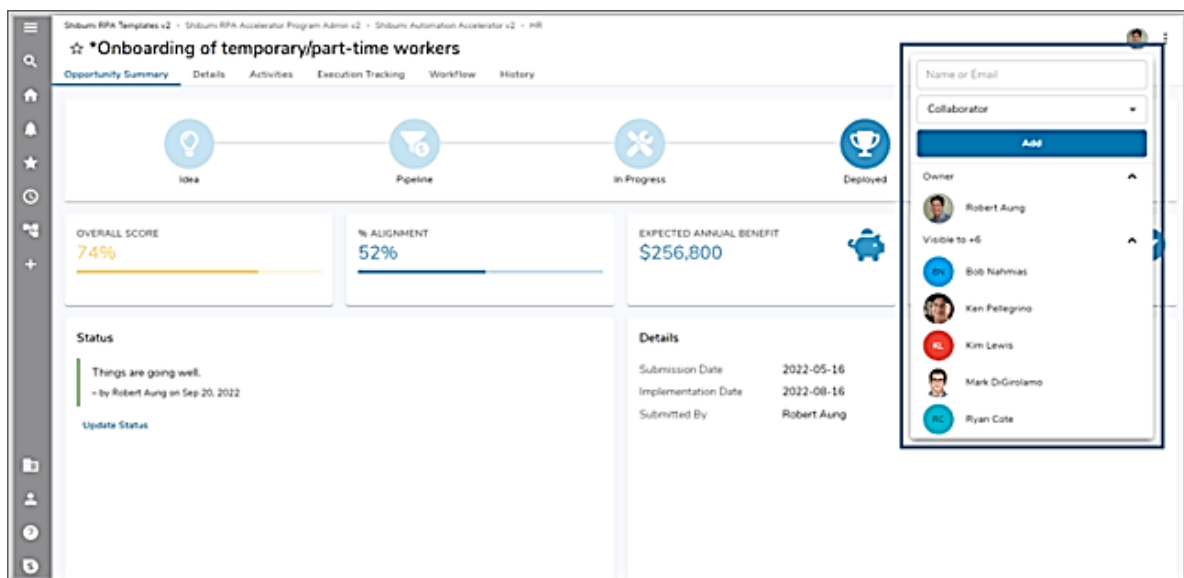

## CoE Manager Plus - Link automation to opportunity

As an administrator, you can review the automations information (in-progress or deployed) and link the automations directly to an opportunity.

1. In CoE Manager Plus, select the opportunity to which you want to link the automation by using one of the following methods:
  - a) Navigate to **Opportunities** tab.  
A list of opportunities is displayed.
  - b) Click the search option (magnifying glass icon) on the navigation sidebar and search with the opportunity name.

---

**Note:** To link the automation to an opportunity, the opportunity should be in the **In Progress**, **Deployed**, or **Completed** stage.

---

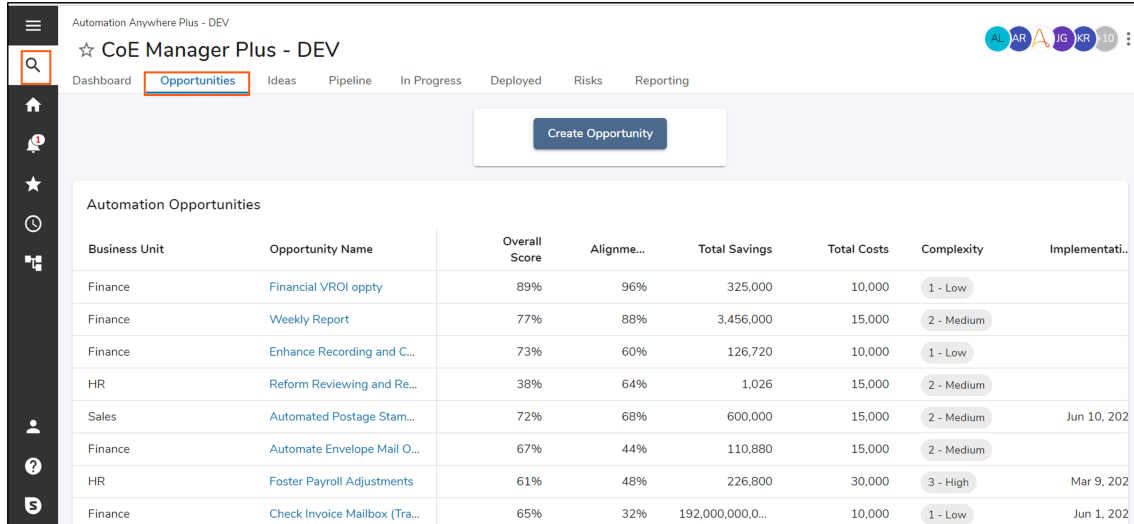

2. Select the opportunity and navigate to the **Execution Tracking** tab.  
This tab is only available for opportunities that are **In Progress**, **Deployed**, or **Completed** stage.
3. Click **Add Automation**.  
The **Create Task Bot** screen is displayed.

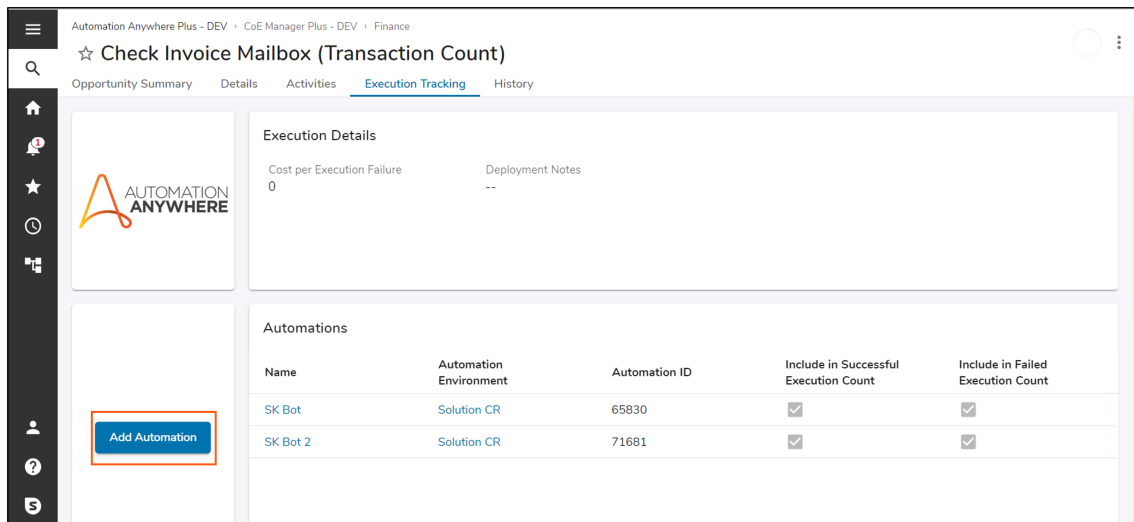

- a) Enter the **Name**.  
This can be the same name of the automation as in your automation environment or you can give a more relatable name.
- b) Enter the **Automation ID**.
- c) Optional: Select the Include in Successful Execution Count check box.  
The count of successful executions are included in the KPIs in the execution metrics section.
- d) Optional: Select the Include in Failed Execution Count check box.  
The count of failed executions are included in the KPIs in the execution metrics section.
- e) Click **Create**.

The associated KPIs are displayed in the **Execution Metrics** section.

Automation	KPI	Last 3 Months			This Month	Last 7 Days							Today
		May	Jun	Jul	Aug	Wed	Thu	Fri	Sat	Sun	Mon	Tue	Wed
Test Flow 5	Automation Duration	9,666	1,352	--	--	--	--	--	--	--	--	--	--
	Failed Executions	--	12	--	--	--	--	--	--	--	--	--	--
	Successful Executions	24,758	3,192	--	--	--	--	--	--	--	--	--	--
Test Flow 4	Automation Duration	14,272	1,608	--	--	--	--	--	--	--	--	--	--
	Failed Executions	--	11	--	--	--	--	--	--	--	--	--	--
	Successful Executions	24,758	3,193	--	--	--	--	--	--	--	--	--	--
Test Flow 3	Automation Duration	9,334	1,585	--	--	--	--	--	--	--	--	--	--
	Failed Executions	--	11	--	--	--	--	--	--	--	--	--	--
	Successful Executions	24,758	3,193	--	--	--	--	--	--	--	--	--	--

- Navigate to **Automations** tab and click the name of the automation you just added. The **Automation** screen displays.
- Edit the **Automation Environment** tab and select the automation environment from the options in the drop-down.
- Click **Save**.

## CoE Manager - Link automation to opportunity

As an administrator, you can review the deployed automations information and link the automations directly to an opportunity.

- Log in to the CoE Manager by providing your **Email Address** and **Password**.
- Select the opportunity to which you want to link the automation by using one of the following methods:
  - Navigate to **Opportunities** tab. A list of opportunities are displayed.
  - Click the search option (magnifying glass icon) on the Navigation Sidebar and search with the opportunity name.

Oppor...	Business ...	Overall Sco...	Alignme...	Total Savings	Total Costs	Complexity	Implementati...	Stage	Submitted
*Foster Huma...	HR	63%	68%	220,736	21,000	1 - Low	Nov 12, 2022	2 - Pipeline	Aug 26, 2022
*Onboarding ...	HR	76%	52%	241,800	15,000	2 - Medium	Aug 16, 2022	4 - Deployed	May 16, 2022
*Streamline R...	Finance	84%	72%	152,064	36,000	3 - High	Oct 28, 2022	3 - In Progress	Jun 18, 2022
*Weekly Data...	Finance	85%	84%	172,800	15,000	2 - Medium		4 - Deployed	Sep 26, 2022
Accounts Pay...	Finance	87%	68%	303,000	10,000	1 - Low	Oct 27, 2022	4 - Deployed	Oct 23, 2022
Accounts Pay...	Sales	60%	28%	96,500	15,000	2 - Medium		5 - Retired	Sep 12, 2022
Adjust Prepar...	HR	66%	80%	24,300	30,000	3 - High		1 - Idea	Sep 13, 2022
Approval Flo...	Finance	69%	72%	91,200	15,000	2 - Medium		2 - Pipeline	Nov 1, 2022
Auto-populat...	Sales	72%	72%	88,400	30,000	3 - High	Sep 2, 2022	3 - In Progress	Jun 9, 2022
Auto-track th...	HR	35%	28%	8,184	15,000	2 - Medium	Jan 13, 2023	3 - In Progress	Aug 26, 2022

3. Select the opportunity and navigate to the **Execution Tracking** tab. This tab is only available for opportunities that are in-progress, deployed, or completed.

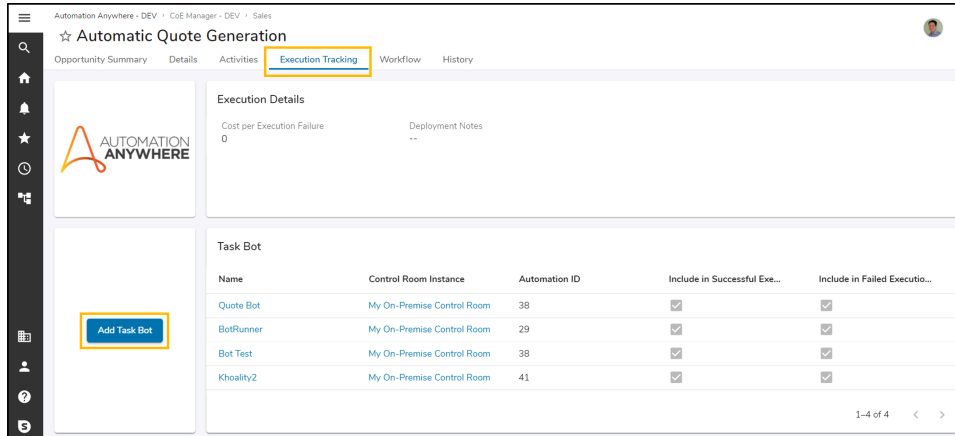

4. Click **Add Task Bot**. The **Create Task Bot** screen is displayed.
  - a) Enter the **Name**.  
This can be the same name of the Task Bot as in Automation 360 or you can give a more relatable name.
  - b) In the **Control Room Instance** field, browse and select the Control Room where the Task Bot is located.
  - c) Enter the **Automation ID**.

**Note:** The Automation ID is same as Bot ID from Automation Anywhere (see example below).

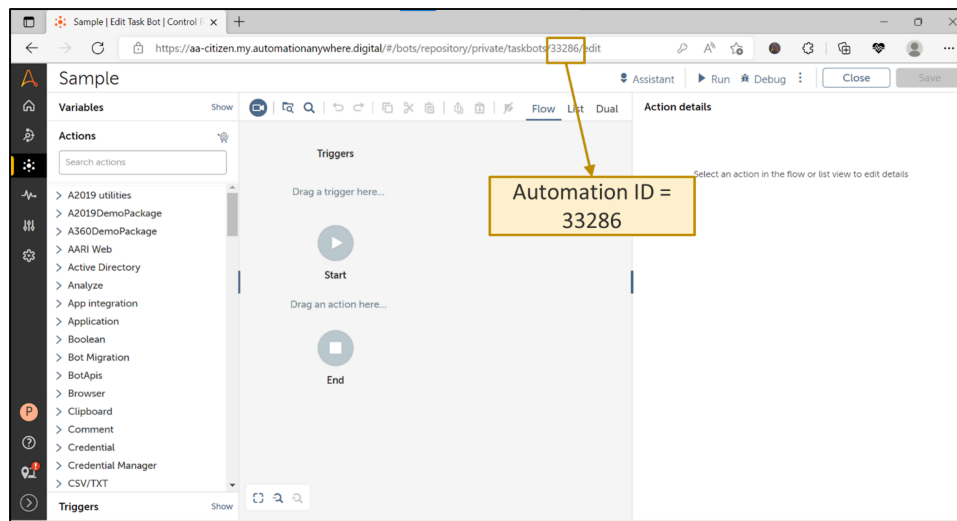

5. Optional: Select the **Include in Successful Execution Count** check box. The count of successful executions are included in the KPIs in the execution metrics section.
6. Optional: Select the **Include in Failed Execution Count** check box. The count of failed executions are included in the KPIs in the execution metrics section.
7. Click **Create**. The associated KPIs are displayed in the Execution Metrics section.

Task Bot	KPI	Last 3 Months			This Month		Last 7 Days							Today
		Nov	Dec	Jan	Feb	Mon	Tue	Wed	Thu	Fri	Sat	Sun	Mon	
Khoality2	Automation Duration	--	--	93	37	--	93	37	--	--	--	--	--	
	Failed Executions	--	--	--	--	--	--	--	--	--	--	--	--	
	Successful Executions	--	--	9	6	--	9	6	--	--	--	--	--	
Bot Test	Automation Duration	--	--	208	--	--	55	--	--	--	--	--	--	
	Failed Executions	--	--	--	--	--	--	--	--	--	--	--	--	
	Successful Executions	--	--	21	--	--	6	--	--	--	--	--	--	
BotRunner	Automation Duration	--	--	25	--	--	--	--	--	--	--	--	--	
	Failed Executions	--	--	--	--	--	--	--	--	--	--	--	--	
	Successful Executions	--	--	5	--	--	--	--	--	--	--	--	--	
Quote Bot	Automation Duration	6,000	--	266	--	--	55	--	--	--	--	--	--	
	Failed Executions	--	--	--	--	--	--	--	--	--	--	--	--	
	Successful Executions	600	--	28	--	--	6	--	--	--	--	--	--	

## ROI tracking

It is important to have current information about the opportunity so that the investment made into each opportunity is profitable when the opportunity is delivered. You can use the opportunity information to understand the status and make strategic decisions based on the status.

After the opportunity moves to the deployed state, you can track the benefit (ROI) provided by the opportunity. To track ROI for an opportunity, select the opportunity and navigate to any of the following tabs:

- **Opportunity Summary**
- **Execution Tracking > Execution Metrics**
- **Details**

You can track the ROI based on the number of bot executions or the number of transactions processed by the bot. You can select the ROI model by specifying it in the opportunity intake form.

## Execution-based ROI

Execution-based ROI evaluates the return on investment based on the successful execution counts of the automation. It calculates how many times the automation runs in a day and aggregates it based on week, month, quarter, and so on. It provides details such as successful and failed executions and the automation duration. It measures how many times an automation runs for a particular day and then calculates its benefit. The focus is on measuring the efficiency and effectiveness of the overall automation execution; not on the transactions processed.

With the execution-based ROI, you can perform the following:

- Prioritize improvement in the efficiency of the automation execution by streamlining workflows, reducing manual effort, and so on.
- Enhance operational effectiveness by identifying bottlenecks and areas to improve in the execution process.

## Transaction-based ROI

Transaction-based ROI evaluates the return on investment based on the volume or the number of transactions processed by the automation. It calculates the total number of records processed for any given day, week, month, or quarter. This provides a more granular level of tracking so you can focus on the revenue generated from each transaction.

With the transaction-based ROI you can perform the following:

- Assess the cost savings and efficiency improvements for each transaction.
- Compare and measure success of each process based on the transactional outcome.

To effectively measure transaction-based ROI, you must orchestrate the automations using the Analyze package to identify the transactions to be counted. See [Analyze package](#) on page 2412.

For example, consider the scenario where you have parent bot calling a child bot, and the transactions are processed in the child bot. If total number of transactions processed within the child bot are 3, the bot logic for each transaction should be within the **Analyze > Open and Close** action. That means, you must use **Analyze > Open and Close** action three times to record the three transactions and so on.

---

**Important:** Once you set the method to track the ROI for your opportunity as either execution or transaction based, you must not make any further modification, that is you must not change it from execution based to transaction based or vice versa. Modifying the ROI tracking method is not supported, and the dashboard displays wrong data. Instead, create a new opportunity and choose the preferred method of ROI tracking.

---

Based on your business objectives, you can select either the execution-based or transaction-based ROI tracking. You can use both ROI tracking methods to assess the benefits achieved and the cost of implementing the automation solutions. Transaction-based ROI focuses on evaluating the overall impact of the automation on the organization, whereas transaction-based ROI focuses on individual transactions processed by the automation.

## Configure transaction-based ROI

The volume ROI feature allows you to measure the realized automation value by how many business records or transactions have been completed. This feature allows you to measure the number of records processed on parent or the child bot level.

- Configure the opportunity in CoE Manager.
  - a) Follow one of the following options to configure the opportunity to measure how many records or transactions are processed by a bot.
    - In the opportunity intake form, select **# of records processed** for **How is the process is measured** question.
    - In the **Opportunity > Details** tab, select **# of records processed** in **How is Processed Measured** option.
  - b) Specify the time (in minutes) required to process a single record and the number of records processed per month.
- Add Analyze package to your automation.

Consider a scenario where the automation consists of a parent and child bot, and the parent bot calls the child bot within it. The child bot processes some records for order processing.

- a) Create parent bot.
  - b) Use **Task Bot > Run** action to call the child bot.
  - c) In the child bot, use Loop action to count the number of transactions.
  - d) Include the bot logic inside the **Analyze > Open and Close** actions. This records the number of transactions.
  - e) In the **Variables** tab on the left pane, initialize the variables #SampleNumber and "SampleString with a default value.
  - f) Note down the automation ID of the child bot.
- Track the number of records processed and value realized in CoE Manager.
    - a) In the CoE Manager, select the opportunity.
    - b) Navigate to **Execution Tracking** tab.
    - c) Add the automation ID of the child bot to the opportunity.
    - d) You can see the number of records (orders) processed by the child bot in the **Execution Metrics** tab.
    - e) Navigate to **Opportunity Summary** tab to track the benefits achieved with this automation.

## Configure CoE Manager for SSO

Use the single sign-on (SSO) option to enable the CoE Manager authentication through an identity provider (IdP) using Security Assertion Markup Language (SAML) 2.0 protocol.

### SAML SSO login setup

Before configuring the CoE Manager, ensure you have completed the following requirements:

1. Download the Service Provider (SP) metadata for your respective CoE Manager region using the links provided below:
  - US environment: [Test](#) | [Prod](#)
  - EU environment: [Test](#) | [Prod](#)
  - AP environment: [Test](#) | [Prod](#)
2. Configure your Identity Provider (IdP) with the metadata obtained from the previous step and in SAML assertion, provide the following:
  - Email, First Name, Last Name, and NameID
  - Redirect URL for IdP-initiated login as a relay-state parameter
3. Provide the IdP metadata and the attribute names received from IdP (Email, Last Name, and First Name) to the Automation Anywhere support team.



## Login workflow

SAML SSO login can be configured using one of the following methods:

- Service provider-initiated login: The SP-initiated login starts with the CoE Manager and is triggered when a user attempts to access the application through a URL. SP-initiated login requires a redirect to the appropriate IdP to ensure proper authentication before access is granted to the service or to any specific object. Depending on whether SSO is configured as mandatory or optional, your login workflow will vary. See below for more information.

- Mandatory SSO: After SSO is enabled, enter your email address in the CoE Manager login page and click **Next**.

As the CoE Manager is a multi-tenant application, you must use an email address to determine the IdP to be redirected to. This email address can be from any domain associated with your organization. CoE Manager will redirect to the IdP based on the entered email domain. For example, if your organization is Acme Corp, you might have acme.com and acmeent.com as associated domains. In this event, any address with @acme.com and @acmeent.com will redirect to the IdP when you click **Next**. You will be redirected back to the CoE Manager page after IdP authentication.

- Optional SSO: On the login page, enter the email address and click **Next**. Instead of being automatically redirected to the IdP, you will be prompted to either enter a password or select the option to log in with SSO, which will be sent to your IdP for authentication.

---

### Note:

- CoE Manager supports deep linking with SSO. After clicking the link, you should enter your email address in the CoE Manager login page. You are then redirected to the IdP for authentication. After authentication, you are redirected to the URL initially requested.
  - CoE Manager creates a cookie after successfully logging in to the application using SSO. This ensures the subsequent logins to CoE Manager will bypass the username and password screen and redirects to the appropriate SSO login page automatically. You can also override the cookie by navigating directly to the CoE Manager login page, that is `https://<region>.shibumi.com/shibumi/login`.
  - A user account is automatically created after successfully logging in to the CoE Manager using SSO for the first time.
- 
- IdP-initiated login: With IdP-initiated login, you can access the CoE Manager directly through the IdP (without a login page being displayed). When CoE Manager is launched using this method, you are taken directly to your organization's CoE Manager home page or to a URL provided by the IdP as a relay state parameter.

## Account provisioning

CoE Manager provisions user accounts as needed for organizations with enabled SSO. Accounts are generated when:

- A user is assigned a role on an object in CoE Manager
- A user is invited to a CoE Manager work item
- A user first attempts to access CoE Manager

The typical account provisioning sequence would be for a user to be invited into a work item in CoE Manager by an existing user. This triggers the auto-provisioning of their account. If this is not done, when the user attempts to access CoE Manager the first time the account is provisioned, the user will not have access to any work items. This can be a confusing experience. Therefore, it is a recommended best practice to ensure that the users are invited to participate in a work item prior to the first access.

---

**Note:** User accounts are not imported in bulk from the IdP. Users are not automatically added or removed from the CoE Manager instance when a person joins or leaves the organization.

---

When a user is authenticated via an IdP, their first and last name are updated in CoE Manager to reflect the attribute values supplied in the SAML payload (the mapping of first name and last name to attributes is part of the SAML configuration in CoE Manager and in IdP).

## Using CoE Manager

CoE manager provides a structured and consistent way of assessing all submitted opportunities, thereby increasing confidence in the quality of automation pipeline.

### Work item basics

CoE Manager is composed of Opportunities, Business Units (referred to as workstreams by Shibumi), and a Program. In CoE Manager, these are all called work items. They are places to review and add information. Each of these work items are made up of tabs and sections.

[RPA work item basics](#) on page 2099

### Roles and user management

Users are assigned to specific roles, and the role determines how the user interacts with CoE Manager. In CoE Manager, all users have inherited permissions, which means that the permissions extend below where they have access.

[Roles and user management](#) on page 2077

### Workspace

CoE Manager workspace is divided into Navigation Sidebar, Header, and Work Area.

[RPA workspace overview](#) on page 2106

### Personas and available actions

CoE Manager personas represent the people within your organization who participate in your automation program. The titles given to these personas might not match the job titles used within your organization. Use the goal descriptions to help you map your organization titles to the CoE Manager personas. Once you have mapped your positions to the CoE Manager personas, the topics to cover column (in Persona overview link below) highlights the solution activities most applicable to the persona. Persona-specific support site articles

are available through the persona column hyperlinks.

[Persona overview](#) on page 2111

Review automation program status

Review up-to-date program data in a single location to drive decision making.

[Review automation program status](#) on page 2113

## RPA work item basics

The RPA Accelerator consists of opportunities, workstreams, and a program. In Shibumi, these are all called work items. They are places to review and add information. Each of these work items are made up of tabs and sections.

### Tabs

Select a tab to view other pages within a work item. Select the left and right arrows to navigate through the available tabs. The first tab is the only tab available in the preview panel. Depending on your access or stage of your opportunity, you might see different tabs. The following image shows an example of tabs in an opportunity that has been deployed.

The tabs available in this example are **Opportunity Summary**, **Details**, **Activities**, **History**, and **Execution Tracking**.

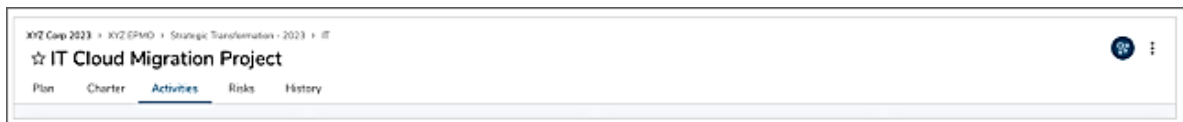

### Sections

Lists and views

Vast amounts of data can be hard to manage. Shibumi simplifies this management by enabling you to create and view this data. From lists and views, you can do the following:



Number	Option	Description
1	Refresh	Refresh a specific section to return new data. When new data is available, the refresh icon is blue.
2	Report view	Ability to view data in a table format.

Number	Option	Description
3	Gantt chart	Ability to view a time-based graphical representation of start and due dates (the colors are tied to the status).
4	Charts	Ability to view data in a variety of charts.
5	Filter	Ability to filter a list or view based on an attribute or role.  Sort: Ability to sort a list or view by recently updated or by columns in the section.
6	Settings	Export and bulk edit options are available within the settings menu.
7	Create	Ability to add to a list by selecting the + (plus) icon and adding one or multiple items. This option is not available on views.

Section icons are available on hover of the upper-right corner of lists or views. The create (plus icon) option is always displayed on lists.

Report view

Status	Name	Description	Activity Type	Owner	Target		Actual			
					Start Date	End Date	Start Date	Due Date	Completed Date	
✓	Issue RFP		Activity	Rabin Gibb	Jul 1, 2020	Jul 31, 2020	Jul 1, 2020	Jul 31, 2020	Aug 20, 2020	
✗	Shortlist solutions		Milestone	Rabin Gibb	Jul 31, 2020	Jul 31, 2020	Jul 31, 2020			

Edit: Ability to edit an item (that you have permissions to edit) by selecting inside a cell and changing the value.

Status	Name	Description	Activity Type	Owner	Target		Actual			
					Start Date	End Date	Start Date	Due Date	Completed Date	
✓	Issue RFP		Activity	Rabin Gibb	Jul 1, 2020	Jul 31, 2020	Jul 1, 2020	Jul 31, 2020	Aug 20, 2020	
✗	Shortlist solutions		Milestone	Rabin Gibb	Jul 31, 2020	Jul 31, 2020	Jul 31, 2020			

Number	Option	Description
1	Export	Generates a CSV file that downloads immediately to your computer. The file will only include columns on the list or view. If the hide filter is on, it will not show the hidden columns.
2	Export On	Schedule an export to run on a recurring cadence. View all scheduled exports on your <b>My account</b> page.
3	Bulk Edit	Allows users to bulk edit large lists or views of data in the context specified for the type filter.

Chart view

Depending on the list and view type and configuration, different chart types are available. By toggling the chart icons on the upper-right part of a section, you can change the way you view your data.

In the following example, you can see the options for a line chart, bar chart, and a doughnut chart. The doughnut chart is displayed in this example.

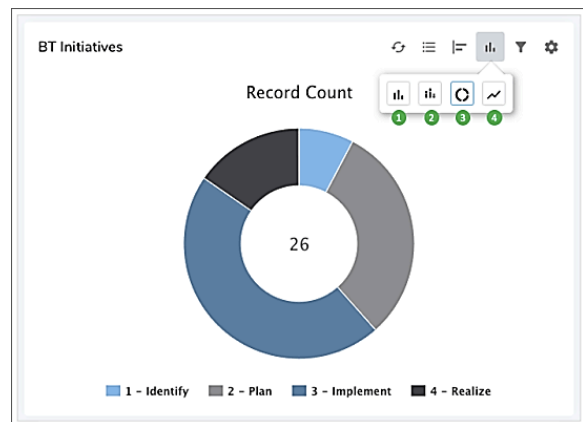

Number	Type of chart
1	Stacked bar chart
2	Line chart
3	Bar chart

Number	Type of chart
4	Doughnut chart

## Filters

In any list or view of data, a user can filter data by selecting the filter icon (located at the top-right of the section). Clicking the icons shows the filter bar where a user can type into or select values for unlocked filters. Typing text into a filter field will search for any items whose value contains that text.

- Dropdown filters

Filter name	Description
Limit	<ul style="list-style-type: none"> <li>• Applies to individual rows when show or hide filter is set to show</li> <li>• Applies to grouped rows when show or hide filter is set to hide</li> </ul>

- Toggle filters

Some attribute filters are displayed as toggles rather than text, numeric, or date fields.

Filter name	Description
Active/All	<ul style="list-style-type: none"> <li>• Active items are those that have not been marked complete or canceled</li> <li>• All items include all items, regardless of the status</li> </ul>
Show/ Hide	<ul style="list-style-type: none"> <li>• When items are grouped, the ability to show or hide items will appear</li> <li>• Selecting hide will hide items that are grouped together</li> </ul>

- Filter operations

Operators specify how filter criteria relate to one another. Review the following list of filter operators when setting filters on lists, views, dashboards, and some custom fields.

Action Operator	Description	Supported filter types
OR	Comma Filters on any of separated values entered (,)	Text, numeric
AND	Plus sign Filters on a combination of separated values (+)	Text, numeric
Exact Match	Surrounds values in quotes, for example "insert values"	Text, numeric
Empty Values	Enter double quotes containing no value for example ""	Text, numeric
Less Than	< Evaluates if a value is less than the value that follows this symbol	Numeric
Greater Than	> Evaluates if a value is greater than the value that follows this symbol	Numeric
Less or Equal	<= Evaluates if a value is less than or equal to the value that follows this symbol	Numeric
Greater or Equal	>= Evaluates if a value is greater than or equal to the value that follows this symbol	Numeric

Action Operator	Description	Supported filter types
Not Equal to	Excludes values from your results	Text, numeric

## Sort

Users can sort their lists and views with the **Sort By** options. In the **Sort By** drop-down list, users can select one or more columns to determine the sort order. If you want to sort items by ascending or descending order, click the arrow next to the item to toggle the sort order direction.

---

### Note:

- Column headers and updated date are available as **Sort By** options.
  - When sorting by ascending order, blank items will appear before alphabetized items (the opposite is true for descending order).
- 

## Create

Users can add items to a list by selecting the blue + (plus) icon in the upper-right corner. This option is not available on views. **Create New** enables you to create one item, while **Create Multiple** enables you to bulk create.

## Export

You can easily export your data from Shibumi. To manually export data from a list or view section, select the **Settings** gear icon at the top-right of the section and select **Export** from the drop-down options.



The screenshot shows the 'RPA Program 2023' dashboard. At the top, there are navigation tabs: Dashboard, Opportunities, Ideas (selected), Pipeline, In Progress, Deployed, Risks, Reporting, \*Dashboards, and \*Metrics. Below the navigation are three summary cards: 'NEW IDEAS LAST MONTH' with a plus icon, 'TOTAL IDEAS' with the value '12', 'TOTAL IDEA VALUE' with the value '\$1,586.81K', and 'OLDER THAN 90 DAYS' with the value '12' and an hourglass icon. The main section is titled 'Ideas' and contains a table with columns: Workstream, Opportunity, Overall Score, Alignment, Complexity to Automate, Hours Saved, Total Savings, Total Costs, Submitted, and Action. The table lists several HR and Sales & Marketing ideas with their respective scores and values. An 'Action' menu is open over the first row, showing options: Export, Export on, and Bulk Edit.

Data is exported based on filter and sort order configurations. All available results are returned, regardless of the limit filter configuration.

	A	B	C	D	E	F	G	H	I	J	K
1	Status	Name	Description	Activity Type	Owner	Target - Start	Target - End	Actual - Start	Actual - Due	Actual - Completed	Date
2	Completed	Issue RFP		Activity	Robin Gibb	7/1/20	7/31/20	7/1/20	7/31/20	8/20/20	
3	Delayed	Shortlist solutions		Milestone	Robin Gibb		7/31/20	7/31/20	7/31/20		
4	Delayed	Vendor Demonstrations		Milestone	Robin Gibb		10/1/20	10/1/20	10/1/20		
5	Delayed	Define requirements		Activity	Robin Gibb	10/1/20	10/31/20	10/1/20	10/31/20		
6	Delayed	Go Live		Milestone	Robin Gibb		11/1/20	11/1/20	11/1/20		
7											
8											
n											

When you open the exported file in excel, the structure of the columns will match the structure from the list or view.

**Note:** If you would like to export in a different format, change your account settings in **User preferences**.

To schedule an export, click **Export on** to open the scheduling dialog box. Select a start date, cadence (weekly or monthly), and frequency (for example, every 2 weeks on Friday). To cancel a scheduled export from the section, open the scheduling dialog box and select **Cancel Schedule** in the bottom-left corner.

### Schedule Export

**Starting**

03/26/2021 08:30 PM 

Time is in Universal Coordinated Time (UTC)

**Repeating**

Every

On

[Cancel Schedule](#) [Cancel](#) [Save](#)

When a scheduled export runs, it only takes locked filters into account. Exports can only be scheduled when the type filter is locked. If a type filter is unlocked after scheduling, the export will not complete.

To view all of your existing scheduled exports, go to your account page by hovering over the user icon in the navigation sidebar and selecting **Edit My Account**.

---

**Note:** Exporting might be disabled in your solution.

---

## RPA workspace overview

The RPA workspace dashboard provides visualization of metrics, navigation tools, and workitem-related information.



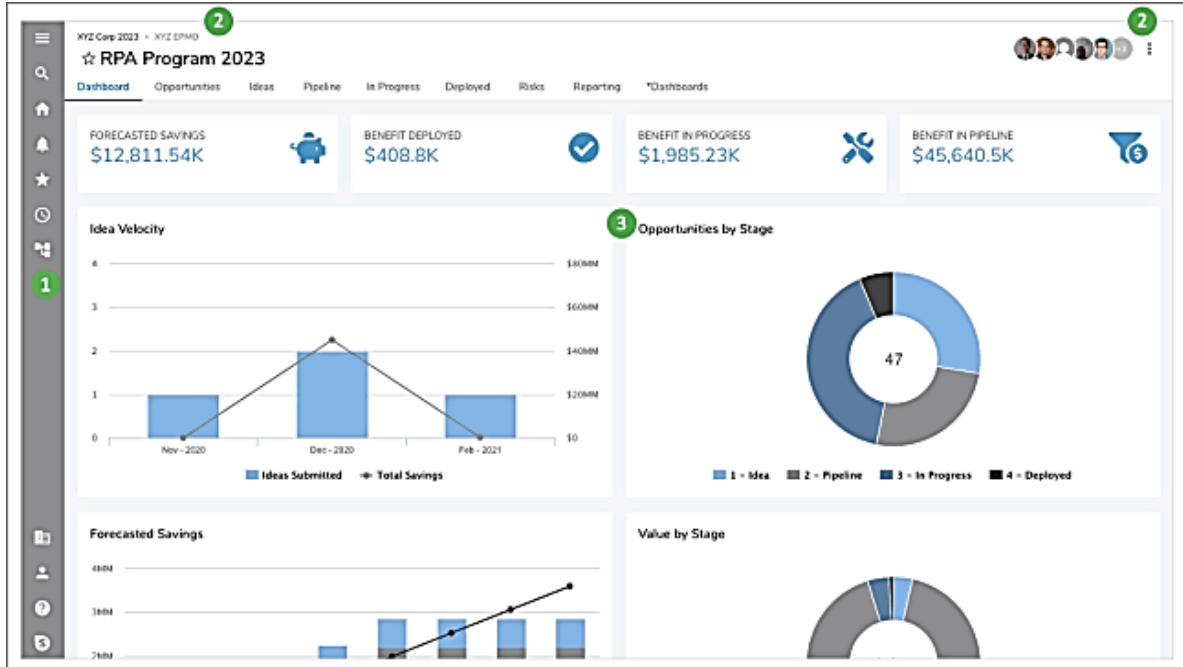





The workspace shows three areas:



Number	Option	Description
1	Navigation sidebar	Quick links to search, homepage, notifications, favorites, recently viewed, and navigation trees to help you navigate your App solution. Available on all pages.
2	Header	<p>Consists of the page name, breadcrumb trail, participant avatars, and action menu.</p> <ul style="list-style-type: none"> <li>Breadcrumb trail indicates the page location in your solution.</li> <li>Participant avatars show who has access to view or edit the page.</li> <li>Action menu provides access to settings, rename the page, move/copy or print.</li> </ul> <p>Header is available on all pages in your solution.</p>
3	Work area	<p>Contains tabs and sections that allow you to view and edit data.</p> <p>See <a href="#">RPA work item basics</a> on page 2099 for details.</p>







## Navigation sidebar

From the navigation sidebar, you can select the following:

Icon	Name	Definition
	Expand menu	Expands the navigation sidebar so you can view more details, or collapses to hide it for more workspace.
	Search	Search by item name or Shibumi ID number.
	Home	Navigates to the user's homepage.
	Notifications	Notification page where a user's notifications are grouped in an easy-to-navigate mailbox.  The number of new notifications will appear on the notifications icon.
	Favorites	List of items a user has marked as favorites.
	Recently viewed	The last 10 items that a user viewed.
	Navigation	<ul style="list-style-type: none"> <li>• Easily select and navigate through work items.</li> <li>• Carets indicate the item can be expanded to view its children.</li> <li>• Bullets indicate the item contains no children.</li> <li>• This feature is hidden until an administrator has defined a navigation structure.</li> </ul>
	User preferences	Provides the ability to edit a user's account (that is, change password).
	Help	Directs the user to help center information.

## Workitem action items

The following table describes the Header and Action menu icons:

Icon	Name	Definition
	Favorite	<ul style="list-style-type: none"> <li>Click the star icon next to the page name to add it to the favorites list.</li> </ul> <p>The star turns to a yellow color, and the page appears in the favorites list.</p> <ul style="list-style-type: none"> <li>To remove it from the favorites list, click the star icon again.</li> <li>Select <b>Manage Favorites</b> at the bottom of the favorites list to edit favorites.</li> </ul>
	Actions	Expands and collapses the actions menu.
	Settings	<ul style="list-style-type: none"> <li>Displays if you have ownership or admin rights.</li> <li>Provides ability to set item-specific configuration.</li> </ul>
	Rename	Allows you to rename the current page.
	Print	Prints the current tab of the item.
	Move or copy	Moves or copies the item.
	Delete	Deletes the current item and its children.

## Participant window

Click the participant avatars to see all of the people that have been invited to collaborate on the currently displayed work item. If you have sufficient permission, this list also allows you to invite additional collaborators to participate.





Collaborator 

Add

Owner 

 Program Owner

RPA Admin 

 Bob Nahmias

 Ken Pellegrino

 Kim Lewis

 Mark DiGirolamo

 Robert Aung

## Roles

Participants are assigned to specific roles. The role a user has determines how the user interacts with the system. In Shibumi, all users have inherited permissions, that is, the permissions extend to a below level where they have access. In the RPA Accelerator, if a user is added at a program level, their permissions extend to all workstreams and opportunities. If a user is added to an opportunity, they are only able to access that opportunity and related activities, not the program or workstream.

The following table lists the available RPA Accelerator roles. Note that the permissions of these roles extend to all items underneath where they are added.

Role	Type	Add Users	Read	Edit Unlocked Fields	Edit Locked Fields	Create	Delete	Update Opportunity Status	Approve
Owner, sponsor, admin	Admin	#	#	#	-	#	#	-	#
RPA Admin	Admin	#	#	#	#	#	#	#	#
RPA approver	Edit	-	#	#	-	#	-	-	#
Collaborator	Edit	-	#	#	-	#	-	-	-
Viewer	View	-	#	-	-	-	-	-	-
(Opportunity) Admin owner	Admin	#	#	#	-	#	#	#	-

## Persona overview

The Shibumi RPA personas represent the people within your organization that participate in your RPA program. The titles provided to these personas might not match the unique names assigned within your organization. Use the goal descriptions to help you map your organization's titles to our Shibumi personas.

After you have mapped your positions to the Shibumi personas, the Topics to cover column in the following table highlights the solution activities most applicable to the persona.

For all personas, we recommend you review the following articles:

- [Create and manage your account](#) on page 2051
- [RPA workspace overview](#) on page 2106

Persona	Goal	Topics to cover
Stakeholder or executive	<ul style="list-style-type: none"> <li>• Review my up-to-date program data in a single location</li> <li>• Use the program data to make time-sensitive decisions</li> </ul>	Navigate to and interpret the RPA dashboard

Persona	Goal	Topics to cover
CoE lead or head of automation program	<ul style="list-style-type: none"> <li>• Manage the program in alignment with our methodology and in support of our KPI objectives</li> <li>• Prioritize and approve opportunities to achieve maximum ROI</li> <li>• Have real-time visibility into the opportunity pipeline and delivery status</li> <li>• Assess program status and progress over time</li> </ul>	<ul style="list-style-type: none"> <li>• Navigate within the Accelerator to quickly find information</li> <li>• Approve (or reject) opportunities as they progress through review stage gates</li> <li>• Track top performing automation implementations to confirm expected value is achieved</li> <li>• Review program status and progress over time</li> </ul>
Automation lead	<ul style="list-style-type: none"> <li>• Introduce and enable the organization to use the RPA Accelerator</li> <li>• Add and remove participants to and from the program</li> <li>• Enable submission of opportunity ideas from anyone in the organization</li> <li>• Prioritize and approve opportunities to achieve maximum ROI</li> <li>• Have real-time visibility into the opportunity pipeline and delivery status</li> <li>• Assess status and progress over time, both at the program and workstream levels</li> </ul>	<ul style="list-style-type: none"> <li>• Set up the program with opportunities, users, dates, and targets</li> <li>• Add users who need access to the program (and remove users who no longer need access)</li> <li>• Assist with assembly of the opportunity business cases</li> <li>• Approve or reject opportunities as they progress through review stage gates</li> <li>• Navigate within the Accelerator to quickly find information</li> <li>• Track implementation progress and achieved value</li> <li>• Review program, workstream, and opportunity status and progress over time</li> </ul>
App or IT admin	<ul style="list-style-type: none"> <li>• Provide exceptional IT support to the automation team</li> <li>• Facilitate integration of the various platforms being used by the Automation team</li> <li>• Optional: Configure SSO to the RPA Accelerator</li> <li>• Deploy automations</li> </ul>	<ul style="list-style-type: none"> <li>• Set up SSO for Shibumi in accordance with your company guidelines</li> <li>• Define integration between the RPA Accelerator and one or more automation platforms</li> <li>• Register digital worker within the Accelerator</li> <li>• Ensure information sourced from the automation platform is up-to-date in the Accelerator</li> </ul>



Persona	Goal	Topics to cover
Opportunity owner	<ul style="list-style-type: none"> <li>Submit and build a business case for an opportunity and track its progress through the approval stage gates</li> <li>Measure the results of the opportunity after it has been automated</li> </ul>	<ul style="list-style-type: none"> <li>Create and update an opportunity</li> <li>Add team members</li> <li>Manage activities to support the opportunity implementation</li> </ul>
Automation team member	Collaborate on the activities and milestones for an opportunity implementation	<ul style="list-style-type: none"> <li>Update and view an opportunity</li> <li>Manage activities to support the opportunity</li> </ul>

## Review automation program status

You can review and interpret the up-to-date program data in a single location. You can use this program data to make time-sensitive decisions.

As a corporate executive (Shibumi RPA Accelerator stakeholder), you have the responsibility to define a path towards organizational success while simultaneously avoiding unhealthy risks and obstacles. Often, the automation program is critical to your success strategy. You need the real-time information being aggregated within the RPA Accelerator to ensure that you are able to make timely strategic decisions.

Before you can access the program information, you must create an account. See [Create and manage your account](#) on page 2051.

## Access the program

After creating an account, you will be authenticated into the RPA Accelerator with the program-level content displayed by default.

The program is defined as the homepage. In addition to the home icon, you can use the navigation tree to view and access the program and workstreams. You can access these from any page (both routes are highlighted in the following image).

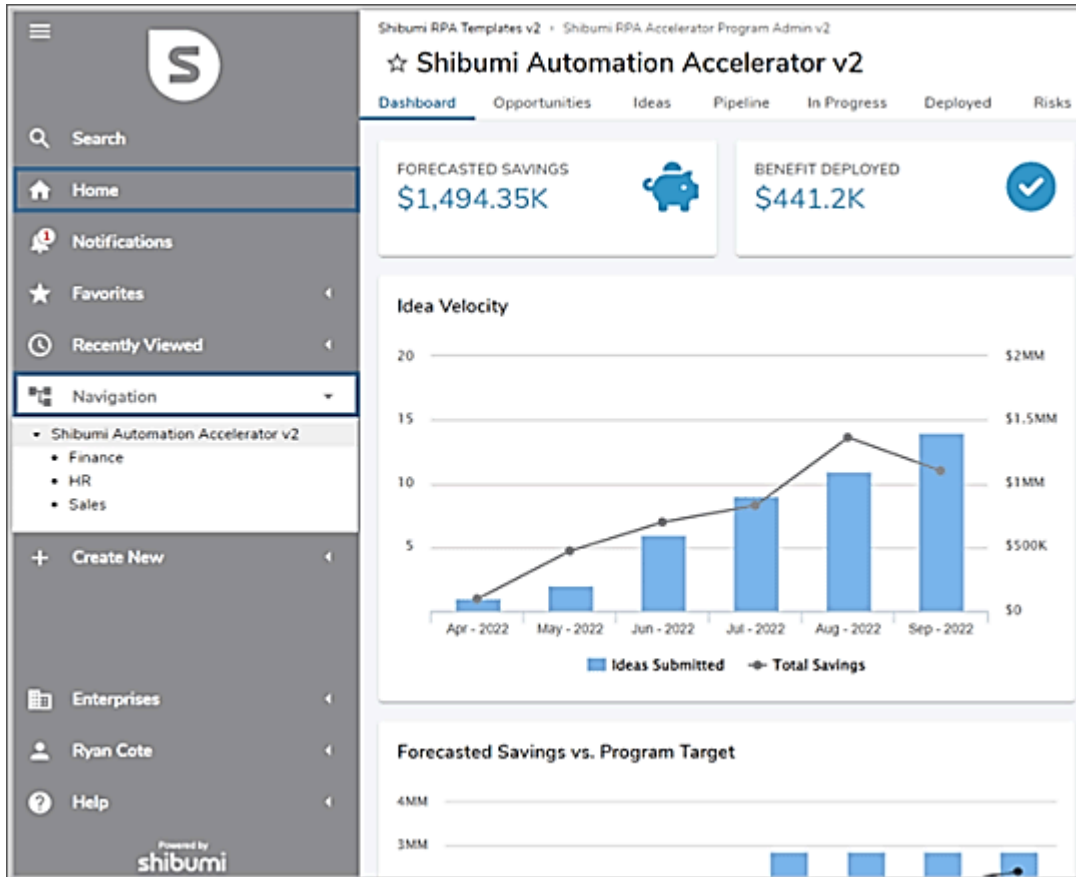

**Note:** When your automation lead sets up the RPA Accelerator, they will have invited you into the program level which triggered the email prompting you to join Shibumi. Permissions are inherited downwards within the RPA Accelerator. Because you were invited into the top-level program, you have the ability to access and edit all unlocked data. However, a user invited into a specific, lower-level opportunity will only be able to edit information specific to that opportunity.

## Review program data

On the program, the dashboard and reporting tabs show key information. You can access the tabs by clicking the tab names (the name of the currently displayed tab is highlighted in blue). By default, you will view the Dashboard tab.

Both the dashboard and reporting tabs include aggregated data from all workstreams and opportunities. The following example shows the dashboard tab content and highlights the dashboard and reporting tabs on the tab bar.

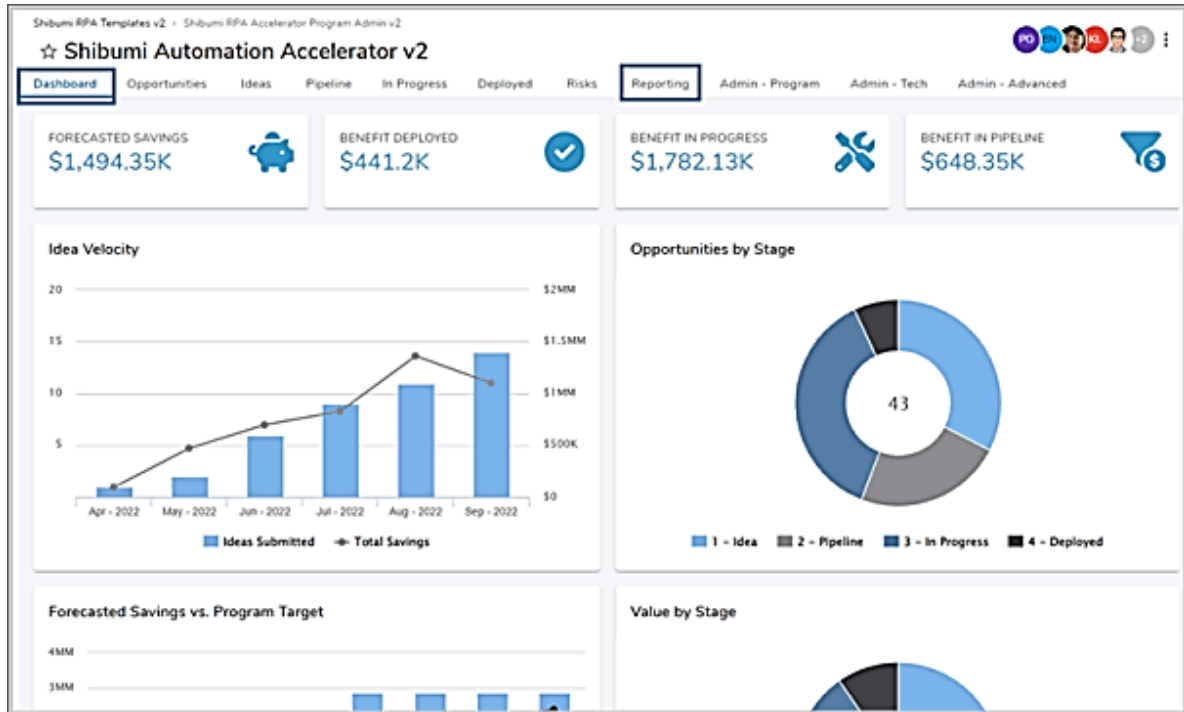

## CoE Manager FAQ

For details and questions on the CoE Manager powered by Shibumi platform, review this FAQ.

### Overview

What is CoE Manager?

CoE Manager (powered by Shibumi) is a cloud-based solution to manage the automation pipeline, delivery, and benefits of the automation program.

Why do I need CoE Manager?

CoE Manager helps you take control of your end-to-end automation lifecycle while accelerating pipeline generation. It helps CoEs to scale automation programs more quickly and efficiently driving core automation deployments and maximize the value (ROI) from your automation investment. CoE Manager elevates the value of the pipeline of automation opportunities to build the business case for additional investment.

I already have an existing app for managing my automation pipeline. Do I still need CoE Manager?

CoE Manager is a purpose-built automation CoE management solution that provides advanced capabilities to drive automation success and comes with a native integration with Automation Anywhere and Power Automate. Soon to come native integrations include UiPath, Blue Prism, Power BI, Jira,

Which compliance standards does CoE Manager support?	<p>ServiceNow, and Tableau. It eliminates the manual overhead required in a homegrown tool and allows CoEs to focus on accelerating the automation pipeline instead.</p> <p>Automation Anywhere and Shibumi are committed to maintaining compliance with key global information security and regulatory standards, including:</p> <ul style="list-style-type: none"><li>• Service Organization Control (SOC) 2, Type 2 certification</li><li>• CSA Cloud Controls Matrix standards compliance</li><li>• EU Model clauses supported</li></ul>
What data retention policies, if any, are in place?	<p>For more information on compliance standards, see <a href="#">Compliance Portal</a>.</p> <p>If you renew your CoE Manager license before your contract expires, your CoE Manager instance is activated again, and your data remains intact. If you do not renew your CoE Manager license after your contract expires, your CoE Manager instance and data is retained in a passive state for a period of 30 days. After 30 days, both the data and the CoE Manager instance is permanently deleted.</p>
What is the software lifecycle policy of CoE Manager?	<p>CoE Manager software lifecycle policy aims to make innovations and enhancements available to you quickly. Through this policy, we provide you predictability, quality, and importantly nondisruptive access to the latest innovations and enhancements so that you can control when and how you want to adopt these enhancements.</p> <p>For more information, see <a href="#">CoE Manager software lifecycle policy</a> on page 2119.</p>
Do I need Automation Anywhere to use CoE Manager?	Yes, you need Automation Anywhere to use CoE Manager base version.
Do I need Automation Anywhere to use CoE Manager Plus?	No. CoE Manager can work independent of Automation Anywhere.
What is the Opportunity Lifecycle enforced by CoE Manager? Can it be modified?	<p>All opportunities in CoE Manager follow a tollgate process comprised of 4 stages given below:</p> <ul style="list-style-type: none"><li>• Stage 1: Idea</li><li>• Stage 2: Pipeline</li><li>• Stage 3: In progress</li><li>• Stage 4: Deployed</li></ul>

These four stages are not configurable if you are on the base version of the CoE Manager. However, if you have the CoE Manager Plus instance, you can customize these by adding new stages as required.

Can I use CoE Manager to manage my automation pipeline outside of Automation Anywhere?

Yes.

Does CoE Manager support single sign-on?

Yes, the CoE Manager supports full SAML or SAMLv2 integration into any IDP or SSO solution such as Okta.

## Get started

How do I activate CoE Manager?

Contact your Automation Anywhere representative if your organization has not yet purchased CoE Manager. Each SKU will represent a unit of one CoE Manager instance for an unlimited number of users.

There are two variants available for CoE Manager, CoE Manager (base version) and CoE Manager Plus. For more information, see [Automation program lifecycle with CoE Manager](#) on page 2046.

How do I access CoE Manager?

Depending on the region from where CoE Manager was purchased, you can access CoE Manager through one of below links.

- [US](#)
- [Europe](#)
- [APAC](#)

---

**Note:** Your account should already be setup in CoE Manager before you logging in. For the account setup process, refer to [Getting started with CoE Manager](#) on page 2050.

---

Is there an integration between CoE Manager and Automation 360?

Yes, you can link up to three Automation 360 Control Room instances to a CoE Manager enterprise instance in the base version. In the CoE Manager Plus instance, you can have an unlimited number of external integrations.

How is data pushed to CoE Manager from the Cloud Control Room?

Once you integrate CoE Manager with the Cloud Control Room, the enabled integration ensures that all the bot executions and transactional data is pushed from the Control Room to CoE Manager every four hours. Each

	<p>push includes the current day's data up to the current time plus the previous day's data in full.</p> <p>See <a href="#">Admin - Tech</a> on page 2065   <a href="#">CoE Manager - Integrate with Cloud Control Room</a> on page 2074.</p>
<p>How is data pushed to CoE Manager from the On-Premises Control Room?</p>	<p>For an On-Premises Control Room, a bot deployment is required to push the data from Control Room to the CoE Manager. You must have a valid license such as a Bot Creator, Bot Runner, or a Citizen Developer to run the bot. To run this bot, you must also add the CoE Manager URL to trusted list.</p> <p>See <a href="#">Admin - Tech</a> on page 2065   <a href="#">CoE Manager - Integrate with On-Premises Control Room</a> on page 2074   <a href="#">CoE Manager activity logs</a>.</p>
<p>Which version of Automation Anywhere is CoE Manager compatible with?</p>	<p>CoE Manager integrates with Automation 360 Cloud Control Room out of the box and integrates with On-Premises environments through a digital worker. For further details, refer to <a href="#">CoE Manager</a> on page 2047.</p>
<p>Does CoE Manager require any third-party software applications?</p>	<p>No.</p>
<p>What are the hardware requirements for CoE Manager?</p>	<p>CoE Manager is a cloud-based solution accessible via a browser and does not need any hardware setup.</p>
<p>Which browsers does the CoE Managersupport?</p>	<p>Google Chrome, Mozilla Firefox, Microsoft Edge, and Safari.</p>
<p>Does CoE Manager support APIs?</p>	<p>Yes. CoE Manager/Shibumi exposes create, read, update, and delete capabilities through its GraphQL API.</p> <p><a href="#">GraphQL API</a></p>
<p>Can I customize dashboards?</p>	<p>Yes. This feature is available in CoE Manager Plus instance.</p>
<p>Can I export the dashboard and reports?</p>	<p>Yes. You can export to Excel or CSV wherever applicable.</p>
<p>Can I add new business units to manage my automation opportunities?</p>	<p>Yes. You can create as many business units and sub-business units as per your requirement.</p>
<p>How do I assign opportunity to a user?</p>	<p>You can assign the opportunity to a user as given below:</p> <ol style="list-style-type: none"><li>1. Open the opportunity.</li><li>2. Click the <b>Avatar</b> icon on the top right.</li><li>3. Enter the email address of the user you want to add.</li></ol>

**4.** Select the role and click **Add**.

<p>I am unable to login into CoE Manager. What do I do?</p>	<p>Contact your CoE Manager administrator to start a password reset.</p>
<p>My organization already uses Shibumi. Can I use CoE Manager with Shibumi license?</p>	<p>No. A new license needs to be purchased from Automation Anywhere to use the CoE manager.</p>
<p>Can I do a bulk upload of automation opportunities?</p>	<p>Yes.</p>
<p>Where do I report a problem with CoE Manager?</p>	<p>For reporting any unexpected or deficient functionality, submit a support ticket to Automation Anywhere.</p>
<p>Can I rename, copy, move, or delete an opportunity?</p>	<p>Yes, you can access these options from the three vertical dots icon on the top right.</p>
<p>Can I assign the idea submitted by me to the operational manager for approval?</p>	<p>No. You can submit the idea for approval but cannot choose who can approve it. As a best practice, add the operational managers into the business unit as RPA approver. They can approve or reject any idea submitted into that business unit.</p>
<p>Can we add one or more users (developers) to the same opportunity?</p>	<p>Yes, you can add one or more users or developers to the same opportunity. To add users to an opportunity, follow the steps mentioned below:</p> <ol style="list-style-type: none"> <li><b>1.</b> In the CoE Manager, navigate to the <b>Opportunities</b> tab.</li> <li><b>2.</b> Click the <b>Opportunity Name</b> to open the opportunity.</li> <li><b>3.</b> Click the <b>Manage Participants</b> icon top right hand corner of the page.</li> <li><b>4.</b> Enter the email address of the user.</li> <li><b>5.</b> Select the role as <b>Collaborator</b> from the roles drop down.</li> <li><b>6.</b> Click <b>Add</b>.</li> <li><b>7.</b> Repeat the above steps to add other users to the opportunity.</li> </ol>
<p>For bot executions, how is the estimated execution time calculated?</p>	<p>For bot executions, the estimated execution time is based on the <b>Bot Start Time</b> and <b>Bot End Time</b> captured in the Control Room.</p>

## CoE Manager software lifecycle policy

CoE Manager software lifecycle policy aims to make innovations and enhancements available to you quickly. Through this policy, we provide you predictability, quality, and importantly

nondisruptive access to the latest innovations and enhancements so that you can control when and how you want to adopt these enhancements.

---

**Note:** The policies mentioned on this page apply to CoE Manager Base and Plus deployments unless where the differences are called out explicitly.

---

## Overview

The software lifecycle policy helps you with change management while providing you with the latest software updates with enhancements in the CoE Manager. Our policy aims to provide faster access to features, bug fixes, and other enhancements for a better customer experience.

The following image shows the advantages of this lifecycle



policy:

## CoE Manager

A new version of the CoE Manager will be released every quarter, that is four CoE Manager updates are released each year. Two of these updates are optional and two updates are mandatory. You can skip the optional updates and update to the next mandatory CoE Manager update.

---

**Note:** Any customizations in the current version are not retained when you update to the new version of the CoE Manager Base. For assistance in updating to the new version of CoE Manager Base, contact Automation Anywhere Support.

---

## CoE Manager Plus

A new version of the CoE Manager Plus variant will be released every quarter, that is four CoE Manager Plus updates are released each year. At the time of renewing your CoE Manager Plus instance, you can update to the latest version. You can treat the other three releases as optional.

To update at the time of renewal, contact Professional Services at Automation Anywhere for support.

---

**Note:** Support is not provided for versions earlier than N-4 releases. The maximum period you can be on a version is one year.

---



## Data retention

If you renew your CoE Manager license before your contract expires, your CoE Manager instance is activated again, and your data remains intact. If you do not renew your CoE Manager license after your contract expires, your CoE Manager instance and data is retained in a passive state for a period of 30 days. After 30 days, both the data and the CoE Manager instance is permanently deleted.

## Activities

Monitor all ongoing automations and pause, stop, and resume them as required. Also, view the Bot Runner (attended or unattended) trigger deployments in queue.

### In-progress activity

The progress details of a bot run contains information such as:

- The name of the bot.
- The action that is currently being performed.
- The line number that is being executed.
- The total number of lines in the bot.
- Status of the bot run (% completed).

The progress details are displayed only when a bot is run on a local device by a user with Attended Bot Runner license.

---

**Note:** From v.29 and later releases, you might see the following changes on the **In progress activity** page:

- You might view activities in the **Failed** status on the **In progress activity** page. Click the **Refresh table** option on the top-right of the table to move such activities to the **Historical activity** page.
- It might take few seconds to view activities in the **Active** status.
- If permissions for users is revoked and then reassigned, such users will be unable to view activities in the **Active** status.

For more information, see [Tips on bot status shown on In progress page](#).

---

Depending on the permissions granted by administrators, as a user, you can view and manage bots and bot folders. With specific permissions, you can perform the following:

View everyone's activity from my folders

With run or schedule permissions on folders, you can view all bot activity started by other users from those folders. This will be a super set in the **View my activity** output.

Manage everyone's activity from my folders

With run or schedule permissions on folders, you can perform management activities, such as **Pause**, **Resume**, and **Stop** on all bot activity started by various users from those folders.

Based on the administrative permissions, you can apply various search parameters to monitor and find the required in-progress activities.

The following table describes various search parameters, their description, and possible values or examples to search the in-progress activities:

Parameter	Description	Possible values and examples
<b>Status</b>	Search for an activity based on its status.	<ul style="list-style-type: none"> <li>• <b>Started</b></li> <li>• <b>Active</b></li> <li>• <b>Paused</b></li> <li>• <b>Unknown</b></li> <li>• <b>Paused for input</b></li> <li>• <b>Pending execution</b></li> <li>• <b>Queued</b></li> </ul>
<b>Automation priority</b>	Search for an activity based on the priority assigned to the automation.	<ul style="list-style-type: none"> <li>• <b>Low</b></li> <li>• <b>Medium</b></li> <li>• <b>High</b></li> </ul>
<b>Current action</b>	Search for an activity based on the current action.	User-specified action name
<b>Current bot</b>	Search for an activity based on the name of a bot that is currently running.	User-specified bot name
<b>Bot</b>	Search for an activity based on the name of a bot.	User-specified bot name
<b>Activity type</b>	Search for an activity based on the activity type selected to run a bot.	<ul style="list-style-type: none"> <li>• <b>Run Bot</b></li> <li>• <b>Import queue files</b></li> <li>• <b>Run bot with queue</b></li> <li>• <b>Export bots</b></li> </ul>
<b>Device</b>	Search for an activity based on the device name on which it is running.	User-specified device name

**Note:** For troubleshooting a bot that stuck on the **In progress activity** page, refer [BOT stuck in In Progress Stage and not able to move it to history](#) or ["BOT stuck in Pending execution Stage and not able to move it to history"](#) on Automation 360 CLOUD and On-Prem environments.

## Actions

You can pause, resume, stop, move, export, and refresh the activities or items by using the actions in the **Historical** page. Hover over the actions icon (vertical ellipsis) to enable and use the following actions:

### Pause checked items

To pause the selected items

<b>Resume checked items</b>	To resume the selected paused items
<b>Stop checked items</b>	To stop the selected items
<b>Move checked items to history</b>	To stop the selected items
<b>Move checked items to history</b>	To move the selected activity from <b>In progress</b> to the <b>Historical</b> page.
<b>Export checked items to CSV</b>	To export selected items to a CSV file based on the following parameters: <ul style="list-style-type: none"><li>• Filters</li><li>• Selection</li></ul>
<b>Refresh table</b>	To refresh the table with updated activity details
<b>Customize columns</b>	To show or hide specific columns

---

**Important:** Multiple workload automation entries equaling the number of devices are shown on the **In-progress activity** page if the work items added to a queue are fewer than the number of devices available in a device pool. For details about a workload automation, see the **View queue details** page on the user device on which the workload automation is deployed.

---

## Historical activity

You can search, view, and run previously created bots in the **Activity > Historical** page.

### Prerequisites

To view historical activities, ensure that you have the following permissions:

- **View my activity**
- **Manage my activity**
- **View activity from user's folder**
- **Manage activity from user's folder**
- **View everyone's activity**
- **Manage everyone's activity**

### Time filter

As a Control Room user, you can use the **Time filter** option to search and view historical activities. You can select the required time duration from the list and view the specific details for the activity. Additionally, you can customize the specific time range to view historical activity details in a specific time range. This filter provides historical activity details based on custom settings, hours, or days (default is **Last 90 days**).

The following image shows the **Time filter** option on the **Historical activity** page:

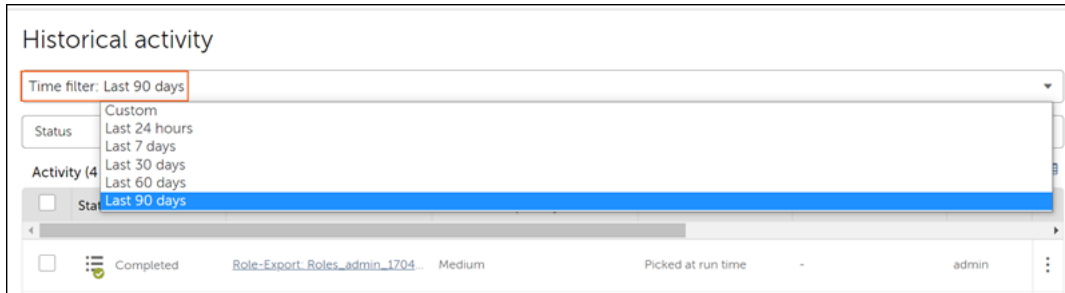

For example, to view historical activities from May 10th to May 15th:

1. Log in to the Control Room with required [permissions](#).
2. Navigate to the **Activity > Historical** page.  
The **Historical activity** page displays.
3. From the **Time filter** drop-down, select the **Custom** option.  
By default, the **Historical activity** page shows the last 90 days of historical activities.
4. Set the date and time:
  - **Start date:** 05-10-2023
  - **Start time:** 10:00 AM
  - **End date:** 05-15-2023
  - **End time:** 10:00 PM
5. Click **Confirm** to confirm the date and time. Otherwise, click **Cancel**.  
The historical activities for the set date and time display as:

### Search parameters

Based on the administrative permissions, you can apply various search parameters to monitor and find the required historical activities. The following table describes various search parameters, their description, and possible values or examples to search the historical activities:

Parameter	Description	Possible values and examples
<b>Status</b>	Search for an activity based on its status.	<ul style="list-style-type: none"> <li>Completed</li> <li>Failed</li> <li>Stopped</li> <li>Timed out</li> <li>Unknown</li> <li>Deploy failed</li> <li>Run failed</li> <li>Pending execution</li> </ul>

Parameter	Description	Possible values and examples
<b>Item name</b>	Search for an activity based on triggered item.	A generic name in specific system format with combination of your bot name, date and time when you run the bot, and username by which you run the bot.  For example, recorder_Recorder_2.7.3-20220527-004608.2
<b>Automation priority</b>	Search for an activity based on the priority assigned to the automation.	<ul style="list-style-type: none"> <li>• <b>Low</b></li> <li>• <b>Medium</b></li> <li>• <b>High</b></li> </ul>
<b>Device name</b>	Search for an activity based on the name of the device on which the activity is running.	User-specified device name
<b>Bot name</b>	Search for an activity based on the name of a bot.	User-specified bot name
<b>User</b>	Search for an activity based on the name of the user who created the activity.	User specified name

## Actions

You can export, refresh, and customize the activity details in the **Activity > Historical** page.

### Export checked items to CSV

To export selected items to a CSV file based on the following parameters:

- Filters
- Selection

### Refresh table

To refresh the table with updated activity details

### Customize columns

To show or hide specific columns

### Important:

- Multiple workload automation entries equal to the number of devices are shown on the **Historical activity** page, if the work items added to a queue are less than the number of devices available in a device pool. For workload automation details, refer to the **View queue details** page on the actual user device on which the workload automation was deployed.
- Historical activity displays only the bots that are processing the work items, while each bot deployment can include multiple work items processed as one activity.

## View completed activity

You can view a list of all completed activities and corresponding information in the **Activity > Historical** page.

### Completed activities

You can use the **Status** search parameter and view all the completed activities in the **Historical** page. You can export data in the table in CSV format, customize columns, and refresh the list in the table for the completed activities.

The retention period of bot execution information in the **Historical** page varies based on the deployment. The retention period for various deployments is listed in the following table:

Deployment	Retention period (Days)
Community Edition	30
Cloud	90
On-Premises	Unlimited (No automatic deletion)

#### Note:

- For On-Premises deployment, the bot execution information beyond the specified retention period is available in the audit log and these logs are not deleted.
- For Cloud deployment, see [Automation 360 Cloud Data Retention Policy](#).

#### Note:

- Specify search parameters for the same column using **OR** operator.
- Specify search parameters for different columns, the system searches using **AND** operator.

You can perform the following actions for a table of completed activities:

- Sort the column items in ascending or descending order.
- Drag-and-drop columns to move or change the column sequence.
- Resize the column width.

### Activity details

The following table describes various details for completed activities:

Parameter	Description	Possible values and examples
<b>Status</b>	Search for an activity based on its status.	<b>Completed</b>

Parameter	Description	Possible values and examples
<b>Item name</b>	Search for an activity based on triggered item.	A generic name in specif system format with combination of your bot name, date and time when you run the bot, and username by which you run the bot.  For example, recorder_Recorder_2.7.3-20220527-004608.2
<b>Automation priority</b>	Search for an activity based on the priority assigned to the automation.	<ul style="list-style-type: none"> <li>• <b>Low</b></li> <li>• <b>Medium</b></li> <li>• <b>High</b></li> </ul>
<b>Device name</b>	Search for an activity based on the name of the device on which the activity is running.	User-specified device name
<b>Bot name</b>	Search for an activity based on the name of a bot.	User-specified bot name
<b>User</b>	Search for an activity based on the name of the user who created the activity.	User specified name
<b>Started on</b>	The date and time when the activity was started.	For example, 19:01:24IST 2022-06-06
<b>Ended on</b>	The date and time when the activity was ended.	For example, 19:01:40IST 2022-06-06
<b>Last modified</b>	The time when activity was last modified.	For example, 57 minutes ago or 3 weeks ago
<b>Modified by</b>	The name of the user who changes the activity.	User-specified name

## Actions

You can view any individual item using the following action:

View

View details of the completed activity.



## Scheduled activities

Schedule bots to run on unattended Bot Runners from the **Scheduled** tab in the Control Room.

### Overview

Edit, view, activate, deactivate, delete a schedule, export selected activity details to a CSV file, and search by activity name.

Perform the following actions on a column:

- Click a column to sort it in ascending or descending order.
- Use a drag-and-drop operation to move the column left or right.
- Move the mouse cursor to the end of the column and drag to re-size.

### Schedule Actions

Perform the following tasks on an individual Schedule by moving your mouse over the **Actions** icon.

### Schedule a bot

Schedule a bot to run at a specific time.

Ensure you are logged in to the Control Room as the administrator or a user with the following permissions:

- Schedule my bots to run
- Schedule permission at folder level for specific bots and their dependencies
- Access to run-as users (Bot Runners) that you can add to the schedule

---

**Note:** Automation will fail in the following cases:

- If any of the bot dependencies are missing.
- If you do not have folder privileges on the dependencies.
- If you do not have the scheduling permissions.

- 
1. Navigate to **Manage > Scheduled**.
  2. Click **Run bot**.
  3. Click **Schedule bot**.
  4. Add the scheduling details for the bot.

---

**Note:** The value of the **Start date** is always later than or equal to the current date. If the start date is the current date, the scheduled time cannot be less than the current time.

---

---

Option	Definition
<b>Run once</b>	<p>Use this option to run the bot once on a given day at x hour. When you select this option, set the start date and start time.</p> <p><b>Start date</b>                      Default value is the current day.</p> <p><b>Start time</b>                      Default value is roundup to the next half-hour.</p> <p><b>Time zone</b>                      User's system time zone</p>

Option	Definition
<p><b>Run repeatedly</b></p>	<p>Use this option to schedule your bot to run every x minutes or hour on a given day. When you select this option, select the start date, start time, end date, and end time.</p> <p>Start date                      Enter the date when you want the schedule to start running the bot. Enter the date either manually in YYYY-MM-DD format or by using the pop-up calendar. The default value of the <b>Start date</b> field is set to the current day of your local system.</p> <p>End date                         Enter the date when you want the schedule to end. The default value of the <b>End date</b> field is blank.</p> <p>Start time                        Enter the <b>Start time</b> using the drop-down list to set the time value when you want your schedule to start. The list contains predefined time values in the 12-hour format at intervals of 15 minutes. You can also manually set the time value in the 12-hour format. However, this is not available for the selection in the drop-down list. The default value of the Start Time field is rounded off to the next half-hour that is 15 minutes away. For example, if the current time is 11:22 AM, it will display 12:00 PM.</p> <p>Repeat every                      Select the Repeat every option to</p>

- In the **Missed schedule setting** section, select **Redeploy the schedule again** to redeploy a schedule that was missed because of Control Room shut down.

**Note:** To ensure a successful deployment when using the **Redeploy the schedule again** option, you must start the compiler service before you restart the Control Room services.

When the **Redeploy the schedule again** option is selected, schedules missed because of Control Room shut down are automatically redeployed after the Control Room is restarted. An audit log entry is also added showing the Event type as `Schedule misfired`.

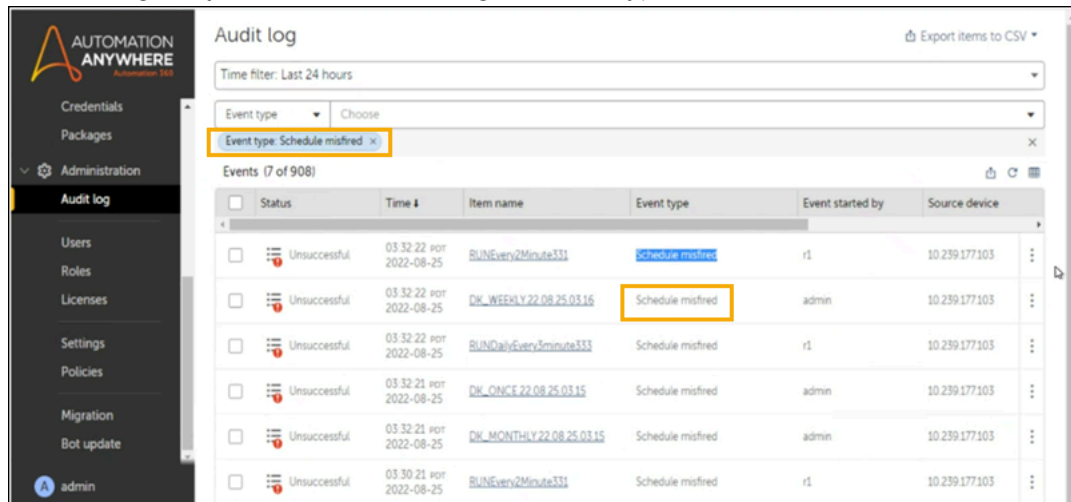

- Select the bot to schedule.
  - Latest version: Click **Latest version** tab to select the latest version of the bot.
  - Labeled version: Click **Production version** tab to select the labeled version of the bot.

Available bots are displayed along with any **Input values** and dependencies. If the production label option is selected for the parent bot, the corresponding dependent bots with the production label are also automatically selected. If any of the dependent bots do not have the production label applied, the latest version of the bot is selected.

- Select the Bot Runner user from the **Available bot runners** list. Use the following options to define the number of Bot Runners to use:
  - All bot runners:** Select to use all the selected Bot Runners.
  - Custom number of bot runners:** Select to customize the number of Bot Runners to use from the list of selected Bot Runners. The Control Room will then automatically select the configured number of Bot Runners from the list of available Bot Runners.

**Note:** If a run-as user (Bot Runner) does not appear in the list, ensure the user scheduling the bots is assigned a role that provides access to the appropriate run-as users.

- Click the right arrow (→) to add your selection.
- Optional: Select **Device Pools**. Select the pool from the list of available device pools. If any of the selected run-as users does not have the bot running device, a device pool is required. You can select up to 25 device pools per schedule.
- Optional: Click the up or down arrow to set the selected device pools in preferred order.

When a bot is deployed, the system selects the first available device based on the order in which you organized the device pools. If none of the devices are available at the time of deployment, the bot is queued.

**11.** Enter the **Name**.

**12.** Optional: Enter a description.

**13.** Select the **Automation priority** from the **General** tab.

Set the priority to high, medium, or low based on your requirements for resource optimization. The default permission is set to medium.

**14.** Click **Schedule bot**.

The **Schedule bot** option remains disabled until all the required items, such as bots, schedule details, and devices are selected.

The number of times a bot is deployed depends on the run-as users (Bot Runners) selected for the schedule. Consider the following scenarios:

- The number of run-as users selected is two, and both the users have the bot running device: The bot is deployed twice on the two run-as users and their bot running devices.
- The number of run-as users selected is three, and only one of the users has the bot running device. In this case, you must select the device pool. If the device pool has only two devices, the bot is deployed three times on both the devices in the device pool and also on the bot running device of the third user.
- The number of run-as users selected is three, and none of the three users has the bot running device: In this case, you must select the device pool. If the device pool has only two devices, the bot is deployed twice on both the devices in the device pool, and the third request for bot deployment is queued. The bot is deployed only when a device becomes available in the device pool.
- The number of run-as users selected is two, and none of the two users have the bot running device: In this case, you must select the device pool. If the device pool has four devices, the bot is deployed twice on any available two devices in the device pool.

---

**Note:** For schedules without a device pool, when one or more active run-as user devices are unavailable or disconnected, the bot deployment fails for all the run-as users in the schedule.

---

Related concepts

[Bot permissions for a role](#) on page 1763

Assign bot permissions when creating a role with the View my bots feature permission.

Related tasks

[Edit a scheduled activity](#) on page 2135

Make changes to a schedule so that the automation is not skipped.

[Delete a scheduled activity](#) on page 2138

Delete a scheduled activity.

## Change ownership of scheduled activity

A user who schedules an automation is the owner of that activity. If the user account of the owner is deactivated or is no longer available, change the ownership of that activity to ensure that it can be managed by another existing Control Room user.

Ensure you are logged in to the Control Room as the administrator or a user with the following permissions:

- Access to the selected bot (same as when the user tries to schedule a bot).  
See [Schedule a bot](#) on page 2129.
- Access to the selected **Run as users** (same as when the user tries to schedule a bot).
- Access to the device pool (if it was selected in the schedule).

1. Navigate to **Manage > Scheduled**.
2. From the **Activity** table, select the scheduled activity for which you want to change ownership.

You can select multiple activities or select the **Check all** check box to select all the available activities. For more information on how the change in ownership of multiple activities works, see [How changing ownership of multiple activities works](#) on page 2134.

3. Click the **Change owner** icon at the top of the table.
4. Click **Yes, change** to confirm.
5. In the **Change owner** screen that opens with all the available users, select the user that you want to transfer the ownership to, and click the right arrow (→).

The following video shows how to change the owner of a scheduled activity:

6. Click **Confirm**.  
The ownership of the selected activity is changed or transferred to the specified user. You can verify the changes in the **Owned by** column (scroll across the table) and the audit log will contain the details of the original and changed owner of the scheduled activity.

## How changing ownership of multiple activities works

A Control Room administrator or a user with the necessary permissions can change or transfer the ownership of multiple scheduled activities. However, ownership of multiple or all the selected activities cannot be changed at the same time.

An alert is displayed when the ownership of one or more of the selected activities cannot be changed. Review examples where the ownership of all the selected activities cannot be changed at the same time.

## Multiple owners with a varied number of scheduled activities

Consider an example where you want to change the ownership of 10 scheduled activities from 3 different users:

- Jane: owns 3 activities
- Derek: owns 5 activities
- Bob: owns 2 activities

When you select all the activities on the **Scheduled activity** page and click **Change owner**, an alert is displayed that the ownership of activities owned by Derek will be changed while the ones owned by Jane and Bob will be skipped.

## Multiple owners with equal number of scheduled activities

Consider an example where you want to change the ownership of 12 scheduled activities from three different users:

- Lara: owns 4 activities
- Chung: owns 4 activities
- Deb: owns 4 activities

When you select all activities on the **Scheduled activity** page and click **Change owner**, an alert is displayed that the ownership of activities owned by one of the three users will be changed while the ones owned by other two users will be skipped.

## Edit a scheduled activity

Make changes to a schedule so that the automation is not skipped.

Ensure that you are logged in to the as the administrator.

Edit the scheduled activity in order to:

- Change the schedule type, date, or time.
- Add or remove Bot Runners from the schedule.
- Change the retry settings.

**Note:** The system redeploys the bots and dependencies only if there are updates to the bots or its dependent files.

1. Hover over the **Actions** icon for the scheduled in the Activity table.
2. Click the **Edit** icon. 
3. Make changes to the schedule details, bots, and devices, as required.

Option	Definition						
<b>Run once</b>	Use this option to run the bot once on a given day at x hour. When you select this option, set the start date and start time. <table data-bbox="873 1520 1427 1772"> <tr> <td><b>Start date</b></td> <td>Default value is the current day.</td> </tr> <tr> <td><b>Start time</b></td> <td>Default value is roundup to the next half-hour.</td> </tr> <tr> <td><b>Time zone</b></td> <td>User's system time zone</td> </tr> </table>	<b>Start date</b>	Default value is the current day.	<b>Start time</b>	Default value is roundup to the next half-hour.	<b>Time zone</b>	User's system time zone
<b>Start date</b>	Default value is the current day.						
<b>Start time</b>	Default value is roundup to the next half-hour.						
<b>Time zone</b>	User's system time zone						

Option	Definition
<p><b>Run repeatedly</b></p>	<p>Use this option to schedule your bot to run every x minutes or hour on a given day. When you select this option, select the start date, start time, end date, and end time.</p> <p>Start date                      Enter the date when you want the schedule to start running the bot. Enter the date either manually in YYYY-MM-DD format or by using the pop-up calendar. The default value of the <b>Start date</b> field is set to the current day of your local system.</p> <p>End date                         Enter the date when you want the schedule to end. The default value of the <b>End date</b> field is blank.</p> <p>Start time                        Enter the <b>Start time</b> using the drop-down list to set the time value when you want your schedule to start. The list contains predefined time values in the 12-hour format at intervals of 15 minutes. You can also manually set the time value in the 12-hour format. However, this is not available for the selection in the drop-down list. The default value of the Start Time field is rounded off to the next half-hour that is 15 minutes away. For example, if the current time is 11:22 AM, it will display 12:00 PM.</p> <p>Repeat every                     Select the Repeat every option to</p>



**Note:** An alert is displayed if you select a **Start date** or **Start time** that is earlier than your device time.

---

4. In the **Missed schedule setting** section, select **Redeploy the schedule again** to redeploy a schedule that was missed because of Control Room shut down.
- 

**Note:** To ensure a successful deployment when using the **Redeploy the schedule again** option, you must start the compiler service before you restart the Control Room services.

---

When the **Redeploy the schedule again** option is selected, schedules missed because of Control Room shut down are automatically redeployed after the Control Room is restarted. An audit log entry is also added showing the Event type as `Schedule misfired`.

5. Select **Device pools**.  
Select the pool from the list of available device pools.
6. Optional: Click the up or down arrow to set the selected device pools in preferred order.
7. Optional: Change the **Automation priority** from the **General** tab.
8. Click **Schedule bot**.

The **Schedule bot** option remains disabled until all the required items, such as bots, schedule details, and devices are selected.

The number of times a bot is deployed depends on the run-as users (Bot Runners) selected for the schedule. Consider the following scenarios:

- The number of run-as users selected is two, and both the users have the bot running device: The bot is deployed twice on the two run-as users and their bot running devices.
- The number of run-as users selected is three, and only one of the users has the bot running device. In this case, you must select the device pool. If the device pool has only two devices, the bot is deployed three times on both the devices in the device pool and also on the bot running device of the third user.
- The number of run-as users selected is three, and none of the three users has the bot running device: In this case, you must select the device pool. If the device pool has only two devices, the bot is deployed twice on both the devices in the device pool, and the third request for bot deployment is queued. The bot is deployed only when a device becomes available in the device pool.
- The number of run-as users selected is two, and none of the two users have the bot running device: In this case, you must select the device pool. If the device pool has four devices, the bot is deployed twice on any available two devices in the device pool.

---

**Note:** For schedules without a device pool, when one or more active run-as user devices are unavailable or disconnected, the bot deployment fails for all the run-as users in the schedule.

---

Related tasks

[Schedule a bot](#) on page 2129

Schedule a bot to run at a specific time.

[Delete a scheduled activity](#) on page 2138

Delete a scheduled activity.

## Delete a scheduled activity

Delete a scheduled activity.

Ensure that you are logged in to the as the administrator.

To delete a scheduled activity:

1. Hover over the **Actions** icon for the scheduled in the Activity table.
2. Click **Delete**.  
Confirm or cancel.
3. Click **Yes, delete**.

Related tasks

[Schedule a bot](#) on page 2129

Schedule a bot to run at a specific time.

[Edit a scheduled activity](#) on page 2135

Make changes to a schedule so that the automation is not skipped.

## Automatically select the number of Bot Runners users

Scale your automation by allowing Automation 360 to automatically select the Bot Runner users for specific tasks.

You can enable Automation 360 to automatically select the Bot Runner users for specific tasks:

- Scale automations easily
- Run bots concurrently
- Use resources efficiently

You can optimize Bot Runner users by selecting how many Bot Runners you want to use to run tasks concurrently. The system automatically selects the number of Bot Runner users that are available for the tasks. As a result, when you run or schedule an automation, the available run-as users are automatically selected from the specified list.

Let us consider the following example:

- You have three bots: Bot 1, Bot 2, and Bot 3.
- You have two Bot Runner licenses: bruser 1 and bruser 2.

You can use any of the Bot Runner users to run the three bots by performing the following procedure:

1. Create schedules to run these bots.
2. Select these bots to run.
3. Select both Bot Runner users.
4. Specify **Custom number of bot runners** to use as 1 so that one of the Bot Runners is used to run these bots.

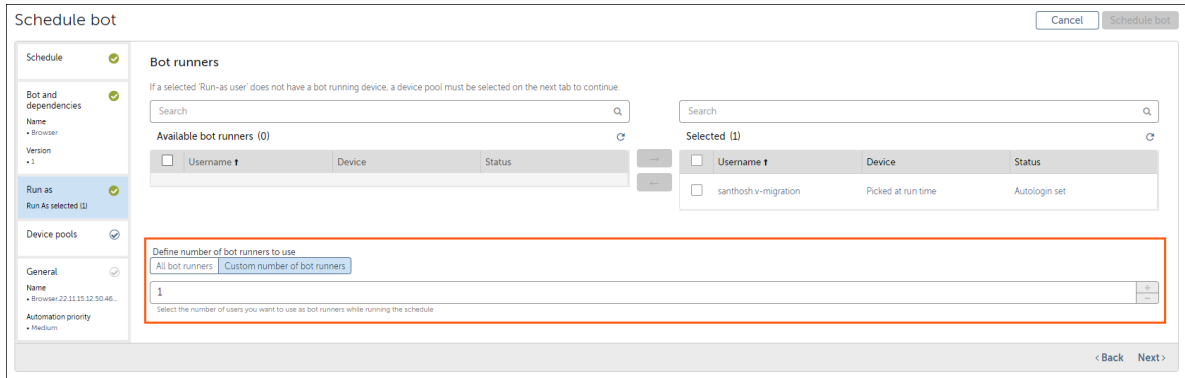

See the following video on how Automation 360 automatically selects the Bot Runner users for specific tasks:

To customize Bot Runners, see [Schedule a bot](#) on page 2129.

## Event triggers

An event trigger is a predefined action that runs an associated bot. All the bots with event triggers are listed under the **Event triggers** tab.

### Available role permissions for event triggers

A Control Room administrator must provide the required permissions to ensure the associated users can access event triggers. The following table lists the available permissions:

Permission	Description
<b>View event triggers</b>	Select this permission if the users can only view the event triggers but not run or delete them.
<b>Manage event triggers</b>	<p>The <b>Manage event triggers</b> permission is available only if <b>View event triggers</b> is enabled. Select this permission if the users can:</p> <ul style="list-style-type: none"> <li>Add an event trigger</li> </ul> <hr/> <p><b>Note:</b> Users associated with the Bot Creator license cannot add event triggers in the private workspace.</p> <hr/> <ul style="list-style-type: none"> <li>Run a bot with event trigger</li> <li>Delete event trigger</li> <li>Associate an event trigger with a Bot Runner (attended or unattended) user or a role that is associated with one or more Bot Runner (attended or unattended) users.</li> </ul>

## Supported actions

In Automation 360, click **Manage > Event triggers** to view the table that lists all the available bots with event triggers. The following actions are available for this table.

- Enter a keyword from the `BOT_PATH` in the **Search** field to find an event trigger.  
For example, if the bot path of an event trigger is `Bots\file--created--event--Salesinfo`, enter `Sales` in the **Search** field to find this event trigger.
- Use the **Run with event triggers** option to add event triggers.

[Adding event triggers](#) on page 2141

- User can also delete any associated (active or inactive) event triggers.
- View the trigger status, bot path, user name, role, and modification details.

**Optional:** On the specific device, to view trigger details:

1. Open the **Task Manager > Details** tab.
2. Right-click on the column in the list of app entries.
3. Click **Select columns**.
4. Click **Command Line** item to enable the column.

Verify that the following Java processes are running to confirm that the triggers are active:

- Bot agent or node manager

---

**Note:** The name for this is **NodeManager.exe**

---

- Trigger listener

---

**Note:** The name for this is **TriggerListener.exe**

---

**Note:** When you install or update the Bot Agent, you must add the above-mentioned `.exe` files to the trusted list.

---

**Optional:** To confirm that **NodeManager.exe** or **TriggerListener.exe** are associated with a node manager or trigger listener, respectively:

1. Copy the details of this task  
Press **CTRL+C** after you clicked the task name.
2. Paste the details to a notepad.
3. Verify the jar files.

---

**Note:** Node manager is **node-manager.jar** and the trigger listener is **triggerlistener.jar**

---

Consider a scenario where triggers are associated with a Bot Runner user who logs off or signs out of a device. This Bot Runner user must log in to the Control Room on that device in order to activate the associated triggers.

Related concepts

[Adding a trigger to run a bot](#) on page 2286

Add triggers that can automatically run the selected bot whenever a specific event occurs. For example, clicking a specific button or using a combination of keystrokes.

## Adding event triggers

Any bot with triggers can be associated with users or role to enable event trigger. Control Room user (or role) with **Manage event triggers** permission can add event triggers.

All the bots a user creates are displayed in the Private tab. When the user checks in a bot to a public folder, it is displayed in the **Public** tab.

A private event trigger is created when a user with the Manage event triggers permission adds a trigger to a bot but does not check in this bot to a public folder. Private event triggers are listed under the **Manage > Event triggers** page. However, if the user checks in the associated bot to a public folder, it is no longer displayed under the **Event triggers** page.

1. Click **Automation**.
2. Click **Run bot**.
3. Click **Run with event triggers**.
4. Select the bot.
  - Latest version: Click **Latest version** tab to select the latest version of the bot.
  - Latest version: Click **Production version** tab to select the labeled version of the bot.

If the production label option is selected for the parent bot, the corresponding dependent bots with the production label are also automatically selected. If any of the dependent bots do not have the production label applied, the latest version of the bot is selected.

5. Click the right arrow (→) to add your selection.
6. Click **Next**.
7. Select one of the following to link the bot:

Option	Description
<b>Roles</b>	Select the custom role you have created.
<b>Users</b>	Select the Bot Runner (attended or unattended) user who is associated with this custom role.

8. Click the right arrow (→) to add your selection.
9. Select the **Automatically deploy to unattended Bot Runners** option.

**Note:** When you select this option, triggers will automatically deploy for unattended Bot Runner users, eliminating the need for users to manually log into their default system. Additionally, if their default system or Bot Agent gets rebooted, the system will automatically log back as the user, and deploy the triggers.

10. Click **Next**.
11. Click **Run with event triggers**.

The selected bot is added to the **Event triggers** page under **Activity**.

Related concepts

[Working with bots](#) on page 2279

Depending on the license and permission assigned to you, you can perform various bot operations and access the private and public workspaces in the Control Room.

## Linking event triggers to a Bot Runner

An Control Room administrator or users with **Manage event triggers** permission can add event triggers by associating users or roles with a bot. This enables Bot Runner users to trigger the bot when they perform a specified event.

When a user with a Bot Creator license creates a bot and checks it in a repository, the bot is available in the **Public** workspace. An Control Room administrator or user with **Manage event triggers** permission and access to that **Public** workspace can then link an event trigger.

A Bot Runner (attended or unattended) user must log into the Control Room to start the event trigger, and can choose to log out after that event trigger is activated.

Optionally, administrator can also enable the auto-login feature in the Control Room for unattended Bot Runner users.

See [Configure auto-login settings](#) on page 1804.

**Note:** Among all the triggers, you can associate any trigger only with a user who has a Bot Runner license. Also, for a user with unattended Bot Runner license, if you associate triggers such as **Hot key**, **Interface**, or **Window**, the following conditions apply:

- The default device must not be in the logged-off or locked state.
- The user must be logged in to the device to perform the predefined task that can trigger the bot.

1. On the left pane, click **Automation**.
2. Click **Run bot**.
3. Click **Run with event triggers**.
4. Click the right arrow (→) to add your selection.
5. Click **Next**.
6. Select one of the following to link the bot:

Option	Description
<b>Roles</b>	Select the custom role you have created.
<b>Users</b>	Select the Bot Runner (attended or unattended) user who is associated with this custom role.

7. Click **Add event triggers**.

When the Bot Runner user logs in to Control Room and performs the trigger event, the bot is deployed. The event trigger will continue to work until one of the following changes occur:

- Associated bot is deleted from the public workspace.
- The linked Bot Runner user account is deleted.
- The default device is logged off.
- The default device enters the sleep or hibernate mode.

## Audit log

View audit logs and details to record user activities.

Audit Log displays a read-only table of records of actions performed by users. These log records are searchable and exportable. Audit logs include both **Successful** and **Unsuccessful** actions attempted.

### Actions

The following Audit log actions are enabled:

---

**Note:** Use your cursor to roll over the action button icons to identify specific functions.

---

Time filter	Users select from preset time filters or configure a custom time filter for log entries to view. The default time filter setting is <b>Last 24 hours</b> .
Search	Search the records. Select additional search filter criteria from the drop-down menu. <hr/> <b>Tip:</b> To search the exact phrase, enclose the search phrase within double quotes (for example, "Taylor-Finance-564").
Export checked items to CSV	Export the data to a CSV file based on filters and or selections.
Refresh	Refresh and view the updated status.
Customize columns	Show or hide specific columns.
View	To view details of a table entry, mouse over the entry to expand and click <b>Audit details</b> .

### Audit log table

View the following audit details in the table.

Table item	Description
Status	Shows action status.
Time	Shows the date and time of the action performed.
Event type	Shows the type of action performed.
Item name	Shows the entity on which action was performed.
Event started by	Shows the user that performed the action.

Table item	Description
Source device	Shows the device or machine name or IP address that was used to perform the action.
Source	Shows the component: Control Room, Enterprise Client or API, from where the action originated or was performed.
Request ID	Shows the unique identity number assigned to a specific set of user actions.
Results	Shows the reason of failure for unsuccessful audit log entries.

## Audit events list

Review the list of audit events to identify the type of audit entries that are logged in the Control Room for Automation 360.

### General audit entries

The following table shows a list of general audit entries and their descriptions (listed alphabetically):

Audit entries	Description
Accept end user license agreement	This action is logged when the user accepts the license agreement.
Activate automation	This action is logged when the user activates the schedule.
Add credential	This action is logged when the user creates credentials.
Add Global value	This action is logged when the user creates a new global value.
Add locker	This action is logged when the user creates the locker.
Add manual dependency	This action is logged when the user adds manual dependency to a bot.
Add MFA token	This action is logged when the user adds the MFA (multi-factor authentication) token.



Audit entries	Description
Allocate license	This action is logged when the user creates a user with a particular license (such as Bot Creator or Bot Runner) and when the user changes the license from Bot. This action is logged when the user creates a user with a particular license (such as Bot Creator or Bot Runner) and when the user changes the license from Bot Creator to Bot Runner and vice versa.
API-Key duration	This action is logged when the user changes the duration for how long a generated API-Key is valid to authenticate users.
Audit error	This action is logged when an audit error occurs.
Audit migration finished	This action is logged when migration is completed.
Audit migration started	This action is logged when migration is started.
Audit unset activity type	This action is logged when there is an unset activity type.
Auto-login credentials not set	his action is logged when auto-login credentials have not been set for the user.
Automation complete	This action is logged when a schedule completes.
BOT_AGENT_BULK_INSTALLATION	This action is logged when the user changes the option to generate a registration key to perform bulk installation of the Bot Agent on multiple devices.
Bot runner session	This action is logged when a Bot Runner session occurs.
Bot saved	This action is logged when a user saves a bot or modifies a bot that is checked in to a Git repository.
Bot sent to device	This action is logged when a bot is sent to a device.
Bot sent to device failed due to configuration update	This action is logged when a bot fails to be sent to a device because a device configuration update is in progress.
Bot validation setting	This action is logged when a user sets the bot validation setting.
Callback request	This action is logged when a callback is requested.

Audit entries	Description
Callback URL validation failed	This action is logged when the callback URL is invalid and does not appear on the trusted list.
Certificate authentication configuration create	This action is logged when a user creates certificate authentication settings.
Certificate authentication configuration update	This action is logged when a user modifies the certificate authentication configuration.
Certificate authentication TLS host configuration create	This action is logged when a user creates a certificate authentication TLS host server configuration.
Certificate authentication TLS host configuration reinstall	This action is logged when a user reinstalls a certificate authentication TLS host server configuration.
Certificate authentication TLS host configuration update	This action is logged when a user modifies a certificate authentication TLS host server configuration.
Change settings	This action is logged when the user changes any setting such as On to Off, or Off to On.
Check in	This action is logged when a check in occurs.
Check in request	This action is logged when a check in is requested.
Check out	This action is logged when a checkout occurs.
Check out request	This action is logged when a check out is requested.
Client log in	This action is logged when a client logs in.
Clone	This action is logged when a user clones an object.
Cloud burst mode	This action is logged when a cloud burst occurs.
Cloud-enabled provisioning success	This action is logged when a cloud is successfully provisioned.
Cloud-enabled provisioning failure	This action is logged when cloud provisioning fails.
Configure credential vault	This action is logged when a user configures a credential vault.
Connect credential vault	This action is logged when a user connects a credential vault.

Audit entries	Description
Control Room configurations	This action is logged when a user edits general configuration settings to the Control Room.
Control Room upgrade available	This action is logged when an upgrade to the Control Room is available.
Control Room upgrade email notification	This action is logged when an email has been sent to indicate a successful upgrade to the Control Room.
Control Room upgrade failure	This action is logged when an upgrade to the Control Room has failed.
Control Room upgrade success	This action is logged when an upgrade to the Control Room has completed successfully.
Create automation	This action is logged when the user creates a new schedule or runs a bot with a queue in workload management.
Create bot	This action is logged when the user creates a bot for the first time.
Create domain	This action is logged when the user creates a new domain.
Create draft of queue	This action is logged when the user saves the work item as draft in workload management.
Create folder	This action is logged when the user creates a new folder.
Create learning instance	This action is logged when the user creates a new learning instance.
Create package	This action is logged when the user creates a new package.
Create proxy credentials	This action is logged when the user creates new proxy credentials.
Create queue	This action is logged when the user creates a new queue in workload management.
Create queue failed	This action is logged when a queue creation fails.
Create role	This action is logged when the user creates a new role.
Create user	This action is logged when a new user is created.
Create work item	This action is logged when new work items are added to a queue.
Create work item failed	This action is logged when new work items failed to add to a queue.

Audit entries	Description
Credential vault settings	This action is logged when a user defines credential vault settings.
Deactivate automation	This action is logged when the scheduled automation is deactivated.
Delete automation	This action is logged when the user deletes the schedule.
Delete bot	This action is logged when the user deletes a bot.
Delete credential	This action is logged when the user deletes credentials.
Delete device	This action is logged when the user deletes a device.
Delete file	This action is logged when the user deletes a file.
Delete folder	This action is logged when the user deletes a folder.
Delete Git settings	This action is logged when the user deletes Git repository settings in the Control Room.
Delete Global value	This action is logged when the user deletes the global value.
Delete learning instance	This action is logged when the user deletes an existing learning instance.
Delete locker	This action is logged when the user deletes a locker.
Delete MFA token	This action is logged when the user deletes the MFA (multi-factor authentication) token.
Delete package	This action is logged when the user deletes a package.
Delete proxy credentials	This action is logged when the user deletes proxy credentials.
Delete queue	This action is logged when the user deletes the queue in workload management.
Delete queue failed	This action is logged when the user fails to delete a queue.
Delete role	This action is logged when the user deletes roles from the system.
Delete tenant BLM clean up	This action is logged when the Bot Lifecycle Management (BLM) performs clean up for a deleted tenant.

Audit entries	Description
Delete user	This action is logged when the user delete users from the system.
Delete work item	This action is logged when the user deletes the work item from the queue.
Delete work item failed	This action is logged when the user fails to delete work items in a queue.
Deployment automation	This action is logged when a bot is deployed to run.
Deployment queued	This action is logged when a deployment has been queued to run.
Device acquired by user	This action is logged when the device has been acquired by the user.
Device configuration update initiated	This action is logged when the user initiates the device configuration update.
Device details updated	This action is logged when the device details have been successfully updated.
Device not available to acquire	This action is logged when the device is unavailable to be acquired by the user.
Device registered	This action is logged when the user registers a device.
Device update configured	This action is logged when the user changes the option to install or update the Bot Agent software.
Device type update settings	This action is logged when the settings of a device type are updated.
Disable package	This action is logged when the user disables a package.
Disable user	This action is logged when the user disables another user in the system.
Domain credential reset	This action is logged when the user resets or reconnects to the Active Directory domain from the settings page.
Download bot	This action is logged when a user downloads a bot.
Download bot finished	This action is logged when the Bot Store completes downloading a bot.
Download file	This action is logged when a user downloads a file.
Edit bot	This action is logged when the user renames a bot.

Audit entries	Description
Edit domain	This action is logged when the user modifies a domain.
Edit learning instance	<p>This action is logged when the user edits any of the following settings of an existing learning instance:</p> <ul style="list-style-type: none"> <li>• Edits the name</li> <li>• Edits or adds a description</li> <li>• Uploads staging documents</li> <li>• Adds new fields</li> <li>• Edits new group setting</li> <li>• Edits default validations groups setting</li> </ul>
Edit role	This action is logged when the user modifies a role.
Edit role - folder permissions	This action is logged when a user changes the folder permissions of an existing role.
Edit settings	This action is logged when the user modifies settings.
Edit user	This action is logged when the user modifies another user.
Elasticsearch backup	This action is logged when the user provides a backup IP address in the Elasticsearch disaster recovery backup cluster.
Elasticsearch delete index	This action is logged when the user deletes an index from the Elasticsearch.
Email notification	This action is logged when email notification connection or authentication fails.
Email notification settings	This action is logged when the user modifies email notification settings.
Empty pools	This action is logged when there are empty pool IDs.
Enable package	This action is logged when the user enables a package.
Enable user	This action is logged when the user enables another user in the system.
Execute automation	This action is logged when the user executes a bot.
Export bots	This action is logged when the user exports bots and is available for download on the <b>Historical activity</b> page.

Audit entries	Description
Export domain	This action is logged when the user exports any of the domains from the IQ Bot application.
Export learning instance	This action is logged when the user exports a learning instance (.iqba file) through the migration utility.
Export queue	This action is logged when the user exports a queue from workload management.
Export request	This action is logged when the user submits a request to export automations.
Export to csv	This action is logged when the user exports data to a csv.
Failed to acquire user or device	This action is logged when the device or user is unavailable to be acquired.
Failsafe status updated	This action is logged when a failsafe status has been updated.
File upload settings	This action is logged when the user changes the file upload settings to restrict or allow the upload of executable files to a malicious file upload.
First Administrator settings	This action is logged when a user configures the first Administrator user in the Control Room.
Force unlock bot	This action is logged when a user unlocks a bot.
GDPR report	This action is logged when a user enables GDPR (General Data Protection Regulation) reporting.
Generate API-Key	This action is logged when an Admin user generates an API key from the <b>My Settings</b> page, which can be used to obtain an authentication token. This audit entry shows the generate API key status as either Successful or Unsuccessful.
Git push	This action is logged when the user synchronizes information between the built-in Git repository and the remote Git host.
Git restore	This action is logged when the user restores all of their bots and associated dependent files from the Git repository to a new database.

Audit entries	Description
Git restore abort	This action is logged when the user aborts to restore all of their bots and associated dependent files from the Git repository to a new database.
Git restore reset	This action is logged when the user resets to restore all of their bots and associated dependent files from the Git repository to a new database.
Import bot	This action is logged when the user imports a bot.
Import domain	This action is logged when the user imports any new domains to IQ Bot.
Import learning instance	This action is logged when the user imports a learning instance (.iqba file) through the migration utility.
Import queue	This action is logged when the user imports a queue into workload management.
Import request	This action is logged when the user generates an import request.
Install license	This action is logged when the user installs or changes the license from the license page.
IP address access	This action is logged when the IP address has been accessed.
License migration	This action is logged when a license is migrated to another user.
License mode change	This action is logged when the user changes the license mode.
Load work items from file	This action is logged when the user selects a CSV or Excel file and uploads the work item in a queue.
Log in banner settings	This action is logged when an Admin configures banner text to display on the login page of the Control Room.
Migration finished	This action is logged when a migration completes.
Migration started	This action is logged when a migration begins.
Move automation to history	This action is logged when the user moves the selected activity to the <b>Historical</b> page.



Audit entries	Description
Move file	This action is logged when a user moves any type of file (process automation, bot, and so on) from one folder or path to another folder or path.
No access to pool	This action is logged when a user has no access to a device pool.
Override Global value	This action is logged when users override a global value with their own private value.
Password settings	This action is logged when an Admin configures password settings for the Control Room.
Read credential	This action is logged when the logged-in user accesses the credentials of another user for which they do have permission for because the user is not a consumer for the credential or a credential owner.
Read locker	This action is logged when the logged-in user accesses the locker of another user for which they do not have permission because they are not part of a locker as a member (owner, manager, participant, or consumer).
Register app	This action is logged when the user configures IQ Bot.
Release license	This action is logged when the user changes the license from Bot Runner to Bot Creator or Admin.
Release user license	This action is logged when the user changes the user license.
Remove manual dependency	This action is logged when the manual dependency is removed from a bot.
Rename folder	This action is logged when the user renames the folder.
Resend email verification	This action is logged when the email is resent for verification.
Reset password	This action is logged when the user resets the password.
Revert checkout	This action is logged when the user reverts a previous check out action.
Rollback	This action is logged when the user rolls back to a previous version.
Run as user in use	This action is logged when the user runs a bot as the user using the bot.

Audit entries	Description
Run as user invalid	This action is logged when a user who tries to run a and use the bot is invalid.
Run automation	This action is logged when the user runs an automation.
Save allowed IP addresses	This action is logged when the allowed IP addresses have been saved.
Schedule misfired	This action is logged when the Control Room services starts or the server is available after more than 15 minutes of scheduled deployment time.
Security Settings - External key Vault - Configuration	For cloud deployments, this action is logged when a user makes a change to the external key vault configuration. Automation Anywhere supports these external key vaults: AWS Secrets Manager, Azure Key Vault, and CyberArk. This audit entry shows the status as either Successful or Unsuccessful.
Security Settings - Network settings	This action is logged when the user changes the configuration of the allowed IP address from where the authentication is restricted.
Send bot to production	This action is logged when the user moves the bot from staging to production.
Send bot to staging	This action is logged when the user moves the bot from production to staging.
Send email	This action is logged when an email is sent.
Send learning instance to production	This action is logged when the user moves the learning instance from staging to production.
Send learning instance to staging	This action is logged when the user moves the learning instance from production to staging.
Session timeout settings	This action is logged when the settings of a session timeout is reached.
Set default device	This action is logged when the user sets the default device.
Set device credentials	This action is logged when the user sets the device credentials.
Set Git settings	This action is logged when the user sets remote Git repository settings in the Control Room.
Sync license	This action is logged when a license is synced.

Audit entries	Description
SysLog Configuration	For on-premises deployments, this action is logged when a user adds, edits, or deletes Syslog server configuration. This audit entry shows the Control Room server recording the status as either Successful or Unsuccessful.
Temporary devices cleanup job	This action is logged when the temporary device runs its cleanup job.
Test proxy connectivity	This action is logged when proxy connectivity is tested.
Time out	This action is logged when an operation times out.
Train bot	This action is logged when the user creates a training bot.
Transfer credential ownership	This action is logged when the locker admin transfers the ownership of the credentials.
Trigger bot run	This action is logged when a bot runs due to a trigger.
Trigger bot run fail	This action is logged when a bot fails to run due to a trigger.
Trigger delete	This action is logged when a trigger is deleted.
Trigger delete failed	This action is logged when the deletion of a trigger fails.
Trusted CA key store update	This action is logged when a user modifies the trusted CA key store for certificate authentication.
Unable to send bot device	This action is logged when a bot fails to be sent to a device.
Undo checkout	This action is logged when the user reverses a check out.
Unlock credential vault	This action is logged when the user unlocks the credential vault.
Unset default device	This action is logged when the user changes the default device.
Update app registration	This action is logged when the IQ Bot URL is updated in the settings page.
Update automation	This action is logged when the user edits the schedule automation.
Update callback URL failed	This action is logged when the callback URL list has failed to update.

Audit entries	Description
Update callback URL successful	This action is logged when the callback URL list has been updated successfully.
Update credential	This action is logged when the user modifies the credentials.
Update device auto download packages	This action is logged when the device updates its auto download packages settings.
Update device credentials	This action is logged when the device updates its credentials.
Update device general settings	This action is logged when the device updates its general settings.
Update device log settings	This action is logged when the device updates its log settings.
Update device RDP settings	This action is logged when the device updates its RDP (Remote Desktop Protocol) settings.
Update device resolution settings	This action is logged when the device updates its resolution settings.
Update Git settings	This action is logged when the user updates remote Git repository settings in the Control Room.
Update Global value	This action is logged when the user updates an existing public global value.
Update locker	This action is logged when the user modifies the lockers.
Update MFA role	This action is logged when the user modifies the MFA (multi-factor authentication) role.
Update MFA settings	This action is logged when the user modifies the MFA (multi-factor authentication) settings.
Update MFA token	This action is logged when the user modifies the MFA (multi-factor authentication) token.
Update MFA user	This action is logged when the user modifies the two-factor authentication for a user.
Update package	This action is logged when the user updates an existing package.
Update package settings	This action is logged when the user updates any package settings.
Update proxy credentials	This action is logged when the user updates existing proxy credentials.

Audit entries	Description
Update queue	This action is logged when the user updates the existing queue (for example, adding new work items to the same queue).
Update queue failed	This action is logged when the user fails to update the existing queue (for example, adding new work items to the same queue).
Update settings	This action is logged when the user updates any setting in Control Room.
Update temporary devices auto delete settings	This action is logged when the temporary device updates its auto delete settings.
Update work item	This action is logged when the user edits a work item.
Update work item failed	This action is logged when work items fail to update.
UPDATE_DEVICE_ADVANCED_OPTIONS_SETTINGS	This action is logged when the user changes the device environment settings such as: global cache location, auto-login timeout duration, and so on.
UPDATE_DEVICE_THRESHOLD_SETTINGS	This action is logged when the user changes enables or disables the threshold settings such as: CPU utilization, device memory threshold values, and so on.
UPDATE_DEVICE_LOG_SETTINGS	This action is logged when the user changes the log collection settings such as: log collection, log size, and so on.
UPDATE_GLOBAL_AUTO_LOGIN_SETTINGS	This action is logged when the user changes the auto-login settings in the Control Room to either create user sessions, or reuse existing user sessions to reduce the bot startup time.
Upload	This action is logged when a user imports a file.
Upload bot	This action is logged when a user uploads a bot.
Upload document	This action is logged when a user uploads a document.
Upload file	This action is logged when a user uploads a file.
Upload package	This action is logged when the user uploads a package.
Upload work items file	This action is logged when the user updates a queue and adds work items.

Audit entries	Description
User Authentication configuration	This action is logged when the user changes the Control Room database or SAML user authentication configuration.
User multiple log in	This action is logged when the user logs in to the Control Room from different browsers with the same username.
User log in	This action is logged when the user logs in to the Control Room.
User log out	This action is logged when the user logs out of the Control Room.
Validate learning instance	This action is logged when the user validates (either corrects the document and saves it or invalidates the document) a document in the validator of a learning instance.
Version control settings	This action is logged when the user updates any version control settings.
Websocket proxy connection failure	This action is logged when the websocket proxy connection fails.

## Active Directory audit entries

The following table shows the list of Active Directory audit entries and their descriptions (listed alphabetically):

Audit entries	Description
AD allowed domain not set	This action is logged when a user or an existing mapping belongs to one or more domains. <a href="#">Manage Active Directory role mapping</a> on page 1774
AD allowed domain set	<ul style="list-style-type: none"> <li>This action is logged when the user adds a domain to the allowed domains list.</li> <li>This action is logged when the user removes a domain from the allowed domains list.</li> </ul> <a href="#">Manage domain</a> on page 1814
AD default domain set	This action is logged when the user configures a domain as the default domain. <a href="#">Manage domain</a> on page 1814

Audit entries	Description
AD group mapping created	This action is logged when the user creates an Active Directory role mapping.
AD group mapping deleted	This action is logged when the user deletes an Active Directory role mapping.
AD group mapping updated	This action is logged when the user updates an Active Directory role mapping.
AD sync role empty	This action is logged when an Active Directory role assigned with sync operations is empty.
AD sync role conflict	This action is logged when an Active Directory role assigned with sync operations is in conflict with another role.
AD sync role system assigned	This action is logged when new Active Directory roles are assigned with sync operations.
AD sync role system deleted	This action is logged when Active Directory roles are deleted with sync operations.
AD sync role system updated	This action is logged when Active Directory roles are updated with sync operations.
AD sync user count	This action is logged when the Active Directory user counts are synced.
AD sync user deleted	This action is logged when the Active Directory synced users are deleted.
AD sync user out of license	This action is logged when the Active Directory synced users run out of available licenses.

## Automation Co-Pilot for Business Users (Automation Co-Pilot) Audit logs

The entry shows the status of events relating to requests, teams, scheduler, process setups, bot setups, human tasks, and bot tasks that you have created, deleted, updated, submitted, or recovered.

Audit log entry	Success
Automation Co-Pilot Team	<ul style="list-style-type: none"> <li>When a team is created by a user</li> <li>When a team is edited by a user</li> <li>When a team is deleted by a user</li> </ul>
Automation Co-Pilot Request	<ul style="list-style-type: none"> <li>When a request is deleted by a user</li> <li>When a request is recycled by a user</li> <li>When a request is recovered by a user</li> </ul>

Audit log entry	Success
Automation Co-Pilot Human Task	<ul style="list-style-type: none"> <li>When a task is edited by a user</li> <li>When a task is submitted by a user</li> <li>When a task is canceled by a user</li> <li>When a task is assigned by a user to another user</li> <li>When a task is canceled (using a cancel type of action by a user or by a bot (AARI Web package))</li> </ul>
Automation Co-Pilot Bot Task	When the process launched a bot task
Automation Co-Pilot Process	<ul style="list-style-type: none"> <li>When a process is created</li> <li>When a process is edited by a user</li> </ul>
Automation Co-Pilot Bot Setup	<ul style="list-style-type: none"> <li>When a new bot is added to the bot setup management</li> <li>When the bot setup management is modified</li> <li>When a bot is deleted by a user</li> </ul>
Process Scheduler	When the scheduler configuration is modified

## Bot Insight audit entries

The following table shows the list of Bot Insight audit entries and their descriptions (listed alphabetically):

Audit entries	Description
Bot Insight add user dashboard	This action is logged when a new user dashboard is added to Bot Insight.
Bot Insight BLM dashboard export	This action is logged when a user exports a BLM (Bot Lifecycle Management) dashboard from Bot Insight.
Bot Insight BLM dashboard import	This action is logged when a user imports a BLM (Bot Lifecycle Management) dashboard into Bot Insight.
Bot Insight create dashboard	This action is logged when a user creates a dashboard in Bot Insight.
Bot Insight copy dashboard	This action is logged when a user copies a dashboard in Bot Insight.
Bot Insight delete dashboard	This action is logged when a user deletes a dashboard from Bot Insight.



Audit entries	Description
Bot Insight delete user dashboard	This action is logged when a user dashboard is deleted from Bot Insight.
Bot Insight end task	This action is logged when a task ends in Bot Insight.
Bot Insight get task data	This action is logged when task data is retrieved in Bot Insight.
Bot Insight get user dashboards	This action is logged when user dashboards are retrieved in Bot Insight.
Bot Insight load dashboard	This action is logged when a user loads a dashboard in Bot Insight.
Bot Insight operations	This action is logged when operations occur in Bot Insight.
Bot Insight publish dashboard	This action is logged when a user publishes a dashboard in Bot Insight.
Bot Insight registers dashboard	This action is logged when a user registers a dashboard in Bot Insight.
Bot Insight run data	This action is logged when data runs in Bot Insight.
Bot Insight save dashboard	This action is logged when a user saves a dashboard in Bot Insight.
Bot Insight search dashboard	This action is logged when a user searches a dashboard in Bot Insight.
Bot Insight start task	This action is logged when a task starts in Bot Insight.
Bot Insight update dashboard	This action is logged when a user updates a dashboard in Bot Insight.
Bot Insight profile update	This action is logged when a user updates a data profile in Bot Insight.

## Bot life cycle audit logs

The entry shows the status of each stage of the bot life cycle.

Audit log entry	Success	Failure
Create automation	Bot was sent to the control room and was successfully compiled.	Check if the Control Room is up and running.

Audit log entry	Success	Failure
Bot Sent To Device	Control Room deployed the bot successfully on the specified device.	<p>Possible reasons for failure entry include:</p> <ul style="list-style-type: none"> <li>• Check if you have configured the Node manager on the corresponding device correctly.</li> <li>• Check for the app Automation Anywhere Bot Manager in <b>Add Remove Programs</b> or in <b>Control Panel &gt; Uninstall a program</b>. Try to reinstall by uninstalling and downloading the app again.</li> <li>• Try to reinstall by uninstalling and downloading the app again from Device Manager.</li> <li>• Ensure the device auto log in details are set correctly.</li> </ul>
Run bot Deployed	The bot has started on the specified device.	<p>Possible reasons for failure entry include:</p> <ul style="list-style-type: none"> <li>• Check if you have configured the Node manager on the corresponding device correctly.</li> <li>• Check for app Automation Anywhere Bot Manager in <b>Add Remove Programs</b> or in <b>Control Panel &gt; Uninstall a program</b>.</li> <li>• Try to reinstall by uninstalling and downloading the app again from Device Manager.</li> <li>• Ensure device auto log in details are set correctly.</li> </ul>

Audit log entry	Success	Failure
Run bot finished	Bot execution completed successfully.	Possible reasons for failure entry include: <ul style="list-style-type: none"> <li>• Check for the bot execution progression in Activity In progress.</li> <li>• Check the code at the line where activity log has been paused for errors.</li> <li>• If it has paused at a message box, minimize all windows and check if the message box is in the background.</li> </ul>
Bot Runner Session Continued	Control Room deploys the Task Bots in a sequence for the same RDP session.	
Bot Runner Session Released	When a task successfully completes the execution.	
Download file	Downloading to the Control Room.	
Upload file	Uploading a file to the Control Room.	
Bot Runner Session	Control Room gets the RDP session of Bot Runner machine.	

## Bot Store audit entries

The following table shows the list of Bot Store audit entries and their descriptions (listed alphabetically):

Audit entries	Description
Bot Store add to My bots	This action is logged when a user adds a bot to their My bots.
Bot Store clean up	This action is logged when clean up is performed for a deleted tenant.
Bot Store download	This action is logged when a user starts to download a bot from the Bot Store.
Bot Store log in	This action is logged when a user logs in to the Bot Store.

Audit entries	Description
Bot Store submit bots	This action is logged when a user submits bots to the Bot Store.

## Code analysis audit entries

The following table shows the list of code analysis audit entries and their descriptions (listed alphabetically):

Audit entries	Description
Automated code analysis completed	This action is logged when automated code analysis completes.
Automated code analysis started	This action is logged when automated code analysis starts.
Policy added	This action is logged when a user adds a new code analysis policy in the <b>Policy Manager</b> page.
Policy deleted	This action is logged when a user deletes a code analysis policy in the policy manager page.
Policy folder added	This action is logged when a user creates a policy assignment to a folder in the policy manage page.
Policy folder removed	This action is logged when a user deletes a policy assignment to a folder in the policy manage page.
Policy updated	This action is logged when a user modifies and saves a code analysis policy in the policy manage page.
Run automated code analysis	This action is logged when automated code analysis starts and when automated code analysis completes.
Run code analysis	<p>This action is logged when a user performs the following actions:</p> <ul style="list-style-type: none"> <li>• Runs code analysis from the automation page.</li> <li>• Opens an automation file in the Bot editor.</li> <li>• Saves an automation file in the Bot editor</li> </ul>

## Device pool audit entries

The following table shows the list of device pool audit entries and their descriptions (listed alphabetically):

Audit entries	Description
Device pool created	This action is logged when the user successfully creates a new device pool.
Device pool creation failed	This action is logged when the user fails to create a device pool.
Device pool deleted	This action is logged when the user successfully deletes a device pool.
Device pool deletion failed	This action is logged when the user fails to delete a device pool.
Device pool update failed	This action is logged when the user fails to update an existing device pool.
Device pool updated	This action is logged when the user edits an existing device pool (for example, add a new device or add a new customer role).

## Device update audit entries

The following table shows the list of device update audit entries and their descriptions (listed alphabetically):

Audit entries	Description
Device update acknowledged	This action is logged when the device update has been acknowledged.
Device update already in progress	This action is logged when the device update is already in progress.
Device update completed	This action is logged when the device update has completed.
Device update disconnected	This action is logged when the device update has been disconnected.
Device update downloaded	This action is logged when the device update has been downloaded.
Device update failed and max retry reached	This action is logged when the device update has failed after the maximum number of retries has been reached.
Device update failed and max retry reset reached	This action is logged when the device update has failed but device will continue to retry the update.

Audit entries	Description
Device update initiated	This action is logged when the user initiates the device update.
Device update settings	This action is logged when the settings of a device are updated.
Device update started	This action is logged when the device update has started.
Device update unavailable	This action is logged when the device update has already occurred and been updated.
Device update unsuccessful	This action is logged when the device update has been unsuccessful.
Device update waiting for deployments to complete	This action is logged when the device update is waiting for deployments to complete.

### Discovery bot audit entries

The following table shows the list of Discovery bot audit entries and their descriptions (listed alphabetically):

Audit entries	Description
Discovery bot cancel recording	This action is logged when the discovery bot successfully cancels a recording.
Discovery bot convert to bot	This action is logged when the discovery bot successfully converts to a bot.
Discovery bot create aggregated recording	This action is logged when the discovery bot successfully creates a new aggregated recording.
Discovery bot create opportunity	This action is logged when the discovery bot successfully creates a new opportunity.
Discovery bot create process	This action is logged when the discovery bot successfully creates a new process.
Discovery bot create process assignment	This action is logged when the discovery bot successfully creates a new process assignment.
Discovery bot create project	This action is logged when the discovery bot successfully creates a new project.
Discovery bot create recording	This action is logged when the discovery bot successfully creates a new recording.
Discovery bot create recording step	This action is logged when the discovery bot successfully creates a new recording step.

Audit entries	Description
Discovery bot create recording step metadata	This action is logged when the discovery bot successfully creates metadata for a new recording step.
Discovery bot delete aggregated recording	This action is logged when the discovery bot successfully deletes an aggregated recording.
Discovery bot delete opportunity	This action is logged when the discovery bot successfully deletes an opportunity.
Discovery bot delete process	This action is logged when the discovery bot successfully deletes a process.
Discovery bot delete process assignment	This action is logged when the discovery bot successfully deletes a process assignment.
Discovery bot delete project	This action is logged when the discovery bot successfully deletes a project.
Discovery bot delete recording	This action is logged when the discovery bot successfully deletes a recording.
Discovery bot delete recording step	This action is logged when the discovery bot successfully deletes a recording step.
Discovery bot delete recording step metadata	This action is logged when the discovery bot successfully deletes metadata for a recording step.
Discovery bot export opportunity	This action is logged when the discovery bot exports an opportunity.
Discovery bot migrate opportunity	This action is logged when the discovery bot migrates an opportunity.
Discovery bot update aggregated recording	This action is logged when the discovery bot edits an existing aggregated recording.
Discovery bot update aggregated recording json	This action is logged when the discovery bot edits an existing aggregated recording using json.
Discovery bot update opportunity	This action is logged when the discovery bot edits an existing opportunity.
Discovery bot update process	This action is logged when the discovery bot edits an existing process.
Discovery bot update process assignment	This action is logged when the discovery bot edits an existing process assignment.
Discovery bot update project	This action is logged when the discovery bot edits an existing project.
Discovery bot update recording	This action is logged when the discovery bot edits an existing recording.
Discovery bot update recording step	This action is logged when the discovery bot edits an existing recording step.

Audit entries	Description
Discovery bot update recording step metadata	This action is logged when the discovery bot edits metadata for an existing recording step.

## External key vault audit log

For cloud deployments, the External key vault configuration audit entry shows the type of external key vault configured (if any). Automation Anywhere supports these external key vaults:

- AWS Secrets Manager
- Azure Key Vault
- CyberArk Password Vault

Based on the type of external key vault configured, the external key vault configuration details shows different attributes and their values.

Audit log entry	External key vault	User action	Configuration details shows these attributes and their values
External key vault configuration	AWS Secrets Manager	Adds a new AWS Secrets Manager when there was previously no external key vault.	<ul style="list-style-type: none"> <li>• External key vault value: Changes from no external key vault to AWS Secrets Manager.</li> <li>• AWS Secrets Manager value is Enabled</li> <li>• Region value is set to (for example) us-east-1</li> </ul>



Audit log entry	External key vault	User action	Configuration details shows these attributes and their values
	CyberArk	Adds a new CyberArk Password Vault when there was previously no external key vault.	<ul style="list-style-type: none"> <li>External key vault value: Changes from no external key vault to CyberArk.</li> <li>CyberArk value is Enabled</li> <li>Vault URL is the CyberArk AIM server CCP API URL and is set to (for example) https://&lt;hostname:port_num&gt;/</li> <li>Application ID is the CCP API AppID and is set to (for example) AAControlRoom</li> </ul>

Audit log entry	External key vault	User action	Configuration details shows these attributes and their values
	Azure Key vault	Adds a new Azure Key vault when there was previously no external key vault.	<ul style="list-style-type: none"> <li>External key vault value: Changes from no external key vault to Azure Key vault.</li> <li>Azure Key vault value is Enabled</li> <li>Vault URL is the Azure Key Vault URL and is set to (for example) <code>https://user-db-vault.vault.azure.net/</code></li> <li>Client ID is the (application) ID of an App Registration in the tenant and is set to (for example)536145</li> <li>Tenant ID is the Azure Active Directory tenant (directory) ID and is set to (for example)89D12L</li> </ul>
External key vault configuration	Change from AWS Secrets Manager to CyberArk	User changes from one external key vault to another type.	External key vault value changes from AWS Secrets Manger to CyberArk

### OAuth connection audit entries

The following table shows the list of OAuth connection audit entries and their descriptions (listed alphabetically):

Audit entries	Description
Bulk delete OAuth connection	This action is logged when multiple OAuth connections are deleted simultaneously.
Create OAuth connection	This action is logged when an OAuth connection is successfully created.
Delete OAuth connection	This action is logged when an OAuth connection is successfully deleted.
Update OAuth connection	This action is logged when an OAuth connection is successfully updated.

### Run bot audit entries

The following table shows the list of run bot audit entries and their descriptions (listed alphabetically):

Audit entries	Description
Run bot disconnected	This action is logged when a user disconnects a running bot.
Run bot finished	This action is logged when a running bot finishes.
Run bot paused	This action is logged when a user pauses a running bot.
Run bot pre process failed	This action is logged when the pre-process to run the bot fails.
Run bot reconnected	This action is logged when a user re-connects a running bot.
Run bot resumed	This action is logged when a previously paused bot resumes to run.
Run bot stopped	This action is logged when a user stops a running bot.

### Run bot local audit entries

The following table shows the list of run bot local audit entries and their descriptions (listed alphabetically):

Audit entries	Description
Run bot local hotkey finished	This action is logged when a running bot for a local hotkey finishes.
Run bot local hotkey paused	This action is logged when a running bot for a local hotkey pauses.

Audit entries	Description
Run bot local hotkey resumed	This action is logged when a running bot for a local hotkey resumes.
Run bot local hotkey started	This action is logged when a running bot for a local hotkey starts.
Run bot local hotkey stopped	This action is logged when a running bot for a local hotkey stops.
Run bot local hotkey suspended	This action is logged when a running bot for a local hotkey is suspended.
Run bot local schedule finished	This action is logged when a running bot for a local schedule finishes.
Run bot local schedule paused	This action is logged when a running bot for a local schedule pauses.
Run bot local schedule resumed	This action is logged when a running bot for a local schedule resumes.
Run bot local schedule started	This action is logged when a running bot for a local schedule starts.
Run bot local schedule stopped	This action is logged when a running bot for a local schedule stops.
Run bot local schedule suspended	This action is logged when a running bot for a local schedule is suspended.
Run bot local trigger finished	This action is logged when a running bot for a local trigger finishes.
Run bot local trigger paused	This action is logged when a running bot for a local trigger pauses.
Run bot local trigger resumed	This action is logged when a running bot for a local trigger resumes.
Run bot local trigger started	This action is logged when a running bot for a local trigger starts.
Run bot local trigger stopped	This action is logged when a running bot for a local trigger stops.
Run bot local trigger suspended	This action is logged when a running bot for a local trigger is suspended.

### Run logic local audit entries

The following table shows the list of run logic local audit entries and their descriptions (listed alphabetically):

Audit entries	Description
Run logic local client finished	This action is logged when running logic for a local client finishes.
Run logic local client paused	This action is logged when running logic for a local client pauses.
Run logic local client resumed	This action is logged when running logic for a local client resumes.
Run logic local client started	This action is logged when running logic for a local client starts.
Run logic local client stopped	This action is logged when running logic for a local client stops.
Run logic local client suspended	This action is logged when running logic for a local client is suspended.

### Run workflow local audit entries

The following table shows the list of run workflow local audit entries and their descriptions (listed alphabetically):

Audit entries	Description
Run workflow local client finished	This action is logged when running a workflow for a local client finishes.
Run workflow local client started	This action is logged when running a workflow for a local client starts.
Run workflow local client stopped	This action is logged when running a workflow for a local client stops.
Run workflow local schedule finished	This action is logged when running a workflow for a local schedule finishes.
Run workflow local schedule started	This action is logged when running a workflow for a local schedule starts.
Run workflow local schedule stopped	This action is logged when running a workflow for a local schedule stops.
Run workflow local trigger finished	This action is logged when running a workflow for a local trigger finishes.
Run workflow local trigger started	This action is logged when running a workflow for a local trigger starts.
Run workflow local trigger stopped	This action is logged when running a workflow for a local trigger stops.

## Schedule bot audit entries

The following table shows the list of schedule bot audit entries and their descriptions (listed alphabetically):

Audit entries	Description
Schedule bot disconnected	This action is logged when a scheduled bot is disconnected.
Schedule bot ended	This action is logged when a scheduled bot ends.
Schedule bot paused	This action is logged when a scheduled bot pauses.
Schedule bot reconnected	This action is logged when a scheduled bot is reconnected.
Schedule bot resumed	This action is logged when a scheduled bot resumes.
Schedule bot stopped	This action is logged when a scheduled bot stops.

## Syslog audit log

For on-premises deployments, the SysLog Configuration audit entry shows the Control Room server status when adding, editing, or deleting the system configuration. The Syslog details shows these attributes and their values:

- Syslog Server Hostname: Full qualified domain name (FQDN) or the IP address of the Syslog server used to deliver the log reports
- Port: Port used by the remote Syslog server to receive incoming Syslog records
- Protocol: TCP or UDP
- Use Secure Connection: TLS encrypted channel used to send Syslog records to the remote Syslog server

Audit log entry	Status	User action	SysLog details shows these attributes and their values
SysLog Configuration	Successful	Adds new values to an existing server	<ul style="list-style-type: none"> <li>• Syslog Server Hostname</li> <li>• Port</li> <li>• Protocol</li> <li>• Use Secure Connection</li> </ul> <p>For example: MyServer1.aa.com, 468, TCP, Enabled</p>
	Successful	Adds new values to multiple servers	<ul style="list-style-type: none"> <li>• Syslog Server Hostname</li> <li>• Port</li> <li>• Protocol</li> <li>• Use Secure Connection</li> </ul> <p>For example: MyServer1.aa.com, 468, TCP, Enabled</p> <p>MyServer2.aa.com, 333, TCP, Disabled</p>
	Successful	Edits existing server	<ul style="list-style-type: none"> <li>• Syslog Server Hostname</li> <li>• Port</li> <li>• Protocol</li> <li>• Use Secure Connection</li> </ul> <p>For example: Old Value MyServer1.aa.com, 468, TCP, Enabled</p> <p>New Value MyServer123.aa.com, 514, UDP, Disabled</p>

Audit log entry	Status	User action	SysLog details shows these attributes and their values
	Successful	Deletes existing server	<ul style="list-style-type: none"> <li>Syslog Server Hostname</li> <li>Port</li> <li>Protocol</li> <li>Use Secure Connection</li> </ul> <p>For example: MyServer1.aa.com, 468, TCP, Enabled</p>
SysLog Configuration	Unsuccessful	User attempted to save the system configuration; however, the Control Room was not able to save the configuration.	For an unsuccessful status, you can use the results to troubleshoot the issue. Examples: Invalid Protocol, or Could not save SysLog settings. Invalid Host.

## Export audit data to CSV

Export Control Room log related data to a CSV file.

- You must have the View\_user permission to export the basic information about other users to the CSV file.
- The source and the target Control Room instances must be running the same version.
- The source and the target Control Room instances must be of the same setup type: SSO with SSO, AD with AD, and non-AD with non-AD.

You can export selected, filtered, or all audit log data to a CSV file by using the following options:

- Export checked items**
- Export filtered items**
- Export all items**

- Navigate to **Administration > Audit log**.  
A list of all the logs is displayed.



- Click the **Export items to CSV** drop-down

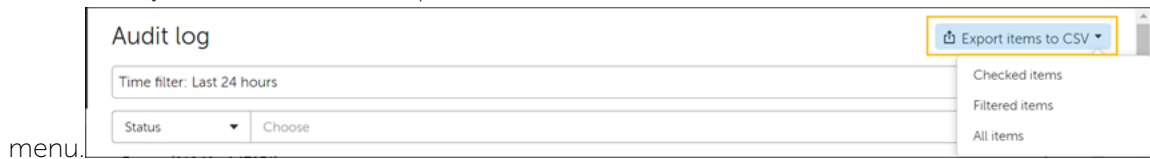

menu.

- Click one of the following required sub-menus:

- **Export checked items:** Exports only the selected records.

**Note:** You must select items to use this option.

- **Export filtered items:** Exports only records that are available after applying filters like Status, Item name, Event type, and so on.
- **Export all items:** Exports all the available records.

**Note:** You can export a maximum of 100,000 records at a time.

The CSV file is exported and downloaded to your local system based on the selected option.

**Note:**

- If there is large number of audit logs to export, a message is displayed, informing that the export function is started and exported CSV file is available in the **Activity > Historical** page. For more information, see [Download exported CSV file](#) on page 2177.
- The time required to export data to a CSV file might vary based on the number of records being exported. A message appears on the screen if the time required to export the data is more than 2 seconds. The CSV file is available for download after it is generated.

Also refer to [Syslog server integration](#) on page 1815.

## Download exported CSV file

When there is large number of audit log data to export, the export function starts and exported CSV file is available in the **Activity > Historical** page.

To download the exported CSV file,

- Navigate to the **Activity > Historical** page and search for exported audit log by using the Audit-Export

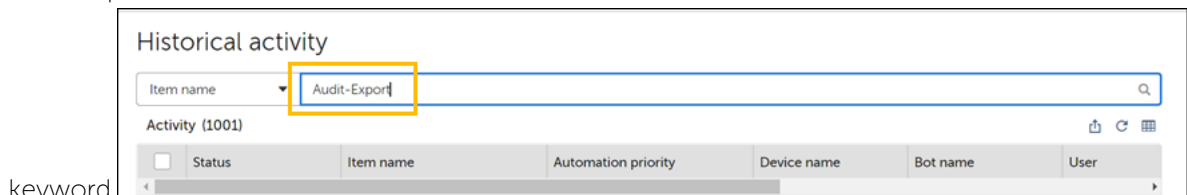

keyword.

A list of all the exported audit log files is displayed.

- Click the required item name hyperlink to view the audit log details.

Historical activity

Item name Search

Item name: Audit-Export

Activity (2 of 1002)

Status	Item name	Automation priority	Device name	Bot name	User
Run failed	Audit-Export: cr-audit-2022081...	Medium	Picked at run time	-	taimur
Completed	Audit-Export: cr-audit-2022081	Medium	Picked at run time	-	taimur

3. Click **Download exported zip file**.

Audit-Export: cr-audit-20220818-103015-botcreator

Device: Picked at run time

User: botcreator

Name + Description

Name: Audit-Export: cr-audit-20220818-103015- botcreator

Description: --

Download exported zip file

The CSV file is downloaded to your local system as a zip file.

## Code analysis

Code analysis (code review) enables you to evaluate a program without running the code. When you review the code, a list of violations based on a set rules are displayed. You can review and fix any coding or stylistic errors for your automation.

Code analysis enables you to form certain code structures with which you can implement coding best practices and make the code maintainable, reliable, efficient, and secure.

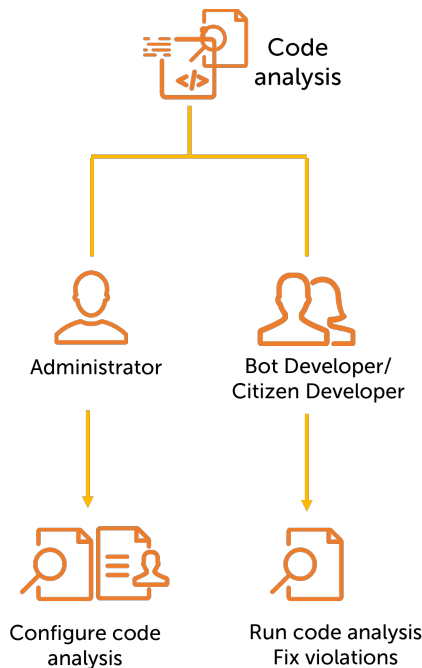

Automation ANYWHERE Settings

> Bots

> Policies

Code Analysis

When enabled this feature will enable all set Code Analysis policies and enable automated code analysis of bots in the repository.

Enable  Disable

> Packages

> Devices

> IQ Bot

> Bot agent bulk install

> Email

Automation

Public Private Bot Store

Public bots and files can be viewed, run, and checked out by other people, based on permissions set by your administrator.

Folders

- Bots
- code\_an...
- Document Workspace Pr...
- IQ Bot Processes
- Sample bots

Files and folders (1)

Type	Name	Status	Version	Label
Task Bot	test_code_analysis	Checked out	3	

Run Code Analysis

## Benefits

Code analysis provides you the following benefits:

- Implement coding best practices by enforcing certain coding conventions.
- Authorize Citizen Developer to introduce new automations.
- Enable complex automations to be more accessible.
- Improve code readability and quality.
- Control the structure of your automation code.
- Improve productivity of the developer and the platform as good coding practise improves the automation quality over time.

## Code analysis for user roles

Lead RPA Developer (Administrator)

Configure code analysis policies that define coding best practices in the organization.

Monitor and report the status of code quality based on adherence to these policies. Code analysis enables certain coding practices and principles to be enforced which in turn helps with the following:

- Facilitate the development of automation by a larger pool of business personnel, for example, a Citizen Developer who might not have strong software development skills.
- Improve maintenance of automations by reducing code complexity and improving readability.
- Improve reliability of automations by reducing errors.
- Improve security and compliance of automations by enforcing secure coding practices.
- Reduce production time and costs of automation.

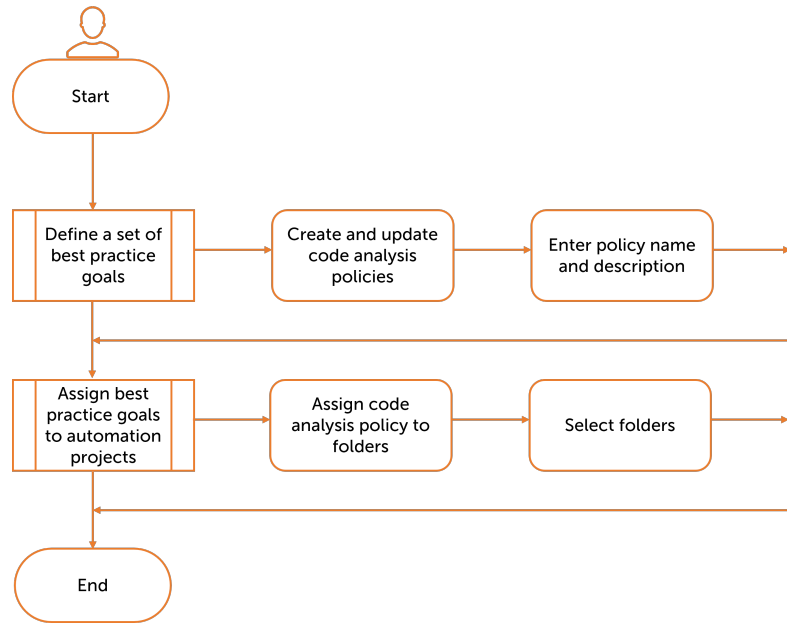

Citizen Developer or RPA Developer

Code analysis provides guidance to develop automations that meet organizational requirements for the following:

- Error reduction
- Code readability and maintenance
- Code security

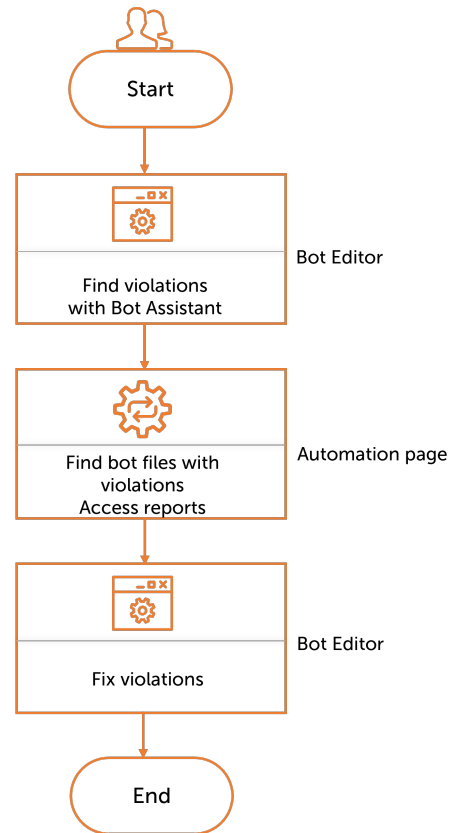

## Permissions

You require the following permissions to set up a code analysis policy.

- **View policies:** Allows you to view the code analysis policy that defines how developers can build automations.
- **Manage policies:** Allows you to view, edit, and assign policies that defines how developers can build automations. This permission allows the assignment of policies to folders for which you have access.

For code analysis enforcement, you require the permissions mentioned below. These permissions are active when code analysis is enabled in **Administration > Settings > Policies**

- **Enable enforcement for bot check-in:** A default permission in all roles which allows the user to check-in the automation file if it has no code analysis violations.
- **Allow check-in with low severity violations:** This optional permission allows the user to check-in the automation file if it has low severity code analysis violations.
- **Allow check-in with high severity violations:** This optional permission allows the user to check-in the automation file if it has high severity code analysis violations.

---

**Important:** Starting with Automation 360 v.29, all the system roles (such as AAE\_Basic or AAE\_Admin) will have only the permissions to check in bots with no violations. All the custom roles (user-defined roles) are updated to contain both the permissions to check in with low and high severity violations. For enforcement, you should edit your custom roles to restrict check-in. If

you use only system-defined roles for your users, to configure enforcement, you must create new roles to assign the appropriate permissions to check in bots with violations.

---

## Components

- Policy editor: Contains multiple named policies for all Control Room users.
- Rules: As the foundation of code analysis, rules help to evaluate bot code. Rules can be simple or complex depending on the evaluation that is performed. Rules include coding practices that can be verified. They apply to packages and actions in the automation code. A rule consists of a unique RULE\_CODE and a description to indicate the nature of evaluation to be performed on the code.

## Code analysis policy management

Code analysis policies are a set of rules that you can apply to different projects allowing flexibility when introducing coding standards.

To improve the code quality, as an administrator you can:

- Create policies with different rules.
- Apply different policies to different folders on the **Automation** page.
- Easily access the policy rule details while managing code analysis policies.

### Enable code analysis policy

As an administrator, you can enable code analysis policy by navigating to **Administration > Settings > Policies** tab. Click **Edit** to enable the code analysis policy. When you enable code analysis policy:

- Code analysis automatically runs on all the bots in the public workspace that have **Not Scanned** status and reside in folders which are assigned code analysis policy. This provides visibility on coding best practices for the bots in the public workspace. Code analysis runs every five minutes and scans 1,000 bot files in five minutes.
- Code analysis is invoked when you save a bot in the Bot editor.
- Code analysis results summary is visible on the **Automation** page.
- Code analysis results are displayed in the **Assistant** tab.
- Run code analysis icon is available from the row level action on the **Automation** page. Running code analysis from the **Automation** page enables you to download the code analysis violation report.

When you disable code analysis policy, the code analysis functions and features are not available.

Regardless of whether code analysis is enabled or disabled, you can still create multiple policies and assign those policies to different folders in the **Automation** page.

The following video displays how to enable the code analysis policy:

## Create and assign code analysis policy

You can configure multiple named policies for code analysis. With this feature, you can create different policies with different rules configured with different settings and different severity levels. You can use these named code analysis policies to define different code quality standards and apply to different automation projects by assigning the policy to specific folders. This provides the flexibility to gradually introduce code quality standards on existing and older projects and also apply more firmer standards on newer projects.

You need the **View policies** and **Manage policies** permissions to set up a code analysis policy. These permissions allow you to view, edit, and assign policies that define how developers can build automations. The **Manage policies** permission allows the assignment of policies to folders for which you have access.

The **Administration > Policies** page has two tabs; **Policies** and **Assign**. You can create and name these policies in the **Policies** tab. You can create any number of policies. You can search for any policy using the search tool at the top. You can use either the policy name or description in the policy selector window to search for a policy. You can also view, edit, and delete any policies by clicking the actions menu (vertical ellipses) on the right and selecting the appropriate action.

Use the **Assign** tab to assign a policy to a folder on the **Automation** page. You can optionally remove the assigned policy on any folder by clicking the actions menu (vertical ellipses) on the right and selecting the **Unassign policy**.

Policy summary pop-up: The policy summary pop-up provides a quick and easy reference to the rule details defined in the policy and their severity. With this pop-up, it is easier to understand which policy is applied to different folders without navigating back and forth between policy and assign tabs in the policy manager. It also helps you quickly decide which policy you want to assign to a particular folder.

This policy summary pop-up is provided in the following tabs:

- Policy tab: Click the number of rules.
- Assign tab: Click either the assigned policy or the number of rules in the **Assign policy** option.

## Policy behavior on folder operations

The following table describes the behavior of the policies when certain operations are performed on the folder.

Folder operation	Policy behavior
Create	Folder inherits the policy from the nearest parent folder
Rename	Folder retains the current policy
Move	Folder either retains the current policy or inherits the policy from the nearest parent folder
Delete	The policy assigned to the folder is removed

When you run code analysis on a bot, it uses the applicable policy for the folder (assigned or inherited) where the bot is located.

## Code analysis rules

Rules are the foundation of code analysis. They are used to evaluate the automation (Task Bot and API Task) logic. Rules can be simple or complex depending on the evaluation performed. Rules include coding practices that can be verified. They apply to packages and actions in the automation code.

A rule consists of a unique RULE\_CODE and a description which indicates the nature of the evaluation to be done on the code. You can use the severity levels (low or high) to emphasize the criticality of the rule.

The following table lists the rules and their description that can be used with code analysis:

Rule code	Group	Title	Rule description	Applicable to automation file
ACT-GEN-001	Actions, general	Action Maximum	The number of actions in the bot cannot exceed the specified maximum	Task Bot, API Task
ACT-GEN-002	Actions, general	Try-Catch Coverage	All the non-comment actions within the bot logic must be within a <b>Try/Catch</b> block.	Task Bot, API Task
ACT-GEN-003	Actions, general	Infinite Loop Detection	Mandates the check for infinite loops in the bot logic	Task Bot, API Task
VAR-NMG-001	Variables, naming	Variable Name Pattern	Variable names must match the specified naming pattern	Task Bot, API Task
VAR-NMG-002	Variables, naming	Variable Name Length	Variable names must be within the specified minimum and maximum character length	Task Bot, API Task
VAR-USG-001	Variables, usage	No Unused Variables	All the variables must be used within the bot	Task Bot, API Task
ACT-COM-001	Actions, comments	Mandatory Header Comment	The first action in the bot must be a <b>Comment</b> action	Task Bot, API Task
ACT-COM-002	Actions, comments	Comment Coverage	The number of <b>Comment</b> actions must be equal to or greater than the specified percentage of total command actions	Task Bot, API Task



Rule code	Group	Title	Rule description	Applicable to automation file
VAL-HCV-002	Values, hard coded values	No Hard Coded Delay	The delay time in the <b>Delay</b> action must be set using a variable	Task Bot, API Task
VAL-HCV-003	Values, hard coded values	No Hard Coded File Path	The file or folder path must be set using a variable	Task Bot
VAL-HCV-004	Values, hard coded values	No Hard Coded Email Address	The command action field must not contain a hard-coded email address	Task Bot, API Task
ACT-ERR-001	Actions, error handling	No Empty Catch	The catch block cannot be empty	Task Bot, API Task
ACT-ERR-002	Actions, error handling	Mandatory Catch Logging	The catch block must contain a <b>Log to File</b> action	Task Bot, API Task
ACT-ERR-003	Actions, error handling	Mandatory Catch Screen Capture	The catch block must contain a <b>Screen capture</b> action	Task Bot
ACT-ERR-004	Actions, error handling	Mandatory Catch Line Reference	The catch block error must contain the reference line number	Task Bot, API Task
ACT-LOG-001	Actions, logs	Log to file coverage	The bot logic must contain the specified ratio of <b>Log to file</b> actions	Task Bot

## Checking out code analysis results

As a Bot Creator (RPA developer) or Citizen Developer, you can use code analysis to check and fix any coding errors in your automation files (Task Bot or API Task). You can develop automation based on configured code analysis policies and predefined rules.

With code analysis, you can improve the reliability of your automations by implementing coding best practices such as variable naming conventions, comment coverage, and error handling. Building automations conforming to the predefined guidelines or rules helps you to identify possible errors during automation development. This reduces automation failures in the production environment. You can run code analysis in both your private and public workspaces and view the results.

With code analysis (available from the Bot editor), you get the following benefits:

- Run code analysis as required.
- Get tooltip guidance for compliance with rules.
- Integration with **Assistant** for accounting and guidance.

## Code analysis results

To view the results of code analysis, go to the **Automation** page, and check the **Code Analysis results**. This column shows a summary status of the code analysis results for each automation file (Task Bot or API Task). The following details of each status are available:

- N/A: You will see the not applicable status for any of the following reasons:
  - Code analysis does not apply to the object because the object is not a Task Bot or API Task file.
  - There is no policy assigned to the Task Bot or API Task file or folder. When a Task Bot or API Task file or folder is in N/A status, row level actions for run code analysis option is not shown. Code analysis will not automatically run on these automations that have the N/A status.
- Not Scanned: Code analysis has not been run on the Task Bot or API Task.
- High severity: The Task Bot or API Task has at least one high severity violation.
- Low severity: The Task Bot or API Task has at least one low severity violation, but no high severity violations.
- No violations: There are no code analysis violations in the Task Bot or API Task.

The following image shows an example result from code analysis:

The screenshot displays the Automation Anywhere interface. The top navigation bar shows 'Automation' and 'Private Bot Store'. A sidebar on the left lists folders like 'code\_analysis', 'Document Workspace Pr...', 'IQ Bot Processes', 'My Tasks', 'Sample bots', 'Srilatha', 'TaskBotExample', and 'Bot Store'. The main area shows a table of 'Files and folders (5)'. The table has columns: Type, Name, Status, Source version, Code Analysis results, Size, Last modified, and Modified by. The 'Code Analysis results' column is highlighted with an orange box. The table contains the following data:

Type	Name	Status	Source version	Code Analysis results	Size	Last modified	Modified by
Folder	bulk_checkin	N/A	N/A	N/A	N/A	3 minutes ago	bot_creator
Task Bot	Excel find text which is no...	New	N/A	Not scanned	16.39 KB	23 minutes ago	bot_creator
Task Bot	test_code_analysis	Checked out	3	High severity	2.75 KB	21 hours ago	bot_creator
Task Bot	test_migration	New	N/A	Low severity	1.27 KB	24 minutes ago	bot_creator
Task Bot	test1	New	N/A	Not scanned	2.32 KB	24 minutes ago	bot_creator

At the bottom of the table, there is a pagination control showing '100 per page'.

**Note:** The status of the Task Bots or API Tasks in the code analysis results column is set to not scanned for the following scenarios:

- The automation file is edited in the private workspace and has not been saved yet.
- Code analysis is recently enabled by the administrator or there is a change in any of the rule configuration in the applicable policy for the automation file and the file is waiting to be scanned.

## Reviewing results in Bot editor

When you create an automation file (Task Bot or API Task) or modify an existing automation file and then save it in the Bot editor, code analysis is initiated in the background, and the results are displayed in the **Assistant**. The code analysis header shows the total count of violations in the automation file. You can expand the code analysis option, select a specific object and view the following attributes:

- Applicable object: Displays the automation file, variable, action, and action attribute.
- Rule code: Unique RULE\_CODE ID.
- Severity: High or low.
- Rule text: Description to indicate the nature of evaluation to be performed on the code.

The following image shows an example of code analysis displayed in the Assistant:

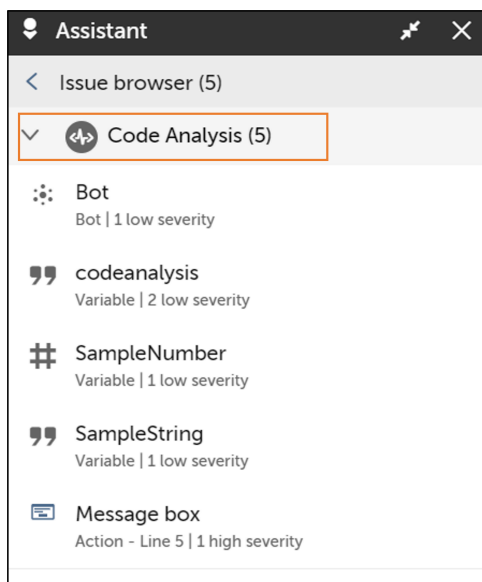

The code analysis results are displayed in the following order:

Attribute	Rules violated
Bot	<ul style="list-style-type: none"> <li>• Mandatory header comment</li> <li>• Comment coverage</li> <li>• Action maximum</li> </ul>
Variable	<ul style="list-style-type: none"> <li>• Variable name pattern</li> <li>• Variable name length</li> <li>• No unused variables</li> </ul>

Attribute	Rules violated
Action	<ul style="list-style-type: none"> <li>No hard-coded delay</li> <li>No hard-coded file path</li> <li>No hard-coded email address</li> <li>No empty catch</li> <li>Mandatory catch logging</li> <li>Mandatory catch screen capture</li> </ul>

The code analysis header displays the count of objects with a violation error within the automation file. Each object can have either low or high severity. The violation is displayed with the attribute followed by the line number and the severity. All the high severity errors are displayed first. Navigate to the corresponding line in the automation file that has the violation, rectify the violation, and save the automation.

You must save the automation file to see the latest code analysis results in the **Assistant**.

## Code analysis violations and policy details in Bot editor

Professional and Citizen Developers can see the code analysis violations in actions at the canvas level. A violation indicator is available for flow and list views, enabling professional and Citizen Developers to quickly see and correct any actions in their automations that have code analysis violations. Code quality is enhanced when developers can easily determine violations and adhere to best practices when they are developing automations.

Professional and Citizen Developers no longer need to navigate to the policies page to view the applied policy and the rules contained in the policy. They can see the current code analysis policy and their rules from directly within the Bot editor from the drop-down menu (access from the three vertical ellipses in the upper right of the Bot editor) . This helps the users who do not have **View policies** and **Manage policies** permission to view current policy and their rules while editing the automation in the Bot editor itself instead of just viewing the violation.

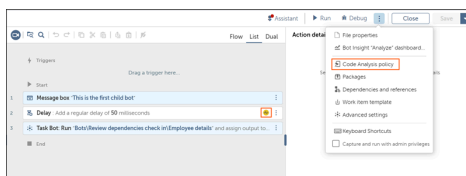

## System-created variables

Variables created by the system such as input or output variables, package-suggested variables, or auto-generated variables (window variables) use the default variable naming case convention from code analysis or Pascal case if no format is defined in code analysis rule.

## Audit log

When code analysis is initiated either by saving an automation file or running code analysis in the Bot editor, the information is captured in the audit log. The following details are captured:

- Bot name
- User information
- The method through which code analysis is initiated (save option or run code analysis option)
- Time taken for the code analysis to run including details such as the number of code lines if captured by code analysis process
- Total number of violations
- Details of the violations

## Code analysis reports

You can access the code analysis report from the **Automation** page after running code analysis. The report is in the form of a downloadable CSV file.

You must have **View content** permission to download the code analysis results in CSV format.

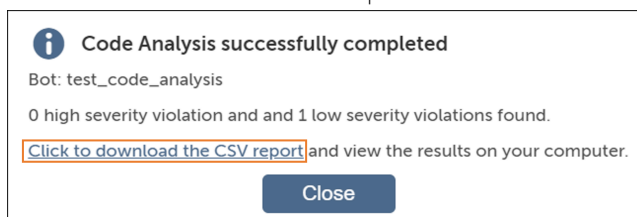

The report contains the results of the code analysis policy. It details the violation, the location of the violation, and the automation file location. The code analysis report consists of the following:

- Rule code
- Rule error message description (with location of the automation file as appropriate)
- Location of the automation file

The following image shows an example code analysis

Rule Code	Rule Error Message	Bot Path
BOT-GEN-1	Number of actions in the bot should not exceed Max '30' lines	Automation Anywhere\Bots\code analysis\code-analysis-demo-bot-has-violations
BOT-VAR-3	Variable 'cnt' should be used in the bot or removed	Automation Anywhere\Bots\code analysis\code-analysis-demo-bot-has-violations
BOT-ERR-1	Action 'Catch' at line 5 should not be empty	Automation Anywhere\Bots\code analysis\code-analysis-demo-bot-has-violations
BOT-COM-1	Missing header comments in the bot file at action line 1	Automation Anywhere\Bots\code analysis\code-analysis-demo-bot-has-violations
BOT-VAR-1	Variable 'cnt' should follow the bot variable naming convention 'Pascal case' (ex: VariableName)	Automation Anywhere\Bots\code analysis\code-analysis-demo-bot-has-violations
BOT-VAR-2	Variable 'cnt' should be within the Min '5' and Max '50' length	Automation Anywhere\Bots\code analysis\code-analysis-demo-bot-has-violations
BOT-HRD-2	Action at line 6 should not include hard coded file or folder paths	Automation Anywhere\Bots\code analysis\code-analysis-demo-bot-has-violations

report:

## Code analysis enforcement

As an administrator, you can enforce code analysis when developers check in bots to the public workspace. You can restrict the RPA developers or Citizen Developers from checking in automations that contain code analysis violations based on permissions assigned to them in their custom role.

Code analysis enforcement is based on a combination of the following:

- Policies applied to folders
- Permissions allocated to users in their custom roles

Code analysis policies apply to files in the **Automation** tab. You can configure the same rule with two different policies but with different severity levels; one with low severity and the other with high severity. By using policies with rules configured at different severity levels, you can focus the enforcement to specific automation projects.

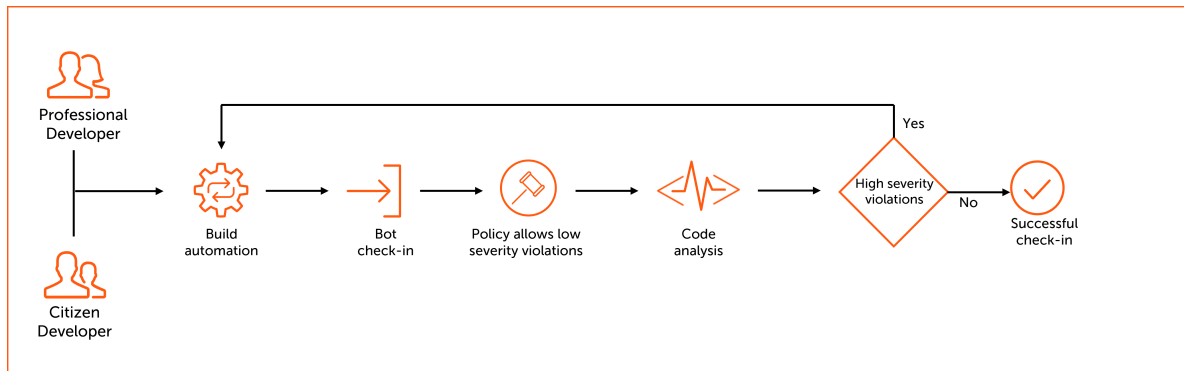

## Code analysis enforcement permissions

The following code analysis enforcement permissions are available:

- **Enable enforcement for bot check-in:** A default permission for all roles which allows the user to check in the automation file if it has no code analysis violations.
- **Allow check-in with low severity violations:** This optional permission allows the user to check in the automation file if it has low severity code analysis violations.
- **Allow check-in with high severity violations:** This optional permission allows the user to check in the automation file if it has high severity code analysis violations.

**Important:** Starting with Automation 360 v.29, all the system roles (such as AAE\_Basic or AAE\_Admin) will have only the permissions to check in bots with no violations. All the custom roles (user-defined roles) are updated to contain both the permissions to check in with low and high severity violations. For enforcement, you should edit your custom roles to restrict check-in. If you use only system-defined roles for your users, to configure enforcement, you must create new roles to assign the appropriate permissions to check in bots with violations.

Use different roles and permissions to restrict automation file check-in based on the skill level of the developer. For example, you can have policies with low and high severity violations applied to a folder. You might have Citizen Developers who are assigned the permission to check in bots with both high and low severity violations, whereas the RPA developers might have the permission to check in bots with no violations or only low severity violations.

You can use different policies on different automation projects and set different rule severity levels for different policies and environments. For example, in the testing environment, you can have policies where all rules are set to high severity, and the RPA developers can only check in bots with low severity or no violations.

## Example

The following example shows three automation files with their code analysis results::

Automation files	Code analysis results
File 1	10 rules with high severity violation
File 2	7 rules with high severity violation 20 rules with low severity violation
File 3	10 rules with low severity violation

The example includes three users with assigned roles:

User	Role assigned
Alice	Role 1
Bob	Role 2
Carol	Role 1, Role 2

- Users in role 1 can check in bots with results of high severity violation.
- Users in role 2 can check in bots with results of low severity violation.

The code analysis enforcement for these users are as follows:

- Alice can check in file 1.
- Bob can check in file 3.
- Carol can check in file 1, file 2, and file 3.

## Configure and assign code analysis policy

As an administrator or a user with view and manage policy permissions, you can configure multiple named policies to define coding best practices to improve the reliability of automations by reducing errors.

Ensure that you have the following permissions:

- View policies
- Manage policies

These permissions allow you to view, edit, and assign policies that define how developers can build automations. They also allow the assignment of policies to folders for which you have access.

- Create policies in the **Policies** tab.
  - a)** In the Control Room, navigate to **Administration > Policies**.
  - b)** Select the **Policies** tab.
  - c)** Select the **Create policy** icon at the top of the policies table.
  - d)** Enter a meaningful name for the policy.
  - e)** Optional: Enter a descriptive comment for the policy.

- f) Select the rules for your automation files (Task Bot and API Tasks). In the **Rules** section, use the on and off slider in the rule tiles to turn on and configure one or more rules for your respective automation files.
- g) Select the **Severity** as either **Low** or **High** to highlight the criticality of the rule.
- h) Click **Save changes** to create the policy.  
A notification appears indicating the policy details are successfully saved.

See the following video to learn how to create named policies:

- Assign a policy to multiple folders in the **Assign** tab.
    - a) In the Control Room, navigate to **Administration > Policies**.
    - b) Select the **Assign** tab.
    - c) Select one or more folders.
    - d) Select the **Assign policy for checked items** icon at the top right of the folders table.  
A policy selector window appears indicating the selected folder name or the number of selected folders.
    - e) In the policy selector window, search for a policy using the search tool at the top.
- 
- Note:** Each policy has a summary of the number of rules.
- 
- f) Select the policy to assign to the selected folders.
  - g) Click **Assign** to assign the policy to the selected folders.

See the following video to learn how to assign named policies:

## Run code analysis

As a Bot Creator (RPA developer) or Citizen Developer, you can run code analysis to evaluate your bots for any coding errors. You can develop automations based on the code analysis policies and predefined rules.

You must have **View content** permission to download the code analysis results in CSV format.

- You can run code analysis only on bots that are error-free. If your bots contain errors, the **Run Code Analysis** option is not enabled. Resolve the errors in your bot to see the **Run Code Analysis** option.
- Code analysis automatically runs on all the bots with the **Not Scanned** status in the public workspace, thereby providing visibility on the coding best practices for all the bots in the public repository. Code analysis runs every five minutes and scans 1000 bot files in five minutes.
- Code analysis is not invoked on API bot files.
- When you run code analysis, if there is a change in the code analysis results status, the last modified time of the bot is updated.
- Run code analysis in the private workspace:
  - a) On the **Automation** page, select the bot, click the actions menu (vertical ellipsis), and click **Run Code Analysis**.



A message is displayed indicating that code analysis is successfully completed, along with a file link with the result of the code analysis.

- b)** Click the file link to analyze the result of code analysis.  
A CSV file with the result of code analysis is displayed.
- c)** Click **Close**.

- Run code analysis in the public workspace: Run code analysis by choosing one of the following options:

Option	Steps
Run Code Analysis	<ol style="list-style-type: none"> <li><b>1.</b> On the <b>Automation</b> page, select the bot, click the actions menu (vertical ellipsis), and click <b>Run Code Analysis</b>.</li> <li><b>2.</b> Select the version of the bot for which to run code analysis:               <ul style="list-style-type: none"> <li><b>a)</b> Latest version</li> <li><b>b)</b> Product label</li> </ul> </li> <li><b>3.</b> Click <b>Continue</b>. A message is displayed indicating that code analysis is successfully completed, along with a file link with the result of code analysis.</li> <li><b>4.</b> Click the file link to analyze the result of code analysis. A CSV file with the result of code analysis is displayed.</li> <li><b>5.</b> Click <b>Close</b>.</li> </ol>

Option	Steps
View history Task Bot	<ol style="list-style-type: none"> <li data-bbox="776 254 1427 348">1. On the <b>Automation</b> page, select the bot, click the actions menu (vertical ellipsis), and click <b>View history Task Bot</b>.  All the versions of the selected bot are displayed on top showing the latest version.</li> <li data-bbox="776 443 1427 646">2. Select a version of the bot, click the actions menu (vertical ellipsis), and click <b>Run Code Analysis</b>.  A message is displayed indicating that code analysis is successfully displayed, along with a file link with the result of code analysis.</li> <li data-bbox="776 663 1427 806">3. Click the file link to analyze the result of code analysis.  A CSV file with the result of code analysis is displayed.</li> <li data-bbox="776 823 1427 848">4. Click <b>Close</b>.</li> </ol>

The following video shows the two ways of running code analysis in the public workspace:

## Upgrade changes in code analysis policy for Automation 360 v.28 or later versions

For Automation 360 v.28 or later versions, there is a change in how policies are managed for code analysis. Advanced policy management provides the flexibility to gradually introduce code quality standards on existing and older projects, and apply firmer standards on newer projects.

If you have configured a code analysis policy in Automation 360 v.27 or earlier, this policy is migrated to a named policy in Automation 360 v.28 or later versions. This preserves any previously configured policy as a named policy, so you can use it with the new named policies feature in Automation 360 v.28.

See [Code analysis policy management](#) on page 2182.

The new named policy will be named default policy and will be applied to the **Automation** page root folder. This policy is applicable to all automation code in all the folders. This is similar to the single policy feature in Automation 360 v.27 and earlier. You can make edits to restrict the default policy to a few folders or automations, and make changes to the enabled rules and their severity.

## Notifications

Notifications is a built-in mechanism in the Automation 360 Control Room, which notifies users about various events. It is a centralized notifications repository in Automation 360 for all users to track relevant events.

The Notifications mechanism provides simplified information about possible risks, warnings, information, and success statistics of the Automation 360 platform and automation events. With

the notifications feature, you can monitor, respond, reduce, and resolve critical risks in much quicker way. It allows you enable required event categories and be notified for the enabled events.

The diagram illustrates the notification configuration process. On the left, three yellow boxes with icons describe the steps: 1. 'Enable or disable notifications for all Control Room users' (person with key icon), 2. 'Enable or disable notifications for individual users' (two people icon), and 3. 'Get notifications for enabled event categories through enabled channels' (bell icon). On the right, a screenshot of the 'Notification settings' interface shows options for 'Automation events', 'Platform events', and 'Process events', along with 'Allow users to control notifications settings' and 'Notification channels' (Email reports). Below the settings is a mobile notification bar with icons for back, help, location, and a highlighted notification bell.

## Benefits

Notifications provide the following benefits:





- Maintain all the notifications from a centralized repository.
- Enhance ability to respond to critical or warning notifications.
- Stay organized with automated notifications to reduce and avoid future risks, and take possible actions.
- Improve productivity of users and the platform by being notified about updates such as Bot export and add or update package.
- Save time and increase notification efficiency because of a single centralized events repository.
- Increase relevance of notifications delivery through multichannel communication.
- Notify Automation 360 users about events through email report or instant email notification.

See the following video for an overview of how notifications are configured in the Automation 360 Control Room:

## Prerequisites

- The Control Room administrator must enable the **Administration > Settings > Notification settings** to receive notifications. For more information, see [Administer notifications for Control Room](#) on page 2205.
- Control Room users must enable the required settings from the **Notifications** repository to receive notifications. For more information, see [Enable or disable event categories](#) on page 2207.

## Components

- Notification icons and navigation:
  -  : Indicates no new notification.
  -  : Indicates new notification.
  -  : Indicates hover over action on the notification icon.
  -  : Indicates select action on the notification icon.
- Notifications panel:

The in-app notification panel provides a comprehensive view of all the event notifications with notification summary and details. For more information, see [Getting started with Notifications](#) on page 2196.
- Notifications filter

The in-app notification panel displays all the notifications as a single list. You can enable the **Attention needed** filter to view and categorize high-risk and cautionary events such as:

  - Stop or impact execution of scheduled tasks or processes
  - Tasks not running as expected or completed with minor recoverable errors.
- **Settings:**

Enable and disable the notifications for **Automation runtime events** and **Platform** events. You can also enable **Email report** channel to receive notifications through email.

## Getting started with Notifications

The notifications repository provides simplified information that users can track for possible risks, warnings, and success statistics of various Automation 360 events.

When you enable required event categories, you receive notifications through the notifications repository. New notifications display with the (  ) icon.

To start working with notifications, set preferences for the following event categories and notification channels:

### Event categories

Events are at the core of the monitoring framework. Users must be able to monitor event continuously, and receive constant notifications. Automation 360 provides notifications for the following events:

- [Automation events](#) on page 2202
- [Platform events](#) on page 2203
- [Process events](#) on page 2204

The following example shows an export bot event notification:



## Notification channels

Notifications are sent through integrated channels used to organize and manage the notifications. Automation 360 send notifications through the following channels:

### Notifications panel

This is the default notification channel. The notifications panel provides a summarized view of all event notifications. It is a list of all the events across the Control Room. For more information, see [Notification summary and details](#) on page 2200.

---

**Note:** The maximum number of days these notifications are available in the Control Room notification panel are:

- Attention needed: 4
- Other notifications: 2

### Email notifications

These notifications generate emails to the opted-in users only. For more information about how to opt-in for email notification, see [Enable or disable event categories](#) on page 2207. There are two types of email notifications:

- Instant notifications: Instant email notification is sent to a user's registered email address.

The following sample shows an email sent for an instant notification:



Hello,

You have the following email from your Control Room administrator  
[john.doe@xyz.com](mailto:john.doe@xyz.com)

Type	Details
Information	Category: Platform events Time occurred: 19 Jul 2023 11:09:30  Your user account has been activated for informational purposes. If you have not already done so, please visit <a href="#">Anywhere's control room now</a> and grant access to your account.

Bonjour,

Vous avez reçu le-mail suivant de la part de l'administrateur  
[john.doe@xyz.com](mailto:john.doe@xyz.com)

Type	Détails
Informations	Catégorie: Événements de la plateforme Temps écoulé: 19 Jul 2023 11:09:30  Votre compte utilisateur a été activé pour des fins informatives. Si vous ne vous êtes pas encore connecté, veuillez visiter <a href="#">control room Automation Anywhere</a> et accorder l'accès à votre compte.

- Email report: Email report notification is sent to a user's registered email address twice a day at a fixed time.

The following sample shows an email sent for an email report:



Hello,

You have the following email from your Control Room administrator:

[john.doe@xyz.com](mailto:john.doe@xyz.com)

**Summary Report**

19 Jul 2023 07:57 AM - 19 Jul 2023 07:56 AM

Attention needed: 0

Information: 8

**Total notification: 8**

**Information**

Category/Time occurred	Details
Automation events 19 Jul 2023 07:57:26	Bot execution completed successfully.
Automation events 19 Jul 2023 07:57:08	Bot execution completed successfully.
Platform events 19 Jul 2023 07:56:51	AAIN1936Z4E9 updates for Setting DeviceT
Platform events 19 Jul 2023 07:56:22	Office 365 Excel package 2.13.2 is now available
Platform events 19 Jul 2023 07:56:20	PDF package 3.9.0 is now available in the c
Platform events 19 Jul 2023 07:56:20	Office 365 Calendar package 2.13.1 is now
Platform events 19 Jul 2023 07:56:19	Microsoft 365 Outlook package 1.1.4 is now
Platform events 19 Jul 2023 07:56:18	Document-Extraction package 3.30.5 is now

**Note:** Notifications that are sent as Instant notifications are not included in the Email report and vice-versa. Based on the event type, notifications are sent either as Instant notifications, or Email report. You cannot configure these notifications.

---

## Notification summary and details

After you enable the required event category, corresponding event notifications are sent through the **Notifications** repository. The notification summary displays an event description with the call-to-action (CTA) link (if applicable) in the description. The notification summary provides information about the event such as successful or unsuccessful execution of bot, license or user related events, and on. The CTA link in notification summary redirects you to the appropriate page or wizard, thus increasing the notification's effectiveness.

---

### **Note:**

- The notification summary varies based on the event type.
  - If a notification have additional details associated with it, you can expand the notification summary by using the expand icon in the top-right corner of the notification.
- 

The following images are sample event notifications for a bot execution events:

- Event notification for a successful bot execution:



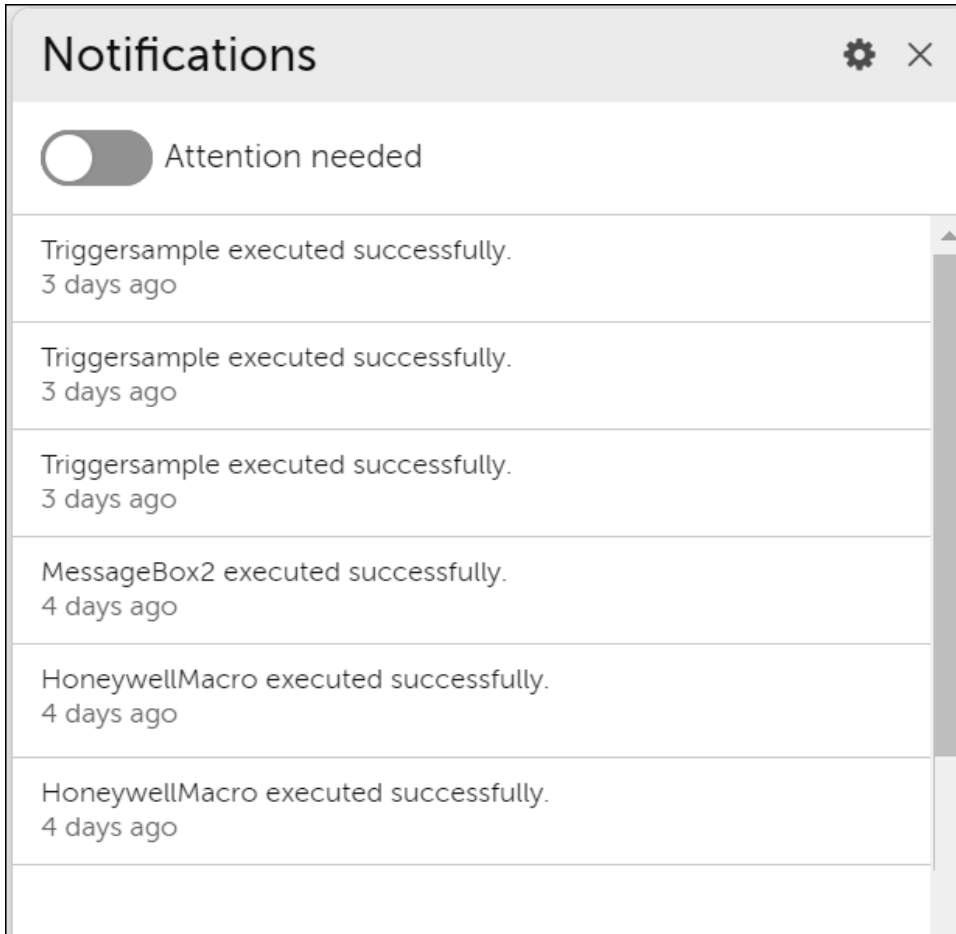

- Event notification for an unsuccessful bot execution:

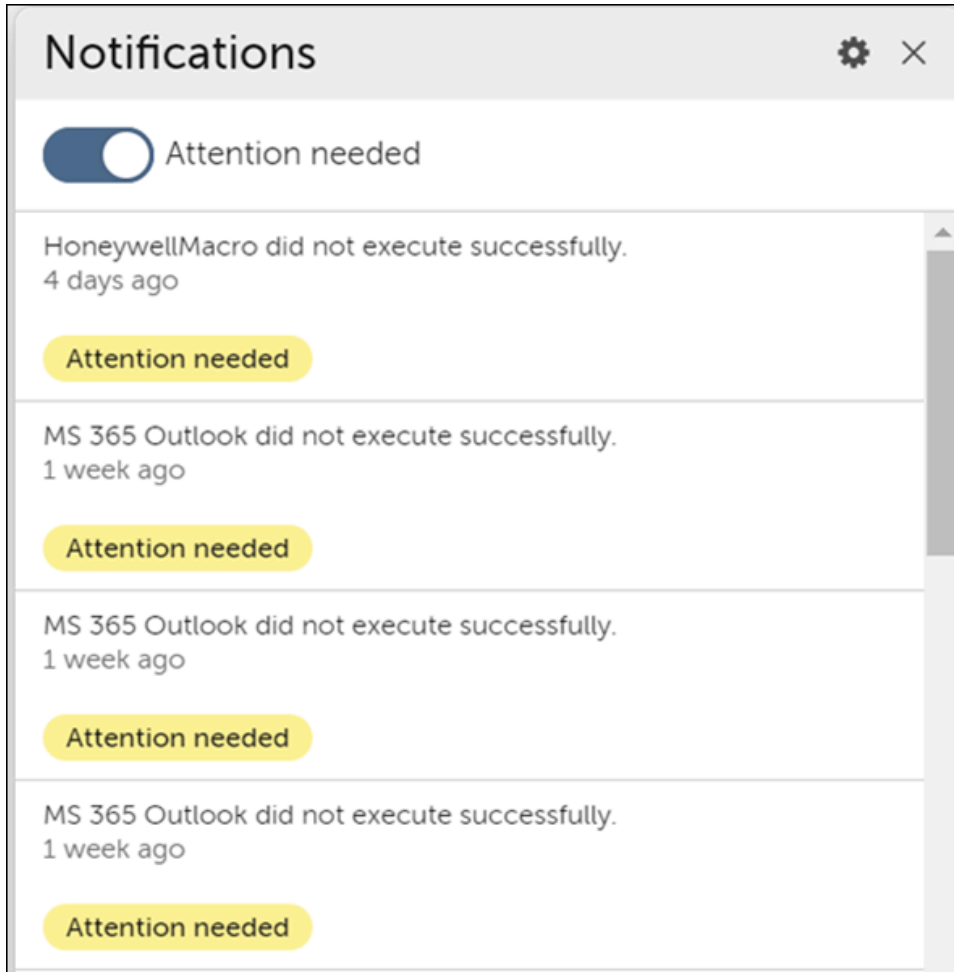

## Automation events

The automation event category is a group of notifications that contains bot-related events such as bot execution successful or unsuccessful.

These notifications are sent to users based on the permissions defined in the Automation 360 platform, and to users who have performed specific tasks, such as export bot. Based on permissions to monitor the bot execution, notifications are sent to the following users:

- Users who starts the bot and have access to monitor the bot execution.
- Users who have access to the bot and can monitor other user's bot execution.
- Users who have access to the bot and can monitor execution based on their respective folders.

---

**Note:** If a user is common in all the preceding scenarios, only one notification is sent to the respective users for all the scenarios.

---

The following table lists examples of the automation event and its severity:

Event name	Users notified for the event	Type of email notification
Bot execution successful	Control Room user who started the bot execution	<a href="#">Email report</a>
Bot export successful	Control Room user who exported the bot	<a href="#">Email report</a>
Bot export unsuccessful	Control Room user who exported the bot	<a href="#">Email report</a>
Bot execution unsuccessful (Application or Data related error, Bot start-up issue, or Bot in unknown or suspended state)	Control Room user who started and is monitoring the bot execution	<a href="#">Email report</a>
Bot import successful	Control Room user who imported the bot	<a href="#">Email report</a>
Bot import unsuccessful	Control Room user who imported the bot	<a href="#">Email report</a>

## Platform events

This category notifies you about events related to the Automation 360 and package updates, device pool, and licenses.

These event notifications are sent to users based on their role and permissions defined in the Control Room. The following table lists examples of the platform events and its severity:

Event name	Users notified for the event	Type of email notification
Add a device to, or remove a device from a device pool		
Add or update package	All Control Room users	<a href="#">Email report</a>
Create or update device pool	Device pool owners	<a href="#">Email report</a>
Enable or disable user account	Notifies only respective users about user account related events such as account enabled or disabled. You can take necessary actions to manage or retain your user account.	<a href="#">Instant notification</a>

Event name	Users notified for the event	Type of email notification
Expired token	<p>An email notification sent to users who have the <b>Manage connections</b> permission. This static information notifies users about events related to expired tokens and provides steps to complete the task and re-authenticate for new set of tokens.</p> <ul style="list-style-type: none"> <li>• Shared tokens: Notification is sent only when the token status is set to expired.</li> <li>• User specific tokens: Notification is sent only one time, when the token is identified as expired.</li> </ul>	<a href="#">Instant notification</a>
Invalid login attempts	<p>Email notification sent to all users who exceeded the maximum allowed login attempts.</p> <hr/> <p><b>Note:</b> A Control Room administrator configures the number of maximum allowed invalid login attempts through the <b>Settings &gt; Security settings</b>. For more information about the the <b>Lock the user out after unsuccessful login attempts</b> option, see <a href="#">Security settings</a> on page 1791.</p> <hr/>	<a href="#">Instant notification</a>
License over subscription or consumption	Email notification to all users with a <b>Manage license</b> permission	<a href="#">Instant notification</a>

## Process events

The process events category notifies you about Automation Co-Pilot for Business Users (Automation Co-Pilot) events. This category includes events related to requests, tasks, and workflows.

When you work with Automation Co-Pilot forms or processes in applications such as Salesforce, Workday, browsers, and desktops for end-to-end process automation, the Control Room notifies you about the request and task events though notifications.

The following table describes various Automation Co-Pilot events:

Event name	Users notified for the event	Type of email notification
Assigned to Me	User assigned to the task	<a href="#">Email report</a>
My Task Expired	User assigned to the task	<a href="#">Email report</a>
Request Cancelled	<ul style="list-style-type: none"> <li>Member of the creating team</li> <li>Creator of the request</li> <li>All previous submitters</li> </ul>	<a href="#">Email report</a>
Request Completed	<ul style="list-style-type: none"> <li>Member of the creating team</li> <li>Creator of the request</li> <li>All previous submitters</li> </ul>	<a href="#">Email report</a>
Request Failed	<ul style="list-style-type: none"> <li>Member of the creating team</li> <li>Creator of the request</li> <li>All previous submitters</li> </ul>	<a href="#">Email report</a>

## Administer notifications for Control Room

As an administrator, you can manage notifications for the Control Room by disabling various notification categories and channels.

Login to Control Room as an administrator.

You can manage notification settings for all the Control Room users and view the audit log information to track user activities.

---

**Note:** All the event categories are enabled by default.

---

1. Navigate to **Administration > Settings > Notification settings**.
2. To enable or disable the required event categories, click **Edit**.
3. Optional: Manage the event categories based on your requirements. For more information about which event category to enable or disable, see [Event categories](#) on page 2196.
  - When an administrator enables the event categories, those are applicable to all the Control Room users.
  - If the Control Room administrator disables one of the event categories, then individual users can view only the enabled event categories in the Control Room **Notifications settings** window.
  - If the Control Room administrator disables all the event categories, then individual users cannot view any of the event categories in the Control Room **Notifications settings** window.
4. Click **Save changes**.

**Note:** Notifications audit logs to track user activities are available at the **Administration > Audit log** page. For more information, see [Audit log](#) on page 2143.

---

## Manage notification channels

As a Control Room administrator, you can manage notification channels through which you want to notify all the Control Room users.

- Login to Control Room as an administrator.
- For On-Premises users, navigate to **Administration > Settings > Email** and enter an email address in the **From this email address** field to manage emails. For more information, see [Edit email notifications](#) on page 1820.

**Note:** This setting does not apply to Cloud users. The region-specific email addresses deliver the notifications in their respective clouds.

---

After you enable the required event categories, enable the required notification channel through which Control Room events are notified to the opted-in users. This feature helps you to notify users through email about events such as a planned maintenance activity. It is useful when you have a dedicated support team for managing the RPA operations.

**Note:** The email channel is disabled by default.

---

1. Navigate to **Administration > Settings > Notification settings**.
2. Click **Edit** to enable or disable the required notification channel.
3. Enable the required notification channel. For more information about notification channels, see [Notification channels](#) on page 2197.

**Note:** Notification channels enabled by an administrator are applicable to all the Control Room users.

---

4. Specify the email address or email distribution list to whom you want to send the email report.

**Note:**

- You can specify multiple email addresses and email distribution lists separated by comma.
- You can send an email notification to a specific email distribution list.
- You cannot send email notifications to public domain addresses such as gmail.com, yahoo.co.in, and so on.

When you specify the email addresses, you confirm that the specified email address or distribution list have permissions to receive email notifications from Automation 360.

5. Select the enable button to customize an email notification template.
  - a) Click **Browse** and select the logo.

**Note:** The following formats are supported for the logo image: PG, JPEG, GIF, and, PNG. Additionally, the size of the logo image should be less than 100KB.

---

- b) You can select the check box to turn off the email footer with Automation Anywhere social media links.

---

**Note:** If you enable the Email template customizations option and make the changes, the previous customized content will be overwritten with the new changes.

---

6. Click **Save changes**.

After applying these changes, you can click **Send me a test mail** option to preview the email template updates by sending a test email to your email ID.

## Lock event categories

As a Control Room administrator, you can lock the set preferences. With this feature, a Control Room administrator can manage a user's access to the event categories that are already set.

Login to Control Room as an administrator.

If this setting is enabled, individual users can enable or disable the required event categories. Otherwise, this setting locks the preference that a Control Room administrator had set.

For example, for attended automation users, the automation administrator does not want individual users to change these settings. To enforce this policy, a Control Room administrator can lock the required preferences and notifications only for those enabled event categories are sent to the users.

1. Navigate to **Administration > Settings > Notification settings**.
2. Click **Edit** to enable or disable the required notification channel.
3. For the **Allow users to control notifications settings**, select one of the following options.
  - **Enable:** When you enable this setting, individual users can change the notification settings in their Control Room instance.
  - **Disable:** When you disable this setting, the notification settings set in the **Administration > Settings > Notification settings** section are locked and individual users cannot change the notification settings in their Control Room instance.

---

**Note:** When **Allow users to control notifications settings** is disabled, all the Control Room users are notified about events based on the enabled event categories in the **Administration > Settings > Notification settings** section.

---

4. Click **Save changes**.

## Enable or disable event categories

As an individual user, you can enable or disable the required events categories to receive notifications, and control notifications traffic in your Control Room instance.

Ensure that the required event category is enabled by Control Room administrator.

1. Click the **Notifications** () icon.

2. Click the Settings (  ) icon in the **Notifications** window.
3. Enable the required event category and close the **Notifications settings** window. For details about which event category to enable, see [Event categories](#) on page 2196.

---

**Note:** The Control Room administrator manages the disabled event categories.



---

## Enable email report channel

As an individual user, you can use the email report channel to notify Control Room users about various events through emails.

Ensure that the required email report channel is enabled by Control Room administrator.

Email notifications are sent as an instant notification or email report based on the event severity identified by the Automation 360 platform. The email report channel is disabled by default.

1. Click the **Notifications** (  ) icon.
2. Click the Settings (  ) icon in the **Notifications** window.
3. Enable the **Email report** option to receive email notifications.  
An email report, containing the Control Room URL and time duration when the report was generated, is sent to the specified email addresses or email distribution list.

---

**Note:** When you enable the email report channel, consider the following information:

- If the Control Room administrator does not enable the **Email report** channel, then individual users cannot enable or disable this option. As a result, individual users cannot be notified through emails.
  - If the Control Room administrator disables the **Email report** channel for a certain duration (for example, maintenance activity over weekend), individual users cannot receive email reports for that duration.
  - The email report is sent to all email addresses and distribution lists specified by the Control Room administrator based on the enabled event categories.
  - If an event is critical and marked for instant notification, then an email notification is sent immediately when the event occurs. Otherwise, it is sent as a part of the email report but the email notification not included in both instant notification and email report.
  - A single email report is sent for all bot events.
  - An email report is sent twice a day, at a fixed time that is 8 AM (PST) and 4 PM (PST).
- 

## Capabilities supporting notifications

With Notifications, you are notified about specific events in Automation 360, such as bot execution tasks and updates to platform and functionalities.

Automation 360 supports notifications for the following capabilities:



## Automation events

For example, export or import bot. When a bot is exported or imported, a notification is sent for these automation events. Based on the result (success or failure) of the export or import bot functionality available in the platform, you receive a notification that contains the event details. This notification is sent only to the user who exported or imported the bot.

For a list of automation events, see [Automation events](#) on page 2202.

## Platform events

For example, add or update package. When a package is added or a new package version is released in the Control Room, you are notified about this platform event. This notification is sent to all the Control Room users who have the **View package** permission. Based on your role and package permissions, you can view event notifications. For package versions information, see [Packages available in Automation 360](#) on page 2316.

---

**Note:** For custom packages, a notification is sent only to the corresponding customer and not to all the Control Room users.

---

For a list of platform events, see [Platform events](#) on page 2203.

## Process events

For example, notifications in embedded automations. Notifications are integrated in business applications (such as Workday, Salesforce) to provide business users updated information about automation events initiated from these business applications. Additionally, you can view these notifications through the Control Room notifications panel. Based on your role and permissions in the Control Room and business applications, you receive a notification. For more information, see [Automation Co-Pilot status and notifications](#) and [Automation Co-Pilot for Business Users supported features](#) on page 3312.

For a list of process events, see [Process events](#) on page 2204.

# Control Room log files

Various types of information about the Control Room are captured in different log files. You can analyze these log files when the Control Room or a bot encounters an error and identify the root cause for that error.

## Overview

The log files capture information about the errors encountered by various components of the Control Room such as the Bot Store, devices, and license. You can use the information in the log files to identify the root cause of an error and resolve that error.

## Log file locations

The Control Room log files are available at `C:\ProgramData\AutomationAnywhere\Logs` on the machine on which you have installed the Control Room. The log files are named `WebCR_<COMPONENT-NAME>`, for example, `WebCR_BotStore`, `WebCR_Devices`, and `WebCR_License`.

You can refer the following log files for the Control Room.

<code>WebCR.log</code>	Contains log entries related to the initialization of the Control Room and messages, if any.
<code>WebCR_UserManagement.log</code>	Contains log entries related to the user management module.
<code>WebCR_Ignite.log</code>	Contains log entries related to the Apache Ignite or caching system.
<code>WebCR_ServerRepository.log</code>	Contains log entries of the server repository related functions.
<code>WebCR_CredentialVault.log</code>	Contains log entries of Credential Vault related function calls.
<code>WebCR_Hibernate.log</code>	Contains log entries related to the Hibernate system, ORM mapping and Query system, ActiveMQ messaging subsystem, and so on.

---

**Note:** For information on the Linux OS directory structure, see [Installed Control Room directories and files](#) on page 1398.

---

# Build automations

Automation 360 provides a browser-based, intuitive experience for users to easily automate tasks and powerful tools for developers to build process automation, delivering security, and governance.

## Overview

Our Automation Workspace is a web-based workspace that provides the tools and capabilities to create, upload, and deploy bots to automate repetitive tasks and processes. It includes the Control Room, Bot editor, Bot Runners, Bot Creators, and Credential Vault.

Automation Workspace provides the following capabilities:

- Automate fast and customize with an actions library for the complicated processes
- Get full visibility and orchestration, from scheduling to automating workloads, with the Control Room
- Assign and manage role-based access with full control and audit trail of every event
- Multi-layered security from cloud to platform to bots ensures granular, privileged access to data.

## Build bots

Use our Bot editor to create and edit bots on any device and from a web browser. See [Bot editor for creating bots](#) on page 2228.

Watch the following videos to get started on building bots:

- Short video on building your first bot:
- Detailed video with a step-by-step guide toward becoming an RPA developer:

For RPA courses, tutorials, certificates and more, visit: [Automation Anywhere University: RPA Training and Certification \(A-People login required\)](#).

Related reference

[Actions to build bots](#) on page 2363

Use actions to build an automation workflow and to instruct a bot what to do. The available actions are located in the Actions palette of the Bot editor in the Control Room.

[Variables overview](#) on page 2326

Automation 360 offers a variety of variables, each designed to hold specific types of data and is intended for specific use. Use the topics below to learn more about each variable and how to use them.

Related information

[Automation Anywhere Bot Store](#)

[Pathfinder Community A-People](#)

[Training - Getting Started with RPA](#)

# Templates

Automation 360 provides (out-of-the-box) templates that you can use to quickly create and build new automations. These templates contain prebuilt automation code structure that you can select based on your business processes.

## Overview

---

### Important:

- Currently, predefined templates are not available in Automation 360. However, you can create and publish your own custom templates based on your business needs.
  - Currently, you can create templates only from Task Bots.
- 

Templates enable teams to automate common business scenarios rapidly and are user-friendly for citizen developers because there is no need for coding skills. For example, the Payroll management team can use predefined templates to generate pay slips for the employees of an organization. Similarly, the Human resource team can use templates to automate processes such as application processing, interview scheduling, employment offers, and employee onboarding, offboarding, and exiting.

## Benefits of templates

- Templates simplify the process of creating automations enabling citizen developers with low or no coding knowledge to use predefined templates for their business use cases.
- Professional developers can use predefined templates to quickly build and customize complex automations.
- Using prebuilt code structures reduces errors and enforces coding best practices.
- Templates enable you to start automation initiatives quickly and efficiently without having to re-enter duplicate information into several automations.
- Templates reduce cost, enhance productivity, and accelerate development.

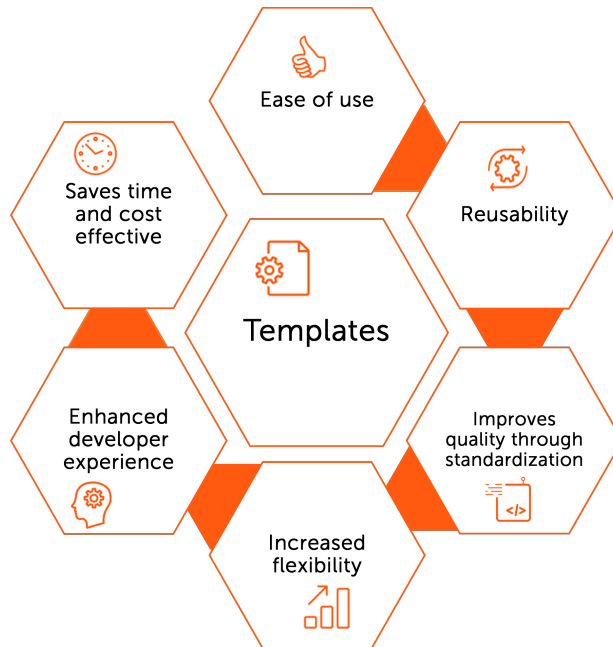

## Templates for user roles

Professional developers: Lead or advanced developers can use, create new templates, or customize the existing ones to build automations.

- Enable developers to develop templates for more complex business cases.
- Improve the reliability of automations by reducing errors.
- Improve process efficiencies for reliable automations by adhering to coding best practices such as placeholders for comments, exception handling, logging, and so on.

Citizen developer: Business users can use predefined templates or create simple templates for their daily automations, such as desktop applications, data collection, data processes, request approvals, and task assignment.

- Templates for common business use cases enable quick and easy application development, ensuring quality.
- Ability to achieve automation goals by following a set structure of code which does not require an in-depth knowledge of packages, actions, or triggers for a specific business use case.

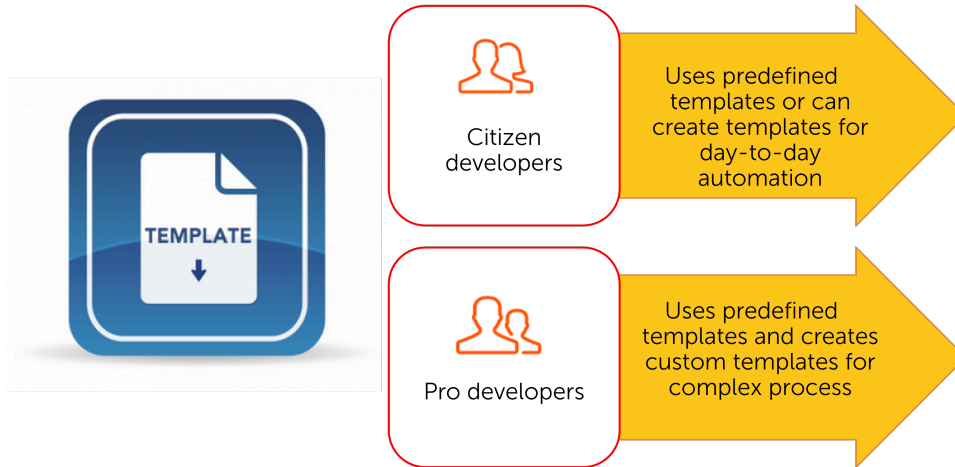

## Permissions

To access the templates, you must have the following permissions:

- View my bots permission
- Additionally, you must have the following permissions on the folders containing the templates you want to update:
  - Check in
  - Check out
  - View content

## Types of templates

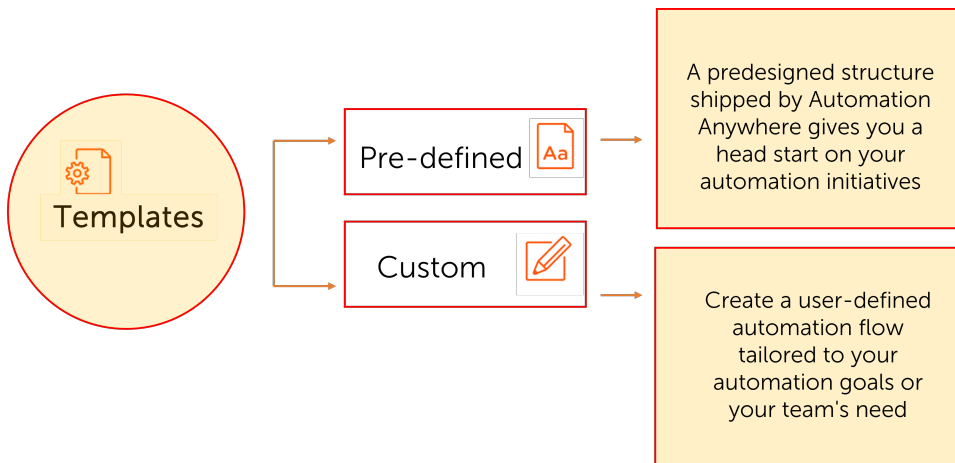

## Using templates

Templates in the private workspace are available only to those users who created them. Templates created in the private workspace can be made available to other users by checking in the template to the public workspace.

Role-based access control (RBAC) does not apply to templates. Depending on your folder or file level permissions where the template resides, you can access all the templates in the public workspace. For example, RBAC is set at the package level, and you do not have access to a particular package but you do have access to a specific template. In this case, you can access the templates but not the packages in the template. A message displays indicating you do not have access to that package.

The following video shows how to create and use templates.

## Create template

Create a template to get a framework containing a list of steps that you can use to automate repetitive work.

For example, your organization runs a biweekly data backup to store and secure data on the cloud, and this process is being automated across multiple departments. Instead of each department building the automation from scratch, they can use templates to customize it based on their own unique requirements.

- This task is performed by a user who has a Bot Creator or Citizen Developer license.
- The user must have **View my bots** permission,
- To check in and check out the templates, user must have **Check in** and **Check out** on the folders of where the template resides.

## Procedure

You can create a template using one of the following methods:

- Use an existing automation
  - 1.** Log in to the Control Room.
  - 2.** On the **Automation** page, open an existing automation.
  - 3.** Add new actions or modify the existing property values in the automation.
  - 4.** Click **Save as Template** to save the template.

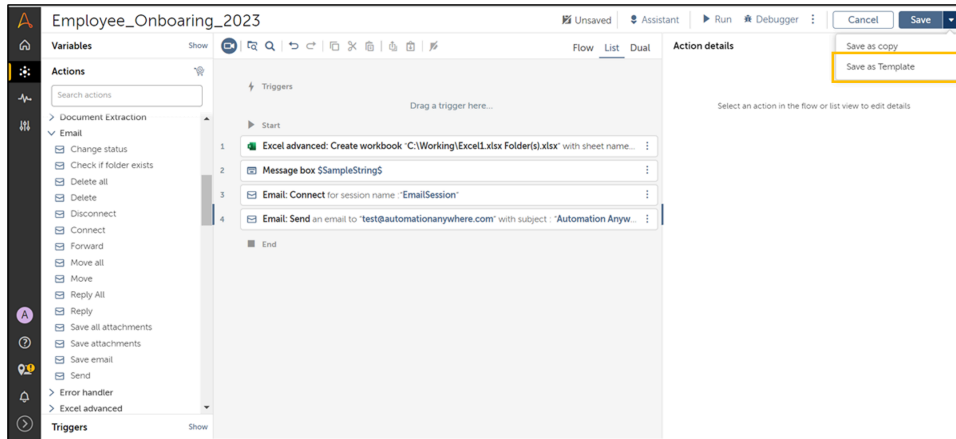

- Create a new template
  1. Log in to the Control Room.
  2. Create a new template.

**Note:** Currently, you can create a template only from a Task Bot. This option creates an automation as an intermediate step. If you do not plan to edit or use the automation, you can delete it.

- a) On the left pane, click **Automation**.
- b) Click **Create new > Task Bot**.
- c) In the **Create Task Bot** window, enter the template name.
- d) Accept the default folder location: `\Bots\`.

To change the default template storage location, click **Choose** and follow the prompts.

- e) Click **Create and edit**.

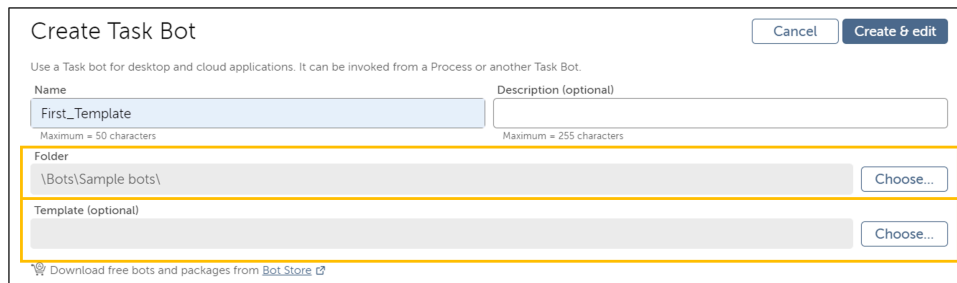

3. Based on your use case, you create a custom template in the Bot editor using actions from the **Action** pane, and then select the **Save as Template** option.



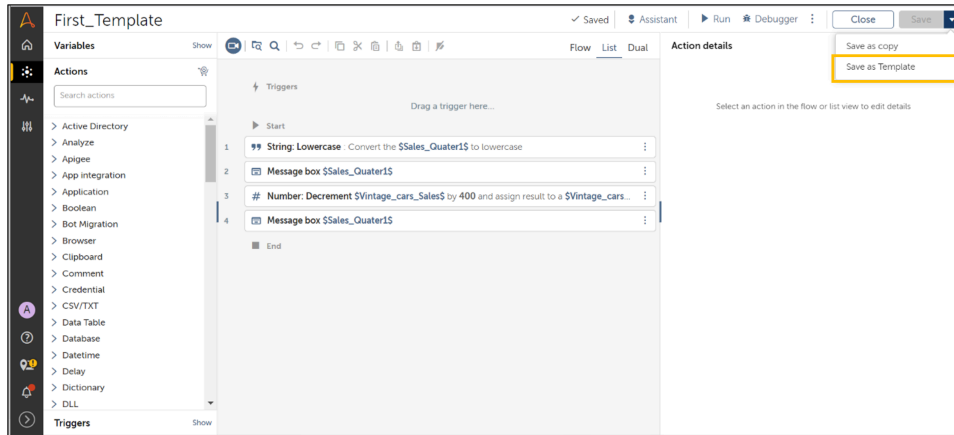

4. In the window that opens, enter the template name, description, and path, and then click **Save**.

## Edit a template

Use the **Edit template** option to add, modify, or delete actions and automation steps based on your business scenarios.

**Note:** You cannot edit a template in the public workspace. You can check-out the template from the public workspace to edit it in the private workspace.

1. Log in to the Control Room.
2. On the left pane, click **Automation**.  
A list of available templates and automations is displayed.
3. Perform the following steps to edit a new or checked-out template in the private workspace.
  - a) Click the actions menu (vertical ellipsis) and click **Edit Template**.  
The template opens in the edit mode in the Bot editor.
  - b) Click any action in the editor that you want to update.
  - c) Edit the required fields.  
You can modify the existing property values or delete actions.
  - d) If required, add new actions or files you want to add as dependencies.
4. Click **Save**.

## Create automation from a template

You can use a template to build an automation. As a Citizen Developer or Professional developer, you can select from prebuilt templates and create new automations based on your automation goal.

- This task is performed by a user who has a Bot Creator or Citizen Developer license.
- The user must have **View my bots** permission.
- The user must have **Check in** and **Check out** permission on the folders of where the template resides.

1. Log in to the Control Room.
2. Create a new automation from templates.

- a) On the left pane, click **Automation**.
- b) Click **Create new > Task Bot from Template**.

You will see all the available templates in the **Create Task Bot from Template** window.

- c) Search for a specific template in one of the following ways: search for the template name or description, or select the template.

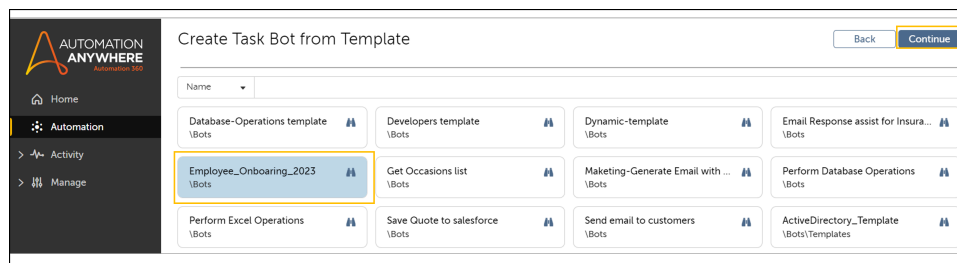

- d) Click **Continue**.  
You can also click the **View template** icon to open template in the Bot editor and view it.
- e) In the **Create Task Bot from Template** window, enter the automation name.
- f) Accept the default folder location: `\Bots\`.  
To change the default automation storage location, click **Choose** and follow the prompts.
- g) Click **Create and edit**.

After entering the automation details, the Bot editor is displayed. The automation structure is added to the canvas, and you can start editing a template.

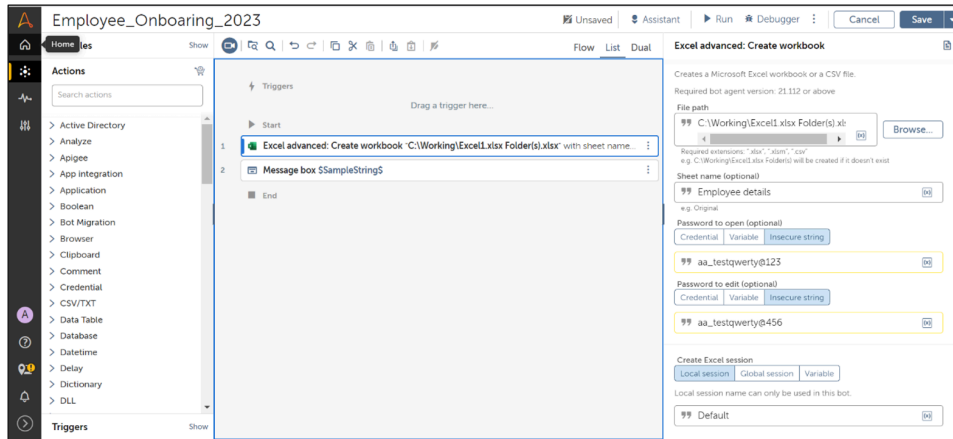

3. If required add more actions to the workflow, edit the properties of the existing actions, or delete specific steps.
4. Click **Save**.

Additionally, you can select **Save as copy** to easily have a copy of an existing automation.

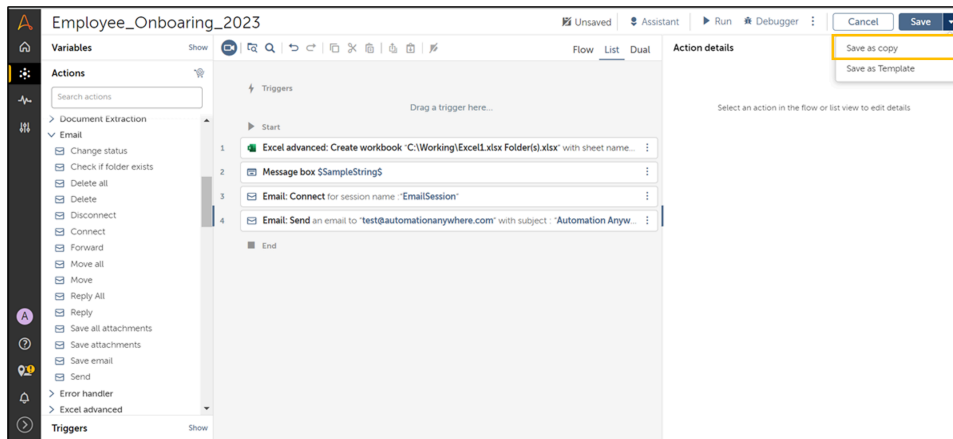

## Copy a template

Use the **Copy Template** option to quickly duplicate existing templates and make similar updates, instead of building the template from the start.

1. Log in to the Control Room.
2. On the left pane, click **Automation**.  
A list of available templates and automation is displayed.
3. Mouse over the actions menu (vertical ellipsis) corresponding to the template that you want to copy.
4. Click the **Copy Template** icon.
  - a) In the **Copy file** window, enter a name for the duplicate template.

---

**Note:** The name must be unique if you want to create a copied template in the same folder location.

---

- b) Optional: Click **Browse** to select the folder where you want to save the template.
- c) Click **Copy**.

The duplicate template appears in the specified folder.

## Delete a template

You can use the **Delete Template** option to delete templates that are not in use and to keep the private repository organized.

Before you delete a template, review the following prerequisites:

- Public workspace: You must have the Control Room administrator role or the **Delete from Public** permission at the folder level.
- Dependent folders and files: You must have the **Delete from Public** permission on these folders and files.
- Private workspace: You must have a Bot Creator or Citizen Developer license.

---

### Important:

- You cannot delete a template if it is referenced by other templates or automations. You must first remove the references before deleting the template.
  - You cannot restore a deleted template, so ensure that you no longer require a template before deleting it.
- 

Perform the following steps to delete a template from a private or public workspace.

- Delete templates from a private workspace

---

**Note:** In a private workspace, you can delete only templates that are in the **New** or **Cloned** status. You cannot delete a template in the **Checked out** or **Checked out and edited** status.

---

1. Log in to the Control Room.
2. On the left pane, click **Automation**.  
A list of available templates and automation is displayed.
3. Select the template. Mouse over the actions menu corresponding to the template that needs to be deleted and then click **Delete Template**.
4. Click **Yes, Delete**.

- Delete templates from a public workspace

---

**Note:** In the public workspace, you can delete only templates that are in the **Public** status. You cannot delete templates that are in the **Checked out** status.

---

1. Log in to the Control Room as an administrator, a Bot Creator, or a user with **Delete from Public** permission.
2. On the left pane, click **Automation**.

A list of available templates and automation is displayed.

3. Select the template. Mouse over the actions menu corresponding to the template that needs to be deleted and then click **Delete Template**.
4. Click **Yes, Delete**.

## Check in a template

Check in templates to the public workspace from the private workspace to make them available for all users with permission to create and edit the templates.

Check-in of templates is essential so that Citizen Developer or other users can see all the available templates in the public repository and can use them to create automations.

- You must have a Bot Creator or Citizen Developer license to check in a template to the public workspace.
- You must be assigned a custom role with the following permissions:
  - **Check in** permission at the folder level and at the corresponding parent folder level in the public workspace.
  - To check in a template with dependent folders and files, you must have **Create folder** permission on the corresponding folders.

For example, if you are checking in a template from your private workspace and if the folder in which the template is present does not yet exist in the public workspace, you must have **Create folder** permission to successfully check in the template.

1. Log in to the Control Room.
2. On the left pane, click **Automation** and then select **Private**.  
A list of available templates and automation is displayed.
3. Check in either one template or multiple templates simultaneously.
  - Check in single template
    - a) Select the template that you want to check in, click the actions menu (vertical ellipsis), and click **Check in Template**.
    - b) In the **Check in file** window, add your comment and click **Check in**.

---

**Note:** Directly referenced dependencies are checked in by default.

---

- Check in multiple templates

---

**Note:** You can check in up to 10 templates at a time.

---

- a) Select **Check all** or select the templates that you want to check in, and from the table level icons click **Check in checked items**.
- b) Add the comment and click **Check in**.
- c) Optional: Select **Advanced option**, add the comment, select the files you want to check in, and click **Check in**.

The template appears in the same folder structure in the public workspace. For example, when you check in a template from the sample template folder in the private workspace, it will appear in the sample template folder in the public workspace. Directly referenced dependencies are selected for check in by default. You can review and select other dependencies to check in.

## Check out a template

Professional developer or Citizen Developer, you can check out templates from the public workspace to the private workspace to create an editable copy of the template in the private workspace and make further modifications based on changes in your business scenarios.

After you have modified the template, you can check in the template again to the public workspace so that it can be deployed by all users who have permission to access it. You can choose the specific version of the template along with their dependencies during the check-out process.

- You must have a Bot Creator or Citizen Developer license to check out a template to your private workspace.
- You must be assigned a custom role with the following permissions:
  - **Check out** permission at the folder level.
  - **Check out** permission on the dependency folders to check out a template with dependent folders and files.
  - To check out a template with dependent folders and files, you must have **Create folder** permission on the corresponding folders.

1. Log in to the Control Room.
2. On the left pane, click **Automation** and then select **Public**.  
A list of available templates and automation is displayed.
3. Check out either one template or multiple templates simultaneously:
  - Check out single template
    - a) Select the template you want to check out, click the actions menu (vertical ellipsis), and click **Check out Template**.

---

**Note:** If a template has multiple versions, you can select and check out the specific version of the template using **Advanced** options. This enables you to roll back to an earlier version of the template.

---

- b) In the **Check out** window, choose any one of the following options:

Option	Steps
<b>Yes, Check out</b>	Select this option to check out the latest version of a template. The dependencies are cloned automatically.

Option	Steps
<b>Advanced options</b>	<p>Select this option to select a specific version of the template and dependencies.</p> <ol style="list-style-type: none"> <li><b>1. Click <b>Advanced options</b>.</b> The <b>Check out</b> file window opens.</li> <li><b>2. <b>Version</b>:</b> Select the version of the template to check out, click the right arrow, and then <b>Next</b>.</li> <li><b>3. <b>Check out Dependencies</b>:</b> From the <b>Available dependencies</b>, choose the dependencies to check out, and then click <b>Next</b>.</li> <li><b>4. <b>Versions for dependencies</b>:</b> Select the version of the dependency to check out.</li> <li><b>5. <b>Review other dependencies</b>:</b> (Overwritten, Missing, Cloned, or Skipped).</li> <li><b>6. Click <b>Check out</b>.</b></li> </ol>

- Check out multiple templates
  - a)** Select the templates you want to check out and from the table level icons, click **Check out checked items**.
  - b)** In the **Check out** window, choose any one of the following options:

Option	Steps
<b>Check out</b>	<p>Select this option to check out the latest version of a template. The dependencies are cloned automatically</p>

Option	Steps
<b>Advanced options</b>	<p>Select this option to review the information about the template and dependencies which can be checked out, skipped, or cloned and then click <b>Check out</b>.</p> <ul style="list-style-type: none"> <li>• The <b>Files</b> tab displays the available and selected files. You can add or remove files to check out.</li> <li>• The <b>Checkout Dependencies</b> tab displays the dependencies which you can choose to check out.</li> <li>• The <b>Review dependencies</b> tab displays information on the dependencies which are Overwritten, Missing, Cloned, or Skipped.</li> </ul>

After you check out the template with its dependencies, it appears in the same folder structure in the private workspace. However, if you do not select the dependencies to be checked out, it will be cloned in your private repository.

## Cancel template check out

You can cancel templates that were checked out and no longer need to be updated. You can use the **Cancel check out for Template** option either from the public or the private workspace.

You must have the **Cancel checkout** and **View content** permissions on a public workspace to cancel or undo a check out performed by a Bot Creator or Citizen Developer user.

You do not require the **Cancel checkout** permission to cancel the checked out template from a private workspace.

You can cancel the checked-out template from your private workspace. Similarly, you can cancel the checked-out templates from the public workspace to releases the template for another user who has access in the public workspace. When you cancel check out, the template status changes to **Public** in the public workspace. In the private workspace, the status changes to **New** if any edits are made to the template. If there are no changes, the template is replaced with a clone.

1. Log in to the Control Room.
2. On the left pane, click **Automation**.
3. Select the template. Mouse over the actions menu corresponding to the template that needs to be canceled, and then click **Cancel check out for Template**.
4. Click **Yes, Cancel check out**.



## View version history of template

The **View history** option enables you to view the history of changes that have occurred on a template. The history includes actions performed by the user during a specific date and time, along with check-in messages.

- You must have either the check-in or check-out permission.
- You can view the version history of the templates available in the public workspace.

1. Log in to the Control Room.
2. On the left pane, click **Automation**.

A list of available templates and automations is displayed.

3. View the version history of templates in the following ways.
  - Select the template for which you want to view version history. Hover over the actions menu (vertical ellipsis) located to the right of the template name and click **View history**.
  - Click the template name. When the template opens in the Bot editor, click the vertical ellipsis at the top-right corner and select the **View history** option.

The **View history** window opens listing all the versions of the selected template in a sequence (latest revision on the top and the first revision is at the end). The information includes the version number, check-in message, checked-in date and time, and checked-in by username.

## View template dependencies and references

You can view dependencies and references of a template in both public and private workspaces. The **View dependencies and references** option shows files added as scanned or manual to a template as its dependencies.

With this information, you can understand the impact of the change in a template, maintain better code and reusability, and prevent conflicts.

Ensure that you have the **View content** permission.

1. Log in to the Control Room.
2. On the left pane, click **Automation**.

A list of available templates and automations is displayed.

3. Select **Public** or **Private** to view the dependencies and references of a template in the following ways:
  - Select the template for which you want to view dependencies. Hover over the actions menu (vertical ellipsis) located to the right of the template name and click **View dependencies and references**.
  - Click the template name. When the template opens, click the vertical ellipsis at the top-right corner and select **View dependencies and references**.
  - Toggle between the **Dependencies** and **References** tabs to view the immediate files (parent and child Task Bots or templates).
    - **Dependencies**: Displays the files that the templates depend on.

- **References:** Displays the files that depend on the template.

## Import templates

You can import a template with their dependencies from one Control Room to another to make it publicly available to developers of multiple Control Room instances.

- Ensure that the following permissions are enabled to import templates:
  - **Import** bots permission
  - Manage package feature permissions
  - **Create folder** permission (if required)
  - **Check-in** to public workspace permission if you are importing to the public workspace.
- You must have a Bot Creator or Citizen Developer license to import templates either into the private workspace or public workspace.

You can import templates into the public workspace if you have the required permissions, regardless of your license.

- Ensure that the version of Control Room and templates in the source and target Control Room instances are same for import as well as export.

1. Log in to the Control Room.
2. On the left pane, click **Automation**.  
A list of available templates and automations is displayed.
3. Click **Manage bots > Import**.

---

**Note:** This option currently applies to both bots and templates.

---

4. Browse and select the required zip file that you want to import.
5. Select the private workspace or public workspace.
6. If the exported template or file is password-protected, enter the password when prompted.  
You can get the password from the user who exported this template or file.
7. If some of the files that are being imported are already available in your Control Room, select one of the following options.
  - **Skip the bot or file (don't import it)**
  - **Overwrite the bot or file with the imported one**
8. Click the **Import bots** option.
9. After the import is complete, based on your source environment, navigate to the corresponding repository (private or public, based on your selection in Step 4) to find and use the imported template.

## Export templates

You can export a template with their dependent files from one Control Room to another.

- Only templates within the public workspace can be exported. To export a template, check in the template into the public workspace.
- You must have **Export bots**, **View package**, and **Check in** or **Check out** permissions to the required folders.
- Ensure that you have the View content rights at the folder level from which you want to export the template.
- To export the templates from one Control Room to another, both Control Room instances must be the same version.

1. Log in to the Control Room.
2. On the left pane, click **Automation**.  
A list of available templates and automations is displayed.
3. In the public workspace, use one of the following options to export templates:
  - Click **Manage bots > Export**.
  - From the table level icons, select **Export bots**.

---

**Note:** These two options currently applies to both bots and templates.

---

- Click the actions menu (vertical ellipsis), and then click **Export Template**.

The selected template as well as the required dependencies are displayed.

4. Select the template you want to export.

---

**Note:** You can select only the latest version of the template to export. Currently, the production label is not supported.

---

5. Click the right arrow (→) to add your selection and then Click **Next**.
6. Select the dependencies of the templates.
7. Click **Next**.

All related packages are displayed.

8. Select the necessary packages associated with the template to export.
9. Optional: You can select **Exclude bot packages** check box to remove all packages from the export.
10. Enter the name in the **Export name** field.
11. Optional: Enter and confirm your password.

Adding a password enhances the security for your templates or file when exporting from one Control Room to another.

12. Click **Export bots and files**.

All selected templates are exported into a zip file.

If you have configured SMTP, an email is sent that contains a link to the zip file of the exported template. If you have not configured SMTP, perform the following steps to access the link to the zip file of the exported template:

- a) Navigate to **Activity > Historical**.

- b) Search and view the historical activity of the exported template.
- c) Click **Download exported zip file**.  
A link to download the zip file is displayed.
- d) Use the link to download the zip file and save it to a location for importing it to another Control Room.

---

**Note:** If you are exporting a large size template or dependency, there might be a delay in the download of the export zip file from the **Activity > Historical**.

---

## Templates - Known behaviors

Review some of the known behaviors when using the template feature.

- Automation 360 premade templates are currently not available to use. However, you can create and publish custom templates based on your business needs.
- You can create templates only from Task Bot. Creating templates from **Forms** and **Process Composer** are currently not supported.
- On the **Automation** page, when you select the **Task Bot from Template** option, the **Create Task Bot from Template** window will display templates only if they are already published in the public workspace.
- When you create and save a template with empty properties, an error icon is not displayed as the system allows you to save a template without adding any property value.
- **Run** and **Schedule** options do not apply to templates.
- When you export and import templates from one Control Room to another, the description of the templates is not retained.
- You cannot use the following capabilities in templates as they are not currently supported: Clone, move, setting production label, compare versions, code analysis, and Bot insight.
- You create automation from a template that has pre-filled properties, and if you navigate to the private workspace without making any changes to the automation, you will see the automation highlights the error icon, and when you click the actions menu (vertical ellipsis), the **Check in Task Bot** will not be visible to use.

Workaround : When you create an automation from a template that has pre-filled properties, ensure you edit the automation and save it.

## Bot editor for creating bots

The Bot editor enables users to create and edit bots on any device and from anywhere the user can access a web browser.

### Overview

Because Automation 360 is web-based, there is no separate client to download. Access the Bot editor by logging in to Automation 360, navigating to **Automation** on the left panel, and then creating or opening a bot.

The Bot editor is a web-based environment and includes the following features:

- Universal Recorder to simplify capturing processes
- Search for a bot from the public workspace and your private workspace and add that bot to the current bot.

The location of the selected bot in the public and private workspaces is also displayed.

---

**Note:** An error occurs if you add a bot from a folder in the public workspace for which you do not have the **Clone** permission for that folder.

---

- Powerful bot code management
- Python and JavaScript actions support inline scripting without linking, with drag-and-drop integration
- Rich variable passing, with no cross-language mapping required

## Bot editor

Use the Bot editor to create and edit any bot through a web browser, regardless of the device or location. When you create a bot or modify an existing bot, the Bot editor is displayed.

You can create a bot by using the following options:

- On the **Home** page, click **Create a bot**.
- On the **Automation** page, click **Create new > Bot** in the top-right corner.
- 

In the **Files and folders** table, click **Create a bot** (  ).

You can modify a bot by using the following options:

- On the **Automation** page, select the bot to modify, click the actions menu (vertical ellipses) and click **Edit Task Bot**.
- Select and open the bot you want modify.

See also the video at the end of this page on how to get started with the Bot editor.

There are three view options for bot creation:

---

**Note:** You can use the search box in the **Flow**, **List**, or **Dual** view to search for text, variables, or actions in a bot. This feature can be helpful when you view or edit a bot with longer code lines.

---

- **Flow:** Displays actions used in an automation as a flow diagram (Default)

---

**Note:** The **Flow** view is not available when you create or edit a bot and the bot exceeds 500 lines of code. Use the **Show list view** option to navigate to the list view.

---

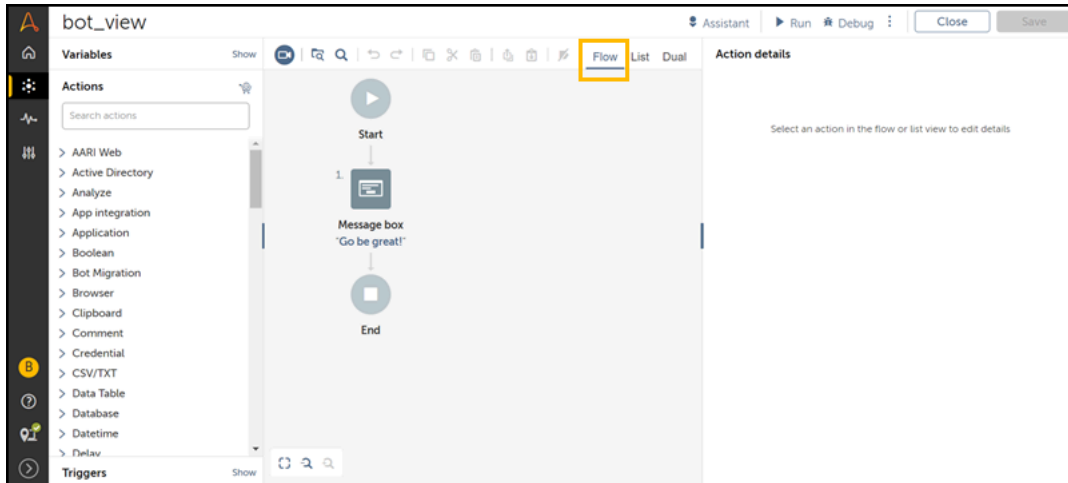

- **List:** Displays the actions used in an automation as a list

**Note:** Drag the selected actions within the task logic.

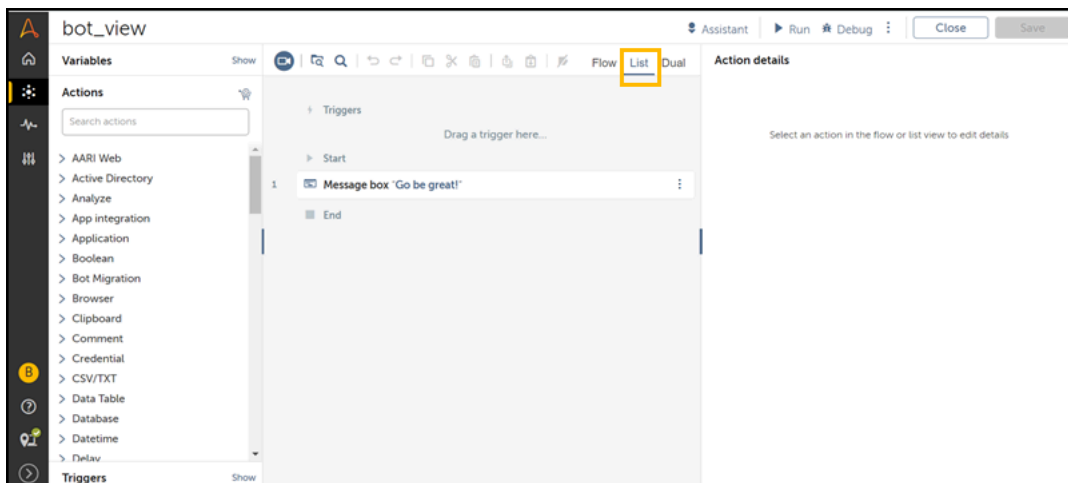

- **Dual:** Displays the actions used in an automation from both **Flow** and **List** view aspects

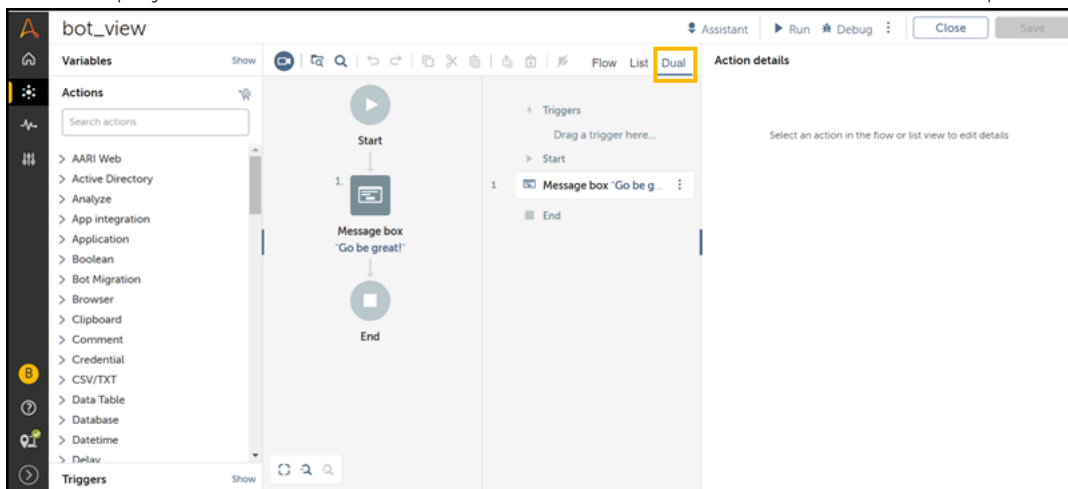

The **Flow**, **List**, and **Dual** views display the following properties of actions:

- The value that you enter for actions such as **Set text** for all the supported technologies
- Names of the objects on which actions such as **Set text**, **Click**, **Left click**, **Get property**, and **Select item by index** are performed
- Name of the object property mentioned in the action
- Name of the return variable if some value is assigned to a variable
- List of properties for the **Get property** action

See the video on enhanced bot building experience on Bot editor and AISense for Citizen developers.

## Code analysis violations and policy details in Bot editor

Pro and Citizen Developers can see the code analysis violations in actions at the canvas level. A violation indicator is available for flow and list views, enabling Pro and Citizen Developers to quickly see and correct any actions in their automations that have code analysis violations. Code quality is enhanced when developers can easily determine violations and adhere to best practices when they are developing automations.

Pro and Citizen Developers no longer need to navigate to the policies page to view the applied policy and the rules contained in the policy. They can see the current code analysis policy and their rules from directly within the Bot editor from the drop-down menu (access from the three vertical ellipses in the upper right of the Bot editor) . This helps the users who do not have **View policies** and **Manage policies** permission to view current policy and their rules while editing the automation in the Bot editor itself instead of just viewing the violation.

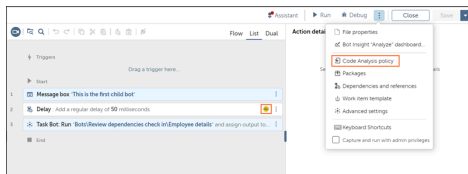

## Bot Assistant

When you create a bot, use the feature Bot Assistant to get a comprehensive view of line numbers of the bots that require your action.

The Bot Assistant displays the name of the packages or action and line number on which action is required by you. When you click the line number, it directly takes you to the line where the error occurs.

For migrated bots, the Bot Assistant displays a comprehensive view of the package or action and line numbers of the bots that require review or action by you.

## More resources

- Free Automation 360 bots and command packages from Bot Store: [Automation 360 and AARI pre-built automation](#)
- [Create your first bots](#)

Related tasks

[Edit a bot](#) on page 2313

Edit bot logic using the Bot editor to add, modify, or delete actions and automation steps.

[Run a bot](#) on page 2282

You can run a bot to test an automated process.

## Using Bot editor

As a Bot Creator, you can build bots on the workbench and perform various bot operations. The Bot editor provides an easy to use feature-rich experience.

### Default view in the Bot editor

We provide implicit preference to retain the default view, so you do not have to set them explicitly in the Bot editor. When you create or modify an existing bot in the Bot editor, your preferred default view (List, Flow, or Dual) will persist; and if you switch to another browser or log out and log back into the Control Room, you will see your default view. When you open a bot in the Bot editor, the default view is displayed as follows:

- If you open the bot for the first time, **Flow** view is shown as the default view. However, you need to change the view by selecting it based on your preference so that you can see the same view upon your subsequent login.
- For all subsequent visits to the Control Room, your last selected view will be set as the default view.

The set default view remains the same across browsers and user sessions.

### Line markers for collapsible sections of code

When you create bots using **Loop**, **If/If-else**, **Step**, **Trigger-loop**, **Try**, **Catch**, and **Finally** statements, you will see the visually highlighted collapsible sections on the Bot editor. These visual indicator line markers are displayed at the beginning and end of the collapsible section. Additionally, when you select the collapsible section a line displays that connects the beginning and end brackets.

---

**Note:** The visual indicator line marker for the collapsible section applies only to the **List** view in the Bot editor.

---



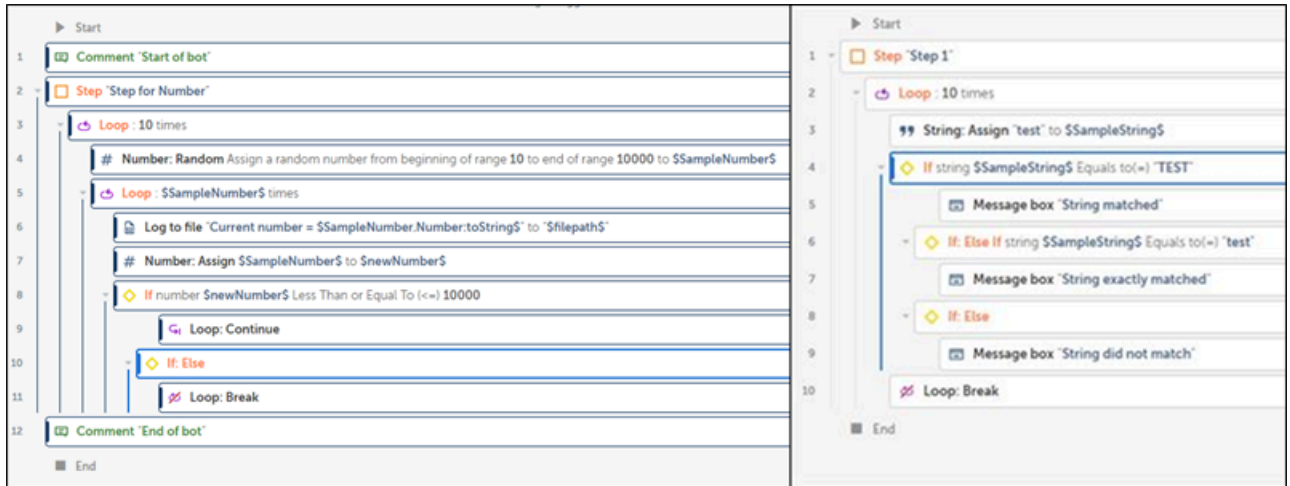

### Error messages with descriptive information

When you create a bot where the parent bot calls a child bot, and if an error occurs in the child bot, the error message displays the following details:

- Line number of the parent bot which ran the child bot.
- Line number of the child bot where the error occurred.
- Error message details, such as what went wrong with that line number and the corresponding corrective action.

The following example shows different error messages displayed during runtime:

- One parent bot calls two child bots.

For example, you build a parent bot such as `Bonus calculation`. The parent bot calls the child bot `Company performance`, and then the child bot `Company performance` calls another child bot `Profits2022`. If the error is in the child bot `Profits2022`, the following error message will be displayed:

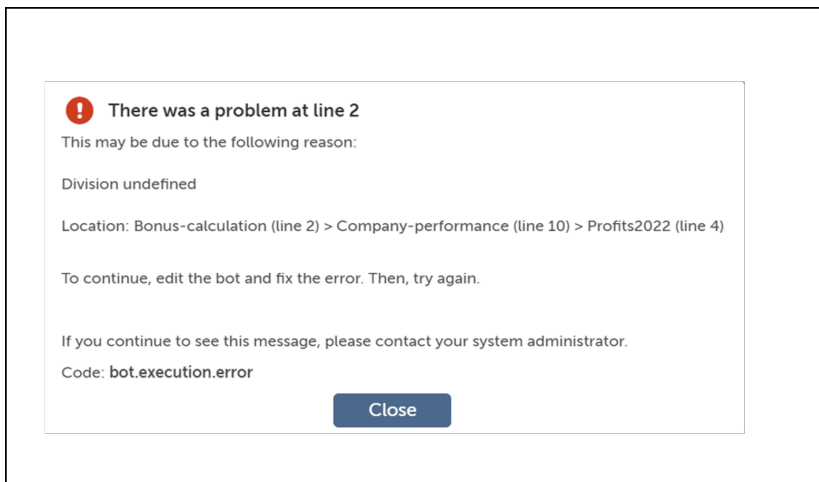

View the following video that outlines the sample error scenario

- One parent bot calls multiple child bots.

For example, you build a parent bot such as `Bonus calculation`. The parent bot calls the child bot `Company performance`, and then the child bot `Company performance` calls another child bot `Employee performance`. Then `Employee performance` calls **Completed targets > Profits2022**. If the error is in the child bot `Profits2022`, the following error message will be displayed:

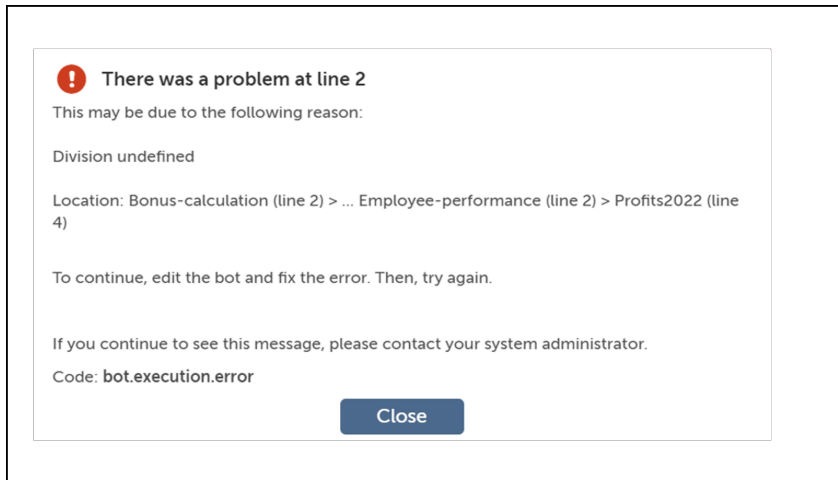

## Keyboard shortcuts to expand or collapse elements in bot logic

When you are creating a large bot, you can expand or collapse sections using keyboard shortcuts in both **Flow** and **List** views.

By using this feature, you can improve your productivity as a Bot Creator. It enables you to use keyboard shortcuts in a specific section or all sections, and you can move quickly through the process of developing a bot.

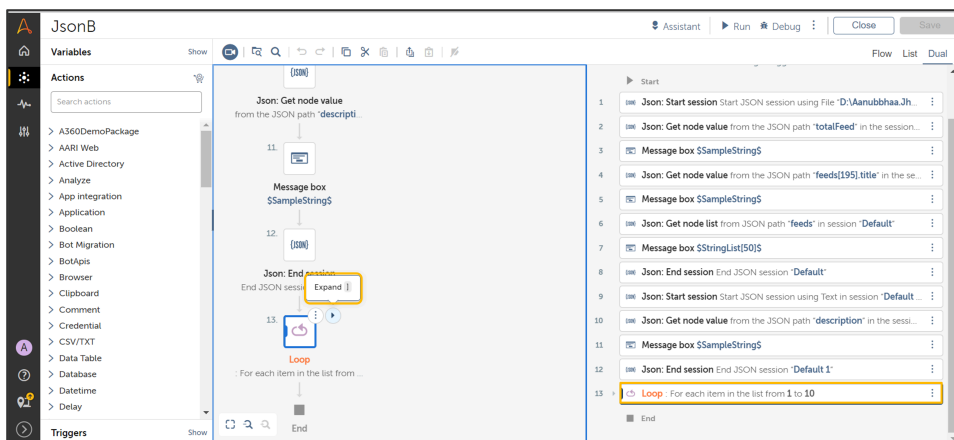

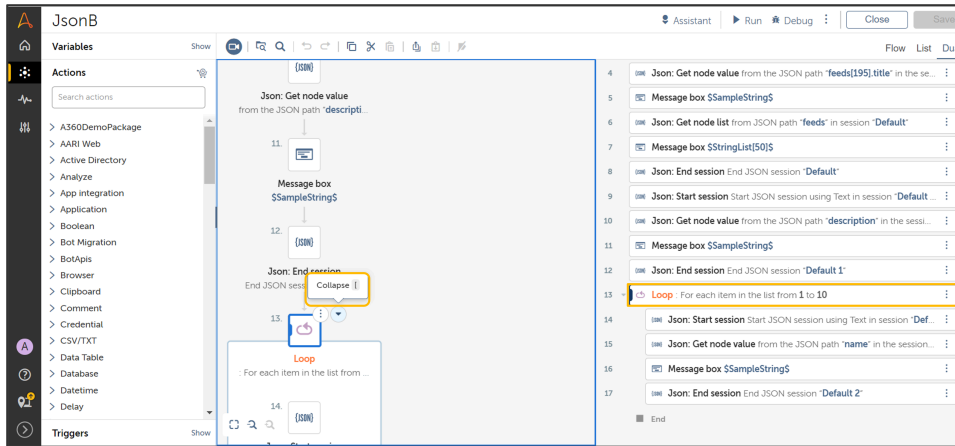

Shortcuts to expand or collapse an action is applicable only when the section is selected. You can use the following list of keyboard shortcuts in your bots.

Shortcut	Action
[	Collapses the current node
Ctrl+[	Collapses all the nodes
]	Expands the current node
Ctrl+]	Expands all the nodes
←	Collapses the current node or collapses to parent if already collapsed
→	Expands the current node

These keyboard shortcuts to expand and collapse nodes are supported in the following packages and actions:

- Loop package
- If package> **If**, **Else if**, and **Else** actions
- Error handler package> **Try**, **Catch**, and **Finally** actions
- Step package
- Trigger Loop package> **Trigger Loop** and **Handle** actions

## Keyboard shortcuts list

Review the list of keyboard shortcuts that are supported.

## All modes - Flow or List view

In the Bot editor, you can open a menu to display available keyboard shortcuts.

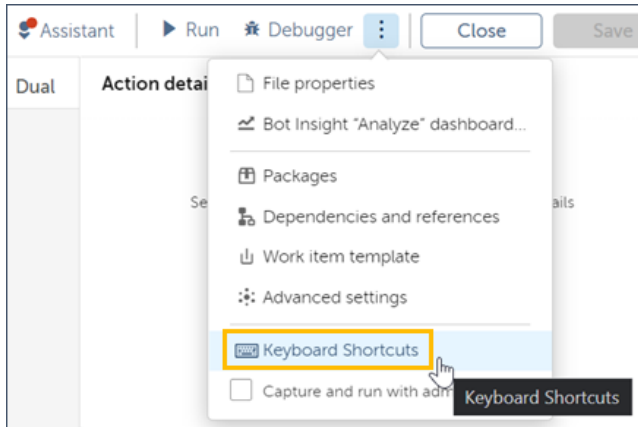

Keys	Action
Esc	Closes node details or clear cursor
Tab	Toggles Flow or List view
Enter	Shows node details and focus first input
Space	Toggles node details
Ctrl A	Selects all nodes

### All modes - Flow view

Keys	Action
Up	Moves cursor up
Down	Moves cursor down
Left	Moves cursor left
Right	Moves cursor right

### All modes - List view

Keys	Action
Up	Moves cursor up
Down	Moves cursor down

### Edit mode

Keys	Action
Ctrl S	Saves file

Keys	Action
F5	Run
F10	Enters debug mode
Shift F9	Toggles all breakpoint

### Edit modes - Flow or List view in focus

Keys	Action
Ctrl Shift R	Starts recording
Ctrl /	Enables or disables mode
F9	Toggles node breakpoint
Ctrl C	Copy node
Ctrl X	Cut node
Ctrl V	Paste node
Delete	Delete node
Ctrl Z	Undo
Ctrl Y	Redo

### Debug mode

Keys	Action
F5	Play/pause/restart
F6	Step next
F7	Stop
F10	Exits debug mode
Shift F9	Toggles all breakpoints

### Debug mode - Flow or List view in focus

Keys	Action
F9	Toggles node breakpoints

## Node details

Keys	Action
Ctrl Enter	Accepts current input and saves the action or trigger

## Get started with recorders

You can use two recorders in Automation 360, the Universal Recorder and the AISense Recorder, to automate tasks by recording interactions with objects such as click, read (data extraction), and write (data entry).

### An integrated Recorder

In versions 2.0.9-20201105-164103 and later, the Recorder package contains both the Universal Recorder and AISense Recorder. This offers the following benefits:

- Feature updates are delivered as delta updates, which reduces the time spent downloading the newest Recorder package each release.
- The **Start recording** icon serves as a common entry point to both recorders.

---

**Note:** The AISense Recorder fails if you manually upgrade the Recorder package version, such as by importing a bot that contains the integrated Recorder package (Version A2019.17 and later) to a Control Room that has a build from Version A2019.16 or earlier. Always upgrade the Recorder package through the Control Room. Do not attempt to manually upgrade by importing a .jar file or bot.

---

### Choosing which recorder to use for your task

Before you start building your bot, decide which recorder best fits your requirements.

#### Universal Recorder

Use Universal Recorder when you want to record interactions such as click, read, or write with user interface objects on your business application. After you have captured the object, you can specify your requirements in terms of the action to be performed on that object.

For example, if you capture a hyperlink, you can select an action to click the link or to retrieve the link text. Similarly, if you capture a table object, you can specify to either retrieve the total number of rows from a table object or retrieve each row one by one and perform any actions on it. This is the most reliable form of automation because it is performed on user interface objects rather than coordinates, images, keystrokes and so on.

## AI Sense Recorder

Use AI Sense Recorder when you are building and automating your bots on applications that are exposed over Citrix or accessed over RDP. You can also reduce the time spent on building and automating your bots for legacy applications where object-based automation is difficult.

The recorder's resiliency to screen resolution, browsers, and user interface alterations reduces limitations and obstacles when recording tasks across your business applications.

## Universal Recorder for object-based automation

Use the Universal Recorder to record interactions, such as click, read (data extraction), and write (data entry), with user interface (UI) objects on the desktop, taskbar, or in an application or browser window.

The earlier Automation Anywhere RPA products such as Version 11.3 have three separate recorders to capture objects from various environments. Automation 360 combines the capabilities of these three recorders into the Universal Recorder to streamline the recording process.

## Using the Universal Recorder

You can use the Universal Recorder in the following ways:

1. To record a process consisting of multiple steps, use the Universal Recorder video camera icon, which is located on the top-left of the workbench.

Depending on where you want to add newly captured actions in an existing Task Bot, use one of the following ways:

- To add newly captured actions below an existing action, select the existing action and then start recording.
- To add newly captured actions before the existing actions that are available inside another action, select the other action and then start recording. For example, if you want to add newly captured actions before the existing actions that are available inside a loop action, select the loop action and then start recording.

---

**Note:** If you do not select any action, then the newly captured actions are added at the end of the Task Bot by default.

---

See [Record a task with the Universal Recorder](#) on page 2240.

2. To record a single interaction that you want to add into an existing Task Bot (for example, if you missed a step when recording a task), use Capture action from the Recorder package.

See [Using the Capture action](#) on page 2940.

For a common use case, see [Example of entering data into a web form from a spreadsheet](#) on page 3204.

The Universal Recorder is also used within actions to capture coordinates (**Mouse > Click** action) or a local file path (**Application > Open program/file** action).

## Background processing

Background processing enables an automation that involves interacting with an application in the foreground (such as mouse clicks) to run in the background. We recommend that you use the option to run in background to increase the visibility of the target object and improve bot accuracy. The following actions support background processing:

- Click
- Set Text
- Get Text

Related tasks

[Record a task with the Universal Recorder](#) on page 2240

Use the Universal Recorder to capture a series of interactions (clicks, keystrokes, and mouse movements) with object controls including text boxes, buttons, tables, menus, radio buttons, combo boxes, check boxes, list views, links, trees, and page tabs.

[Edit a task recorded with the Universal Recorder](#) on page 2242

After recording a task, edit the **Capture** actions to change the window, capture a different object, select a new action, enable background processing, enter a different wait time, or save the output to a variable.

Related reference

[Browser requirements for Automation Workspace](#) on page 1210

Access the Automation Workspace interface from a browser. After you have installed and enabled extensions in the browser, perform several tasks through the Automation Workspace interface based on your user role and automation requirements.

[Secure recording mode](#) on page 2255

When secure recording mode is enabled, the bots do not capture values of certain properties or store application images. This ensures that sensitive data is not stored in the bots. This setting only applies to bots that are created or edited after the mode is enabled.

[Recording tasks in applications that run on JRE](#) on page 2256

Use the Universal Recorder to capture objects from Java applet, web start, and desktop applications that run using Java Runtime Environment (JRE) 6, 7, 8, 9, 10, and 11.

[Recorder package](#) on page 2916

Recorder package captures a series of tasks in a process and then automates them. You can automate your business applications (for example, desktop, Web, SAP, and Java applications) using the Recorder to capture actions performed on application objects such as a text box, button, table, radio button, combo box, and list view.

[Actions performed on objects captured with Universal Recorder](#) on page 2923

After capturing the object, specify the action for the bot to do to the object at runtime. For example, if you capture a hyperlink, you can select an action to click the link or to retrieve the link text. Refer to the table below for the objects and their possible actions.

## Record a task with the Universal Recorder

Use the Universal Recorder to capture a series of interactions (clicks, keystrokes, and mouse movements) with object controls including text boxes, buttons, tables, menus, radio buttons, combo boxes, check boxes, list views, links, trees, and page tabs.



- To use the Recorder, you must already have done the following:
  - [Install Bot Agent and register device](#) on page 1347
  - [Set user device credentials](#) on page 1353
- Configure device display and font scale to 100%.

If you are using Recorder package version 2.0.6-20200626-193519 or later, you can record tasks in Google Chrome, Internet Explorer, Java, Microsoft Active Accessibility, and Microsoft UI automation applications on a computer that has display scale configured to 100%, 125%, or 150%.
- If you are automating a task using a browser, configure the zoom level to 100%.

If you are using Recorder package version 2.0.6-20200626-193519 or later, you can record tasks in a Google Chrome browser that does not have a zoom level setting of 100%.
- If you are automating a task using a Google Chrome browser, ensure that the Automation Anywhere plug-in that corresponds with the Automation 360 build version is enabled.

[Browser requirements for Automation Workspace](#) on page 1210
- To automate web applications running on Microsoft Edge Chromium browser in Internet Explorer mode using the Universal Recorder, ensure that the Internet Explorer compatibility mode is enabled. The objects on the web applications are captured using HTML technology. To enable this mode, perform the following steps:
  1. On the Microsoft Edge Chromium browser page, click **Settings**.
  2. On the left panel, click **Default browser**.
  3. Navigate to the **Allow sites to be reloaded in Internet Explorer mode** option and select **Allow**.
  4. Click **Add** to add the URL of the page that you want to load in Internet Explorer mode.

---

**Note:** The pages that you add open in Internet Explorer mode for 30 days from the date when you add the page.

---

Considerations when recording a task:

- Use clicks when possible rather than shortcut keys.

When you click an object using the Recorder, it retrieves the object's properties that enable the bot to identify the object at runtime. Keyboard shortcuts are less reliable, so use them when it is not possible to automate the task by a clicking an object.
- If you are automating a task using a browser, do not use autofill to enter values into fields.
- Record the task at low speed.
- Avoid dragging windows during the recording process.
- Avoid clicking on applications that are not part of the process you are recording and automating.
- When Internet Explorer is used, the action waits until the browser is completely rendered and is in a ready state before executing the action.

To record a task using the Universal Recorder, follow these steps:

1. From Automation Anywhere web interface left panel, click **Automation**.
2. Create a new bot or open an existing bot for which you want to record a task.
3. Click **Start recording**.

**Note:** In versions 2.0.9-20201105-164103 and later, the Recorder package contains both the Universal Recorder and AISense Recorder.

[An integrated Recorder](#) on page 2238

---

The **Automation Anywhere Recorder** window appears.

4. Select a window from the drop-down list.  
If you opened an application recently and it is not available in the list, click the **Refresh** icon.
5. Click **Universal Recorder**.
6. Perform the steps in the task. For example, click buttons, fill in forms, or search a website.  
To perform an action on an object, move the mouse pointer on that object. The object is highlighted with a box. If the box does not appear, verify that you have enabled the necessary plug-in. For more information, see [Universal Recorder supported applications and browsers](#) on page 2248.

The **Recorder** window contains the number of operations recorded and a description of the most recently captured object. For example, `5. Left click on button 'Submit'`.

To redo the previous object capture, click the **Delete** icon at the bottom right of the **Recorder** window to discard the most recent capture.

If Secure recording mode is enabled, a shield icon appears to the right of the red recording icon.

[Secure recording mode](#) on page 2255

7. Click **Finish** after you finish capturing all the necessary objects.  
A **Capture** action is generated for each operation.  
Where applicable, the **Recorder** generates variables. [Your variables \(user-defined\)](#) on page 2331
8. Edit the actions or click **Save**.  
[Edit a task recorded with the Universal Recorder](#) on page 2242

## Edit a task recorded with the Universal Recorder

After recording a task, edit the **Capture** actions to change the window, capture a different object, select a new action, enable background processing, enter a different wait time, or save the output to a variable.

Select the **List** view to see the full details of each action.

Edit a recorded task to do the following:

- Change the application window in which you want to perform the operation, or add a wildcard to the window title.
- Change the properties of the captured objects.
- Specify the action you want to perform on the captured objects.
- Introduce a delay before the next action is performed.
- Specify the variable you want to use to store the output.

To add a **Capture** action to the task, see [Using the Capture action](#) on page 2940.

To edit a recorded task, perform the following steps:

1. Open the bot that contains the recorded actions you want to edit.

2. Click the **Capture** action that you want to edit.

Make the following changes, as necessary:

3. Change the window selection to the **Currently active** window option.
4. Optional: Insert a wildcard character (\*) in the **Window title** field to search for window titles that can change. You can specify one or more wildcards (\*) at the start, middle, or end of the value.

For example, to perform an operation on any window that has `Microsoft` in the title, use a wildcard to indicate any string by adding it before or after the value: `*Microsoft*`. The first searches for the exact window title (`Microsoft`), and if it does not find a match, it searches for windows with the term `Microsoft` anywhere in the title.

You can use a regular expression (regex) to identify a window title. Select the regular expression condition as either **String** or a **Pattern** and then enter the value. By default, the **Window title** field is case-sensitive.

To identify a browser title, you can enable the **Case sensitive** option to match the letter case, or disable the option to identify a window title where the letter case does not match.

---

**Note:** Ensure that the minimum version installed on your system is the version that was released with v.26. If you have a version released with v.25 or earlier, then by default, the window title will be identified only with matching letter case (case-sensitive).

---

For example, you can enter the **String** value as `(\w*)-Notepad` for all window title names starting with `(\w*)-Notepad`, or use **Pattern** value as `(\w)\s*document-Notepad` for only those window titles that match this pattern.

---

**Note:**

- When you use a regular expression of type **String** with `-title` as the input value for a window title in any , the might encounter a run time error. To prevent the run time error, ensure that when you add the string input as `*-title`, the application with the specific title is open. The asterisk (\*) is just a character, not a wild card character.
- When you use a regular expression of type **Pattern** with `-title` as the input value for a window title in any , the might encounter a run time error because the input value `*-title` is incorrect.

Ensure that you use valid regex patterns.

---

**Note:** During runtime, verify that the Task Bot identifies the correct window. If it does not, do the following:

- a) Open the application or browser window.
- b) Drag a **Window > Get active window title** action above the **Recorder > Capture** action.
- c) Insert a string variable into the **Assign the window title to variable** field.
- d) Drag a **Window > Set title** action below the **Window > Get active window title** action.
- e) In the **Window** field, insert the window variable generated by the **Recorder > Capture** action.
- f) In the **New window title** field, insert the string variable from the **Get active window title** action.

g) Click **Save**.

- 
5. Optional: Select the **Resize window** option to specify the window dimensions.

This option delivers a more reliable bot. It resizes the window to the dimensions at which the task was recorded, which enhances the ability of the bot to identify the target object.

- If the window is maximized when you record the task, this option is not selected.
- If the window is not at the maximum size when you record the task, this option is selected, by default, and the width and height fields are automatically filled with the dimensions of the window.

---

**Note:** This option is available only for windows that can be resized. It is not available for the **Desktop** or **Taskbar** options.

- 
6. Review the **Object properties** table.

Following are the list of object properties that are selected by default based on the technology type:

---

**Note:** You do not have an option to select Java or HTML technology explicitly. When you capture an application in auto-detect mode, the Recorder detects the technology automatically based on the application being captured. When the Recorder detects the specific technology, the technology type is displayed within the **Object properties**.

---

**Important:** The following list does not include all the properties and is restricted to the most commonly used and important properties based on the technology type.

---

Technology type	Object properties	Description
HTML Technology	Control type	This is a read-only property that shows the type of object captured, for example, text box or button.

Technology type	Object properties	Description
	DOMXPath	<p>It is the path that is used to locate the control or object that is captured. <b>DOMXPath</b> can be of two types: Relative XPath and Absolute XPath.</p> <ul style="list-style-type: none"> <li>• Absolute Xpath: It contains the complete path from the root element to the desired element. For example, an absolute Xpath for this topic would be <code>/html/body/div/div[1]/main/div[2]/div/div/div[2]/div/div/div[1]/div/article/main/article/div/p[1]</code></li> <li>• Relative Xpath: This is a shorter path that refers to an element you want to identify. A relative path starts with a <code>//</code> symbol. For example, the relative XPath for this topic would be <code>//*[@id="cloud-using-recorder-action"]/div/p[1]</code></li> </ul> <p>For example, if you want to find the <b>DOMXPath</b> of a particular element on Google Chrome browser, perform these steps:</p> <ol style="list-style-type: none"> <li>a) Select the element for which you want to extract the XPath.</li> <li>b) Right-click the element and select <b>Inspect</b>.</li> <li>c) Right-click the highlighted element in the <b>Element</b> tab.</li> <li>d) Go to <b>Copy &gt; Copy XPath</b> to copy the relative path and select <b>Copy &gt; Copy full XPath</b> to copy the absolute path.</li> </ol>
	Path	<p>It is a numeric representation of the position of a particular control in an application. For web applications, the best practise is to use <b>DOMXPath</b> from the search criteria when compared to <b>Path</b>.</p>
	HTML name and ID	<p>These properties are used to identify an HTML object</p>
	HTML inner text	<p>The DOM innerText Property is used to set or return the text content of a specified node and its descendants</p>

Technology type	Object properties	Description
	HTML tag	HTML tags are like keywords that define the way web browser formats and displays the content. For example, if the captured text has an HTML code: <code>&lt;h3 class="search_results-title"&gt;Search results for "string package"&lt;/h3&gt;</code> , then enter h3 in the HTML tag field.
Microsoft Active Accessibility	Control type	This property is used only as a reference to ensure that the correct object is captured
	Path	It is a numeric representation of the position of a particular control in an application
	Name	This specifies a name of an element and works as an identifier
	ID	This specifies the ID of an element and works as an identifier
Java Technology	Control type	This property is used only as a reference to ensure that the correct object is captured
	Path	It is a numeric representation of the position of a particular control in an application
Microsoft UI Automation	Control type	This property is used only as a reference to ensure that the correct object is captured
	Path	It is a numeric representation of the position of a particular control in an application
	Name	This specifies a name of an element and works as an identifier
	ID	This specifies the ID of an element and works as an identifier
	IsFirst	This property enables the bot to detect the first object based on your search criteria instead of traversing the entire tree. You can use this property when an object does not have a unique Automation ID and the object hierarchy changes in the application.
Microsoft UI Automation (COM)	Control type	This property is used only as a reference to ensure that the correct object is captured.
	Path	It is a numeric representation of the position of a particular control in an application.
	Name	This specifies a name of an element and works as an identifier.
	ID	This specifies the ID of an element and works as an identifier.

The bot uses the selected properties to identify the object control at runtime.

- a) Verify that the **Control Type** matches your intended object.

For example, when capturing a table from a website, ensure the **Control Type** and **HTML Tag** values are **Table**.

If the **Control Type** does not match your intended object, recapture the object control.

- b) Select and assign values to the object properties that you want to include in the object search.

For a more reliable bot, we recommend that you select only the properties that have static values (such as **Name**, **Class**, **Type**, **HTML ID**, and **DOMXPath**), and deselect the properties that have dynamic values (such as **HTML Href**, **Path** or **Value**), which are subject to change and cause bot errors.

It is a best practice to use the wildcard character (\*) or variable in object property values to search for objects whose properties are dynamic and changes frequently.

---

**Note:** Wildcard character matching is currently not supported for SAP technology. When you execute a bot with a wildcard character, it matches the property values exactly as specified in the search criteria.

---

7. Select the **Action** from the drop-down list.

For a full list of possible actions by object, see [Actions performed on objects captured with Universal Recorder](#) on page 2923.

- If you record a click and keystrokes in a text box with a **Control Type** of `Password text`, the **Recorder** does not capture the keystrokes entered into the field. Instead, the action selects the **Set text** option and offers options to securely input the password. We recommend that you store the password in the Credential Vault and insert it into the action as a credential. [Credentials and credential variables in the Bot editor](#) on page 2344

If you navigate to the text box using the TAB keystroke instead of a click in an MSAA or SAP application, the **Recorder** is able to identify fields with a **Control Type** of `Password text`.

We recommend that you use the **Set text** action without setting a delay time to enter keystrokes into a text field. However, if the text that you want to enter consists of a control key value or a text field requires any key press event, then you must set a delay time between the keystrokes when using the **Set text** action.

- If the selected **Action** supports background processing, a **Run in the background** option appears. [Background processing](#) on page 2240

8. Optional: Enter a value in the **Wait for control** field to specify the number of seconds the bot must wait for the object control to appear on the application window.

9. Optional: Assign the output to a variable.

The Control Room suggests a descriptive default variable name based on the action you selected in step 8. For example, if you selected **Get property**, the suggested output variable is `PropertyValue`. If you create several output variables, subsequent variable names are appended with a `-1` to avoid duplication.

10. Perform the Steps 3 through 9 for the other actions that you want to edit in the bot.

11. Click **Save**.

Link an object to a supporting anchor

**Note:** You can use object anchoring in Microsoft Active Accessibility, Microsoft UI Automation, or Java applications.

---

At runtime, if the bot cannot reliably identify an object, link it to a nearby object (such as a link or button) that is easier for the bot to find:

1. Open the **Capture** action.
2. Click the **Anchor** tab.
3. Click **Capture anchor**.

The browser or application window activates with the main object highlighted (the object that you previously captured). A dialog box appears, verifying whether the action has correctly identified the main object.

4. If the correct object is highlighted, click **Yes, Select anchor**.

Otherwise, click **No, I need to correct it** to select the correct object.

5. Select a nearby object to the target object that is easier for the bot to find.

The object is highlighted with an anchor icon on the right of the object.

6. Click **Save**.

## Universal Recorder supported applications and browsers

Use the Universal Recorder to record interactions with objects from the supported technologies.

### Applications

- HTML applications
- Java applet, web start, and desktop applications that run using Java Runtime Environment (JRE) 6, 7, 8, 9, 10, and 11 (32-bit and 64-bit versions)  
  
See [Recording tasks in applications that run on JRE](#) on page 2256.
- Microsoft Active Accessibility and UI automation
- Microsoft Silverlight version 5 (standard Microsoft controls only)
- Oracle EBS and Forms
- SAP versions 730, 740, 750 patch 9, 760 patch 5, and 770 patch 6
- Citrix Virtual Apps
- Electron

### Technologies

- Microsoft Active Accessibility (MSAA)
- Microsoft UI automation

---

#### **Note:**

Silverlight technology is supported for migrated bots only. You can migrate any Enterprise 11 bots that you created using Silverlight



technology to Automation 360. To modify the migrated bots or create new bots to automate Silverlight web applications, you can capture the web application using Microsoft UI Automation technology. Microsoft UI automation supports only standard controls for a Silverlight application.

---

## Browsers

- Google Chrome (versions 91 and later) for Manifest V3 extension
- Google Chrome (versions 90 and earlier) for Manifest V2 extension

To build and run bots that contain actions from the Recorder package, you must enable the Google Chrome extension that corresponds with the Recorder package version. See [Google Chrome browser extension requirements](#) on page 2250.

If you encounter an error when recording or running a bot that automates tasks in a Google Chrome browser and you have installed Google Chrome, you must perform additional steps to configure your system. See [Google Chrome extension troubleshooting](#) on page 2251.

- Internet Explorer (version 11)
- Microsoft Edge (version 91 and later) for Manifest V3 extension
- Microsoft Edge (version 90 and earlier) for Manifest V2 extension
- Microsoft Edge based on Chromium (versions 79 and later)

Microsoft Edge is supported on Recorder package version 2.0.9-20201105-164103 and later. You must install the A2019 plug-in for Microsoft Edge and verify that it is running in the Task Manager: [Automation 360 extension for Microsoft Edge](#)

---

**Note:** Ensure that the Google Chrome extension is not installed in the Microsoft Edge browser because that configuration causes recording and runtime errors. [Google Chrome extension installed in Microsoft Edge](#) on page 2254

---

- Mozilla Firefox (versions 80 and later)

Mozilla Firefox is supported on Recorder package version 2.0.11-20210128-034104 and later. You must install the A2019

extension for Mozilla Firefox: [Automation 360 extension for Mozilla Firefox](#)

Desktop	The desktop refers to the device screen when all application and browser windows are minimized.
Taskbar	The taskbar is the horizontal or vertical bar containing icons of open applications and browsers, as well as the notification area. You can capture application, browser, and system icons, such as Clock and Calendar, volume, and Wi-Fi.
UI objects	See <a href="#">Actions performed on objects captured with Universal Recorder</a> on page 2923.

#### Related reference

[Actions performed on objects captured with Universal Recorder](#) on page 2923

After capturing the object, specify the action for the bot to do to the object at runtime. For example, if you capture a hyperlink, you can select an action to click the link or to retrieve the link text. Refer to the table below for the objects and their possible actions.

#### Google Chrome browser extension requirements

Ensure the Automation Anywhere Google Chrome extension you are using corresponds with the Recorder package version in your bots.

Automation Anywhere has created two versions of the Google Chrome extension, based on the Recorder package version. Automation Anywhere A2019 extension version 1.1.0.1 is the recommended Google Chrome extension for bots that contain actions from the Recorder package 2.0.6 and later. Automation Anywhere Google Chrome extension version 11 or 12 is required only to run bots that contain actions from the Recorder package 2.0.5 and earlier.

Use the table below to verify that your system is running the correct browser agent and Google Chrome extension.

- Verify the browser agent in the **Windows Task Manager > Details** tab.  
If the browser agent is in the Task Manager, but is not running:
  1. Verify that the ComSpec variable is defined in the **Environment Variables** list.  
You can locate this list in **My computer > Properties > Advance System Settings > Environment Variables**.
  2. If the ComSpec variable is not in the list, define it by specifying the **Variable Name** as ComSpec and the **Variable Value** as %SystemRoot%\system32\cmd.exe.
- Verify the Google Chrome extension version in `chrome://extensions/`.
- If necessary, install the Google Chrome extension using the links in the table below.

Google Chrome re-verification: Google Chrome requires re-verification of permissions when the Automation Anywhere Google Chrome extension is updated. If prompted, click **Enable this item** in the Google Chrome message. Alternatively, re-enable the extension through the links in the table above. Similarly, if you are deploying your Bot Runners through a primary image, accept the permission from within that image.

Recorder package version	Browser agent	Google Chrome extension and ID
2.0.5 or earlier	Automation.BrowserAgent.exe	Version 11 or 12 ID: jjpdebaihkangkfpbgfmmnlafkahebn
2.0.6 or later	Automation.Bot.BrowserAgent.exe	Version 1.1.0.1 or later ID: kammdlphdfejllopponbapggpbgakimokm

**Note:** If you update the Bot Agent version by uninstalling the Bot Agent instead of directly updating, this also uninstalls the Google Chrome extension. In that case, you must manually reinstall the Google Chrome extension.

If you encounter an error when recording or running a bot that automates tasks in a Google Chrome browser and you have installed the Google Chrome, you must perform additional steps to configure your system. See [Google Chrome extension troubleshooting](#) on page 2251.

Related reference

[Google Chrome extension troubleshooting](#) on page 2251

If you encounter an error when recording or running a bot that automates tasks in a Google Chrome browser and you have installed Google Chrome, you must perform additional steps to configure your system.

[Google Chrome extension troubleshooting](#)

If you encounter an error when recording or running a bot that automates tasks in a Google Chrome browser and you have installed Google Chrome, you must perform additional steps to configure your system.

## Prerequisites

Ensure the Automation Anywhere Google Chrome extension you are using corresponds with the Recorder package version in your bots. See [Google Chrome browser extension requirements](#) on page 2250.

To configure your system to run the Google Chrome extension, choose the scenario that applies to you and follow the steps.

### Recorder package version 2.0.9 or later:

1. Verify that Google Chrome extension version 1.1.0.1 or higher is installed and enabled.  
To install the extension, see [Version 1.1.0.1 or later](#).
2. Open the Windows registry to the Google Chrome browser agent: Computer  
`\HKEY_LOCAL_MACHINE\SOFTWARE\WOW6432Node\Google\Chrome`  
`\NativeMessagingHosts\automation.bot.browseragent`
3. Verify that the registry entry points to the Automation 360 Bot Agent installation directory:  
`C:\Program Files\Automation Anywhere\Bot Agent\AABrowserAgent`  
`\AAChromeAgentManifest.json`

If this configuration is missing, reinstall the Bot Agent.

### Recorder package version 2.0.6, 2.0.7, or 2.0.8 (for Version A2019.16 or earlier)

1. Open the Windows registry to the Google Chrome browser agent: `Computer\HKEY_LOCAL_MACHINE\SOFTWARE\WOW6432Node\Google\Chrome\NativeMessagingHosts\automation.chrome.agent`
2. Verify that the registry entry points to the Automation 360 global cache: `C:\ProgramData\AutomationAnywhere\GlobalCache\embedded-resources\<Recorder package version>\AAChromeAgentManifest.json`

For example, `C:\ProgramData\AutomationAnywhere\GlobalCache\embedded-resources\2.0.6-20200626-193519-1bd6fceb-b036-4202-9932-4dc18349bd5c\AAChromeAgentManifest.json`

If this configuration is missing, do the following steps as an admin:

- a) Open the Automation 360 global cache: `C:\ProgramData\AutomationAnywhere\GlobalCache\embedded-resources\<Recorder package version>`
- b) Run the `install.ps1` file.
- c) Repeat steps 2 and 3 to verify the registry entry is updated.

### Recorder package version 2.0.5 or earlier, and never installed Automation Anywhere Enterprise Version 11.3 or later

---

**Note:** Use latest Recorder package version available in your Control Room.

---

1. Verify that Google Chrome extension version 11 or 12 is installed and enabled.  
To install the extension, see [Version 11 or 12](#).
2. Open the Windows registry to the Google Chrome browser agent:  
`Computer\HKEY_LOCAL_MACHINE\SOFTWARE\WOW6432Node\Google\Chrome\NativeMessagingHosts\automation.chrome.agent`
3. Verify that the registry entry points to the Automation 360 global cache: `C:\ProgramData\AutomationAnywhere\GlobalCache\embedded-resources\<Recorder package version>\AAChromeAgentManifest.json`

For example, `C:\ProgramData\AutomationAnywhere\GlobalCache\embedded-resources\2.0.5-20200626-193519-1bd6fceb-b036-4202-9932-4dc18349bd5c\AAChromeAgentManifest.json`

If this configuration is missing, do the following steps as an admin:

- a) Open the Automation 360 global cache: `C:\ProgramData\AutomationAnywhere\GlobalCache\embedded-resources\<Recorder package version>`
- b) Run the `install.ps1` file.

- c) Repeat steps 2 and 3 to verify the registry entry is updated.
4. Verify that the browser agent `Automation.BrowserAgent.exe` is running with the Google Chrome extension installed and enabled.  
If this configuration is missing, restart Google Chrome. Either disable and enable the Google Chrome extension, or close all Google Chrome browser tabs and reopen a new window.

### **Recorder package version 2.0.5 or earlier, and installed Automation Anywhere Enterprise Version 11.3 or later**

1. Verify that Google Chrome extension version 11 or 12 is installed and enabled.  
To install the extension, see [Version 11 or 12](#).
2. Open the Windows registry to the Google Chrome browser agent: `Computer\HKEY_CURRENT_USER\Software\Google\Chrome\NativeMessagingHosts\automation.chrome.agent`
  - If the above key is available, disable the Google Chrome plug-in version 11.x and enable the Google Chrome plug-in version 12.x.
  - If the above key is not available, disable the Google Chrome plug-in version 12.x and enable the Google Chrome plug-in version 11.x.
3. Restart Google Chrome. Either disable and enable the Google Chrome extension, or close all Google Chrome browser tabs and reopen a new window.
4. Verify that the browser agent `Automation.BrowserAgent.exe` is running with the Google Chrome extension installed and enabled.

### **Automation Anywhere Enterprise Version 11.3 or later is uninstalled**

Uninstalling the Enterprise Client does not remove the Google Chrome extension and registry entries. To remove them manually, do these steps:

1. Disable Google Chrome extension 12.x.
2. Install and enable Google Chrome extension 11.x.
3. In the Windows registry editor, remove the following key: `Computer\HKEY_CURRENT_USER\Software\Google\Chrome\NativeMessagingHosts\automation.chrome.agent`
4. Open the Windows registry to the Google Chrome browser agent:  
`Computer\HKEY_LOCAL_MACHINE\SOFTWARE\WOW6432Node\Google\Chrome\NativeMessagingHosts\automation.chrome.agent`
5. Verify that the registry entry points to the Automation 360 global cache: `C:\ProgramData\AutomationAnywhere\GlobalCache\embedded-resources\<Recorder package version>\AAChromeAgentManifest.json`  
For example, `C:\ProgramData\AutomationAnywhere\GlobalCache\embedded-resources\2.0.6-20200626-193519-1bd6fceb-b036-4202-9932-4dc18349bd5c\AAChromeAgentManifest.json`

6. Restart Google Chrome. Either disable and enable the Google Chrome extension, or close all Google Chrome browser tabs and reopen a new window.

## Google Chrome extension installed in Microsoft Edge

Although Microsoft Edge browser settings allow extensions from the Chrome Web Store, we recommend that you do not install the Google Chrome extension in the Microsoft Edge browser. Installing it causes recording and runtime errors in bots that interact with the Google Chrome browser. Even if you did not manually install the Google Chrome extension, the auto-sync settings in the Microsoft Edge browser might have automatically installed the extension.

## Unable to view Google Chrome extension in offline mode

1. Drag the file `ChromeExtension.crx` to the Google Chrome extension tab.  
This file is available in the same path where the `Automation.BrowserAgent.exe` file is available.  
Enable the Automation 360 Google Chrome extension.
2. If the Google Chrome extension is still not visible:
  - a) Verify if the registry entry `automation.chrome.agent` is available in the path `Computer\HKEY_CURRENT_USER`.  
If it is not available, create the registry in the following path: `Computer\HKEY_CURRENT_USER\Software\Google\Chrome\NativeMessagingHosts\automation.chrome.agent`  
This entry should have the same path as the entry: `Computer\HKEY_LOCAL_MACHINE\Software\Google\Chrome\NativeMessagingHosts\automation.chrome.agent`
  - b) Go to the path `Computer\HKEY_LOCAL_MACHINE\Software\Google\Chrome\Extensions`.  
For the 11.1.0.0 Automation 360 Google Chrome extension ID `jjpdebaihkangkfpbgefmmn1afkaebn`, create a new string with the name `path`.  
The value of the string will be the path of the `ChromeExtension.crx`, which is available in the same folder where the `AAChromeAgentManifest.json` file is available.  
For example, add the entry `C:\ProgramData\AutomationAnywhere\GlobalCache\embedded-resources\2.0.5-20200511-172840-1825fd43-19bc-4dd2-ac56-53a2aed4b0e4\ChromeExtension.crx` in the following locations:
    - `Computer\HKEY_LOCAL_MACHINE\Software\Google\Chrome\Extensions (ExtensionID)`
    - `Computer\HKEY_CURRENT_USER\Software\Google\Chrome\Extensions (ExtensionID)`
  - c) Restart Google Chrome. Either disable and enable the Google Chrome extension, or close all Google Chrome browser tabs and reopen a new window.

## Secure recording mode

When secure recording mode is enabled, the bots do not capture values of certain properties or store application images. This ensures that sensitive data is not stored in the bots. This setting only applies to bots that are created or edited after the mode is enabled.

A user with admin privileges must enable secure recording mode. See [Settings](#) on page 1789.

To capture objects in secure recording mode, ensure that the Recorder package is set to 2.0.0-20200318-020414 or higher. See [Manage Control Room packages](#) on page 1913.

When you record a task in secure recording mode, the **Preview** window temporarily shows the captured area. This image is deleted after you close the bot.

When you record a task in secure recording mode, you can choose whether or not the captured images are available for preview and stored in the Control Room. See [Secure recording](#) on page 1042

**Note:** Ensure that you use the latest version of the Recorder package. If you are using the 2.7.3-20220527-004608 or an older version of the Recorder package, a preview of the images will be shown in the Bot editor when the objects are captured. The images will be discarded when you refresh the Bot editor.

The following object properties are not automatically captured by default as they might contain sensitive data. If required, you can manually update the values of these properties to uniquely search the object. In addition, you can also review and ensure that any of these object properties do not contain any potentially sensitive data.

Technology	Object property
Microsoft Active Accessibility/UI automation/Java	<ul style="list-style-type: none"> <li>Item name</li> <li>Item value</li> <li>Name</li> <li>Parent</li> <li>Value</li> </ul>
HTML	<ul style="list-style-type: none"> <li>HTML InnerText</li> <li>HTML name</li> <li>HTML value</li> </ul>

Technology	Object property
Microsoft UI Automation (COM)	<ul style="list-style-type: none"> <li>• Description</li> <li>• Image</li> <li>• Value</li> <li>• Name</li> <li>• Parent</li> <li>• Item name</li> <li>• Item value</li> <li>• Data provider</li> <li>• Content</li> <li>• Legacy name</li> <li>• Legacy value</li> <li>• Legacy description</li> </ul>

## Recording tasks in applications that run on JRE

Use the Universal Recorder to capture objects from Java applet, web start, and desktop applications that run using Java Runtime Environment (JRE) 6, 7, 8, 9, 10, and 11.

Automation 360 supports JRE 6 and later on both 32-bit and 64-bit systems.

Verify whether additional configuration is necessary, depending on the JRE version:

- If JRE 7 update 6 or later is installed on the registered device, Java Access Bridge is automatically installed on that device.
- If JRE 7 update 5 or earlier is installed on the registered device, you must manually copy the required files to the corresponding directories. See [Java Access Bridge](#).
- If you have more than one version of JRE, Automation 360 configures Java Access Bridge with the default version. To configure it to a different version, you must manually copy the required files to the corresponding directories. See [Java Access Bridge](#).

The first time you record a task in an application running on JRE 6 or 7 update 5 or earlier, an error message might appear if the application is launched before Java Access Bridge is installed. Restart the application and proceed with recording the task.

## AI Sense for recording tasks from remote applications

AI Sense is the artificial intelligence (AI) powered capability of Automation 360 that helps you identify objects from an image or an application with a complex user interface (UI) and make automation in all environments faster and more accurate.

AI Sense is suitable when object-based automation fails or is not efficient for automating tasks on applications that are accessed remotely, in a Citrix environment, and legacy applications.

Some of the issues that affect the accuracy of an automation task in a remote environment are as follows:

- In a Citrix environment, the automation platform receives an image of the application and does not have access to the actual UI elements.
- Screen resolution and scaling might not be the same on the host and client machines.



- The position of a UI element might change for web applications due to a different resolution on the Bot Runner machine.

AI Sense uses computer vision to intelligently create dynamic linking between objects by determining their composition to deliver change-resilient automation. AI Sense enables you to accurately automate applications even when labels and text change their position.

---

**Important:**

- Bots will fail if they contain actions from Recorder package versions 2.0.9-20201105-164103 or later and the AI Sense package. You must delete the **AI Sense** actions and recapture the objects using the integrated recorder icon. [An integrated Recorder](#) on page 2238
- AI Sense Recorder supports the following languages: English, Simplified Chinese, Korean, Brazilian-Portuguese, Japanese, and Russian. When you record an application, ensure that the device locale is set to the same language as that of the application, regardless of operation system and keyboard layout. If the user interface (UI) of the application is a combination of English and another language, set the device locale to the other language. For example, if the UI is a combination of English and Russian, set the device locale to Russian.

---

**Note:** Even if the device locale is set to a language other than English, you can continue to automate applications that have an English UI without changing the device locale to English.

---

---

**Recommendation:** On any application, regardless of the language of the application, when you use the **Get text** action to retrieve text from a specified area, if the retrieved text is not accurate, we recommend that you perform one of the following actions and then record again:

- Increase the font size.
- Decrease the screen resolution.
- Zoom in to capture the text correctly.

---

Related tasks

[Record a task with AI Sense Recorder](#) on page 2257

Use the AI Sense Recorder to record an end-to-end task on a remote application or an application with a complex user interface (UI).

[Edit a task recorded using AI Sense](#) on page 2259

After you have recorded a task using the AI Sense Recorder, you can edit the recorded actions to perform various actions on the captured objects.

## Record a task with AI Sense Recorder

Use the AI Sense Recorder to record an end-to-end task on a remote application or an application with a complex user interface (UI).

- If you are automating a task using a browser, ensure that auto-fill is disabled for that browser.
- The screen resolution must be set to 1980x1080 or lower.
- Configure the device display settings to 100% DPI.
- If you are using Automation 360 On-Premises, ensure that the AI Sense Recorder package is added to your Control Room.

AI Sense Recorder can capture the following objects from an application: text boxes, buttons, radio buttons, combo boxes, check boxes, active and passive text, image button, scroll, and combo box.

Keep the following considerations in mind when recording a task:

- Record the task at low speed.
- Avoid dragging windows during the recording process.
- Avoid clicking applications that are not part of the process you are recording to automate.

To record a task using the AI Sense Recorder, follow these steps:

1. From Automation Anywhere web interface left panel, click **Automation**.
2. Create a new bot or open an existing bot for which you want to record a task.
3. Click **Start recording**.

---

**Note:** In versions 2.0.9-20201105-164103 and later, the Recorder package contains both the Universal Recorder and AI Sense Recorder.

[An integrated Recorder](#) on page 2238

---

The **Automation Anywhere Recorder** window appears.

4. Select a window from the drop-down list.  
If you opened an application recently and it is not available in the list, click the **Refresh** icon.
5. Click AI Sense Recorder .

The first time you use the AI Sense Recorder on a device, the Recorder downloads the required dependencies.

The **Recorder** toolbar appears with **Finish**, **Scan**, **Define**, and **Pause** options.

The Recorder analyzes the application window you selected to identify the UI objects in that window. The options on the toolbar are disabled when the system is analyzing the application window. After the analysis, the options are enabled and you can start recording the task.

6. Perform the actions to record. For example, click buttons, fill in forms, or select an option.  
To perform an action on an object, move the mouse pointer on that object. The system highlights an object along with the text associated with that object. For example, when you move the mouse pointer over a button or check box, the associated text with that button or check box is also highlighted and captured.
  - If the object is not highlighted, click the **Scan** option on the recording toolbar. After the system finishes analyzing the application window, you can capture the required object.
  - If you want to capture an option from a list, click the list and wait until the highlight appears around the box containing the options. After the box is highlighted, move the mouse pointer over the option you want to capture and wait until the option is highlighted.
  - If you use scroll on an application window, you must click **Scan** to analyze the new objects on the window.
  - If you want to record an interaction with an object that is only visible when you hover the mouse over the object, see [Detect hidden objects manually](#)

The **Recorder** window contains the number of operations recorded and a description of the most recently captured object. For example, `5. Left click on button 'Submit'`.

To redo the previous object capture, click the **Delete** icon at the bottom right of the **Recorder** window to discard the most recent capture.

If Secure recording mode is enabled, a shield icon appears to the right of the red recording icon.

[Secure recording mode](#) on page 2255

7. Click **Finish** after you finish capturing all the necessary objects.  
A **Capture** action is generated for each operation.  
Where applicable, the **Recorder** generates variables. [Your variables \(user-defined\)](#) on page 2331
8. Edit the actions or click **Save**.  
[Edit a task recorded using AISense](#) on page 2259

Detect hidden objects manually

If an object is only visible when you hover the mouse over the object, you must manually specify the object type and location by anchoring it to the nearest text:

1. Click the object once.
2. Click **Define**.  
The **AISense Define main object** window appears with a screenshot of the application, where the object is visible.
3. Click and drag a rectangle to outline the object to capture.
4. In the **Supporting anchor** list, select the text that is closest to the object you are capturing.
5. Click **Apply**.

Related tasks

[Edit a task recorded using AISense](#) on page 2259

After you have recorded a task using the AISense Recorder, you can edit the recorded actions to perform various actions on the captured objects.

Related reference

[AISense for recording tasks from remote applications](#) on page 2256

AISense is the artificial intelligence (AI) powered capability of Automation 360 that helps you identify objects from an image or an application with a complex user interface (UI) and make automation in all environments faster and more accurate.

[Actions performed on objects captured with AISense Recorder](#) on page 2261

After you capture objects using the AISense Recorder, you can perform various actions that a bot can perform on the object at runtime.

## Edit a task recorded using AISense

After you have recorded a task using the AISense Recorder, you can edit the recorded actions to perform various actions on the captured objects.

Edit a recorded task to do the following:

- Change the application window in which you want to perform the operation, or add a wildcard to the window title.
- Change the properties of the captured objects.
- Specify the action you want to perform on the captured objects.
- Introduce a delay before the next action is performed.
- Specify the variable you want to use to store the output.

**Important:** Only the following types of objects are supported with AISense Recorder:

- Text boxes
- Check boxes
- Combo boxes
- Radio buttons
- Buttons
- Active text

Active text is the text that you can click. For example, link, menu, text on a navigation pane, and so on. When there are duplicate active texts on the window, the AISense Recorder identifies and applies the action of the first occurrence of that active text on the window.

- Passive text

Passive text is the text that you can only read. It can be any text visible on the window that can be associated with a nearby static anchor text that is available during bot execution. When you select an area that has multiple lines, the AISense Recorder retrieves only the first line of the text from the area.

- Image button

An image button is a button that contains only image and does not have any text associated with it. For example, icons for delete, copy, cut, paste, and so on. You can capture image buttons that are hidden on the application screen and appear when you hover the mouse pointer over them.

- Scroll on an application window and combo box
- 

To edit a recorded task, perform the following steps:

1. Open the bot that contains the recorded actions you want to edit.
2. Click the **Capture** action that you want to edit.

Make the following changes, as necessary:

3. Click the **Window** tab or the **Variable** tab to specify a different application window on which you want to perform the operation.

If you have used the **Window** tab to specify the application window, you can use a wildcard character in the **Window title** field. The wildcard character is useful if the title of an application changes. For example, `Sample* - Google Chrome`.

---

**Note:**

- During runtime, verify that the Task Bot identifies the correct window.
  - If you use scroll on an application window, you must click the **Analyze window** option to analyze the new objects on the window.
- 

4. Update the object properties.

You can only update the value available in the **Anchor** field.

5. Select an option from the **Action** list to specify the action you want to perform on the object. For a full list of possible actions by object, see [Actions performed on objects captured with AISense Recorder](#) on page 2261.
  6. Optional: Enter a value in the **Wait for control** field to specify the number of seconds the bot must wait for the object control to appear on the application window.
-

We recommend setting a delay time when using the Set text action to enter keystrokes into a text field.

- Optional: Assign the output to a variable.

The Control Room suggests a descriptive default variable name based on the action that you selected previously. For example, if you selected **Get text**, the suggested output variable is `CaptureText`. If you create several output variables, subsequent variable names are suffixed with a hyphen and number to prevent duplication of variable names.

- Perform the Steps 2 through 7 for the other actions that you want to edit in the bot.
- Click **Save**.

Link nearby text to a supporting anchor

At run time, if the bot cannot reliably identify an object, link the object to nearby text that is easier for the bot to find:

- Open the **Capture** action.
- Click the **Anchor** tab.
- Click **Capture anchor**.

The browser or application window activates with the main object highlighted (the object that you previously captured). A dialog box appears, verifying whether the action has correctly identified the main object.

- If the correct object is highlighted, click **Yes, Select anchor**.

Otherwise, click **No, I need to correct it** to select the correct object.

- Select nearby text to the target object that is easier for the bot to find.

The text is highlighted with an anchor icon to the right of the text.

- Click **Save**.

Actions performed on objects captured with AISense Recorder

After you capture objects using the AISense Recorder, you can perform various actions that a bot can perform on the object at runtime.

For example, when you capture a button, you can select to click the button or to retrieve the button text. The following table lists the objects and their possible actions.

Object	Actions
Button	<ul style="list-style-type: none"> <li>• <b>Get text</b>: Extracts the value or caption from the specified captured object.</li> <li>• <b>Click</b>: Use this action to select the captured object.</li> <li>• <b>Left click</b>: Use this action if the <b>Click</b> action does not work during runtime.</li> <li>• <b>Right click</b>: Use this action to perform the right-click operation on the captured object.</li> <li>• <b>Double click</b>: Use this action to perform the double-click operation on the captured object.</li> </ul>

Object	Actions
Image button	<ul style="list-style-type: none"><li>• <b>Left click:</b> Use this action if the <b>Click</b> action does not work during runtime.</li><li>• <b>Right click:</b> Use this action to perform the right-click operation on the captured object.</li><li>• <b>Double click:</b> Use this action to perform the double-click operation on the captured object.</li></ul>
Active text	<ul style="list-style-type: none"><li>• <b>Left click:</b> Use this action if the <b>Click</b> action does not work during runtime.</li><li>• <b>Right click:</b> Use this action to perform the right-click operation on the captured object.</li><li>• <b>Double click:</b> Use this action to perform the double-click operation on the captured object.</li></ul>
Passive text	<b>Get text:</b> Retrieves text available in the area you have specified.
Check box	<ul style="list-style-type: none"><li>• <b>Get text:</b> Extracts the value or caption from the specified captured object.</li><li>• <b>Get status:</b> Retrieves whether the check box is selected. Returns checked or unchecked.</li><li>• <b>Check:</b> Selects the captured check box.</li><li>• <b>Uncheck:</b> Clears the captured check box.</li><li>• <b>Toggle:</b> Switches the check box to the opposite status. For example, if the check box is selected, use the <b>Toggle</b> action to clear it.</li><li>• <b>Left click:</b> Use this action if the <b>Toggle</b> action does not work during Runtime.</li><li>• <b>Right click:</b> Use this action to perform the right-click operation on the captured object.</li><li>• <b>Double click:</b> Use this action to perform the double-click operation on the captured object.</li></ul>

Object	Actions
Combo box (appears as a drop-down list)	<ul style="list-style-type: none"> <li>• <b>Get text:</b> Extracts the value or caption from the specified captured object.</li> <li>• <b>Get selected text:</b> Retrieves text from the selected item.</li> <li>• <b>Select item by text:</b> Selects the item that matches the text you have specified in the <b>Assign value</b> field.</li> </ul> <hr/> <p><b>Note:</b> The <b>Assign value</b> field is case-sensitive.</p> <hr/> <ul style="list-style-type: none"> <li>• <b>Expand:</b> Expands the combo box.</li> <li>• <b>Click:</b> Use this action to select the captured object.</li> <li>• <b>Left click:</b> Use this action if the <b>Click</b> action does not work during runtime.</li> <li>• <b>Right click:</b> Use this action to perform the right-click operation on the captured object.</li> <li>• <b>Double click:</b> Use this action to perform the double-click operation on the captured object.</li> </ul>
Scroll bar (within a combo box)	<ul style="list-style-type: none"> <li>• <b>Scroll Up:</b> Performs the scroll up operation. This action is similar to clicking the scroll up button one time.</li> <li>• <b>Scroll Down:</b> Performs the scroll down operation. This action is similar to clicking the scroll down button one time.</li> <li>• <b>Page Up:</b> Performs the page up operation. This action is similar to holding the scroll bar and moving it up. The distance by which the scroll bar is moved up is specified in the <b>Scroll Distance</b> field.</li> <li>• <b>Page Down:</b> Performs the page down operation. This action is similar to holding the scroll bar and moving it down. The distance by which the scroll bar is moved down is specified in the <b>Scroll Distance</b> field.</li> <li>• <b>Left click:</b> Use this action if the <b>Click</b> action does not work during runtime.</li> <li>• <b>Right click:</b> Use this action to perform the right-click operation on the captured object.</li> <li>• <b>Double click:</b> Use this action to perform the double-click operation on the captured object.</li> </ul>
RadioButton	<ul style="list-style-type: none"> <li>• <b>Get text:</b> Extracts the value or caption from the specified captured object.</li> <li>• <b>Get status:</b> Retrieves whether the radio button is selected. Returns selected or deselected.</li> <li>• <b>Select:</b> Use this action to select the captured radio button.</li> <li>• <b>Left click:</b> Use this action if the <b>Click</b> action does not work during runtime.</li> <li>• <b>Right click:</b> Use this action to perform the right-click operation on the captured object.</li> <li>• <b>Double click:</b> Use this action to perform the double-click operation on the captured object.</li> </ul>

Object	Actions
TextBox	<ul style="list-style-type: none"> <li>• <b>Get text:</b> Extracts the value or caption from the specified captured object.</li> <li>• <b>Set text:</b> Enters the text you have specified in the captured field. It supports credentials. <a href="#">Credentials and credential variables in the Bot editor</a> on page 2344</li> <li>• <b>Append text:</b> Adds text at the end of existing text in the captured field, instead of overwriting it.</li> <li>• <b>Click:</b> Use this action to select the captured object.</li> <li>• <b>Left click:</b> Use this action if the <b>Click</b> action does not work during runtime.</li> <li>• <b>Right click:</b> Use this action to perform the right-click operation on the captured object.</li> <li>• <b>Double click:</b> Use this action to perform the double-click operation on the captured object.</li> </ul>

## Capture Image button through AISense Recorder

Image buttons or icons are clickable buttons with no anchors. An application can have one or multiple image buttons. AISense Recorder uses template matching to detect and match image buttons on an application. So even after you record, if the position of the image button changes due to window resizing, AISense Recorder can detect the object and run the bot.

### Capture Image button

1. On the left pane, click **Automation**.
2. To create a bot, click **Create new > Bot**, or open a bot for which you want to record a task.
3. Click **Start recording**.

The Recorder bot runtime window appears.

4. Select a window from the drop-down list.  
If you opened an application recently and it is not available in the list, click the **Refresh** icon.
5. Click **AISense Recorder** and allow the scanning process to finish.

---

**Note:** The AISense Recorder downloads the required dependent files the first time you use it on a device.

---

The AISense Recorder toolbar appears with these options: **Finish**, **Scan**, **Define**, and **Pause**.

The AISense Recorder analyzes the selected application window to identify the UI objects in that window. When the system is analyzing the application window, the options on the toolbar are unavailable. After the analysis completes, the options are enabled and you can start recording the task.

6. Wait for the AISense Recorder to detect the object.



- If the object is not detected automatically, then when the AISense Recorder reaches the **Ready** state, you can click the **Define** button to detect the object.

**Note:**

- In the **Define** window, the shows embedded help for each control type so you can select the correct control types for custom objects.
- If you unintentionally click the screen or click before the highlighter appears, provides visibility into it. You must confirm to capture the object again, or use the **Define** functionality to define the object on the screen.

- Select **Image button** from the **Select the object type for the selected area** tab.

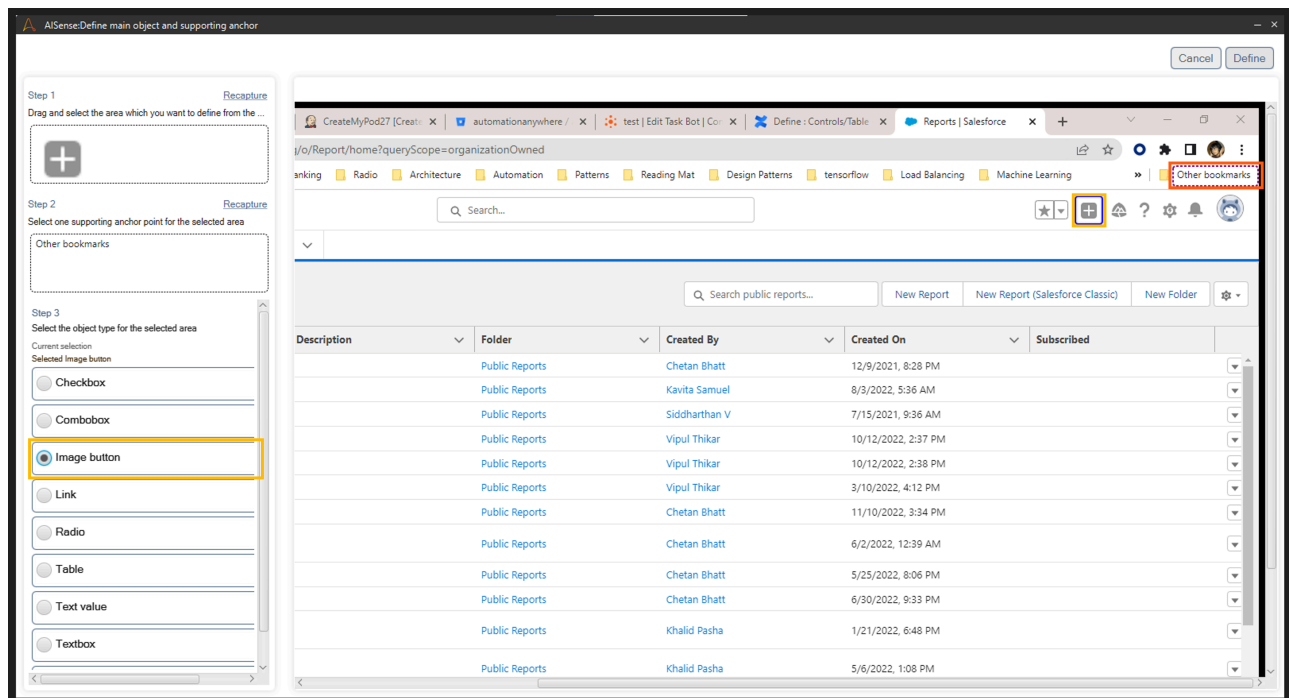

- Draw a rectangle around the image button that you want to capture.  
The selected area is shown in the box below the **Drag and select the area which you want to define from the image** field.
- Hover the mouse cursor over the nearby static text. Once the text is highlighted, select the static text as the supporting anchor.  
The image of the anchor is shown in the box below the **Select one supporting anchor point for the selected area** field.
- Click **Define**.
- After you have captured the required objects, click **Finish**.

## Capture link button through AISense Recorder

The link button control is clickable and has no specific features. In some cases, the AISense Recorder cannot detect it. You must use the **Define** option to detect and capture the link button control.

### Capture link button

1. On the left pane, click **Automation**.
2. To create a bot, click **Create new > Bot**, or open a bot for which you want to record a task.
3. Click **Start recording**.

The Recorder bot runtime window appears.

4. Select a window from the drop-down list.  
If you opened an application recently and it is not available in the list, click the **Refresh** icon.
5. Click **AISense Recorder** and allow the scanning process to finish.

---

**Note:** The AISense Recorder downloads the required dependent files the first time you use it on a device.

---

The AISense Recorder toolbar appears with these options: **Finish**, **Scan**, **Define**, and **Pause**.

The AISense Recorder analyzes the selected application window to identify the UI objects in that window. When the system is analyzing the application window, the options on the toolbar are unavailable. After the analysis completes, the options are enabled and you can start recording the task.

6. Wait for the AISense Recorder to detect the object.
7. If the object is not detected automatically, then when the AISense Recorder reaches the **Ready** state, you can click the **Define** button to detect the object.

---

**Note:**

- In the **Define** window, the shows embedded help for each control type so you can select the correct control types for custom objects.
- If you unintentionally click the screen or click before the highlighter appears, provides visibility into it. You must confirm to capture the object again, or use the **Define** functionality to define the object on the screen.

- 
8. Select **Link** from the **Select the object type for the selected area** tab.

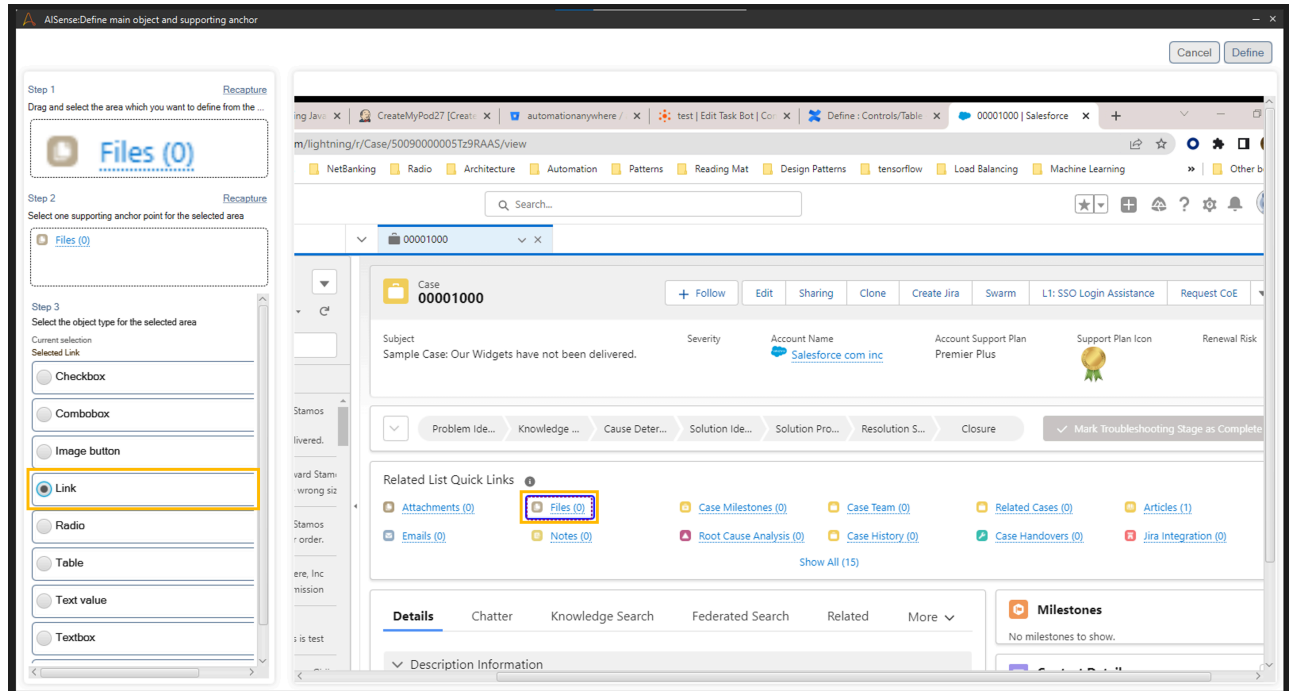

9. Draw a rectangle around the link button that you want to capture.  
The selected area is shown in the box below the **Drag and select the area which you want to define from the image** field.
10. Hover the mouse cursor over the text. Once the text is highlighted, select the link text as the supporting anchor.  
The image of the anchor is shown in the box below the **Select one supporting anchor point for the selected area** field.
11. Click **Define**.
12. After you have captured the required objects, click **Finish**.

## Capture text value through AISense Recorder

Passive texts are texts that are readable only. To make decisions, bots might require extracting texts, for example, key-value pair or text value from a form. If the AISense Recorder cannot detect the texts automatically, then you must use the **Define** option to detect the texts.

### Capture the text value

1. On the left pane, click **Automation**.
2. To create a bot, click **Create new > Bot** or open a bot for which you want to record a task.
3. Click **Start recording**.  
The Recorder bot runtime window appears.
4. Select a window from the drop-down list.  
If you opened an application recently and it is not available in the list, click the **Refresh** icon.

5. Click **AI Sense Recorder** and allow the scanning process to finish.

---

**Note:** The AI Sense Recorder downloads the required dependent files the first time you use it on a device.

---

The AI Sense Recorder toolbar appears with these options: **Finish**, **Scan**, **Define**, and **Pause**.

The AI Sense Recorder analyzes the selected application window to identify the UI objects in that window. When the system is analyzing the application window, the options on the toolbar are unavailable. After the analysis completes, the options are enabled and you can start recording the task.

6. Wait for the AI Sense Recorder to detect the object.
7. If the object is not detected automatically, then when the AI Sense Recorder reaches the **Ready** state, you can click the **Define** button to detect the object.

---

**Note:**

- In the **Define** window, the shows embedded help for each control type so you can select the correct control types for custom objects.
- If you unintentionally click the screen or click before the highlighter appears, provides visibility into it. You must confirm to capture the object again, or use the **Define** functionality to define the object on the screen.

- 
8. Select **Text value** from the **Select the object type for the selected area** tab.

9. Draw a rectangle around the text area that you want to extract.

The selected area is shown in the box below the **Drag and select the area which you want to define from the image** field.

10. Hover the mouse cursor over the nearby static text. Once the text is highlighted, select the static text as the supporting anchor.

The image of the anchor is shown in the box below the **Select one supporting anchor point for the selected area** field.

11. Click **Define**.
12. After you have captured the required objects, click **Finish**.

## Known behavior

AI Sense Recorder cannot extract texts with multiple lines. If you select multiple lines, only the first line is extracted.

## Capture Textbox, Radio, Checkbox, and Combobox

When a screen is dense, sometimes the AI Sense Recorder cannot detect and classify the controls correctly. To continue to automate the controls seamlessly, you can use the AI Sense Recorder to capture coordinates of controls and perform certain actions without having to use the Mouse and Simulate keystrokes packages separately.

## Textbox, Radio, Checkbox, and Combobox

---

**Note:** Any textbox, radio, checkbox, and combobox controls captured using **Define** functionality will be coordinate based automation. This functionality is provided for continuity of workflow.

---

1. On the left pane, click **Automation**.
  2. To create a bot, click **Create new > Bot** or open a bot for which you want to record a task.
  3. Click **Start recording**.  
The Recorder bot runtime window appears.
  4. Select a window from the drop-down list.  
If you opened an application recently and it is not available in the list, click the **Refresh** icon.
  5. Click **AI Sense Recorder** and allow the scanning process to finish.
- 

**Note:** The AI Sense Recorder downloads the required dependent files the first time you use it on a device.

---

The AI Sense Recorder toolbar appears with these options: **Finish**, **Scan**, **Define**, and **Pause**.

The AI Sense Recorder analyzes the selected application window to identify the UI objects in that window. When the system is analyzing the application window, the options on the toolbar are unavailable. After the analysis completes, the options are enabled and you can start recording the task.

6. Wait for the AI Sense Recorder to detect the object.
  7. If the object is not detected automatically, then when the AI Sense Recorder reaches the **Ready** state, you can click the **Define** button to detect the object.
- 

**Note:**

- In the **Define** window, the shows embedded help for each control type so you can select the correct control types for custom objects.
  - If you unintentionally click the screen or click before the highlighter appears, provides visibility into it. You must confirm to capture the object again, or use the **Define** functionality to define the object on the screen.
- 

8. Select the specific object type from the list of object types from the **Select the object type for the selected area** tab.

The object types that you select is shown under **Current selection**.

9. Draw a rectangle around the control that you want to capture.

The selected area is shown in the box below the **Drag and select the area which you want to define from the image** field.

10. Hover the mouse cursor over the text. Once the text is highlighted, select and define the text as the supporting anchor for identification.

The image of the anchor is shown in the box below the **Select one supporting anchor point for the selected area** field.

---

11. Click **Define**.
12. After you have captured the required objects, click **Finish**.

## Table data extraction through AISense Recorder

Tables are a complex control, with many types, backgrounds, and formatting effects, and hence might not be automatically detected by AISense Recorder in some cases. In such cases, use the **Define** option to detect tables.

### Capture a table using AISense Recorder

1. On the left pane, click **Automation**.
2. To create a bot, click **Create new > Bot** or open a bot for which you want to record a task.
3. Click **Start recording**.  
The Recorder bot runtime window appears.
4. Select a window from the drop-down list.  
If you opened an application recently and it is not available in the list, click the **Refresh** icon.
5. Click **AISense Recorder**. Let the scanning process finish.

---

**Note:** The first time you use AISense Recorder on a device, the Recorder downloads the required dependent files.

---

The Recorder toolbar appears with the following options: **Finish**, **Scan**, **Define**, and **Pause**

The Recorder analyzes the application window that you selected to identify the UI objects in that window. The options on the toolbar are unavailable when the system is analyzing the application window. After the analysis, the options are enabled and you can start recording the task.

6. Wait for AISense Recorder to detect the table in the application.
7. If the table is not detected automatically, then when AISense Recorder is in the **Ready** state, click the **Define** button to detect the table.

---

**Note:**

- In the **Define** window, the shows embedded help for each control type so you can select the correct control types for custom objects.
- If you unintentionally click the screen or click before the highlighter appears, provides visibility into it. You must confirm to capture the object again, or use the **Define** functionality to define the object on the screen.

- 
8. Select **Table** from the **Object type** tab and click the top-left header.  
The detected table will be highlighted with columns and internal controls.

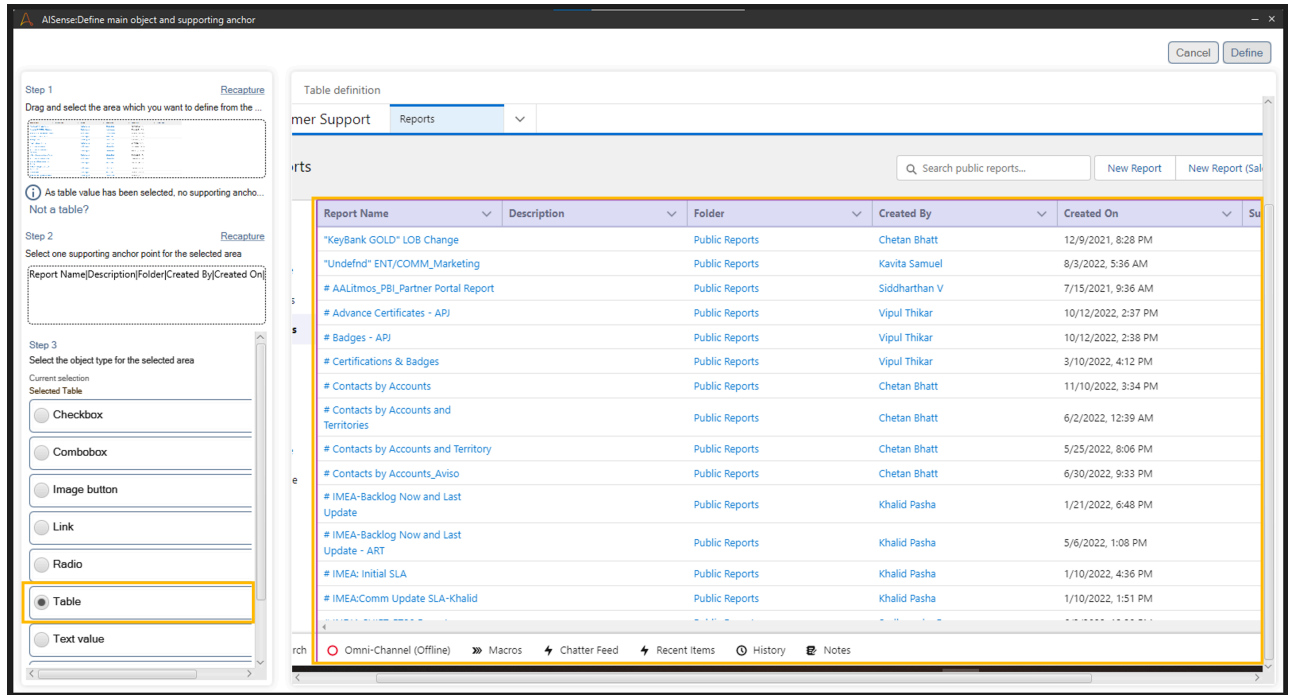

9. If you want to select a limited set of columns, then draw a rectangle around the columns that you want to capture.

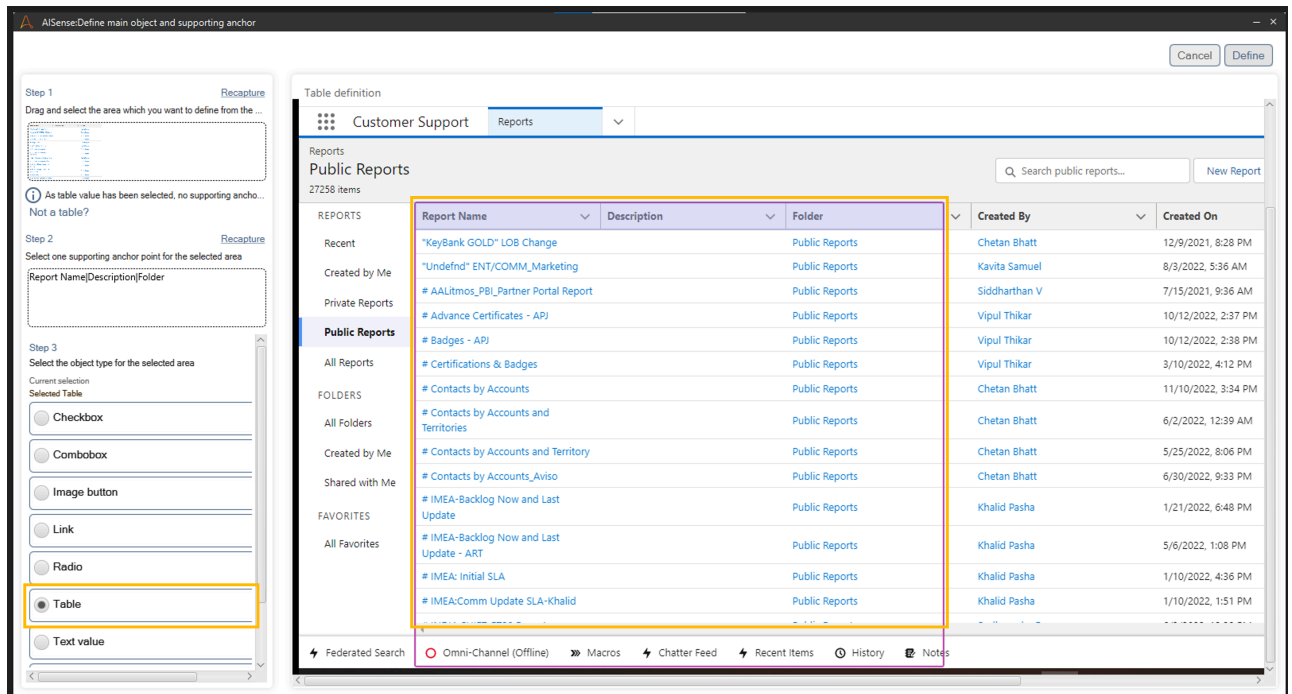

## Extract data from a table

1. After the object is captured, click **Finish** to end the recording.

2. Return to the Control Room.
3. In the **Object properties** table, verify that the **Control Type** is TABLE. If it is not, click **Recapture object**.
4. From the **Action to take on object** drop-down list, select **Get table**.
5. In the **Save the outcome to a variable** field, create the CapturedTableData variable.
6. Double-click or drag the **Data Table > Write to file** action.
7. From the **Data table name** list, select CapturedTableData.
8. Provide a filepath to create a CSV file. For example, C:\AutomationAnywhere\Development\SFDC.csv
9. Select the **Create folders/files if it doesn't exist** option.
10. Select to overwrite the existing file.
11. Click **Save**.
12. Click **Run**.

The bot creates a CSV file in the specified path with the table data extracted.

## Correct a column definition

It is possible that dense tables can merge columns due to less space between columns or lack of clear separators. To correct the column definition, perform the following steps:

1. After the object is captured, click **Finish** to end the recording.
2. On the Bot editor window, go to **Object properties** to edit the **Anchor Table** property.
3. Add the pipe character (|) as a delimiter between the column names to separate them. For example, <CHECKBOX>Name|Company|State|Email|Lead status

---

**Note:** When the bot is run, previously merged columns will be treated as separate columns.

---



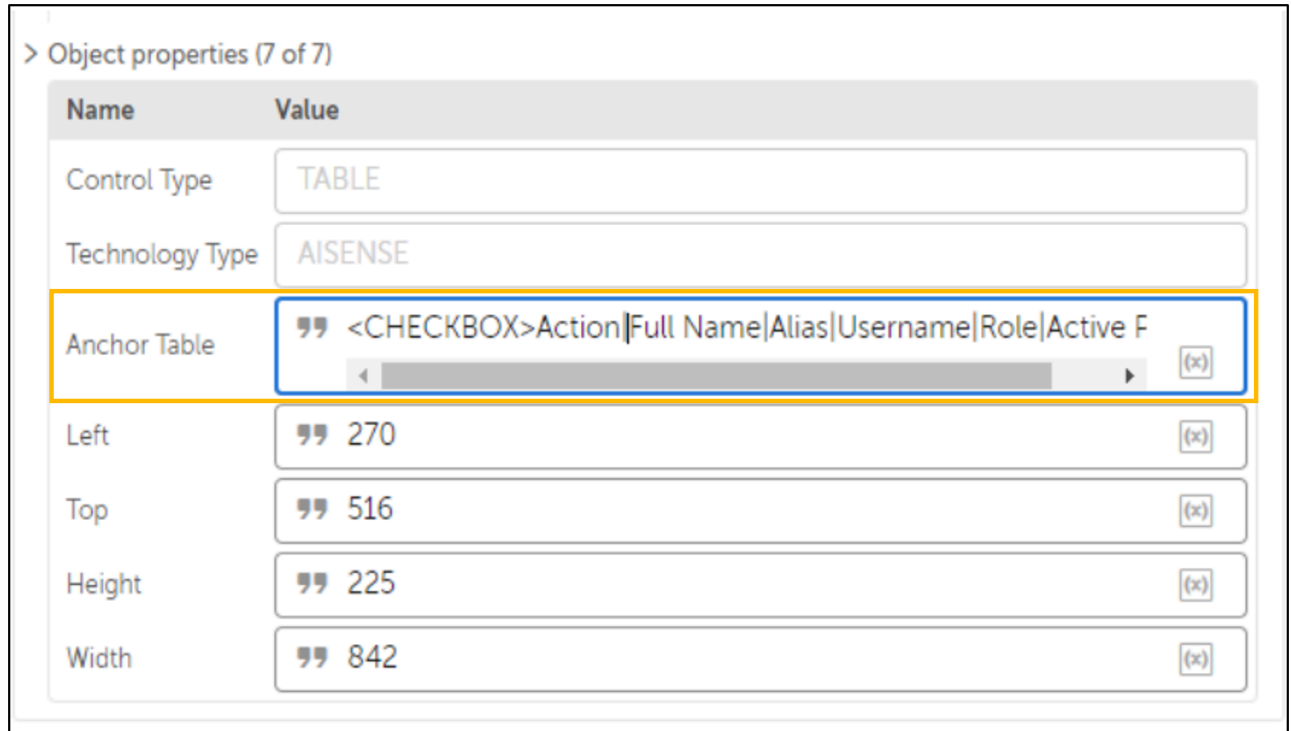

### Known behavior

- AI Sense Recorder cannot extract tables with multiple lines in single rows or cells.
- Pagination and autoscrolling are not supported.
- Truncated columns will not be automatically adjusted to extract truncated cell text.

### Use variable anchor

You can use the variable anchor to automate same controls that have different anchors. For example, pages having multiple checkboxes with different captions. These captions might be dynamic and might change based on the workflow. You can use the variable anchor to capture the control once, and then use the anchor as a variable in the Bot editor window. You can use a variable from various sources, for example, Microsoft Excel, CSV, or database.

### Capture using variable anchor

1. On the left pane, click **Automation**.
2. To create a bot, click **Create new > Bot** or open a bot for which you want to record a task.
3. Click **Start recording**.  
The Recorder bot runtime window appears.
4. Select a window from the drop-down list.  
If you opened an application recently and it is not available in the list, click the **Refresh** icon.

- Click **AI Sense Recorder** and allow the scanning process to finish.

**Note:** The AI Sense Recorder downloads the required dependent files the first time you use it on a device.

The AI Sense Recorder toolbar appears with these options: **Finish**, **Scan**, **Define**, and **Pause**.

The AI Sense Recorder analyzes the selected application window to identify the UI objects in that window. When the system is analyzing the application window, the options on the toolbar are unavailable. After the analysis completes, the options are enabled and you can start recording the task.

- Wait for the AI Sense Recorder to detect the object.
- If the object is not detected automatically, then when the AI Sense Recorder reaches the **Ready** state, you can click the **Define** button to detect the object.

**Note:**

- In the **Define** window, the shows embedded help for each control type so you can select the correct control types for custom objects.
- If you unintentionally click the screen or click before the highlighter appears, provides visibility into it. You must confirm to capture the object again, or use the **Define** functionality to define the object on the screen.

- Select **Variable anchor** from the **Select the object type for the selected area** tab.

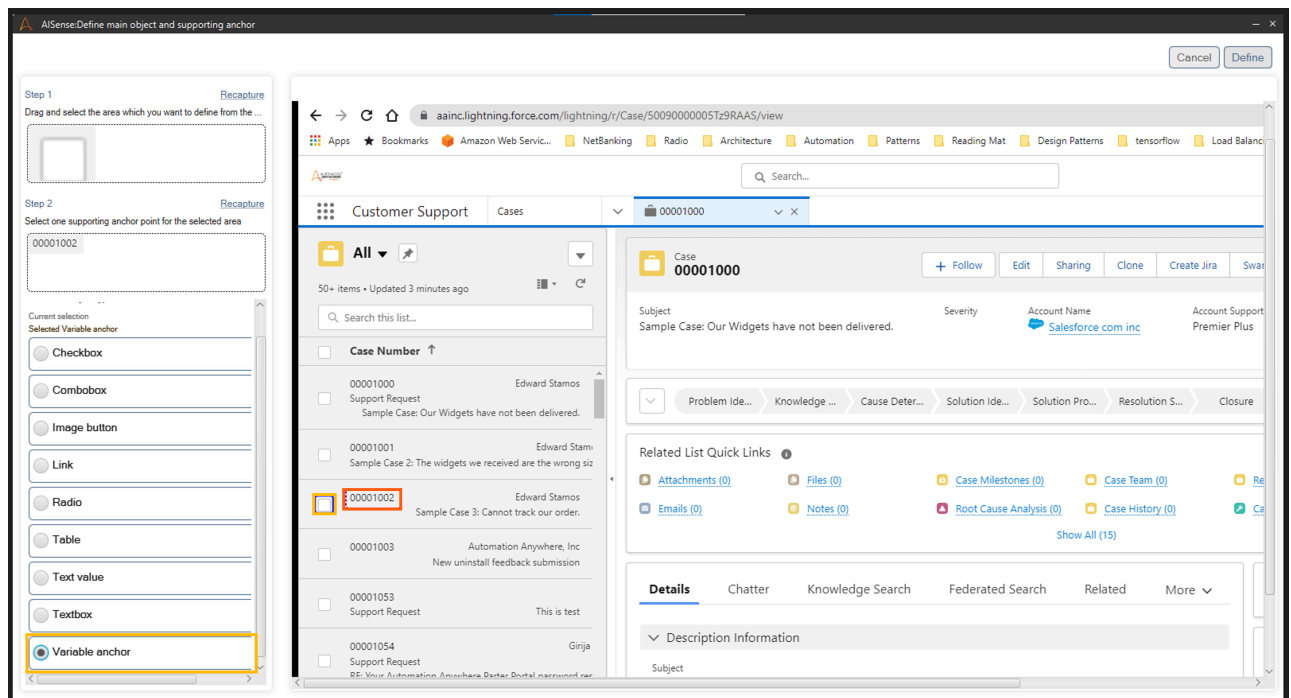

- Draw a rectangle around the checkbox that you want to capture.

The selected area is shown in the box below the **Drag and select the area which you want to define from the image** field.

**Note:** Hover the mouse over the checkbox and ensure that the checkbox is detected and highlighted with red rectangle before you click **Define**.

---

- 10.** Hover the mouse over the closest static text. Once the text is highlighted, select the text as the supporting anchor.

The image of the anchor is shown in the box below the **Select one supporting anchor point for the selected area** field.

- 11.** Click **Define**.
- 12.** After you have captured the required objects, click **Finish**.

The recorded steps appear as a separate action in the bot.

For each variable anchor action, you can copy the added action and update the value in the **Anchor** field with the anchor text of the object you want to capture, for each variable anchor action. Alternatively, you can use the action within the Loop action and use a variable that supports the String data type in the **Anchor** field.

> Object properties (7 of 7)

Name	Value
Control Type	VARIABLE_ANCHOR
Technology Type	AISENSE
Anchor	☞ \$AnchorInput\$ (x)
Left	☞ 47 (x)
Top	☞ 275 (x)
Height	☞ 21 (x)
Width	☞ 21 (x)

Keep trying for (seconds)

# 15 (x)

How long we'll search for the object (time out)

**Note:**

- You can assign only highlighted controls to a variable.
- Ensure no additional control or text exists between the anchor and the control.

## Enable debug logs for AISense Recorder

You can use debug logs to troubleshoot the application window that you capture and to verify if the object is being detected correctly. The results are available as debug images in the %temp%\AISenseLogs folder.

1. On your local device, browse to C:\Program Files\Automation Anywhere\Bot Agent\config.
2. Open the botlauncher-logging.xml file.
3. Include the following logger entry within the <Loggers> XML element and save the XML file:  
<Logger name="com.automationanywhere.recorder" level="DEBUG"/>  
For example, add the debug logger entry below the existing logger entry.

```
<Logger name="com.automationanywhere.recorder" level="INFO"/>  
<Logger name="com.automationanywhere.recorder" level="DEBUG"/>
```

Changes you make to the logging configuration file are updated in seconds configured per the monitor interval value.

---

**Note:** If the changes are not automatically applied per the monitor interval value, restart the Bot Agent service.

---

## AISense Recorder best practices

To use the AISense Recorder optimally, review the best practices.

### Configuring registered devices

- Ensure you use only recommended hardware configuration for registered device as specified. See [Bot Runner device requirements](#) on page 1167
- If application is running on same device, we recommend you to add additional CPU or RAM to avoid slowness. See [Bot Runner device requirements](#) on page 1167
- If you are automating a task using a browser, ensure that auto-fill is disabled for that browser.
- Ensure that the screen resolution is set to 1980x1080 or lower. See [Record a task with AISense Recorder](#) on page 2257
- Configure the device display settings to 100% DPI. See [Record a task with AISense Recorder](#) on page 2257

### Behavior

- When you use the AISense Recorder for the first time on any device, either for recording or for playback, it downloads the required resources from the Control Room. This process might take a few or several minutes depending on the speed of your internet. The state of the process is indicated in the progress bar during recording and the Bot runtime window shows **Downloading additional resources**.
- When you use a new package in a bot and if the package has any updated resources, it gets downloaded automatically that results in a delay in bot execution.
- There is a delay in scanning or bot execution in the following cases:

- The first execution will setup AISense environment which will take couple of seconds (based on machine configuration). User will observe some delay in scanning and bot execution.
- Every time application changes, due to navigation or new controls loaded, AISense has to detect new available controls on the application screen, which will take couple of seconds (based on machine configuration). User will observe some delay in scanning and bot execution.
- Parent and child bot execution: If child bot is using AISense Recorder, every time the child bot is executed, an AISense environment gets created to maintain isolation between bots. User will observe some delay in bot execution.

## Methodology

- Record the task at low speed. Click only after the red highlighter appears around the object.
- Avoid dragging the windows during the recording process.
- If AISense Recorder is downloading required resources from the Control Room in case it is deployed for the first time, do not close the Recorder window in between since doing so might corrupt the required resource files.
- When the AISense Recorder is in **Scanning** state, avoid switching between applications.
- When the AISense Recorder is in **Ready** state, move the mouse slowly over the object or control that you want to capture and make sure that it gets highlighted with the red rectangle and then click on it.

## Capturing Combo box

The following are some best practises that you can follow when you use the AISense Recorder to capture combo boxes. Below are some of the combo boxes based on the application requirements.

- **Searchable combo box:** The searchable combo box enables you to click in the text area and type. It then starts filtering the typed text from the list and allows you to press enter when a single result is available.
  - To automate this combo box control, during recording, highlight the combo box and click in the center of the combo box. The default action selected will be **Select Item by Text**. Finish the recording.
  - Go back to control room bot editor. Enter the text value along with Enter or combination of Down (down arrow) and Enter to simulate user like action. For example, if you are automating a searchable combo box which has a dropdown list item, then you can either enter the value in the searchable combo box and click Enter to select it or use the down arrow to search for the specific value and click Enter to select that value from the list.
- **Legacy combo box:** The legacy combo box does not have a search functionality and it is mandatory to expand it by clicking triangular button on right side of combo box and select one of the value.
  - To automate this combo box control, during recording, highlight the combo box, it should also highlight the small triangular button on right side.

---

**Note:** Ensure that it also highlights the small triangular button on the right side.

---

- Click the button and wait.  
The Recorder must take sometime to identify expanded value. During this time, the recording icon in the Recorder window must be in the blinking state.
- As soon as the small recording icon stops blinking, hover the mouse over the list box (expanded combo box) and make sure it highlights list values.
- Select the specific values.
- User can select any value and later change it from the Bot editor window in the Automation Anywhere Control Room.

## Using AISense Recorder with other Packages

AISense Recorder is computer vision based object detection method of automating where it captures the image of the application that you want to automate. When you use AISense Recorder to automate applications that have objects like textbox with single underline or combobox without triangular button, the objects might not get detected. In such cases, we recommend you use a combination of AISense Recorder with other packages like OCR and Image Recognition packages or only OCR and Image Recognition packages to automate such use cases.

## Client Control

AISense Recorder detects object on the application with specific feature set. When you click an area where there is no control, or click a control before it highlights with red boundaries, it will be recorded as **CLIENT** control. The client control is coordinate based capture of mouse click to replicate user click and is not standard AISense control. We recommend user to recapture control if captured as **CLIENT** control.

## Working with bots

Depending on the license and permission assigned to you, you can perform various bot operations and access the private and public workspaces in the Control Room.

## Licenses

Two types of licenses are available: Bot Creator and Bot Runner (attended or unattended) licenses. [Automation 360 licenses](#) on page 1407

## Bot Creator tasks

A Bot Creator user can access both the private workspace and public workspace in the Control Room by navigating to **Automation** on the left panel. The license provides the user exclusive access to the registered device. Other users cannot use the default device of a Bot Creator.

With the Bot Creator license and specific permissions, you can perform the following tasks:

- [Create a bot](#)
- [Run a bot](#) on page 2282

- Record a bot
  - Record a task with the [Universal Recorder](#) on page 2240|[Record a task with AI Sense Recorder](#) on page 2257
- [Schedule a bot](#) on page 2129
- [Copy a bot](#) on page 2311
- [Assign label to a bot](#)
- [View bot version history](#)
- [Export a bot](#)
- [Import a bot](#)
- [Check in a bot](#) on page 2301
- [Check out a single bot](#) on page 2305
- [Delete a bot](#)

You can also edit, analyze, save, clone, view content, pause, or stop a Task Bot.

## Bot Runner tasks

A Bot Runner can access only to the public workspace in the Control Room. They cannot create or edit bots.

With the Bot Runner license and specific permissions, you can perform the following tasks:

- [Run a bot](#) on page 2282
- [Schedule a bot](#) on page 2129
- [Assign label to a bot](#)

You can also view the content of a Task Bot.

## Public and private workspaces

The Automation page lists all the folders and bots available within the selected folder in the **Public** and **Private** repositories. If you have migrated the Enterprise 11 or Enterprise 10 data to Automation 360, the Automation page additionally displays the Enterprise 11 or Enterprise 10 Task Bots (.atmx) and MetaBots (.mbot) files in the public repository.

When an Enterprise 11 or Enterprise 10 bot is migrated and converted to the Automation 360 bot, the **My Tasks** and the **My Metabots** folders display the migrated (Enterprise 11 or Enterprise 10) and the converted bots with the same name but different extension. This might create confusion to differentiate between the two bots. Also, you cannot take any actions on the migrated bots except deleting them. To avoid this confusion, you can use the **Show** menu option to show or hide the Enterprise 11 or Enterprise 10 bots.

The Show menu displays three options - **Folder**, **.ATMX Task Bot**, and **.MBOT Meta Bot**. By default, each of these options are selected and displays all the folders and sub folders along with the Enterprise 11 or Enterprise 10 bot files.

If you clear the selected **Folder** option, then the sub-folders will be hidden from the files and folders list and will only display `.atmx` or `.mbot` files and when you clear the selected **.ATMX Task Bot** or the **.MBOT Meta Bot** options, the `.atmx` or `.mbot` files, will then be hidden across all the folders.



Depending on the license, users logging in to the Control Room can access the private and public workspaces.

#### Private workspace

Users with the Bot Creator license can access the private workspace. This workspace is primarily used to create and test bots. It enables users to view and manage all their activities in one primary location. Bots in the private workspace is available only to the users who created them.

---

#### Note:

- Users with administrative privileges and Bot Runner license cannot access the private workspace because they cannot create bots.
- The bot name must be unique. If a bot or a folder with the same name exists in the same folder location which you have access to in the public workspace, you cannot either create, check out, or rename the bot with this name in the private workspace.

#### Public workspace

Both Bot Creator and Bot Runner users can access the public workspace. This is a shared workspace where you can execute the bots.

Users with the Bot Runner license can run bots created by the Bot Creator user. Bots created in the private workspace by Bot Creators can be made available to specific Bot Runner users in the public workspace by defining the permissions at the folder or file level. To do this, users have to first check in the bot from the private workspace to the public workspace.

---

#### Note:

- When you create a Task Bot with dependencies, ensure that both the parent and child bot are in the same workspace (public or private). You cannot call a public bot from a private bot. To call a bot from the public workspace, you should first check-out or clone the public bot into the private workspace, include it as a child bot inside the private bot, and check-in both the bots.
- Folder names in private and public workspaces are case-sensitive. You can create a folder with the same name and matching case in private and public workspaces. However, you cannot create folders with the same name but with different case in the workspaces. For example, you can create a folder My Metabots in both private and public workspace. However, you cannot create folder names that use the same name but with different case, such as My Metabots in the private workspace and My MetaBots in the public workspace.
- Sorting and filtering are supported for substrings. For example, if you want to search for bots or files that have `fin` in the file or bot name, enter `fin` as the search criterion. All the

bots and files that contain `fin` in the names will be displayed, for example, Finance, Finder, DeltaFinance, and Dolfin.

Wildcards are not supported for searching and filtering bots or files.

---

## Run a bot

You can run a bot to test an automated process.

1. Log in to the Control Room.
2. On the left pane in the public workspace, click **Automation**.  
A list of available bots and forms is displayed.
3. Select the bot to run. Hover over the actions menu (vertical ellipses) located to the right of the bot name and click **Run Task Bot**.

If an optional Bot Agent update for your device is available, the following message that Bot Agent has an update is displayed one time per user session or when you log out and log in to the Control Room.

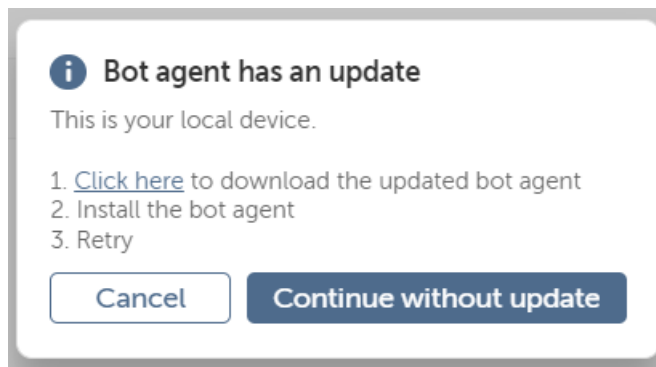

- To download and update the Bot Agent to the latest version on your device, use the **Click here** link.
  - To opt out of the update and continue with the existing Bot Agent version on your device, click **Continue without update**.
4. Select the version of the bot to run.
    - Latest version: To select the latest version of the bot, click the **Latest version** tab.
    - Labeled version: To select the labeled version of the bot, click the **Production version** tab.

By default, the latest version of the bot is selected. If the production label option is selected for the parent bot, the corresponding dependent bots with the production label are also automatically selected. If any of the dependent bots do not have the production label applied, the latest version of the bot is selected.

5. Click the right arrow (→) to add your selection.
6. Select the Bot Runner users from the list of **Available bot runners** in the **Run as** tab.  
The list of Bot Runner users that you have access to are displayed.
7. Click the right arrow (→) to add your selection.
8. Select the pool from the list of **Available device pools** in the **Device pools** tab.  
The list of device pools for which you have a consumer role are displayed. Select the device pool only if any of the selected Bot Runner users do not have a bot running (default) device.

9. Click the right arrow (→) to add your selection.
10. Optional: Select the **Automation priority** from the **General** tab.  
Set the priority to high, medium, or low based on your requirements for resource optimization. The default permission is set to medium.
11. Click **Run bot now**.

---

**Note:** If you have not set the device credentials from the **My settings** page, you are prompted to provide the device credentials to run the bot.

---

If you encounter issues in running a bot, refer to the following articles:

- [Automation 360 - Unable to download the bot or the dependencies to the device; Error code: download.error \(A-People login required\)](#).
- [There is already an existing deployment in-progress for this user session \(A-People login required\)](#).
- [BOT stuck in In Progress Stage and not able to move it to history" or "BOT stuck in Pending execution Stage and not able to move it to history" on Automation 360 CLOUD and On-Prem environments](#)

## Considerations for running a bot

There are certain considerations you have to keep in mind when running a bot.

- As a Bot Creator, you can deploy a bot on your device or you can run the bot on a remote machine through RDP connection.
- If you are running bots on your local machine as a Bot Creator, enter only your username in the device login credentials; no password is required. The username is required to confirm that the same user who logged in to the local device is deploying the bot. If you are using the Google Chrome plug-in and running bots on your local machine, your username is required.
- As a Bot Runner, you can either deploy the bot yourself or select a run-as user assigned by the administrator. You can run the bot either through your device or choose from the list of devices in a device pool. If you choose to override the default device, the bot will be executed on any available device in the device pool for each run-as user.
- You can preload packages on your local device to shorten the bot runtime.

The system supports running only one bot for each device at a given time. If a bot is already running on the device, you cannot deploy another bot on the device.

While a bot is running on a device, if you try to deploy another bot on the same device, the second bot is queued according to its type. After the deployment of the currently running bot is complete, the queued bot is automatically deployed on the same device.

- If you are running a bot from the Bot editor, closing the Control Room web browser will stop the bot run.
- Run-as user: A set of unattended Bot Runner users that a scheduler can select from to run a bot on a device. The run-as user can select an available device from the device pool to run the bot.
- When bots are queued for a Bot Runner user, bots with higher priority are deployed before bots with lower priority. However, if a bot with lower priority is already running, bots with higher priority are deployed after the bot with lower priority completes running.
- When you create the bot deployment using the **Run bot now** option, the bot is queued for execution. If the bot is deleted while it is queued for execution or while it is active, an error is displayed for that bot in the **In progress activity > View activity** page.

- Attended Bot Runner, Bot Creator, and Citizen Developer users can run the bots using either the **Run bot now** option in the Bot editor or the shortcut key F5. However, unattended Bot Runner users can run their bots only using the **Run bot now** option.

The following table explains the different scenarios where you should choose device pools against bot running devices for the run-as user.

Option	Scenario	Device pool	Default device	Result
Run bot now	Information security compliance where the user cannot log in to any other device	No	Yes	Bot deploys on the default device of the user.
	Specialized application access restricted to a user	No	Yes	Bot deploys on the default device of the user.
Schedule bot	<b>Override bot running device</b> option is selected	Yes	Yes	Bot deploys on the available device in the device pool.
	<b>Override bot running device</b> option is not selected	Yes	Yes	Bot deploys on the default device of the user. If default device is not available, the bot deploys on the available device in the device pool.
	Information security compliance where the user cannot log in to any other device	No	Yes	Bot deploys on the default device of the user.
	Specialized application access restricted to a user	No	Yes	Bot deploys on the default device of the user.
WLM (Run bot with queue)	<b>Run on bot running devices</b> option is selected	Yes	Yes	Bot deploys on the default device of the user.
	<b>Run on bot running devices</b> option is not selected	Yes	Yes	Bot deploys on the default device of the user. If default device is not available, the bot deploys on the available device in the device pool.
Automation Co-Pilot on the web	Run-as user with device pool assigned	Yes	No	Bot deploys on the available device in the device pool.

Related tasks

[Add queue, Bot Runner, and device pool](#) on page 1888

Add a queue, Bot Runner, and device pool to the automation from the **Run bot with queue** page.

## Run a bot in elevated mode

You can run a bot in elevated mode to enable non-administrative users to run an automation on applications that require administrative privileges.

To run bots in elevated mode:

- If the user has administrative credentials, then enable the **Run with administrative privileges** option in the **Run bot now** wizard.
- If the user does not have administrative credentials, then run the `A360Elevator.exe` application in an elevated or administrator mode.

---

**Note:** The `A360Elevator.exe` is bundled with the Bot Agent in the Automation 360 installation.

---

As an administrator, run the `A360Elevator.exe` in an elevated mode using one of the following methods:

- Right-click the `A360Elevator.exe` application and select **Run as administrator**.
- Create a shortcut of the `A360Elevator.exe` and add it to the Start up program. See [Add an app to run automatically at startup in Windows 10](#).
- Run the application through a job scheduler (such as Windows Task Scheduler) to enable the Control Room users to run bots in elevated mode.

## Elevated mode example

A user without administrator privileges runs a bot without elevated mode

In this example, a Control Room user runs a bot and this user does not have administrator credentials on the device. However, this bot accesses a Notepad application that requires administrator credentials. The following video shows the message that is displayed when the bot run fails:

A user without administrator privileges runs a bot in elevated mode

After installing the new Bot Agent, an IT administrator runs the `A360Elevator.exe` application in an elevated mode from the following location:

```
C:\Program Files\Automation Anywhere\Bot Agent
```

The following video shows how the same Control Room user can now run the bot that accesses the Notepad application which requires administrator credentials and complete the execution.

## Verifying the `A360Elevator.exe`

- To verify if the `A360Elevator.exe` is running, open the **Task Manager** as an administrator and review the **Details** tab.
- Search for one of the following lines in the success log:
  - Trying to launch elevated process using `A360Elevator.exe` in session '2'.
  - Successfully launched process in elevated mode.

- Search for one of the following lines in the error log:
  - Trying to launch elevated process using `A360Elevator.exe` in session '2'.
  - Launching process using elevated process token has error {}.
  - Not able to launch process as elevated.

## Adding a trigger to run a bot

Add triggers that can automatically run the selected bot whenever a specific event occurs. For example, clicking a specific button or using a combination of keystrokes.

Triggers integrate predefined events into your workflow and reduce the number of repetitive tasks that users must perform. Attended automation in Automation 360 enables you to create unique triggers for various applications. You can then use these triggers to start a bot.

Use one of the following types of triggers to start a bot:

---

**Important:** Trigger are not supported for private workspace, the trigger functionality will not work.

---

Email	Starts a bot when a new email message is received in the specified email service such as Microsoft Outlook, Email server, or EWS server.
Files and folders	Starts a bot when a predefined file or folder event occurs. You can set one of the following options as the trigger: <ul style="list-style-type: none"><li>• When a new file or folder is created.</li><li>• When an existing file or folder is deleted.</li><li>• When a file or folder is renamed.</li><li>• When a file or folder is modified.</li></ul>
Hot key	Starts a bot when a predefined combination of keystroke is performed on the keyboard. You can set a combination of the following keys as the trigger: <ul style="list-style-type: none"><li>• Control keys such as Ctrl, Alt, Windows logo key, and Esc.</li><li>• Keys with regular alphabetical (English) characters.</li></ul>
Interface	Starts a bot when a predefined event occurs on the selected user interface element. Some examples of the predefined events are: <ul style="list-style-type: none"><li>• User clicks a button.</li><li>• User opens or closes an application.</li><li>• User selects or clears a checkbox.</li></ul>

---

**Note:** When capturing an interface trigger in a SAP application, ensure that both the Recorder

and Interface trigger packages are from Build 5933 or from a prior release.

---

#### Process

Starts a bot when a predefined event occurs on the selected Microsoft Windows process. Some examples of the predefined events are:

- User starts a process.
- User stops or closes a process.

#### Service

Starts a bot when a predefined event occurs on the selected service in Microsoft Windows. Some examples of the predefined events are:

- Service starts or stops.
- User pauses the service.
- User resumes the service that was paused\.

#### Window

Starts a bot when a predefined event occurs on the selected application window. An example for a predefined event is when a user opens or closes an application.

#### Related reference

[Trigger loop package](#) on page 3136

The **Trigger loop** package enables you to run a series of actions when a trigger event occurs. You can insert multiple trigger loops within a bot or nest one trigger loop within another trigger loop.

[Email trigger package updates](#) on page 877

Review the updates in released versions of the Email trigger package such as new and enhanced features as well as fixes and limitations. The page also lists the release dates of each version, and the compatible Control Room and Bot Agent versions.

## Add an email trigger

Starts a bot when a new email message is received from the predefined email service.

Connect the Control Room to one of the email services on your system and trigger the bot when you receive a new email.

For email automation, you can use OAuth 2.0 to authenticate with the email server. To register your application with the Microsoft identity platform, see [Using Connect action in Email package](#) on page 2523

1. On the left pane, click **Automation**.  
A list of available and forms is displayed.
2. Click **Create new > Bot**.
3. Enter a name for the bot.  
All the bots are stored under the \Bots folder. (Optional) Click **Browse** to change the folder.
4. Click **Create & edit**.
5. In the bot builder page, click **Triggers > Email trigger**.
6. Drag **Email** into **Drag a trigger here**.
7. Use the **Email trigger** pane on the right to choose one of the following server types as the trigger for your incoming emails:

Server type	Steps
Microsoft Outlook	Click <b>Outlook</b> . Microsoft Outlook is set as the email service and the bot is triggered when you receive a new email.



Server type	Steps
Email server	<p>Click <b>Email server</b>.</p> <p><b>a)</b> Enter the email service <b>Host</b> information.</p> <p>For example, if you are using Office365 as your email service, enter <code>Outlook.office365.com</code>.</p> <p><b>b)</b> Select <b>IMAP</b> or <b>POP3</b>.</p> <p>IMAP and POP3 are protocols used to connect to the mail server that enables you to read your emails through an email client.</p> <hr/> <p><b>Note:</b> The POP3 protocol has a known limitation where any new calendar invite can also trigger the bot.</p> <hr/> <p><b>c)</b> <b>Use secure connection (SSL/TLS):</b> Select this option if you want to use a secure connection with the mail server.</p> <p><b>d)</b> Enter the configured port number for your email server.</p> <p><b>e)</b> Select one of the following user authentication methods to sign in to the email server:</p> <ul style="list-style-type: none"> <li>• <b>Basic</b> <ul style="list-style-type: none"> <li>• <b>Credential:</b> Click <b>Pick</b> to select the stored <b>Username</b> and <b>Password</b>. <a href="#">Credentials and credential variables in the Bot editor</a> on page 2344</li> <li>• <b>Insecure string:</b> Enter the username and password.</li> </ul> </li> <li>• <b>Client credentials</b> <ul style="list-style-type: none"> <li>• Specify the unique client and tenant IDs generated when you registered the application in the Microsoft Azure portal.</li> <li>• Specify the username you want to use to access the mail server.</li> <li>• Specify the client secret that you generated for your app in the app registration portal.</li> </ul> <p>For <b>Client ID</b>, <b>Tenant ID</b>, <b>Username</b> and <b>Client Secret</b> fields, choose from <b>Credential</b> or <b>Insecure string</b> tab:</p> <ul style="list-style-type: none"> <li>• <b>Credential:</b> Use a value available in the credential vault.</li> <li>• <b>Insecure string:</b> Manually enter a value.</li> </ul> </li> </ul> <hr/> <p><b>Note:</b> Client Credentials flow does not support Gmail.</p> <hr/> <p><b>Note:</b> The <b>Email in folder</b> does not support sub-folders when you set the protocol as <b>POP3</b> for <b>Email Server</b>,</p> <hr/>

Server type	Steps
EWS server	<p>Click <b>EWS server</b>.</p> <p><b>a)</b> From the <b>Microsoft Exchange Version</b> drop-down menu, select your current version.</p> <p>For example, if you are using Microsoft Exchange Service Pack 2, select <b>Exchange2010_SP2</b> as your email service.</p> <p><b>b)</b> Enter the domain name, for example, <code>smtp.office365.com</code></p> <p><b>c)</b> Select one of the following user authentication methods to sign in to the email server:</p> <ul style="list-style-type: none"> <li>• <b>Basic</b> <ul style="list-style-type: none"> <li>• <b>Credential:</b> Click <b>Pick</b> to select the stored <b>Username</b> and <b>Password</b>. <a href="#">Credentials and credential variables in the Bot editor</a> on page 2344</li> <li>• <b>Insecure string:</b> Enter the username and password.</li> </ul> </li> <li>• <b>OAuth 2.0 - Client credentials</b> <ul style="list-style-type: none"> <li>• Specify the unique client and tenant IDs generated when you registered the application in the Microsoft Azure portal.</li> <li>• Specify the username you want to use to access the mail server.</li> <li>• Specify the client secret that you generated for your app in the app registration portal.</li> </ul> <p>For <b>Client ID</b>, <b>Tenant ID</b>, <b>Username</b> and <b>Client Secret</b> fields, choose from <b>Credential</b> or <b>Insecure string</b> tab:</p> <ul style="list-style-type: none"> <li>• <b>Credential:</b> Use a value available in the credential vault.</li> <li>• <b>Insecure string:</b> Manually enter a value.</li> </ul> </li> </ul> <hr/> <p><b>Note:</b> There is no shared mailbox support for Microsoft Outlook but as a workaround, you can use the EWS server credentials flow with a shared email as a username string.</p> <hr/>

8. Optional: Use the **Check every** drop-down menu available under all the server types to set the trigger interval.

The trigger interval for the bot is set to 120 seconds by default.

**Note:** The trigger interval that you have configured using the **Check every** drop-down menu does not depend on the number of emails received during the scheduled interval.

For example, if you have configured **Check every** to **1** second, the task is triggered only one time even if you receive three different emails at same time. The run time filter of polling is updated to the sent date time of the email for which the last trigger was run.

- 
- 9.** Optional: Use **Select Conditions** to specify an email event for the selected server type.

Consider a scenario where you select **Outlook** and want to trigger a bot when you receive an email from a specific sender. In **Select Conditions**, select the **Email from** check box and specify the sender's email address.

When you select the **Email subject contains** check box, the email trigger is executed depending on the following subject conditions:

- When the subject line is provided within double quotation marks (""), for example, "ABC spreadsheet", the trigger is executed only when the email subject has an exact match for the string provided within quotation marks.
- When multiple subject lines are separated by semicolons, for example, ABC spreadsheet; ABC project logs, the trigger is executed when the email subject matches any of the subject lines mentioned.

- 10.** Optional: To create a variable, in the **Assigned to > Record** tab, click .

You can use this variable to retrieve various details about the email that triggered the bot, such as sender, recipient, subject, email content, date, action information, email server host, and port data.

- 11.** Click **Apply**.

- 12.** Click **Run > Run with triggers**.

Microsoft Outlook, Email server, or EWS server is set as the trigger to start the bot for new emails.

---

**Note:** When you run an email trigger, the **emailTo** key returns a list of To addresses. To convert the list of To addresses into a string, use the **Assign** action from the List package and then use the **Join items** action from the List package, with the comma as a delimiter to separate the addresses.

---

## Add a file and folder trigger

Starts a bot when a predefined action such as create, delete, rename, or modify is performed on a file or a folder.

This procedure is for a scenario where you want to trigger a bot when a user modifies a document called `Product info.docx`.

---

**Note:** This scenario is for a user with Bot Creator role.

For information about how a user with a Bot Runner role can link event triggers, see [Linking event triggers to a Bot Runner](#) on page 2142.

---

- 1.** On the left pane, click **Automation**.  
A list of available and forms is displayed.
- 2.** Click **Create new > Bot**.
- 3.** Enter a name for the bot.  
All the bots are stored under the `\Bots` folder. (Optional) Click **Browse** to change the folder.
- 4.** Click **Create & edit**.

5. In the bot builder page, click **Triggers > Files & folders**.
  6. Drag **File trigger** into **Drag a trigger here**.
  7. Click **Browse** and select the `Product info.docx` file.
  8. From the **Start the bot when the file is** drop-down menu, select **modified**.  
This sets the trigger for the bot.
  9. Optional: Use the **Assigned to** drop-down menu to assign a variable.  
If you want use the **Variables** tab to create a variable, ensure you select the **Use as input** check box for it to appear in the **Assigned to (optional)** drop-down menu.
- 

**Note:** If you use the  in the **Assigned to (optional)** drop-down menu to create a variable, ensure that you do not select the **Constant (read only)** check box.

---

The following set of data can be retrieved by defining a variable as the input type, which you can assign to get output from the trigger:

- **triggerType:** File or folder trigger
- **eventType:** The type of trigger event

The following set of data cannot be used if the **Set Schema** check box is selected as it returns a non-string variable type:

- **timeStamp:** The time when the trigger occurred  
Ensure you link the **timeStamp** value to a string variable to obtain the trigger data. For example, consider you want to extract the date and time for the trigger event when a user modifies the `Sales update.xls` file. Use the **Message** action within the task logic, and enter `Date Time- $recordVar[2]` in the **Enter the message to display** field.
- **fromFolder:** Details of the parent folder path
- **folder:** Details of the file or folder path on which the event occurred

10. Click **Save**.
11. Click **Run > Run with triggers**.  
Whenever a user modifies the `Product info.docx`, the bot is triggered.

Related reference

[Event triggers](#) on page 2139

An event trigger is a predefined action that runs an associated bot. All the bots with event triggers are listed under the **Event triggers** tab.

## Add a hot key trigger

Starts a bot when a predefined combination of keys is used on the keyboard.

This procedure is for a scenario where the bot is triggered when a user presses Ctrl (plus) L keys from the keyboard.

---

**Note:** Hot key triggers are supported on both attended and unattended Bot Runner licenses. However, the hot key trigger will work for unattended Bot Runner users only if they have access to the associated default device and they use the predefined keys.

---

1. On the left pane, click **Automation**.  
A list of available and forms is displayed.
2. Click **Create new > Bot**.

3. Enter a name for the bot.  
All the bots are stored under the \Bots folder. (Optional) Click **Browse** to change the folder.
4. Click **Create & edit**.
5. In the bot builder page, click **Triggers > Hot key**.
6. Drag **Hot key trigger** into **Drag a trigger here**.
7. Click **Ctrl** to set it as the **Hot key** from the available key modifiers.
8. Use the drop-down menu to select **L** from the keyboard.  
The **Hot key** field displays the key combination that will trigger the bot.
9. Click **Apply**.
10. Click **Run > Run with triggers**.  
When the Ctrl and L keys are used on the keyboard, the bot is triggered.

Example for using hot key to trigger a bot

In this example, a front desk executive of an insurance company responds to a call from an existing customer who wants to understand the policy details and its validity. The executive uses a hot key to trigger a bot that retrieves the customer's information.

Information about all the existing customers and the insurance company's various policies is distributed across two different databases. An existing bot maps the data between the two databases and provides consolidated information in a user readable format to the executive. Ctrl +L is set as the hot key to trigger this bot.

1. The executive collects caller's information to verify if it is an existing customer.  
The executive confirms the caller is an existing customer who wants to know the policy details.
2. The executive uses Ctrl+L to trigger a bot.  
The bot retrieves the customer information and the corresponding policy details. An authorization message is displayed.
3. The executive reviews the information that is consolidated in a form, and answers the customer queries without any delay or hold time.

The following image illustrates this attended automation scenario:

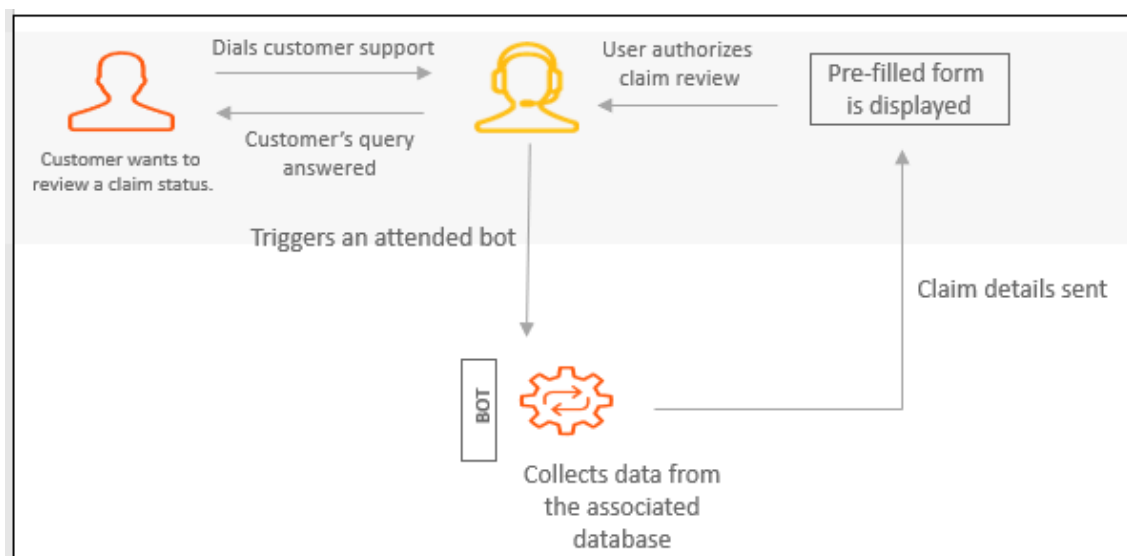

## Add an interface trigger

Starts a bot when a predefined action occurs on a specific interface element, such as clicking a button or closing an application.

The following procedure is for a scenario where a trigger is configured to start a bot when the user clicks the **New** option in Microsoft Word. Before the trigger configuration, ensure the Microsoft Word application is open on your system. A complete list of supported events and objects is available at the bottom of the page.

---

**Note:** Interface triggers for objects are available only for native Windows applications.

---

**Note:** Interface triggers are supported on both attended and unattended Bot Runner licenses. However, the interface trigger will work for unattended Bot Runner users only if they have access to the associated default device and perform the predefined action on the specified interface element.

---

1. On the left pane, click **Automation**.  
A list of available and forms is displayed.
2. Click **Create new > Bot**.
3. Enter a name for the bot.  
All the bots are stored in the \Bots folder. (Optional) Click **Browse** to change the folder.
4. Click **Create & edit**.
5. In the bot builder page, click **Triggers > Interface trigger**.
6. Drag **Object** into **Drag a trigger here**.  
The **Interface trigger: Object** editing panel appears.
7. In **Window detail** tab, click **Application**.

---

**Note:** For browser-based events, click **Browser** and select the correct browser tab. Interface triggers are supported on only Google Chrome and Edge Chromium browsers.

---

8. Click the drop-down menu and select **Taskbar** under **Preset** to show applications in the menu that are open in your taskbar. You can then select Microsoft Word as the application for the interface trigger.

If Microsoft Word is not displayed in the list, you can use the Refresh option to reload the list of applications and select .

9. Click **Capture object**.  
This initiates a built-in web recorder that captures the object of your next click. In this scenario, Microsoft Word is displayed. Click **New**, which is then set as the trigger to start the bot.
10. Click the **Select main event** drop-down menu to choose a specific event.  
In this scenario, **New** in Microsoft Word is considered a button and the following events are available:
  - **Click:** Triggers the bot when the user clicks the selected main event object.
  - **Click with hotkey:** Use one of the available key modifiers and select a key (alphabetical letters) from the drop-down menu. This combination is set as the hot key to trigger the bot.

11. Optional: Select one of the available Control keys (Shift, Alt, Ctrl, Windows and AltGr) as an additional combination for the hot key to trigger the bot.
12. Click **Save**.
13. Click **Run > Run with triggers**.  
The preset trigger is created, and the bot is triggered when the user clicks **New** in Microsoft Word.

Other events and objects can be used as triggers, and might be more suitable for your specific business needs.

The interface trigger supports the following events and objects from applications (Windows native, SAP Desktop, and Google Chrome browser).

Object	Event
Button	<ul style="list-style-type: none"> <li>• Click</li> <li>• Click with hotkey</li> </ul>
Textbox	<ul style="list-style-type: none"> <li>• Get focus</li> <li>• Lost focus</li> <li>• Hotkey when in focus</li> </ul>
Hyper Links or Link like widgets	<ul style="list-style-type: none"> <li>• Click</li> <li>• Click with hotkey</li> </ul>
Checkbox	<ul style="list-style-type: none"> <li>• Selected</li> <li>• Deselected</li> </ul>
Radiobutton	Selection change
Drop-down or combo menu	Selection change
Tab	<ul style="list-style-type: none"> <li>• Click</li> <li>• Click with hotkey</li> </ul>
List item	Selection change
Menu bar	<ul style="list-style-type: none"> <li>• Click</li> <li>• Item click</li> </ul>

### Add Microsoft 365 Outlook trigger

Use email as a trigger to start a bot when you receive an email in Microsoft 365 Outlook that is using the OAuth2 authentication.

Ensure that the following per-requisites are completed:

- OAuth 2.0 to use client credentials is set up.

For more information on setting up OAuth 2.0 to use client credentials, see [Set up OAuth 2.0 using client credentials](#) on page 2857

- Credentials are assigned to lockers that can be accessed during bot development.  
For more information, see [Set up lockers and credentials in Credential Vault](#) on page 1862.

This procedure is for a sample scenario where you want to trigger a bot when you receive a Microsoft 365 Outlook email that meets one the following conditions:

- Email is from sales@example.com.
  - The subject line contains the phrase `Monthly sales report`.
  - The email contains an attachment.
1. Log in to the Control Room as a Bot Creator.
  2. On the left pane, click **Automation**.  
A list of available bots and forms are displayed.
  3. Click **Create new > Task Bot**.
  4. In the **Create a bot** page, enter `Sales Report` in the **Name** field.  
All the bots are stored in the `\Bots` folder location.
  5. Optional: Click **Browse** to change the default location.
  6. Click **Create & edit**.
  7. In the bot editor page, click **Triggers > Microsoft 365 Outlook** and double-click or drag **Email**.
  8. Click the **Azure Cloud** drop-down menu and select **Azure Global**.  
**Azure Global** is used for the Microsoft 365 Commercial version (login.microsoftonline.com) while **Azure GCC High** is used for the Microsoft 365 Government version (login.microsoftonline.us).
  9. Use the **Check every** field to change the trigger interval time to 40 minutes.  
The trigger interval for the bot is set to **120** minutes by default.
  10. Verify **Client Credentials** is selected under the **Authentication mode** drop-down menu.
  11. For the **Client ID**, **Tenant ID**, **Username** and **Client Secret** fields, select the **Credential** tab and click **Pick** to select a value from the Credential Vault.  
Use the **Insecure String** tab to provide an existing variable.
  12. In the **Select Conditions** field, select the following options for the email events:
    - **Email from**: Enter sales@example.com.
    - **Email subject contains**: Enter `Monthly sales report`.
    - **Email attachment**: Select **With attachment**.
  13. Optional: Use the **Assigned to (optional)** drop-down menu to either select an existing record variable, or click the **Create variable** icon to create a record variable that you want to assign.  
You can use this variable to retrieve various details about the email that triggered the bot, such as sender, recipient, subject, email content, date, action information, email server host, and port data.
  14. Click **Save** to save your configuration.  
Microsoft 365 Outlook is now configured to trigger the associated bot when the specified email events under the **Select Conditions** field occur.

## Add a process trigger

Starts a bot when a predefined action occurs on the selected Microsoft Windows process.



This procedure is for a scenario where you want to configure a trigger to start a bot when users launch or close Microsoft Outlook. Before you configure the process trigger, ensure that you have the Microsoft Outlook application open on your system so that you can select this process.

1. On the left pane, click **Automation**.  
A list of available and forms is displayed.
2. Click **Create new > Bot**.
3. Enter a name for the bot.  
All the bots are stored in the \Bots folder. (Optional) Click **Browse** to change the folder.
4. Click **Create & edit**.
5. In the bot builder page, click **Triggers > Process trigger**.
6. Drag **Process** into **Drag a trigger here**.  
The **Process trigger: Process** editing panel appears.
7. Click the **Process name** drop-down menu and select **Outlook.exe**.  
Refresh the **Process name** drop-down menu if none of the processes are listed.
8. Select the following check boxes to set the trigger condition:
  - **Starts**: Triggers the bot when users launch or start Microsoft Outlook.
  - **Stops**: Triggers the bot when users close or stop Microsoft Outlook.
9. Optional: Use the **Assigned to** drop-down menu to assign a variable.  
If you want to use the **Variables** tab to create a variable, ensure that you select the **Use as input** check box for it to appear in the **Assigned to (optional)** drop-down menu.
10. Click **Save**.
11. Click **Run > Run with triggers**.  
The preset trigger is created, and the bot is triggered when the user launches or closes the Microsoft Outlook application.

## Add a service trigger

Starts a bot when any of the predefined actions occur on the selected service in Microsoft Windows.

This procedure is for a scenario where you want to configure a trigger to start a bot when the **Windows Update** service is started, stopped or is paused by a user.

1. On the left pane, click **Automation**.  
A list of available and forms is displayed.
2. Click **Create new > Bot**.
3. Enter a name for the bot.  
All the bots are stored in the \Bots folder. (Optional) Click **Browse** to change the folder.
4. Click **Create & edit**.
5. In the bot builder page, click **Triggers > Service trigger**.
6. Drag **Service** into **Drag a trigger here**.  
The **Service trigger: Service** editing panel appears.
7. Click drop-down menu and select **Windows Update**.  
Refresh the drop-down menu if none of the services are listed.
8. Select the following checkboxes to set the trigger condition for the **Windows Update** service:

- **Starts**
  - **Stops**
  - **Pauses**
9. Optional: Use the **Assigned to** drop-down menu to assign a variable.  
If you want use the **Variables** tab to create a variable, ensure you select the **Use as input** check box for it to appear in the **Assigned to (optional)** drop-down menu.
  10. Click **Save**.
  11. Click **Run > Run with triggers**.  
The preset trigger is created, and the bot is triggered when any user starts, stops or pauses the **Windows Update** service.

## Add a window trigger

Starts a bot when the predefined application window is opened or closed by the user.

This procedure is for a scenario where you want to configure a trigger to start a bot when any user opens a Microsoft Excel document called **Customer\_database.xls**. Before you configure this window trigger, ensure that you have opened the **Customer\_database.xls** document on your system so that you can select this window.

1. On the left pane, click **Automation**.  
A list of available and forms is displayed.
2. Click **Create new > Bot**.
3. Enter a name for the bot.  
All the bots are stored in the `\Bots` folder. (Optional) Click **Browse** to change the folder.
4. Click **Create & edit**.
5. In the bot builder page, click **Triggers > Window trigger**.
6. Drag **Window** into **Drag a trigger here**.  
The **Window trigger: Window** editing panel appears.
7. Click the **Window** drop-down menu and select **Customer\_database.xls**.  
Refresh the **Window** drop-down menu if none of the available windows are listed.
8. Under the **Window title** field, click the **String** tab to set the entire title of the selected window.  
  
The **Regex** tab can be used to select a pattern that matches the selected window title. For example, if you select the **Regex** option in this scenario, the bot is triggered if the user opens any `.xls` file.
9. Select **Open** from the **Window action that start the bot** drop-down menu.
10. Optional: Use the **Assigned to** drop-down menu to assign a variable.  
If you want use the **Variables** tab to create a variable, ensure you select the **Use as input** check box for it to appear in the **Assigned to (optional)** drop-down menu.
11. Click **Save**.
12. Click **Run > Run with triggers**.  
The preset trigger is created, and the bot is triggered when any user opens the **Customer\_database.xls** document.

## ServiceNow New Record trigger

Create a trigger to monitor a ServiceNow table for new records and begin succeeding RPA actions in your bot flow.

- The bot creator must have access to a ServiceNow account with required permissions to perform tasks enabled by this package. See [Roles](#).
- Follow ServiceNow guidelines for authenticating to an external client with OAuth 2.0. See [Set up OAuth](#).
- Create a Developer account and Developer instance in ServiceNow. See [Personal Developer Instances](#).
- Ensure that you are authenticated before initiating any ServiceNow action. See [Authentication](#) on page 3019

The new record trigger monitors the creation event of any record within a time period. Upon record creation, the trigger invokes and returns data. If multiple records are created within the entered time period, then the trigger returns data of multiple records.

Map your trigger to a ServiceNow table, and then enter the time period to send a query for that table data. When a new record is found, this trigger is invoked and begins succeeding bot actions.

1. Enter the **URL** for your ServiceNow instance.
2. (Optional) Enter the API version.
3. Select how ServiceNow credentials will be entered for the following fields.

Option	Description
Credential	Select a credential saved in a secure locker that you have mapped to your Control Room.
Insecure string	Enter the credential.

- a) Enter the **Client ID**.
  - b) Enter the **Client secret**.
  - c) Enter the **Username**.
  - d) Enter the **Password**.
4. Enter the **Table name** in ServiceNow to monitor for new records.  
A query is sent, and ServiceNow returns data for this table. When a new record is returned in the data, then this trigger is invoked.
  5. (Optional) To store a response from ServiceNow, select and enter a **List** or **Variable** input where the response is stored.
  6. (Optional) Apply filters to specify the type of ServiceNow record to monitor.
  7. Enter how frequent the trigger searches for new records in the **Check every (seconds)** field.
  8. (Optional) Select a variable to save returned data by the trigger.

## ServiceNow Updated Record trigger

Create a trigger that monitors a ServiceNow table for updated records and begins succeeding RPA actions in your bot flow.

- The bot creator must have access to a ServiceNow account with required permissions to perform tasks enabled by this package. See [Roles](#).
- Follow ServiceNow guidelines for authenticating to external client with OAuth 2.0. See [Setup OAuth](#).
- Create a Developer account and Developer instance in ServiceNow. See [Personal Developer Instances](#).
- Ensure that you are authenticated before initiating any ServiceNow action. See [Authentication](#) on page 3019

The updated record trigger monitors the record within a time period. When updates occur, the trigger invokes and returns data. If multiple records are updated within the entered period, then data of multiple records is returned.

Map your trigger to a ServiceNow table. Enter the time period to send a query for that table data. When an updated record is found, this trigger is invoked and can begin succeeding bot actions.

1. Enter the **URL** for your ServiceNow instance.
2. Enter the API version.
3. Select how ServiceNow credentials will be entered for the following fields.

Option	Description
Credential	Select a credential saved in a secure locker that you have mapped to your Control Room.
Insecure string	Simply enter the credential. This data will remain visible.

- a) Enter the **Client ID**.
  - b) Enter the **Client secret**.
  - c) Enter the **Username**.
  - d) Enter the **Password**.
4. Enter the **Table name** where the record is located in ServiceNow.  
This data is what the trigger monitors. A query is sent, and ServiceNow returns data for this table. When a record update is returned in the data, then this trigger is invoked.
  5. (Optional) To store a response from ServiceNow, select and enter a **List** or **Variable** input where the response is stored.
  6. (Optional) Apply filters to specify the type of ServiceNow record to monitor.
  7. Enter how frequent the trigger searches for updated records in the **Check every (seconds)** field.
  8. (Optional) Select a variable where returned data is saved by the trigger.

## Move a bot

As a Bot Creator, you can now move your bots and files from one folder to another with ease in the private workspace. If a bot is placed in an incorrect folder, you no longer have to clone it in the correct folder and then delete it from the incorrect folder.

- You can move only newly created bots and files or folders containing the newly created bots and files. Checked-out, edited, and cloned bots cannot be moved.
  - You can move bots or files only in the private workspace and not in the public workspace.
1. Log in to the Control Room as a Bot Creator user.
  2. Select the bot or file to move. Hover over the actions menu (vertical ellipsis) located to the right of the bot or file name and click **Move Task Bot**.
  3. Browse and select the folder to which you want to move the bot and click **Choose**. The bot is copied to the destination folder and removed from the source folder.

---

### Note:

- When the bot is moved, you will see a warning message to change the reference in all the parent bots.
- You can move a folder or a sub-folder into another folder when the number of items in the folder is less than 100. An error message is displayed if the folder contains more than 100 items (including metadata).

---

See the following video to understand how to move bots and files between folders.

## Check in a bot

Check in the bot files or folders to the public workspace from private workspace to make it available for all users who have the permission to access and run the bot.

- You must have Bot Creator or Citizen Developer license to check in a bot to the public workspace.
- You must be assigned a custom role with the following permissions:
  - Required: Check in permission at the folder level and at the corresponding parent folder level in the public workspace.
  - Optional: Create folder permission.
  - Optional: View packages permission.
- To check in a bot with dependent folders and files, ensure you have the following:
  - Create folder permission.

If you are checking in a bot from your private workspace and if the folder in which the bot is present does not yet exist in the public workspace, you must have create folder permission to successfully check in the bot.
  - Check in permission on the dependency folder.
- Ensure that your private and public workspaces have the same folder structure so that when you check in a bot from your private workspace, it will appear in the same folder structure in the public workspace.

- For example, if you check in a bot from the sample bot folder in the private workspace, it will appear in the sample bot folder in the public workspace.

If you want to check in multiple bots as a unit that are not dependent on each other, create a main bot and then add the other bots as dependencies to this main bot. Check in the main bot.

1. Log in to the Control Room as a Bot Creator or a Citizen Developer user.
2. On the left pane, click **Automation** in the private workspace.  
A list of available bots and forms is displayed.
3. You can choose to check in either one bot or multiple bots simultaneously.
  - Check in a single bot.
    - a) Select the bot that you want to check in, click the actions menu (vertical ellipsis), and click **Check in Task Bot**.
    - b) In the **Check in Task Bot** window, add your comment and click **Check in**.

**Note:** Directly referenced dependencies are checked in by default. The **General** tab shows only the immediate dependencies; however, all the nested dependencies are displayed in the **Review dependencies** tab, and these are also checked in.

For example, consider a scenario where we have parent bot Acme Insurance having departments as child bots HR, Sales and Marketing, and IT services. These child bots have dependencies Employee details, Employment type, and Employee status.

When you check in the parent bot Acme Insurance, in the general dependency tab, only the direct dependencies HR, Sales and Marketing, and IT services are displayed and selected to be checked in by default.

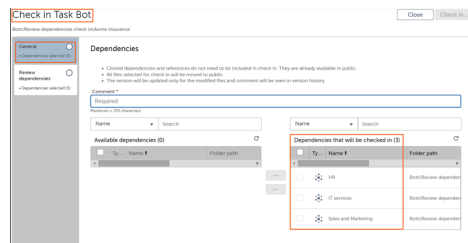

The review dependencies tab displays all these child bots along with the other available nested dependencies such as Employee details, Employment type, and Employee status that are also checked in along with the parent bot.

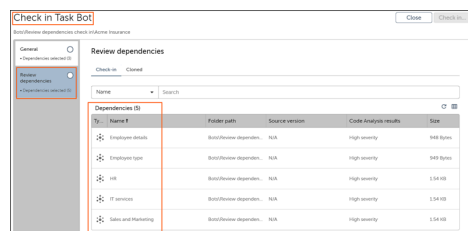

- Check in multiple bots.

**Note:** You can check in up to 10 bots at a time.

- a) Select the bots that you want to check in and click **Check in checked items**.

**Note:** All the inherited dependencies are included to be checked in.

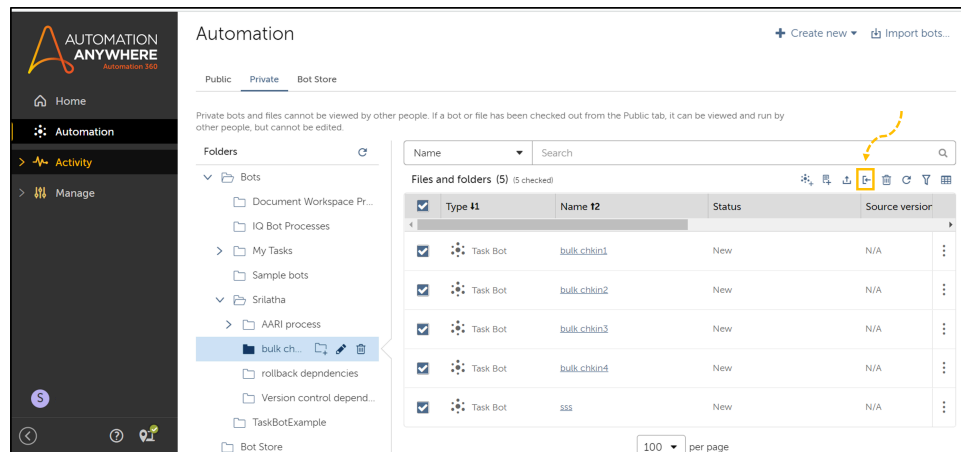

- b) Add the comment and click **Check in**.
- c) Optional: Select **Advanced options** to view or modify the selected dependencies, add the comment, and click **Check in**.

The bot appears in the same folder structure in the public workspace.

**Note:**

- You cannot check in a bot file if another bot file already exists in the same location in the public workspace.
- When you check in a bot along with a cloned bot and no other bots are dependent on the clone, the cloned bot is deleted.

If you have issues in checking in a bot, see [Unable to check-in the bots in Automation 360 \(A- People login required\)](#).

## Checking out a bot and dependencies

The check out process enables you to create an editable copy of the bot in the private workspace from the public workspace for further modification.

After you have modified the bot, you can check in the bot again to the public workspace so that it can be deployed by all users who have permission to access it. You can choose the specific version of the bot and its dependencies (bot and non-bot) during the check-out process.

You can cancel the checked-out bot from your private workspace whereas an administrator can cancel the checked-out bot from the public workspace. This releases the bot for another user who has access in the public workspace. When you cancel check out, the bot status changes to **Public** in the public workspace. In the private workspace, the status changes to **New** if any edits are made to the bot. If there are no changes, the bot is replaced with a clone.

## Guidelines for checking out bots

While checking out a bot, keep the following considerations in mind:

- If you want to check out multiple bots as a unit that are not dependent on each other, create a main bot and then add the other bots as dependencies to this main bot. Check out the main bot.
- Only one user can check out a bot at a time. When a user checks out a bot, it cannot be checked out by any other user.
- If you are checking out a parent bot in the public workspace whose dependencies are checked out by another user, the dependencies of the parent bot will be cloned in your private workspace.
- If a bot is checked out, it cannot be deleted. The bot should be in a checked-in (**Public**) state to be deleted.
- When you edit a checked-out bot, the status changes to **Checked out edited**.

You can use the **Revert edits** option to revert changes you made to the checked-out bot.

- During check out, a cloned bot can be overwritten or replaced.
- The dependent files are automatically cloned if they are checked out by another user and you have the **Clone** permission on the bot folder.
- The bot check-out timeout value is 30 minutes. If you have a large bot, sometimes the bot might not check out within 30 minutes, and the check-out operation fails. Break your bot into logical sub-bots so that they are easily manageable and checked out in less time.

## Prerequisites for checking out bots and dependencies

- You must have Bot Creator or Citizen Developer license to check out a bot to your private workspace.
- You must have check out permission at the folder level.
- You must have the check out permission on the dependency folders to check out a bot with dependent folders and files.
- You must have the **Cancel checkout** and **View content** permissions on a public workspace to cancel or undo a check out performed by a Bot Creator user,

You do not require the **Cancel checkout** permission to cancel the checked out bot from a private workspace.

## Checking out bots

You can check out single or multiple bots along with their dependencies. You can also choose the version of the bot and their dependencies during the check out.



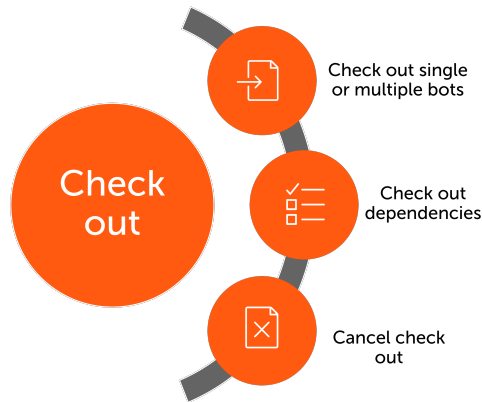

- [Check out a single bot](#)
- [Check out multiple bots](#)
- [Check out file dependencies](#)

### Check out a single bot

Check out the specific version of a parent bot and its dependencies from the public workspace to the private workspace to create an editable copy of the bot.

[Prerequisites for checking out bots and dependencies](#) on page 2304

1. Log in to the Control Room as a Bot Creator or a Citizen Developer user.
2. On the left pane, click **Automation**.  
A list of available and forms is displayed.
3. Select the bot, choose to either clone or check out the dependencies, open the actions menu (vertical ellipsis) and click **Check out Task Bot**.

**Note:** If a bot has multiple versions, you can select and check out the specific version of the bot using **Advanced options**. This enables you to roll back to an earlier version of the bot.

Option	Steps
Yes, Checkout	Select this option to check out the latest version of a bot. The dependencies are cloned automatically.

Option	Steps
Advanced options	<p>Select this option to select a specific version of the parent bot and dependencies.</p> <ol style="list-style-type: none"> <li><b>a)</b> Click <b>Advanced options</b>.</li> <li><b>b)</b> Select the version of the parent bot to check out.</li> <li><b>c)</b> Add or remove dependencies to check out.</li> <li><b>d)</b> Select the version of the dependency (bot or non- bot ) to check out.</li> <li><b>e)</b> Review the dependencies (<b>Overwritten, Missing, Cloned, Skipped</b>).</li> <li><b>f)</b> Click <b>Check out</b>.</li> </ol>

The bot appears in the same folder structure in the private workspace. When you check out bot files or folders, all the dependencies linked to the bot files or folders will either be checked out or cloned according to your choice.

4. To cancel the checked-out bot, click the **Cancel check out Task Bot** option.

You can use this option from either the public or the private workspace.

In the public workspace, the bot status changes to public, and the bot is available for check out by another user with the appropriate permissions.

In the private workspace, the bot status changes to new if any changes are made to the bot. If there are no changes, the bot is replaced with a clone.

## Check out multiple bots

Check out the specific versions of the parent bots and its dependencies from the public workspace to the private workspace to create an editable copy of the bot.

Ensure you have completed all the prerequisites for checking out bots:

- [Prerequisites for checking out bots and dependencies](#) on page 2304
  - Check out up to 10 parent bots at a time
  - Check out only the latest version of the bot
1. Log in to the Control Room as a Bot Creator or a Citizen Developer user.
  2. On the left pane, click **Automation**.  
A list of available bots and forms is displayed.
  3. Select the bots you want to check out and from the table level icons, click **Check out checked items**.

---

**Note:** You can check out up to 10 parent bots at a time. You can check out only the latest version of the bot and its dependencies.

---

Option	Steps
Check out	Select this option to check out the latest version of a bot. The dependencies are cloned automatically.
Advanced options	<p>Select this option to review the information about the bot and dependencies which can be checked out, skipped, cloned and click <b>Check out</b>.</p> <ul style="list-style-type: none"> <li>• The <b>Files</b> tab displays the bot files that can be checked out.</li> <li>• The <b>Checkout Dependencies</b> tab displays the dependencies which you can choose to check out.</li> <li>• The <b>Review dependencies</b> tab displays the information on the dependencies which are <b>Overwritten, Missing, Cloned, or Skipped</b>.</li> </ul>

The bot appears in the same folder structure in the private workspace. When you check out bot files or folders, all the dependencies linked to the bot files or folders will either be checked out, cloned, skipped, or overwritten. For more information, see [Considerations for checking out multiple bots](#) on page 2307.

#### Considerations for checking out multiple bots

There are certain considerations you have to keep in mind when checking out multiple bots.

- You can check out up to 10 parent bots at a time.
- You can only check out the latest version of the bot. You cannot select a specific version of the bot to check out.
- During check out of multiple bots, the parent bots and their dependencies are either checked out, cloned, skipped, or overwritten depending on different scenarios.

The following table explains the different scenarios of the parent bots and their dependency behavior during check out of multiple bots.

Scenario	Behavior
Parent bot not checked out by the current user	The parent bot is checked out as part of the bulk checkout and is shown in the check-out section of the basic flow.
Dependency not checked out by the current user	The dependency is checked out as part of the bulk check out and is shown in the check-out dependencies section of the advanced flow.
Parent bot is already checked out by the current user	The parent bot is not re-checked out and is shown in the skipped section of the basic flow.
Dependency already checked out by the current user	The dependency is not re-checked out and is shown in the skipped section of the advanced flow.
Dependency checked out by other users	The dependency is cloned during bulk check out.
Parent bot already cloned by the current user and requiring a check out	The parent bot is checked out as part of the bulk checkout, and the clone will be replaced with the checked out bot.

Scenario	Behavior
Dependency already cloned by the current user and requiring a check out	The dependency is checked out as part of the bulk checkout, and the clone will be replaced with the checked out bot.
Dependency already cloned by the current user and is shown again for cloning in bulk check out	The dependency is not re-cloned and is shown in the skipped section of the advanced flow.
Parent bot is in new status in private workspace	During bulk check-out, the user is provided an option to overwrite the bot in the basic flow.
Dependency is in new status in the private workspace	If the dependency is to be checked out, it is shown in the overwrite section of the advanced flow. If the dependency is to be cloned, it is shown in the cloned section of the advanced flow.

## Clone a bot

Create a read-only copy of the bot from the public workspace to the private workspace so that you can have a local copy without checking out the bot.

- Create a user with a Bot Creator license.
- Create a custom role with the clone permission assigned at the folder level to the user.
- To clone a dependency folder, you must have the clone permission on the dependency folder.

Cloning a bot does not affect other users' access to the bot in the public workspace. A bot can be cloned by multiple users.

You cannot edit a cloned bot. To edit a bot in your private workspace, choose one of the following options:

- Create a copy of the cloned bot and edit.
- Delete the clone, check out the bot to your private workspace, make changes, and re-check in the bot.

For more information on editing a bot, see [Edit a bot](#) on page 2313.

1. Log in to the Control Room as a Bot Creator user.
2. On the left pane, click **Automation**.  
A list of available and forms is displayed.
3. Select the bot you want to clone, click the actions menu (vertical ellipsis), and click **Clone Task Bot**.

The cloned bot appears in the same folder structure in the private workspace.

Related tasks

[Edit a bot](#) on page 2313

Edit bot logic using the Bot editor to add, modify, or delete actions and automation steps.

## Delete a bot

If you are a Control Room administrator or user with **Delete from Public** permission, you can delete bots from the public workspace. If you are a Bot Creator, you can delete bots from your private workspace.

To delete a bot, ensure the following:

- Public workspace: You must have the Control Room administrator role or the **Delete from Public** permission at the folder level.
- Dependent folders and files: You must have the **Delete from Public** permission on these folders and files.
- Private workspace: You must have a Bot Creator license.

Keep the following considerations in mind before deleting a bot.

- You cannot restore a deleted bot either from public or private workspace, so ensure that you no longer require a bot before deleting it.

---

**Note:** After you delete a bot, if you immediately create a bot with the same name as the deleted bot and create it in the same folder, an error is displayed in some cases. To avoid this error, after you delete a bot, wait for at least 5 seconds for the deletion to be completed. You can create another bot with the same name as the deleted bot and in the same folder.

---

- You cannot delete a bot if it is referenced by other bots. You must first remove the references before deleting the bot.

- Delete bots from a private workspace:

In a private workspace, you can delete only bots that are in the **New** or **Cloned** status. You cannot delete a bot in the **Checked out** or **Checked out and edited** status.

- Log in to the Control Room as a Bot Creator.
- On the left pane, click **Automation**.  
A list is displayed with the available files and folders containing the bots.
- From the **Automation** page, choose one of the following methods to delete a bot:

Option	Action
Specific bot	<ol style="list-style-type: none"> <li>Select the bot.</li> <li>Hover over the actions menu (vertical ellipsis) located to the right of the bot name and click <b>Delete Task Bot</b>.</li> <li>Click <b>Yes, delete</b>.</li> </ol>
Multiple bots	<ol style="list-style-type: none"> <li>Select the check boxes corresponding to the bots, and click <b>Delete checked items</b>.</li> <li>Click <b>Yes, delete</b>.</li> </ol>

- Delete bots from a public workspace:  
In the public workspace, you can delete only bots that are in the **Public** status. You cannot delete bots that are in the **Checked out** status.
  - a) Log in to the Control Room as an administrator, a Bot Creator, or an attended or unattended Bot Runner user with **Delete from Public** permission.
  - b) On the left pane, click **Automation**.  
A list is displayed, with the available files and folders containing the bots.
  - c) From the **Automation** page, choose one of following methods to delete a bot:

Option	Action
Specific bot	<ol style="list-style-type: none"> <li>a) Select the bot.</li> <li>b) Hover over the actions menu (vertical ellipsis) located to the right of the bot name and click <b>Delete Task Bot</b>.</li> <li>c) Click <b>Yes, delete</b>.</li> </ol>
Multiple bots	<ol style="list-style-type: none"> <li>a) Select the check boxes corresponding to the bots, and click <b>Delete checked items</b>.</li> <li>b) Click <b>Yes, delete</b>.</li> </ol>

## Preload packages

You can preload packages on your local device to shorten the bot runtime.

When you run a bot, the system downloads the bot and all the packages used in the bot. Bot execution begins when the download is complete. If the packages used in the bot are preloaded, the system can skip downloading the packages and start executing the bot, thereby reducing the bot execution timeframe.

Folder path: Preloaded packages are stored in `\ProgramData\AutomationAnywhere\GlobalCache` on the local device.

If there are multiple versions of a package, only the default package is preloaded. You can only preload packages on your local device. For the option to be available, the automatically download preloaded packages setting must be enabled by the Control Room admin.

---

**Note:** You can also save specific versions of packages that are used in bots offline to save the time it takes to download these packages from the Control Room. The specific version of packages are stored in the `C:\ProgramData\AutomationAnywhere\AAPreloadedPackages` folder. You must create this folder manually `C:\ProgramData\AutomationAnywhere\AAPreloadedPackages`.

---

Perform the following steps to preload packages on your local device:

1. Log in with a Bot Creator account.
2. Click the **Manage > Devices > Preload package** icon in the menu list for your local device.

**Note:** The **Preload package** option is also available from the device icon drop-down menu for Automation 360 Cloud through the Google Chrome browser with the Chrome plug-in enabled.

3. In the **Preload packages** window, preload either all packages listed on the **Common packages** page, or select individual packages from the **Customize packages** page.

Common packages are the most lightweight and most commonly used ones.

4. Click the **Start preloading** option.

## Copy a bot

Copy a bot to create a duplicate sequence of actions within your private repository. The copy retains the meta-data of the original bot including captured images, recorded objects, called files, and child bots.

To copy a bot, follow these steps:

1. On the left pane, click **Automation**.  
A list of available and forms is displayed.
2. Mouse over the actions menu.  
The actions menu is the vertical stack of three dots to the left of each bot.
3. Click the Copy Task Bot icon.
4. In the **Name** field, enter a name for the duplicate bot.

**Important:** Bot name must be unique. If a bot with the same name exists in the same folder location which you have access to in the public workspace, you will not be able to copy the bot with this name in the private workspace.

Consider the following naming conventions when copying bots:

- Ensure that a bot name does not end with a period (.) or space.
- Do not use bot names that are reserved for the Windows operating system. The reserved bot names are as follows:

CON	PRN	AUX	NUL	COM1
COM2	COM3	COM4	COM5	COM6
COM7	COM8	COM9	LPT1	LPT2
LPT3	LPT4	LPT5	LPT6	LPT7
LPT8	LPT9	--	--	--

- For more information about file naming, see [Microsoft guidelines](#).
5. Optional: Click **Browse** to select the folder where to save the bot.
  6. Click **Copy**.  
The duplicate bot appears in the specified folder.

## View Task Bot version history

View the history of the changes that have occurred in your Task Bots. You can identify actions performed by other users during a specific date and time along with check-in messages.

You must have either check-in or check-out permissions.

You can view the version history of the Task Bots available in the public workspace (only if there are checked-out bots). However, there is no version history available for new and the cloned Task Bots.

The check-in or the check-out permission is required for the Bot Runner to view the version history. However, note that this permission cannot be used by the Bot Runner to check in or check out bots.

1. Log in to the Control Room.
2. On the left pane, click **Automation**.  
A list of available and forms is displayed.
3. View the version history of Task Bots in the following ways:
  - Select the Task Bots for which you want to view version history. Hover over the actions menu (vertical ellipsis) located to the right of the Task Bots name and click **View history Task Bot**.
  - Click the bot name. When the bot opens, click the vertical ellipsis at the top-right corner and select the **View history Task Bot** option.

A message appears listing all the versions of the selected bot in a sequence (latest revision on the top and the first revision is at the end). The information includes the version number, check-in message, checked-in date and time, and checked-in by username.

## Assign label to a bot

You can now assign a production label for a particular version of a bot. You can use this label to choose the version on which you want to perform certain bot operations. With the version of your choice, you can schedule, run, queue, export, and trigger bot development workflows.

- You must have a custom role with the **Label bots** permission.
  - You can apply labels only to the bots that are checked in to the public workspace.
1. Log in to the Control Room.
  2. On the left panel in the public workspace, click **Automation**.  
A list of available bots and forms is displayed.
  3. Select a bot, hover over the Actions menu (vertical ellipsis) on the right of the bot name, and click **Label Task Bot**.  
A list of available versions of the bot is displayed.
  4. Select the version of the bot to which you want to apply a label.
  5. Click the right arrow (→) to add your selection.
  6. Click **Apply Label**.  
The label **Production** is now assigned to the bot.

---

**Note:** If the production label option is selected for the parent bot, the corresponding dependent bots with the production label are also automatically selected. If any of the



dependent bots do not have the production label applied, the latest version of the bot is selected. However, if the dependent bot is called through **Task Bot > Run > Variable > Control Room path** option, always the latest version of the bot is selected even if the production label is applied to the bot.

---

## Edit a bot

Edit bot logic using the Bot editor to add, modify, or delete actions and automation steps.

Create a user with a Bot Creator or Citizen Developer license.

Consider an automation example where a Message Box action is used. Perform the following steps to edit the task bot:

1. Log in to the Control Room as a Bot Creator user.
2. On the left pane, click **Automation**.  
A list of available bots and forms is displayed.
3. Perform one of the following actions to edit a bot.
  - Click the required bot.
  - Click the actions menu (vertical ellipsis), and click **Edit Task Bot**.

The bot opens in the edit mode.

4. Click the Message Box action in the automation.
5. In the dialog box on the right, edit the required values for the **Message box** action such as:
  - a) In the **Enter the message box window title** field, enter `My edit to task bot`.
  - b) In the **Enter the message to display** field, enter `Bot Games`.
  - c) Edit value in the **Scrollbar after lines** field and **Close message box after** check box.

---

**Note:** The type and number of variables might vary based on the various actions used in an automation.

---

6. Click **Save**.

## Compare bot versions

You can compare different versions of your bots and view any modifications in your workflows in both the public and the private workspaces.

Ensure you have the following permissions:

- **View my bots**
- **View content**
- **Check in** or **Check out**
- Public workspace
  - a) Log in to the Control Room as a Bot Creator or a Citizen Developer user.
  - b) Navigate to the public workspace.
  - c) On the left pane, click **Automation**.

A list of available bots and forms is displayed.

- d)** Select a bot, hover over the actions menu (vertical ellipsis) on the right of the bot name, and click **Compare versions**.  
The compare version page appears with two versions of your bot. The left column shows the previous version of your bot, and the right column shows the newer version of your bot.
- e)** Click the **Change version** icon to select and confirm the version of the bot that you want to compare on the left and right column.  
You can review the two versions of your bot. The red highlights on the left column show the lines that are modified. The green or blue highlights on the right column show the lines that are added or changed. This view shows the bot versions by **Actions**.

---

**Note:** When you compare two versions of a bot, you might sometimes not observe any visible changes. This is because the bot version is modified as a result of changes in the underlying JSON file.

---

- f)** Optional: Select **Variables, Triggers, Packages, or Dependencies** to compare your bot versions by these categories.

---

**Note:** The changes made to the immediate dependencies are displayed, and the dependencies are sorted in an alphabetical order.

---

- g)** Optional: Select the **Swap versions** icon to swap between your two current versions.
- h)** Click **Close** to exit the comparison view.

- Private workspace

- a)** Log in to the Control Room as a Bot Creator or a Citizen Developer user.
- b)** Navigate to the private workspace.
- c)** On the left pane, click **Automation**.  
A list of available bots and forms is displayed.
- d)** Select a bot, hover over the actions menu (vertical ellipsis) on the right of the bot name, and click **Compare versions**.  
The compare version page appears with the left column displaying the source checked-out version of the bot in the public workspace and the right column displaying the checked-out and edited bot in the private workspace.
- e)** Click **Change version** to change the current bot version in the left column (**Public** version).  
The **Select version to compare** page prompts you to select a new bot version.

---

**Note:** You cannot change version on the right column (**Private** version).

---

- f)** Select and confirm the version of the bot that you want to compare on the left column. You can review the source and edited versions of your bot. The red highlights on the left column show the lines that are modified. The green or blue highlights on the right column show the lines that are added or changed. This view shows the bot versions by **Actions**.
- g)** Optional: Select **Variables, Triggers, Packages, or Dependencies** to compare your bot versions by these categories.

**Note:** The changes made to the immediate dependencies are displayed, and the dependencies are sorted in an alphabetical order.

---

- h) Click **Close** to exit the comparison view.

## View bot dependency map

You can now view the dependency map for your bot in both the public and private workspaces. The dependency map shows the immediate parent and child bots for any selected bot. With this information, you can gauge the impact of the change in a bot, use the bot effectively, maintain better bot code and reusability, and prevent conflicts.

Ensure that you have the **View content** permission.

1. Log in to the Control Room.
2. On the left pane, click **Automation**.  
A list of available bots and forms is displayed.
3. View the dependency map of the bots in the following ways:
  - Select the bot for which you want to view version history. Hover over the actions menu (vertical ellipsis) located to the right of the bot name and click **View dependencies and references**.
  - Click the bot name. When the bot opens, click the vertical ellipsis at the top-right corner and select **View dependencies and references**.
4. Toggle between the **Dependencies** and **References** tabs to view the immediate parent and child bots.
  - **Dependencies:** Displays the bots or files that the bot uses to run
  - **References:** Displays the bots or files that depend on the bot to run

## Attach work item template to bot

Attach a work item template to a bot to use the bot in workload automation.

When you attach a work item template to a bot, you can use the variable **\$WorkItem\$** that contains the attributes for the required workload automation when you run the bot using the **Run bot with queue** option.

[Use Work Item variables](#) on page 2343

1. On the left pane, click **Automation**.  
A list of available bots and forms is displayed.
2. Create or edit a Task Bot from the **Automation** page.  
The Task Bot opens in edit mode.
3. Select the option **Work item template** from the menu at the top-right of the Workbench.  
The list of **Work item templates** appears.
4. Select the template that best suits your workload automation requirement.
5. Click the right arrow to add the template.  
The **Work item template attributes** are listed for the selected template.

6. Click **Save**.
7. Choose one of the following actions:
  - Click **Close** to return to the **My bots** page.
  - Click **Return to editor** to continue editing the Task Bot.

---

**Note:** When you attach a work item template to a bot, you must deploy the bot using the **Run bot with queue** option in the Bot editor. If you deploy the bot using the **Run bot now** or **Schedule bot** option, the bot execution fails.

---

Related concepts

[Workload management](#) on page 1996

The workload management module enables users to upload Microsoft Excel and CSV files to the Control Room so that it feeds the records from the files into the bot deployments.

Related tasks

[Use Work Item variables](#) on page 2343

You can use the Work Item variables to pass the Work Item attributes or values to the Task Bot from the Control Room when you run the bot with the option **Run bot with queue**.

Related reference

[Workload package](#) on page 3184

The Workload package enables you to insert work items in a queue for workload automation. It also enables data chaining between multiple queues. You can orchestrate multiple bots, and enable optimal device utilization through the queueing mechanism of workload management.

## Packages available in Automation 360

Actions are grouped into version-specific packages. Bot Creators can select which package version to use for a specific bot.

Basic users can only view the packages available in the Control Room and the specific package details.

Bot Creators require the **AAE\_Basic** permission to select specific packages to use within a bot.

Go to the **Manage > Packages** page to view all the packages in the Control Room.

## Packages updated in Automation 360

---

**Important:** With every Automation 360 general availability (GA) release, new packages or new package versions are provided with the latest innovations and all the code and security fixes from the previous versions. You can view package updates, including the compatible Control Room and Bot Agent versions.

- For v.27 and later releases, there are release-specific page for details about package updates in these releases. Navigate to the specific [Automation 360 Release Notes](#) on page 17, expand the table of contents, and open the Packages updated in v.xx page for release-specific information.
  - For information about packages in previous releases, see the PDFs available here: [Automation 360 previous release versions](#).
-

## List of packages in the Control Room

The following table provides information about the packages in the Control Room.

Package name	Description
<a href="#">Process Composer package</a> on page 2893	Enables user to configure their bots to work on requests, tasks, and team members.
<a href="#">Active Directory package</a> on page 2374	Automates Active Directory operations to manage users across a group or organization.
<a href="#">Analyze package</a> on page 2412	Performs transactional analytics for the data that is logged by the variables when the bot runs.
<a href="#">Apigee action package</a> on page 2413	Use the Apigee package to connect to an Apigee instance to run integrations and collaborate efficiently to function as one unit.
<a href="#">App Integration package</a> on page 2423	Captures the user-specified window or area and extracts text from it.
<a href="#">Application package</a> on page 2428	Opens an application or file
<a href="#">Boolean package</a> on page 2430	Performs various operations on Boolean values
<a href="#">Bot migration package</a> on page 2433	Migrates legacy (11.x and 10.x) bots to Automation 360 format. Also, converts legacy and Automation 360 bots to Microsoft Edge with IE mode.
<a href="#">Browser package</a> on page 2435	Enables you to download files, find broken links, and open a website.
<a href="#">Clipboard package</a> on page 2447	Automates tasks through the Windows clipboard such as copying a string value to the clipboard, copying a clipboard value to a string variable, and clearing the clipboard.
<a href="#">Comment package</a> on page 2452	Inserts a user-specified comment to the bot logic.
<a href="#">Credential package</a> on page 2448	Performs credential operations
<a href="#">CSV/TXT package</a> on page 2449	Opens a CSV or text file, reads data from the file, and assigns the data to a Table variable.
<a href="#">Database package</a> on page 2466	Connects to a database, starts a transaction, and manages the stored data.
<a href="#">Data Table package</a> on page 2452	Performs various operations on the values of table variables.

Package name	Description
<a href="#">Datetime package</a> on page 2484	Enables you to perform various operations on date/time values such as updating and comparing values in Datetime variables.
<a href="#">Delay package</a> on page 2492	Enables you to add a timed delay to the logic.
<a href="#">Dictionary package</a> on page 2493	Performs various operations on dictionary-type values.
<a href="#">DLL package</a> on page 2498	Uses a .dll file as reference and calls functions from the bot.
<a href="#">Document Extraction package</a> on page 2511	Extracts data from documents and downloads that data. This package is used for processing documents in Document Automation.
<a href="#">Email package</a> on page 2517	Automates email-related tasks through EWS, Microsoft Outlook, and other email servers.
Email trigger	Runs a Task Bot when an email is received in a particular email account.
<a href="#">Error handler package</a> on page 2552	Handles exceptions that a bot encounters and transfers control to other actions within that bot.
<a href="#">Excel advanced package</a> on page 2565	Automates tasks performed with Microsoft Excel spreadsheets. Use this package when Microsoft Excel is installed on the device.
<a href="#">Excel basic package</a> on page 2558	Automates spreadsheet tasks in xlsx workbooks when Microsoft Excel is not available on the device.
<a href="#">File package</a> on page 2600	Automates various file-related operations
<a href="#">Folder package</a> on page 2612	Automates folder-related operations
<a href="#">FTP / SFTP package</a> on page 2618	Automates FTP/SFTP operations
<a href="#">Genesys package</a> on page 2659	Automates the repetitive tasks related to onboarding and updating the details of contacts by using the actions in the Genesys package.
<a href="#">Google Calendar package</a> on page 2692	Automate creating and deleting events on Google Calendar.
<a href="#">Google Drive package</a> on page 2694	Automates tasks on files and folders on Google Drive.
<a href="#">Google Document AI package</a> on page 2720	Extracts data from documents by using the Google Document AI capabilities of the Google Document AI package in your bots.
<a href="#">Google Sheets package</a> on page 2703	Automates tasks involving cells, columns, rows, and sheets in Google Sheets.

Package name	Description
Hot keys	Triggers for hot key events
<a href="#">If package</a> on page 2724	Controls the sequence of execution based on one or more conditions of a task.
<a href="#">Image Recognition package</a> on page 2731	Searches for a user interface element in an application based on an image to automate a task in that application.
<a href="#">Interactive forms package</a> on page 2738	Provides actions that handle exceptions encountered by a bot. All the actions performed by users on the interactive forms can be monitored to execute logic using subtasks.
Interface trigger	Starts the bot when the Select main event takes place on the trigger interface element. For example, a user clicks on a button.
<a href="#">IQ Bot package</a> on page 2758	Uploads documents to and downloads them from an IQ Bot server.
<a href="#">IQ Bot Pre-processor package</a> on page 2742	Extracts content from documents or process image files before they are sent to IQ Bot.
<a href="#">JavaScript package</a> on page 2760	Opens and runs a JavaScript from a bot.
<a href="#">Json package</a> on page 2762	Extracts the required information from a JSON text or file and uses the extracted values in bots.
Legacy AISense	Provides actions to perform legacy AISense operations.
<a href="#">Legacy Automation package</a> on page 2765	Provides actions to perform legacy automation operations.
<a href="#">List package</a> on page 2774	Performs various operations on a variable of the list data type.
<a href="#">Log To File package</a> on page 2781	Creates a log file with data
<a href="#">Loop package</a> on page 2784	Runs a sequence of actions repeatedly for a specific number of times or until a specific condition is met.
<a href="#">Message box package</a> on page 2796	Shows a message box
<a href="#">Mouse package</a> on page 2798	Simulates mouse actions
<a href="#">Number package</a> on page 2802	Performs various operations on a number variable. A number variable holds numeric values, including integers and decimals.
<a href="#">OCR package</a> on page 2804	Extracts text from images or applications
<a href="#">Microsoft 365 Calendar package</a> on page 2811	Automates meeting-related tasks in Microsoft 365 Calendar.

Package name	Description
<a href="#">Microsoft 365 Excel package</a> on page 2821	Automates tasks in the online version of Microsoft Excel.
<a href="#">Microsoft 365 OneDrive package</a> on page 2841	Automates repetitive tasks in OneDrive application.
<a href="#">PDF package</a> on page 2879	Automates various operations on a PDF file
<a href="#">PGP package</a> on page 2888	Automatically encrypt and decrypt files for security.
Ping	Provides actions to perform ping operations.
<a href="#">Play Sound package</a> on page 2891	Plays sound files before or after an action is executed in a bot.
<a href="#">Printer package</a> on page 2891	Automates retrieving and setting the default printer and removing a printer from the list of available printers.
<a href="#">Process package</a> on page 2904	Contains a request action that enables the Control Room user to use this action and configure their bots.
Process trigger	Starts the bot on process events.
Process Discovery	Use this package to perform object operations.
<a href="#">Prompt package</a> on page 2905	Performs prompt operations such as entering a value, requesting a yes or no response, or selecting files or a folder.
<a href="#">Python Script package</a> on page 2907	Enables Python Script functions in a task
<a href="#">Record package</a> on page 2912	Performs various operations on record-type variables.
<a href="#">Recorder package</a> on page 2916	Records interactions with UI elements such as click, read, and write.
<a href="#">REST Web Service package</a> on page 2961	Use methods such as DELETE, GET, PATCH, POST, or PUT to send requests to and receive responses from an API.
<a href="#">Salesforce package</a> on page 2973	Automate your Salesforce CRUD operations on records, execute SOQL, and upload/download attachments.
<a href="#">SAP package</a> on page 2990	Automates tasks and processes on an SAP application.
<a href="#">SAP BAPI package</a> on page 3003	Contains actions to automate tasks and processes using SAP Business Application Programming Interface (BAPI). BAPI is a standardized method that enables a third-party application to interact with an SAP system.



Package name	Description
<a href="#">Screen package</a> on page 3011	Automates the process of capturing an area of an application window, entire screen, or active open window and saves it in a specified location in an image format.
<a href="#">Service package</a> on page 3016	Automates operations in Windows and application services including starting, stopping, pausing, resuming, or retrieving the status of a service.
<a href="#">ServiceNow package</a> on page 3018	Provides actions for ServiceNow Rest APIs.
<a href="#">Simulate keystrokes package</a> on page 3070	Simulates keystrokes in different language characters.
<a href="#">SNMP package</a> on page 3072	Automates network management tasks such as retrieving and modifying data, and sending notification messages.
<a href="#">SOAP Web Service package</a> on page 3084	Provides action to call SOAP web services and parse XML response.
<a href="#">Step package</a> on page 3085	Groups various actions together and runs them in a specific order. You can provide a relevant name for a step to identify the operation performed by the actions included in that step.
<a href="#">String package</a> on page 3086	Performs operations such as comparing two strings, retrieving the string length, or converting a string to uppercase or lowercase.
<a href="#">System package</a> on page 3105	Automates locking, logging off, restarting, and shutting down operations for a machine.
<a href="#">Task Bot package</a> on page 3109	Manages running one or more child from a parent bot or with a third-party software using an API.
<a href="#">Terminal Emulator package</a> on page 3117	Connects to and automate tasks on another machine. For example, run applications and access files on a different operating system.
<a href="#">Text file package</a> on page 3134	Open a text file, reads data from the file, and saves it to a string variable.
<a href="#">Trigger loop package</a> on page 3136	Runs a loop that can handle triggered events until stopped.
<a href="#">V11 Task Bot package</a> on page 3149	Runs Task Bots from version 11.3.2 and later.
<a href="#">VBScript package</a> on page 3153 <a href="#">VBScript package</a> on page 3153	Enables VBScript functions in a task

Package name	Description
<a href="#">Wait package</a> on page 3155	Adds a condition to wait for an application screen to change, or a separate window to open or close before proceeding to the next action.
<a href="#">Window package</a> on page 3174	Automates tasks relating to a window
Window trigger	Starts the bot based on window action.
<a href="#">Workload package</a> on page 3184	Enables you to insert work items in a queue for workload automation. It also enables data chaining between multiple queues. You can orchestrate multiple bots, and enable optimal device utilization through the queueing mechanism of workload management.
<a href="#">XML package</a> on page 3186	Automates the processing of XML data generated from web services and cloud computing applications.

## Select the package version used in your bot

As a Bot Creator you have the ability to select which package version to use for a set of actions within your bot.

You need to have **AAE\_Basic** permission.

**Tip:** For existing bots, follow these steps to update to the default package.

1. Open or create a new bot from **Automation** page.
2. Click the vertical ellipses in the upper right corner, and select **Packages**.

**Note:** The packages used in the selected bot are highlighted.

3. Click the drop-down list to view which version of the package is currently used for this bot.
4. To change the package version to be used for this bot, select the package version to use from the drop-down list of available packages.
5. Click **Change version**.
6. Click **Save**.

## Bot compatibility version

Bot compatibility version provides internal versioning for bot compilation and helps track different runtime behaviors for specific features. Compatibility version helps to maintain backward-compatibility when there are breaking changes (when you make changes in one part of the code that can cause potential issues in other areas).

## Available compatibility versions

Bot compilation occurs on the device where the Control Room is located. Typically a Windows or Linux device is used based on the deployment model (Windows for On-Premises and Linux for Cloud).

Depending on your requirements, choose one of the following versions:

Version	Description
1	The bot file path is parsed at compilation time.
2	The bot file path is parsed at bot runtime depending on the device on which the bot is running.  For example, the UNC (universal naming convention) path format is different for Windows and Linux. When you choose this version, a message is sent to the bot compiler to parse the file path during runtime instead of at compilation time.
3	The global value used in the parent bot is carried over to the child bot using a shared cache for the entire bot run which reduces the bot execution time.
4 (Default)	<ul style="list-style-type: none"> <li>When automations containing parent and child bots fail, enhanced error messages display the error details from the child bot.</li> <li>Verifies whether a DLL session exists even if the session name is defined through a variable.</li> </ul>

## Set the bot compatibility version

As a Bot Creator, you can set the bot compatibility version in the private workspace.

1. Log in to the Control Room.
2. In the private workspace, select the bot for which you want to set the version.  
The bot opens in edit mode.
3. From the actions menu (vertical ellipsis), select **Advanced settings**.
4. If the **Bot compatibility version** is set to **1**, **2**, or **3**, we recommend that you set it to **4** (default version) to enhance the bot performance. Ensure that the parent bot and all the child bots have the **Bot compatibility version** set to **4**.

---

**Note:** Each version includes new features in addition to those provided by the previous versions. By selecting the latest version 4, you will get the advantages of all the cumulative features of previous versions.

---

5. Optional: Select the **Enabled improved number support** check box in the **Advanced features** field.

This setting helps in accurate float number calculation (positive or negative whole number with a decimal point) for your new bots.

6. Return to the bot editor and save the bot.

## Compatibility version for migrated bots

After migration from Enterprise 11 to Automation 360 and if you have removed the `AAApplicationPath` from the destination path, your bot might fail. For more information on how to resolve this issue, see [Migrated bots and compatibility versions](#).

## Set automation priority for your bots

Set the automation priority of your bots to high, medium, or low so that higher-priority automations are processed first for deployment. This enables you to meet your business SLA (service-level agreement) for resource optimization.

- You must have a Bot Creator license.
- You must be assigned the **Set automation priority to high** permission.

You can set the automation priority when you create and edit a bot.

1. Log in to the Control Room as a Bot Creator user.
2. In the private workspace, select a bot for which you want to set the priority. The bot is opened in edit mode.
3. From the actions menu (vertical ellipsis), select **Advanced settings**.
4. Set the **Automation priority** to high, medium, or low based on your requirements. When bots are queued for a Bot Runner user, bots with higher priority are deployed before bots with lower priority. However, if a bot with lower priority is already running, bots with higher priority are deployed after the bot with lower priority completes running. The default permission is set to medium.
5. Return to the bot editor and save the bot.

## Configure timeout for bot execution

Specify the amount of time the system must wait before terminating a bot that is unresponsive or is taking more time than expected to complete the task.

When a task times out, any downstream tasks (tasks in a queue) can run without any issues.

Timeout for a task is not applicable in the following scenarios:

- When a task is manually paused.
- If the task is run in Debug mode.
- If the task is called through the **Run** action of the Task Bot package.
- When the first task in a process is paused, additional tasks are canceled and the first task is resumed.

1. Log in to the Control Room.
2. On the left pane, click **Automation**. A list of available and forms is displayed.
3. Open the bot for which you want to set timeout.

4. Select **Advanced settings** from the actions menu (three vertical ellipsis) on the top-right.
5. In the **Time out** field, specify the amount of time you want the system to wait before canceling a bot.  
By default, the value in the **Time out** field is set to zero (0) and the system waits till the bot completes execution.
6. Return to the Bot editor and save the changes to the bot.

## Create and rename folders

Depending on the permission assigned to you, you can create or rename folder names and description in the private workspace and rename the folder description in the public workspace. This helps to organize your bots and files in the Control Room repository.

To create folders, you must have the following permissions:

- View my bots
- Create folders

To rename folders, you must have the following permissions:

- View my bots
- Rename folders

You can grant access privileges to other users to specific folders so that they can perform various bot operations on the bots contained in that folder. Keep the following considerations in mind while renaming your folder:

- You can rename your non-empty folders only in the private workspace.
- Ensure the following when you rename a folder:
  - It does not contain checked-out or cloned bots even at subfolder levels.
  - It does not contain more than 100 items including subfolders and files.

Consider the following naming conventions when creating and renaming folders:

- Ensure that a folder name does not end with a period (.) or space.
- Do not use folder names that are reserved for the Windows operating system. The reserved folder names are as follows:

CON	PRN	AUX	NUL	COM1
COM2	COM3	COM4	COM5	COM6
COM7	COM8	COM9	LPT1	LPT2
LPT3	LPT4	LPT5	LPT6	LPT7
LPT8	LPT9	--	--	--

- For more information about file naming, see [Microsoft guidelines](#).
- Create a folder
  - a) Navigate to **Automation > Folder**.
  - b) Click a folder in the **Folders** tree view to open it. For example, **Bots > Sample bots**.

- c)** Click the icon to create subfolders in the **Folder** tab and provide an appropriate name.
  - d)** Browse and choose the path where you want to save the folder.
  - e)** Click **Create folder**.  
The folder is added and can be viewed in the **Folders** tree view and in the **Files and folders** tab.
  
- Rename a folder in the private workspace
  - a)** Navigate to **Automation > Folder**.
  - b)** Click a folder in the **Folders** tree view to open it. For example, **Bots > Sample bots**.
  - c)** In the **Files and folders** tab, hover over the folder that you want to rename and click **Edit folder** (pencil icon).
  - d)** Provide an appropriate name and description and browse and choose the path to the location where you want to save the folder.
  - e)** Click **Save changes**.
  
- Edit folder description in the public workspace
  - a)** Navigate to **Automation > Folder**.
  - b)** Click a folder in the **Folders** tree view to open it. For example, **Bots > Sample bots**.
  - c)** In the **Files and folders** tab, hover over the folder that you want to rename and click **Edit folder** (pencil icon).
  - d)** Enter a meaningful description and then browse to select the location where you want to save the folder.
  - e)** Click **Save changes**.

## Variables overview

Automation 360 offers a variety of variables, each designed to hold specific types of data and is intended for specific use. Use the topics below to learn more about each variable and how to use them.

### Using variables

The following table describes how Automation 360 passes variable values between a parent and child bot when using different data types:

Data type	Behavior
Number, String, Boolean, DateTime and Credential	You create a parent and a child bot using the following data types (Number, String, Boolean, DateTime and Credentials) and run the TaskBot. When the parent bot passes a variable to the child bot through input variables, and if you change the values of those variables in the child bot, the changes are not saved when execution returns to the parent bot. When you use these data types, the variable's actual value is passed, and any changes made to these variables in the child bot are not reflected in the parent bot.
List, Dictionary, File, Table, Window, Record, Session and Form	You create a parent and child bot using the following data types (List, Dictionary, File, Table, Window, Record, Session and Form) and run the TaskBot. When the parent bot passes a variable to the child bot through input variables, and if you change the values of those variables in the child bot, the changes are saved when execution returns to the parent bot. When you use these data types, the values are passed by reference, and any changes made to these variables in the child bot are reflected in the parent bot.

Example: You created a parent and child bot using the following variables:

- VarList: `Employee data (First name, last name, Date of birth)`
- VarString: `Employment type (Permanent)`
- VarNumber: `100`

You used the same variables in the child bot with the **Use as input** check box selected.

In the child bot, you updated the following values:

- Added a new detail in the VarList variable as `Employee data (Date of Joining)`
- Changed the value of the VarString variable to `Employment type (Contract)`
- Changed the value of the VarNumber variable to `50`

When the parent bot calls the child bot, and the execution returns to the parent bot, the List variable will show the updated values, whereas the String and Number variable values will not change:

- VarList: `Employee data (First name, Last name, Date of birth, Date of joining)`
- VarString: `Employment type (Permanent)`
- VarNumber: `100`

[Credentials and credential variables in the Bot editor](#) on page 2344

Use credentials when building bots to pass sensitive information such as passwords and account numbers. Using credentials separates

	the sensitive information from the bots and Bot Runners, which reduces the risk of data spillage or unauthorized user access.
<a href="#">Predefined variables</a> on page 2328	Predefined (or system) variables return the specific values about the machine on which the bot is executed. Users cannot edit the values of a predefined variable.
<a href="#">Your variables (user-defined)</a> on page 2331	Users and some actions create user-defined variables to temporarily hold values. Use this kind of variable to input values into an action (window title, login credential, or file path) or to accept the output of an action (values read from a file or a Boolean return). <a href="#">Create a variable</a> on page 2336
<a href="#">Global values</a> on page 2350	Global values enable users to reuse identical values between bots instead of creating new variables for each bot.
<a href="#">Work Item variables</a>	You can use the Work Item variables to pass the Work Item attributes or values to the Task Bot from the Control Room when you run the bot with the option <b>Run bot with queue</b> .

## Predefined variables

Predefined (or system) variables return the specific values about the machine on which the bot is executed. Users cannot edit the values of a predefined variable.

Predefined variable types include clipboard, date time, string and system settings and parameters.

---

**Note:** System variables are called as predefined variables in Automation 360.

---

## Clipboard

Use the actions in the Clipboard package to perform operations on the clipboard variable. See [Clipboard package](#) on page 2447.

Variable	Description
Clipboard	Returns the contents of the clipboard.

## Date time

Use the actions in the Datetime package to perform operations on the date time variables. [Datetime package](#) on page 2484



Variable	Description
Date	Returns the date including hours, minutes, and seconds.  <b>Note:</b> Hours can be in 24-hour or AM/PM format depending on the machine configuration.
Day	Returns the day in DD format.
Hour	Returns the hours in HH format.
Machine	Returns the device name as a string.
Millisecond	Returns the milliseconds with a value between 0 and 999.
Minute	Returns the minutes in MM format.
Month	Returns the month in MM format.  <b>Note:</b> This is a numeric type variable.
Second	Returns the seconds in SS format.
Year	Returns the year in YYYY format.

## String

Use the following variables to change how a string is displayed.

Variable	Description
Enter	Starts a new line without returning to the beginning of the line based on the operating system of the device. For example, the variable always adds a new line in Linux CentOS. In Microsoft Windows, the variable adds a page break in the Microsoft Word application and a new line in the Notepad application.
Newline	Starts a new line and moves the cursor to the beginning of the next line regardless of the application and operating system of the device.
Separator	Demarcates a separation between values with a <sep> value.
Tab	Creates large space.

## System settings and parameters

Use the following variables to return data from the computer that is connected to the running Bot Agent:

Variable	Description
AAControlRoom	Returns the URL of the Control Room.

Variable	Description
AAInstallationPath	Returns the Bot Agent installation path. For example, <code>C:\Program Files\Automation Anywhere\Bot Agent</code> .
AATaskExecutor	<p>Returns details on the Run-as user that is used to run a bot. If the bot is deployed on an attended Bot Runner, this variable returns information about the logged-in user. If the bot is deployed by a trigger, this variable returns information about the user associated with that Bot Runner license.</p> <p>This variable is a dictionary with the following keys:</p> <ul style="list-style-type: none"> <li>• <code>Executor_UserName</code></li> <li>• <code>Executor_FirstName</code></li> <li>• <code>Executor_LastName</code></li> <li>• <code>Executor_Email</code></li> <li>• <code>Execution_type</code>: Returns the type of execution <ul style="list-style-type: none"> <li>• When you schedule a bot to run, the <code>Execution_Type</code> key in the <code>AATaskExecutor</code> variable returns information about the execution type with the schedule type (frequency) such as <code>Run as schedule &lt;Daily, Weekly, or Monthly&gt;</code>.</li> <li>• When you use a trigger in a bot, the <code>Execution_Type</code> key can be accessed through the trigger data. The <code>Execution_Type</code> key returns the <code>Run through Trigger</code> as a string for triggers. The <code>Execution_type</code> can be used in all the triggers.</li> </ul> </li> </ul>
AATaskInvoker	<p>Returns details on the user that deployed the bot either by running or scheduling the bot. If the bot is deployed to an attended Bot Runner, this variable returns information about the logged-in user. If the bot is deployed by a trigger, this variable returns information about the user who set the trigger.</p> <p>This variable is a dictionary with the following keys:</p> <ul style="list-style-type: none"> <li>• <code>Invoker_Email</code></li> <li>• <code>Invoker_FirstName</code></li> <li>• <code>Invoker_UserName</code></li> <li>• <code>Invoker_LastName</code></li> </ul>
AATaskName	Returns the path and name of the currently running Task Bot. For example, <code>/Bots/Finance/combineSheets.atmx</code> .
CPUUsage	<p>Returns the percentage utilization of the CPU.</p> <p>Use this variable in a <b>Wait for condition</b> action to make the bot wait until machine CPU usage decreases to a specific amount. See <a href="#">Wait package</a> on page 3155.</p>
Machine	Returns the name of the computer.

Variable	Description
RAMUsage	Returns the RAM usage in megabytes. Use this variable in a <b>Wait for condition</b> action to make the bot wait until machine RAM usage decreases to a specific amount. See <a href="#">Wait package</a> on page 3155.
OSName	Returns the operating system. For example, Windows 10 64-bit.
TotalRAM	Returns the total amount of RAM available.

- Version 11.3 contained Email, File, and PDF system variables, which could hold a limited number of properties values. In Automation 360, an infinite amount of Email, File, and PDF properties values are stored in User-defined Dictionary variables. For more information, see [Using dictionary variable for email properties](#) on page 2547 and [Using a dictionary variable for PDF properties](#) on page 2888.
- Version 11.3 contained Excel system variables to return the cell, column, or row location. In Automation 360, the Excel Advanced package contains the following actions to return location values: [Get cell address](#), [Get column](#), and [Get row](#).
- Version 11.3 contained the Counter system variable to return the loop iteration count. In Automation 360, the user must create and configure a number variable.

## Your variables (user-defined)

Users and some actions create user-defined variables to temporarily hold values. Use this kind of variable to input values into an action (window title, login credential, or file path) or to accept the output of an action (values read from a file or a Boolean return).

When you are building automated tasks, some actions need to refer to and use some values, and these values can be stored in variables. Variables can help you in several ways, from retrieving online data to transferring data between applications, such as Microsoft Excel. A variable can hold one or more values. The values that a variable can contain and the operations that can be performed on the variable are determined by its data type.

### Note:

- A bot can return only a maximum of 3 MB to an output variable. In addition, the table structure in BotOutputVariable is limited to 300,000 cells.

If you insert more than 300,000 cells, an error message is displayed indicating that the debug variable is too big to debug or that BotOutputVariable is too big to process.

Workaround: Store the bot output on the device, such as in a .txt file. If the output must be shared across multiple Bot Runners, store the output in a shared drive.

- The size of bot input variables is limited to 1900000 bytes. We recommend you use .txt file to store large data set.

## Variable types

The data type of a variable is an attribute that determines the kind of data that the value stored in the variable can have. Data types include storage classifications, such as integers, strings, and characters. Variables such as dictionary, record, list, or table can hold multiple data types.

Most variable types have a package with a similar name, which contains actions used to perform operations on the values stored in the variable. For example, use the actions in the String package to work on String variables. Similarly, to work on Number variables, use the actions in the Number package. To convert the value of one variable type to another, see [Type conversion](#) on page 2339

You can also reuse identical values between bots instead of creating new variables for each bot. See [Global values](#) on page 2350.

## Variable naming

A variable name can contain a maximum of 50 Unicode characters, including numbers (0-9), Latin letters (A-Z, a-z), and special characters (- and \_). You can use double-byte characters, such as Chinese, Japanese, or Korean characters, in a variable name. [Unicode range supported in variables](#) on page 2341

We recommend using camel case for variable names and prefixing the variable name to indicate the scope and data type. For example, `iFileEmailAttachment` for a file type variable that is used to provide an input.

---

**Note:** The following is a recommended naming standard for variables `<type/scope indicator><data type><Variable name>`. While there are many naming convention options, some standards must be adopted and used consistently within the organization.

The `<type/scope indicator>` is a single character as follows:

- `p` = local variable (neither input nor output)
- `i` = input variable
- `o` = output variable
- `io` = input and output variable
- `c` = constant

---

Following are a few more examples for naming variables.

- `iStrAuditLogPath`: a string type variable received from a calling task
- `oNumReturnValue` : a number type variable returned to a calling task
- `ioStrStatus`: a string that is both received from and returned to a calling task
- `cStrNull`: a string that holds no value; for example, useful for string comparisons to check whether a value is present

For more information about scope, see [Task Bot package](#) on page 3109. This standard enables you to search for variables by type. For example, `oStr` returns variables that are used to hold output string values.

## Variable types

Variable type and suggested name	Description	Use examples
Any Any	Stores Boolean, Data table, Datetime, File, Number, Record, String, or Window data types. Use this variable type when you are uncertain of which data type an action will output.	<a href="#">Example of using the Run action on page 3238</a>
Boolean Bool	Stores either a True or False value.	
Credential Cred	Stores string values securely, preventing values from being displayed in a message box or written to a file. The value is either selected from the Credential Vault or is user-provided.  <a href="#">Credentials and credential variables in the Bot editor on page 2344</a>	
DateTime Date	Stores a value containing a single date and time value.	You can format the values by selecting a predefined format or specifying a custom format.  <a href="#">Datetime formats on page 2489</a>
Dictionary Dict	Stores data in the form of key-value pairs. The value can be boolean, number, or string.  <a href="#">Dictionary package on page 2493</a>	<ul style="list-style-type: none"> <li>• <a href="#">Using dictionary variable for email properties on page 2547</a></li> <li>• <a href="#">Using a dictionary variable for PDF properties on page 2888</a></li> </ul>
File File	Stores a file path.  <a href="#">Example of using a file variable on page 3280</a>	
Form Form	Stores the value that was input into an interactive form field.  <a href="#">Using interactive forms on page 3292</a>	

Variable type and suggested name	Description	Use examples
List List	Stores a sequence of boolean, number, or string values. <a href="#">List package</a> on page 2774	
Number Num	Stores numeric values, including integers and decimals. It holds values from -9,223,372,036,854,775,808 to 9,223,372,036,854,775,807, and up to 15 decimal digits.  You can assign a randomly generated value to this variable. <a href="#">Random number action</a>	You can remove the digits following a decimal when converting the value into a string.  <a href="#">Number to string action</a>
Record Rec	Stores a single row of values extracted from a table. The values can be boolean, datetime, number, or string.  <a href="#">Record variable</a> on page 2340	<a href="#">Example of entering data into a web form from a spreadsheet</a> on page 3204
Session Sess	Stores the session name from the Excel basic, Excel advanced, or Terminal Emulator packages. Pass this variable from a parent to a child bot in the <b>Task bot &gt; Run</b> action to enable the child bot to process the data in the file opened in the parent bot.  <hr/> <b>Note:</b> When initializing this variable in the child bot, select <b>Use as input</b> . <hr/>	<a href="#">Example for sharing an Excel session between bots</a> on page 3114
String Str	Stores alphanumeric and special characters, and empty values. It can hold up to 65535 UTF-8 characters. A string variable can hold multiple lines of text.	You can compare the value in a String variable to an empty String variable.  <a href="#">Example of using a conditional statement</a> on page 3208
Table Table	Stores multiple values in a table of rows and columns. The values can be boolean, datetime, number, or string.	Assign values to a table variable by extracting values from a <a href="#">CSV/TXT file</a> , <a href="#">Excel file</a> , or a <a href="#">Web form</a> .

Variable type and suggested name	Description	Use examples
Window Win	Stores a window title and URL.  When you create a Window type variable, note that selecting <b>Browser</b> as default value supports only Google Chrome tabs whereas selecting <b>Application</b> as default value supports any application window.	Some actions, such as the Capture action, create a Window variable to store the specified window title and URL.  <a href="#">Example of extracting data from a web table on page 3201</a>

## How window variables behave

When you use the Recorder to automate a specific window, for example `window 1` and perform a **Click** action on the window, and run the bot, the bot for the first time searches that specific window and assigns a window handle to it for identification and saves it in cache. When you perform a second **Click** action on the same `window 1`, the bot verifies if the `window 1` is available. If the `window 1` is available, then the bot no longer must search for the specific window as the window is already stored in cache and automatically fetches it from there. This enhances the performance of the bot and saves time as the bot does not have to search the window at every instance if the window is already available.

Suppose you now perform a third **Click** action on the same `window 1` that opens to another page because of which the window title has now changed. For example, you open a Yahoo India web page and perform a **Click** action on the **News** option on the web page, the action navigates you to another page which changes the title of the window.

Hence in this case when you run the bot, the bot still fetches the same window that is stored in the cache and performs action on it because the window is still the same but only the title has changed. Hence this behaviour provides a good user experience, and you can avoid creating multiple window variables for each window whose title changes while automating web pages.

## Delete variables

You can delete user-created variables in either of the following ways:

- Delete one variable: In the **Variables** palette, click the vertical ellipsis to the right of the variable name and click **Delete variable**.
- Delete unused variables: In the **Variables** palette, click **Delete unused variables**, select which variables to delete, and click **Delete**.

Related tasks

[Create a variable](#) on page 2336

Create a variable to store values.

Related reference

[Boolean package](#) on page 2430

The **Boolean** package contains actions that enable you to do various operations on boolean values.

[Data Table package](#) on page 2452

The Data Table package contains actions that enable you to perform various operations on the values of table variables. Use these actions to join or merge content, search for specific values, insert rows and columns, remove duplicate rows, and write values to a file.

[Datetime package](#) on page 2484

A datetime value consists of a date, time, and time zone. Automation Workspace stores datetime values in a Datetime variable. The **Datetime** package contains actions that enable you to perform various operations on datetime values. You can use these actions to manipulate and compare values in the Datetime variables.

[Dictionary package](#) on page 2493

The **Dictionary** package contains actions that enable you to do various operations on dictionary-type values.

[List package](#) on page 2774

The **List** package contains actions that enable you to perform various operations on a variable of the list data type.

[Number package](#) on page 2802

The Number package contains actions that enable you to perform various operations on a number variable. A number variable holds numeric values, including integers and decimals. It holds values from -9,223,372,036,854,775,808 to 9,223,372,036,854,775,807, and up to 15 decimal digits.

[String package](#) on page 3086

Use the `String` package to perform various operations such as comparing two strings, retrieving the string length, or converting a string to uppercase or lowercase.

[Type conversion](#) on page 2339

You can temporarily convert the values inside a Boolean, Number, or String variable from one type to another type (typecasting) to use within one action. For example, use `$(YourStringVariable).String:toNumber$` to convert the value of a string variable to a number variable to perform mathematical operations.

[Recursive expressions](#) on page 2340

Use a recursive expression to insert a variable in the place of an index or key of a dictionary, list, record, or table variable.

## Create a variable

Create a variable to store values.

When you create a variable that uses characters such as the underscore (`_`) or hyphen (`-`) in your variable name, note that the underscore or hyphen are treated as the same character for the variable names. For example, `global-temp_path` is treated the same as `global-temp-path`. If you create a new variable that uses variables different from these two characters, an error is displayed.

If you have created a global variable as `global-temp-path`, you can refer to this variable in any of the following formats:

- `global-temp-path`
- `Global-Temp-Path`



- global\_temp\_path
- Global\_Temp\_Path

To create and configure a variable, perform the following steps:

1. From the Bot editor, click **Variables** > **Create variable** (+ icon) at the top of the **Variables** menu.

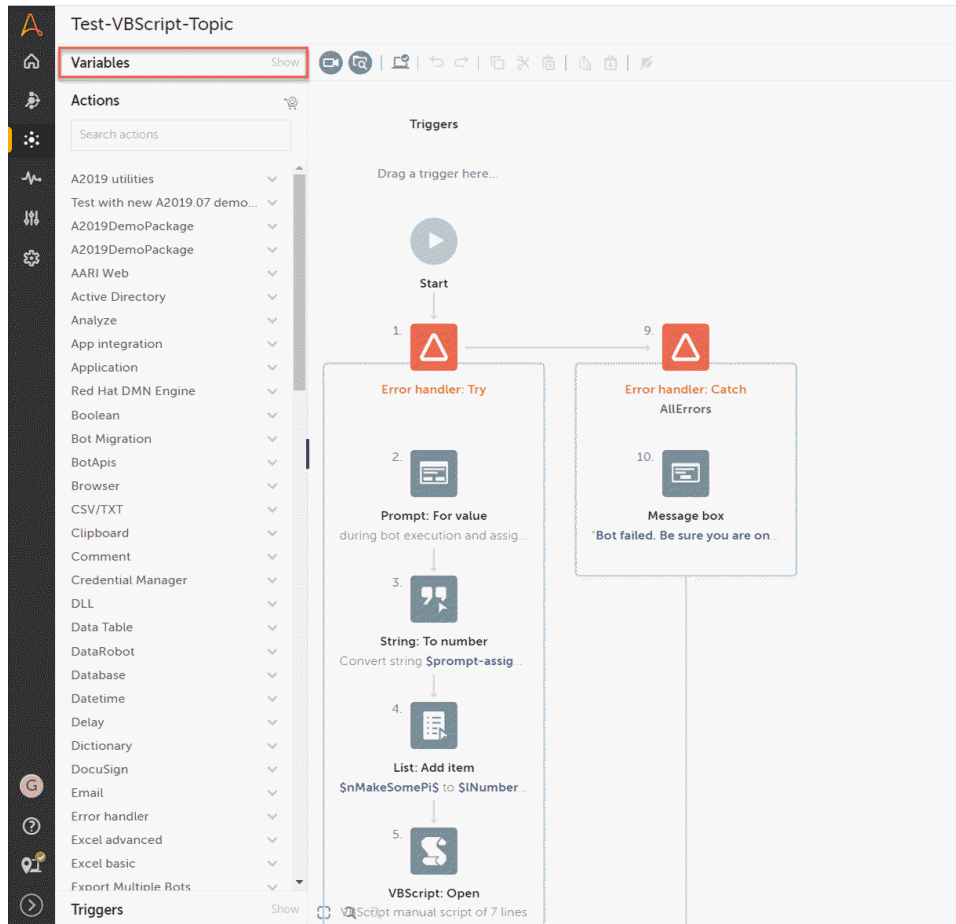

2. In the **Create variable** window, enter a descriptive name for the variable that is prefixed by a lowercase letter to indicate the variable type.

For example, sCe11vAlue to indicate a string data type.

---

#### Note:

- You can use double-byte characters, such as Chinese, Japanese, or Korean characters, in a variable name. [Unicode range supported in variables](#) on page 2341
- Variables cannot be named Java keywords, such as String, Boolean, Integer, Public, and Finally.

3. Optional: Enter a description.

---

**Recommendation:** Provide meaningful variable description when defining input or output variables.

---

4. Optional: Select the **Constant (read-only)** option to ensure values cannot be edited or overwritten.
5. Select from the following options:  
This field pertains to using a bot to run other bots. See [Task Bot package](#) on page 3109.
  - **Use as input:** The variable holds a value that can be passed from the parent bot to a child bot. (Applicable only to a child bot)
  - **Use as output:** The variable holds a value that can be passed from a child bot to the parent bot. (Applicable only to a child bot)
  - **Both:** The value can be passed in both directions.
  - **Neither:** The variable is confined to this bot; it cannot be shared across other bots.

The following example illustrates when to select **Use as input** or **Use as output** in a variable.

Suppose you want to add two numbers. The values are present in the parent bot, and the child bot performs the calculations. For the parent bot to transfer the values to the child bot, the two variables you created must be selected as **Use as input** so that the child bot can receive the values. Now, for the parent bot to receive the calculated value, the variable that stores the result of the calculation in the child bot has to be selected as **Use as output**.

---

**Note:** Ensure that you select the check boxes when you create a variable in the parent bot and the child bot. When you build the bot, and if you edit the selection of check boxes, it might impact your parent bot references, such as your parent bot might not work after this change.

---

6. Select a data type from the drop-down list.  
For more information on data types, see [Variable types](#) on page 2332.
7. Optional: Enter a default value to assign to the variable.  
The values are NULL/empty by default.
8. Click **Create**.  
The variable appears in the Variables pane on the left side of the Bot editor.  
If you want to edit a variable, you can change its name and value but not its data type.
9. To insert a variable into an action field, perform one of the following actions:
  - Click F2 to open the variables list.
  - Click the **Insert a value** icon, located on the right side of the field.
  - Enter the variable name. As you type, the field generates suggestions of existing variables.

---

**Note:** Add a dollar sign at the start and end of the variable. For example, \$myVariableName\$.

---

You can use the variable option and pass it as a parameter to open a file in packages such as XML, Excel basic, or Excel advanced. To open files with different extensions, use the variable option to assign the folder path, file name, and file extension. First, create a variable for the folder path, \$sFolder\$. Then, for the files in the folder path, create two variables, one for file name \$name\$ and another for file extension \$extension\$. To open a file, combine the variables as a string, such as \$sFolder\$\name\$. \$extension\$. For the extension to work with different file types and different open options, you can add conditional logic.

[Build a Go be Great bot](#) on page 3198: Follow the steps in this procedure for an example of how to create a variable and assign it to an action.

## Type conversion

You can temporarily convert the values inside a Boolean, Number, or String variable from one type to another type (typecasting) to use within one action. For example, use `$(YourStringVariable).String:toNumber$` to convert the value of a string variable to a number variable to perform mathematical operations.

In the text field, enter `$(variable name) .` After you enter the period, the auto-fill suggests possible actions such as `toNumber`.

Variable type	Typecasting options
Boolean	<ul style="list-style-type: none"> <li>• <b>invert</b>: Converts the Boolean value to the opposite value (True to False and False to True).</li> <li>• <b>toNumber</b>: Converts the Boolean value to a numeric value (True to 1 and False to 0).</li> <li>• <b>toString</b>: Converts the Boolean value to a string value.</li> </ul>
Number	<ul style="list-style-type: none"> <li>• <b>decrement</b>: Decreases the number value by one.</li> <li>• <b>increment</b>: Increases the number value by one.</li> <li>• <b>toString</b>: Converts the number value to a string value.</li> </ul> <hr/> <p><b>Note:</b> When you convert a number value to a string value and if the number has a decimal value, the decimal value is removed after conversion. For example, 15.234 will be shown as 15 when you convert it.</p> <hr/>
String	<ul style="list-style-type: none"> <li>• <b>length</b>: Returns the number of characters in the string as a numeric value.</li> <li>• <b>lowercase</b>: Converts the characters in the string to lowercase.</li> <li>• <b>reverse</b>: Reverses the characters in the string.</li> <li>• <b>toBoolean</b>: Converts the string value to a Boolean value.</li> <li>• <b>toNumber</b>: Converts the string value to a number value. The limits of the <b>String to Number</b> action apply here.</li> </ul> <p>See <a href="#">String to number action</a> .</p> <ul style="list-style-type: none"> <li>• <b>trim</b>: Trims blanks and whitespaces from the string.</li> <li>• <b>uppercase</b>: Converts the characters in the string to uppercase.</li> </ul>

**Note:** Type casting is not supported for the following scenarios:

- As a value that is passed between bots.
- As a property value for an object captured with the Universal Recorder.

[Object properties](#) on page 2921

## Recursive expressions

Use a recursive expression to insert a variable in the place of an index or key of a dictionary, list, record, or table variable.

A recursive expression contains a variable nested inside of another variable (the outer variable). The value of the outer variable is conditional based on the value of the nested variable.

For example, the list variable `$listOfPlanets$` has the following values: Mercury, Venus, Earth, Mars, Jupiter, Saturn, Uranus, and Neptune. The Number variable `$indexPosition$` has value of 2. The expression `$listOfPlanets[$indexPosition]$` returns `Earth`.

The following types of expressions are supported. You can create a recursive expression containing up to 10 expressions.

- `$dictionaryVariable($key$)$`
- `$listVariable[$index$]$`
- `$recordVariable[$index$]$`
- `$tableVariable[$rowIndex$][$columnIndexOrName$]$`

---

### Note:

- You cannot use a Table variable within a List variable. For example, the following expression is not supported: `$vListStr[$vTable[0][0]$]`
  - You cannot combine expressions with properties. For example, the following expression is not supported: `$dictionaryVar{$listStrVar[2]$}.String:reverse$`
- 

## Record variable

A record variable holds a row of data extracted from a database, spreadsheet, or table in name-field pairs. The fields can store values of Boolean, datetime, number, or string data type.

## Working with a record variable

Record variables are commonly used in the loop action to store a single row of retrieved data; you can access a single value by specifying the index number or name. The index number is the position of the name-field pair. The name is either configured when the variable is initialized or it can be extracted from the column headers of the source table.

The following is an example table:

CustomerName	City
Dana	Pittsburgh
Sam	Los Angeles
Alex	Boston

In this example, a bot loops through the preceding table and assigns each row to `rCurrentRow`. To retrieve the value from the first column of each row, use either the index number `$rCurrentRow[0]$` or name `$rCurrentRow{CustomerName}$`.

**Note:** To retrieve a date time value from a record variable and use it as a string, concatenate the record variable with a string value in the action field.

## Schema

A schema is like a template for the record fields. It sets the order of the fields and the type of data that can be entered into each field.

If you select the **Set schema** option when creating a new record variable, the following conditions apply at runtime, where the bot retrieves a row of data and stores it to a record variable:

- The retrieved values must match the configured field data types.

For example, the data set [{"name": "Sally"}, {"id": 002}, {"dob": "03/05/1989"}] can be assigned to a record variable with the schema [{"name": String}, {"id": Number}, {"dob": Date}].

- The data set attributes must follow the same order and capitalization.

For example, the data set [{"name": "Henry"}, {"id": 003}, {"dob": "06/13/2001"}] cannot be assigned to a record variable with the schema [{"id": Number}, {"name": String}, {"dob": Date}] or {"Name": String}, [{"ID": Number}, {"DOB": Date}].

- The record variable can accept a superset of the configured fields if the fields are in the same order.

For example, the data set [{"name": "Alex"}, {"id": 004}, {"dob": "12/10/1995"}, {"pet": "yes"}] can be assigned to a record variable with the schema [{"name": String}, {"id": Number}, {"dob": Date}].

- The record variable does not accept a subset of data.

For example, the data set [{"id": 005}, {"dob": "05/21/1975"}] cannot be assigned to a record variable with the schema [{"name": String}, {"id": Number}, {"dob": Date}].

If the bot encounters a row of data that does not meet the record variable schema, the bot fails. This prevents the bot from passing incorrect or invalid data into the next action.

Related reference

[Loop package](#) on page 2784

Use the Loop package to run a sequence of actions repeatedly for a specific number of times or until a specific condition is met.

## Unicode range supported in variables

Review the valid characters that can be used in a variable name.

Language	Characters	Range
Arabic		U+0600 - U+0605, U+0620 - U+0669, U+066E - U+06D3
CJK ideographs	Common	U+4E00 - U+9FEA
	Extension A	U+3400 - U+4DB5
	CJK compatibility ideographs	U+F900 - U+FA6D

Language	Characters	Range
Chinese	Chinese Kanji	See CJK ideographs
Greek	All alphabetical characters (uppercase and lowercase) are supported. For extended characters (ά έ ή ί ι ι̂ ο ύ ü ð ώ €)	U+0370 - U+0374, U+0376 - U+0377, U+037A - U+037D, U+037F - U+0386, U+0388 - U+038A, U+038C, U+038E - U+03A1, U+03A3 - U+03F5, U+03F7 - U+03FF, U+1F00 - U+1F15, U+1F18 - U+1F1D, U+1F20 - U+1F45, U+1F48 - U+1F4D, U+1F50 - U+1F57, U+1F59, U+1F5B, U+1F5D, U+1F5F - U+1F7D, U+1F80 - U+1FB4, U+1FB6 - U+1FBC, U+1FBE, U+1FC2 - U+1FC4, U+1FC6 - U+1FCC, U+1FD0 - U+1FD3, U+1FD6 - U+1FDB, U+1FE0 - U+1FEC, U+1FF2 - U+1FF4, U+1FF6 - U+1FFC
Japanese	Hiragana	U+3041 - U+3096, U+309D, U+309E
	Katakana full-width and half-width characters	U+30A1 - U+30FA, U+30FC
	Kanji	See CJK ideographs
	Double-byte numbers	U+FF10 - U+FF19
Korean	Hangul Syllables	U+AC00 - U+D7A3

Language	Characters	Range
Latin	a-z	U+0061 - U+007A
	A-Z	U+0041 - U+005A
Latin extended (Czech, Danish, Dutch, Finnish, French, German, Hungarian, Italian, Norwegian, Polish, Portuguese, Romanian, Spanish, and Swedish)	Latin-1 supplement	U+00C0 - U+00D6, U+00D8 - U+00F6, U+00F8 - U+00FF
	Latin Extended-A	U+0100 - U+017F
	Latin Extended-B	U+0180 - U+024F
	Latin Extended-C	U+2C60 - U+2C7F
	Currency symbols	U+20AC
Numbers	0-9	U+0030 - U+0039
Russian	Cyrillic	U+0400 - U+0481, U+0483 - U+0487, U+048A - U+04FF
Special characters	Hyphen (-) and underscore (_)	U+002D, U+005F

## Use Work Item variables

You can use the Work Item variables to pass the Work Item attributes or values to the Task Bot from the Control Room when you run the bot with the option **Run bot with queue**.

The Work Item variables are available in a Task Bot only after you attach a work item template to the Task Bot when you define the work item template in the work item structure during queue creation.

[Attach work item template to bot](#) on page 2315

1. On the left pane, click **Automation**.  
A list of available and forms is displayed.
2. Click **Create a bot**.
3. In the **Create a Taskbot** window, enter the required parameters such as **Name**, **Description**, and **Folder** location.
4. Click **Create & edit** to open the Task Bot in edit mode.
5. Attach the bot to a queue category by selecting a **Work item template**.  
[Attach work item template to bot](#) on page 2315
6. Press the function key F2 to open the **Insert a variable** window and add the following Workload variables to an action:
  - a) **workItem** to view the default values or attributes of the Work Item when you run the Task Bot using the **Run bot with queue** option.

The **workItem** is an input variable for debugging a Workload bot to be used for Task Bot deployment options **Run now** and **Schedule a bot**. You can add the values for the **workItem** variable when you create an automation.

On the other hand, when you use the option **Run bot with queue**, the **workItem** variable uses the values passed on by the Control Room.

- b) workItemResult** to set the final outcome of the Work Item when you run the Task Bot using the **Run bot with queue** option.

Use the **String > Assign action** to set the value of **workItemResult** variable. This is an output variable type and you can use the string values as well as other variables to set the value of **workItemResult** variables.

The variables are read-only and therefore cannot be edited or deleted from the Task Bot editor page.

Double click a variable in the **Variables** panel to view the variable parameters:

- Variable name.
- Description of the variable.
- Read only if the Constant check box is selected when the variable was created.
- To be used as input or output parameter in a Task Bot during run time.
- Variable type.
- The default values or attributes that are configured with the Work Item template for a **workItem** variable or the default output values for a **workItemResult** variable.

Related concepts

[Workload management](#) on page 1996

The workload management module enables users to upload Microsoft Excel and CSV files to the Control Room so that it feeds the records from the files into the bot deployments.

Related tasks

[Define Work Item structure](#) on page 2002

Define the Work Item structure for processing in a queue. This enables you to manually upload the Work Items from the system in the absence of ready data in a file.

[Attach work item template to bot](#) on page 2315

Attach a work item template to a bot to use the bot in workload automation.

Related reference

[Workload package](#) on page 3184

The Workload package enables you to insert work items in a queue for workload automation. It also enables data chaining between multiple queues. You can orchestrate multiple bots, and enable optimal device utilization through the queueing mechanism of workload management.

## Credentials and credential variables in the Bot editor

Use credentials when building bots to pass sensitive information such as passwords and account numbers. Using credentials separates the sensitive information from the bots and Bot Runners, which reduces the risk of data spillage or unauthorized user access.

Credential

A credential holds the sensitive information in attributes. An attribute can have a value that is standard for all users or it can accept a user-input value. For example, an `Email` credential



	<p>can hold three attributes: <code>host</code> name (standard value), <code>username</code> (user input), and <code>password</code> (user input).</p> <p>Credentials are predefined in the <b>CREDENTIALS</b> tab and cannot be modified when the user is building or running a bot.</p> <p>By default, all users can create, manage, and use their own credentials. A user is granted access to another user's credentials by receiving access to a locker that holds the credential. If the credential requires a user-input value, it appears in the <b>CREDENTIAL REQUESTS</b> tab.</p> <p>A credential must be assigned to a locker to be used for building and running a bot.</p>
Locker	<p>A locker specifies which users can view, modify, or access the credentials. For example, a human resources (HR) locker can hold <code>Email</code>, <code>Database</code>, and <code>Training website</code> credentials and allow only specific employees of the HR department to use the credentials in their bots.</p>
Credential variable	<p>A credential variable stores a credential value in a user-defined variable. It enables users to securely pass values to a bot and from a bot to another bot. Using a credential variable ensures that the values are not displayed in a message box or written to a file. The value is either selected from the Credential Vault or is provided by the user. You can use it into any action field that accepts a variable.</p> <hr/> <p><b>Note:</b> Values of this data type cannot be converted to another data type.</p> <hr/> <p>You can:</p> <ul style="list-style-type: none"><li>• Pass login credentials to a child bot.</li><li>• Retrieve confidential data, such as account numbers, and pass them to the main bot.</li></ul> <hr/> <p><b>Note:</b> You cannot pass credential values to the main bot when you deploy it from the <b>Run bot now</b> page. The values must be hard-coded in the bot or selected from the Credential Vault.</p> <hr/>

## Working with credentials

- Only fields with a **Credential** tab below the field name accept a credential.

- Action fields display the locker, credential, and attribute name; users can not see attribute values in the Bot editor.
- A credential cannot be appended to other variables or to a string.

## Packages that support Credential Variables

The following list of packages support use of credential variables:

- Active Directory
- Apigee
- Credentials
- Database
- Email
- Email trigger
- Excel advanced
- FTP / SFTP
- Generative AI
- Genesys
- Google G Suite
- Google Calendar
- Google Drive
- Google Document AI
- Google Sheets
- Interactive forms
- Legacy Automation
- Microsoft 365 Calendar
- Microsoft 365 Excel
- Microsoft 365 OneDrive
- Microsoft 365 Outlook
- Microsoft 365 Outlook trigger
- PDF
- PGP
- Recorder
- REST Web Service
- Salesforce
- SAP
- ServiceNow
- SharePoint
- Simulate keystrokes
- SNMP
- SOAP Web Service
- Terminal Emulator
- Workday

Related tasks

[Create credential](#) on page 1864

Create a credential and add the required attributes.

[Edit a credential](#) on page 1865

Modify credential details and add or remove attributes.

## Example of building a bot that uses credentials

Build a bot that securely logs in to an online bank using credentials from Credential Vault, ensuring that the username or password is not stored in the bot or on the device.

- Credentials must be assigned to a locker to be used in a bot.
- You must have **Consumer** permissions to the locker.

If the email notification setting is enabled, you receive an email that confirms the locker name and your permissions to that locker.

In this example, you configure a credential with user-provided values and build a bot to automate logging into an online bank website.

1. Provide the user-input values.
  - a) Navigate to **BOTS > Credentials > CREDENTIAL REQUESTS**.  
The credentials that require a user-provided value have an incomplete icon in the first column.
  - b) Click the credential that holds the bank login credentials.
  - c) Click **Edit**.
  - d) Enter the attribute values for the username and password and click **Save changes**.
2. Open a new bot.
  - a) On the left panel, click **Automation**.  
A list of available bots and forms is displayed.
  - b) Click **Create new > Bot**.
  - c) Enter a bot name and click **Create and edit**.
3. Open the browser to the bank login page.
  - a) Double-click or drag the **Browser > Open** action.
  - b) Enter the URL.  
For example, `www.examplebank.com/login`.  
Use an application page where you want to enter a credential.
  - c) Select your preferred browser.
  - d) Click **Save** and **Run**.  
The bank website opens in a new window. If the website opens in a new tab, drag it into a separate window.
4. Specify the username text box.
  - a) Double-click or drag the **Recorder > Capture** action.
  - b) From the **Object detail** menu, select the window containing the bank website.
  - c) Click **Capture object**.  
The window containing the bank website is activated.

- d) Hover over the username text box and click when a red outline appears.
      - e) In the Object properties table, verify that the Control Type is a textbox.
      - f) From the **Action** menu, select **Set text**.
      - g) Select the **Select a credential** option and click **Pick** to navigate to the credential. The **Pick a credential** window appears.
      - h) Select the **Locker**, **Credential**, and **Attribute** for the bank website username and click **Confirm**.
5. Repeat Step 4 to specify the password text box.
6. Specify the Log on button.
  - a) Double-click or drag the **Recorder > Capture** action.
  - b) From the **Object detail** menu, select the window containing the bank website.
  - c) Click **Capture object**.  
The window containing the bank website is activated.
  - d) Hover over the Log on button and click when a red outline appears.
  - e) In the Object properties table, verify that the Control Type is a button.
  - f) From the **Action** menu, select **Click**.
7. Close the window containing the bank website.
8. Click **Save** and **Run**.

[Example of building a bot that uses credential variables](#) on page 2348

Perform the steps in this task to learn how to pass values securely between bots.

Related reference

[Recorder package](#) on page 2916

Recorder package captures a series of tasks in a process and then automates them. You can automate your business applications (for example, desktop, Web, SAP, and Java applications) using the Recorder to capture actions performed on application objects such as a text box, button, table, radio button, combo box, and list view.

[Credentials and credential variables in the Bot editor](#) on page 2344

Use credentials when building bots to pass sensitive information such as passwords and account numbers. Using credentials separates the sensitive information from the bots and Bot Runners, which reduces the risk of data spillage or unauthorized user access.

## Example of building a bot that uses credential variables

Securely pass values to a bot using credential variables to automate the process of logging in to a bank website.

Complete the steps in the following task to build the child bot that automates logging in to a bank website: [Example of building a bot that uses credentials](#) on page 2347

This task is performed by the user who wants to build and deploy . You must have the necessary rights and permissions to complete this task, and authorization to log in to the as the licensed user.

In this example, you modify the bot to accept credentials passed from a parent bot.

In the bot that you built for [Example of building a bot that uses credentials](#) on page 2347, create two credential variables and insert them into the **Recorder > Capture** actions.

1. Configure the credential variable to hold the username.

Field	Input
Name	username
Use as input	select
Type	Credential
Default value	Insecure string, leave field empty

2. Configure the credential variable to hold the password.

Field	Input
Name	password
Use as input	select
Type	Credential
Default value	Insecure string, leave field empty

3. Modify the first **Recorder > Capture** action.
  - a) Click the action to open it in the action editor.
  - b) In the **Select a credential** field, select the **Variable** tab.
  - c) Click F2 to open the Variables menu and select \$username\$.
  - d) Click **Yes, insert**.
4. Repeat the substeps in step 3 to insert the \$password\$ variable into the second **Recorder > Capture**.
5. Click **Save** and **Close**  
The **Automation** page appears.

Create a parent bot that will run the child bot and pass it the credential values.

6. Open a new bot.
  - a) Click **Create new > Bot**.
  - b) Enter a bot name and click **Create and edit**.
7. Insert a **Task Bot > Run** action to select the bot and provide the login credentials.
  - a) Double-click or drag the **Task Bot > Run** action.
  - b) In the **Task Bot to run** field, select the **Control Room file** tab.
  - c) Click **Browse** and select the bot that you modified in the above steps.
  - d) In the **Input values** options, select both **Set username** and **Set password**.
  - e) For each credential variable, click **Pick** to select the locker, credential, and attribute.
8. Click **Save** and **Run**.

#### Related tasks

[Create a variable](#) on page 2336  
Create a variable to store values.

#### Related reference

[Task Bot package](#) on page 3109

Use the **Run**, **Pause**, and **Stop** actions in the Task Bot package to manage running one or more child bots from a parent bot or with a third-party software using an API.

[Credentials and credential variables in the Bot editor](#) on page 2344

Use credentials when building bots to pass sensitive information such as passwords and account numbers. Using credentials separates the sensitive information from the bots and Bot Runners, which reduces the risk of data spillage or unauthorized user access.

## Global values

Global values enable users to reuse identical values between bots instead of creating new variables for each bot.

A user with the `AAE_admin` role or **View and manage global values** permission can configure a global value using a tenant scope value. This enables other Automation 360 users to either use `tenant scope` or `overwrite to user scope value` in their bots.

## Data types

Data type	Description
DateTime	Stores a value containing a single date and time value.
Number	Stores numeric values, including integers and decimals. It can hold up to 15 decimal digits.
String	Stores alphanumeric and character values.
Boolean	Stores a Boolean value as True or False, default value is False.  <b>Note:</b> The Boolean does not show the associated value or input when the user clicks <b>View details</b> on the <b>Global values</b> page.
User group	Stores the value of a user group either through the entities roles or teams.

## Working with global values

**Note:** The maximum number of public global values that can be created is 150.

Users can perform the following tasks:

- Create a global value as an admin.  
[Create a global value](#) on page 2351
- Update the default value as a non-admin.

[Overwrite the default value](#) on page 2353

- Search and delete a global value.

A user with the **AAE\_Admin** role can delete a global value by hovering over the vertical ellipsis to the right of the value, and clicking the **Delete** icon. When a global value is deleted, any overridden values for that global value are also deleted. To delete or search a specific global value, ensure that you search for the exact name of the value. For example, if the name of the global value in the database is `globalvalue_001`, and if you search for `globalvalue-001`, the global value will not be found.

- Insert global values into bots.

All action fields that accept a user-created variable accept a global value. Insert a global value into an action field by pressing F2 or by clicking the **Insert a value** icon on the left side of the field.

Related reference

[Feature permissions for a role](#) on page 1749

A user with the **Manage roles** permission can create and assign roles to users to provide them with access to features and operations.

## Create a global value

You should have the **AAE\_Admin** role to create a global value, configure the data type, set the default value, and enable the value to be updated by non-admin users

1. Log in as an administrator and navigate to **Manage > Global values**.  
The **All global values** page appears with a table of global values.
2. Click **Create global value**.

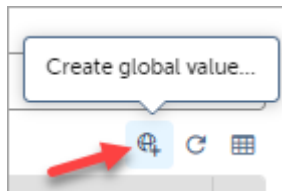

The **Create global values** screen appears.

3. Enter a descriptive name of up to 50 characters.

**Create global value**

Cancel **Create global value** 8

Name  3  
Max characters = 50

Description (optional)  4  
Max characters = 255

Type  5

Value  6

The scope of this global value

7 CANNOT be changed  
The default value will be used for everyone

CAN be changed  
The default value will be used, unless the username running the bot has changed the value

**Note:**

- When the global value is initialized, you cannot change the name.
- Global values cannot be named Java keywords such as String, Boolean, Integer, Public, and Finally.
- The global value name field is case insensitive. For example, if you have already created a global value with the name `globalvalue-001`, then you will not be able to create another global value with the name, `GLOBALVALUE-001`.
- For the **Name** field, the characters `-` and `_` are considered as same characters. For example, if you have already created a global value with the name `globalvalue-001`, then you will not be able to create another global value with the name, `globalvalue_001`. To create a global value with the name `globalvalue_001`, delete the existing global value and create a new value with the desired name.

---

4. Optional: Enter a description of up to 255 characters.

5. Select the data type from the drop-down list.

[Data types](#) on page 2350

- User group: Select from Role or Team tab.
  - Role: Select the role that the users are assigned to.
  - Team: Select the team that the users belong to.

---

**Note:** When configuring the user group type value, teams must already be created to populate in the menu for selection.

---

- Basic data types (String, Number, DateTime, Boolean): Enter the default value.

---

**Note:** When the value is initialized, you cannot change the type.

---

6. Specify whether users can overwrite the value:

- **CANNOT be changed:** The default value remains constant across all users and bots.
- **CAN be changed:** Users can overwrite the default value to use in their bots.

---

**Note:** When you create a global value, if you set its scope to **CANNOT be changed**, you cannot edit the scope to **CAN be changed** later. If you want the scope of the global value to be **CAN be changed**, delete the value and recreate it with the scope set to **CAN be changed**.

---

7. Click **Create global value**.



## Overwrite the default value

Global values can be configured to allow non-admin users to overwrite the default value. When building bots, use a global value for values that remain constant across all bots instead of creating a new variable for every bot.

As a non-admin user, you can only overwrite the default value in global values with a changeable scope. You can identify which global values have a changeable scope by checking the value in the **Scope changeable** column in the **All global values** table.

To verify if a global value has a changeable scope and to overwrite the default value, do the following steps:

1. Navigate to **Manage > Global values**.  
The **Global values** table appears. Each row shows the data type, value name, whether the scope is changeable, and the last modified date and time.
2. Find the global value that has a changeable scope.
3. Move your mouse over the vertical ellipsis and click **Edit global value**.  
The **Edit global value** page appears with the **User value** field enabled.
4. Enter the value that will overwrite the default value.

---

**Note:** This value will overwrite the default value of this global value in all of your bots.

---

5. Click **Save changes**.

## Debug tool

The Debug tool helps you identify and troubleshoot any issues during bot running process. It improves developer productivity and helps narrow down the automation issues.

You can change or edit variable values in debug mode to run the automation successfully.

User role: Citizen developers and Professional developers

## Debugging your automations

You can use the **Debug** tool in the Bot editor to debug your automations.

### Using the Debug tool

From the **Automation** page, select and edit the bot that you want to debug. You can access the **Debug** tool from the **Assistant** utility or from the Bot editor.

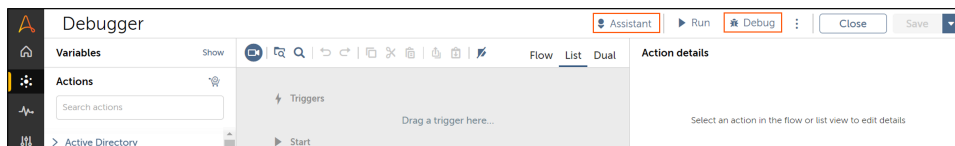

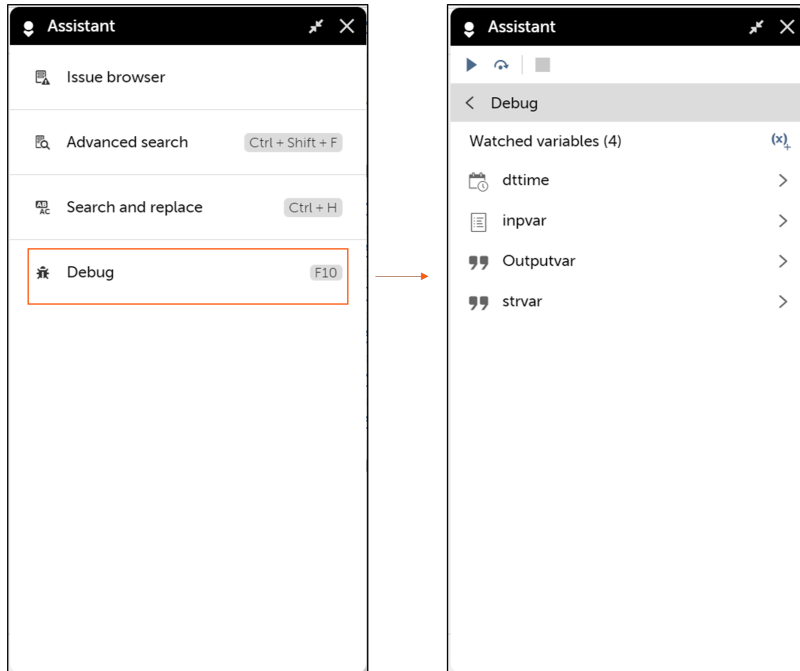

When you invoke the **Debug** tool from the Bot editor:

- You can add, update, or delete actions and variables within a bot. You can continue to edit the bot as long as the debugging process has not yet started.
- A header bar appears below the bot name that displays the name of the bot being debugged. The header bar displays **Now debugging** and the bot name afterward. For example: **Now debugging: MSGBot5**
- The **Actions** panel on the left side of the Bot editor automatically collapses. This helps in providing more horizontal area to view the actions added in the Bot editor while debugging. Once the debugging stops, the **Actions** panel expands again.

---

#### Note:

- Invoking a debugger does not start debugging.
- Before you start debugging, ensure that you fix validation any errors in your bots.
- You can debug the bot in **Flow** and **List** views. However, for better visibility of your actions, we recommend that you debug your bot in the **List** view.





---

When you open the **Assistant** utility from the Bot editor, API editor, or the Template editor, and move it to a specific position, the editor will retain the last position of the **Assistant** utility even after you exit the editor. The default position of the **Assistant** utility will correspond to the last position you moved it to, before exiting the editor:

- even if a user session times out or if the browser is closed abruptly.
- even if you open the editor from a different browser or log in to a different session using the same user credentials.



This improves the usability of the **Assistant** as you no longer have to move the **Assistant** to the right of the editor to view the Actions panel each time you open the bot within the editor.

## Debug controls

Actions	Icons	Keyboard shortcuts	Description
<b>Start debugging</b>		--	Use <b>Start debugging</b> to start the debugging process.
<b>Step to next action</b>		F6	Use <b>Step to next action</b> to debug one action at a time. After you have debugged the current action, you can use <b>Step to next action</b> to move to the next action in the sequence.
<b>Continue to next breakpoint</b>		F5	Use <b>Continue to next breakpoint</b> to move to the next breakpoint directly. <b>Continue to next breakpoint</b> executes the current action and then moves to the next breakpoint and pauses.  <b>Note:</b> When debugging is in progress, the <b>Start debugging</b> icon changes to <b>Continue to next breakpoint</b> .
<b>Stop</b>		F7	Use <b>Stop</b> to stop the debugging process.

## Adding breakpoints

Breakpoints allow you to pause the debugging process during a bot run. To pause and troubleshoot a specific action, you can insert a breakpoint at that specific action. When you enable the breakpoint, the specific action that is being debugged is highlighted with a pause sign against it. After you add the breakpoint to pause the debug tool, you can **Continue to next breakpoint**, **Step to next action**, or **Stop** the debugging process.

Actions	Icons and keyboard shortcuts	Description
<b>Enable breakpoint</b>	 F9	<p>To insert a breakpoint, click the vertical ellipses on the specific code line and select <b>Enable breakpoint</b>.</p> <p>Alternatively, you can also enable a breakpoint by clicking on the specific line number. This displays a breakpoint icon on top of the line number.</p> <hr/> <p><b>Note:</b> When you enable a breakpoint for a specific line of code, the <b>Debug</b> tool highlights it and denotes it with a pause button at the right side of the code line.</p> <hr/>
<b>Disable breakpoint</b>	 F9	<p>To disable a breakpoint, click the vertical ellipses on the specific code line and select <b>Disable breakpoint</b>. The breakpoint becomes inactive. Additionally, you can also click the breakpoint icon on top of the specific line number to disable it.</p>
<b>Clear all breakpoints</b>	 Shift + F9	<p>To clear all breakpoints, click the <b>Clear all breakpoints</b> icon.</p>

## Watched variables

You can use **Watched variables** to watch the values of the specific variable during bot execution. By default, the **Watched variables** list is empty. With a single click, you can add used variables in a bot. These variables are displayed in a pop-up where you can select or deselect, one or more variables, from the list.

## Adding watched variables

You can add variables used in a bot to the **Watched variables** list using either of these methods:

- Select the **Click here to add used variables** link in the **Assistant** utility pane to add all of the used variables in a bot with one click.

- Click the x (  ) icon next to **Watched variables** to add or remove variables manually.

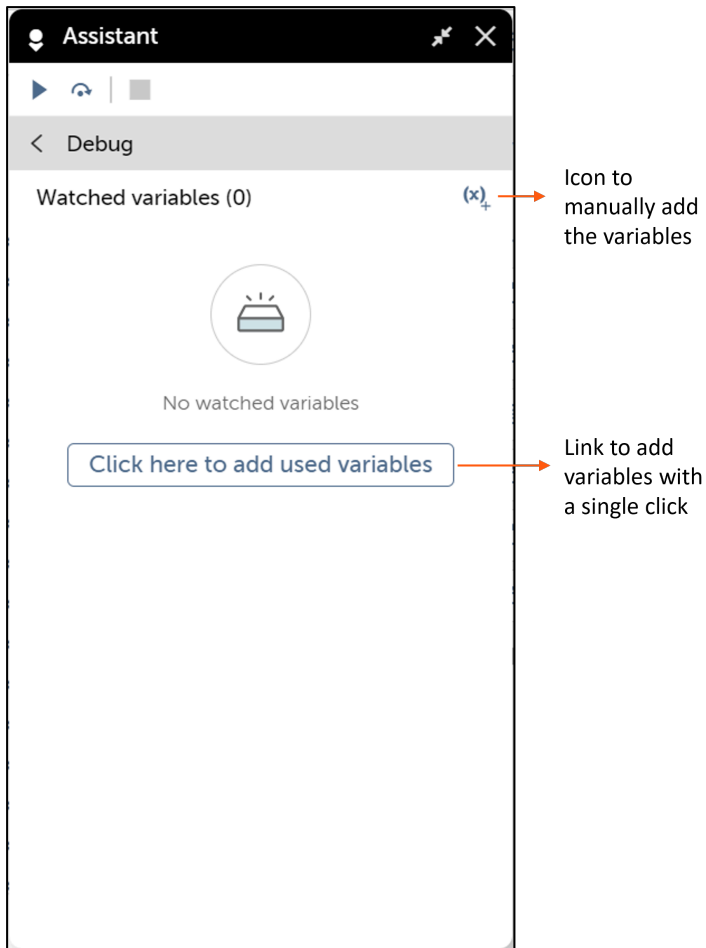

When a bot updates the variables, the values of those variables are updated dynamically in the **Watched variables** list. This provides a current status of a bot run at each action, and helps fix any bot-related errors early on from the **Debug** tool.

**Note:** If you rename a variable that is in the **Watched variables** list, then you must re-add it for it to display in the **Watched Variables** list.

## Editing watched variables

To edit the variables added to the **Watched variables** list:

1. In the **Watched variables** list, click the variable that you want to edit.  
A view with the specific variable details opens in the same tab.
2. Click the edit icon next to the variable name.
3. Change the value of the variable and click **Update**.

**Note:**

- To edit the watched variables, ensure that you install Bot Agent version 21.250 (which was released with Automation 360 v.29) on your system.
- You cannot edit the values of the constant variables.
- You can edit a variable value only when paused at a breakpoint in debug mode.
- The variable value that you update in debug mode is effective only during the debug session. It does not change the original variable value. Once the variable value is updated, the next set of actions that refers to the variable will use the new value.

---

Instead of navigating to the **Variable** panel, the **Watched variables** detailed view provides a quick reference of the variable properties such as type, input, output, and constant.

Currently, you can edit the values of the following variable types:

- Number
- String
- Boolean
- Datetime

You can navigate to the next and the previous variables from the edit window by clicking the next and previous arrows, respectively.

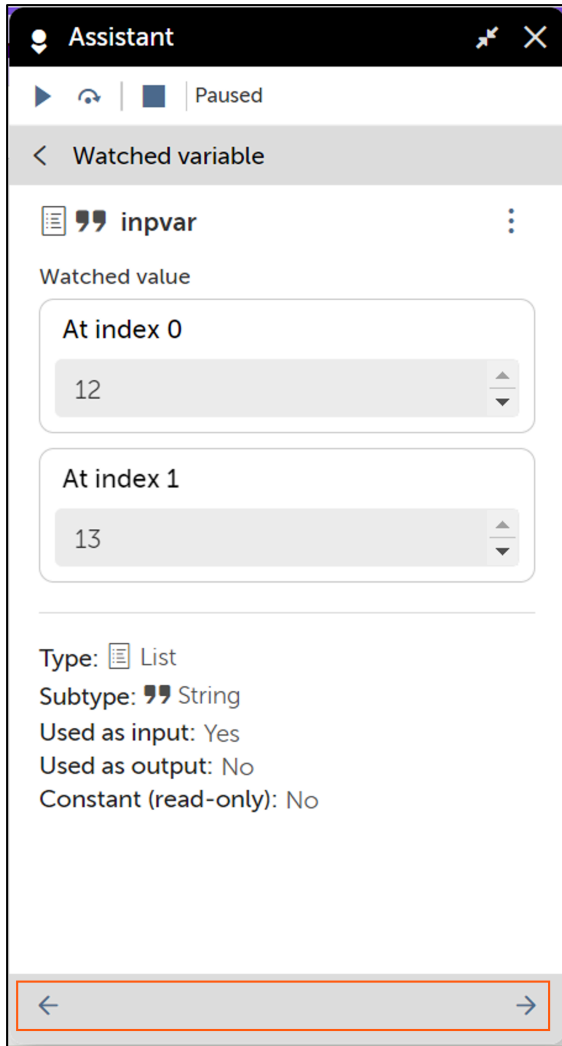
**Note:**

- You can watch variable values only when you start the debugging process.
- You cannot debug child bots from their parent bot.

## Bot dependencies

Bots dependencies are files and other bots that are required to run that bot successfully.

Related tasks

[Upload bot and its dependencies](#) on page 2360

You can upload Enterprise 11 or Enterprise 10 bots, their dependent bots, and other files that are required to run a bot successfully in the Automation 360 Control Room.

[View bots dependencies](#) on page 2361

You can view the files and bots that are added to a bot as its dependencies.

Related reference

[Bot dependencies](#) on page 2359

Bots dependencies are files and other bots that are required to run that bot successfully.

## Upload bot and its dependencies

You can upload Enterprise 11 or Enterprise 10 bots, their dependent bots, and other files that are required to run a bot successfully in the Automation 360 Control Room.

1. On the left pane, click **Automation**.  
A list of available and forms is displayed.
2. In the **PRIVATE** tab, expand the **Bots** folder and select the folder in which you want to upload the dependent files.
3. Click the **Upload files** icon.
4. On the **Upload files** page, click **Add files**.
5. From the **Open** dialog box, select the files you want to upload and click **Open**.
6. Click **Upload**.

Related tasks

[Add bot dependencies](#) on page 2360

You must add the files that are required to run a bot as its dependencies.

[View bots dependencies](#) on page 2361

You can view the files and bots that are added to a bot as its dependencies.

## Add bot dependencies

You must add the files that are required to run a bot as its dependencies.

Ensure that the files you want to add as dependencies are uploaded in the Control Room, except for bots.

The system identifies the automatic dependencies for a bot and adds the required files and other bots as its dependencies. However, for manual dependencies, you must identify the files and bots that are required and add them as dependencies for a bot.

1. On the left pane, click **Automation**.  
A list of available and forms is displayed.
2. In the **PRIVATE** tab, expand the **Bots** folder that contains the bot for which you want to add dependencies.
3. Select the bot for which you want to add dependencies.
4. Select the **Edit Task Bot** icon from the actions menu (vertical ellipsis) on the right.
5. Select **Dependencies** from the actions menu (vertical ellipsis) on the top-right.
6. Expand the **Bots** folder and select the folder that contains the files you want to add as dependencies.
7. Select the files you want to add as dependencies from the Available files section and click the right arrow.
8. Click **Save**.
9. Click **Return to editor** if you want to update the bot or click **Close** to close the bot.

Related tasks

[View bots dependencies](#) on page 2361



You can view the files and bots that are added to a bot as its dependencies.

[Upload bot and its dependencies](#) on page 2360

You can upload Enterprise 11 or Enterprise 10 bots, their dependent bots, and other files that are required to run a bot successfully in the Automation 360 Control Room.

## View bots dependencies

You can view the files and bots that are added to a bot as its dependencies.

1. In the **PRIVATE** or **PUBLIC** tab, expand the folder that contains the bot for which you want to view dependencies.
2. Select the bot for which you want to view dependencies.
3. Select the **View Task Bot** icon from the actions menu (vertical ellipsis) on the right.
4. Select **Dependencies** from the actions menu (vertical ellipsis) on the top-right.  
The system shows a list of files and bots that are added as dependencies for the bot.

Related tasks

[Add bot dependencies](#) on page 2360

You must add the files that are required to run a bot as its dependencies.

[Upload bot and its dependencies](#) on page 2360

You can upload Enterprise 11 or Enterprise 10 bots, their dependent bots, and other files that are required to run a bot successfully in the Automation 360 Control Room.

## Edit bot-dependent text-based files

As a Bot Creator, you can open, view, edit, and save bot-dependent text-based files directly inside the workbench. Automation 360 supports more than 40 text-based file formats, such as TXT, XML, JSON, and Javascript.

- You must have a Bot Creator license.
- You must be assigned a custom role, with the **View content** and **Check out** permissions assigned at the folder level.

If you have the **Check in** permission, you can check in the edited files to the public workspace.

1. Log in to the Control Room as Bot Creator.
2. In the **Private** page, expand the **Bots** folder and select the folder that contains the bot-dependent text-based files that are added as dependencies.

---

**Note:** You can edit only the text-based dependent files.

---

3. Select the file that you want to edit.
4. From the actions menu (vertical ellipses) on the right, click **Edit file** to open the file in the text editor.  
The file opens up with all the formatting effects.  
  
For example, XML files open up with the same formatting as that in code editor, providing you with a similar experience.
5. Make changes to the file and click **Save**.  
The changes made to the file are saved.

6. Click **Close**.

## Check out non-bot file dependencies

Check out the specific versions of the non-bot file dependencies from the public workspace to the private workspace to create an editable copy of the file.

Ensure you have completed all the prerequisites for checking out non-bot file dependencies: [Prerequisites for checking out bot and dependencies](#).

1. Log in to the Control Room as a Bot Creator or a Citizen Developer user.
2. On the left pane, click **Automation**.  
A list of available bots, forms, and non-bot files are displayed.
3. You can choose to check out either one file or multiple files simultaneously.
  - Select the file dependency that you want to check out, click the actions menu (vertical ellipsis), and click **Check out file**.
  - Select the file dependencies that you want to check out and click **Check out checked items**.

Option	Steps
Check out file	Select this option to check out the latest version of the dependent file.
Advanced options	<p>Select this option to select a specific version of the dependent file to check out.</p> <ol style="list-style-type: none"> <li>a) Click <b>Advanced options</b>.</li> <li>b) Select the version of the dependent file to check out.</li> <li>c) Add or remove further dependencies if any.</li> <li>d) Select the version of these dependencies.</li> <li>e) Review the dependencies (<b>Overwritten, Missing, Cloned, Skipped</b>.)</li> <li>f) Click <b>Check out</b>.</li> </ol>

The file appears in the same folder structure in the private workspace.

4. To cancel the checked-out dependent file, click the **Cancel check out for file** option.

You can use this option from either the public or the private workspace.

In the public workspace, the file status changes to **Public**, and the file is available for check out by another user with the appropriate permissions. In the private workspace, the file status changes to **New** if any changes were made to the file. If there are no changes, the file is replaced with a clone.

## View version history of non-bot file dependencies

You can now view the version history of your non-bot file dependencies such as TXT, XML, JSON, XLS, VBS, CSV, Javascript files, to identify relevant changes performed by other users to your files on a specific date and time along with the check-in messages.

You must have check-in and check-out permissions.

You can view the version history of the non-bot file dependencies available in the public workspace (only if there are checked-out files). However, there is no version history available for new and cloned files.

1. Log in to the Control Room.
2. On the left pane, click **Automation**.  
A list of bots, forms, and dependencies are displayed.
3. Select the dependency file for which you want to view the version history. Hover over the actions menu (vertical ellipsis) on the right and click **View history file**.  
A message appears listing all the versions of the selected file in a sequence (latest revision on the top and first revision at the bottom). The information includes the version number, check-in message, date and time of check-in, and the username that made the check-in.

## Actions to build bots

Use actions to build an automation workflow and to instruct a bot what to do. The available actions are located in the Actions palette of the Bot editor in the Control Room.

### Actions, packages, and dependencies

Actions are grouped into packages based on the technology they automate. For example, the Excel advanced package contains Excel-related actions, such as **Open workbook**, **Go to cell**, and **Delete cell**, which you can insert in the Bot editor to automate a spreadsheet process.

Each package is updated and enabled individually to support new functionality. New bots are built with the default version. Existing bots are not automatically updated. They run using the same package version that they were built with until the Bot Creator manually updates to the new version.

When the Control Room deploys a bot, the packages used to create the automation are collected and sent to the Bot Agent on the destination device. The Bot Agent caches the packages so that it does not require updates each time the bot runs.

To shorten the runtime the first time a bot runs on a device, preload the packages using the **Preload packages** option in the Bot editor. The system loads the packages to `\ProgramData\AutomationAnywhere\GlobalCache` on the local machine for quick access at runtime.

After an action from a package is used in a bot, that package becomes a dependent file of that bot.

- Learn more about managing packages in [Packages](#) on page 1898.
- Developers can learn more about creating packages in [Package SDK](#) on page 3509.
- Learn more about managing bots and package dependencies in [Bot dependencies](#) on page 2359.

## Packages and exe files

Packages	exe process files
DLL	Automation.CSharpDLLWrapper.exe
Database	Automation.DatabasePlayer.exe

## Working with actions

**Important:** Each action in a package provides minimum compatible Control Room and Bot Agent version information when you create bots. So you can update your bots and reduce runtime errors caused by an incompatible Control Room or Bot Agent version.

You can configure actions in the Bot editor. Double-click the action to view the fields and features that you can configure, and double-click or drag an action to insert it into the automation.

Move the mouse over the vertical ellipsis at the top right of an action icon to access the following features:

Copy action	Duplicate the action.
Cut action	Copy the action and remove it from the bot code.
Paste after action	Paste the copied action below the selected action.
	<b>Note:</b> This option only appears when there is an action in the clipboard.
Delete action	Remove the action from the bot code.
Disable action	At run time, bot ignores the action until you enable it.
Enable breakpoint	Pauses the bot for debugging purposes. <a href="#">Debugging your automations</a> on page 2353
Step over	Use the Step over icon to go to the next action in debug mode. By default, it starts from the first action in debug mode.

You can edit multiple actions at a time, using the toolbar at the top of the Bot editor.

Find in this bot (Search box)	Search for any text or action such as a package name, actions name, string name, or variable name in the Flow, List, or Dual view of the Task Bot. You can search text across multiple pages of the bot and do not require the pages to be loaded manually. This feature is useful for viewing or editing a bot with longer code lines to determine where the searched text, such
-------------------------------	---

as variables, strings, or actions is used and in which line.

- You can search only within the lines of the code in the Bot editor.
- The search is not case-sensitive.

Run from here

Use the Run from here option to execute the bot from a specific line in the Bot editor by skipping all the lines of code before it. This feature helps to execute a particular code block quickly and easily without running the complete bot.

---

**Note:** When you use an action within the conditional packages such as If, Loop, or Error handler in the bot, the **Run from here** option is not available from that action. However, you can use the **Run from here** option from If, Loop, or Error handler actions.

---

Copy items

Copy actions to a clipboard so they can be duplicated within the bot.

Cut items

Copy the actions and remove them from the bot code.

Paste items

Paste one or more actions after the highlighted action. If you have not highlighted an action, the actions are appended to the end of the automation sequence.

---

**Note:** This icon is only enabled when there are actions in the clipboard.

---

Copy to shared clipboard

Copy actions, triggers, and metadata to a clipboard that is shared between bots.

Paste from shared clipboard

Paste actions, triggers, and metadata from another bot.

---

**Note:** This icon is only enabled when there are actions in the shared clipboard.

---

---

**Note:** The **Copy to shared clipboard** and **Paste from shared clipboard** options are enabled only for users with Bot Creator privileges.

The **Copy to shared clipboard** option is not displayed if the bot is in Debug mode and you have selected only one line of code. However, this option appears when you select multiple lines of a code.

---

## Auto-save functionality of events in Bot editor

In the Bot editor, when you use actions to build an automation, when a bot is not manually saved, an auto-save is performed and the bot now automatically saves the changes for specific events.

---

**Note:** The auto-save functionality is currently available only for specific events.

---

Some of the events that support auto-save functionality are as follows:

- Recorder: When you create a bot with certain actions and click **Recorder**, the event is saved, and when the recording is complete, the event is automatically saved.
- Variable manager: When you create or edit a variable to insert it in an action, the changes are saved.

---

**Note:** The auto-save functionality is not supported when you delete a variable or insert it by pressing F2 to open the variable list.

---

- Actions menu (vertical ellipsis): When you select any action from this menu, for example **Packages**, the event is saved automatically. When you make any change to the **Packages** page and return to the Bot editor, the event is saved.
- Find a file: When you click the **Find a file** icon, the bot is saved if it is not manually saved. Also, after you click the **Add** option, the bot is automatically saved.
- Dialog boxes: When a dialog box is opened, it is automatically saved if any changes are made.

---

**Note:** Auto-save is triggered only for top-level dialog boxes and not for nested dialog boxes.

---

- Deleting variables: When you delete unused variables, the event is saved.
- Bot name change: If you edit the name of a bot, the event is saved.

## Resources

Related reference

[Bot editor for creating bots](#) on page 2228

The Bot editor enables users to create and edit bots on any device and from anywhere the user can access a web browser.

## Advanced search option in Bot editor

When you edit or view a bot, you can use the advanced search feature to find the exact line of action and the corresponding details where the search text appears, select the search filter criteria, and navigate through the search results.

Search for any text value or variable name within action details across a bot by using the **Advanced search** feature. You can access **Advanced search** from the Bot editor in one of the following ways:

- Click the **Assistant** icon at the top.
- Click **Search in this bot** > **Open advanced search** icon.
- Use **Ctrl + Shift + F** shortcut keys.

If you enter a search term in the **Search in this bot** field and then click the **Open advanced search** icon, the search term is carried over and displayed on the **Advanced search** page.

The **Advanced search** feature comprises of three components:

## Search

In the **Advanced search** page, you can enter a search text in the search box. You can search for a text value, variable name, or long text that has multiple matches.

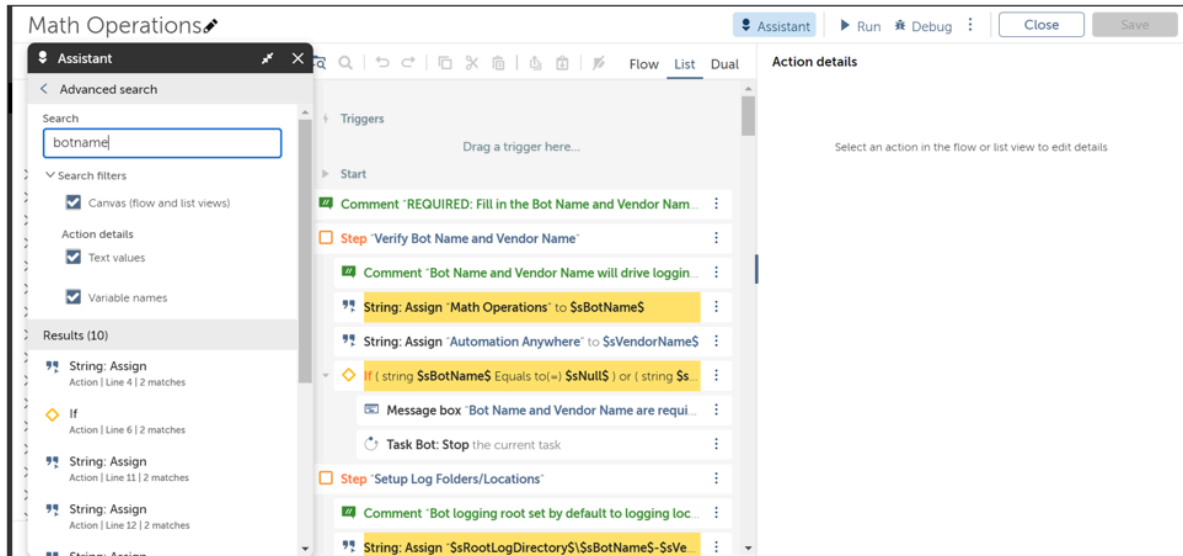

Figure 2: Search

You can also select the search filter criteria and navigate through the search results.

**Note:** **Advanced search** is not case sensitive.

## Search filters

You can use filters to narrow down the search results and quickly locate the search text. The filters can include the following search criteria:

- Canvas (Flow and List views): to search for any text within the canvas that is displayed in the flow and list views.
- Text value: to search for any text value within the action details.
- Variable name: to search for any variable name within the action details.

You can select or clear one or all the filter check boxes depending on the search criteria.

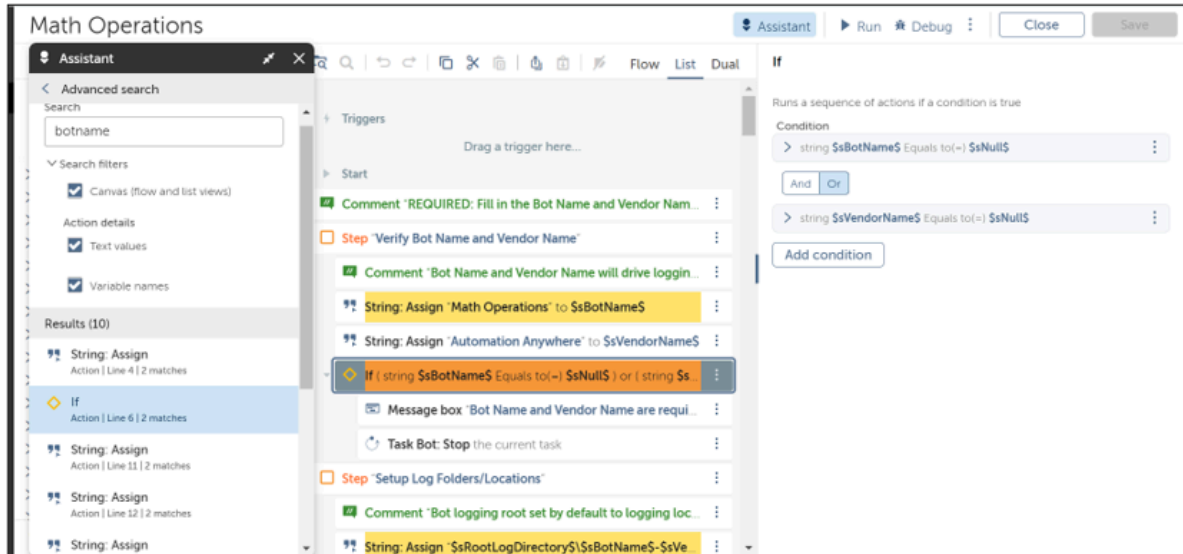

Figure 3: Search filter

When you click a matching item from the action details, for example, if you select the second search result **If | Line 6 | 2 matches** in the **Results** tab, you will see the complete line of action that contains the search text highlighted in the canvas, and the details of the selected action are displayed on the properties panel. You can see that the searched text `botname` is appearing in the if condition, as shown in the properties panel.

## Results

When you enter the search text and select the filter criteria, the **Advanced search** page displays the search results based on action names across the different lines of the bot.

The **Results** header displays the total count of matched action names and the count of selected action or line item in a bot. For each action name listed, the line number containing the action and the total matching results found within the action details are displayed as **Action or Trigger | Line number | Number of matches**.

**Note:** The count displayed in the **Results** header displays only the count of matching line items (or actions) within the bot. However, each line item can have multiple matches and is not counted in the total matching line items. For individual line items, the count of multiple matches is displayed within the particular line item in the **Results** tab.

When you select a specific line item against the action name, the action detail page opens within **Results** tab displaying a list of all matching results within that action.

When there is more than one search result, you can use the **Back** button to go to the previous line and the **Next** button to go to the next item. When you select the **Back** or **Next** button, the action is highlighted in the canvas, and the detail of the corresponding item is displayed in the properties panel.

The following example shows how **Advanced search** works. You are editing a bot with lengthy lines of code. Now you want to search with the text `botname` in the **Assistant** window. The **Results** header shows the total count of 10 matched action names and line numbers with the count of matching line items, such as **If | Line 6 | 2 matches**.



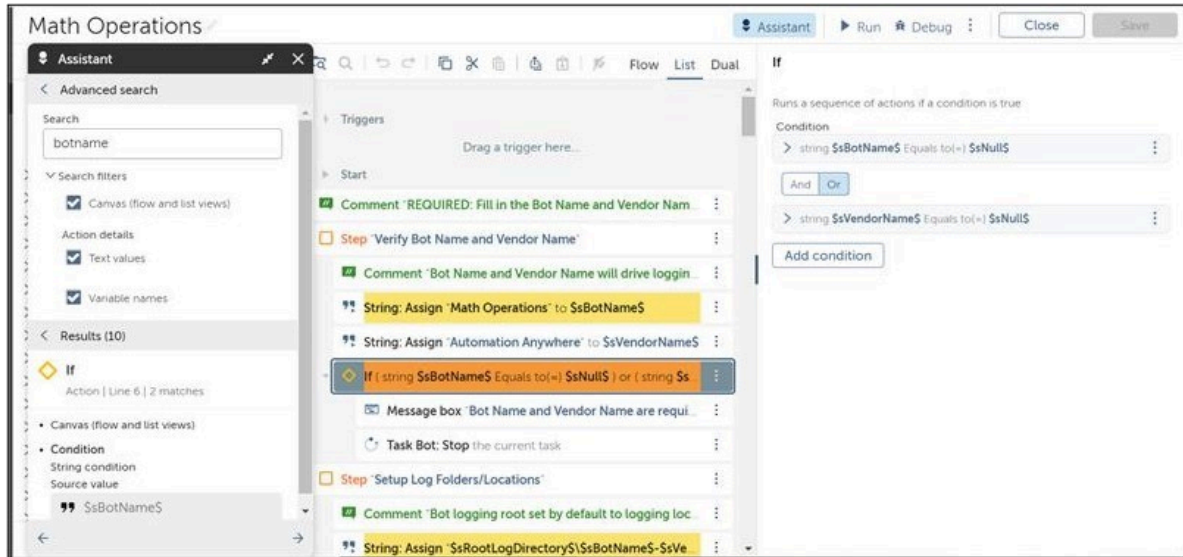

Figure 4: Results

## Search and replace option in Bot editor

The search and replace feature enables you to search for any text or string and variable within an action in the Bot editor, and replace it with text or string and variables of the same type. This feature helps in bulk replacement within the bot.

Use one of the following methods to access **Search and replace**:

- Click **Assistant > Search and replace** option.
- Click the **Search in this bot** icon and click the **Open search and replace** icon.
- Use **Ctrl + H** shortcut key.

The **Search and replace** feature comprises of four components:

### Search type

Click the **Search type** drop-down menu to select one of the following:

- **String**: To search for text or string.
- **Variable name**: To search for a variable.

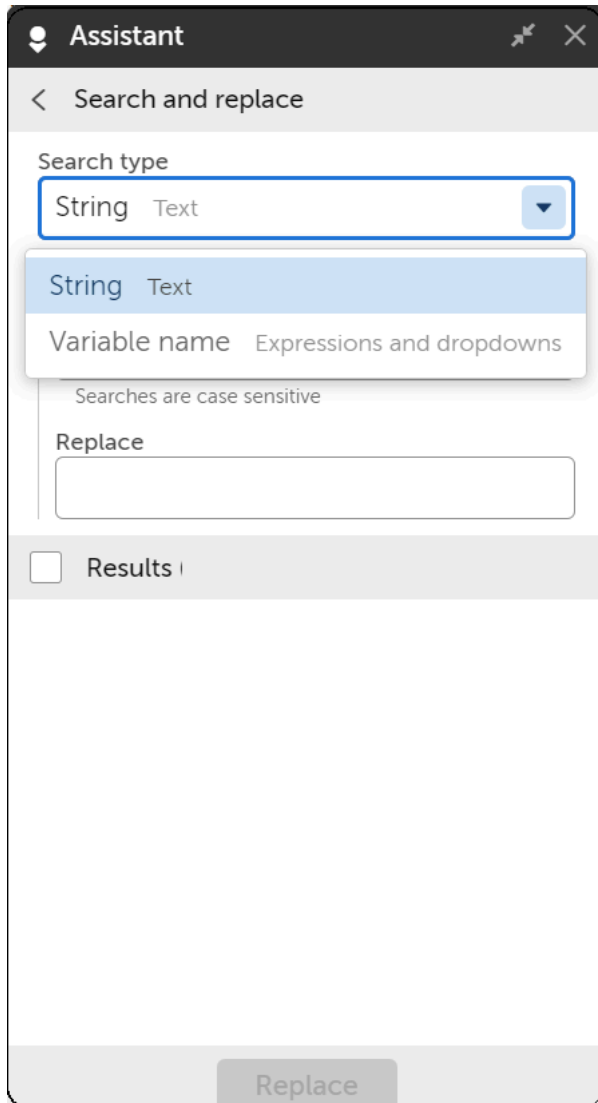

Figure 5: Search type

## Search

In the **Search** field, enter the term or keyword you want to search. You can search for a text value, variable name, or long text that has multiple matches.

## Replace

In the **Replace** field, enter the term or keyword that you want to replace.

- If the **Search type** field is **String**, then enter the text or string in the **Replace** field to replace it.
- If the **Search type** field is **Variable name**, then select the variable from the **Replace** field.

**Note:** If the search type is a variable, then the **Search** and **Replace** drop-down menus will only display the variable names that are used in the bot.

---

Points to remember:

- Ensure that you enter different values or select different variables in **Search** and **Replace** fields.
- **Search** field is case-sensitive.
- When you set the **Search type** to **Variable**, the **Search** is applicable only for the used variables.
- Any search text that you have used in the **Search** field of the **Advanced search** window is retained in the **Search** field of the **Search and replace** tab.

For example, if you have used the keyword 'commands' in the **Search** field and then open the **Advanced search** window, the keyword 'commands' is retained in the **Search** field of the **Advanced search** window.

- You can only use the **Search type** > **String** to search a string value. Although you can search and replace the variable types such as number, boolean or datetime, you cannot search or replace their values.

## Results

The **Results** header displays the total count of matched action names and the count of selected actions or line item in a bot. For each action name listed, the line number containing the action and the total matching results found within the action details are displayed as **Action or Trigger | Line number | Number of matches**.

You can select one, or all line items where the search keyword appears for replacement. When you click the **Replace** button, all the selected line items are replaced. automatically

Consider the following example when you select the **Search type** as **String**. Enter Please enter your commands to loop in the **Search** field and Please do not edit this in the **Replace** field. Select the **Comment** check box for items you want to replace, and click **Replace** button at the bottom.

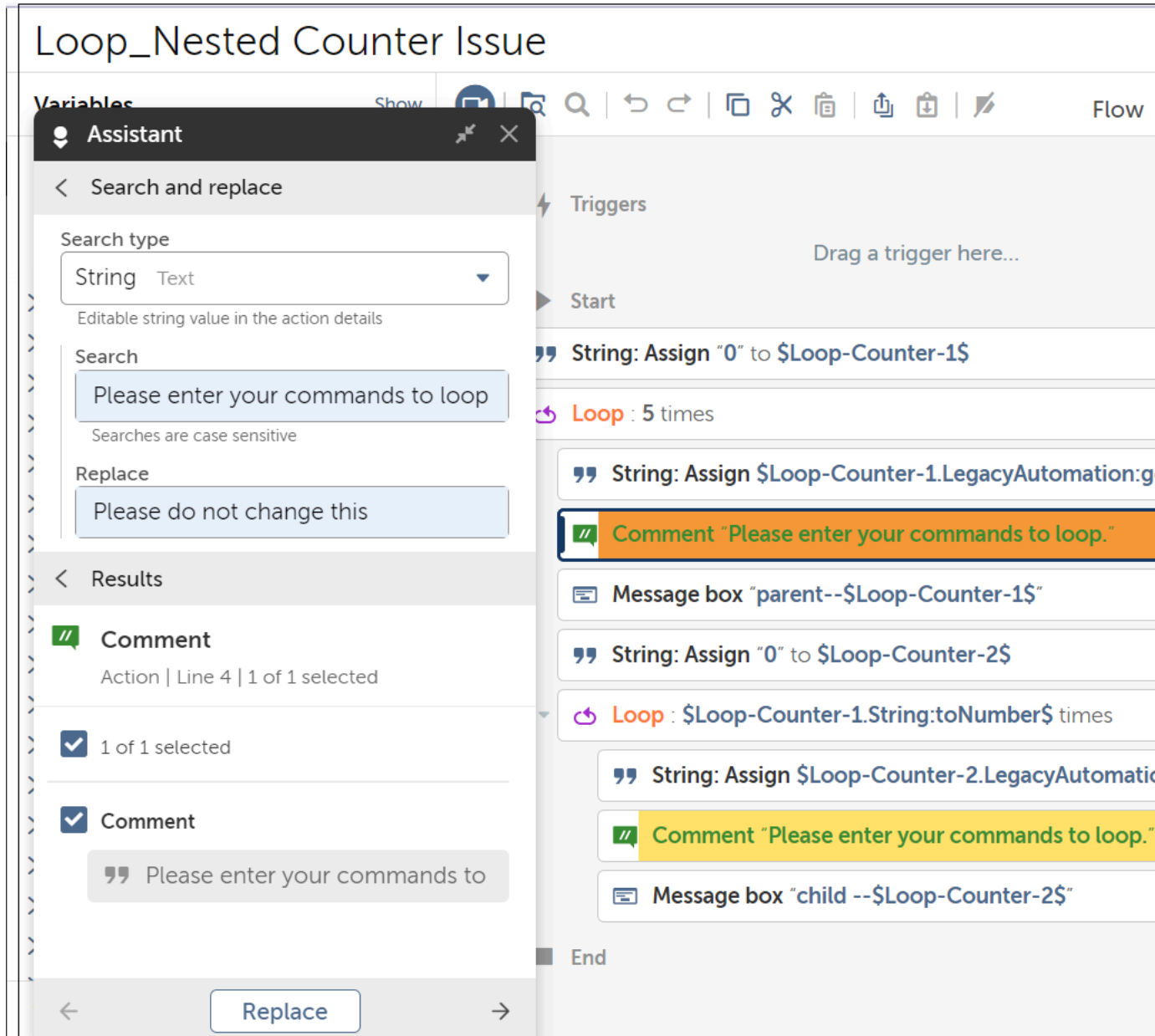

Figure 6: Results for Search type: String

Similarly, here is a sample scenario where you want to search and replace a loop counter variable. You select the **Search type** as **Variable-name**. Use the **Search** drop-down menu to select **Loop-Counter-2**, click **Replace** drop-down menu and select **Loop-Counter**. In the **Results** tab, select the line item where you want to replace the loop counter and click the **Replace** button at the bottom.

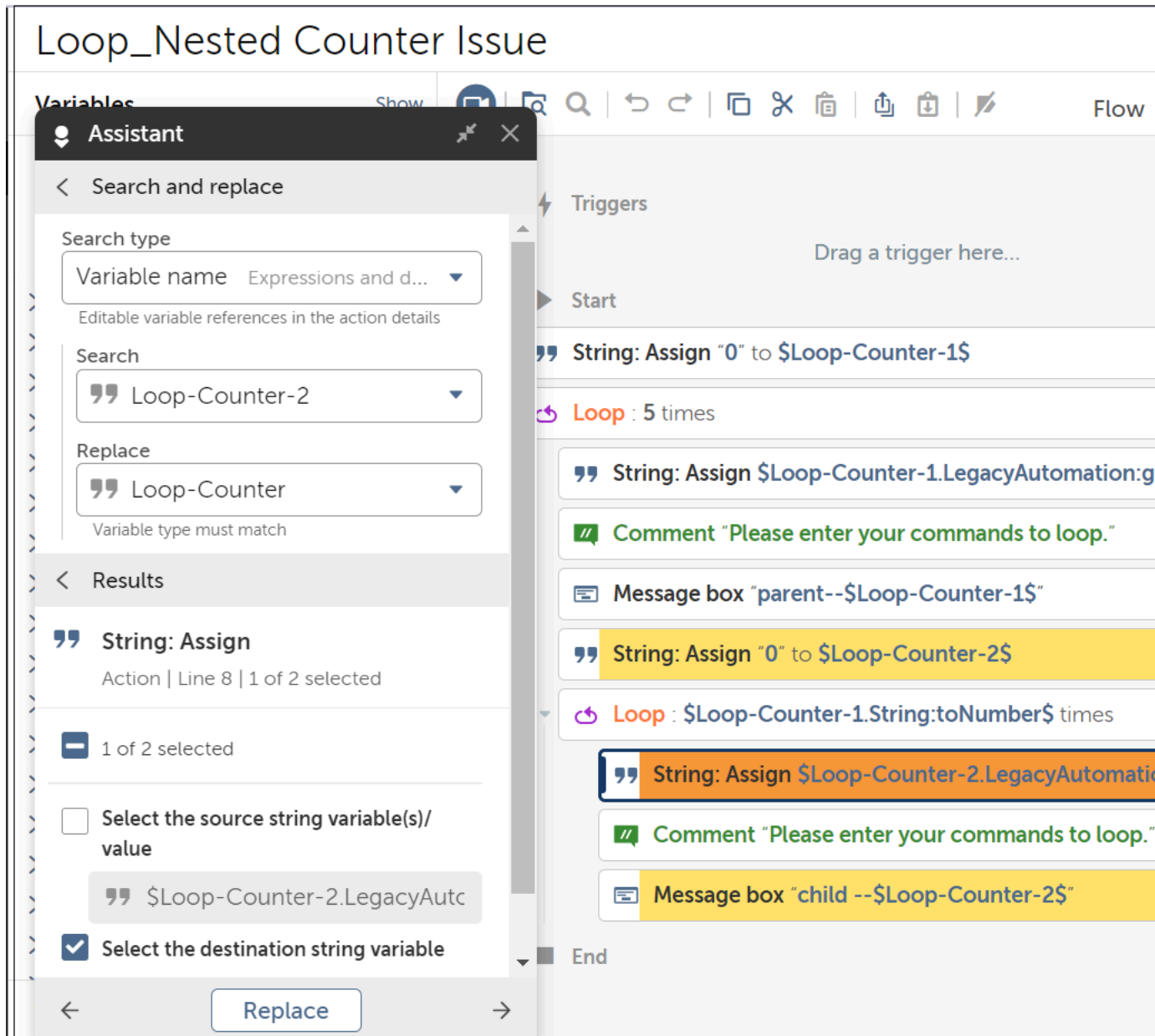

Figure 7: Results for Search type: Variable-name

Points to remember:

- The **Results** tab displays the total count of search terms present in a bot, along with the corresponding line number in the action. However, only the count of matching line items (or actions) within the bot are displayed.

Each line item can have multiple matches and is not counted in the total matching line items. For individual line items, the count of multiple matches is displayed within the particular line item in the **Results** tab.

- The **Replace** button is enabled when you select one of the line items in the **Results** tab.

- Click the line item to get more details from the action. If there are multiple matches for the same line item in the detailed view, they are all displayed and you can select the specific match to replace them.
- The **Next** and **Previous** arrows at the bottom of the dialog allows you to navigate to the next and previous items in the search list.

## Active Directory package

Use the Active Directory package to automate actions in the Active Directory. An Active Directory is a directory service provided by Microsoft to assist the admin in managing users across a group or organization.

Automation Workspace uses Lightweight Directory Access Protocol (LDAP) to read from and edit users in the Active Directory. The server and domain names are combined to create an LDAP path, which is used to connect to the Active Directory.

### Before you start

Before you can use the available actions, in the Active Directory package you must perform the following steps:

1. Establish a connection with the Active Directory using the **Connect** action. Use this same session name for the other actions. For more details, see [Using Connect action for Active Directory](#) on page 2380.
2. Use the actions to automate a task.
3. After you have automated all the Active Directory -related tasks, use the **Disconnect** action to terminate the connection to the server .

### Operations in the Active Directory package

The Active Directory package includes the following operations:

Operation	Description
Computer operations	See <a href="#">Computer operations</a> on page 2376.
Group operations	See <a href="#">Group operations</a> on page 2378.
LDAP operations	See <a href="#">LDAP operations</a> on page 2380.
Organizational unit operations	See <a href="#">Organizational unit operations</a> on page 2382.
User account operations	See <a href="#">User account operations</a> on page 2384.

## Active Directory attributes list

The following table provides examples of the most commonly used Active Directory attributes. For a complete list of attributes, the Active Directory administrator can review the attributes listed in the Active Directory server.

Attribute Name	Example
cn (CommonName)	George.Woods
description	Marketing Manager
distinguishedName	DN attribute is a sequence of distinguished names that contains identifying information for an associated user, group, or object. For example, CN=George.Woods,OU=aae,CN=USERS,DC=domain
displayName	George Woods
givenName	George
objectClass	An object class is a defined grouping of attributes such as users, groups, computers, printers, and domain controllers.
objectCategory	Objects attributes are a set of fields that define the mandatory and optional attributes that an object can have. For example, a user object in Active Directory will have attributes such as first Name, last Name, email address, department, and title.
ou (Organizational Unit)	Marketing
sAMAccountName	SJones@domain.com
userAccountControl	You can use the userAccountControl attribute to configure several account settings in Active Directory. The attribute values apply to flags that control password, lockout, disable or enable, script, and other behavior for the user account. For example, for the flag <code>Disabled Account</code> , the value in decimal is 514.
userPrincipalName	SJones

Related reference

[Active Directory package updates](#) on page 840

Review the updates in released versions of the Active Directory package such as new and enhanced features as well as fixes and limitations. The page also lists the release dates of each version, and the compatible Control Room and Bot Agent versions.

## Computer operations

The computer operations in the Active Directory package contain various actions to automate tasks related to computers, including create, delete, get property, rename, and set property.

### Actions in the Active Directory package

The Active Directory package includes the following actions for computer operations:

Action	Description
Create computer	See <a href="#">Create computer action in Active Directory</a> on page 2376
Delete computer	See <a href="#">Delete computer action in Active Directory</a> on page 2376
Get computer property	See <a href="#">Get computer property action in Active Directory</a> on page 2377
Move computer	See <a href="#">Using the Move computer action</a> on page 2377
Rename computer	See <a href="#">Rename computer action in Active Directory</a> on page 2378
Set computer property	See <a href="#">Set computer property action in Active Directory</a> on page 2378

### Create computer action in Active Directory

The **Create computer** action in the Active Directory package enables you to create a new object for the computer.

#### Settings

- Enter the same session name as the one you used in the **Connect** action.
- Enter a name for the computer.
- Optional: Enter a description of the computer.

### Delete computer action in Active Directory

The **Delete computer** action in the Active Directory package enables you to delete an existing computer.

#### Settings

- Enter the same session name as the one you used in the **Connect** .
- Enter a name for the computer.



## Get computer property action in Active Directory

The **Get computer** action in the Active Directory package enables you to retrieve a specific property value for a computer.

### Settings

- Enter the same session name as the one you used in the **Connect** .
- Enter the computer name.
- Enter the property.
- Assign the value to a string variable.

## Using the Move computer action

Use the Move computer action to move the computer from an existing location to a new location.

Ensure there is an existing computer.

[Computer operations](#) on page 2376

1. In the **Actions** palette, double-click or drag the **Move computer** action from the **Active Directory** package.
2. Add the computer name:
  - Select the name from the server:
    - a) Click **Add computer from server**.
    - b) Enter the host and domain credentials in the **Connect to server** window and click **Connect**.
    - c) In the **Select computer** window, select the computer name from the **Domain Objects** panel and click **Apply**.
  - Enter the name in the **Computer name** field.
3. Add the LDAP path: or perform the following steps if you choose the option :
  - Enter the path in the **Move to** field.
  - Click **Select computer object** and perform these steps:
    - a) Enter the host and domain credentials in the **Connect to server** window and click **Connect**.
    - b) In the **Select computer** window, select the destination server path from the **Domain Objects** panel and click **Apply**.
4. Enter the same session name in the **Active Directory session** that you used in the **Connect** action.
5. Click **Save** and **Apply**.

## Rename computer action in Active Directory

The **Rename computer** action in the Active Directory package enables you to rename an existing computer.

### Settings

- Enter the same session name as the one you used in the **Connect** .
- Enter a name for the computer.
- Enter a new name for the computer.

## Set computer property action in Active Directory

The **Set computer property** action in the Active Directory package enables you to assign a value to a computer property.

### Settings

- Enter the same session name as the one you used in the **Connect** .
- Enter the computer name.
- Enter the property to update.
- Enter the new value.

## Group operations

The group operations in the Active Directory package contain various actions to automate tasks related to groups, including create, delete, get property, and set property.

### Actions in the Active Directory package

The Active Directory package includes the following actions for group operations:

Action	Description
Create group	See <a href="#">Create group action in Active Directory</a> on page 2378
Delete group	See <a href="#">Delete group action in Active Directory</a> on page 2379
Get group property	See <a href="#">Get group property action in Active Directory</a> on page 2379
Rename group	See <a href="#">Rename group action in Active Directory</a> on page 2379
Set group property	See <a href="#">Set group property action in Active Directory</a> on page 2380

### Create group action in Active Directory

The **Create group** action in the Active Directory package enables you to create a new group.

## Settings

- Enter the same session name as the one you used in the **Connect** .
- Enter a unique name for the group.
- Optional: Enter a description for the group.
- Select the group scope from the following options:
  - **Domain Local**
  - **Global**
  - **Universal**

### Group scope

- Select the group type from the following options:
  - **Security**: Provides users with access rights to folders.
  - **Distribution**: Sends emails to a group of users.

## Delete group action in Active Directory

The **Delete group** action in the Active Directory package enables you to delete an existing group.

## Settings

- Enter the same session name as the one you used in the **Connect** .
- Enter the name of the group to delete.

## Get group property action in Active Directory

The **Get group property** action in the Active Directory package enables you to retrieve a specific property value for the group.

## Settings

- Enter the same session name as the one you used in the **Connect** .
- Enter the group name.
- Enter the property.
- Assign the value to a string variable.

## Rename group action in Active Directory

The **Rename group** action in the Active Directory package enables you to rename an existing group.

## Settings

- Enter the same session name as the one you used in the **Connect** .

- Enter the group name.
- Enter a new name for the group.

## Set group property action in Active Directory

The **Set group property** action in the Active Directory package enables you to assign a value to a group property.

### Settings

Assigns a value to a group property.

- Enter the same session name as the one you used in the **Connect** .
- Enter the group name.
- Enter the property to update.
- Enter the new value.

## LDAP operations

The Lightweight Directory Access Protocol (LDAP) operations in the Active Directory package contain various actions to automate tasks related to LDAP, including connect, disconnect, and run query.

### Actions in the Active Directory package

The Active Directory package includes the following actions for LDAP operations:

Action	Description
Connect	See <a href="#">Using Connect action for Active Directory</a> on page 2380
Disconnect	Closes the connection with the LDAP server.
Run query	See <a href="#">Run query action in Active Directory</a> on page 2381

### Using Connect action for Active Directory

Use the **Connect** action to establish a connection with an Active Directory server. This is the first action you must use to automate an Active Directory related task.

This action enables you to provide the server credentials and details, and associate this information with a session name. Use this same session name for the other Active Directory actions so that you have to provide the server information only once.

To establish a connection with an Active Directory server, follow these steps:

1. In the Actions palette, double-click or drag the **Connect** action from the Active Directory package.
2. Enter a session name.
3. Enter or create the LDAP URL:

- **Parent path:** Enter the LDAP URL that identifies the server that hosts the Active Directory services.

For example, LDAP://192.168.2.60/DC=corporate,DC=com

- **Build parent path:** Create the LDAP URL:
  - a) Click the **Build parent path** option to connect to the Active Directory server.
  - b) In the **Connect to server** window, enter the host and domain credentials, and click **Connect**.
  - c) In the **Object Explorer** window, select the specific path from the **Objects** panel.
  - d) Verify the selected LDAP URL path in the **Preview** field and click **Apply**.

4. In the **Login user** field, provide your username with one of the following options:

- **Credential:** Select a credential from the Credential Vault. [Credentials and credential variables in the Bot editor](#) on page 2344
- **Variable:** Select a variable holding a credential data type value. [Your variables \(user-defined\)](#) on page 2331
- **Insecure string:** Enter a value or select a variable.

---

**Important:** Values entered using this option are not encrypted.

---

5. In the **Login password** field, provide your password with one of the following options:

- **Credential:** Select a credential from the Credential Vault. [Credentials and credential variables in the Bot editor](#) on page 2344
- **Variable:** Select a variable holding a credential data type value. [Your variables \(user-defined\)](#) on page 2331
- **Insecure string:** Enter a value or select a variable.

---

**Important:** Values entered using this option are not encrypted.

---

6. Click **Save**.

7. After you have automated all the Active Directory-related tasks, terminate the connection to the server using the **Disconnect** action.

## Run query action in Active Directory

The **Run query** action in the Active Directory package enables you to run a specified Active Directory query. The query results are stored in a list variable, either for object names or LDAP paths, depending on the option selected.

### Settings

- Enter the same session name as the one you used in the **Connect**.
- Input the query. For example: (&(objectCategory=person)(objectClass=user)(name=A\*))
- Specify the return type. Select either the **Object Name** or **LDAP Path** option.
- Assign the value to a string variable.

## Organizational unit operations

The organizational unit operations in the Active Directory package contain various actions to automate tasks related to organizational units, including create, delete, and rename organizational units, and get and set property.

### Actions in the Active Directory package

The Active Directory package includes the following actions for organizational unit operations:

Action	Description
Create organizational unit	See <a href="#">Create organizational unit action in Active Directory</a> on page 2382
Delete organizational unit	See <a href="#">Delete organizational unit action in Active Directory</a> on page 2382
Get organizational unit property	See <a href="#">Get organizational unit property action in Active Directory</a> on page 2383
Move organizational unit	See <a href="#">Using the Move organizational unit action</a> on page 2383
Rename organizational unit	See <a href="#">Rename organizational unit action in Active Directory</a> on page 2384
Set organizational unit property	See <a href="#">Set organizational unit property action in Active Directory</a> on page 2384

### Create organizational unit action in Active Directory

The **Create organizational unit** action in the Active Directory package enables you to create a new object for the organizational unit.

#### Settings

- Enter the same session name as the one you used in the **Connect** .
- Enter a name for the organizational unit.
- Optional: Enter a description of the organizational unit.

### Delete organizational unit action in Active Directory

The **Delete organizational unit** action in the Active Directory package enables you to delete an existing organizational unit.

#### Settings

- Enter the same session name as the one you used in the **Connect** .

- Enter the name of the organizational unit to delete.

## Get organizational unit property action in Active Directory

The **Get organizational unit property** action in the Active Directory package enables you to retrieve a specific property value for an organization and assigns the results to a variable.

### Settings

- Enter the same session name as the one you used in the **Connect** .
- Enter the organizational unit name.
- Enter the property.
- Assign the retrieved value to a string variable.

## Using the Move organizational unit action

Use the Move organizational unit action to move an organizational unit from an existing location to a new location.

Ensure there is an existing organizational unit.

[Organizational unit operations](#) on page 2382

1. In the **Actions** palette, double-click or drag the **Move organizational unit** action from the Active Directory package.
2. Add the organizational unit name:
  - Add the name from the server by performing these steps:
    - a) Click **Add organizational units from server**.
    - b) Enter the host and domain credentials in the **Connect to server** window and click **Connect**.
    - c) In the **Select organizational unit** window, select the organizational unit name from the **Domain Objects** panel and click **Apply**.
  - Enter the name in the **Organizational unit name** field.
3. Add the LDAP path: or perform the following steps if you choose the option **Select organizational unit object**
  - Enter the path in the **Move to** field.
  - **Select organizational unit object** and perform these steps:
    - a) Enter the host and domain credentials in the **Connect to server** window and click **Connect**.
    - b) In the **Select organizational unit** window, select the destination server path from the **Domain Objects** panel and click **Apply**.
4. Enter the same session name in the **Active Directory session** that you used in the **Connect** action.
5. Click **Save** and **Apply**.

## Rename organizational unit action in Active Directory

The **Rename organizational unit** action in the Active Directory package enables you to rename an existing organizational unit.

### Settings

- Enter the same session name as the one you used in the **Connect** .
- Enter the name of the organizational unit to rename.
- Enter the new name.

## Set organizational unit property action in Active Directory

The **Set organizational unit property** action in the Active Directory package enables you to assign a value to an organizational property.

### Settings

- Enter the same session name as the one you used in the **Connect** .
- Enter the organizational unit name.
- Enter the property to update.
- Enter the new value.

## User account operations

The Active Directory package contains various actions to automate tasks related to user account management, including create, delete, get property, remove, rename, and set property.

## Actions in the Active Directory package

The Active Directory package includes the following actions for user account operations:

---

**Note:** We now support Active Directory user operations by logon name with domain and can provide the domain name to extract the user details. When you retrieve user property or perform any user operation based on the logon name (userPrincipalName), and if the user domain name differs from the domain specified in the LDAP path, the user properties are now successfully retrieved regardless of whether it contains a domain name or not.

For example, LDAP Path: LDAP://ADServer/DC=automation, DC=net

User	Logon name
userPrincipalName: kim@aaengg.net	User can provide logon name as kim@aaengg.net.
userPrincipalName: shaun@aasales.net	User can provide logon name as shaun@aasales.net.

---



User	Logon name
userPrincipalName:sarah@automation.net	user can provide a logon name as either sarah or sarah@automation.net.

When you perform any user action on the logon name, and if the logon name has a duplicate user under subDomain and subDomain@rootDomain, the user property is retrieved for the user with the root domain.

For example, LDAP Path: LDAP://ADServer/DC=automation, DC=net

- User 1: userPrincipalName (logon name) is kim@aaengg.net.
- User 2: userPrincipalName (logon name) is kim@aaengg.net@automation.net.

If you enter the logon name as kim@aaengg.net or kim@aaengg.net@automation.net, the operations will be performed on the second user that is kim@aaengg.net@automation.net.

Action	Description
Add users to group	See <a href="#">Using the Add users to group action</a> on page 2385.
Create user	See <a href="#">Using the Create user action</a> on page 2386.
Change user password	See <a href="#">Change user password action in Active Directory</a> on page 2387
Delete user	See <a href="#">Delete user action in Active Directory</a> on page 2387
Disable user account	See <a href="#">Disable user account action in Active Directory</a> on page 2387
Enable user account	See <a href="#">Enable user account action in Active Directory</a> on page 2388
Get all users of a group	See <a href="#">Get all users of a group action in Active Directory</a> on page 2388
Get user property	See <a href="#">Get user property action in Active Directory</a> on page 2388
Remove users from group	See <a href="#">Using the Remove users from group action</a> on page 2388.
Rename user	See <a href="#">Rename user action in Active Directory</a> on page 2389
Set user property	See <a href="#">Set user property action in Active Directory</a> on page 2389
Update account options	See <a href="#">Update account options action in Active Directory</a> on page 2390
Update user details	See <a href="#">Using the Update user details action</a> on page 2390

## Using the Add users to group action

Use the **Add user to group** action to add an existing user to a user-created group.

Ensure there is an existing user and group.

[User account operations](#) on page 2384 | [Group operations](#) on page 2378

1. In the **Actions** palette, double-click or drag the **Add users to group** action from the **Active Directory** package.
2. From the **Select user** field, select one of the following options:
  - **Add user manually:** Enter the **Name** and **Ldap path** of the user in the **Add user** window and click **Add**.
  - **Add users from server:** Add an existing user from the server:
    - a) Enter the host and domain credentials in the **Connect to server** window and click **Connect**.
    - b) In the **Select user** window, select the user from the **Objects** panel and click **Add user**.

The user name and LDAP path of the user is added in the **Select user** table.

3. Add the user to the specified group by choosing one of the following options:
  - **Group name:** Enter the group name to add the existing user to a specific group.
  - **Select user group:** Add an existing user to a group:
    - a) Enter the host and domain credentials in the **Connect to server** window and click **Connect**.
    - b) In the **Select user** window, select the group from the **Objects** panel to add user to the destination group and click **Apply**.
4. Enter the same session name in the **Active Directory session** that you used in the **Connect** action.
5. Click **Save** and **Apply**.

For more information on how to use some of the actions (including Add user to group), see this example topic [Example using user account actions from Active Directory package](#) on page 3274

## Using the Create user action

Use the **Create user** action to configure and activate a new user.

Connect to the Active Directory server.

[Using Connect action for Active Directory](#) on page 2380

1. In the **Actions** palette, double-click or drag the **Create user** action from the **Active Directory** package.
2. In the **Session name** field, enter the session name that you provided in the **Connect** action.
3. Enter a user name.

For example, John Smith.
4. Enter the logon name.

The user will use this value to log in to the account.  
For example, john.smith.
5. Enter the user's first name.
6. Optional: Enter these user details: last name, display name, initials, email address, description, department, and title.

7. Select **Active user** to activate the user.
8. Select the **Password settings** check box to set the password for the user.
9. Enter the password.  
You can select **Credential** to use a value from the Credential Vault, **Variable** to use a credential variable, or **Insecure string** to manually enter a password.
10. Select the option that enables the user to either change or not change their password at the next login.  
If you choose the **Don't require password change at next login** option, you have additional options to select.
  - **User can't change password**
  - **Password doesn't expire**
11. Click **Save**.

## Change user password action in Active Directory

The **Change user password** action in the Active Directory package enables you to change the user password.

### Settings

- Enter the user name. You can select **Credential** to use a value available in the Credential Vault, **Variable** to use a credential variable, or **Insecure string** to manually enter a user name.
- Enter the new password. You can select **Credential** to use a value available in the Credential Vault, **Variable** to use a credential variable, or **Insecure string** to manually enter a password.
- Enter the same session name in the **Active Directory session** that you used in the **Connect** action.

## Delete user action in Active Directory

The **Delete user** action in the Active Directory package enables you to delete an existing user.

### Settings

- Enter the same session name as the one you used in the **Connect** .
- Select whether to search for the user by **User name** or **Logon name**.

---

**Note:** Before removing a user, make certain all unfinished development of bots are checked-in.

---

## Disable user account action in Active Directory

The **Disable user account** action in the Active Directory package enables you to disable a user account.

### Settings

- Enter the same session name as the one you used in the **Connect** .

- Select whether to search for the user by **User name** or **Logon name**.

## Enable user account action in Active Directory

The **Enable user account** action in Active Directory package allows you to enable a user account.

### Settings

- Enter the same session name as the one you used in the **Connect** .
- Select whether to search for the user by **User name** or **Logon name**.

## Get all users of a group action in Active Directory

The **Get all users of a group** action in Active Directory package enables you to retrieve a list of all the users of a group, and assigns the results to a variable.

### Settings

- Enter the same session name as the one you used in the **Connect** .
- Enter the group name.
- Specify the return type. Select either the **Object Name** or **LDAP Path** option.
- Assign the value to a string variable.

## Get user property action in Active Directory

The **Get user property** action in the Active Directory package enables you to retrieve a specific property value for a user and assigns the results to a variable.

### Settings

- Enter the same session name as the one you used in the **Connect** .
- Select whether to search for the user by **User name** or **Logon name**.
- Enter the property.
- Assign value to a string variable.

## Using the Remove users from group action

Use the Remove users from group action to remove a user from a group.

Ensure there is an existing user assigned to a group.

[Using the Add users to group action](#) on page 2385

1. In the **Actions** palette, double-click or drag the **Remove users from group** action from the Active Directory package.
2. From the **Select user** field, select one of the following options:
  - **Add user manually**: Enter the **Name** and **Ldap path** of the user in the **Add user** window and click **Add**.
  - **Add users from server**: Add an existing user from the server:

- a) Enter the host and domain credentials in the **Connect to server** window and click **Connect**.
- b) In the **Select user** window, select the user from the **Objects** panel and click **Add user**.

The user name and LDAP path of the user is added in the **Select user** table.

3. To remove the user from a group, select one of the following options:
  - **Group name:** Enter the group name to remove the existing user from a group.
  - **Select user group:** Remove an existing user from a group.
    - a) Enter the host and domain credentials in the **Connect to server** window and click **Connect**.
    - b) In the **Select user** window, select the group from the **Objects** panel to remove user from the group and click **Apply**.
4. Enter the same session name in the **Active Directory session** as you used in the **Connect** action.
5. Click **Save** and **Apply**

## Rename user action in Active Directory

The **Rename user** action in Active Directory package enables you to rename the user logon name or the user account name.

### Settings

- Enter the same session name as the one you used in the **Connect** .
- Select whether to search for the user by **User name** or **Logon name**.
- Enter the name to search for.
- In the **New name** field, enter the updated name.
- Select from the following options to specify what to update:
  - **Rename user name**
  - **Rename logon name**
  - **Rename user and logon name**

## Set user property action in Active Directory

The **Set user property** action in Active Directory package enables you to assign a value to a user property, view the current details, and update it.

### Settings

- Enter the same session name as the one you used in the **Connect** .
- Select whether to search for the user by **User name** or **Logon name**.
- Enter the property to update.

- Enter the new value.

## Update account options action in Active Directory

The **Update account options** action in Active Directory package enables you to set account attributes for the user.

### Settings

- Specify the user name. You can select **Credential** to use a value from the Credential Vault, **Variable** to use a credential variable, or **Insecure string** to manually enter a user name.
- Select the status of the user as **Active** or **Inactive**.
- Select an option indicating whether the user can change their password at the next login or not.

If you choose the **Don't require password change at next login** option, you have additional options to select.

- **User can't change password**
  - **Password doesn't expire**
- Enter the same session name in the **Active Directory session** that you used in the **Connect** action.

## Using the Update user details action

Use this action to update the details of a user.

Connect to the Active Directory server.

[Using Connect action for Active Directory](#) on page 2380

1. In the **Actions** palette, double-click or drag the **Update user details** action from the **Active Directory** package.
2. In the **Session name** field, enter the session name that you provided in the **Connect** action.
3. Select whether to search for the user by **User name** or **Logon name**.
4. Enter the user's first name.
5. Optional: Enter the following user details: last name, display name, initials, email address, description, department, and title.
6. Click **Save**.

## AI package

Artificial Intelligence (AI) packages bring a new dimension to automation by enabling actions that mimic human intelligence. These packages empower automation to perform tasks such as problem-solving, pattern recognition, and decision-making. AI encompasses various technologies, including machine learning, Generative AI, and robotics, which are revolutionizing industries and enhancing everyday life.

Automation Anywhere's commitment to innovation and the integration of AI into its automation solutions reflects our dedication to providing cutting-edge tools that will empower your

organization to thrive in the modern digital landscape. The following sections allow you to discover how our AI packages can drive efficiency, productivity, and competitiveness in your business processes.

## AWS SageMaker

Amazon SageMaker, an AWS service, offers a seamless ecosystem for developing, training, and deploying machine learning models. This guide serves as your compass, guiding you through the initial steps to harness the full potential of SageMaker within Automation Anywhere.

---

### Note:

The AWS mark and logo are trademarks or registered trademarks of Amazon.com, Inc. and are used for identification purposes only.

---

Amazon SageMaker simplifies the complex process of machine learning model development. From the conceptualization of ideas to the deployment of robust models, SageMaker offers a comprehensive suite of tools and resources. This integration with Automation Anywhere unlocks the synergy of these two powerful platforms, making it easier than ever to leverage the capabilities of machine learning in your automation processes.

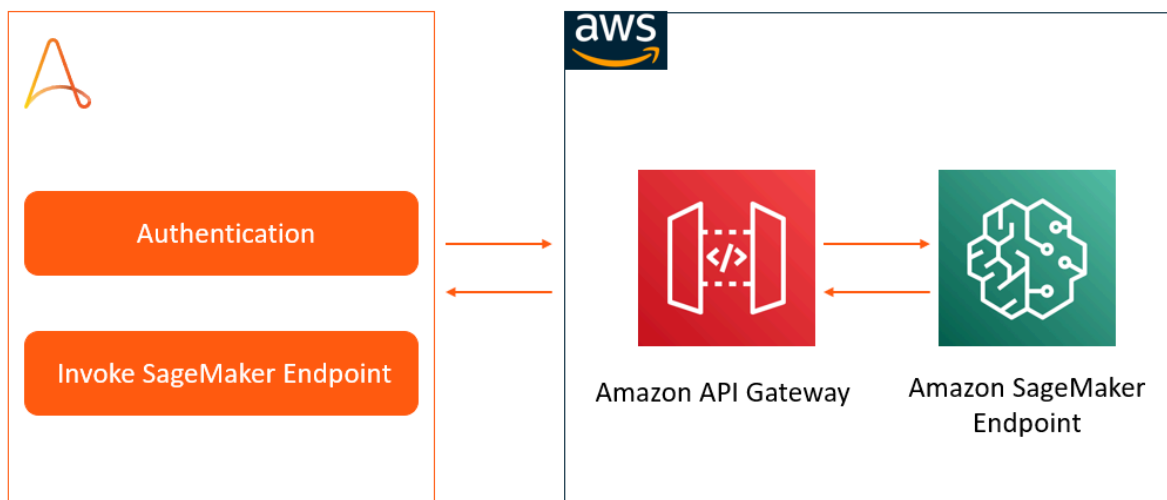

The first step on this journey is the authentication process in AWS, ensuring a secure and reliable connection to Amazon SageMaker. Once authenticated, you gain access to SageMaker endpoints, enabling seamless communication and interaction between Automation Anywhere and SageMaker. This integration facilitates the effortless utilization of SageMaker's advanced machine learning functionalities within the Automation Anywhere platform.

### Authentication action

To authenticate access to AWS SageMaker from the Control Room you need to obtain AWS access key ID and secret access key. You can include a session token which is a temporary token used when working with temporary security credentials.

---

**Note:** The examples and graphics provided on this page are for representation purposes only and may not accurately reflect your specific instance. We do not assume responsibility for their maintenance or accuracy.

---

1. Create a AWS account ([Create a standalone AWS account](#)) or create a member account in your organization ([Creating a member account in your organization](#)).
2. Log in to your AWS account and create a project. If you already have access to a project, you can view it after you login into you AWS account.

This topic describes the steps to acquire the following key components and use them in the Control Room to authenticate to AWS SageMaker:

- **AWS Access Key ID:** The AWS Access Key ID serves as your unique identifier within the AWS ecosystem. It is a fundamental part of the authentication process, allowing AWS services to recognize and validate your access.
- **Secret Access Key:** The Secret Access Key is the confidential counterpart to your Access Key ID. This key is used to sign requests made to AWS, enhancing security by ensuring that only authorized individuals or systems can access your AWS resources.
- **Session Token (Optional):** Additionally, you have the option to include a Session Token. A Session Token is a temporary, time-bound token used when working with temporary security credentials. It provides an added layer of security, particularly in scenarios where temporary access is required, such as when using temporary security credentials.

1. Log in to your AWS Console and select the project.
2. Click **Command line or programmatic access** corresponding to the project you selected.

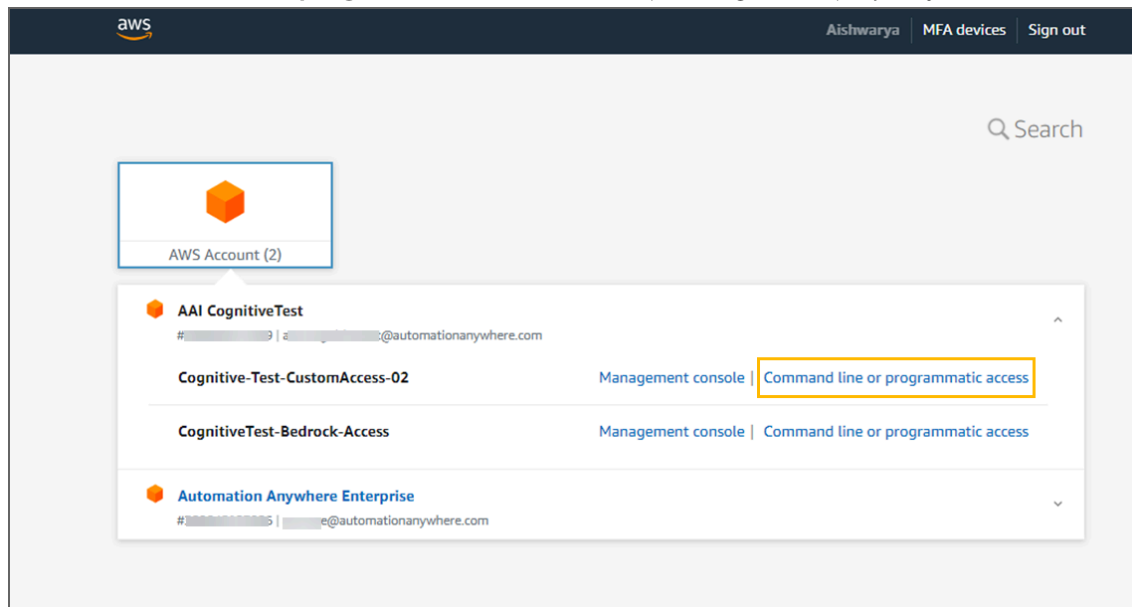



- Click on **Windows** and scroll down the screen to copy the: **AWS Access Key ID**, **AWS Secret Access Key**, and **AWS Session**

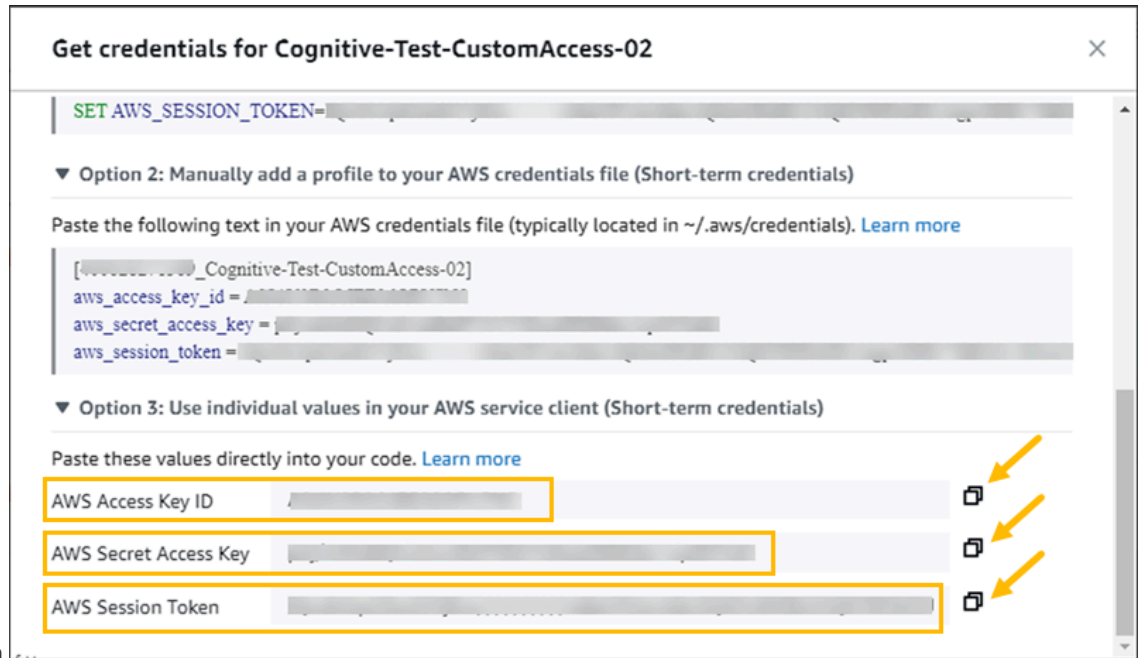

Token.

- Log in to the Control Room.
- Create a new bot. For more details, see [Create your first bot](#) on page 1489.
- From the **Actions** pane, select **AI** > **AWS SageMaker** > **Authentication** and place it under the **Start** of the bot flow.
- Paste all the credentials you copied as follows:

**Note:** You can use one of the following options to specify the **Access Key/Secret Access Key/Session Token (optional)**:

- Credential:** To implement stronger security, you can use values in the Credential Vault that contains information about the AWS access key ID/Secret access key/Session Token (optional).
- Variable:** To implement stronger security, you can use a credential variable that contains information about the AWS access key ID/Secret access key/Session Token (optional).
- Insecure string:** Enables you to enter the AWS access key ID/Secret access key/Session Token (optional).

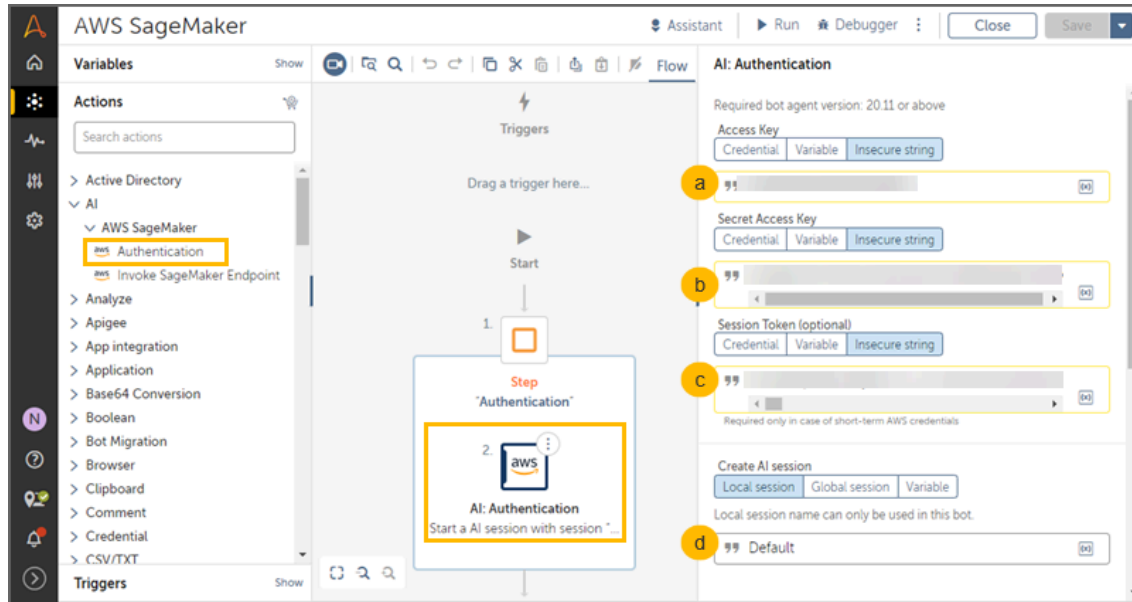

- a) In the **Access Key** field, paste the **Access Key** copied from your AWS Environment.
  - b) In the **Secret Access Key** field, paste the **Secret Access Key** copied from your AWS Environment.
  - c) In the **Session Token (optional)** field, paste the **Session Token (optional)** copied from your AWS Environment.
  - d) Enter **Default** as the Local session name or create a Global session or store the session in a Variable.
8. Click **Run** to ensure you are successfully authenticated.

[Invoke SageMaker Endpoint action](#) on page 2394

## Invoke SageMaker Endpoint action

Invoke SageMaker Endpoint action sends data to an AI model deployed on the SageMaker platform and receives response. The action enables you to integrate machine learning capabilities directly into your Control Room, making predictions or classifications based on the trained model's expertise.

**Note:** The examples and graphics provided on this page are for representation purposes only and may not accurately reflect your specific instance. We do not assume responsibility for their maintenance or accuracy.

## Overview

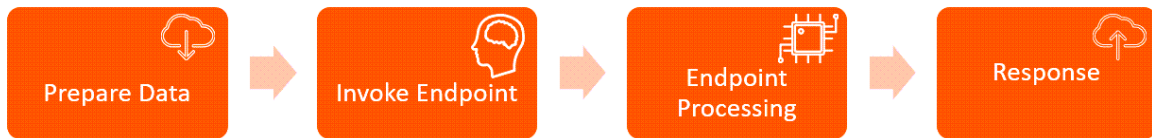

- **Prepare Data:** Before invoking the endpoint, you need to prepare the data you want to send for prediction. This could be an image, a text snippet, numerical values, or any other format that the model expects.
  - **Invoke Endpoint:** To get predictions, you send a POST request to the endpoint URL with the prepared data as input. The request typically includes the data in JSON format.
  - **Endpoint Processing:** The SageMaker endpoint processes the incoming data using the deployed model. It runs the data through the model's algorithms and produces predictions or responses based on the model's training.
  - **Response:** The endpoint sends back the model's predictions or responses in the HTTP response body. Your application can then parse this response and use the results as needed.
- The AI model should be deployed in SageMaker
  - The deployed model is accessible by Invoke SageMaker Endpoint.

**Note:** This task is usually performed by an automation admin with Admin privileges.

1. Log in to your AWS Console and select the project.
2. Click **Management Console** corresponding to the project you selected.

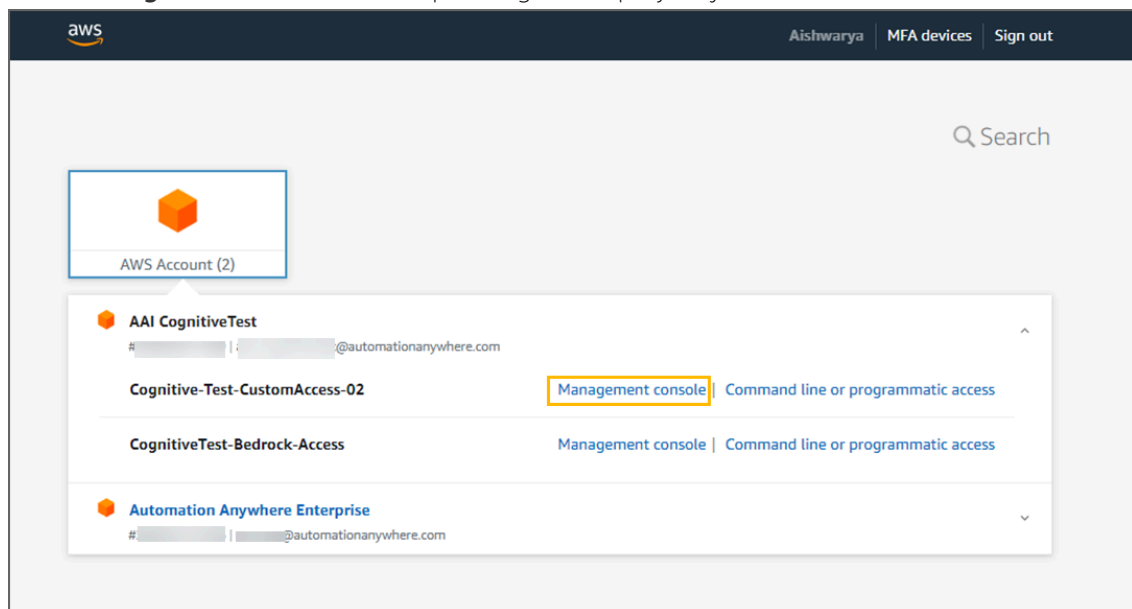

3. Search for SageMaker and select **Amazon**

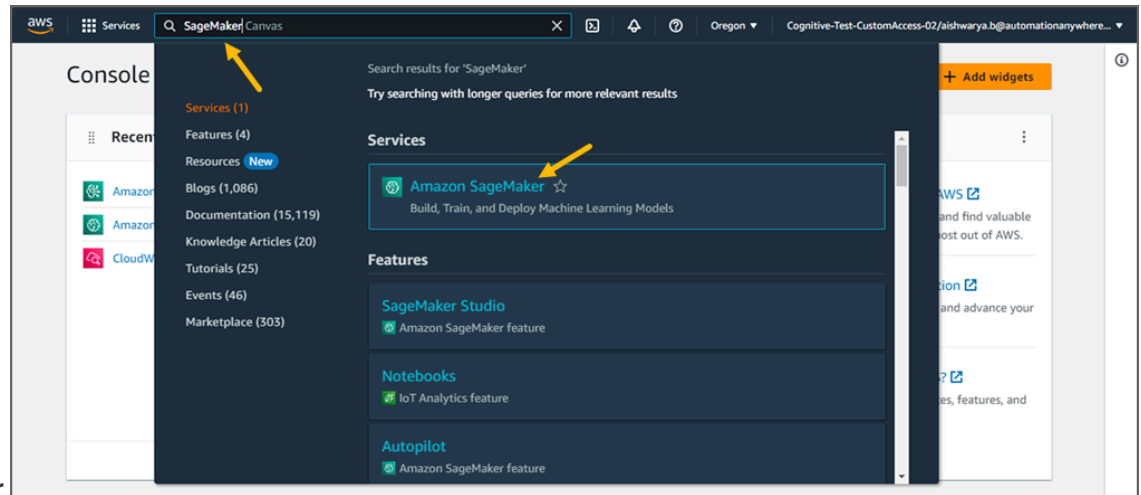

SageMaker

4. Navigate to the **Domains** and click a

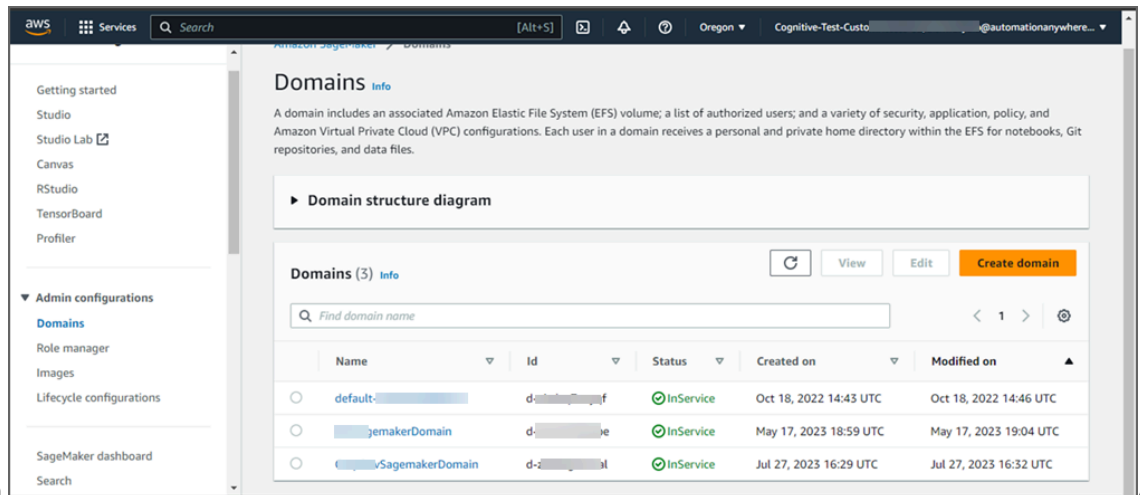

Domain.

Alternat

you can click Studio (on the left navigation) to select the appropriate domain and click **Open Studio**. To add a domain, see [AWS add a custom domain](#). For more information on Domains, see [Amazon SageMaker Domain](#).

5. Navigate to **Inference > Endpoints** to view all the existing models that are already deployed. The following examples describes how to invoke a text and an image-based model that are already deployed on AWS SageMaker.

Invoke a Text based model on SageMaker

This topic describes how to invoke Meta's LLaMA 2 AI model through AWS SageMaker using an example.

The Llama 2 family of large language models (LLMs) is a collection of pre-trained and fine-tuned generative text models ranging in scale from 7 billion to 70 billion parameters. Fine-tuned LLMs, called Llama-2-chat, are optimized for dialogue use cases. You can use Automation Anywhere's

Invoke SageMaker Endpoint action to send a prompt and receive a response from this model. In this example, a prompt is sent to the model, and a response appears in a message box.

1. In the Control Room, click **Discovery endpoints to configure** to get the list of endpoints.

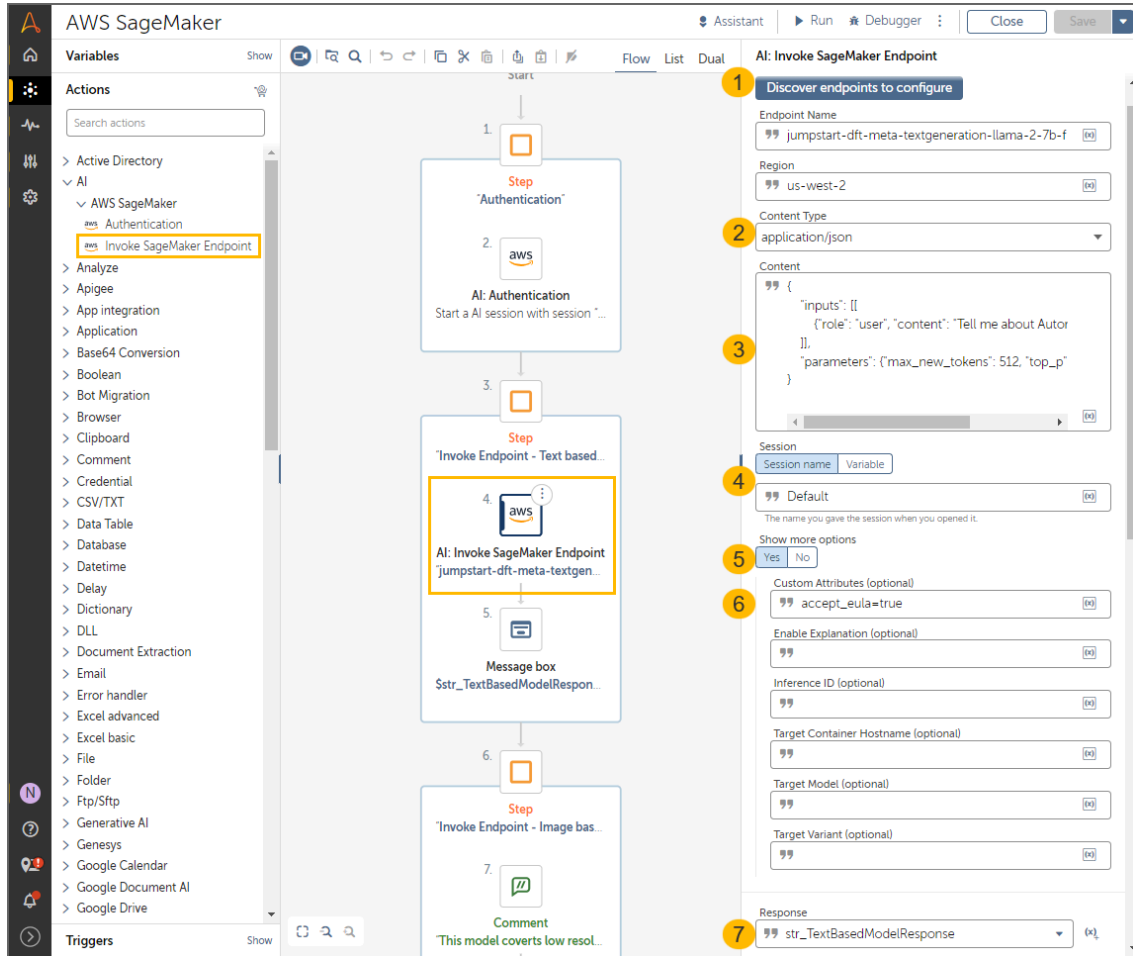

- a) Enter the credentials as described in [Authentication action](#) on page 2391.
- b) Click **Region** drop-down to select a region of your AWS instance from where you want to get the

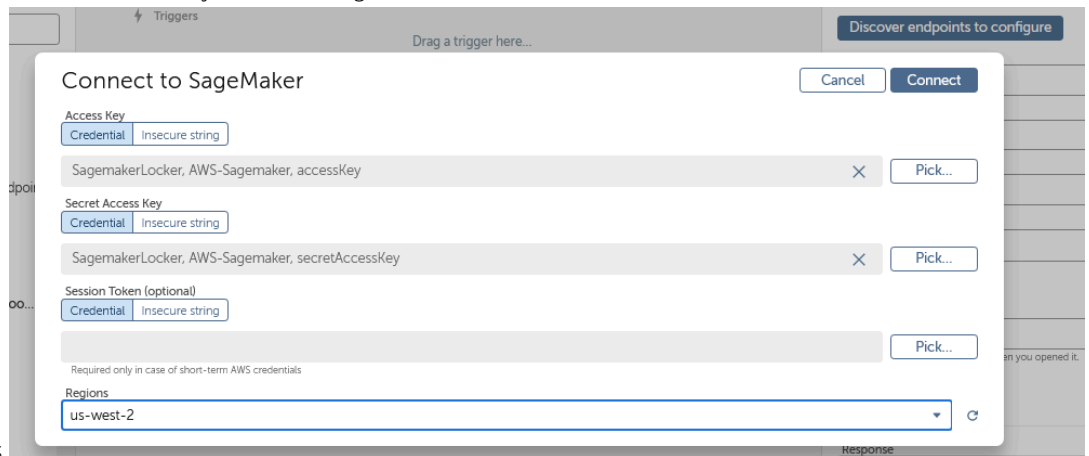

- c) Click **Connect**.

It connects to the SageMaker and lists the Endpoint available in the region

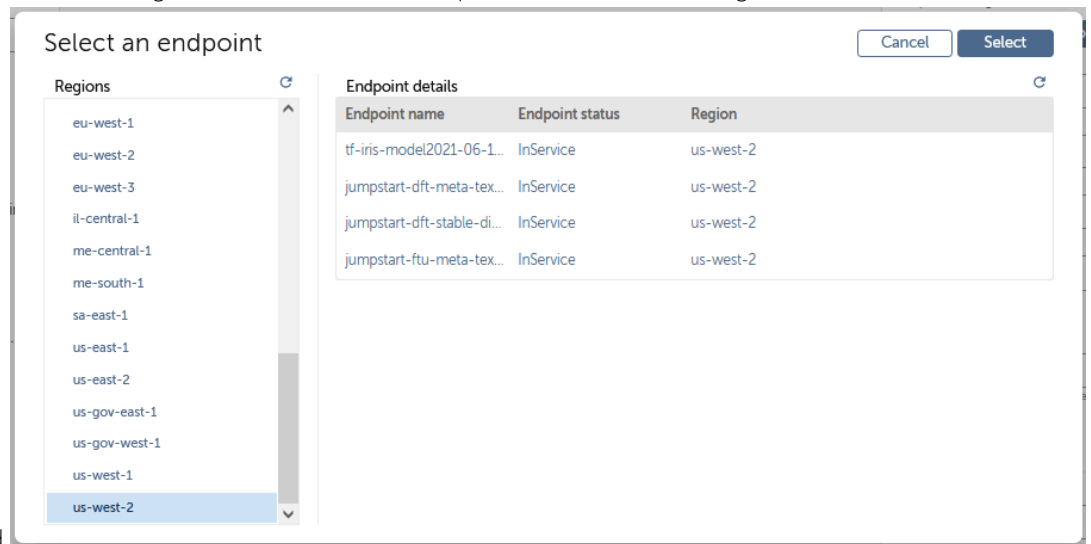

selected.

- d) Click an Endpoint name that corresponds to the model you want to use and click **Select**. A text-based model is used in this example. A pre-existing and a pre-trained model is used, and you can view the models already deployed by navigating to **Inference > Endpoints**. If you want to deploy a model of your choice, see [AWS SageMaker Deploy models for inference](#) and to train the deployed models, see [AWS SageMaker Build, Train, and Deploy models for inference](#). To get more information on the models, click a model.
  - e) Click **Select**.  
It auto fills the **Endpoint Name** and **Region** to the parent screen.
2. Click **Content Type** drop-down to select the content payload type you want to input. In this example, select **application/json** as the payload type.
  3. Input the content in a JSON format. In this example, the following JSON is used:

```
{
  "inputs": [
    [
      {
        "role": "user",
        "content": "Tell me about Automation Anywhere"
      }
    ]
  ],
  "parameters": {
    "max_new_tokens": 512,
    "top_p": 0.9,
    "temperature": 0.6
  }
}
```

4. Enter **Default** as the session name or store the session in a Variable.
5. To manage the optional parameters, select **Yes** for **Show more options**. If you select Yes, you can add other parameters such as: **Custom Attributes (optional)**, **Enable Explanation (optional)**, **Inference ID (optional)**, **Target Container Hostname (optional)**, **Target Model (optional)**, and **Target Variant (optional)**. For information about these optional parameters and details on Invoke SageMaker Endpoint, see [AWS SageMaker InvokeEndpoint](#).

6. In this example, the model selected requires accepting the EULA, you need to set the **Custom Attributes (optional)** to `accept_eula=true`.
7. Click **Run** to start the bot. You can read the value of the field by printing the response in a Message box action. In this example, `str-TextBasedModelResponse` prints the

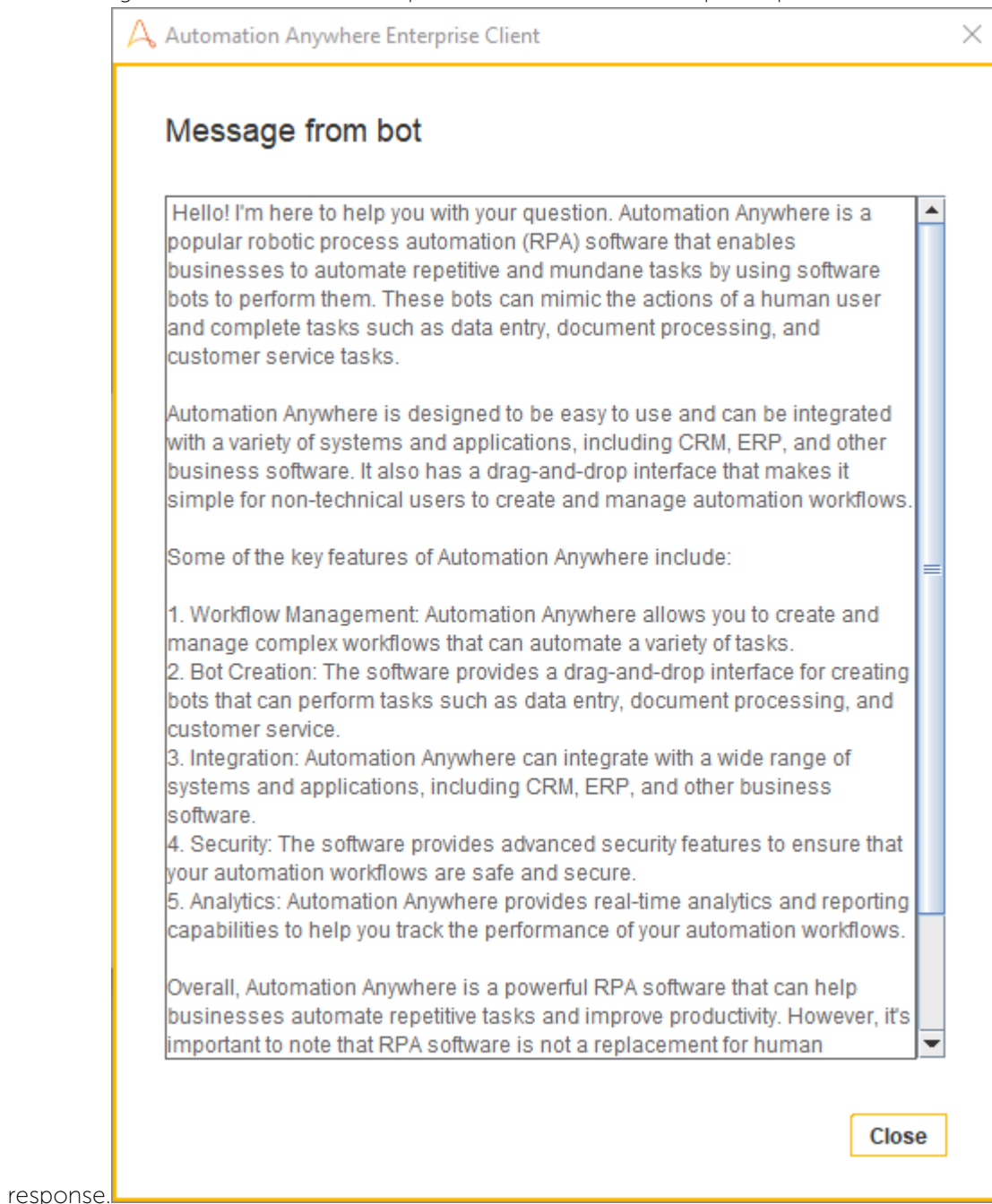

Invoke an Image based model on SageMaker

This topic describes how to invoke an image-based model on AWS SageMaker using an example that upscales the input image. Image upscaling with machine learning typically involves using

deep learning models, such as convolutional neural networks (CNNs), to increase the resolution or quality of images.

**Note:**

The AWS mark and logo are trademarks or registered trademarks of Amazon.com, Inc. and are used for identification purposes only.

A low-resolution image is transformed into a high-resolution image by upscaling the image using stable diffusion in the Amazon AWS SageMaker JumpStart model. The low-resolution image is encoded to a Base64 format and is given to the model for upscaling. The image below provides you with a flow that is followed in this upscaling process. For more information on AWS SageMaker JumpStart model, see [AWS SageMaker InvokeEndpoint JumpStart Upscale Images](#) and [AWS SageMaker InvokeEndpoint JumpStart Upscaling](#).

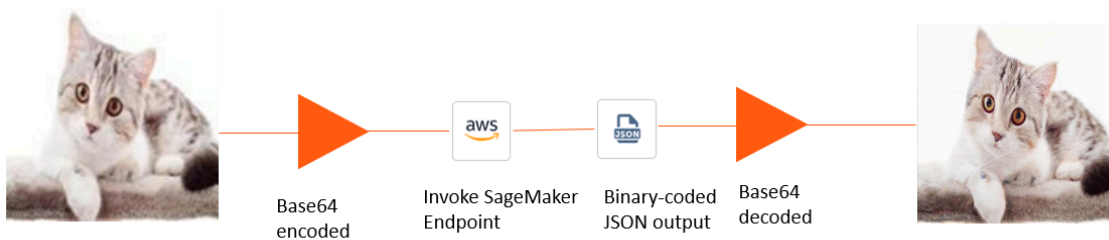

1. In the Control Room, click **Configure using SageMaker endpoints discovery** to get the list of endpoints.

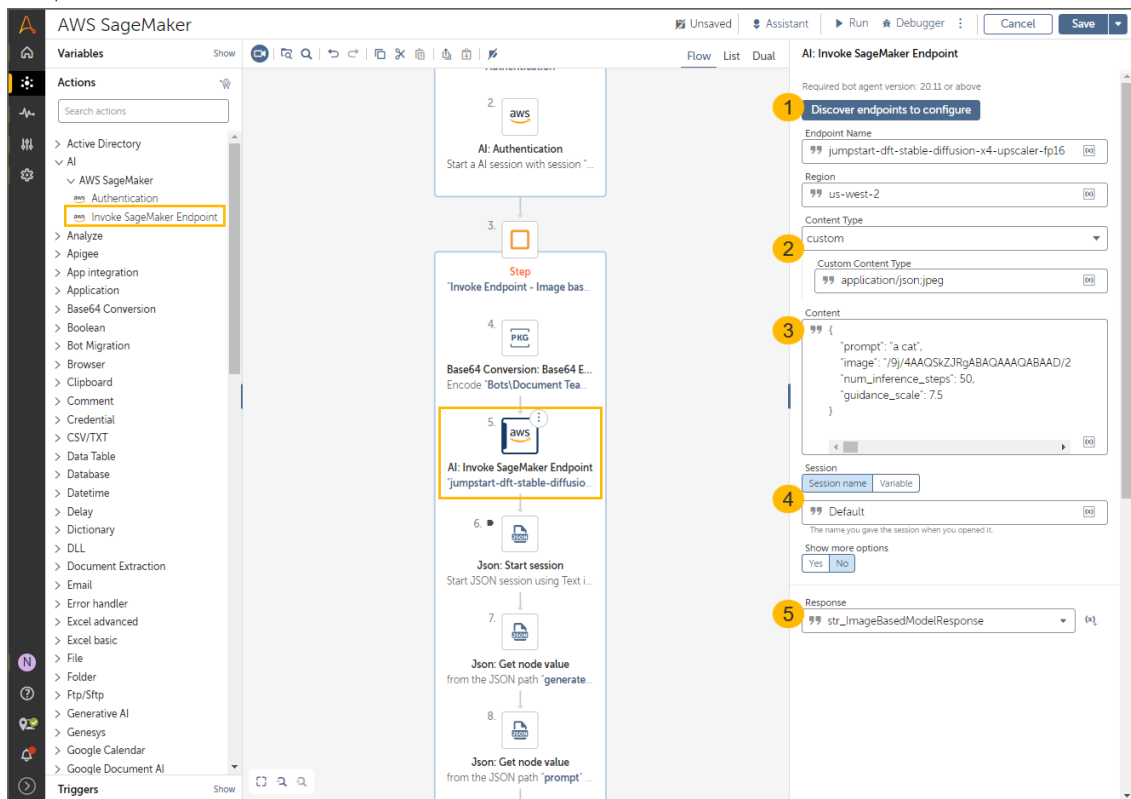

- a) Enter the credentials as described in [Authentication action](#) on page 2391.



- b) Click **Region** drop-down to select a region of your AWS instance from where you want to get the endpoints.
  - c) Click **Connect**.  
It connects to the SageMaker and lists the Endpoint available in the region selected.
  - d) Click an Endpoint name that corresponds to the model you want to use and click **Select**. An image-based model is used in this example. A pre-existing and a pre-trained model is used, and you can view the models already deployed by navigating to **Inference > Endpoints**. If you want to deploy a model of your choice, see [AWS SageMaker Deploy models for inference](#) and to train the deployed models, see [AWS SageMaker Build, Train, and Deploy models for inference](#). To get more information on the models, click a model.
  - e) Click **Select**.  
It auto fills the **Endpoint Name** and **Region** to the parent screen.
2. Click **Content Type** drop-down to select the content payload type you want to input. In this example, select **application/json;jpeg** as the payload type.
  3. Store the low-resolution image in a folder and use the Base64 Conversion: Base64 Encode action to convert the image into a base64 encoded text. Input the base64 encoded text in a JSON format as shown in the example below:

```
{
  "prompt": "a cat",
  "image": encoded_image,
  "num_inference_steps": 50,
  "guidance_scale": 7.5
}
```

The output of the base64 encode is used in the encoded\_image.

4. Enter **Default** as the session name or store the session in a Variable.
5. The response JSON is stored in a variable str-ImageBasedModelResponse.  
The response JSON contains 2 parts:
  - Generated Image: The Generated Image node contains the binary of the upscaled image.
  - Prompt: The input prompt. In this example, it is a cat.
6. You can use a base 64 decoder to convert the output into an image. In this example bot, each node of the JSON is read and the value of the Generated Image: node is passed to the decoder to generate the upscaled image.

## Advanced Classifier package

The Advanced Classifier package enables you to classify documents into a folder structure. You can upload the documents from the folders to the respective learning instance for content extraction in Document Automation.

---

### Note:

- A valid Skillja (3rd Party provider) license is mandatory for utilizing the Advanced Classifier package and the associated actions to process documents. For more information, see [Configuring bring your own key \(BYOK\) for Advanced Classifier package](#) on page 2411.
- Your CSM, AE or PEM can contact [contact@scalehub.com](mailto:contact@scalehub.com) to obtain the license details.

- You can download the Advanced Classifier package from [IQ Bot downloads](#) link.
- You must upload this package to the Control Room. For more information, see [Add packages to the Control Room](#) on page 1908.

## Actions in the Advanced Classifier package

The package contains the **Train Advanced Classifier**, **Classify Document**, **Classify Pages**, and **Split Document** actions. You can use these actions to create a model file, and use the file to classify uploaded documents into different folders. These actions work as a precursor to document processing.

Actions	Description
Train Advanced Classifier	Use the Train Advanced Classifier action to create a model file that is used by the Classify Document, Classify Pages, or Split Document actions to sort the documents into required categories for input. For more information, see <a href="#">Using the Train Advanced Classifier action</a> on page 2403.
Classify Document	The <b>Classify Document</b> action groups the input documents based on the first page of each document, using the selected model file that is created with the <b>Train Advanced Classifier</b> action. For more information, see <a href="#">Using the Classify Document action</a> on page 2408.
Classify Pages	The <b>Classify Pages</b> action groups the pages of an input document based on the model file that was created using the <b>Train Advanced Classifier</b> action and filters out the pages that do not fit the model. For more information, see <a href="#">Using the Classify Pages action</a> on page 2409.
Split Document	Use the <b>Split Document</b> action to separate the input document into multiple documents based on the selected classification model. For more information, see <a href="#">Using the Split Document action</a> on page 2410.

### Note:

The Advanced Classifier package leverages Tesseract OCR for image-based classification. For an extensive list of languages supported by Tesseract OCR, see [Tesseract OCR Supported Languages](#).

### Related reference

[Advanced Classifier package updates](#) on page 842

Review the updates in released versions of the Advanced Classifier package such as new and enhanced features as well as fixes and limitations. The page also lists the release dates of each version, and the compatible Control Room and Bot Agent versions.

## Using the Train Advanced Classifier action

Use the **Train Advanced Classifier** action to create a model file that is used by the **Classify Document**, **Classify Pages**, or **Split Document** actions to sort the documents into required categories for input.

Before building the bot, collect example documents and categorize them into folders. Ensure the set of example documents meets the following requirements:

- Has at least two categories.
- A minimum of 15 files per category is required, with a recommendation of 20 files per category.
- There are no restrictions on the maximum number of categories. However, it is important to note that as the training data set and the corresponding model size increase, the performance of the classification process can decline. Therefore, it is advisable to keep the number of categories within a range of 150 per model file for optimal performance.
- The supported file formats are as follows:
  - .tiff
  - .bitmap
  - .jpeg
  - .png
  - .pdf
  - .txt
- We recommend that you provide images with a resolution of 300 dpi (dots per inch). The minimum acceptable resolution is 200 dpi.

---

### Note:

If these minimum requirements are not met, an error message is displayed during bot run-time.

- 
1. In the Actions palette, double-click or drag the **Train Advanced Classifier** action from the Advanced Classifier package.
  2. Enter a name for the model file in the **Model name** field.
  3. Select the **Training folder path** from **Desktop folder** or **Variable**. The input folder path must have subdirectories with the names that correspond to the category of the documents that you want to train the classifier on. For example, if you have sales-related documents, the input folder path must have subfolders such as Invoice and Purchase Order.
  4. Optional: If you select **Desktop** file, click **Browse** to change the default filepath. For example, C:\Users\Dave\BankStatement\TrainingData
  5. Use the **Model output path** field to select the directory for the output model file.
  6. In the **License** field, provide a license credential.
  7. If you select **Credential** option, click **Pick** to get a license from the license locker.
  8. In the **Document Split Training** field:
    - If you select **Disabled**:

- a) In Advanced Settings, choose the **Classification Type** from the drop-down menu based on the type of classifier you want to build:
  - Visual Classifier
  - Content Classifier
  - Visual and Content Classifier
- b) Optional: Add the **Text Rules**.

If you select **Enabled**:

- a) You will see the following options:
  - Merge Unknown Document - Unchecked, by default.
  - Unknown Page Threshold - 30 percent, by default
  - Split Confidence Threshold (or Separation Split Threshold) - 70 percent, by default.
- b) In Advanced Settings, choose the **Classification Type** from the drop-down menu based on the type of classifier you want to build:
  - Visual Classifier
  - Content Classifier
  - Visual and Content Classifier
- c) Optional: Add the **Text Rules**.

---

**Note:** There must be only one rule file per category. If the rules file is placed outside the category folders shows the following error message:

```
Invalid rule file location
```

---

## 9. Click **Save** and **Run**.

After creating the model, build a bot to classify input documents. For more information, see [Using the Classify Document action](#) on page 2408.

## Set up rules for classifying documents or pages

This topic describes about the capability to set up rules for classifying documents or pages.

### Understanding rules and their usage

A rule is used to determine the category to which a document should be assigned. For the below example, a rule can specify a particular phrase like `Annexure` and when the rule is applied to the document text, if that phrase is found, the category associated with the rule will be assigned a high score, such as 80, indicating a strong match.

```
[
{
  "DocumentTypeID": 0,
  "Location": 0,
  "Distance": 1,
```

```

"Score": 80,
"KBGuid": "00000000-0000-0000-0000-000000000000",
"IsEnabled": true,
"ExpectExactSequence": false,
"TextRulePhrases": [
  {
    "Text": "Annexure",
    "IsNegativePhrase": false,
    "PhraseType": 1
  }
]

```

Rules are useful when additional guidance is needed to enhance the accuracy of a classification model in determining the most relevant document category. While technically it is possible to do all classification using a rules, it is not the best practice as the management of rules configuration becomes a significant overhead overtime especially when dealing with large number of categories.

### Example of a rule file

A rule file is a json schema and in json format as specified below. The <filename>.json can have multiple rules setup. For a document to be considered during the training process for classification, it must be placed in a designated training folder category, for example, C:\Invoice\Vendor1.

```

[
  {
    "DocumentTypeID": 0,
    "Location": 1,
    "Distance": 3,
    "Score": 90,
    "KBGuid": "00000000-0000-0000-0000-000000000000",
    "IsEnabled": true,
    "ExpectExactSequence": true,
    "TextRulePhrases": [
      {
        "Text": "Annexure",
        "IsNegativePhrase": false,
        "PhraseType": 1
      },
      {
        "Text": "Terms & Conditions",
        "IsNegativePhrase": false,
        "PhraseType": 1
      },
      {
        "Text": "Payment Terms",
        "IsNegativePhrase": false,
        "PhraseType": 1
      }
    ]
  },
  {
    "DocumentTypeID": 2,
    "Location": 2,

```

```

"Distance": 1,
"Score": 95,
"KBGuid": "00000000-0000-0000-0000-000000000000",
"IsEnabled": true,
"ExpectExactSequence": false,
"TextRulePhrases": [
{
"Text": "Addendum",
"IsNegativePhrase": true,
"PhraseType": 5
}
]
}
}
]

```

## Configurable properties of a rule file

Configuration	Description
DocumentTypeID	Currently, this field is not supported. For any rule being setup it can be kept static text as 0.
Location	<p>This configuration specifies which location of the document text the rule applicable. The values can be 0, 1, 2, or 3.</p> <ul style="list-style-type: none"> <li>"Location": 0 Any Location: There are no restrictions for finding the phrase, it can be anywhere on the document</li> <li>"Location": 1 First Page: The phrase must be found on the first page of the document.</li> <li>"Location": 2 Inside Caption: The phrase must be found on inside caption text of the document.</li> <li>"Location": 3 Last Page: The phrase must be found on the last page of the document. If only a few pages are provided to the text rule classifier, the last page is the one that will be passed to the classifier..</li> </ul>
Distance	<p>This configuration specifies the distance between phrases when the look-up is done on the document text. The rule will only match if the distance is as specified basis this configuration. The values can be 0, 1, 2, or 3.</p> <ul style="list-style-type: none"> <li>"Distance": 0 Same Text Line: All phrases must be in the same text line.</li> <li>"Distance": 1 Next Text Line: All phrases must be in the same text line or have a maximum of one line-break in between each other.</li> <li>"Distance": 2 Same Paragraph: All phrases must be within the same paragraph text.</li> <li>"Distance": 3 Same Page: All phrases must be on the same page.</li> </ul>

Configuration	Description
Score	After a rule match is performed, a score is assigned to the category (or training folder) associated with that rule. The score value can range from -100 to 100.
KBGuid	Currently, this field is not supported. For any rule being setup it can be kept static text as 00000000-0000-0000-0000-000000000000
IsEnabled	This allows rule to be enabled or disabled by setting <code>true</code> OR <code>false</code> respectively.
ExpectExactSequence	<p>When looking up multiple phrases in a rule, this configuration specifies exact sequence based matching. For example, if set <code>true</code> in the example, "<code>Text</code>": "<code>Annexure</code>", "<code>Text</code>": "<code>Terms &amp; Conditions</code>", and "<code>Payment Terms</code>" must be present in the document text in this order for the rule to match. It is possible for other text to exist between these phrases, but it is important that the order of these phrases is consecutive, with one following the other.</p> <hr/> <p><b>Note:</b> Unless its very clear that the expected sequence will follow a specific pattern its recommended to keep this configuration as <code>false</code></p> <hr/>
TextRulePhrases	The <code>TextRulePhrases</code> contains all the phrase text values that needs to be looked up against the document text. It can have one or more phrase text values.
Text	<code>Text</code> - specifies the phrase text value that needs to be looked up against the document text
IsNegativePhrase	<code>IsNegativePhrase</code> - specifies whether the lookup condition is a negative phrase type of lookup. When set <code>true</code> in the example, this will mean that " <code>Text</code> ": " <code>Addendum</code> " is not present in the document text for the rule to match.

Configuration	Description
PhraseType	<p>PhraseType specifies type of match that will be used when phrase text value is looked up against the document text</p> <p>"PhraseType": 1 Fuzzy Matching allows you to use some tolerance in word matching. A phrase is matched if the Levenshtein distance is <math>\geq 80\%</math>. For a 5 character word this means 1 character can be different.</p> <p>"PhraseType": 5 Exact Matching requires an exact match of the phrase but still ignores character casing and also includes some filtering of punctuations.</p> <p>"PhraseType": 6 RegularExpression allows you to define a regular expression that is then searched in the original text. No text pre-processing or filtering of punctuation characters is done for this type of matching.</p>

## Using the Classify Document action

The **Classify Document** action groups the input documents based on the first page of each document, using the selected model file that is created with the **Train Advanced Classifier** action.

- If not done already, use the **Train Advanced Classifier** action to create a model file.
- Ensure the input files are in required format.

Build a bot with the **Classify Document** action within a **Loop** action to iteratively classify each file in the selected folder.

1. In the Actions palette, double-click or drag the **Classify Document** action from the Advanced Classifier package.
2. In the **Input file** field, provide the default filepath for incoming files for classification:
  - **Control Room file**
  - **Desktop file**
  - **Variable**
3. In the **Classifier** field, provide the filepath of the model file. You can either select the **.zip** folder or extract the **.clsproj3** file from this folder and select it.
  - **Control Room file**
  - **Desktop file**
  - **Variable**
4. Use the **Output folder** path option to save the classification output documents. The pages from the output document are saved in the respective subfolders based on the categories created in the model file.
  - **Desktop folder**
  - **Variable**
5. In the **License** field, provide a license credential.
6. If you select **Credential** option, click **Pick** to get a license from the license locker.



7. Optional: Configure the Confidence threshold (%). If the confidence value of the category prediction of a document is less than the confidence threshold, the document is moved to the `Unclassified` folder.
8. Select or create a list variable to hold the output. The classification results as a list with the following keys:
  - `fileName`
  - `category`
  - `confidence`

## Using the Classify Pages action

The **Classify Pages** action groups the pages of an input document based on the model file that was created using the **Train Advanced Classifier** action and filters out the pages that do not fit the model.

- If not done already, use the **Train Advanced Classifier** action to create a model file.
- Ensure the input files are in required format.

Build a bot with the **Classify Pages** action within a **Loop** action to iteratively classify each file in the selected folder.

1. In the Actions palette, double-click or drag the **Classify Pages** action from the Advanced Classifier package.
2. In the **Input file** field, provide the default filepath for incoming files for classification:
  - **Control Room file**
  - **Desktop file**
  - **Variable**
3. In the **Classifier** field, provide the filepath of the model file. You can either select the `.zip` folder or extract the `.c1sproj3` file from this folder and select it.
  - **Control Room file**
  - **Desktop file**
  - **Variable**
4. Use the **Output folder** path option to save the classification output documents. The pages from the output document are saved in the respective subfolders based on the categories created in the model file.
  - **Desktop folder**
  - **Variable**
5. In the **License** field, provide a license credential.
6. If you select **Credential** option, click **Pick** to get a license from the license locker.
7. Optional: Configure the following:

Save classification output variable: Save the classification results as a list of dictionaries with the following keys:

  - `fileName`
  - `index`
  - `category`

- confidence

---

**Note:**

- You can select the type of classification in the Advanced Classifier:
  - Image-based classification
  - Text-based classification
  - Both image and text based classification

---

**8.** Click **Save** and **Run**.

You can use each subfolder of similar documents to create and train a learning instance to extract data from the documents.

## Using the Split Document action

Use the Split Document action to separate the input document into multiple documents based on the selected classification model.

- If not done already, use the **Train Advanced Classifier** action to create a model file.
- Ensure the input files are in required format.

To split a document into multiple documents, do the following:

1. In the **Actions** palette, double-click or drag the **Split Document** action from the **Advanced Classifier** package.

---

**Note:** The PDF and TIFF documents with multiple pages are the only valid inputs for the **Split Document** action.

2. In the **Input file** path, select one of the following options to specify the location of the Input file:
  - **Control Room file**
  - **Desktop file**
  - **Variable**
3. Use the **Output folder** path option to save the classification output documents.
  - **Desktop folder**
  - **Variable**
4. In the **License** field, provide a license credential.
5. If you select **Credential** option, click **Pick** to provide a license from the credential vault.
6. Use the **Save split output variable** option to save the classification output documents. Save the classification results as a list of dictionaries with the following keys:
  - fileName
  - documentIndex
  - pageIndex
  - category
  - classConfidence

- splitConfidence

7. Click **Save** and **Run**.

## Comparing Advanced Classifier and Document Classifier

This topic is a concise comparison matrix between Advanced Classifier and Document Classifier.

Table 4: Comparison Matrix: Advanced Classifier vs Document Classifier

Capability	Advanced Classifier	Document Classifier
Key for Multiple Matches: Use the key to fetch more than one matching classes	Available	Not Available
Hierarchical Classification: Can process class definition using a complex folder tree structure.	Available	Not Available
Rules for Document Classification: Ability to define rules for document or page classification.	Available	Not Available
Split Document: Feature for handling document splitting during training.	Available	Not Available
Retraining: Incrementally updates the classification model using additional files.	Not Available	Available
OCR Engine: Type of OCR engine used for text extraction and processing.	Tesseract OCR	ABBYY FineReader Engine

## Configuring bring your own key (BYOK) for Advanced Classifier package

To leverage BYOK (bring your own key) license for Advanced Classifier package, follow these configuration steps.

Log in as the Admin user type with **Locker** admin.

Create a custom role to access the Credential Vault locker.

1. Navigate to **Administration > Roles > Create role**.
2. Provide a name for the role, such as `advanced-classifier-credential-role`. The `Manage my credentials` and `lockers` permission is automatically selected.
3. Click **Create role**.

Assign the role to the Bot creator and Unattended Bot Runner user types.

4. Navigate to **Administration** > **Users** and locate the users.
5. For each user, click Edit user and add the `advanced-classifier-credential-role`.
6. Navigate to **Manage** > **Credentials** > **Create credential**.
7. Provide a name for the credential, such as `advanced-classifier-credential`.
8. Provide a name for the attribute, such as `ServiceAccount`.
9. Select the **Standard** input option and enter the `License` json key in the **Value** field.
10. Click **Create credential**.  
Create a locker to store the key and provide access to other users.
11. Navigate to the **Lockers** tab and click **Create locker**.
12. Provide a name for the locker, such as `advanced-classifier-locker`.
13. Select the `advanced-classifier-credential` and click the right arrow to move the credential to the **Selected column**.
14. In the **Consumers** tab, select the `advanced-classifier-credential-role` and click the right arrow to move the credential to the **Selected** column.
15. Click **Create locker**.

## Analyze package

Use the actions in the **Analyze** package to specify the actions and variables to use in the Bot Insight dashboard and widgets. The **Analyze** package enables you to perform transactional analytics for the data that is logged by the variables when the bot runs.

---

**Note:** The proxy configuration with authentication is currently not supported.

---

### Actions in the Analyze package

The **Analyze** package includes the following actions:

Action	Description
Close	<p>Closes a transaction.</p> <ul style="list-style-type: none"> <li>• In the <b>Transaction name</b> field, enter the transaction name that you provided in the <b>Open</b> action.</li> <li>• In <b>Dictionary variable</b>, select the following options: <ul style="list-style-type: none"> <li>• <b>All user-defined variables</b>: Include all the user-defined string, numeric, and datetime variables from the bot to populate the Bot Insight dashboards.</li> <li>• Manually select the variables to include in the Bot Insight dashboards.</li> </ul> </li> </ul>
Open	<p>Opens a transaction. Insert the actions that you want to include for analysis between the <b>Open</b> and <b>Close</b> actions. In the <b>Transaction name</b> field, enter a transaction name.</p>

Using the **Open** and **Close** actions with the **Loop** package

- If you want to capture all the data within the loop in the Bot Insight dashboard, use the **Open** and **Close** actions inside the loop.

Example: If you are using the **For each row in CSV/TXT** iterator in the **Loop** action to read values from each row in a Microsoft Excel sheet, use the **Open** and **Close** actions inside this loop to analyze and capture the data of each row in the Bot Insight dashboard.

- If you want to capture only the last interpreted data of the loop in the Bot Insight dashboard, use the **Open** and **Close** actions outside the loop.

Example: If you are using the **For each row in CSV/TXT** iterator in the **Loop** action to read values from each row in a Microsoft Excel sheet, use the **Open** and **Close** actions outside this loop to capture only the data in the last row of the Excel sheet in the Bot Insight dashboard.

Using the **Open** and **Close** actions with the **Error handler** and **If** packages

- If you want to analyze and capture error messages during bot execution in the Bot Insight dashboard, use the **Open** and **Close** actions with an **Error handler** package.

Example:

1. Create a bot with multiple **If** actions within a loop.
2. To capture errors, within every **If** action, add an **Error Handler > Catch** action.
3. Inside the loop, after every **If** action, add the **Analyze > Close** action to capture the errors inside every **If** condition on the Bot Insight dashboard for analysis.

---

**Example task:** See the following topic for an example of building a bot to retrieve data from a website to create visualizations in Bot Insight: [Build a Bot Insight dashboard bot](#) on page 3253. The example includes using the **Open** and **Close** actions inside a loop when using the **For each row in CSV/TXT** iterator in the **Loop** action.

---

## Apigee action package

Use the Apigee package to connect to an Apigee instance to run integrations and collaborate efficiently to function as one unit.

---

### Note:

The Apigee mark and logo are trademarks or registered trademarks of Google LLC and are used for identification purposes only.

---

Apigee Integration offers business organizations of all sizes the tools needed to connect and manage the multitude of software applications required to support business operations in a digital world. With Apigee Integration's out-of-the-box triggers, configurable tasks, and friendly user interface, you can create enterprise-level integrations with ease. All the Automation 360 actions can be configured to an API trigger to invoke executions for Apigee integrations.

The following illustration shows an overview of the actions that can be used to connect to an Apigee instance and execute integrations:

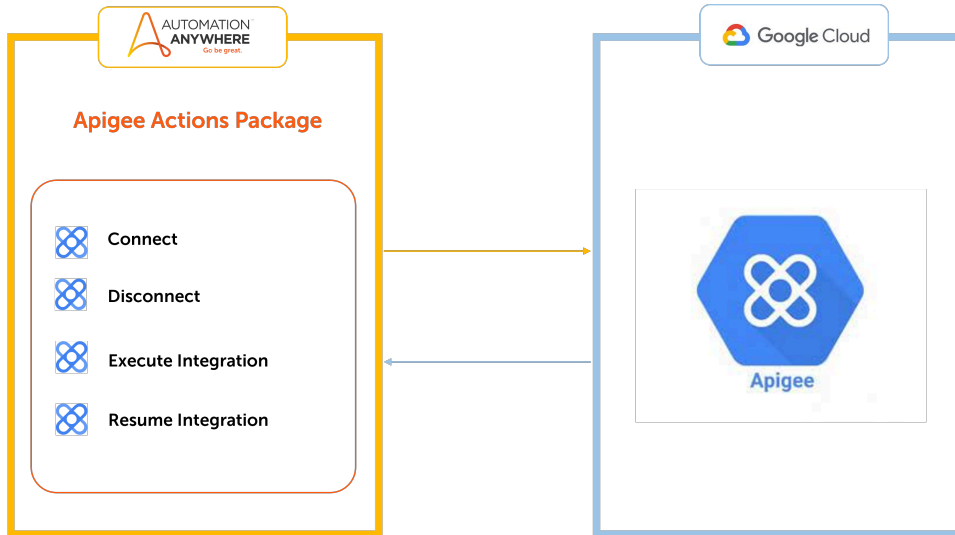

Related reference

[Apigee package updates](#) on page 843

Review the updates in released versions of the Apigee package such as new and enhanced features as well as fixes and limitations. The page also lists the release dates of each version, and the compatible Control Room and Bot Agent versions.

## Apigee Connect

You can connect to a Google Cloud Platform (GCP) instance using the **Apigee Connect** action. The GCP manages access to your Apigee instance.

**Note:** The examples and graphics provided on this page are for representation purposes only and may not accurately reflect your specific instance. We do not assume responsibility for their maintenance or accuracy.

- Create a GCP account ([GCP Cloud](#)) and create a GCloud project.
- Login to your GCloud account at [Google Cloud Project](#) and create a project. If you already have access to a project, you will see your project here.
- Create an OAuth 2.0 Client ID. A client ID is used to identify a single application to Google's OAuth Servers. For more details, see [Apigee Connect](#).

You can connect to an Apigee instance using the **Apigee Connect** action from Automation 360.

You can use different connection methods to connect to Apigee:

- **User Account:** Use this connection method by providing the GCloud account credentials. The GCloud account is required to establish a connection.
- **Service Account:** Use this connection method by providing the GCloud service account key. This method uses the certificate to authenticate between servers rather than user credentials. To create a service account key, see [Creating a service account](#).
- **Control room OAuth connection:** Use this connection method by creating an OAuth connection and storing it in the Control Room.

1. Log in to the Control Room.

2. Create a new bot or edit an existing bot. For more details, see [Create your first bot](#) on page 1489.
3. From the Actions pane, select **Apigee > Connect** and place it under the **Start** of the bot flow.
4. In the **Authentication Type** field, select the authentication method from the drop down list.
5. To view client ID and client secret details in Apigee for **User Account** authentication, complete the following steps:
  - a) Open the [Google Cloud console](#).
  - b) At the top-left, click **Menu > APIs & Services > Credentials**.
  - c) Click on an application under OAuth 2.0 Client IDs that you want to connect.

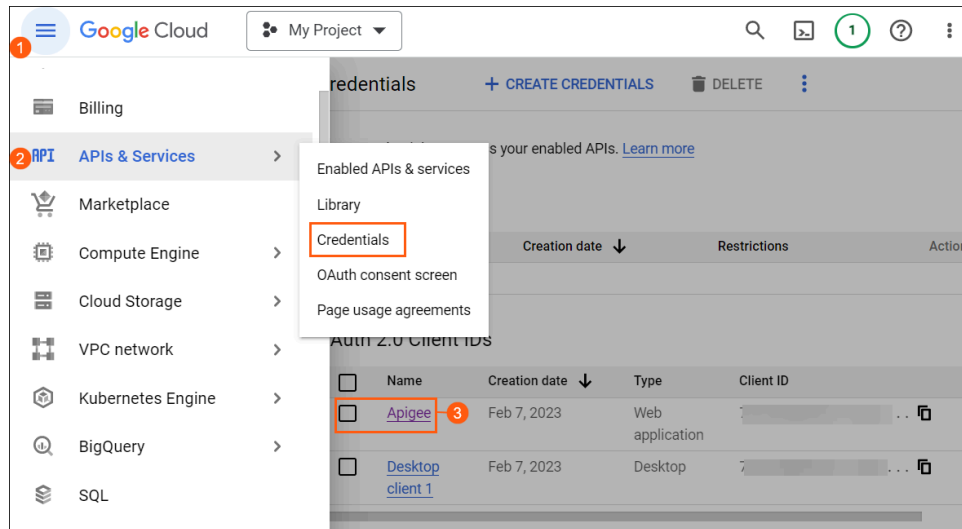

- d) Copy the values from **Client ID**, **Client secret**, and **URI** fields.
6. To connect using User Account, complete the following steps:
    - a) In the **User Email Address** field, enter the email address used to login to the GCloud account.
    - b) In the **Client ID** field, paste the **Client ID** copied from the GCloud. This example uses **Insecure string** whereas you can use **Credential** or **Variable** options for better security.
    - c) In the **Client Secret** field, paste the **Client Secret** copied from the GCloud.
    - d) In the **Redirect URI** field, enter the redirect URI from the GCloud account.
    - e) Enter **Default** as the session name.

**Note:** You can use one of the following options to specify the **User Email Address/Client ID/Client secret/ Redirect URI**:

- **Credential:** Enables you to use a value in the Credential Vault that contains information about the User Email Address/Client ID/Client secret/Redirect URI.
- **Variable:** Enables you to use a credential variable that contains information about the User Email Address/Client ID/Client secret/Redirect URI..
- **Insecure string:** Enables you to enter the User Email Address/Client ID/Client secret/Redirect URI. User Email Address/Client ID/Client secret/Redirect URI

7. To connect using Service Account, in the **Service Account Key** field, enter the GCloud service account key. This example uses **Insecure string** whereas you can use **Credential** or **Variable** options for better security.

**Note:** If you do not have access to generate and retrieve the **Service Account Key**, contact your Google Cloud Admin.

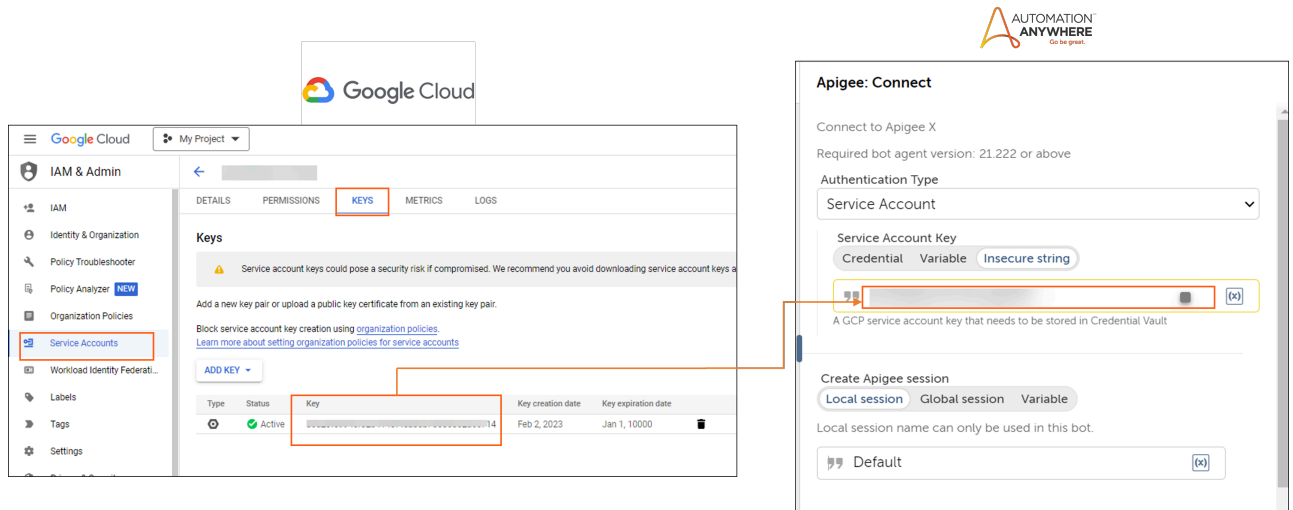

8. To configure a **Control room OAuth connection** in Apigee, complete the following steps:
  - a) Complete step 1 to step 5 in [Create OAuth connection](#) on page 1893.
  - b) Open the [Google Cloud console](#).
  - c) At the top-left, click **Menu > APIs & Services > Credentials**.
  - d) Click **CREATE CREDENTIALS > OAuth client ID**.
  - e) Select **Web application**. Enter a name and add the Callback URL from [Create OAuth connection](#) on page 1893 as an authorized redirect URI.
  - f) Click **Create**.
  - g) Copy the client ID and client secret.
  - h) Go to [Create OAuth connection](#) on page 1893 and complete the remaining steps to create an OAuth connection with the above details.
9. To connect using **Control room OAuth connection**, pick an Apigee OAuth connection you have created and stored in the Control Room. For more details, see [Configure OAuth connections in Control Room](#) on page 1889.
10. In the **Create Apigee session** field, the session name is displayed as **Default**.

## Apigee Disconnect

You can disconnect from your Apigee instance and clear the session using the **Apigee Disconnect** action.

1. From the **Actions** pane, select **Apigee > Disconnect** and place it under the bot flow.
2. Enter the session name and click **Run**.



3. After the bot runs, your Apigee instance is disconnected.

## Apigee Execute Integration

You can configure and execute an integration in Apigee using the **Apigee Execute Integration** action.

- Create a GCP account ([GCP Cloud](#)) and create a GCloud project.
- Login to your GCloud account at [Google Cloud Project](#) and create a project. If you already have access to a project, you will see your project here.
- Create an OAuth 2.0 Client ID. A client ID is used to identify a single application to Google's OAuth Servers. For more details, see [Apigee Connect](#).

Use the **Apigee Execute** action to execute an integration in an Apigee instance from Automation 360.

1. Log in to the Control Room.
2. Create a new bot. For more details, See [Create your first bot](#) on page 1489.
3. From the **Actions** pane, select **Apigee > Execute integration** and place it under the **Start** of the bot flow.
4. Click **Discover integrations to configure. Step 1/4: Connect to Apigee X** appears. In the **Authentication Type** drop down, select the authentication method. For more details, see [Apigee Connect](#) on page 2414.
  - **User Account:** Use this connection method by providing the GCloud account credentials.
  - **Service Account:** Use this connection method by providing the GCloud service account key. You need to add the service account key in the following JSON format. It is recommended to store the entire JSON snippet in the credential vault and pick the saved credential during connection.

```
{
  "type": "service_account",
  "project_id": "your_project_id",
  "private_key_id": "your_private_key_id",
  "private_key": "-----BEGIN PRIVATE KEY-----\your_private_key-----
END PRIVATE KEY-----\n",
  "client_email": "your_client_email",
  "client_id": "your_client_id",
  "auth_uri": "https://accounts.google.com/o/oauth2/auth",
  "token_uri": "https://oauth2.googleapis.com/token",
  "auth_provider_x509_cert_url": "https://www.googleapis.com/oauth2/v1/certs",
  "client_x509_cert_url": "your_client_certificate_url"
}
```

- **Control room OAuth connection:** Use this connection method by creating an OAuth connection and storing it in the Control Room.
5. Click **Connect**.  
If the credentials are correct, it gets connected to GCloud and the **Step 2/4: Load Integration** screen appears.
  6. Select the following in the **Step 2/4: Load Integration** screen.
    - a) Click the **Project ID** drop-down and select the project ID from where you want to load the integration.

- b) Click the **Location** drop-down and select the location from where you want to load the integration.

7. Click **Next**.

**Step 3/4: Select an Integration** screen appears with all the available integrations.

8. Select an integration from the list.

Name	Description	Location	Active	Update Time
aaa-apigee-discovery	Launch a bot for Mone...	us-central1	true	2022-09-06T15:34:27...
aaa-launch-sfdc-bot	Launch a bot on Autom...	us-central1	true	2022-09-02T17:58:31...

9. Click **Next**.

**Step 4/4: Configure my Integration** screen appears with all the configuration options.

10. In the **Step 4/4: Configure my Integration** screen, click the **API Trigger** drop-down and select the trigger you want to invoke.

Name	Type	Value
in_email_address	String	

The input parameters are the parameters retrieved from Apigee.

11. Click **Done**.

All the selected options are displayed as parameters in the **Apigee: Execute integration** action.

12. Click **Add new input parameter** to manually add the input parameters. You can provide the parameter value for different parameter types as specified in the following table:

Parameter type	Parameter value	Example
String	Specify a string value stored as a variable.	\$str_INString\$
Integer	Specify a number.	9
Double	Specify a decimal number.	20.5
JSON	Specify a JSON string.	\$str_JSONString\$
String Array	Specify string values in an array.	[a,b,c]
Integer Array	Specify integers in an array.	[11,22,334]

Parameter type	Parameter value	Example
Double Array	Specify integers and decimal numbers in an array.	[23.5,27,44.5]
Boolean	Specify boolean value as True or False.	True
Boolean Array	Specify boolean values as an array.	[true,false]
-- (Manual entry)	Specify any value from the above formats.	

13. We recommend that you click **Validate my settings** to validate all the parameters you have provided. If the values are incorrect, you will see the details in the **Integration Validation** window.

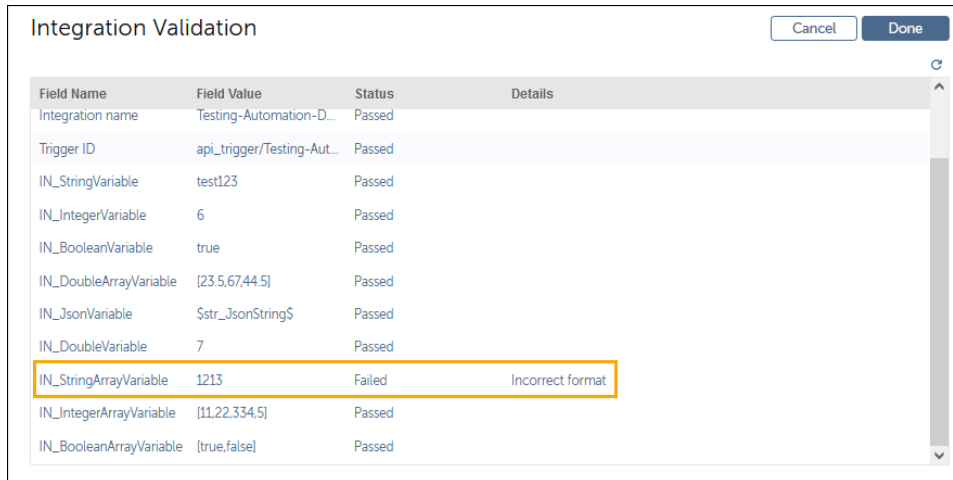

Field Name	Field Value	Status	Details
Integration name	Testing-Automation-D...	Passed	
Trigger ID	api_trigger/Testing-Aut...	Passed	
IN_StringVariable	test123	Passed	
IN_IntegerVariable	6	Passed	
IN_BooleanVariable	true	Passed	
IN_DoubleArrayVariable	[23.5,67,44.5]	Passed	
IN_JsonVariable	\$str_JsonString\$	Passed	
IN_DoubleVariable	7	Passed	
IN_StringArrayVariable	1213	Failed	Incorrect format
IN_IntegerArrayVariable	[11,22,33,4.5]	Passed	
IN_BooleanArrayVariable	[true,false]	Passed	

14. Enter **Default** as the session name.
15. You can store the execution ID to a variable to verify in Apigee. For example: ExecutionId.
16. To verify the response from the Apigee integration, you can store the response to a variable. For example: Execution.

### Apigee: Execute integration

Execute an Apigee integration

Required bot agent version: 21.222 or above

**Discover integrations to configure**

**Project ID**  
 (x)  
Unique identifier for the Google Cloud project

**Location**  
 ▾  
Location of the integration you want to execute

**Integration name**  
 (x)  
Name of the integration you want to execute

**Trigger ID**  
 (x)  
Trigger ID of the integration you want to execute

**16 Input parameters (1) (optional)**

Parameter name	Parameter type	Parameter value
in_email_address	--	\$SampleString\$

**Add new input parameter**  
Manually enter parameter names and values

**17 Validate my settings**

**Session**

**18**  (x)  
The name you gave the session when you opened it.

**19** **Execution ID (optional)**  
 ▾ (x)  
Execution ID of the integration you want to execute

**20** **Execution result (optional)**  
 ▾ (x)  
Execution result of the integration you want to execute

**Note:** The output is retrieved as a list of type `list`. To read an individual record (row) in this list, you need to loop through all the dictionary items using the `loop` action and read or extract the records (rows) individually. For example, the output of `get multiple records` is saved in the variable `list_of_records_any`. If the variable contains five

records, then each record is passed to the Loop action to be processed one at a

The screenshot shows an automation workflow with the following steps:

1. ServiceNow: Authentication Start a "Default" session on SPDI\_urls
2. ServiceNow: Get Multiple Records Get a list of "Incident" records using filter type (N
3. Loop : For each item in the list
4. Dictionary: Get value of the key "number" from \$ListItem\$
5. Dictionary: Get value of the key "severity" from \$ListItem\$
6. Dictionary: Get value of the key "short\_description" from \$ListItem\$
7. Message box "Record: \$O\_inc\_number\$, \$O\_severity\$, \$O\_descri
8. ServiceNow: Revoke Authentication End the "Default" session

An orange arrow points from the "Loop" action to a "View variable" dialog box. The dialog box shows the following details:

Type	Subtype
List	Any
Name	Description
list_of_records_array	An ordered group of items
Use as input	
No	
Use as output	
No	
Constant (read-only)	
No	
Default value (optional)	
This list is empty	

time.

## Apigee Resume Integration

You can resume an integration that is suspended in Apigee using the **Apigee Resume Integration** action.

You can use the suspend task in Apigee to temporarily pause and then resume the execution of an integration. When an integration is suspended the execution is halted and all tasks after the suspend task are suspended. You can configure an output variable (**Suspension result**) for the suspended task that you can use to resume the integration. You must configure a suspend task element in Apigee to suspend an integration. For more details, see [Suspend an integration](#).

You can use the [Apigee Execute Integration](#) on page 2417 to configure and execute an integration in Apigee. If you use the execute integration to suspend an integration in Apigee, the result shows a suspension ID that you can use to resume the integration.

To revoke the suspension you can use the **Apigee Resume Integration** action. You can use one of the following options to resume an integration:

- **Execution ID:** A unique identifier for the execute integration task that is performed to suspend a task in Apigee.
- **Suspension ID:** A unique identifier for the Suspend task. The value of this variable is set immediately after the integration is suspended.
- **Suspension result:** A variable to store the result of the Suspend task.

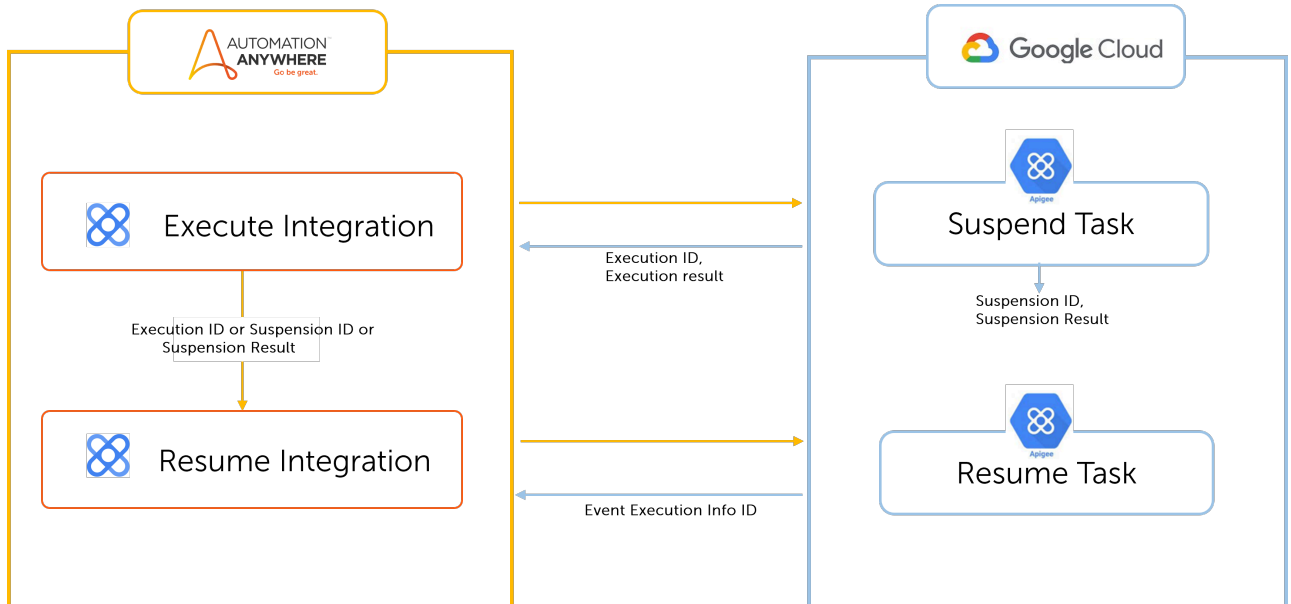

1. Log in to the Control Room.
2. Create a new bot or modify an existing bot. For more details, see [Create your first bot](#) on page 1489.
3. From the **Actions** pane, select **Apigee > Resume integration** and place it under the bot flow.
  - a) In the **Project ID** field, enter the GCloud project ID or select a variable if the project ID is stored as a variable.
  - b) In the **Location** field, select the location of the integration you want to resume.
  - c) In the **Integration name** field, specify the name of the Apigee integration.
  - d) In the **Execution ID (optional)** field, you can specify the unique execution ID of the Apigee integration.
  - e) In the **Suspension ID (optional)** field, you can specify the unique ID of the Apigee suspend task.
  - f) In the **Suspension result (optional)** field, you can store the suspension result in one of the following formats:
    - **Text:** You can use a text value for the suspension result.
    - **Dictionary:** You can use a name or value pairs for the suspension result.
    - **Manual entry:** You can manually enter names and values as the suspension result.
  - g) Enter **Default** as the session name.
  - h) In the **Event execution info ID (optional)** field, specify the unique ID of the integration execution.

**Apigee: Resume integration**

Resume a suspended Apigee integration  
Required bot agent version: 20.11 or above

**Project ID**  
 (x)  
Unique identifier for the Google Cloud project

**Location**  
 ▾  
Location of the integration you want to resume

**Integration name**  
 (x)  
Name of the Apigee integration

**Execution ID (optional)**  
 (x)  
Unique identifier for the Apigee integration execution

**Suspension ID (optional)**  
 (x)  
Unique identifier for the Apigee suspend task

**Suspension result (optional)**  
 Dictionary Manual entry  
 (x)  
Use a text value for the suspension result

**Session**  
 Variable  
 (x)  
The name you gave the session when you opened it.

**Event execution info ID (optional)**  
 ▾ (x)  
Unique identifier for the event execution info

## App Integration package

Extract text from a window and save it to a string variable by using the actions in the App Integration package.

The App Integration package supports the following technologies:

- UNIX shells, such as Cygwin, PowerShell, and GIT shell
- Windows applications, such as Calculator, Command Prompt, and Notepad
- Java applications that are based on the Standard Widget Toolkit and Abstract Window Toolkit, which can draw text using Windows text-drawing APIs

The actions in the App Integration package are based on legacy technology and have certain limitations on specific applications. To seamlessly obtain data from applications and browsers, use the [Recorder package](#) on page 2916.

## Building bots with actions from the App Integration package

1. Open the application or file from which you want to capture the text using the **Application > Open program/file** action.

[Application package](#) on page 2428

2. Extract the text using one of the actions from the App Integration package.
3. Use any of the following actions from the String package to manipulate the captured text:
  - **Extract text:** Extracts text from the source string using logical operators.
  - **Split:** Splits the string into multiple strings and stores the output in a list variable.
  - **Trim:** Trims blanks and white spaces from a string.

[String package](#) on page 3086

## Actions in the App Integration package

The App Integration package includes the following actions:

Action	Description
<b>Capture area</b>	See <a href="#">Capture area action</a> on page 2425.
<b>Capture scrollable text</b>	See <a href="#">Capture scrollable text action</a> on page 2426.
<b>Capture text of window</b>	See <a href="#">Capture text of window action</a> on page 2427.

Related reference

[Screen resolution dependent packages](#) on page 1802

The screen resolution between the Bot Runner and Bot Creator device should be consistent as when resolution-dependent packages are used to build bots, any screen resolution difference between the Bot Creator and Bot Runner device will impact the bots during runtime.

[App Integration package updates](#) on page 844



Review the updates in released versions of the App Integration package such as new and enhanced features as well as fixes and limitations. The page also lists the release dates of each version, and the compatible Control Room and Bot Agent versions.

## Capture area action

The **Capture area** action enables you to extract text from within the captured area of a window and saves it to a string variable.

### Settings

Extracts text from within the captured area of a window and saves it to a string variable.

- In the **Window** field, select an option: Choose from the **Application**, **Browser**, or **Variable** tab.
  - **Application**: Select from a list of windows, including browser windows, that are currently open on the device.
  - **Browser**: Select from a list of supported browser tabs.

---

**Note:** This option supports , Chromium-based , and browsers.

---

- **Variable**: Select an existing window variable to specify the title of the application window title.
- Insert a wildcard character (\*) in the **Window title** field to search for window titles that can change.

You can use a regular expression (regex) to identify a window title. Select the regular expression condition as either **String** or a **Pattern** and then enter the value. By default, the **Window title** field is case-sensitive.

To identify a browser title, you can enable the **Case sensitive** option to match the letter case, or disable the option to identify a window title where the letter case does not match.

---

**Note:** Ensure that the minimum version installed on your system is the version that was released with v.26. If you have a version released with v.25 or earlier, then by default, the window title will be identified only with matching letter case (case-sensitive).

---

For example, you can enter the **String** value as ( (\w\*) -Notepad for all window title names starting with ( (\w\*) -Notepad, or use **Pattern** value as ( (\w) \s) \*document-Notepad for only those window titles that match this pattern.

---

**Note:**

- When you use a regular expression of type **String** with `-title` as the input value for a window title in any , the might encounter a run time error. To prevent the run time error, ensure that when you add the string input as `*-title`, the application with the specific title is open. The asterisk (\*) is just a character, not a wild card character.
- When you use a regular expression of type **Pattern** with `-title` as the input value for a window title in any , the might encounter a run time error because the input value `*-title` is incorrect.

Ensure that you use valid regex patterns.

- 
- Optional: Select the **Resize window** option to specify the window dimensions.
-

This option delivers a more reliable bot. It resizes the window to the dimensions at which the task was recorded, which enhances the bot's ability to identify the target object.

- Click **Capture region** and select the area to capture.
- In the **Save captured text to a variable** field, select a string variable.

## Capture scrollable text action

The **Capture scrollable text** action enables you to capture scrollable text from the specified window.

### Settings

Captures scrollable text from the specified window.

- In the **Window** field, select an option: Choose from the **Application**, **Browser**, or **Variable** tab.
  - **Application**: Select from a list of windows, including browser windows, that are currently open on the device.
  - **Browser**: Select from a list of supported browser tabs.

---

**Note:** This option supports , Chromium-based , and browsers.

---

- **Variable**: Select an existing window variable to specify the title of the application window title.
- Insert a wildcard character (\*) in the **Window title** field to search for window titles that can change.

You can use a regular expression (regex) to identify a window title. Select the regular expression condition as either **String** or a **Pattern** and then enter the value. By default, the **Window title** field is case-sensitive.

To identify a browser title, you can enable the **Case sensitive** option to match the letter case, or disable the option to identify a window title where the letter case does not match.

---

**Note:** Ensure that the minimum version installed on your system is the version that was released with v.26. If you have a version released with v.25 or earlier, then by default, the window title will be identified only with matching letter case (case-sensitive).

---

For example, you can enter the **String** value as `( (\w*) -Notepad` for all window title names starting with `( (\w*) -Notepad`, or use **Pattern** value as `( (\w) \s) *document-Notepad` for only those window titles that match this pattern.

---

#### Note:

- When you use a regular expression of type **String** with `-title` as the input value for a window title in any , the might encounter a run time error. To prevent the run time error, ensure that when you add the string input as `*-title`, the application with the specific title is open. The asterisk (\*) is just a character, not a wild card character.
- When you use a regular expression of type **Pattern** with `-title` as the input value for a window title in any , the might encounter a run time error because the input value `*-title` is incorrect.

Ensure that you use valid regex patterns.

- 
- (Optional) Select the **Resize window** option to specify the window dimensions.  
This option delivers a more reliable . It resizes the window to the dimensions at which the task was recorded, which enhances the bot's ability to identify the target object.
  - Click **Capture coordinate** to capture the coordinates of the window or a specific control within the window.
  - In the **Save captured text to a variable** field, select a string variable.

---

**Note:** The PowerBuilder application is currently not supported.

---

## Capture text of window action

The **Capture text of window** action enables you to extract all the text from a window and saves it to a string variable.

### Settings

Extracts all the text from a window and saves it to a string variable.

- In the **Window** field, select an option: Choose from the **Application**, **Browser**, or **Variable** tab.
  - **Application:** Select from a list of windows, including browser windows, that are currently open on the device.
  - **Browser:** Select from a list of supported browser tabs.

---

**Note:** This option supports , Chromium-based , and browsers.

---

- **Variable:** Select an existing window variable to specify the title of the application window title.
- (Optional) Select the **Resize window** option to specify the window dimensions.  
This option delivers a more reliable . It resizes the window to the dimensions at which the task was recorded, which enhances the bot's ability to identify the target object.
- (Optional) Select the **Use legacy behavior (same as V11)** check box to capture text from a specific window when the Automation Launcher and the target application are running on two different user profiles.  
This feature ensures successful bot run by supporting the same application process run by two users. Also, with the introduction of this new option, the App Integration package supports 32-bit applications and replicates the functionality of Enterprise 11 in Automation 360 when capturing text from a window.
- In the **Save captured text to a variable** field, select a string variable.

## Application package

Use the **Open Program/File** action in the **Application** package to launch an application or a file. This action supports .exe, .bat, script files, or shortcut paths.

### Actions in the Application package

The **Application** package includes the following action:

Action	Description
Open program/file	See <a href="#">Open program/file action</a> on page 2428.

Related reference

[Application package updates](#) on page 846

Review the updates in released versions of the **Application** package such as new and enhanced features as well as fixes and limitations. The page also lists the release dates of each version, and the compatible **Control Room** and **Bot Agent** versions.

## Open program/file action

The **Open Program/File** action in the **Application** enables you to launch an application or a file.

### Settings

- Click **Browse** under the **Location of the program/file** field to specify the filepath of the application.

For example, if you want to launch the Google Chrome application, the location will be `C:\Program Files\Google\Chrome\Application\chrome.exe`.

---

**Note:** You can also enter the complete filepath in this field.

- Optional: In the **Start in path** field, enter the filepath of the working directory that you want to use.

If this is not specified, the current working directory of the calling process is used as the starting directory. However, if you want to specify a different starting directory, you can provide a valid path in the **Start in path** field. This is often used when you want to ensure that the operation has a specific working directory that might be different from the location of the calling program.

- Optional: In the **Parameters** field, specify the parameters or arguments you want to pass to the program.

For example, if you are using the command line, enter the arguments in this field.

---

**Note:** When you enter a filepath in the **Location of the program/file** or **Start in path** field and use a backslash (\) character to separate the filepath, the backslash (\) character is changed to forward slash (/) when you save the bot. To support multiple platforms, Automation 360 converts the filepath to a relative path, and the bot uses a forward slash (/) to separate the filepath.

The bots will continue to run successfully even when the backslash (\) is changed to a forward slash (/).

---

## AWS Comprehend NLP package

The AWS Comprehend NLP package contains actions that enable you to connect to and consume the Amazon Comprehend API to identify the language, sentiment, key phrases, and entities.

---

**Important:** This is a beta package and is currently not available with the Automation 360 Enterprise and Cloud editions.

---

### Before you start

You require the following information for an existing AWS account to use these actions:

- **Access key** and **Secret key:** Credentials that authenticate Automation 360 with your AWS account.  
See [Access Keys \(Access Key ID and Secret Access Key\)](#).
- **Region:** Specifies the AWS service endpoint.  
See [AWS Service Endpoints](#).

### Actions in the AWS Comprehend NLP package

Action	Description
<b>Detect language</b>	Identifies the language of the provided content and returns it in ISO 639-1 language code. The output is stored in a string variable. This action supports over 100 languages. For the full list, see <a href="#">Detect the Dominant Language</a> .
<b>Get key phrases</b>	Identifies the main points and returns a list of key phrases. For example, if the input text is about a basketball game, this action returns the names of teams, the name of the venue, and the final score.
<b>Get named entities</b>	Identifies the entities in the provided content such as people, places, organizations, date/time, quantities, branded products, and book titles.  The output is stored in a dictionary variable, where each name is a key, and the corresponding entity is the value.

Action	Description
<b>Get sentiment</b>	<p>Analyzes the provided content and returns the overall sentiment and scores for all possible sentiments. An example output of the dictionary values:</p> <pre>POSITIVE {Positive: 0.66238534, Negative: 0.0013064129, Neutral: 0.33621928, Mixed: 8.892125E-5}</pre> <p>The output is stored in a dictionary variable containing two keys and their corresponding values: <code>sentiment</code> and <code>score</code>.</p>

## Boolean package

The **Boolean** package contains actions that enable you to do various operations on boolean values.

### Actions in the Boolean package

The actions in the **Boolean** package accept a variable as an input and assign the output to a variable. These actions enable you to compare two boolean values, convert a boolean value to a string or numeric value, and convert a string value to a boolean value.

The **Boolean** package includes the following actions:

Action	Description
Assign	See <a href="#">Assign action in Boolean</a> on page 2431
Compare to	See <a href="#">Compare to action in Boolean</a> on page 2431
Equal to	See <a href="#">Equal to action in Boolean</a> on page 2432
Invert	See <a href="#">Invert action in Boolean</a> on page 2432
To number	See <a href="#">To number action in Boolean</a> on page 2432
To string	See <a href="#">To string action in Boolean</a> on page 2432

### Compare results for the Compare to action

The following table illustrates how two boolean values are compared using the **Compare to** action and their output:

Boolean value 1	Boolean value 2	Compare result
True	True	0
True	False	1
False	True	-1
False	False	0

## Compare results for the Equal to action

The following table illustrates how two boolean values are compared using the **Equal to** action and their output:

Boolean value 1	Boolean value 2	Equal result
True	True	<b>True</b>
True	False	<b>False</b>
False	True	<b>False</b>
False	False	<b>True</b>

Related reference

[Boolean package updates](#) on page 847

Review the updates in released versions of the Boolean package such as new and enhanced features as well as fixes and limitations. The page also lists the release dates of each version, and the compatible Control Room and Bot Agent versions.

## Assign action in Boolean

The Assign action in the Boolean package enables you to assign a constant value (True or False) or a user-defined value to a boolean value.

### Settings

- In the **Select the source boolean variable/value** field, select one of the following options:
  - **Constant values:** Enables you to assign a constant value (**True** or **False**).
  - **Variable value:** Enables you to assign a user-defined value to a boolean value.
- In the **Select the destination boolean variable** field, select a boolean variable to store the output.

## Compare to action in Boolean

The Compare to action in the Boolean package enables you to compare two Boolean values and assigns the output to a number variable.

### Settings

- In the **Select the first boolean variable** field, specify a boolean variable.
- In the **Select the second boolean variable** field, specify a boolean variable that the first boolean variable has to be compared with.
- In the **Assign the output to a number variable** field, select a variable to store the output.

## Equal to action in Boolean

The Equal to action in the Boolean package enables you to verify whether the two boolean values are equal or not, and assigns the output to a boolean variable.

### Settings

- In the **Select the first boolean variable** field, specify a boolean variable.
- In the **Select the second boolean variable** field, specify a boolean variable that the first boolean variable has to be compared with.
- In the **Select the boolean variable to store the result** field, select a variable to store the output.

## Invert action in Boolean

The Invert action in the Boolean package enables you to convert a boolean value to the opposite value (True to False and False to True), and assigns the output to a variable.

### Settings

- In the **Select the boolean variable to be inverted**, select the boolean value to convert. Choose from **False**, **True**, or a **Variable**.
- In the **Assign the output to** field, select a boolean variable to store the converted value.

## To number action in Boolean

The To number action in the Boolean package enables you to convert a boolean value to a numeric value. This action converts True to 1 and False to 0.

### Settings

- In the **Select boolean variable** field, select the boolean variable that you want to convert.
- In the **Assign the output to variable** field, select the number variable to store the converted value.

## To string action in Boolean

The To string action in the Boolean package enables you to convert a boolean value to a string value.

### Settings

- In the **Select boolean variable** field, select the boolean variable that you want to convert.



- In the **Assign the output to variable** field, select the number variable to store the converted value.

## Bot migration package

The **Bot migration** package enables you to migrate Enterprise 10 and Enterprise 11 bots to Automation 360 format. The package also enables you to convert Enterprise 10, Enterprise 11, or Automation 360 bots that use Internet Explorer to Microsoft Edge with IE mode. This package is used internally by the Bot Migration Wizard and the Update Bot wizard.

See [Supported Control Room versions for migration](#) on page 1506.

---

**Important:** We recommend that you use the Bot Migration Wizard to migrate Enterprise 11 or Enterprise 10 bots to Automation 360.

The **Bot migration** package does not migrate dependencies and other entities such as credential variables, AAAApplicationPath system variable, and global values that are required to run the migrated bot.

---

### Action in the Bot migration package

The **Bot migration** package includes the following action:

Action	Description
Migrate legacy bot	See <a href="#">Migrate legacy bot action</a> .
Update bot	See <a href="#">Update bot action</a> .

Related concepts

[Migrate to Automation 360](#) on page 1496

Migration (upgrade) is the process of moving your data and bots from Enterprise 11 or Enterprise 10 to Automation 360. Migration includes but is not limited to replicating and updating your existing database and repository, converting your bots to the Automation 360 format, and migrating learning instances for IQ Bot and dashboards for Bot Insight.

Related reference

[Bot Migration package updates](#) on page 848

Review the updates in released versions of packages such as new and enhanced features as well as fixes and limitations. The page also lists the release dates of each version, and the compatible Control Room and Bot Agent versions.

## Migrate legacy bot action in Bot Migration

The Migrate legacy bot action enables you to migrate the Enterprise 11 and Enterprise 10 bot files to Automation 360 format.

### Settings

Starting from Automation 360 v.24R2 release for IE EOL, the **Migrate bot** action is renamed as **Migrate legacy bot**.

This action only migrates the bot you specify, but does not migrate its dependencies. Dependencies are the bots and other files that are required to run the bot. You must migrate the dependent bots separately and upload other files manually to Control Room.

All the bots migrated using the **Bot migration** package are stored in the **Bots** folder in Automation 360. If you have to migrate a parent bot and its child bots separately using the **Bot migration** package, you must create the same folder structure as in Enterprise 11 or Enterprise 10 and move the dependent bots to these folders for the parent bot to run successfully.

- Use the **Control Room file**, **Desktop file**, or **Variable** tab to specify the location of the bot you want to migrate.
- In the **Output folder path** field, specify the location where you want to save the log files generated for the bot migration.

---

**Note:** Ensure that the location you have specified exists on the device.

---

The system does not upload the bot if it fails during the migration process. The system creates an XML report at the same location that provides information that helps you to troubleshoot if the system encounters an error during migrating the bot file.

- Select the **Overwrite the file if exists** check box to overwrite an existing bot file.
- Set a time-out value for migrating the bots within the range of 3 through 90 minutes (default value is 90 minutes).

If the migration of any specific bot is not completed within the set time, the bot will display a timeout message with the reason for the failure and the migration process will move on to the next bot.

- If you are migrating Enterprise 10 and Enterprise 11 bots that are built using Internet Explorer, select the **Convert bots built using Internet Explorer to Edge with Internet Explorer mode** option to convert them to Microsoft Edge with IE mode.

## Update bot action in Bot Migration

The **Update bot** action enables you to convert Automation 360 bots that are built using Internet Explorer browser to Microsoft Edge Chromium with IE mode.

### Settings

This action is internally used by the Update Bot wizard to convert the bots .

**Note:** This action cannot be used manually in a new or an existing bot for bot conversion.

- From the **Select task bot file** field, enter the name of the Task Bot file that you want to upload or select an existing used variable.
- From the **Select bot version to update** option, select either the latest version of the bot or the bot version that is provided on the production label.

## Browser package

The Browser package contains actions that enable you to download files, find broken links, and launch a website. This package supports Google Chrome, Chromium-based Microsoft Edge, and Internet Explorer browsers.

### Actions in the Browser package

The Browser package includes the following actions:

Action	Description
Call a JavaScript function	See <a href="#">Call a JavaScript function action</a> on page 2436
Close	See <a href="#">Close action</a> on page 2438
Download files	See <a href="#">Download file action</a> on page 2439
Find broken links	See <a href="#">Using Find broken links action</a> on page 2440
Get source code	See <a href="#">Get source code action</a> on page 2440
Go back	See <a href="#">Go back action</a> on page 2441
Open	See <a href="#">Open action</a> on page 2442
Run JavaScript	See <a href="#">Run JavaScript action</a> on page 2444

### Note:

- When you create a bot using the **Call a JavaScript** or **Run JavaScript** actions and want to execute the same Javascript you ran earlier using the **Run JavaScript** action, the bot displays an error.

To resolve this issue, see the workaround provided in [Call a JavaScript or Run JavaScript actions display an error \(A-people login required\)](#)

- When you perform any action from the Browser package on the Internet Explorer browser tab, if multiple tabs with the same tab title are opened in the same browser window, the matching title is not searched in sequence starting from the first tab. The tab activation and browser action might be performed on different matching tabs in this case.
- If the same tab title occurs on different windows, then the action is executed on a tab with a matching title in any window.

---

Related reference

[Browser package updates](#) on page 851

Review the updates in released versions of the Browser package such as new and enhanced features as well as fixes and limitations. The page also lists the release dates of each version, and the compatible Control Room and Bot Agent versions.

## Call a JavaScript function action

The Call a JavaScript function action in the Browser package enables you to call an existing JavaScript function directly in a webpage or in an iFrame within a webpage.

### Configure the settings

---

**Note:** This action supports Google Chrome and Chromium-based Microsoft Edge browsers.

---

1. Select the browser tab from the list of active supported browser tabs or insert a window variable.

You can use a regular expression (regex) to identify a window title. Select the regular expression condition as either **String** or a **Pattern** and then enter the value. By default, the **Window title** field is case-sensitive.

To identify a browser title, you can enable the **Case sensitive** option to match the letter case, or disable the option to identify a window title where the letter case does not match.

---

**Note:** Ensure that the minimum version installed on your system is the version that was released with v.26. If you have a version released with v.25 or earlier, then by default, the window title will be identified only with matching letter case (case-sensitive).

---

For example, you can enter the **String** value as `(\w*) -Notepad` for all window title names starting with `(\w*) -Notepad`, or use **Pattern** value as `(\w)\s*document-Notepad` for only those window titles that match this pattern.

---

**Note:**

- When you use a regular expression of type **String** with `-title` as the input value for a window title in any , the might encounter a run time error. To prevent the run time error, ensure that when you add the string input as `*-title`, the application with the specific title is open. The asterisk (\*) is just a character, not a wild card character.
- When you use a regular expression of type **Pattern** with `-title` as the input value for a window title in any , the might encounter a run time error because the input value `*-title` is incorrect.

Ensure that you use valid regex patterns.

- 
- Optional: Use the **Capture object** option to capture the iFrames.

---

**Note:** You can use the **Capture object** feature to call and run an existing JavaScript function inside an iFrame.

- 
- In the **Function name** field, specify the name of the existing JavaScript function that you want to call.
  - Optional: In the **Arguments** section, click **Add argument** to add arguments that must be passed to call the JavaScript function.
    - In the **Argument details** dialog box, select the **Argument type** required for the specific argument.
    - In the **value** field, enter the corresponding value or variable of the selected type that you want to pass.

---

**Note:** All string values in arguments are passed as is without any character being converted or escaped.

- 
- Optional: In the **Time out after** field, enter the number of seconds the bot must wait for the browser action to complete.

---

**Note:** Enter a timeout value of at least 9 seconds.

- 
- In the **Return Type** field, select the type of value returned by the JavaScript function.

---

**Note:** If the function does not return anything, in the **Return Type** field, select **None**.

- 
- For any **Return type** except **None**, in the **Save the outcome to a variable** field, select a variable for selected **Return type** to hold the JavaScript function output.

## Create variable

To create a variable for selected **Return type**, perform the following steps:

- Click the Create variable symbol next to the **Save the outcome to a variable** field.  
A **Create variable** dialog opens with default variable name for the type of variable selected.
- Optional: Specify the variable information in the **Description** field.
- Optional: Specify a value in the **Default value** field.
- Click **Create & select** to select the newly created variable.

## Supported JavaScript types in Argument and Return type fields

The following JavaScript types are supported:

- String, Number, and Boolean JavaScript types which correspond to the same variable types in bot variables.
- Array JavaScript type which corresponds to the List variable type in bot variables.
- Object JavaScript type which corresponds to the Dictionary variable type in bot variables.

## Close action

Use the Close action in the Browser package to close a browser window or tab.

## Settings

---

**Note:** This supports , Chromium-based , and browsers.

---

- Select to close the tab, window, or all browsers:
  - **Tab:** Closes the selected tab. Select the browser tab from the list of active supported browser tabs or insert a window variable.

You can use a regular expression (regex) to identify a window title. Select the regular expression condition as either **String** or a **Pattern** and then enter the value. By default, the **Window title** field is case-sensitive.

To identify a browser title, you can enable the **Case sensitive** option to match the letter case, or disable the option to identify a window title where the letter case does not match.

---

**Note:** Ensure that the minimum version installed on your system is the version that was released with v.26. If you have a version released with v.25 or earlier, then by default, the window title will be identified only with matching letter case (case-sensitive).

---

For example, you can enter the **String** value as `((\w*)-Notepad)` for all window title names starting with `((\w*)-Notepad)`, or use **Pattern** value as `((\w)\s)*document-Notepad` for only those window titles that match this pattern.

---

### Note:

- When you use a regular expression of type **String** with `-title` as the input value for a window title in any , the might encounter a run time error. To prevent the run time error, ensure that when you add the string input as `*-title`, the application with the specific title is open. The asterisk (\*) is just a character, not a wild card character.
- When you use a regular expression of type **Pattern** with `-title` as the input value for a window title in any , the might encounter a run time error because the input value `*-title` is incorrect.

Ensure that you use valid regex patterns.

---

- **Window:** Closes the window of the selected tab. Select the window from the list of active supported windows or insert a window variable.
-

You can use a regular expression (regex) to identify a window title. Select the regular expression condition as either **String** or a **Pattern** and then enter the value. By default, the **Window title** field is case-sensitive.

To identify a browser title, you can enable the **Case sensitive** option to match the letter case, or disable the option to identify a window title where the letter case does not match.

---

**Note:** Ensure that the minimum version installed on your system is the version that was released with v.26. If you have a version released with v.25 or earlier, then by default, the window title will be identified only with matching letter case (case-sensitive).

---

For example, you can enter the **String** value as `(\w*) -Notepad` for all window title names starting with `(\w*) -Notepad`, or use **Pattern** value as `(\w)\s)*document-Notepad` for only those window titles that match this pattern.

---

**Note:**

- When you use a regular expression of type **String** with `-title` as the input value for a window title in any , the might encounter a run time error. To prevent the run time error, ensure that when you add the string input as `*-title`, the application with the specific title is open. The asterisk (\*) is just a character, not a wild card character.
- When you use a regular expression of type **Pattern** with `-title` as the input value for a window title in any , the might encounter a run time error because the input value `*-title` is incorrect.

Ensure that you use valid regex patterns.

- 
- **All browsers:** Closes all open browser windows for supported browsers.
  - Optional: In the **Time out after** field, enter the number of seconds the bot must wait for the browser window or tab to close before the bot fails.
- 

**Note:** Enter a timeout value of at least 9 seconds.

---

## Download file action

The Download file action in the Browser package downloads and saves a file from the specified URL that might require NTLM authentication.

---

**Note:** This action downloads only a single file to the specified file location.

---

## Settings

- Specify the **URL of the file** you want to download.
- In the **Save to location** field, enter the location where you want to save the file.

## Using Find broken links action

The **Find broken links** action finds broken links on a specific page or website, stores the output to a CSV file. Optionally, you can specify encoding for the output data.

Follow these steps to find broken links:

1. In the **Actions** palette, double-click or drag the **Find broken links** action from the **Browser** package.
2. In the **Page or URL** field, enter the URL of the page or website.
3. In the **Scope** option, choose either **check only this page** or **check the whole site**.
4. In the **Save list to location** field, specify the location of the CSV file.
5. Select the **Append to already existing csv file** check box if you want to append the data to an existing CSV file.
6. Select an option from the **Encoding** list to specify the encoding that you want to apply on the file.
  - **ANSI**
  - **Unicode**
  - **UTF-8**
7. In the **Number of parallel threads** field, enter the number of parallel threads you want to run simultaneously.

Parallel threads means multiple processes running simultaneously to perform the same task which results in faster execution. Higher the number of parallel threads faster the execution of a task execution. For example, if 10 threads complete a task in two minutes, 20 threads complete a task in one minute.

---

**Note:** The maximum value you can provide in the field is 99.

---

8. In the **Time out** field, specify the maximum time the system must wait to receive a response from each URL link.
9. Click **Save**.

## Get source code action

The **Get source code** action retrieves the source code of a web page and an iFrame on a web page and saves the output to a string variable.

### Settings

---

**Note:** This supports , Chromium-based , and browsers.

---

- Select the browser tab from the list of active supported browser tabs or insert a window variable.
  - Optional: Use the **Capture object** option to capture the iFrames.
- 

**Note:**

- The **Capture object** feature is used only to retrieve the source code of an iFrame. If you do not capture anything on the window, the source code of the entire window is retrieved.



- Retrieving the source code of an iFrame is currently supported only on the Google Chrome browser.

- 
- Optional: In the **Time out after** field, enter the number of seconds the must wait for the browser action to complete.
- 

**Recommended:** Enter a timeout value of at least 9 seconds.

---

- Optional: Select a variable to hold the output. The shows a descriptive default variable name. If you create several output variables, subsequent variable names are appended with a -1, -2, -3, and so on to avoid duplication.

## Go back action

The **Go back** action returns to a web page previously visited in the current tab. This action simulates clicking the browser **Back** option.

## Settings

---

**Note:** This supports , Chromium-based , and browsers.

---

- Select the browser tab from the list of active supported browser tabs or insert a window variable.

---

**Note:** When you select the Internet Explorer tab from the list of active tabs, and if the selected tab title or any intermediate tab title while performing the **Go back** action has more than 60 characters, then the first 60 characters are used for comparison to find the matching tab title.

---

**Recommendation:** When you perform the action on the browser tab, ensure that only a single tab is open in the browser window with the matching tab title. This setting ensures that when the action is executed, there is no intermediate tab title that matches another tab title in the same window.

---

- In the **Number of steps back** field, enter the number of pages to go back to.
- **Optional:** Select the **Throw an error if steps exceed history** option so that the bot will fail if the number entered in the previous step is greater than the number of pages visited.  
If this option is not selected, when the bot runs, it will return the tab to the first web page it opened.
- Optional: In the **Time out after** field, enter the number of seconds the must wait for the browser action to complete.

---

**Recommended:** Enter a timeout value of at least 9 seconds.

---

## Open action

The **Open** action opens the browser to a specific web page.

### Using network path URLs

When you use network path URLs, you might encounter bot errors in the following scenarios:

- When you open a network file path using the **New tab**, **Existing tab**, or **New window** option in the Internet Explorer browser.
- When you open a network folder path using the **Existing tab** option in the Internet Explorer or Chromium (Google Chrome or Microsoft Edge) browsers.

To fix these errors with network file or folder path, perform one of the following steps as required:

- For network file path, select a Chromium browser (Google Chrome or Microsoft Edge) in the action.
- For network folder path, select a Chromium browser (Google Chrome or Microsoft Edge) in the action with **New tab** or **New window** option.

## Settings

---

### Note:

- This action is used only to open a URL in the browser. You cannot download a file using this action.
  - This action does not support InPrivate or Incognito mode of browsers.
- 

- Select to open the web page in an existing tab, new tab, or new window:
    - **Existing tab**: Opens the web page on a currently open tab. Select the tab from the list of active supported browser tabs, the **Last used browser tab** option, or insert a window variable.
- 

**Note:** This option supports , Chromium-based , and browsers.

---

You can use a regular expression (regex) to identify a window title. Select the regular expression condition as either **String** or a **Pattern** and then enter the value. By default, the **Window title** field is case-sensitive.

To identify a browser title, you can enable the **Case sensitive** option to match the letter case, or disable the option to identify a window title where the letter case does not match.

---

**Note:** Ensure that the minimum version installed on your system is the version that was released with v.26. If you have a version released with v.25 or earlier, then by default, the window title will be identified only with matching letter case (case-sensitive).

---

For example, you can enter the **String** value as `((\w*) -Notepad` for all window title names starting with `((\w*) -Notepad`, or use **Pattern** value as `((\w) \s) *document-Notepad` for only those window titles that match this pattern.

---

**Note:**

- When you use a regular expression of type **String** with `-title` as the input value for a window title in any , the might encounter a run time error. To prevent the run time error, ensure that when you add the string input as `*-title`, the application with the specific title is open. The asterisk (\*) is just a character, not a wild card character.
- When you use a regular expression of type **Pattern** with `-title` as the input value for a window title in any , the might encounter a run time error because the input value `*-title` is incorrect.

Ensure that you use valid regex patterns.

- 
- **New tab:** Opens the web page on a new tab. Select the tab from the list of active supported browser tabs or insert a window variable.

---

**Note:**

- This option supports Google Chrome, Chromium-based Microsoft Edge, and the Internet Explorer browsers.
- When you perform the action on the Internet Explorer tab, the action is executed in the matching tab only when it is in ready state.

---

You can use a regular expression (regex) to identify a window title. Select the regular expression condition as either **String** or a **Pattern** and then enter the value. By default, the **Window title** field is case-sensitive.

To identify a browser title, you can enable the **Case sensitive** option to match the letter case, or disable the option to identify a window title where the letter case does not match.

---

**Note:** Ensure that the minimum version installed on your system is the version that was released with v.26. If you have a version released with v.25 or earlier, then by default, the window title will be identified only with matching letter case (case-sensitive).

---

For example, you can enter the **String** value as `((\w*) -Notepad` for all window title names starting with `((\w*) -Notepad`, or use **Pattern** value as `((\w) \s) *document-Notepad` for only those window titles that match this pattern.

---

**Note:**

- When you use a regular expression of type **String** with `-title` as the input value for a window title in any , the might encounter a run time error. To prevent the run time error, ensure that when you add the string input as `*-title`, the application with the specific title is open. The asterisk (\*) is just a character, not a wild card character.
- When you use a regular expression of type **Pattern** with `-title` as the input value for a window title in any , the might encounter a run time error because the input value `*-title` is incorrect.

Ensure that you use valid regex patterns.

- **New window:** Opens the web page on a new window of a specific browser.

Select the browser from the following options:

- Default Browser

Ensure that Google Chrome, Microsoft Edge or Internet Explorer is set as the default browser.

---

**Note:** If any browser that is not listed is set as the default browser for the device, the bot might encounter an error.

---

- Google Chrome
- Internet Explorer
- Microsoft Edge
- Mozilla Firefox

- Enter the link to the web page to open.

---

**Note:** For web pages to open properly, we recommend that you specify a URL with the protocol information, such as http, https, or file.

---

- Optional: In the **Time out after** field, enter the number of seconds the bot must wait for the specified webpage to load before the bot fails.

---

**Note:**

- You can enter a timeout value of at least 9 seconds.
  - Timeout value is applicable only for the **New tab** and **Existing tab** options.
  - For the Internet Explorer browser, the bot executes even if the webpage is not loaded completely after waiting till timeout.
- 

## Run JavaScript action

The **Run JavaScript** action in the Browser package executes JavaScript on a web page and on web pages that have iFrames.

### Settings

---

**Note:**

- This action supports Google Chrome and Chromium-based Microsoft Edge browsers.
  - When you use this action to execute a JavaScript that contains a single-line comment as the last line of the JavaScript (for example, `//comment`), it can cause the Automation Anywhere plugin to become unstable. We recommend that you either remove the comment at the end of the JavaScript or convert it to a multi-line comment (for example, `/* comment */`).
- 

- Select the browser tab from the list of active supported browser tabs or insert a window variable.

You can use a regular expression (regex) to identify a window title. Select the regular expression condition as either **String** or a **Pattern** and then enter the value. By default, the **Window title** field is case-sensitive.

To identify a browser title, you can enable the **Case sensitive** option to match the letter case, or disable the option to identify a window title where the letter case does not match.

---

**Note:** Ensure that the minimum version installed on your system is the version that was released with v.26. If you have a version released with v.25 or earlier, then by default, the window title will be identified only with matching letter case (case-sensitive).

---

For example, you can enter the **String** value as `(\w*) -Notepad` for all window title names starting with `(\w*) -Notepad`, or use **Pattern** value as `(\w)\s)*document-Notepad` for only those window titles that match this pattern.

---

**Note:**

- When you use a regular expression of type **String** with `-title` as the input value for a window title in any , the might encounter a run time error. To prevent the run time error, ensure that when you add the string input as `*-title`, the application with the specific title is open. The asterisk (\*) is just a character, not a wild card character.
- When you use a regular expression of type **Pattern** with `-title` as the input value for a window title in any , the might encounter a run time error because the input value `*-title` is incorrect.

Ensure that you use valid regex patterns.

---

- Choose one of the following options:
  - In the **Import existing file** option, select an existing file.

---

**Note:** If you are uploading a script from a file on your desktop, the file and any dependencies must be in a standalone folder. When you select a file for upload, all files and folders at the same folder level are uploaded.

---

- In the **Manual input** option, enter the .
  - Optional: Use the **Capture object** option to capture the iFrames.
- 

**Note:**

- The **Capture object** feature is used only to run JavaScript inside an iFrame.
  - Support to run JavaScript inside an iFrame is available only for the Google Chrome browser.
- 

The following object properties are selected by default when capturing IFrames:

- **Browser type**
  - **Technology type**
  - **Control type**
  - **HTML tag**
  - **DOMXPath**
  - **HTML HasFrame**
  - **HTML FramePath**
  - **FrameDOMXPath**
-

- **Path**
  - **Role**
  - **HTML FrameSrc**
- Optional: In the **Time out after** field, enter the number of seconds the must wait for the browser action to complete.

---

**Recommended:** Enter a timeout value of at least 9 seconds.

---

- Optional: In the **Save the outcome to a variable** field, select a variable to hold the action output. The Control Room shows a descriptive default variable name. If you create several output variables, subsequent variable names are appended with a -1, -2, -3, and so on to avoid duplication.

---

**Note:** This action supports String, Number, and Boolean JavaScript types which correspond to the same variable types in bot variables, or to the bot variable type Any.

---

---

**Recommendation:**

- Do not use JQuery with the JavaScript package.
- Use the **Try/Catch** actions from the Error handler in the JavaScript function.
- Call a JavaScript function before declaring it.

---

Watch the following video on using the Run JavaScript action from the Browser package to execute JavaScript directly within an existing browser window:

## Automating object-based applications

We recommend that you use the Recorder for object-based automations instead of Run JavaScript action. If you use Run JavaScript action to automate dynamic web pages and if there is a change in control hierarchy or properties, then you must re-write the entire script. Use the Run JavaScript action only to execute external scripts in any application.

You can use the Recorder to automate applications using other available technologies if you are unable to capture using the default HTML technology. Ensure that the accessibility for your application is enabled and is not blocked by any company policy before you use a different technology to automate. We recommend you open Google Chrome with the flag `--force-renderer-accessibility`.

**Accessibility Internals**

Use this page to inspect the internal representation of accessibility in Chrome. You can see and modify the various accessibility modes Chrome has. You can also view the accessibility tree for a specific page, or for the Chrome app natively.

**Accessibility modes:**  
Check/uncheck accessibility modes to see how they change a page's accessibility.

- Native accessibility API support  
Allows Chrome to be controlled via native accessibility APIs specific to this platform.
- Web accessibility  
Accessibility support is enabled for web content.
- Text metrics  
Enables support for querying line breaks and the bounding box of arbitrary character ranges.
- Screen reader support  
Exposes accessibility APIs typically needed only by screen readers.
- HTML  
Exposes HTML tag names and attributes via accessibility APIs.

**Accessibility tree viewing options:**

- Internal  
Show internal accessibility tree instead of native

**Filters:**  
Use filters to match the attributes and attribute values you want included in the output. Filters can contain simple wildcards (\*) only, they're not regular expressions. Attributes are separated by spaces.

Allow:   
Include these attributes. Empty attributes are skipped.

Allow empty:   
Include these attributes, even if they are empty.

Deny:   
Exclude these attributes.

**Command line options:**  
Accessibility features in Chrome are off by default and enabled automatically on-demand. Changes to these modes only take effect until the next time Chrome is restarted.

To force accessibility to be enabled at launch, run Chrome with this flag:  
`--force-renderer-accessibility`

To disable accessibility, run Chrome with this flag:  
`--disable-renderer-accessibility`

Related information

[Executing a JavaScript function on Chrome \(A-People login required\)](#)

## Clipboard package

The Clipboard package contains actions that enable you to automate using the Windows clipboard. Use the actions to copy a string value to the clipboard, copy the clipboard value to a string variable, and clear the clipboard.

### Actions in the Clipboard package

The Clipboard package includes the following actions:

Action	Description
Clear	See <a href="#">Clear action in Clipboard</a> on page 2448.
Copy from	See <a href="#">Copy from action in Clipboard</a> on page 2448.
Copy to	See <a href="#">Copy to action in Clipboard</a> on page 2448.

Related reference

[Clipboard package updates](#) on page 852

Review the updates in released versions of the Clipboard package such as new and enhanced features as well as fixes and limitations. The page also lists the release dates of each version, and the compatible Control Room and Bot Agent versions.

## Clear action in Clipboard

The **Clear** action in the Clipboard package enables you to clear the clipboard.

### Settings

This action will remove any value that is stored in the clipboard.

## Copy from action in Clipboard

The **Copy from** action in the Clipboard package enables you to retrieve the values stored in the clipboard.

### Settings

This action enables you to retrieve the values stored in the clipboard and store it in the string variable that you select from the **Assign the output to variable** list. This action also enables you to pass the value from the clipboard to other actions.

## Copy to action in Clipboard

The **Copy to** action in the Clipboard package enables you to store values in the clipboard.

### Settings

You can either enter the value or specify the string variable that contains the value in the **Value** field.

## Credential package

In the Credential package, use the **Assign** action to assign an insecure string or a variable value directly to the credential variable.

### Actions in the Credential package

The Credential package includes the following action:

---

#### Note:

- The credential variables support the retry mechanism. When you create a bot that uses credential variables, if the bot fails during run time to retrieve those variables from the Credential Vault because the Control Room is disconnected or the Control Room services



stop intermittently, then the bot tries three times to retrieve the credential variables from the Credential Vault.

- While the **Convert credential to string** action is listed on the Credential package details page, it is not available for use from the actions list in the Bot editor. This is because the action should be used only for migration and not for other scenarios because it introduces a security risk.

Action	Description
Assign	<p>Sets the value of a credential variable.</p> <ul style="list-style-type: none"> <li>• You can select <b>Credential</b> to use a value from the Credential Vault, <b>Variable</b> to use a credential variable, or <b>Insecure string</b> to manually enter a variable.</li> <li>• In the <b>Save the outcome to a variable</b> field, select a variable to hold the returned value.</li> </ul>

Related reference

[Credential package updates](#) on page 855

Review the updates in released versions of the Credential package such as new and enhanced features as well as fixes and limitations. The page also lists the release dates of each version, and the compatible Control Room and Bot Agent versions.

## CSV/TXT package

The **CSV/TXT** package contains actions that enable you to open a CSV or text file, read data from that file, and assign the data to a Table variable. This package supports files encoded in ANSI, Unicode, UTF-8, or Windows-1251, and can process up to one million records.

Perform the following actions within the **CSV/TXT** package as part of using the set of available actions:

1. Open the file to be used in the automation. See [Using the Open action for CSV/TXT file](#) on page 2450.

---

**Note:** For files containing large data sets, use actions from the Database package to automate create, read, and update operations. See [Using Connect action for database](#) on page 2469.

---

2. Use the **Read** action to retrieve values from a CSV or TXT file and store them in a Table variable. See [Using Read action](#) on page 2451.

To retrieve values row by row, use the **For each row in CSV/TXT** iterator in the Loop action to read values from each row in the file and assign it to a record variable. See [Using the For each row in CSV/TXT iterator](#) on page 2795.

---

**Note:** The **Read** action and **For each row in CSV/TXT** iterator only support CSV/TXT files that conform to the RFC 4180 standard. For more information about the standard, see [Common format and MIME type for CSV files](#).

---

3. After you have automated the CSV/TXT-related tasks, close the file using the **Close** action. Enter the session name that was used to open the file with the **Open** action.

Related reference

[Loop package](#) on page 2784

Use the Loop package to run a sequence of actions repeatedly for a specific number of times or until a specific condition is met.

[Your variables \(user-defined\)](#) on page 2331

Users and some actions create user-defined variables to temporarily hold values. Use this kind of variable to input values into an action (window title, login credential, or file path) or to accept the output of an action (values read from a file or a Boolean return).

[CSV/TXT package updates](#) on page 856

Review the updates in released versions of the CSV/TXT package such as new and enhanced features as well as fixes and limitations. The page also lists the release dates of each version, and the compatible Control Room and Bot Agent versions.

## Using the Open action for CSV/TXT file

This action enables you to specify the delimiter used in the file, whether to trim the spaces, and the encoding applied on the file.

---

**Note:** If there is a double quotation mark (") in the last element of the last line of the CSV/TXT file, at runtime the bot will encounter an error.

---

To open a CSV or text file, do the following:

1. Double-click or drag the **Open** action from the **CSV/TXT** package in the **Actions** palette.
2. Select any of the following options to specify the location of the CSV or text file to open:
  - **Control Room file:** Enables you to open a file from the .
  - **Desktop file:** Enables you to open a file from the device. This field also accepts the file path input as a string variable or global value.

---

**Note:** When you enter a file path in the **Desktop file** field or browse a particular file from the system, wherein the file path is separated by the \ character and save the , the \ character is changed to / as the uses / to separate file paths. Your continue to run successfully even if the \ is changed to / during execution.

---

- **Variable:** Enables you to open a file by specifying a file variable.
3. Select the **Contains header** check box if the file contains a header row and you want to retrieve values from that row.
  4. Select any of the following options to specify the **Delimiter** used in the file:
    - **Comma**
    - **Tab**
    - **Regional list separator:** Enables you to specify the delimiter as configured in the regional settings of the Windows operating system. If the **List Separator** in the Windows regional settings is modified, then the CSV file should also contain that character as a delimiter.
    - **Newline**
    - **Other:** Enables you to specify a delimiter other than the options listed above.

5. Select the **Trim leading** and **Trim trailing** check boxes to remove the leading and trailing spaces from the data extracted from the CSV/TXT file
6. Select an option from the **Encoding** list to specify the encoding that is applied on the file. Data from the CSV/TXT file will be retrieved based on the selected encoding option even if the input file has a different encoding.
  - **ANSI**: Used to encode Latin alphabet.
  - **UTF8**: Can encode all possible characters.
  - **UNICODE**
  - **Win1251**: used to encode languages that use the Cyrillic script, including Bulgarian, Russian, and Serbian.
  - **UTF-16LE**: ignores the byte order mark (BOM) Unicode character at the beginning of file.
  - **Default**: identifies file encoding. This option supports UTF-8, UTF-16LE, and UTF-16BE file encoding.

---

**Note:** Shift-JIS files must use **ANSI** as encoding to read text file content.

---

7. Click **Save**.

Use the **Read** action to retrieve the data from CSV/TXT file and assign them to a table variable. You can use the loop action to retrieve each row of data from the file or table variable and assign them to the record variable for further operations.

- [Using Read action](#) on page 2451
- [Using the For each row in CSV/TXT iterator](#) on page 2795

## Using Read action

Use the **Read** action to retrieve values from a CSV or TXT file, and insert them into a Table variable to perform operations with the data values.

---

### Note:

- The **Read** action only support CSV/TXT files that conform to the RFC 4180 standard. For more information about the standard, see [Common format and MIME type for CSV files](#).
- When you use the **Read** action to read data from a CSV or TXT file that contains double quotes, the bot might display an error message: `Unable to read the file and create a table`. We recommend that you replace all double quotes with an empty or a blank character.

---

To retrieve values from a CSV or TXT file, do the following:

1. Double-click or drag the **Read** action from the **CSV/TXT** node in the **Actions** palette.
2. Enter the name of the session that you have used to open the CSV or text file in the **Open** action.
3. Select a Table variable from the **Assign value to the variable** list.  
Create a variable if it does not already exist. The shows a descriptive default variable name. If you create several output variables, subsequent variable names are appended with a -1, -2, -3, and so on to avoid duplication.

---

**Note:** A bot can return only a maximum of 3 MB to an output variable.

Workaround: Store the bot output on the device, such as in a .txt file. If the output must be shared across multiple Bot Runners, store the output in a shared drive.

Perform operations with the values in the Table variable using the [Data Table package](#) on page 2452.

## Comment package

Use the `Comment` package to insert a user-specified comment into your bot logic.

### Action in the Comment package

The `Comment` package includes the following action:

Action	Description
Comment	<p>Inserts a comment.</p> <hr/> <p><b>Note:</b> A comment is saved and displayed as a single line. A comment with multiple lines is displayed as a single line, followed by an ellipsis when the comment is saved. Comments are ignored when the bot runs.</p> <hr/>

Related reference

[Comment package updates](#) on page 854

Review the updates in released versions of the `Comment` package such as new and enhanced features as well as fixes and limitations. The page also lists the release dates of each version, and the compatible Control Room and Bot Agent versions.

## Data Table package

The Data Table package contains actions that enable you to perform various operations on the values of table variables. Use these actions to join or merge content, search for specific values, insert rows and columns, remove duplicate rows, and write values to a file.

### Actions in the Data Table package

The Data Table package includes the following actions:

**Note:** If you built a bot using actions from the Data Table package from Build 5322 or earlier, the actions will be missing when you open the bot with the default package version. You must reinsert the actions and repopulate the fields.

Action	Description
Assign	<a href="#">Assign action</a> on page 2454.

Action	Description
Change column type	<a href="#">Change column type action</a> on page 2454.
Clear content	<a href="#">Clear content action</a> on page 2455.
Delete column	<a href="#">Delete column action</a> on page 2455.
Delete row	<a href="#">Delete row action</a> on page 2455.
Get number of columns	<a href="#">Get number of columns action</a> on page 2456.
Get number of rows	<a href="#">Get number of rows action</a> on page 2456.
Insert column	<a href="#">Insert column action</a> on page 2456.
Insert row	<a href="#">Insert row action</a> on page 2458.
Join	<p><a href="#">Using Join action</a> on page 2459.</p> <p>Use the <a href="#">Join type output examples</a> on page 2460 to help you decide whether to use the <b>Join</b> or <b>Merge</b> action.</p> <hr/> <p><b>Note:</b> If you built a bot using this action from package version 2.0.0-20200624-042148 or earlier, the action will be missing when you open the bot with the default package version. You must reinsert the action and repopulate the fields.</p> <hr/>
Merge	<p><a href="#">Using the Merge action</a> on page 2462.</p> <p>Use the <a href="#">Merge output example</a> on page 2462 to help you decide whether to use the <b>Join</b> or <b>Merge</b> action.</p> <hr/> <p><b>Note:</b> If you built a bot using this action from package version 2.0.0-20200624-042148 or earlier, the action will be missing when you open the bot with the default package version. You must reinsert the action and repopulate the fields.</p> <hr/>
Remove duplicate rows	<a href="#">Remove duplicate rows action</a> on page 2464.
Search for a value	<a href="#">Search for a value action</a> on page 2464.
Set value of a single cell	<a href="#">Set value of a single cell action</a> on page 2465.
Sort	<a href="#">Sort action</a> on page 2465.
Write to file	<a href="#">Using Write to file action</a> on page 2465.

**Example:** [Example of extracting data from a web table](#) on page 3201

Related reference

[Data Table package updates](#) on page 858

Review the updates in released versions of the Data Table package such as new and enhanced features as well as fixes and limitations. The page also lists the release dates of each version, and the compatible Control Room and Bot Agent versions.

## Assign action

The **Assign** action in the Data Table package enables you to assign values to a table variable.

### Settings

You can use this action to manually enter the table data.

- Use the **Source data table** field to select one of the following options:
  - **Table with values:** select one of the following tabs:
    - **Table:** Click **Edit table (1X1)** button to manually add rows and columns.
    - **Variable:** To select a source table variable.

Consider a scenario where you want to change or update some data in an existing database. In order to ensure you do not lose the original data, you can store the existing values as a temporary Datatable variable. You can then use the **Assign** action to create a temporary or duplicate Datatable for making changes.

- **Table with no values:** update the following fields:
  - **Number of rows:** enter the number of rows that you want to assign to the table.
  - **Number of columns:** enter the number of columns that you want to assign to the table.
- Click the **Save the outcome to a variable** drop-down to select a table variable to hold the output.

You can either select the source table variable to overwrite the values, or select a different table variable.

## Change column type action

The Change column type action in the Data Table package enables you to change the data type of a column.

### Settings

- Select the data table name from the drop-down list.
- Select whether to specify the column by **Name** or **Index**.
  - If you select to specify by name, enter the column name.
  - If you select to specify by index, enter the column index. For example, to set a value to the first column, enter 0.
- Select the new column data type from the drop-down list to **Number**, **Boolean**, **String**, or **Datetime**.

- If you select **Datetime**, you can format the values by selecting a predefined format or specifying a custom format.
- To specify the format applied on the input data table variable, select an option either from the predefined format list or enter the value in a custom format.
- Select a table variable to include the output.  
You can either select the source table variable to overwrite the values or select a different table variable.

## Clear content action

The Clear content action in the Data Table package enables you to clear the contents of the specified table variable.

### Settings

This action clears the content until the execution of the bot is completed. After the bot execution is completed, the original values of the table variables are restored.

This action enables you to reuse an existing table variable to store values that are used only during the bot execution.

---

**Note:** The data type of the values must be same as the data type of the columns in the table variable.

---

## Delete column action

The Delete column action in the Data Table package enables you to delete a specific column.

### Settings

- Select the Table variable name from the drop-down list.
- Specify the column name or column index to delete.

---

**Note:** The index count starts from 0.

---

## Delete row action

The Delete row action in the Data Table package enables you to delete a specific row.

### Settings

---

**Note:** If the data table values were read from an Excel sheet, and you selected the **Sheet contains a header** option in the **Open** action, you cannot delete cells from the first row.

---

- Select the Table variable name from the drop-down list.

- Specify the row name or row index to delete.

---

**Note:** The index count starts at 0.

---

## Get number of columns action

The Get number of columns action in the Data Table package enables you to retrieve the number of columns from a table.

### Settings

Retrieves the number of columns and assigns it to a Number variable. You have the option to select the non-empty columns or include all the columns in the selection.

## Get number of rows action

The Get number of rows action in the Data Table package enables you to retrieve the number of rows from a table.

### Settings

Retrieves the number of rows and assigns it to a Number variable. You have the option to select the non-empty rows or include all the rows in the selection.

## Insert column action

The Insert column action in the Data Table package enables you to insert a column from one table to another table. The Insert column action in the Data Table package enables you to insert a column from one table to another table or insert a custom column of a specified data type to the destination table.

### Settings

- In the **Destination table** field, select the destination data table in which you want to enter the data.
- Select where you want to insert the column: **first index**, **last index**, or **specific index**.

---

**Note:** If you selected **specific index**, then enter the index number where you want to insert the column.

---



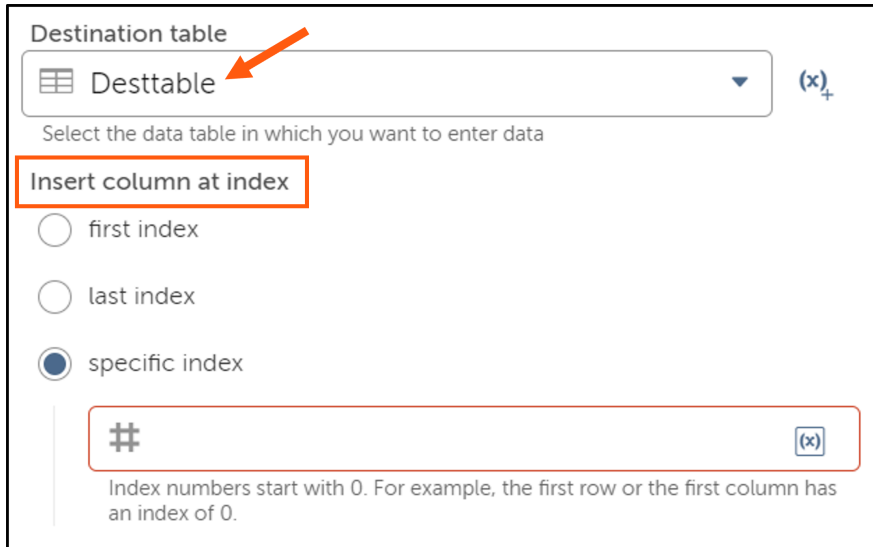

Destination table

Desttable (x)<sub>+</sub>

Select the data table in which you want to enter data

**Insert column at index**

first index

last index

specific index

# (x)

Index numbers start with 0. For example, the first row or the first column has an index of 0.

- From the **Insert column** option, select one of the following options:
  - **From source table**: Select to enter data from another table to the destination table.
  - **Custom column**: Select to insert an empty column or a column with specified data to the destination table.

---

**Note:** You can add only one custom column at a time.

---

- If you selected the **From source table** option, then perform the following steps:
  - In the **Enter data from** field, select a source table from which you want to enter

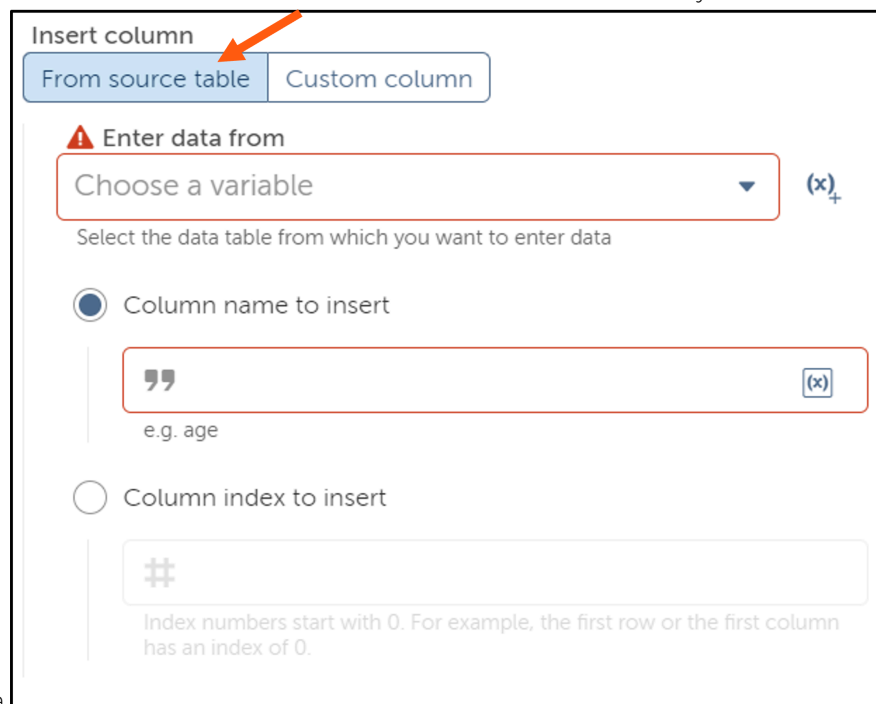

Insert column

From source table Custom column

**Enter data from**

Choose a variable (x)<sub>+</sub>

Select the data table from which you want to enter data

Column name to insert

” (x)

e.g. age

Column index to insert

#

Index numbers start with 0. For example, the first row or the first column has an index of 0.

- data
- Enter the name or index number of the column that you want to insert from the source table.

**Note:** The index count starts at 0.

- If you have selected the **Custom column** option, then perform the following steps:
  - In the **Column name** field, specify the name of the column that you want to

The screenshot shows the 'Insert column' configuration window. At the top, there are two tabs: 'From source table' and 'Custom column'. An orange arrow points to the 'Custom column' tab. Below the tabs, there are three main sections:
 

- Column name (optional):** A text input field containing 'Address' and a clear button '(x)'. Below the field is the text 'eg. age'.
- Column type:** A dropdown menu currently showing 'String'.
- Default value (optional):** A text input field containing 'Bangalore' and a clear button '(x)'. Below the field is the text 'Default value will be set for all rows in the new column'.

- insert.
- In the **Column type** field, specify the data type of the column that you want to insert.

**Note:**

- String, Number, Boolean, and Datetime data types are supported.
  - In the **Column type** field, if you select Datetime as the datatype, the default value will be empty. If you run the bot with an empty value in the Datetime variable field, the action uses the current system date and time by default and then inserts that date and time in the Data Table.
- 
- In the **Default value** field, specify the value that you want to display in each row of the new column.

See [Example of using Custom column option in Data Table package](#) on page 3278 on how to use the Insert column action.

## Insert row action

The **Insert row** action enables you to insert a row into the table.

### Settings

- Click the **Data table name** drop-down menu and select a data table.
  - If there is no existing data table, create a new variable of type **Table**.
- Use the **Insert row at index** field to select one of the following positions in the data table for inserting the row:
  - **first position:** to insert a row in the first index.

- **last position**: to insert a row in the last index
- **specific index**: to insert a row in the specific index.

Index refers to the specific row or column in the data table, and starts from 0. For example, index = 0 refers to the first row in the data table.

- Click the **Row record name** drop-down menu and choose an existing record variable to hold the values for the new row that you want to insert.

If there is no existing variable, create a record variable. In the **Create variable** tab, enter the name of the variable and under the **Default value** section, enter the name, value, and the type of value that you want to add to the new row as per the specified index values.

---

**Note:** A DataTable variable is created with one row and one column (1x1) by default. This default value is retained along with the row data that you added using the **first position, last position** or **specific index** option.

---

Consider a scenario where you want to insert a row record named 'March' at the beginning of a data table called 'Sales'.

1. Click the **Data table name** drop-down menu and select Sales.
2. Under the **Insert row at index** field, select **first position**.
3. Click the **Row record name** drop-down menu and select March.
4. Click **Save**.

## Using Join action

Use the **Join** action to combine content from two table variables. This action enables you to combine content based on the shared values of a specific column in the tables and store the content into a third Table variable or one of the two source tables.

To join the content from two Table variables, do the following:

1. Double-click or drag **Data table > Join**.
2. Select the first Table variable to use from the **Enter first data table name** list.
3. Enter the name of the column from the first Table variable that contains the data to join.
4. Select the second Table variable to use from the **Enter second data table name** list.
5. Enter the name of the column from the second Table variable that contains the data to join.
6. Select an option to specify the type of join. For more information, see [Join type output examples](#) on page 2460.
  - **inner join**: Returns only the records that have matching values in the selected columns in both tables.
  - **left outer join**: Returns all records from the first table, and the matched records from the second table.
  - **right outer join**: Returns all records from the second table, and the matched records from the first table.
  - **full outer join**: Returns all records when there is a match in either left or right table.
7. In the **Enter name of data table in which to join** field, select the table variable to store the combined values.

**Note:**

- Starting from Automation 360 v.27 if you are using 4.6.0-20220920-155212 version of the Data Table package, the **Enter name of data table in which to join** field is mandatory and you must specify a third data table in the field to save the result of the Join action.
- When you upgrade from a previous version to Automation 360, and if you have not updated the package version to 4.6.0-20220920-155212, your bots will continue to run as is. In case you have updated both your bots and the package to the latest version, your bots will continue to run successfully if you have selected a table variable to store the output. If the field is empty, then the bot will encounter an error.

**Join type output examples**

Select a join type option based on your desired output. Use the examples below to guide your selection.

**Inner join**

Returns only the records that have matching values in the selected columns in both tables.

For example, if you have a table of employees and their departments, and a table of employees and their pay rates, this option will return a table of the employees that exist in both tables, and their departments and pay rates.

Table 1: Employees and Departments

Employee	Department
John	101
Jill	102
Mike	103
Betty	104
Cindy	105

Table 2: Employees and Pay rates

Employee	Pay rate
John	50
Betty	50
Mike	40
Jill	35
Dan	45

Table 3: Employees, Departments, and Pay rates

Employee	Department	Pay rate
John	101	50
Jill	102	35
Mike	103	40
Betty	104	50

### Left outer join

Returns all records from the first table, and the matched records from the second table.

Using the example Tables 1 and 2, this option returns the following table:

Table 3: Employees, Departments, and Pay rates

Employee	Department	Pay rate
John	101	50
Jill	102	35
Mike	103	40
Betty	104	50
Cindy	105	

### Right outer join

Returns all records from the second table, and the matched records from the first table.

This option returns the following table:

Table 3: Employees, Departments, and Pay rates

Employee	Department	Pay rate
John	101	50
Betty	104	50
Mike	103	40
Jill	102	35
Dan		45

### Full outer join

Returns all records when there is a match in either left or right table.

This option returns the following table:

Table 3: Employees, Departments, and Pay rates

Employee	Department	Pay rate
John	101	50
Jill	102	35
Mike	103	40
Betty	104	50
Cindy	105	
Dan		45

## Using the Merge action

Use the **Merge** action to combine the contents of two tables when both source tables contain identical column headers. To combine tables that contain different column headers, use the **Join** action.

If one of the tables contains non-identical headers, then the merged table will contain the columns from the first source table with data from the second source table under the identical column headers, followed by the non-identical columns and data from the second source table.

To merge the content, perform these steps:

1. Double-click or drag **Data table > Merge**.
2. Select the first table variable you want to use from the **Enter first data table name** list.
3. Select the second table variable you want to use from the **Enter second data table name** list.
4. Select the table variable that you want to use to store the merged data from the **Enter name of data table in which to merge** list.
5. Click **Save**.

For more information, see [Merge output example](#) on page 2462.

## Merge output example

The **Merge** action combines data from two tables with identical column headers, and stores the merged content in a third table or one of the two source tables. These examples demonstrate the output of two tables with identical column headers and the output of two tables with differing column headers.

## Output of tables with identical column headers

For example, if you have a table of employees hired in September and a table of employees that were hired in October, this option will return a table of all the employees, with the October hires merged below the September hires.

Table 1: Employees hired in September

Employee	Department	Pay rate
John	101	50

Employee	Department	Pay rate
Jill	102	35

Table 2: Employees hired in October

Employee	Department	Pay rate
Mike	103	40
Betty	104	50

Table 3: All employees

**Note:** The column headers in the output table are always lowercase.

employee	department	pay rate
John	101	50
Jill	102	35
Mike	103	40
Betty	104	50

## Output of tables with differing column headers

In this example, the second table has a different column header. As a result, the third table contains the columns from the first source table with data from the second source table under the identical column headers, followed by the non-identical columns and data from the second source table.

Table 1: Employees hired in September

Employee	Department	Pay rate
John	101	50
Jill	102	35

Table 2: Employees hired in October

Employee	Department	Salary
Mike	103	40
Betty	104	50

Table 3: All employees

employee	department	pay rate	salary
John	101	50	

employee	department	pay rate	salary
Jill	102	35	
Mike	103		40
Betty	104		50

## Remove duplicate rows action

The Remove duplicate rows action in the Data Table package enables you to delete any duplicate rows from a table.

### Settings

Select the Table variable name from the drop-down list.

## Search for a value action

Enables you to search for a specific value in a table and return the row or column numbers in which the entry occurs.

When you search for a value using the **Search for a value** action, it will either return:

- A list of all the positions from the Data table where the search matched
- An empty list if the value is not found.

### Settings

- Click the **Enter database name** drop-down and select an existing data table.  
If there is no existing data table, click the **Create variable** icon to create a variable.
- Click the **Enter value to search for** drop-down menu to select a variable.
- (Optional) Select the **Match case** check box if the search term is case sensitive.
- (Optional) Click **Assign result to variable** drop-down to select a variable that you want to assign the value that the search returns.

Consider an example where you want to search for an entry called `abc` that is available at the fourth row and third column of a table variable. When you use the action, it returns `3, 2` as output. As the index number for the row and column starts with zero, the values in the output indicates the fourth row and third column.

So it is a x,y structure list where 'x' refers to Row index and 'y' refers to Column index, with base 0 criteria.



## Set value of a single cell action

The Set value of a single cell action in the Data Table package enables you to update the value of a specific cell.

### Settings

- Select the Table variable name from the drop-down list.
- Enter the row index. For example, to set a value to the first row, enter 0.
- Select whether to specify the column by **Name** or **Index**.
  - If you select to specify by name, enter the column name. Capitalization is not important.
  - If you select to specify by index, enter the column index. For example, to set a value to the first column, enter 0.
- Enter the value to set.

## Sort action

The Sort action in the Data Table package enables you to sort the table data by column.

### Settings

This action enables you to sort the data by column data format (string, number, datetime, or Boolean).

- Select the Table variable name from the drop-down list.
- Specify the column name or column index to sort by.
- Select the order in which to sort: **ascending order** or **descending order**.

---

**Note:** If you built a using this from version 2.0.0-20200624-042148 or earlier, the will be missing when you open the with the default version. You must reinsert the and repopulate the fields.

---

## Using Write to file action

Use the **Write to file** action to write data from a table into file in `.csv` or `.txt` format.

Considerations while using the **Write to file** action:

- Data extracted from a table is written as text into a file that is in `.csv` or `.txt` format.
- Source table typically contains four types of values (string, number, date & boolean). All these values will work with the **Write to file** action.
- Data containing decimals are not truncated unless there is 0 at the end. For example, if the source table has 87.90490, the data is extracted as 87.9049.

1. Double-click or drag **Data table** > **Write to file**.
2. Click the **Data table name** drop-down menu and select the table variable that contains the data that you want to write to a file.

3. Use the **Enter file name** field to specify the location of the file in which you want to write the data.  
You can also click the **Browse** button and select the file.
4. Optional: Select the **Create folders/files if it doesn't exist** check box to create the file or folder that you specified in the **Enter file name** field.
5. In the **When writing** field, select one of the following options:
  - **Append to the existing file**: to write the extracted data at the end of the existing file.
  - **Override existing file**: to erase the existing content from the file and write data.
6. Click the **Row delimiter** drop-down menu and select the delimiter to use for rows from the source table.
7. Click the **Column delimiter** drop-down menu and select the delimiter to use for columns from the source table.
8. Optional: Click the **Encoding** drop-down menu to specify the encoding that you want to apply on the file.  
The default encoding is set to ANSI
9. Click **Save**.

## Database package

Databases support internal operations of an enterprise by storing a variety of data, such as sales transactions, product catalogs, inventories, and customer profiles. Use the Database package to connect to a database, begin a transaction, and manipulate the stored data by retrieving, inserting, updating, deleting, and exporting it to a CSV file.

### Before you start

Perform the following actions within the Database package as part of using the set of available actions:

---

**Note:** When you use actions such as **Read from**, **Run stored procedure**, or **Export to data table** to retrieve records from a Microsoft SQL Server table which has a bit type column or an Excel column (with `TRUE` or `FALSE` values), then the retrieved data will be referred to 0 and 1, not `TRUE` and `FALSE`.

---

1. Establish a connection with the database server using the **Connect** action.  
See [Using Connect action for database](#) on page 2469.
2. Choose from the following:
  - Use the **Read from** action to retrieve records from the database. See [Using the Read from action](#) on page 2475.
  - If you are automating a task that involves making changes to the database, insert the **Begin database transaction** action, followed by the actions that automate the changes.

This action ensures that all records are updated or deleted in their entirety, and prevents accidental updates or deletions of incomplete data if the bot encounters an error during run time.

3. If you used the **Begin database transaction** action in this session, insert the **End database transaction** to commit the changes.
4. Every set of database actions ends with the **Disconnect** action to terminate the connection to the database server.

## Database data types

Data types represent the type of value that can be stored in the database table. The following table provides information about the widely used data types in Automation 360. Note that this is not a comprehensive list.

Data type	Value
Supported data types	Char, Varchar, Nvarchar, Number, Datetime, INT, Float, and Bit
Unsupported data types	<ul style="list-style-type: none"> <li>• Binary data types: Binary, BLOB, CLOB, BFILE, and RAW</li> <li>• Pointer data types: Cursor and Record pointers</li> </ul>

## Actions in the Database package

The Database package includes the following actions:

Action	Description
Begin database transaction	See <a href="#">Begin database transaction action</a> on page 2468.
End database transaction	See <a href="#">End database transaction action</a> on page 2469.
Connect	See <a href="#">Using Connect action for database</a> on page 2469. The Snowflake database using the ODBC driver is supported.
Disconnect	See <a href="#">Disconnect action</a> on page 2474.
Read from	See <a href="#">Using the Read from action</a> on page 2475. The Snowflake database using the ODBC driver is supported.
Run stored procedure	See <a href="#">Using the Run stored procedure action</a> on page 2476.
Export to data table	See <a href="#">Using the Export to data table action</a> on page 2480. The Snowflake database using the ODBC driver is supported.
Manage stored procedure	See <a href="#">Manage stored procedure action</a> on page 2481.

---

Action	Description
Insert/Update/Delete	See <a href="#">Insert/Update/Delete action</a> on page 2482.

Related reference

[Loop package](#) on page 2784

Use the Loop package to run a sequence of actions repeatedly for a specific number of times or until a specific condition is met.

[Variables overview](#) on page 2326

Automation 360 offers a variety of variables, each designed to hold specific types of data and is intended for specific use. Use the topics below to learn more about each variable and how to use them.

[Database package updates](#) on page 859

Review the updates in released versions of the Database package such as new and enhanced features as well as fixes and limitations. The page also lists the release dates of each version, and the compatible Control Room and Bot Agent versions.

## Begin database transaction action

Use the Begin database transaction action in the Database package to starts a database transaction to commit all database actions till the end database transaction.

### Settings

- The actions that you insert between the **Begin database transaction** and **End database transaction** actions are treated as a single unit. The bot must run all of the actions successfully in order to update the database. This prevents a partial entry in the event that one of the actions fail.

For example, in double-entry accounting every debit requires the recording of a credit. If a company receives \$5000 of products, the accountant must debit \$5000 to inventory and credit \$5000 to accounts payable.

- Insert the actions that record these entries between the **Begin database transaction** and **End database transaction** actions to ensure that either both entries are recorded or neither is recorded in the database.
- In the **Session name** field, enter the name of the session that you used to connect to the database server in the **Connect** action.

---

**Note:** **Begin** and **End database transaction** actions do not support ODBC connectivity.

---

## End database transaction action

Use the End database transaction action Database package to commits all the database operations that were performed with the actions that followed the **Begin database transaction** action.

### Settings

- All the database operations that were performed with the actions that followed the **Begin database transaction** action are committed, under the condition that the bot successfully ran those actions.
- In the **Session name** field, enter the name of the session that you used to connect to the database server in the **Connect** action.

---

**Note:** **Begin** and **End database transaction** actions do not support ODBC connectivity.

---

## Using Connect action for database

Use the **Connect** action to establish a connection with the database server that you want to use to automate database-related tasks. This action supports Microsoft Access, Microsoft SQL Server, MySQL, Oracle, PostgreSQL Server, and SQLite database servers, as well as the use of CSV, Microsoft Excel, and TXT files as databases.

---

**Important:** If your current office installation is any of the following:

- Microsoft 365 Apps for Enterprise
- Office 2016, 2019, or 2021 (Consumer Version 2009 or later)

Then you do not need to install the Microsoft Access Database Engine as an additional component in your system.

However, if you have both Microsoft 365 Apps and the Microsoft Access Database Engine are installed on your system, then you can uninstall the Microsoft Access Database Engine and repair Microsoft 365 Apps.

Microsoft recommends that you do not install the Microsoft Access Database Engine driver separately because both the Microsoft Access Database Engine 2016 and Microsoft 365 Apps use the same major version identifier (16.0). To learn more about the Microsoft Access Database Engine driver installation requirement, see [Unable to use the Access ODBC or OLEDB provider](#)

---

**Note:** The SQL Server driver is not dependent on the Microsoft Office installation. Only the Excel driver version is dependent on the Microsoft Office version.

---

Specify the details of a database server and associate it with a session name. Use the session name provided in this action in the other actions so that you do not have to provide the details of the database server in those actions.

To establish a connection with a database server, follow these steps:

1. Double-click or drag the **Connect** action from the Database package in the **Actions** palette.
2. Select the **Default** or **User defined** connection option.

When you select **User defined** connection mode and use action **Read from** with encoding ANSI to save the retrieved data in a CSV file, you will see that the retrieved records from the Oracle database display garbled character.

To know more about this issue, see [Fullwidth hyphen is garbled when exporting data to csv by Database: Read from action with encoding ANSI \(A-people login required\)](#)

- If you select the **Default** option, you can directly enter the connection string for any database that supports the JDBC connection strings and a 64-bit driver. To see the list of supported databases, see [Database server support matrix](#) on page 2482.

If you have configured your database and shared repository in the secondary site, use the JDBC connection to connect to the replica database. For example, `jdbc:sqlserver://AGL-ADDRESS:1433;databaseName=DB_NAME;user=username;password=password;applicationInt`

You can establish a connection with the Snowflake database using ODBC drivers. For more information about downloading the ODBC driver, see [Snowflake using ODBC Driver](#)

You can enter the connection string to connect to the database. For example,

```
Driver={SnowflakeDSIIDriver};Server={account}.aws.snowflakecomputing.com;Database=
```

Use this option to connect to an Excel, CSV, or TXT file. See [Connection Strings by database type](#).

---

**Note:** To access any database through ODBC, you must first install a 32-bit ODBC driver on your device.

---

Parameter: You can use the credential values from the credential locker without exposing the credentials (username or password) in plain text in the connection string. To do so, you must first map the credential in the credential mapper and use the parameter name in the connection string within double curly braces.

For example, if the parameter name is `db_username` and parameter value is chosen from credential value, the connection string

with 3 parameters will be `Provider=SQLLEDB.1;Initial`

```
Catalog=master;Password={{db_credentials}};Persist Security
```

```
Info=True;User ID={{db_username}};Data Source={{db_datasource}}"
```

To use the password from the credential locker, perform the following steps:

- a) Click **Add parameter**.
- b) Enter the **Parameter name**.
- c) In the **Parameter value**, select **Credential** to use a value available in the credential vault, **Variable** to use a credential variable, or **Insecure string** to manually specify the value you want to use.
- d) Click **Add**.

To ensure a more secure automation, use a Credential Vault variable for the connection string.

Select the **Use ODBC 64-bit driver for connection** option to connect to the database.

---

**Note:**

- Ensure that 64-bit access ODBC driver is installed on your system to access any database and perform operations by using database actions.

- The following action does not support the 32-bit or 64-bit ODBC drivers because the listed actions are for database transactions that are carried out after making a connection with the database:
  - Begin database transaction
  - End database transaction
  - Manage stored procedure
- Using Excel as a database, you can process more rows with 64-bit drivers compared to 32-bit ones.

- If you select the **User defined** option, select the database type from the available options and complete the following fields based on the selection:

Database Type	Options
Microsoft SQL Server, PostgreSQL Server	<ul style="list-style-type: none"> <li><b>Server name:</b> Enter the name of the database server you want to connect to.</li> <li><b>Database name:</b> Enter the database name.</li> <li><b>Username:</b> Enter the username you want to use to access the database server. To ensure a secure user name, select a Credential Vault variable. Otherwise, enter a value.</li> <li><b>Password:</b> Enter the password for the username you have provided. To ensure a secure password, select a Credential Vault variable. Otherwise, enter a value.</li> <li><b>Instance name:</b> Enter a name for this connection instance.</li> <li><b>Timeout in seconds (optional) field:</b> Specify the amount of time between 1-9999 you want the system to wait before canceling a bot.</li> </ul> <p>The automation will time out and fail if the database connection is not established the specified time. If you do not enter a value in the <b>Timeout in seconds (optional)</b> field, then the default timeout specified in the driver library is used.</p> <hr/> <p><b>Note:</b> Microsoft SQL Server supports this option only.</p> <hr/> <p><a href="#">Connect to Microsoft SQL Server with Windows authentication</a> on page 2473</p>
MySQL	Enter the same options as in the Microsoft SQL Server database type. Also, enter the port number. The default port number is 3306.

Database Type	Options
Microsoft Access, SQLite	<p>Select the database file path from:</p> <ul style="list-style-type: none"> <li>• <b>Bots</b> folder</li> <li>• local device</li> <li>• existing file variable</li> </ul>
Oracle	<ul style="list-style-type: none"> <li>• <b>Server name (Optional)</b>: Enter the name of the Oracle server you want to connect to.</li> <li>• <b>Optional</b>: Select an option to specify the Oracle instance you want to use: <ul style="list-style-type: none"> <li>• <b>System id (SID)</b>: Enter the system ID.</li> <li>• <b>Service name</b>: Enter the service name.</li> <li>• <b>TNS Name</b>: Enter the <b>TNS Name</b> available in the <code>tnsnames.ora</code> configuration file.</li> </ul> <p>Specify the file path of the <code>tnsnames.ora</code> configuration file, if you have not set the system property with environment variable.</p> <hr/> <p><b>Note:</b> You can connect to the Oracle Database with the <b>Server name</b> or <b>Oracle instance</b>. If you are connecting using the server name, you must specify the <b>System id (SID)</b> or <b>Service name</b> in the <b>Oracle instance</b> field to identify the Oracle database and its instance. However, if you are connecting using the <b>TNS name</b>, you do not require to enter any value in the <b>Server name</b> field. You should only enter the value of the TNS name and file path.</p> <hr/> </li> <li>• <b>Username</b>: Enter the username you want to use to access the Oracle server. To ensure a secure user name, select a Credential Vault variable. Otherwise, enter a value.</li> <li>• <b>Password</b>: Enter the password for the username you have provided. To ensure a secure password, select a Credential Vault variable. Otherwise, enter a value.</li> <li>• <b>Port</b>: Enter the port number. The default port number is 1521.</li> </ul>

**Note:** If you establish a connection by using a JDBC driver, for Microsoft SQL Server, the Database package already includes the JDBC driver. However, for other database servers,



you must provide the corresponding JDBC driver jar file after downloading it from the appropriate resources.

If you establish a connection by using an ODBC driver, you need not provide a jar file.

---

3. Select a driver file from the **Bots** folder, the local device, or a file variable.
4. Select any of the following tabs to create a database session:
  - **Local session**: Specify a session name that can be used only in the current bot.
  - **Global session**: Specify a session name that can be used across multiple bots, such as parent bots and child bots.
  - **Variable**: Specify or create a session variable of subtype Database session.
5. Click **Save**.

Choose from the following:

- Use the **Read from** action to retrieve records from the database.  
[Using the Read from action](#) on page 2475
- If you are automating a task that involves making changes to the database, insert the **Begin database transaction** action.

This action ensures that all records are updated or deleted in their entirety, and prevents accidental updates or deletions of incomplete data if the bot encounters an error during run time.

[Database package](#) on page 2466

## Connect to Microsoft SQL Server with Windows authentication

Configure your device and the Connect action from the Database package to automate connecting to a Microsoft SQL Server with Windows NT authentication.

This task is applicable only for releases prior to Build 9664. Starting from Build 9664, you no longer have to add DLL files manually to connect to the Microsoft SQL Server.

To use Windows NT authentication for connecting to the Microsoft SQL Server, perform the following steps:

1. Download the JDBC driver for Microsoft SQL Server.  
[Download the JDBC Driver from Microsoft](#)
2. In the unzipped folder, locate the .dll file in the auth\x64\ file path.
3. If the .dll file has a different name, rename the file to `sqljdbc_auth.dll`.
4. On the Bot Creator or Bot Runner devices, copy the `sqljdbc_auth.dll` file to one of the following paths, depending on where you installed the Bot Agent and the option that you selected at the time of installation:

---

**Note:** If you are on Build 9664 or later, you do not have to copy the file to the location in which Bot Agent was installed.

---

- If you installed the Bot Agent at the user level and selected the **Only for me (username)** option, copy to `C:\Users\User Name\AppData\Local\Programs\Automation Anywhere\Bot Agent\jre\bin`.

- If you installed the Bot Agent at the system level and selected the **Anyone who uses this computer (all users)** option, copy to `C:\Program Files\Automation Anywhere\Bot Agent\jre\bin`.

This enables Windows authentication because the JDBC driver cannot perform the authentication by default.

5. Select the **Default** connection option.
6. Enter the connection string: `jdbc:sqlserver://localhost;databaseName=Test;integratedSecurity=true;`
7. Click **Save**.

Choose from the following:

- Use the **Read from** action to retrieve records from the database.  
[Using the Read from action](#) on page 2475
- If you are automating a task that involves making changes to the database, insert the **Begin database transaction** action.

This action ensures that all records are updated or deleted in their entirety, and prevents accidental updates or deletions of incomplete data if the bot encounters an error during run time.

[Database package](#) on page 2466

## Disconnect action

Use the Disconnect action in the Database package to disconnect from a database.

## Settings

Select any of the following tabs to create a database session:

- **Session name:** Enter or select a local or global session name variable.
- **Variable:** Enter or create a session variable of subtype Database session.

A record set is returned when you run a stored procedure or a query. To use the record set stored in the memory even if the session is disconnected, select **Keep database schema in cache until bot finishes running**. By using this option, you can enable the **Loop** action to iterate the record set by using cached schema after disconnecting from the database.

This capability becomes ineffective in the following conditions:

- The option **Keep database schema in cache until bot finishes running** is selected.
- A new database session is created after the **Disconnect** action.
- The name of the session is same as the previous session.

In this scenario, an error occurs stating a session already exists, and the new database session is not created. To avoid this, you can leave the **Keep database schema in cache until bot finishes running** unchecked.

**Note:** You cannot delete any files used in a database connection such as `xlsx`, `csv`, or `mdb`. To delete these files, you must not select the **Keep database schema in cache until bot finishes running** check box to disconnect the session without keeping the connection in the cache.

The Snowflake database using the ODBC driver is supported.

## Using the Read from action

Use the **Read from** action to retrieve records from the database and save the retrieved data in a CSV file. This action enables you to retrieve up to one million records from the database.

**Note:** In Automation 360, the bot displays an error when you use **Read from** action to copy the table records using `Select * into tablename from sourcetable`, whereas this functionality is supported in Enterprise 11. If you have such bots created in Enterprise 11 and migrated to Automation 360, we recommend modifying your bots and use **Insert/Update/Delete** action to perform this operation.

To automate the task of selecting and saving a set of records, follow these steps:

1. Enter the name of the session you used to connect to the database server in the **Connect** action.

You do not have to provide the details of the database server here because you have already associated those details with the session name when using the **Connect** action.

2. Enter the SELECT statement to specify the column and table names.

This field supports SQL syntax. For example, `SELECT CustomerName, City FROM Customers`

**Note:** CTE (Common Table Expression) is supported using `WITH` keyword in the SQL compliant databases such as Oracle and MySQL. For example,

```
WITH customers_in_usa AS (SELECT CustomerName, state FROM customers
WHERE country = 'USA')
SELECT cName FROM customers_in_usa WHERE state = 'LA' ORDER BY
CustomerName
```

3. Enter the maximum number of records to retrieve.
4. Optional: Enter a timeout value.  
When the specified time expires, the statement execution stops even if the execution is not completed.
5. Select the **Export data to CSV** option to save the retrieved data.
  - a) Select the file path from the **Bots** folder, the local device, or an existing file variable.
  - b) Select the CSV file encoding to be either **ANSI**, **UNICODE**, or **UTF8**.
  - c) Select whether to export the CSV file with or without the column headers.

With column headers

CustomerName	City
Manny	Pittsburgh
Kate	Los Angeles

CustomerName	City
John	Boston

Without column headers

Manny	Pittsburgh
Kate	Los Angeles
John	Boston

- d) Select this check box if you do not want a CSV file to be created when the SQL query does not return any data.
- e) Specify whether to overwrite the file or append the data to the existing file if a CSV file with the same name exists.

6. Click **Save**.

## Using the Run stored procedure action

Stored procedures are a set of SQL statements that are created and stored in the database. These SQL statements might be complex and have to run multiple times. Use the **Run stored procedure** action to execute existing stored procedures.

---

### Note:

- This action does not support Microsoft Access or SQLite database types.
- Starting from Automation 360 v.22 (Build 10526), for stored procedures, the limit of 32 characters for input and output parameters has been removed.

---

To automate the task of executing a stored procedure, follow these steps:

1. Enter the name of the session you used to connect to the database server in the **Connect** action.

You do not have to provide the details of the database server here because you have already associated those details with the session name when using the **Connect** action.

2. Enter the name of the stored procedure.
3. Optional: Click **Add parameter** to provide an input parameter or configure an output parameter.

Select from the following parameter options:

Option	Steps
Input	<p>Parameter is passed from the bot to the stored procedure.</p> <ul style="list-style-type: none"> <li>• <b>Name</b>: Enter the name of the parameter from the stored procedure.</li> <li>• <b>Value (optional)</b>: Enter a value or select a variable.</li> <li>• <b>Type</b>: Select the data type from the following options                             <ul style="list-style-type: none"> <li>• <b>BIGINT</b> (number)</li> <li>• <b>BINARY</b> (Boolean)</li> <li>• <b>BIT</b> (number)</li> <li>• <b>CHAR</b> (string)</li> <li>• <b>DATE</b> (date time)</li> </ul> <p>Supported format yyyy-mm-dd</p> <ul style="list-style-type: none"> <li>• <b>DECIMAL</b> (number)</li> <li>• <b>DOUBLE</b> (number)</li> </ul> <p>Default choice for decimal values.</p> <ul style="list-style-type: none"> <li>• <b>FLOAT</b> (number)</li> <li>• <b>INTEGER</b> (number)</li> </ul> <p>Uses 4 bytes to store an integer with a value from -2,147,483,648 to 2,147,483,647</p> <ul style="list-style-type: none"> <li>• <b>LONGVARBINARY</b> (Boolean)</li> <li>• <b>LONGVARCHAR</b> (string)</li> <li>• <b>NUMERIC</b> (number)</li> <li>• <b>REAL</b> (number)</li> <li>• <b>SMALLINT</b> (number)</li> </ul> <p>Uses 2 bytes to store an integer with a value from -32,768 to 32,767</p> <ul style="list-style-type: none"> <li>• <b>TIME</b> (date time)</li> </ul> <p>Supported format hh:mm:ss</p> <ul style="list-style-type: none"> <li>• <b>TIMESTAMP</b> (date time)</li> </ul> <p>Supported format yyyy-mm-dd hh:mm:ss.f, where f is fractional seconds</p> <ul style="list-style-type: none"> <li>• <b>TINYINT</b> (number)</li> </ul> <p>Uses 1 byte to store an integer with a value from 0 to 255</p> <ul style="list-style-type: none"> <li>• <b>VARBINARY</b> (Boolean)</li> <li>• <b>VARCHAR</b> (string)</li> </ul> </li> </ul> <p>For example, if running the example function from the <b>Manage stored procedure</b> action, configure the following two input parameters and values for the <code>sum_of_two</code> function to add:</p> <ul style="list-style-type: none"> <li>• Parameter 1: num1, 5, TINYINT</li> <li>• Parameter 2: num2, 10, TINYINT</li> </ul>

Option	Steps
Output	<p>Parameter is passed from the stored procedure to the bot.</p> <ul style="list-style-type: none"> <li>• <b>Name:</b> Enter the name of the parameter from the stored procedure.</li> <li>• <b>Type:</b> Select the data type from the following options                             <ul style="list-style-type: none"> <li>• <b>BIGINT</b> (number)</li> <li>• <b>BINARY</b> (Boolean)</li> <li>• <b>BIT</b> (number)</li> <li>• <b>CHAR</b> (string)</li> <li>• <b>DATE</b> (date time)</li> </ul> <p>Supported format yyyy-mm-dd</p> <ul style="list-style-type: none"> <li>• <b>DECIMAL</b> (number)</li> <li>• <b>DOUBLE</b> (number)</li> </ul> <p>Default choice for decimal values.</p> <ul style="list-style-type: none"> <li>• <b>FLOAT</b> (number)</li> <li>• <b>INTEGER</b> (number)</li> </ul> <p>Uses 4 bytes to store an integer with a value from -2,147,483,648 to 2,147,483,647</p> <ul style="list-style-type: none"> <li>• <b>LONGVARBINARY</b> (Boolean)</li> <li>• <b>LONGVARCHAR</b> (string)</li> <li>• <b>NUMERIC</b> (number)</li> <li>• <b>REAL</b> (number)</li> <li>• <b>SMALLINT</b> (number)</li> </ul> <p>Uses 2 bytes to store an integer with a value from -32,768 to 32,767</p> <ul style="list-style-type: none"> <li>• <b>TIME</b> (date time)</li> </ul> <p>Supported format hh:mm:ss</p> <ul style="list-style-type: none"> <li>• <b>TIMESTAMP</b> (date time)</li> </ul> <p>Supported format yyyy-mm-dd hh:mm:ss.f, where f is fractional seconds</p> <ul style="list-style-type: none"> <li>• <b>TINYINT</b> (number)</li> </ul> <p>Uses 1 byte to store an integer with a value from 0 to 255</p> <ul style="list-style-type: none"> <li>• <b>VARBINARY</b> (Boolean)</li> <li>• <b>VARCHAR</b> (string)</li> </ul> </li> </ul> <p>When the bot runs, the action converts the database data type to an Automation 360-supported data type.</p> <p>For example, if running the example <code>sum_of_two</code> function from the <b>Manage stored procedure</b> action, configure the output parameter: <code>sum, TINYINT</code>.</p>

Option	Steps
InputOutput	<p>Parameter can be used for both input and output.</p> <ul style="list-style-type: none"> <li>• <b>Name:</b> Enter the name of the parameter from the stored procedure.</li> <li>• <b>Value (optional):</b> Enter a value or select a variable.</li> <li>• <b>Type:</b> Select the data type from the following options <ul style="list-style-type: none"> <li>• <b>BIGINT</b> (number)</li> <li>• <b>BINARY</b> (Boolean)</li> <li>• <b>BIT</b> (number)</li> <li>• <b>CHAR</b> (string)</li> <li>• <b>DATE</b> (date time)</li> </ul> <p>Supported format yyyy-mm-dd</p> <li>• <b>DECIMAL</b> (number)</li> <li>• <b>DOUBLE</b> (number)</li> <p>Default choice for decimal values.</p> <li>• <b>FLOAT</b> (number)</li> <li>• <b>INTEGER</b> (number)</li> <p>Uses 4 bytes to store an integer with a value from -2,147,483,648 to 2,147,483,647</p> <li>• <b>LONGVARBINARY</b> (Boolean)</li> <li>• <b>LONGVARCHAR</b> (string)</li> <li>• <b>NUMERIC</b> (number)</li> <li>• <b>REAL</b> (number)</li> <li>• <b>SMALLINT</b> (number)</li> <p>Uses 2 bytes to store an integer with a value from -32,768 to 32,767</p> <li>• <b>TIME</b> (date time)</li> <p>Supported format hh:mm:ss</p> <li>• <b>TIMESTAMP</b> (date time)</li> <p>Supported format yyyy-mm-dd hh:mm:ss.f, where f is fractional seconds</p> <li>• <b>TINYINT</b> (number)</li> <p>Uses 1 byte to store an integer with a value from 0 to 255</p> <li>• <b>VARBINARY</b> (Boolean)</li> <li>• <b>VARCHAR</b> (string)</li> </li></ul>

4. Enter the maximum number of records to retrieve.  
You can limit the results of the execution.
5. Optional: Enter a timeout value.  
When the specified time expires, the statement execution stops even if the execution is not completed.
6. Optional: Select the **Export data to CSV** option to save the retrieved data.

**Note:** The **Export data to CSV** option does not support Oracle Database or PostgreSQL Server database types. Use output parameters to retrieve values.

- a) Select the file path from the **Bots** folder, the local device, or an existing file variable.
- b) Select the CSV file encoding to be either **ANSI, UNICODE, or UTF8**.
- c) Select whether to export the CSV file with or without the column headers.

With column headers

CustomerName	City
Manny	Pittsburgh
Kate	Los Angeles
John	Boston

Without column headers

Manny	Pittsburgh
Kate	Los Angeles
John	Boston

- d) Specify whether to overwrite the file or append the data to the existing file if a CSV file with the same name exists.
7. Optional: Select a dictionary variable to hold the output if the stored procedure returns a value.
- Each output parameter name is a dictionary key which holds the corresponding parameter value.
- For example, if you assign the `sum_of_two` function output to `$Output$`, when the bot calls `$Output {sum} $`, the variable returns 15.

**Note:** If you do not know the output parameter name, use the default key `Output` appended by the parameter index number.

8. Click **Save**.

## Using the Export to data table action

Use the **Export to data table** action to retrieve records from the database and store the retrieved data in a table variable.

To automate the task of selecting and saving a set of records, follow these steps:

1. Enter the name of the session you used to connect to the database server in the **Connect** action.

You do not have to provide the details of the database server here because you have already associated those details with the session name when using the **Connect** action.

2. Enter the SELECT statement to specify the column and table names.



This field supports SQL syntax. For example, `SELECT CustomerName, City FROM Customers`

---

**Note:** CTE (Common Table Expression) is supported using `WITH` keyword in the SQL compliant databases. For example, `WITH customers_in_usa AS (SELECT CustomerName, state FROM customers WHERE country = 'USA') SELECT cName FROM customers_in_usa WHERE state = 'LA' ORDER BY CustomerName`

---

3. Enter the maximum number of records to retrieve.
  4. Optional: Enter a timeout value.  
When the specified time expires, the statement execution stops even if the execution is not completed.
  5. In the **Assign to** option, select the table variable to store the retrieved data.
- 

**Note:**

If the data table has some existing values, the new table overrides the existing data table. For example, if you use **Export to table** action twice in a bot with different select queries, the last used **Export to table** action will override the existing table.

---

6. Click **Save**.

## Manage stored procedure action

Use the Manage stored procedure action in the Database package to create, update, and delete a stored procedure within the specified database. A stored procedure is SQL code saved to the database, enabling you to run it repeatedly.

### Settings

- In the **Session name** field, enter the name of the session that you used to connect to the database server in the **Connect** action.
  - In the **Enter full command** field, enter the command to create, update, or delete the stored procedure. You can specify input and output parameters for the command; you provide values or variables holding the values in the **Run stored procedure** action.
- 

**Note:** Declare a delimiter and use it to close the SQL statement.

---

MySQL example: In this example, the bot checks if there is a procedure in the database named `sum_of_two`. If not, the bot creates a procedure that accepts two input parameters (`num1` and `num2`), adds them together, and produces the sum as the output parameter:

```
DROP PROCEDURE IF EXISTS sum_of_two;
DELIMITER $$
CREATE PROCEDURE sum_of_two(IN num1 INT, IN num2 INT, OUT sum
INT)
BEGIN
SET sum := num1 + num2;
END
$$
```

- In the **Timeout for the query in seconds** field, specify the time within which the statement execution should stop, even if the execution is not completed.

## Insert/Update/Delete action

Use the Insert/Update/Delete action in the Database package to execute an INSERT, UPDATE, or DELETE statement from the database.

### Settings

- In the **Session name** field, enter the name of the session that you used to connect to the database server in the **Connect** action.
- In the **Statement** field, enter the SQL statement to insert, update, or delete the records.

- Use an INSERT statement to create new records in a table:

```
INSERT INTO table_name (column1, column2, column3, ...)
VALUES (value1, value2, value3, ...)
```

- Use an UPDATE statement to modify a record:

```
UPDATE table_name
SET column1 = value1, column2 = value2, ...
WHERE condition
```

- Use a DELETE statement to remove a record:

```
DELETE FROM table_name WHERE condition
Example: DELETE FROM Persons WHERE LastName='Smith'
```

- In the **Timeout for the query in seconds** field, specify the time within which the statement execution should stop, even if the execution is not completed.

If you do not enter a value in the **Timeout for the query in seconds** field, then the default timeout specified in the driver library is used.

## Database server support matrix

Review the list of databases supported in Automation 360 and their JDBC and ODBC connectivity.

### JDBC connectivity

The following table lists the supported database servers with JDBC connectivity.

Datab: Micro: Micro: Postgr MySQL Excel Text CSV Snowf DB2 Oracle AWS Micro: MariaDB action SQL Acces: Server Server RDS Azure	Server	Server	Server	Server	Server	Server	Server	Server	Server	Server	Server	Server	Server
Connect	Y	Y	Y	N	N	N	Y*	Y*	Y	Y	Y	Y	Y*
Disconnect	Y	Y	Y	N	N	N	Y*	Y*	Y	Y	Y	Y	Y*

Database action	Microsoft SQL Server	Microsoft Access	PostgreSQL	MySQL	Excel	Text	CSV	Snowflake	DB2	Oracle	AWS RDS	Microsoft Azure	Microsoft SQL Server
Read from	Y	Y	Y	Y	N	N	N	Y*	Y*	Y	Y	Y	Y*
Run stored procedure	Y	n/a	Y	Y	n/a	n/a	n/a	Y*	Y*	Y	Y	Y	Y*
Export to data table	Y	Y	Y	Y	N	N	N	Y*	Y*	Y	Y	Y	Y*
Managed stored procedure	Y	n/a	Y	Y	n/a	n/a	n/a	Y*	Y*	Y	Y	Y	Y*
Insert/Update/Delete	Y	Y	Y	Y	N	N	N	Y*	Y*	Y	Y	Y	Y*
Begin database transaction	Y	n/a	Y	Y	n/a	n/a	n/a	Y*	Y*	Y	Y	Y	Y*
End database transaction	Y	n/a	Y	Y	n/a	n/a	n/a	Y*	Y*	Y	Y	Y	Y*

- Y: Supported
- Y\*: Supported with Automation 360 v.30 and later releases
- N: Not supported
- n/a: Not applicable

### ODBC connectivity

The following table lists the supported database servers with ODBC connectivity.

Database action	Microsoft SQL Server	Microsoft Access	PostgreSQL	MySQL	Excel	Text	CSV	Snowflake	Oracle	AWS RDS	Microsoft Azure
Connect	Y	Y	Y	Y	Y	Y	Y	Y	Y	Y	Y
Disconnect	Y	Y	Y	Y	Y	Y	Y	Y	Y	Y	Y
Read from	Y	Y	Y	Y	Y	Y	Y	Y	Y	Y	Y
Run stored procedure	Y	n/a	Y	Y	n/a	n/a	n/a	n/a	Y	Y	Y

Database action	Microsoft SQL Server	Microsoft Access	PostgreSQL	MySQL	Excel	Text	CSV	Snowflake	Oracle	AWS RDS	Microsoft Azure
Export to data table	Y	Y	Y	Y	N	N	N	-	Y	Y	Y
Managed stored procedure	N	n/a	N	N	n/a	n/a	n/a	n/a	N	N	N
Insert/Update/Delete	Y	Y	Y	Y	Y	Y	Y	Y	Y	Y	Y
Begin database transaction	N	n/a	N	N	n/a	n/a	n/a	N	N	N	N
End database transaction	N	n/a	N	N	n/a	n/a	n/a	N	N	N	N

- Y: Supported
- N: Not supported
- n/a: Not applicable

## Datetime package

A datetime value consists of a date, time, and time zone. Automation Workspace stores datetime values in a Datetime variable. The **Datetime** package contains actions that enable you to perform various operations on datetime values. You can use these actions to manipulate and compare values in the Datetime variables.

### Actions in the Datetime package

You can enter either a **String** or a **Global** variable for any of the actions in the Datetime package. The actions then assign the output to a variable.

The actions in the **Datetime** package accept a variable as an input and assign the output to a variable. These actions enable you to compare two Datetime values, add to or subtract from a Datetime value, and convert a Datetime value to a string value.

The **Datetime** package includes the following actions:

Action	Description
Add	See <a href="#">Using the Add action</a> on page 2485.
Assign	See <a href="#">Using the Assign action</a> on page 2486.

Action	Description
Is after	See <a href="#">Is after action in Datetime</a> on page 2487.
Is before	See <a href="#">Is before action in Datetime</a> on page 2487.
Is equal	See <a href="#">Is equal action in Datetime</a> on page 2488.
Subtract	See <a href="#">Using the Subtract action</a> on page 2488.
To string	See <a href="#">Using the To string action</a> on page 2489.

Related reference

[Datetime formats](#) on page 2489

Specify a custom format when you convert a datetime value to a string value by using the predefined formats available in Automation Workspace.

[Datetime package updates](#) on page 861

Review the updates in released versions of the Datetime package such as new and enhanced features as well as fixes and limitations. The page also lists the release dates of each version, and the compatible Control Room and Bot Agent versions.

## Using the Add action

Use the **Add** action to increase the value in the Datetime variable by a specified time value and unit. For example, you can use this action to increase the Datetime variable value by three hours or by three days.

To add a value to a Datetime variable, do the following:

1. Double-click or drag the **Add** action from the **Datetime** node in the **Actions** palette.
2. Select an option from the **Source date and time variable** list to specify the variable that contains the value to which you want to add the time unit.
3. Enter the value you want to add in the **Time value to add** field.
4. Select an option from the **Time unit to add** list to specify the time unit you want to add.

Choose from the following time unit options:

- Milliseconds
- Seconds
- Minutes
- Hours
- Days
- Weeks
- Months
- Years

**Note:** This action accounts for leap years. For example, if the action adds 28 days to February 1, 2020, the action output is February 29, 2020. Whereas, if the action adds 28 days to February 1, 2019, the action output is March 1, 2019.

---

5. Select the Datetime variable from the **Assign the output to a variable** list to specify the variable to which you want to assign the output.
6. Click **Save**.

To see the output value, convert the value in the Datetime variable to a String variable, then print the value with the **Message Box** action. For more information, see [Using the To string action](#) on page 2489 and [Using the Message box action](#) on page 2796.

## Using the Assign action

Use the **Assign** action to assign a String variable with a selected datetime format, assign a datetime value manually, or assign an existing Datetime variable into a Datetime variable.

To assign values to a Datetime variable, perform the following steps:

1. Double-click or drag the **To string** action from the **Datetime** node in the **Actions** palette.
2. Select either the **Enter the date time** or **Variable** option.
  - If you selected the **Enter the date time** option, perform the following steps:
    - a) Enter the date time values or select a String variable.

---

**Note:** To enter multiple variables, separate them with single quotation marks. For example, to input the variables date1 and time1, enter the following: 'date1"time1'

---
    - b) Select the date time format.

Choose from the prebuilt formats or provide a custom format. For more information about the prebuilt formats, see [Datetime formats](#) on page 2489.
  - If you selected the **Variable** option, choose either the **Datetime** option or the **Variable** option.
    - Use the **Datetime** option if you want to select the date, time, and timezone manually.
    - Use the **Variable** option if you want to select the Datetime variable or other variables that can have Datetime as a subtype, such as the Dictionary, Record, and list variables.
3. Select the variable to use to store the output from the **Destination Datetime variable** list.
4. Click **Save**.

## Is after action in Datetime

The **Is after** action in the Datetime package compares two Datetime variables and verifies if the value of the source variable is after the value available in the comparison variable, and stores the output to a Boolean variable.

### Settings

- From the Source date and time variable section, select either the **Datetime** or **Variable** option. Use the **Datetime** option to enter the date and time. Use the **Variable** option to select the global value.
- Select the source variable from the **Source date and time variable** list, and select the variable you want to compare with from the **Date and time variable to be compared to** list.
- Select the Datetime variable from the **Assign the output to a variable** list to specify the variable you want to use to assign the output.

For example, if the value in the source variable is after the value in the comparison variable, the system stores `True` as the output in the Boolean variable. If the value in the source variable is not after the value in the comparison variable, the system stores `False` as the output in the Boolean variable.

## Is before action in Datetime

The **Is before** action in the Datetime package compares two Datetime variables and verifies if the value of source variable is before the value available in the comparison variable, and stores the output to a Boolean variable.

### Settings

- Select the source variable from the **Source date and time variable** list, and select the variable you want to compare with from the **Date and time variable to be compared to** list.
- Select the Datetime variable from the **Assign the output to a variable** list to specify the variable you want to use to assign the output.

For example, if the value in the source variable is before the value in the comparison variable, the system stores `True` as the output in the Boolean variable. If the value in the source variable is not before the value in the comparison variable, the system stores `False` as the output in the Boolean variable.

## Is equal action in Datetime

The **Is equal** action in the Datetime package compares two Datetime variables and verifies if the value of the source variable is equal to the value available in the comparison variable, and stores the output to a Boolean variable.

### Settings

- Select the source variable from the **Source date and time variable** list, and select the variable you want to compare with from the **Date and time variable to be compared to** list.
- Select the Datetime variable from the **Assign the output to a variable** list to specify the variable you want to use to assign the output.

For example, if the value in the source variable is equal to the value in the comparison variable, the system stores `True` as the output in the Boolean variable. If the value in the source variable is not equal to the value in the comparison variable, the system stores `False` as the output in the Boolean variable.

## Using the Subtract action

Use the **Subtract** action to decrease the value in the Datetime variable by a specified time value and unit. For example, you can use this action to decrease the Datetime variable value by three hours or by three days.

To subtract a value from a Datetime variable, do the following:

1. Double-click or drag the **Subtract** action from the **Datetime** node in the **Actions** palette.
2. Select an option from the **Source date and time variable** list to specify the variable that contains the value from which you want to subtract the time unit.
3. Enter the value you want to subtract in the **Time value to subtract** field.
4. Select an option from the **Time unit to subtract** list to specify the time unit you want to subtract.

Choose from the following time unit options:

- Milliseconds
- Seconds
- Minutes
- Hours
- Days
- Weeks
- Months
- Years

---

**Note:** This action accounts for leap years. For example, if the action subtracts 31 days from March 31, 2020, the action output is February 29, 2020. Whereas, if the action subtracts 31 days from March 31, 2019, the action output is February 28, 2019.

---

5. Select the Datetime variable from the **Assign the output to a variable** list to specify the variable to which you want to assign the output.
6. Click **Save**.



To see the output value, convert the value in the Datetime variable to a String variable, then print the value with the **Message Box** action. For more information, see [Using the To string action](#) on page 2489 and [Using the Message box action](#) on page 2796.

## Using the To string action

Use the **To string** action to convert a datetime value to a string value. This action enables you to select a predefined format or specify a custom format for the output value.

You can select a predefined format for datetime or provide a custom format based on your requirements. See [Datetime formats](#) on page 2489.

To convert a datetime value to string, do the following:

1. Double-click or drag the **To string** action from the **Datetime** node in the **Actions** palette.
2. Select an option from the **Source date and time variable** list to specify the variable that contains the datetime value that you want to convert to a string value.
3. Select an option from the **Formats** list to specify the predefined format in which you want to store the string value.
4. Select the **Custom format** to specify a custom format based on your requirement.  
[Datetime formats](#) on page 2489
5. Select the string variable that you want to use to store the converted value from the **Assign the output to a variable** list.
6. Click **Save**.

## Datetime formats

Specify a custom format when you convert a datetime value to a string value by using the predefined formats available in Automation Workspace.

The **To string** action enables you to convert a datetime value to a string value. This action also enables you to select a predefined datetime format or specify a custom format.

## Predefined datetime format

When you convert a datetime value to a string value, the predefined datetime formats are available in the **Formats** list. The following predefined datetime formats are available:

- **BASIC\_ISO\_DATE**: Converts the datetime value to a `yyyymmdd+offset` value string value.
- **ISO\_LOCAL\_DATE**: Converts the datetime value to a `yyyy-mm-dd` string value.
- **ISO\_OFFSET\_DATE**: Converts the datetime value to a `yyyy-mm-dd+offset` value string value. The offset value indicates the difference between the local time and UTC in hours and minutes.
- **ISO\_DATE**: Converts the datetime value to a `yyyy-mm-dd+offset` value or `yyyy-mm-dd` string value. The system adds an offset value if it is available.
- **ISO\_LOCAL\_TIME**: Converts the datetime value to a `hh:mm:ss.SSS` string value.
- **ISO\_OFFSET\_TIME**: Converts the datetime value to a `hh:mm:ss.SSS+offset` value string value. The offset value indicates the difference between the local time and UTC in hours and minutes.

- **ISO\_TIME**: Converts the datetime value to a `hh:mm:ss.SSS`, or `hh:mm:ss.SSS+offset value` string value. The offset value indicates the difference between the local time and UTC in hours and minutes.
- **ISO\_LOCAL\_DATE\_TIME**: Converts the datetime value to a `yyyy-mm-ddThh:mm:ss.SSS` string value.
- **ISO\_OFFSET\_DATE\_TIME**: Converts the datetime value to a `yyyy-mm-ddThh:mm:ss.SSS+offset value` string value. The offset value indicates the difference between the local time and UTC in hours and minutes.
- **ISO\_ZONED\_DATE\_TIME**: Converts the datetime value to a `yyyy-mm-ddThh:mm:ss.SSS+offset value[zone id]` string value. The offset value indicates the difference between the local time and UTC in hours and minutes. The 'zone id' in the format represents the time zone.
- **ISO\_DATE\_TIME**: Converts the datetime value to a `yyyy-mm-ddThh:mm:ss.SSS`, `yyyy-mm-ddThh:mm:ss.SSS+offset value`, or `yyyy-mm-ddThh:mm:ss.SSS+offset value[zone id]` string value.
- **ISO\_ORDINAL\_DATE**: Converts the datetime value to a `yyyy-[day of the year]`, or `yyyy-[day of the year]+offset value` string value. For example, if the datetime value is 'January 25, 2018', it is formatted as '2018-25' where '25' indicates the day of the year.
- **ISO\_WEEK\_DATE**: Converts the datetime value to a `yyyy-[week of the year]-[day of the week]`, or `yyyy-[week of the year]-[day of the week]+offset value` string value. For example, if the datetime value is 'January 25, 2018', it is formatted as '2018-W4-4' where 'W4' indicates that it is the fourth week of the year and '4' indicates the day of that week.
- **ISO\_INSTANT**: Converts the datetime value to a `yyyy-mm-ddThh:mm:ss.SSSZ` string value.
- **RFC\_1123\_DATE\_TIME**: Converts the datetime value to a `[day of the week], [day of the month] [month in 'MMM' format] [year in 'YYYY' format] hh:mm:ss`, or `[day of the week], [day of the month] [month in 'MMM' format] [year in 'YYYY' format] hh:mm:ss+offset value` string value. For example, if the datetime value is '2018-01-25 10:15', it is formatted as 'Thu, 25 December 2018 10:15:00GMT'. The 'GMT' indicates that there is no offset available.

## Custom datetime format

Use predefined conventions to specify a custom datetime format. The following conventions are available:

---

**Note:** All predefined conventions that are used to specify a custom datetime format are case-sensitive.

---

- 'y' and 'Y': Specify a year as 'yy' or 'yyyy' and specify the year of the week as 'YY' respectively.
- 

**Note:** The 'yy' and 'YY' provide the same result, however the result differs if you use a datetime format that includes the last week or the first week of a calendar year.

For example, when you use a datetime format as 12/26/22 (2022/12/26), then perform actions to delete the files from the previous year, the datetime format 'yy' provides correct result (12/26/21) and the files from the year 2021 are deleted. If you use the datetime format 'YY' (indicating the year of the week in which the specific day appears), then files from the year 2022 will be deleted because the day 12/26/21 falls during the last week of 2021 and also during the first week of 2022.



We recommend that you use the datetime format 'yy' when you want to consider the calendar year only and not a specific week of that calendar year.

- 'M': Specify a month as 'M', 'MM', 'MMM' (abbreviated name of the month, for example, Jan, Feb), or 'MMMM' (full name of the month, for example, January, February).

**Note:** The 'MMM' and 'MMMM' datetime formats work depending on the operating system on which the Bot Agent runs and your location setting.

- 'd': Specify a day as 'd' or 'dd'.
- 'D': Specify a day in a year as 'D' or 'DD'.
- 'E': Specify day of the week as 'EEE' (Sun-Sat) or 'EEEE' (Sunday-Saturday).

**Note:** The 'EEE' and 'EEEE' datetime formats work depending on the operating system on which the Bot Agent runs and your location setting.

- 'h' or 'H': Specify an hour as 'hh' or 'HH'.

**Note:** HH is a 24-hour time format, and hh is a 12-hour time format with AM or PM. When you use the hh format, add a at the end of the datetime format. For example, if the system locale language is English, the input will be 2018-12-25 10:50:55.999 AM and the format will be yyyy-MM-dd hh:mm:ss.SSS a where a indicates AM or PM. However, on computers that use operating systems in languages other than English, use AM or PM marker accordingly. For example, on a Japanese language operating system, the input must have AM or PM marker in Japanese, such as 2018-12-25 10:50:55.999 午前, where 午前 means AM in Japanese, and the format must be yyyy-MM-dd hh:mm:ss.SSS a.

- 'a': Specify an AM/PM marker for the 12-hour time format
- 'm': Specify a minute in an hour as 'mm'.
- 's': Specify a second in a minute as 'ss'.
- 'S': Specify a millisecond as 'SSS'.
- 'z': Specify a timezone, such as 'Pacific Standard Time' and 'Indian Standard Time'.
- 'Z': Specify an offset time for a timezone, such as '+0550' for 'Indian Standard Time'.

**Important:** On computers where the display language is set to Simplified Chinese or Traditional Chinese, when you use the dd-MMM-yyyy custom datetime format to convert a datetime value to a string value, the output might show incorrectly.

You can use the preceding convention to specify the custom format that you want to use for converting a datetime value. Some examples that use the preceding convention are as follows:

Format	Sample output
yyyy-MM-dd	2018-09-30
yyyy-M-d	2020-9-8
dd-MM-yyyy	25-12-2018
yyyy-MM-dd HH:mm:ss	2018-25-12 23:50:55
hh:mm:ss.SSS a	10:15:35.889 AM / 10:15:35.889 PM
yyyy-MM-dd HH:mm:ss.SSS	2018-12-25 23:50:55.999
yyyy-MM-dd HH:mm:ss.SSS Z	2018-12-25 23:50:55.999 +0530
h.mm a	4.10 PM
D 'days', yyyy	365 days, 2019

## Delay package

Use the `Delay` package to add a timed delay to the logic.

You can use timed delay to add the amount of time a bot waits before moving to the next task. You can specify the amount of time in milliseconds or seconds.

**Note:** You can specify a maximum time delay of 9999999 milliseconds or seconds.

Example: If we give a timed delay of 5 seconds, the bot will wait for 5 seconds and then execute the action following the delay.

The `Delay` package includes the following action:

Action	Description
Delay	See <a href="#">Delay action in Delay</a> on page 2492.

Related reference

[Delay package updates](#) on page 862

Review the updates in released versions of the `Delay` package such as new and enhanced features as well as fixes and limitations. The page also lists the release dates of each version, and the compatible Control Room and Bot Agent versions.

## Delay action in Delay

Use the **Delay** action in the `Delay` package to add a timed delay.

### Settings

- Select the **Delay type** as **Regular** or **Random**.

- Select the **Regular** option to delay the operation for a fixed period of time.
- If you select **Random**, specify the time range in the **From** and **To** fields for the system to select a random delay within the specified range.

You can add **Random** delay with different waiting time for each bot run at a given command level without having to change the bot.

Example: Use **Random** delay when running bots simultaneously on several machines through a workload management queue before executing a database or recorder, or the FTP action. This would reduce the number of concurrent requests made to a database or the FTP server and the performance of the systems will not be adversely impacted.

- Select the **Time unit** in **Milliseconds** or **Seconds**.

## Dictionary package

The **Dictionary** package contains actions that enable you to do various operations on dictionary-type values.

### Dictionary data type

A dictionary is a collection of key-value pairs, in which each key has a value. It is similar to an entry in a dictionary, where each word has a corresponding definition or explanation. The key is similar to the word, and the definition or explanation is similar to its value. The properties of dictionary entries are as follows:

- Keys are unique within each dictionary variable. If you try to duplicate a key, you will overwrite its value.
- Key names cannot be changed.
- Keys are case-sensitive.
- Keys can contain leading and trailing whitespaces.

Each key-value pair in a dictionary is separated by a colon. The key-value pairs are separated from each other by commas. An example of a dictionary is as follows:

```
invoice = {'CustomerID': 9876, 'Location': 'XYZ', 'Amount': 12,34,567}
```

In the example, 'CustomerID', 'Location', and 'Amount' are keys, and the corresponding value assigned to each key is separated by a colon.

### Working with variables of dictionary data type

A dictionary variable can hold values of boolean, number, or string data subtype. When initializing a dictionary variable, you can select the **Any** data subtype in order to hold any of the three data subtypes. You can manually enter values by creating a new variable or selecting an existing one from the Variables menu, and then clicking **Add**.

Use a dictionary variable to hold [email](#) or [PDF](#) properties.

---

**Note:** When you use either the dictionary variable or the **Get** action from the Dictionary package to verify whether a key exists in a dictionary variable and retrieve its corresponding value, different output displays if the key does not exist:

- The dictionary variable retrieves a null value.
- The **Get** action retrieves a blank value.

---

## Actions in the Dictionary package

The following actions are available:

Action	Description
<b>Assign</b>	See <a href="#">Assign action in Dictionary</a> on page 2494.
<b>Get</b>	See <a href="#">Get action in Dictionary</a> on page 2496.
<b>Put</b>	See <a href="#">Put action in Dictionary</a> on page 2497.
<b>Remove</b>	See <a href="#">Remove action in Dictionary</a> on page 2497.
<b>Size</b>	See <a href="#">Size action in Dictionary</a> on page 2497.

Related tasks

[Example of passing a value between bots](#) on page 3206

Learn how to pass a value from one Task Bot to another by using a dictionary variable.

Related reference

[Dictionary package updates](#) on page 864

Review the updates in released versions of the Dictionary package such as new and enhanced features as well as fixes and limitations. The page also lists the release dates of each version, and the compatible Control Room and Bot Agent versions.

## Assign action in Dictionary

You can use the **Assign** action in the Dictionary package to assign the value of a source dictionary to the destination dictionary variable.

### Example of assigning a source dictionary value

This example shows you how to create a bot that assigns the source dictionary value to the destination dictionary variable.

1. Create a bot.
  - a) On the left panel, click **Automation**.  
A list of available bots and forms is displayed.
  - b) Click **Create a bot**.
  - c) Enter the bot name: `Dictionary_Assign`.
  - d) Click **Create and Edit**.
2. Create the user-defined variables using the **Create variable (+)** icon at the top of the **Variables** menu.

- Create two variables of **Dictionary** type:
  - Source dictionary variables: AppraisalData\_FY22
  - Destination dictionary variable: AppraisalData\_FY23
- Enter the following key-pair values in the source and destination dictionary variables.

AppraisalData\_FY22 (Source)

Key	Value
Name	Bob, John, Sarah
Age	52, 26, 42
Job title	Sr. Developer, Technical Writer, HR
Email ID	bob.jones@abc.com, john@abc.com, sarah@abc.com
Phone number	752000000, 753000000, 754000000
CTC	\$160,000, \$110,000, \$100,000
Bonus component	Sr. Developer: 15%, Technical Writer: 15%, HR: 15%
Employment type	Sr. Developer: Permanent, Technical Writer: Contractor, HR: Permanent

AppraisalData\_FY23 (Destination)

Key	Value
Name	Bob, John, Sarah
Age	52, 26, 42
Job title	Sr. Developer, Technical Writer, HR
Email ID	bob.jones@abc.com, john@abc.com, sarah@abc.com
Phone number	752000000, 753000000, 754000000
CTC	\$170,000, \$120,000, \$110,000

3. To assign the value of the source dictionary to the destination dictionary variable, double-click or drag the **Dictionary > Assign** action.
  - a) Select the source dictionary variable from the drop-down list or create and enter AppraisalData\_FY22 in the **Select the source dictionary variable** field.
  - b) To hold the output, select a variable or create and enter AppraisalData\_FY23 in the **Select the destination dictionary variable** field.

**Note:** If both (source and destination) dictionary variables contain the same keys, the destination dictionary variable will be overwritten by the value of the source dictionary variable.

4. To print the value of the destination variable (AppraisalData\_FY23), double-click or drag the **Message box** action. Enter the following values in the **Enter the message to display** field:
  - \$AppraisalData\_FY23{"Job tile"}\$
  - \$AppraisalData\_FY23{"CTC"}\$
  - \$AppraisalData\_FY23{"Bonus component"}\$
  - \$AppraisalData\_FY23{"Employment type"}\$
5. Click **Save** and then **Run**.

The output is displayed as:

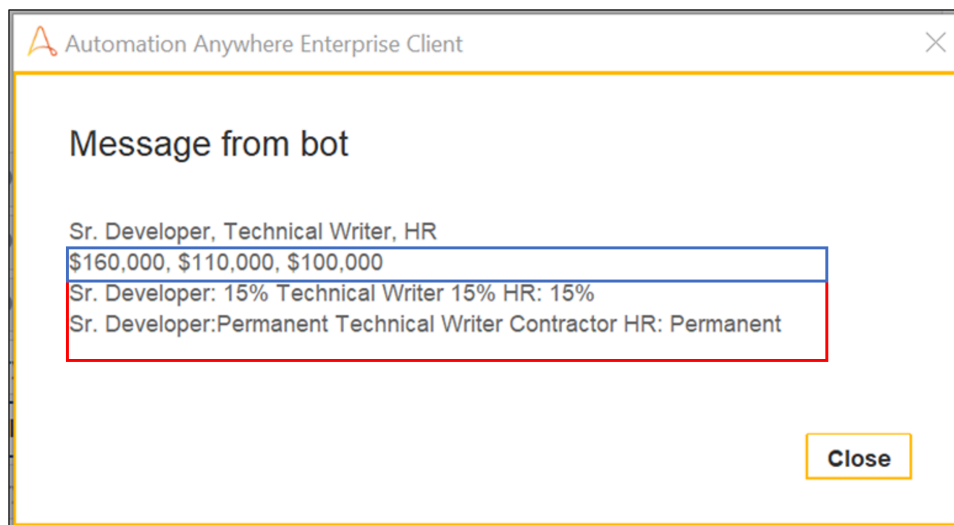

The output shows that the key and its values (Bonus and Employment type) in the source variable (AppraisalData\_FY22) are assigned to the destination variable (AppraisalData\_FY23). Additionally, the source and destination variables contain the same keys for CTC. As a result, the value in the destination dictionary variable is overwritten by the value of the source dictionary variable.

## Get action in Dictionary

Use the **Get** action in the Dictionary package to verify if a key exists in a dictionary variable and return the corresponding value.

### Settings

- Select the dictionary variable from the drop-down list.
- Enter the key name.
- Select a dictionary variable or create one to hold the output.



## Put action in Dictionary

Use the **Put** action in the Dictionary package to assign a value to a key in the dictionary. If the key is already associated with a value, the value can be updated.

### Settings

- Select the dictionary variable from the drop-down list.
- Enter the key name.
- Assign a value to the key.

You can choose the **Static value** tab to add the values manually or the **Variable** tab to add the existing variables.

---

**Note:** If you choose the Static value option, ensure that the data type of static value matches the subtype of the dictionary variable. Otherwise, you might encounter type cast errors when you use the dictionary variables.

---

- Select the variable to hold the previous value.

## Remove action in Dictionary

Use the **Remove** action in the Dictionary package to remove a value from the specified key. The removed value is assigned to a variable selected from the **Assign removed item to variable** list.

### Settings

- Select the dictionary variable from the drop-down list.
- Enter the key name.
- Select the variable to hold the removed value.

## Size action in Dictionary

Use the **Size** action in the Dictionary package to retrieve the number of entries in the dictionary.

### Settings

Retrieves the number of entries in the dictionary specified in the **Dictionary variable** field and assigns the output to a number variable selected from the **Assign the output to variable** list.

## DLL package

A dynamic-link library (DLL) file contains a shared library of functions that can be used by Windows programs. The **DLL** package uses a `.dll` file as reference and calls functions from the bot.

### Before you start

Perform the following actions within the **DLL** package as part of using the set of available actions:

---

**Note:**

- If you create bots using custom DLL, and the custom DLL has a dependency on the Apache log4net library, then we recommend using:
  - log4net version 2.0.11 or later in the custom DLL.
  - Update the Bot Agent (version 21.210 or later) even if the Bot Agent update is optional.
- Only the DLLs built using the Microsoft .NET Framework are supported.
- The Run DLL package is compatible with the following versions of Microsoft .NET: 4.6, 4.7, and 4.8.
- When you create a bot and use the local session with loop, ensure that you use the close session action in the bot. If you do not use the close session command, then the local session will open `AutomationAnywhere.ManagedDLLWrapper.exe` with each iteration of the loop. As a result, you will run out of memory space and the bot will fail.

---

**Important:** If you use different versions of the DLL package in a parent bot and a child bot, the capability to share a session across bots is currently not supported. To share a session across parent and child bots, ensure that you use the same version of the package in both the parent and child bots.

---

1. Use the **Open** action to specify the location of the `.dll` file you want to use and session name. Use this same session name for the other actions. The `.dll` referenced is automatically added as a bot dependency.
2. Use the **Run function** action to run a function from the `.dll` and save its output value as a variable.
3. After running the required functions, close the `.dll` reference. It is important to close the `.dll` reference to free the memory of the operating system.

Windows and appropriate versions of Microsoft .NET Framework are available on the devices running the DLLs.

To review the bot launcher logs, navigate to `C:\ProgramData\AutomationAnywhere\BotRunner\Logs\<current month>\Bot_Launcher-<today's date>.log.zip`. Each zipped folder contains a file with data on the code execution, which is useful for debugging.

---

**Note:** If the `.dll` file uses .NET functions or classes from another `.dll` file, you must add the second `.dll` file as a manual dependency of the bot.

---

[Bot dependencies](#) on page 2359

When you import multiple DLLs that have one main DLL and other DLLs are referenced from it, ensure you have all the DLLs in one folder. Also, the referenced DLLs must be called using a session name that is different from the name used in the main DLL. Your bot execution will fail if the same session name is used in both the main and the referenced DLLs.

## Actions in the DLL package

The **DLL** package includes the following actions:

Action	Description
Close	See <a href="#">Close action</a> on page 2502
Open	See <a href="#">Open action</a> on page 2503
Run function	See <a href="#">Using the Run function action</a> on page 2505.

## Supported data types in DLL functions

The following table list the variables and data types that you can use as an input or output parameter in DLL functions.

**Note:** The **Run function** action does not support any user-defined data types in the **Parameter to the function** or **Assign output to variable** field.

Variable type as input or output parameters	Supported data types in .NET
String	<ul style="list-style-type: none"> <li>• Char</li> <li>• Byte</li> <li>• String</li> <li>• string</li> <li>• SByte</li> </ul>
Number	<ul style="list-style-type: none"> <li>• UInt16</li> <li>• Int16</li> <li>• UInt32</li> <li>• Int32</li> <li>• UInt64</li> <li>• Int64</li> <li>• Int</li> <li>• Single</li> <li>• Decimal</li> <li>• Float</li> <li>• Double</li> </ul>

Variable type as input or output parameters	Supported data types in .NET
Boolean	<ul style="list-style-type: none"> <li>• Boolean</li> <li>• bool</li> </ul>
Datetime	<ul style="list-style-type: none"> <li>• Datetime</li> </ul>
List	<ul style="list-style-type: none"> <li>• UInt16[]</li> <li>• Int16[]</li> <li>• Int32[]</li> <li>• Int64[]</li> <li>• Int[]</li> <li>• Char[]</li> <li>• Single[]</li> <li>• Decimal[]</li> <li>• Float[]</li> <li>• Double[]</li> <li>• Boolean[]</li> <li>• bool[]</li> <li>• Byte[]</li> <li>• String[]</li> <li>• Datetime[]</li> <li>• List&lt;UInt16&gt;</li> <li>• List&lt;Int16&gt;</li> <li>• List&lt;Int32&gt;</li> <li>• List&lt;Int64&gt;</li> <li>• List&lt;Int&gt;</li> <li>• List&lt;Char&gt;</li> <li>• List&lt;Single&gt;</li> <li>• List&lt;Decimal&gt;</li> <li>• List&lt;Float&gt;</li> <li>• List&lt;Double&gt;</li> <li>• List&lt;Boolean&gt;</li> <li>• List&lt;bool&gt;</li> <li>• List&lt;Byte&gt;</li> <li>• List&lt;String&gt;</li> <li>• List&lt;Datetime&gt;</li> <li>• List&lt;SByte&gt;</li> <li>• List&lt;UInt32&gt;</li> <li>• List&lt;UInt64&gt;</li> </ul> <hr/> <p><b>Note:</b> The C# IList data type is not supported and does not work with the Automation 360 List data type.</p> <hr/>

Variable type as input or output parameters	Supported data types in .NET
Table	<ul style="list-style-type: none"><li>• UInt16[,]</li><li>• Int16[,]</li><li>• Int32[,]</li><li>• Int64[,]</li><li>• Int[,]</li><li>• Char[,]</li><li>• Single[,]</li><li>• Decimal[,]</li><li>• Float[,]</li><li>• Double[,]</li><li>• Boolean[,]</li><li>• bool[,]</li><li>• Byte[,]</li><li>• String[,]</li><li>• Datetime[,]</li><li>• Byte[,]</li><li>• UInt32[,]</li><li>• UInt64[,]</li></ul> <hr/> <p><b>Note:</b> The <b>Table</b> type variable is equivalent to a two-dimensional array type variable in .NET.</p> <hr/>

Variable type as input or output parameters	Supported data types in .NET
Dictionary	<ul style="list-style-type: none"> <li>• Dictionary&lt;String,UInt16&gt;</li> <li>• Dictionary&lt;String,Int16&gt;</li> <li>• Dictionary&lt;String,Int32&gt;</li> <li>• Dictionary&lt;String,Int64&gt;</li> <li>• Dictionary&lt;String,Int&gt;</li> <li>• Dictionary&lt;String,Char&gt;</li> <li>• Dictionary&lt;String,Single&gt;</li> <li>• Dictionary&lt;String,Decimal&gt;</li> <li>• Dictionary&lt;String,Float&gt;</li> <li>• Dictionary&lt;String,Double&gt;</li> <li>• Dictionary&lt;String,Boolean&gt;</li> <li>• Dictionary&lt;String,bool&gt;</li> <li>• Dictionary&lt;String,Byte&gt;</li> <li>• Dictionary&lt;String,String&gt;</li> <li>• Dictionary&lt;String,Datetime&gt;</li> <li>• Dictionary&lt;Int,String&gt;</li> <li>• Dictionary&lt;Decimal,String&gt;</li> <li>• Dictionary&lt;Boolean,String&gt;</li> <li>• Dictionary&lt;String,SByte&gt;</li> <li>• Dictionary&lt;String,UInt32&gt;</li> <li>• Dictionary&lt;String,UInt64&gt;</li> </ul> <hr/> <p><b>Note:</b> When creating the .Net DLL function, use the IDictionary data type instead of the Dictionary data type.</p> <hr/>

#### Related tasks

[Example of using the DLL package](#) on page 3211

Build a very simple DLL that will generate a message. Create a bot to run the DLL.

#### Related reference

[DLL package updates](#) on page 865

Review the updates in released versions of the DLL package such as new and enhanced features as well as fixes and limitations. The page also lists the release dates of each version, and the compatible Control Room and Bot Agent versions.

## Close action

The Close action in the DLL package enables you to close the DLL reference.

## Settings

Closes the current session. In the **Session name** field, enter the name of the session.

## Open action

The Open action in the DLL package enables you to open the reference file.

### Settings

- In the **File path** field, specify the location of the path.
- Select any of the following tabs to specify the location of the DLL you want to use:
  - **Control Room file**: Use a DLL that is available in the Control Room.
  - **Desktop file**: Use a DLL that is available on a device.
  - **Variable**: Use a file variable to specify the location of the DLL.
- Select any of the following tabs to create a DLL session:
  - **Local session**: Specify a session name that can be used only in the current bot.
  - **Global session**: Specify a session name that can be used across multiple bots such as parent bots, child bots, and other child bots of the parent bots.  
See [Sharing sessions across bots](#) on page 2503.
  - **Variable**: Specify a session variable that can be used to share that session with other child bots.

When you run the bot, it passes the session variable to the child bot, which enables the child bot to use the DLL opened in the parent bot.

---

**Note:** The DLL package supports only DLLs written in C#.

---

## Sharing sessions across bots

You can share a session across multiple bots so that you can use the same DLL, Microsoft Excel worksheet, and terminal across these bots. You can share a session across child bots, parent bots, and other child bots of the parent bots.

Use the **Global session** option in the **Open** action of the DLL package to pass on the exact state of an application or DLL from one bot to another bot and vice versa.

Sharing a session eliminates the need to repeatedly open and close a session when using the same file across multiple bots. When you share a session across bots, all subsequent actions in that bot, child bots, parent bots, and other child bots of the parent bots can use that DLL session without any additional steps by using the same global session name in these bots.

For example, consider you have added the **Open** action with the **Global session** selected at the eighth line of a bot. All the actions that are executed after the eighth line in the current bot, child bots, and parent bots can use that DLL session without any additional step.

---

**Note:** Use the **Open** action to open a global session as the first action in your bots.

---

## Using the Run function (Legacy) action

Use the **Run function (Legacy)** action to run a function within the .dll file and specify the parameters to pass a function and store the output as a variable.

- Use a dictionary variable to pass the parameters to a function. The dictionary key contains the parameter name to pass to a function.
- If the .dll file uses .NET functions or classes from another .dll file, you must add the second .dll file as a manual dependency of the bot.

[Bot dependencies](#) on page 2359

- When you use **Run function** or the **Run function (Legacy)** action, ensure that you use the supported data types for DLL functions.

See [DLL package](#) on page 2498.

Follow these steps to run a function:

1. In the **Actions** palette, double-click or drag the **Run function (Legacy)** action from the **DLL** package.
2. In the **Session name** field, enter the name of the session.
3. In the **Enter the namespace** field, specify the namespace.  
You can specify any of the namespaces defined in the DLL file.

---

**Note:** Ensure that the value you have provided in the field is correct.

---

**Important:** This field is case-sensitive.

---

4. In the **Enter the class name** field, specify the name of the class.  
You can specify the name of any classes available in the namespace.

---

**Important:** This field is case-sensitive.

---

5. In the **Enter the name of function to be executed** field, specify the name of the function to execute.  
Ensure that the name you have provided is correct and available in the class specified in the previous step.

---

**Important:** This field is case-sensitive.

---

6. Optional: In the **Parameters to the function** list, select the variable that contains all the parameters needed by the function.  
You can use Boolean, datetime, dictionary, list, number, string, or table variable types to pass parameters to the function.

---

**Note:** Use the dictionary subtype Any to enable the bot to pass parameters of different data types to the function including Boolean, numeric, and string.

---

Specify the dictionary key as the parameter name to provide the dictionary value as the parameter value. For example, you have a function `ReturnSum` that returns the sum of two numeric values and want to pass `Param1` and `Param2` as its parameters. Configure a dictionary variable with two keys: `Param1` and `Param2`, each with the value that you want to pass.



7. Optional: In the **Assign output to variable** list, select a variable to use to store the output of the function.  
You can use Boolean, datetime, dictionary, list, number, string, or table variable types to store the output based on the type of output the function returns.
8. Click **Save**.

## Using the Run function action

Use the **Run function** action to run a function within a .dll file and specify the parameters to pass a function and store the output as a variable.

- This action enables you to pass a parameter of any type.
- The **Run function** action does not support the use of Windows Forms.
- If the .dll file uses .NET functions or classes from another .dll file, you must add the second .dll file as a manual dependency of the bot.  
[Bot dependencies](#) on page 2359
- This action supports overloaded functions starting from Enterprise A2019.17. The action can handle .dll files that contain multiple functions of the same name. It calls the function based on the number of parameters passed.
- When you use this action, ensure that you use the supported data types for DLL functions.

[DLL package](#) on page 2498

Perform the follow steps to run a function:

1. In the **Actions** palette, double-click or drag the **Run function** action from the **DLL** package.
2. In the **Session name** field, enter the name of the session.
3. In the **Enter the namespace (Optional)** field, specify the namespace.  
You can specify any of the namespaces defined in the DLL file.

---

**Note:** Ensure that the value you have provided in the field is correct.

---

**Important:** This field is case-sensitive.

---

4. In the **Enter the class name** field, specify the name of the class.  
You can specify the name of any of the classes available in the namespace.

---

**Important:** This field is case-sensitive.

---

5. In the **Enter the name of function to be executed** field, specify the name of the function to execute.  
Ensure that the name you have provided is correct and available in the class specified in the previous step.

---

**Important:** This field is case-sensitive.

---

6. Optional: In the **Input parameters** section, click the **Add Parameters** button.
  - a) In the **DLL parameter details** dialog box, in the **Parameter name** field, enter the name of the parameter.
  - b) From the **Parameter type** list, select a data type.

For Integer data type (UInt16, Int16, Int32, Int64, Int, Single, Float, Decimal, Double, UInt32, or UInt64), you can use a value from a credential vault or a credential variable as input parameter.

- c) In the **value** field, enter the value that you want to pass .

If you select the Integer data type, you can choose from the following options:

- **Number:** In the number field, enter the value that you want to pass.
- **Credential:** To use a value from a credential vault, select **Credential**. To use a credential variable, select **Variable**.

For more information about credential vaults and how to use them, see [Credentials and lockers in the Credential Vault](#) on page 1861.

Repeat Step 6 to add multiple parameters.

---

**Important:** The names of the parameters you add and their order must be the same as in the DLL function.

---

7. Use the **Run function in background** option when no Windows system-related operations, such as such as keystroke, mouse click, or window switching, are called under the C# DLL. You can select the **Run function in background** check box to bypass the intermediate window (AAZeroSizeForm) and run the C# DLL under the console application without the form. We recommend that you select this check box if the DLL function is not interacting with the Windows API to perform operations such as keystroke, mouse click, or window switching. This feature also helps to improve the performance of the DLL execution if the **Run function in background** check box is selected.
8. Optional: In the **Assign output to variable** list, select a variable to use to store the output of the function.  
You can use Boolean, datetime, dictionary, list, number, string, or table variable types to store the output based on the type of output the function returns.
9. Click **Save**.

## Document Classifier package

Document Classifier package enables you to group or classify documents into appropriate learning instances for content extraction in Automation 360 IQ Bot.

---

### Note:

- From Automation 360 v.30 onwards, the IQ Bot Classifier package is renamed to Document Classifier package.
- You can download the Document Classifier package from [IQ Bot downloads](#) link.

---

Classifier (Number of pages) license is required to process documents against any of the associated actions of the Document Classifier package.

The Document Classifier package enables you to segregate different types of documents into respective categories. This output can then be used to build logic to merge pages in a document for enhanced data extraction.

See [How to merge documents in IQ Bot Classifier package \(A-People login required\)](#).

## Actions in the Document Classifier package

The package contains the **Classify**, **Classify documents**, and **Train Classifier** actions. You can use these actions to create a model file, and use the file to classify uploaded documents into different folders. These actions work as a precursor to document processing.

Actions	Description
Classify	IQ Bot Classify action groups the pages of an input document based on the model file that was created using IQ Bot Train Classifier action.  See <a href="#">Using Classify action</a> on page 2507
Classify documents	The IQ Bot Classify document action groups the input documents based on the first page of each document, using the selected model file that is created with the IQ Bot Train Classifier action. Use this action if you are manually creating document groups.  See <a href="#">Using the Classify document action</a> on page 2509
Train Classifier	See <a href="#">Using Train Classifier action</a> on page 2510

Watch the following video to understand how to use the Document Classifier package:

To learn more, review the courses in IQ Bot Developer learning trail: [IQ Bot Developer Training \(A-People login required\)](#).

Related concepts

[About the Classifier](#) on page 3743

Learn about how documents are classified and the factors that affect classification.

## Using Classify action

IQ Bot Classify action groups the pages of an input document based on the model file that was created using IQ Bot Train Classifier action.

- If you have not done so already, use the **Train Classifier** action to create a model file. See [Using Train Classifier action](#) on page 2510.
- Ensure the input files are in PDF format. If the input file is an image file (.gif, .jpg, .png, or .tiff), convert the image to a PDF. See [Using Convert Image To PDF action](#) on page 2743.

Build a bot with the **Classify** action within a **Loop** action to iteratively classify each file in the selected folder.

1. In the **Actions** palette, double-click or drag the **Loop** action from the **Loop** package.
2. In the **Loop Type** field, select the **Iterator** option.
3. In the **Iterator** field, select **For each file in folder** from the drop-down list.
4. In the **Folder path** field, select the path to the folder that contains the input files.

5. In the **Assign file name and extension to this variable** field, create or select a dictionary variable to store the names and extensions of the files in the selected folder path.  
For this example, we will use a dictionary variable named dictFile.
6. In the **Actions** palette, double-click or drag the **Classify** action from the **Document Classifier** package.
7. In the **Input file** field, enter a dynamic file path using a variable.
  - a) Add a file path pointing to the folder, for example `C:\input\`.
  - b) Add the dynamic file name string: `dictFile (name) $.dictFile (extension) $`.

---

**Note:** Be sure to include a period between the variable holding the file name and the one holding the extension.

---

The name and extension keys are predefined. When inserted and run in a loop, the action iterates through the entire folder and calls the files in the folder one at a time. The **Input file** value looks like this: `C:\input\dictFile (name) $.dictFile (extension) $`

8. In the **Classifier** field, provide the file path to the model file.  
You can either select the `.zip` folder or extract the `.icmf` file from this folder and select it.

---

**Note:** For better classification results and performance, we recommend that you use the `.icmf` file available in the `.zip` folder obtained from the **Train Classifier** action.

---

9. Use the **Output folder path** option to save the classification output document.
10. Optional: Configure the following **ADVANCED SETTINGS**:
  - **Confidence threshold (%)**: If the confidence value of the category prediction of a page is less than the confidence threshold, it is moved to the `Unclassified` folder.
  - **Save classification output variable**: Save the classification results as a list of dictionaries with the following keys:
    - fileName
    - pageIndex
    - category
    - confidence

---

**Note:**

- You can select the type of classification in the Document Classifier:
  - Image-based classification
  - Text-based classification
  - Both image and text-based classification
- To project a higher confidence threshold, we suggest that you calculate the confidence threshold when the document pages are similar. To determine the required confidence threshold, you can review the confidence values from the classification output.
- The Document Classifier can auto-detect the language for classification, and supports all languages supported by ABBYY (an optical character recognition application).

- 
11. Click **Save** and **Run**.

The pages from the output document are saved in the respective subfolders, based on the categories created in the model file. Any previously-classified documents in the output folder will be overwritten.

You can use each subfolder of similar documents to create and train a learning instance to extract data from the documents. See [Create a learning instance](#) on page 3746.

## Using the Classify document action

The IQ Bot Classify document action groups the input documents based on the first page of each document, using the selected model file that is created with the IQ Bot Train Classifier action. Use this action if you are manually creating document groups.

- Build and run a bot with the **Train Classifier** action to create a model file. See [Using Train Classifier action](#) on page 2510.
- [Create a new document group](#) on page 3745

1. In the **Actions** palette, double-click or drag the **Classify document** action from the **Document Classifier** package.
2. In the **Input file** field, provide the default filepath for incoming files for classification.
3. In the **Classifier** field, provide the filepath of the model file.

You can either select the `.zip` folder or extract the `.icmf` file from this folder and select it.

---

**Note:** For better classification results and performance, we recommend that you use the `.icmf` file available in the `.zip` folder obtained from the **Train Classifier** action.

---

4. Use the **Output folder path** option to save the classification output documents. The pages from the output document are saved in the respective subfolders based on the categories created in the model file.
5. Optional: Configure the **Confidence threshold (%)**.  
If the confidence value of the category prediction of a document is less than the confidence threshold, the document is moved to the `Unclassified` folder.
6. Select from **Normal mode** or **Express mode**.
  - **Normal mode:** The Classifier parses the entire document and groups it based on the fields in all the pages.
  - **Express mode:** The Classifier groups the document based on the fields in the first page.
7. Select or create a list variable to hold the output.  
The classification results as a list with the following keys:
  - `fileName`
  - `pageIndex`
  - `category`
  - `confidence`

## Using Train Classifier action

Use the **Train Classifier** action to create a model file that is used by the **Classify** action to sort the documents into required categories for input.

Before building the bot, collect example documents and categorize them into folders. Ensure the set of example documents meets the following requirements:

- Has at least two categories.
- A minimum of 15 pages per category (20 pages recommended).
- Split input PDF documents that have multiple pages into single-page PDF documents. See [Using the Split document action](#) on page 2887.

For example, if you have a PDF document that has three pages, split it into three single-page PDF documents.

If these minimum requirements are not met, an error message is displayed during bot runtime.

Each folder has a selection of documents that are a sample of the documents that the associated learning instance will process. The **Train Classifier** action will read through the files in the folders, and build a model based on the documents stored inside each folder.

---

**Note:** As ABBYY FineReader Engine OCR is now downgraded to version 12.2 from version 12.4, older `.icmf` files cannot be used to retrain models in Automation 360 v.24 of the Document Classifier package. If you want to add more categories or more files into your existing categories, you must create a new model.

---

1. In the **Actions** palette, double-click or drag the **Train Classifier** action from the **Document Classifier** package.
  2. Click **Train** to continue creating a new model file.
  3. Optional: If you have an existing model file, click **Re-Train**.
    - a) Use the **Training folder path** field to select an existing folder path from the **Desktop folder** tab.  
Alternatively, click the **Variable** tab to manually enter an existing training folder path.
    - b) Use the **Existing zip path** field to select the filepath of the `.zip` folder from **Control Room file** or **Desktop file** tab.  
Alternatively, click the **Variable** tab to manually enter the path for the `.zip` folder.
- 

**Note:** When you train documents, a `.zip` folder is created, which contains `.icmf`, `.data` and `.properties` files. Ensure you upload the entire `.zip` folder for retraining an existing model file.

---

4. Select the input folder path from **Desktop folder** or **Variable**.

The input folder path must have subdirectories with the names that correspond to the category of the documents that you want to train the classifier on. For example, if you have sales-related documents, the input folder path must have subfolders such as `Invoice` and `Purchase Order`.

5. Optional: If you select **Desktop file**, click **Browse** to change the default filepath.
6. Enter a name for the model file in the **Model name** field.
7. Use the **Model output path** field to select the directory for the output model file.
8. Optional: Configure the following **ADVANCED SETTINGS**:

- a) **Training Optimization:** Use the drop-down menu to select the type of training optimization.
- **Precision:** select this option when you want your training model to be precise but can miss out on few documents.
  - **Recall:** select this option when you want the training model to find all the relevant cases within a dataset.
  - **F1 score:** is selected by default and the recommended setting as it combines the training optimization of both **Precision** and **Recall**.

**F1 score** is the selected by default. **Precision** and **Recall**.

- b) **Classification Type:** Use the drop-down menu to select the features you want to include such as text, image, or both.

**Text and image** is selected by default. If you select **Text** or **Text and image**, list of supported languages is displayed in the **Recognition Language** drop-down menu.

- c) **OCR Settings:** The **Extract all text blocks** and **Extract text from images** are enabled by default.

With the **OCR Settings** enabled by default, more time is consumed by OCR in extracting the content. This ensures that relatively lower quality documents are also handled based on the inputs from OCR.

9. Click **Save** and **Run**.

When you retrain an existing model, you fetch the already trained data and combine it with new data generated from the text or layout features from input documents. After this, you must train the machine learning model from scratch. This method allows you to save the time needed to re-generate text data or layout data for already trained documents. However, the computationally expensive part is training the machine learning model, hence re-train method is expected to be time-consuming. In case this becomes a constraint, we recommend that you create additional model files and use them for additional training and classification.

The model is created as a `.icmf` file in the directory specified in the **Model output path** field.

After creating the model, build a bot to classify input documents. See [Using Classify action](#) on page 2507

## Document Extraction package

The Document Extraction package enables you to extract data from documents and download that data. This package is for processing documents in Document Automation.

When a new learning instance is created, the Control Room automatically creates a folder with the same name as the learning instance in the **Automation > Document Workspace** folder. Within that folder, the Control Room creates the following two bots:

- Extraction bot: Extracts data from defined fields in uploaded documents.
- Download bot: Downloads the extracted data to a specific folder on the device or shared network.

**Note:** The Process Documents action, that was previously accessible from the now deprecated IQ Bot [Local Device] and IQ Bot Extraction package, provides functionality similar to the Extract Data action in the Document Extraction package.

## Actions in the Document Extraction package

This package includes the following actions:

Action	Description
Download data	See <a href="#">Download data action</a> on page 2516
Extract data	See <a href="#">Extract data action</a> on page 2514
Get document data	See <a href="#">Get document data action</a> on page 2512
Update document data	See <a href="#">Update document data action</a> on page 2513

Related concepts

[Document Automation](#) on page 3625

Document Automation is the new Cloud-native intelligent document processing solution that business users can set up to automatically read and process documents quickly using pretrained models and validation feedback.

Related tasks

[Create a learning instance in Document Automation](#) on page 3642

Begin processing documents by creating a learning instance to extract data from invoices, utility bills, or receipts. A learning instance is a structure that holds information such as document type, language, and the fields to be extracted.

Related information

[IQ Bot \[Local Device\] package \(Archived\)](#)

## Get document data action

Use the **Get document data** action to retrieve document information such as extracted values and coordinates, from the server.

Based on your requirements, use this action to:

- Retrieve data
- Enable applications for custom validation, lookups, normalization, and data manipulation

### Note:

- Bot Runner machine must have Python installed to use the Python package.
- Based on your use case, you can apply custom logic at any stage in a process or workflow.

The following table describes the action fields:



Fields	Description
Document ID	Specify the ID of the document from which you want to get the data. The <b>Document ID</b> is the output of the extraction Task Bot which is available at the process level.
Records	Captures the output of the <b>Get document data</b> action as a record set which contains the following key values: <ul style="list-style-type: none"> <li>• Dictionary object: <b>DocumentDictionary</b></li> <li>• JSON string representing the document: <b>DocumentJson</b></li> <li>• Status: <b>Status</b></li> <li>• Error message: <b>StatusMessage</b></li> </ul>

## Update document data action

Use the **Update document data** action to customize and validate data based on external sources. You can update document data in the downloaded dictionary or JSON file and upload it to the server.

Based on your requirements, use this action to:

- Update the document data using custom logic and upload it to the server
- Enable applications for custom validation, lookups, normalization, and data manipulation

---

**Note:** Based on your use case, you can apply custom logic at any stage in a process or workflow.

---

The following table describes the action fields:

Fields	Description
Document ID	Specify the ID of the document to which you want to upload the updated data to. The <b>Document ID</b> is the output of the extraction Task Bot which is available at the process level.
Document data input	The output of the <b>Get document data</b> action is a JSON or dictionary file which contains updated data or coordinates.

Fields	Description
Records	<p>Captures the output of the <b>Get document data</b> action as a record set which contains the following key values:</p> <ul style="list-style-type: none"> <li>• Dictionary object: <b>DocumentDictionary</b></li> <li>• JSON string representing the document: <b>DocumentJson</b></li> <li>• Status: <b>Status</b></li> <li>• Error message: <b>StatusMessage</b></li> </ul>

Consider the following points when you use the **Update document data** action:

- If an error occurs while parsing the input Dictionary or JSON string, this action does not update the document and returns an error message and the validation status.
- If you parse the input Dictionary JSON string and if there are validation rule errors, this action does not update the document but returns the validation status.
- Does not validate entire document against the defined validation rules.
- Replaces original document with the updated one. Hence, if the user does not provide values for some fields, the values for those fields remain empty.

## Extract data action

Task Bots use the Extract data action to process documents uploaded to Document Automation.

When you create a learning instance in Document Automation, the Control Room automatically creates the **extractionbot**. To edit this bot, navigate to **Automation > Document Workspace**, select the folder with the same name as the learning instance, and open **extractionbot**.

The following table describes the action fields.

**Note:** We do not recommend changing the variables in these fields as that might break the process.

Field	Description
Document to extract	File path to the uploaded document
Learning instance name	Name of the learning instance associated with this bot

Field	Description
Output results	<p>Specify where to store the Document Automation data. Based on your use case, you can either upload the data to the Document Automation server, or save it to your local folder.</p> <ul style="list-style-type: none"> <li>• Upload to the Document Automation server: Data generated during extraction is uploaded to the server for further processing (such as validation) and later downloaded by a bot running the <b>Download data</b> action.</li> <li>• <b>Save to your local folder</b>: Data generated by Document Automation is not sent to the server, but is saved to the specified folder path.</li> </ul> <hr/> <p><b>Note:</b> If you select this option, Document Automation does not send files for validation, since that requires the use of the Document Automation server. In addition, you can remove the bot running the <b>Download data</b> action from the process, as selecting this option makes that step in the process bot redundant.</p> <hr/>
Service account	If the learning instance associated with this bot processes documents in Google Document AI , click <b>Pick</b> to select the credential that contains your Google Document AI security token.
Document AI endpoint URL	If the learning instance associated with this bot processes documents in Google Document AI, provide the URL for your service account.
GroupLabel (optional)	If the learning instance was created in Automation 360 IQ Bot and connected to Document Automation, this field is auto-filled with the applicable document group name.

## Related tasks

[Create a learning instance in Document Automation](#) on page 3642

Begin processing documents by creating a learning instance to extract data from invoices, utility bills, or receipts. A learning instance is a structure that holds information such as document type, language, and the fields to be extracted.

## Configure Extract action to process documents in Google Document AI

Provide the credential that is holding the Google Document AI API key to the **Extraction bot**.

- [Configure key for Google Document AI](#) on page 3640
- [Create a learning instance in Document Automation](#) on page 3642
- Login to your Google Document AI account, navigate to the processor, and set the default version to pretrained-invoice-v1.1-2021-04-09
- Copy the Google Document AI prediction endpoint

**Note:** When creating a learning instance of **Document Type** as Invoices or Receipts with the **Provider** as Google Document AI for a BYOK scenario, you must include the processor URL with Google Document AI v1.3 in the extraction command configuration.

1. Navigate to **Automation > Private tab > Document Workspace** and click the folder with the same name as the learning instance to configure the bot.
2. Open the **Extraction bot** and click the Document Extraction action to edit it.
3. In the **Service account** field, click **Pick** to select the `doc-ai-credential` credential.
4. Provide the Google Document AI prediction endpoint URL.
5. Click **Save**.

## Download data action

Task Bots use the Download data action to download data from successfully processed documents in Document Automation.

When you create a learning instance in Document Automation, the Control Room automatically creates the **downloadbot**. To edit this bot, navigate to **Automation > Document Workspace**, select the folder with the same name as the learning instance, and open the process. By default, the process contains four `downloadbots`. You can edit the output format in the bots: [Change output format from CSV to JSON](#) on page 3651

**Important:** Edit the bots in the process only. We do not recommend editing the **downloadbot** in the folder with the same name as the learning instance.

The following table describes the **Download data** action fields:

Field	Description
Document Id	The Document ID of the document you want to download

Field	Description
Document type	This is the output file type such as: <ul style="list-style-type: none"> <li>• <b>Output file (CSV):</b> Used for downloading successfully processed documents to CSV format.</li> <li>• <b>Output file (JSON):</b> Used for downloading successfully processed documents to JSON format.</li> <li>• <b>Input file:</b> Used for downloading failed documents in the file type that were uploaded.</li> </ul>
Output folder path	Specifies the file path and location to download the document to
Delete files	Removes files from the Document Automation server after they are downloaded

Related reference

[About the Automation Co-Pilot process in Document Automation](#) on page 3646

Document Automation uses Automation Co-Pilot for Business Users technology to manage the end-to-end document extraction process. When you create a learning instance in Document Automation, the system also creates an Automation Co-Pilot process. Review the following guide to understand the logic.

## Email package

The Email package contains actions to automate email-related tasks through Exchange Web Services (EWS), Microsoft Outlook, and other email servers. You can use these actions for sending, receiving, and modifying messages, folders, and the status of messages.

### Note:

- The Email package supports the email automation of a shared mailbox in Outlook for Office 365/Microsoft 365 using IMAP/EWS protocols, and OAuth 2.0 authentication using Client Credentials and Authorization Code with PKCE grant flows. You can automate emails retrieved from a shared mailbox and perform email-related tasks by accessing each folder(s) and its subfolder(s) in the shared mailbox. Ensure that you have set up the shared mailbox in your Outlook application. Note that sending, forwarding, and replying to emails using a shared mailbox is not supported.
- Proxy is supported for EWS OAuth 2.0. When you create a bot that uses EWS OAuth2 for authentication and the Bot Runner machine is configured behind the firewall, then all outbound requests are routed through the proxy server configured on the Bot Runner machine.
- When you read emails in a loop using a Microsoft Outlook Client connection with a subject filter, the bot cannot read undelivered emails, if the subject contains these receipts:
  - Delivery receipt
  - Read receipt

- Undelivered receipt

Outlook client does not support this feature due to the third-party library it uses.

We recommend that you use **Email server > IMAP** to connect, read and filter such emails.

---

The Email package supports EWS, POP3, SMTP, and IMAP protocols and enables you to perform the following tasks:

- Manage and organize email messages and folders.
  - Download attachments from emails to specific folders on devices.
  - Extract data from emails to variables, to use as extracted data in other applications. For example, you can extract data from a sender's email and store it in a Microsoft Excel spreadsheet.
- 

**Note:** If you want to automate an email-related task on a device using Microsoft Outlook, ensure that the Outlook application is open.

---

**Note:**

- If your current office installation is any of the following:
  - Microsoft 365 Apps for Enterprise
  - Office 2016, 2019, or 2021 (Consumer Version 2009 or later)

Then you do not need to install the Microsoft Access Database Engine as an additional component in your system.

However, if you have both Microsoft 365 Apps and the Microsoft Access Database Engine are installed on your system, then you can uninstall the Microsoft Access Database Engine and repair Microsoft 365 Apps.

Microsoft recommends that you do not install the Microsoft Access Database Engine driver separately because both the Microsoft Access Database Engine 2016 and Microsoft 365 Apps use the same major version identifier (16.0). To learn more about the Microsoft Access Database Engine driver installation requirement, see [Unable to use the Access ODBC or OLEDB provider](#)

- When you send an email, reply, or forward, the attachment size allowed in the email depends on your internet speed (timeout of 120 seconds) and the email server restrictions. If sending an attachment takes more than 120 seconds, the system displays an error due to timeout.
- 

## Considerations

---

**Note:** Some of the actions must be used within a **Loop** action. See [Using the For each mail in mail box iterator](#) on page 2545.

---

Emails are retrieved based on the sequence of the folders listed in the inbox field. Within each folder, emails are retrieved based on received date and time in the last in, first out (LIFO) order. Additionally, you can apply filters on the following fields:

- Types of emails: **All**, **Read**, and **Unread**
-

- Subject
- From a specific folder
- From specific sender
- Before, on, or after received date

Adhere to the following best practices when you filter and loop through folders that contain a large number of email messages:

- After you have processed email messages, move them to another folder so that their duplicate email messages are not processed again during a subsequent run.
- Try to reduce the number of messages in the mailbox.
- The filtration works on the filter parameters provided by the user, such as type of email: All, Read, and Unread; Subject; from a specific folder; from a specific sender; or before, on, or after received date). Following are the types of filter mechanisms:
  - Email server-side: The filtration that takes place on the server-side is much faster.
  - Client-side: Filtration is performed on the local machine and is comparatively slow because the mail messages are first retrieved from the remote server and then filtered in the local machine.
  - Hybrid: Some parameters are filtered on the server side and some on the client side.
- Here is an explanation of how the filtration process works for various server types:
  - **EWS**: All filtration is done on the server side and is hence much faster.
  - **Outlook client**: Nothing is filtered on the server side, but the filtration process is faster because email messages are already present on the local machine.
  - **IMAP**: Filtration for the **Subject** field is performed on the local machine and is slower. For the **Before, on, or after received date** parameter, the filtration for `date` is performed on the remote server, and for `hour/min/second`, it is performed on the local machine. For example, for the date 01/12/2022, filtration is performed on the remote server whereas for the time (hour/min/sec) 21:10:56, filtration is performed on the local machine.
  - **POP3**: This server is the slowest of all because mails are retrieved from the remote server, and filtration is done in the local machine.

We recommend connecting using the EWS server and Outlook client as the filtration process is much faster when compared to IMAP and POP3 protocols.

- Always use the **Disconnect** action if the **Connect** action is used to release a resource.

## Before you start

Perform the following actions within the `Email` package as part of using the set of available actions:

1. Establish a connection with an email server using the **Connect** action.

While establishing the connection, specify the details and session name of the email server. Use this same session name for the other actions.

You do not have to establish a connection for the **Forward**, **Reply**, and **Send** actions because you will add the sender and email server details when you use these actions.

2. Use the actions to automate a task.

3. After you have automated all the email-related tasks, terminate the connection to the mail server using the **Disconnect** action.

---

**Important:** You must enable POP settings to automate an email-related task on the Gmail server using the POP3 protocol. See [Read Gmail messages using POP](#).

---

## Actions in the Email package

The Email package includes the following actions:

Action	Description
Change status	See <a href="#">Change status action</a> on page 2521.
Check if folder exists	See <a href="#">Check if folder exists action</a> on page 2521.
Delete all	See <a href="#">Delete all action</a> on page 2522.
Delete	See <a href="#">Delete action</a> on page 2523.
Disconnect	See <a href="#">Disconnect action</a> on page 2523.
Connect	See <a href="#">Using Connect action in Email package</a> on page 2523.
Forward	See <a href="#">Using Forward action</a> on page 2529.
Move all	See <a href="#">Move all action</a> on page 2532.
Move	See <a href="#">Move action</a> on page 2533.
Reply All	See <a href="#">Reply All action</a> on page 2533.
Reply	See <a href="#">Using Reply action</a> on page 2536.
Save all attachments	See <a href="#">Save all attachments action</a> on page 2539.
Save attachments	See <a href="#">Save attachment action</a> on page 2540.
Save email	See <a href="#">Save email action</a> on page 2540.
Send	See <a href="#">Using Send action</a> on page 2540.

Related reference

[Loop package](#) on page 2784

Use the Loop package to run a sequence of actions repeatedly for a specific number of times or until a specific condition is met.

[Email server settings](#) on page 2528

The details about the mail server you provide when establishing a connection varies based on the email server to which you are connecting.

[Using dictionary variable for email properties](#) on page 2547

When you automate an email-related task, Automation Workspace retrieves various properties of an email and stores the values of these properties in a dictionary variable. These properties are stored in a dictionary variable when you use an email action within a loop action.

[Email package updates](#) on page 873



Review the updates in released versions of the Email package such as new and enhanced features as well as fixes and limitations. The page also lists the release dates of each version, and the compatible Control Room and Bot Agent versions.

## Change status action

The Change status action in the Email package enables you to change the statuses of emails to read or unread. Use this action within a **Loop** action.

### Settings

- In the **Session name** field, enter the name of the session that you used to connect to the email server in the **Connect** .
- **Change status to:** Select the **Read** or **Unread** option to change the status of the email.

---

#### Note:

- Microsoft Outlook supports this action.
- POP3 servers do not support and maintain the read or unread status of emails.

---

## Check if folder exists action

Use the Check if folder exists action in the Email package to verify whether a folder with the name you specified exists in the email server.

### Settings

- In the **Session name** field, enter the name of the session that you used to connect to the email server in the **Connect** .
- In the **Folder name** field, enter the name of the folder you want to check.

---

**Note:** This field is not case-sensitive.

- In the **Select the destination boolean variable** list, select a Boolean variable to store the output of the result. The output is either True (folder exists) or False (does not exist). The shows a descriptive default variable name. If you create several output variables, subsequent variable names are appended with a -1, -2, -3, and so on to avoid duplication.

## Delete all action

Use the Delete all action in Email package to delete read, unread or all emails from the specified folder.

### Settings

- In the **Session name** field, enter the name of the session that you used to connect to the email server in the **Connect** .
- In the **From specific folders (optional)** field, specify the folder from which to delete the emails. For example, `Inbox/folder1; Inbox/folder2` or `Inbox/test*`.

---

**Note:**

- Microsoft Outlook does not allow the use of wildcards (\*) to run a search on folder filters. You must specify all the folders individually in the **From specific folders** field.
- Both EWS and email server allow the use of wildcards and supports partial matching. For example, you can specify `Inbox/test*` to match `Inbox/test1`, `Inbox/test2`.
- If you are using the POP3 protocol, you can delete emails from Inbox only.

- 
- Select the **All**, **Read**, or **Unread** option to specify the type of email you want to delete.

---

**Note:**

- For an email server using the POP3 protocol, this action deletes all the email messages.
- Microsoft Outlook does not currently support this action.

- 
- Optional: Specify any of the following conditions:

- **When subject contains:** Enter keywords separated by semicolons.

---

**Note:** This field is not case sensitive. You can enter keywords in the **When subject contains** field. If you add keywords inside a pair of double quotation marks, the bot will search for an exact match of keywords and the case you used to filter and retrieve emails.

- 
- **From specific senders:** Enter senders' email addresses separated by semicolons.
  - **When received date is on or after** or **When received date is before:** Select a datetime variable from the list.

---

**Note:** This action is not supported for Gmail because Gmail does not support folders.

---

## Delete action

Use the Delete action in Email package to delete the specified email from the inbox. Use this action within a Loop action.

### Settings

In the **Session name** field, enter the name of the session that you used to connect to the email server in the **Connect** .

---

**Note:** Microsoft Outlook supports this action.

---

## Disconnect action

Use the Disconnect action in Email package to terminate the connection established with the email server.

### Settings

In the **Session name** field, enter the name of the session that you used to connect to the email server in the **Connect** .

## Using Connect action in Email package

Use the **Connect** action in the Email package to establish a connection with an email server. This is the first action you must use to automate an email-related task.

You can use OAuth 2.0 to authenticate with the email server for email automation. Based on your email service provider, perform the relevant steps:

- **Outlook/Office 365**
  - If you use **Client credentials flow** authentication mode, then perform the following steps:
    1. Log in to the Microsoft [Azure portal](#).
    2. Register an application with the Microsoft identity platform to obtain the client ID and tenant ID. See [Register an application](#).
    3. Add a Client secret.  
See [Add a client secret](#)
    4. Based on the mail server you connect to, perform the relevant steps:
      - **IMAP/POP3**  
Add the POP and IMAP permissions to your AAD application . See [Authenticate an IMAP, POP or SMTP connection using OAuth](#).
      - **EWS**
        - Configure for app-only authentication. See [Configure for app-only authentication](#).

- Configure an application access policy and limit the scope of application permissions. See [Configure application access policy](#).
- If you use the **Authorization code with PKCE** authentication mode, then perform the following steps:
  1. Log in to the Microsoft [Azure portal](#).
  2. Register an application with the Microsoft identity platform to obtain the client ID and tenant ID. See [Register an application](#).
  3. When registering the application, set the redirect URI to `http://localhost:9999/callback`.
  4. Add permissions with type delegated for IMAP, POP3, and SMTP and grant the application the required permission for Microsoft Graph to the application.

The videos in the following playlist provides information about configuring and using OAuth 2.0 authentication in the Email **Connect** action:

---

**Note:** If the mailbox is used inside a **Loop** , ensure that you register the user who is assigned to perform the automation. For more information , see .

---

- **Gmail**

To authorize your application with Gmail using the **Authorization code with PKCE** authentication method, perform the following steps:

1. Configure the OAuth 2.0 settings in the Google Cloud Platform (GCP) and retrieve the necessary credentials to connect Automation 360 with your G Suite applications.
2. Ensure you create a project.  
See [create a project](#).
3. Generate the Client ID and Client secret.  
See [Setting up OAuth 2.0](#).

---

**Note:**

- Select the **Web application** option.
- Add this authorized redirect URI: `http://localhost:8888/Callback`.

4. Complete the steps to set up [user consent](#) for the username that you will use to connect to the Automation 360.

---

**Note:**

- Client Credentials flow does not support Gmail.
  - The Client Credentials and Authorization code with PKCE authentication modes do not support Yahoo and MSN mail servers.
-

**Important:** If you want to use both the authentication modes (Client credentials and Authorization code with PKCE), you must register on two separate applications.

---

**Note:** When you connect to an Exchange Web Services server, multi-factor authentication (MFA) must be disabled, including in all organizational level security policies where MFA might be enabled. If MFA is not disabled completely, users can encounter connection or authorization errors. However, if you still want to use MFA, review the information in this article (be aware that a successful connection is not guaranteed):

[Multi-factor authentication for Azure EWS \(A-people login required\)](#)

---

This action enables you to provide the email server credentials and details, and associate this information with a session name. Use this same session name for the other Email actions, so you only have to provide the server information once.

To establish a connection with an email server, follow these steps:

1. In the **Actions** palette, double-click or drag the **Connect** action from the **Email** package.
2. Enter a session name.
3. In the **Outlook, Email server**, or **EWS** option, specify whether you want to establish a connection with Microsoft Outlook or a mail server.

When you establish a connection with Microsoft Outlook, email messages are processed from the shared mailbox. Ensure that you have set up the shared mailbox in your Outlook application.

---

**Note:**

- This feature is supported only for Outlook.
  - You can select only one mailbox from the list of mailboxes in the shared mailbox.
  - The meeting invitation is not read in Outlook because the bot does not select calendar invites as email objects. This feature is not currently supported.
- 

- If you have selected the **Outlook** option, you do not need to provide any additional details.
  - If you have selected the **Email server** option, complete the following fields:
- 

**Note:** For information about the host and port to be used for the various mail servers, see [Email server settings](#) on page 2528.

---

- **Use secure connection (SSL/TLS):** Select this option if you want to use a secure connection with the mail server.
  - **Host:** Enter the name of the mail server.
- 

**Note:** This field is not case-sensitive.

---

- **Port:** Enter the port number of the server.
  - **Protocol:** Select either **IMAP** or **POP3** protocol.
  - **Authentication mode:** Choose from the following authentication modes:
    - **Basic:** Uses the username and password.
    - **OAuth2 – Authorization code with PKCE:** See [Microsoft identity platform and OAuth 2.0 authorization code flow](#)
-

For more information on how to set up application in Azure to use OAuth Authorization Code with PKCE Flow for Mail Server, see [How to setup App in Azure and Exchange Online to use OAuth 2.0 Client Credentials Flow for IMAP/POP3 Mail Server \(A-People login required\)](#).

- **OAuth2 – Client credentials:** See [Microsoft identity platform and the OAuth 2.0 client credentials flow](#)

For more information on how to set up an application in Azure to use OAuth 2.0 Client Credentials Flow for IMAP/POP3 Mail Server, see [How to setup App in Azure and Exchange Online to use OAuth 2.0 Client Credentials Flow for IMAP/POP3 Mail Server \(A-People login required\)](#).

Depending on the authentication mode that you selected, you must specify the details in the following fields as applicable.

- **Username:** Enter the username that you want to use to access the mail server.  
For example, `john.smith@myCompanyName.com`
- **Password:** Enter the password for the username you provided.
- For **Client ID**, **Tenant ID**, **Redirect URI**, and **Client secret** fields, enter the information that is provided for your account on your [Azure portal](#).
- **Email provider:** Select your email service provider from the drop-down list.
  - **Outlook/Office365**  
If you select this option, then provide the **Tenant ID**.
  - **Gmail**

For **Username**, **Password**, **Tenant ID**, **Client ID**, and **Client secret** fields, choose from **Credential**, **Variable**, or **Insecure string** tab:

- **Credential:** Use a value available in the credential vault.
  - **Variable:** Use a user-defined variable that stores the values.
  - **Insecure string:** Manually enter a value.
- If you have selected the **EWS** option, complete the following fields:
    - **Exchange Version:** Select the version that your organization is using:
      - Exchange Server 2013
      - Exchange2010\_SP2
      - Exchange2010\_SP1
      - Exchange2010
      - Exchange2007\_SP1
    - **Azure cloud:** Select the product that your organization is using:
      - **Azure Global:** For customers of Microsoft 365 Commercial version (`login.microsoftonline.com`)
      - **Azure US GCC High:** For customers of Microsoft 365 Government version (`login.microsoftonline.us`)
    - Optional: **Domain name:**
      - If you are a Microsoft 365 customer and you leave this field blank, Automation Workspace uses `smtp.office365.com` to connect to the server.

- If you are an Microsoft 365 customer and you have entered a domain name in the **username** field, you must enter `smt.p.office365.com` in this field.
- If you are not an Microsoft 365 customer, enter the domain name of your organization. Otherwise, Automation Workspace uses the domain name you provided in the **Username** field.
- **Authentication mode:** Choose from the following authentication modes:

---

**Note:** From Automation 360v.27 or later, the authorization type **OAuth2-Silent authentication mode** is renamed to **OAuth2-ROPC**, and the **OAuth2-Interactive authentication mode** is renamed to **OAuth2-Implicit**.

---

- **Basic:** Uses the username and password.
- **OAuth2-ROPC:** See [Microsoft identity platform and OAuth 2.0 Resource Owner Password Credentials](#)
- **OAuth2-Implicit:** See [Microsoft identity platform and implicit grant flow](#)
- **OAuth2 – Authorization code with PKCE:** See [Microsoft identity platform and OAuth 2.0 authorization code flow](#)

For more information on how to set up an application in Azure to use OAuth Authorization Code with PKCE flow for EWS, see [How to setup App in Azure to use OAuth Authorization Code with PKCE Flow for EWS \(A-People login required\)](#).

- **OAuth2 – Client credentials:** See [Microsoft identity platform and the OAuth 2.0 client credentials flow](#)

For more information on how to set up an application in Azure and Exchange Online to use OAuth 2.0 - Client Credentials flow for EWS Server, see [How to setup App in Azure and Exchange Online to use OAuth 2.0 - Client Credentials Flow for EWS Server \(A-People login required\)](#).

If you have trouble connecting to shared mailbox using EWS, see [Unable to connect to shared mailbox using EWS error \(A-People login required\)](#).

Depending on the authentication mode that you selected, you must specify the details in the following fields as applicable.

- **Username:** Enter the username that you want to use to access the mail server.  
For example, `john.smith@myCompanyName.com`
- **Password:** Enter the password for the username you provided.
- For **Client ID**, **Tenant ID**, **Redirect URI**, and **Client secret** fields, enter the information that is provided for your account on your [Azure portal](#).
- **Test connection:** Click **Test connection** to sign in to your account, accept the permissions requested to authenticate, and establish a connection with the server.

---

**Note:**

- When you perform a desktop operation and click **Test connection**, variables such as (Credential, Credential variable, or Sting variables) are currently not supported.
  - When you perform desktop operation and click **Test connection** to sign in to your account, then add this redirect URI: `https://outlook.office365.com`
-

For **Username**, **Password**, **Tenant ID**, **Client ID**, and **Client secret** fields, choose from **Credential**, **Variable**, or **Insecure string** tab:

- **Credential**: Use a value available in the credential vault.
- **Variable**: Use a user-defined variable that stores the values.
- **Insecure string**: Manually enter a value.

4. Click **Save**.

## Email server settings

The details about the mail server you provide when establishing a connection varies based on the email server to which you are connecting.

The following table provides information about the host name and the port you must use when establishing a connection to the specified mail server:

Server	For reading or retrieving emails	For sending emails
Microsoft Outlook/Microsoft Office 365	Host: outlook.office365.com Port: 993	Host: outlook.office365.com, Port: 993 Host: smtp.office365.com Port: 587
Gmail	Host: imap.gmail.com Port: 993	Host: smtp.gmail.com Port: 587
Yahoo	Host: imap.mail.yahoo.com Port: 993	Host: smtp.mail.yahoo.com Port: 465 or 587
MSN	Host: imap-mail.outlook.com Port: 993 For POP3: Host: pop-mail.outlook.com Port: 993	Host: smtp-mail.outlook.com Port: 465 or 587

The Email package supports nonstandard ports in the range of 1 through 65535 for the SMTP server.

## Additional configuration for Gmail and Yahoo

Google no longer supports using less secured apps which only require you to enter your username and password to log in to your Google Account. If you are using a Gmail account to automate an email-related task, you can grant access to third-party applications by using the App password.



You can use the App password if the application does not support Sign in with Google to connect apps to your Google Account. You can only use App passwords with accounts that have 2-Step Verification turned on. As a best practice, use OAuth 2.0 authentication to access G Suite account data.

For more information on how to generate an app password for Gmail, see [Generate and use app passwords for Gmail](#).

If you are using a Yahoo account to automate an email-related task, you must generate the app password from the Yahoo account security page. You can then use the app password and email address to log in to your email account.

For more information on how to generate an app password for Yahoo, see [Generate and use app passwords for yahoo](#).

## Using Forward action

Use the **Forward** action to forward emails and attachments to one or more recipients. To forward emails as plain text or HTML through Exchange Web Services (EWS), Microsoft Outlook, or other email servers, use this action within a **Loop** action.

To forward emails, follow these steps:

1. In the Actions palette, double-click or drag the **Forward** action from the Email package.
2. In the **To address** field and the optional **Cc** and **Bcc** fields, enter the email addresses of the recipients.

---

**Note:** The **To address**, **Cc**, and **Bcc** fields are not case-sensitive.

---

3. Optional: To specify whether to attach multiple files as a list or create a variable to hold the list values of the file object, select the **List** or **Variable** tab from **Attachment**.

Option	Description
List	<ul style="list-style-type: none"> <li>Select the attachment from a location:                             <ul style="list-style-type: none"> <li><b>Control Room file:</b> Enables you to select an attachment that is available in a folder.</li> <li><b>Desktop profile:</b> Enables you to select an attachment that is available on your device.</li> </ul> <p>You can provide a combination of static path or string variable. To use it as a string variable, copy the static path from your desktop and create a variable of type string. Enter the <b>Variable</b> name and paste the file path in the <b>Default value</b> field. Press F2 to insert the value of the filepath.</p> <li><b>Variable:</b> Enables you to specify the file variable that contains the location of the attachment.</li> </li></ul> <ul style="list-style-type: none"> <li>Specify the path that you want to attach in the <b>Value</b> field. Click <b>Add</b> to attach multiple files.</li> </ul>
Variable	<p>Enables you to specify the list of file objects that contain the location of the attachments.</p> <p>Create a new variable of type <b>List</b> with subtype <b>File</b>, and add the filepath in the <b>Default value</b> field (optional). You can choose the file from the <b>Desktop</b> or <b>Control room</b>.</p>

When you are attaching multiple files to an email, to separate the file paths, if you are connected with EWS, use a comma (,), and if you are connected to an email server or Microsoft 365 Outlook, use a semicolon (;).

- Optional: Select the **Raise error if attachments are missing (desktop only)** check box to verify that you have attached a file and the attached file exists.

Option	Result
The <b>Raise error if attachments are missing (desktop only)</b> check box is selected	If a file is not attached, the email is not sent and the bot encounters an error.
The <b>Raise error if attachments are missing (desktop only)</b> check box is not selected	The email is sent even if a file is not attached.

- For **Email body**, select one of the following options for the format that you want to use:

Option	Description
Plain text	Use regular text in your email body, with no formatting effects, such as bold, italic, or underline, or special layout options.
HTML design	Use this option to create and customize your email layout and body. Use the editor toolbar to make various changes to your text, such as applying bold, italic, and other formatting effects, inserting links, and changing the font and size of the text. You can copy the content from the design editor and paste it to other windows.
HTML code	Use HTML script in your mail body when you want your content to be displayed in a certain layout every time. You can also include interactive elements, such as links.

6. Optional: In the **Message** field, enter the content you want to send along with the email. The email will be appended to the message you have specified.
7. Optional: Select the **Include Go Green message at the end of the email** check box. The Go Green message appends the following text to the email body: `Please consider the environment before printing. Let's Go Green!`
8. Use the **Send email via** field to select one of the following options to send the emails using Microsoft 365 Outlook or a mail server.

- **Email server:** Update the following fields:

---

**Note:** For information about the host and port to be used for the various mail servers, see [Email server settings](#) on page 2528.

---

- **Email server host:** Enter the host you want to connect.

---

**Note:** If you use the host Outlook.office365.com, there is a limit of 30 messages sent per minute and 10,000 recipients per day.

---

- **Email server port:** Enter the port you want to use to establish the connection.
- **Use secure connection (SSL/TLS):** Select this option if you want to use a secure connection with the mail server.
- **My server requires authentication:** Select this option if the server requires credentials for access.
- **Authentication mode:** Select the authentication modes:
  - **Basic**
  - **OAuth2 – Authorization code with PKCE**

Depending on the authentication mode that you selected, you must specify the details in the following fields as applicable.

- **Username:** Enter the username that you want to use to access the mail server.  
For example, `john.smith@myCompanyName.com`
- **Password:** Enter the password for the username you provided.

- For **Client ID**, **Tenant ID**, **Redirect URI**, and **Client secret** fields, enter the information that is provided for your account on your [Azure portal](#).
- **Email provider**: Select your email service provider from the drop-down list.
  - **Outlook/Office365**  
If you select this option, then provide the **Tenant ID**.
  - **Gmail**

For **Username**, **Password**, **Tenant ID**, **Client ID**, and **Client secret** fields, choose from **Credential**, **Variable**, or **Insecure string** tab:

- **Credential**: Use a value available in the credential vault.
  - **Variable**: Use a user-defined variable that stores the values.
  - **Insecure string**: Manually enter a value.
- 
- **Outlook**: No additional details are required.
  - **EWS Server**: No additional details are required.

9. Click **Save**.

## Move all action

The Move all action in the Email package enables you to move all emails from one folder to another in the email server.

### Settings

- In the **Session name** field, enter the name of the session that you used to connect to the email server in the **Connect** .
- In the **Destination folder path in mailbox** field, provide the path to the location where you want to move the email.
- Select which emails to move: **All**, **Read**, or **Unread**
- In the **From a specific folder** field, specify the folder from which to move the emails. For example, `Inbox/project1`.

---

**Note:** For an email server using the POP3 protocol, you can retrieve emails only from the inbox.

---

- Optional: Specify any of the following conditions:
  - **When subject contains**: Enter keywords separated by semicolons.  
[How subject filter works when moving emails](#) on page 2549

---

**Note:** The **When subject contains** field is case sensitive. If you have established a connection with the EWS server and when you enter text inside a pair of double quotation marks (") in the **When subject contains** field, the bot retrieves all the email messages whose subject exactly matches the text and the case that you entered inside a pair of double quotation marks.

---

- **From specific senders**: Enter senders' email addresses separated by semicolons.

- **When received date is on or after** or **When received date is before**: Select a datetime variable from the list.

---

**Note:** Because folders are not supported in Gmail, this action is not supported for Gmail.

---

**Note:** You cannot use the **Move all** action within a loop. The **Move all** action is designed to be used with conditions outside a loop.

---

For more information, see [Can Move all action be used within a loop? \(A-People login required\)](#)

## Move action

The Move action in the Email package enables you to move an email from one folder to another in the mailbox. Use this action within a **Loop** action.

### Settings

- In the **Session name** field, enter the name of the session that you used to connect to the email server in the **Connect** .
- In the **Destination folder path in the mailbox** field, provide the path to the destination folder where you want to move the email. For example, `Inbox/finance/1`
- Keep the following considerations in mind when you use the **Move** action:
  - You must use this action inside a loop.
  - When you connect with an **Email server** and use the **IMAP** protocol, ensure that you use the **Move** action as the last action in the email loop.
  - This action is not supported for **POP3** connections.
  - The bot encounters an error if the **Delete** action is used before the **Move** action.
  - If you are connecting to Outlook, we recommend that you to use a **Delay** action after the **Move** action. (Specify a maximum delay of more than 2 seconds). Delay is based on Outlook client performance.
  - For improved performance when moving a large number of emails, considering latency issues with the Outlook client, we recommend using the **Move all** action instead of **Move** action when you want to move more than 500 emails.

## Reply All action

You can use the **Reply all** action in the Email package to send a response to the sender and include all the recipients of an email with the same or modified subject.

### Settings

You use this action in a **Loop** action. This action does not include any files attached to the original email.

1. Optional: In the **Additional Cc** and **Bcc** fields, enter the email address of any additional recipients. Use a comma to separate the multiple email IDs.

2. Optional: Select the **Exclude sender of the email** check box to exclude the email sender from the email recipients while replying to it.
3. Optional: In the **Subject** field, you can enter a new subject line or modify the existing subject while replying to the email.
4. Optional: You can specify whether to attach multiple files as a list, or create a variable to contain the location of any attachments. Select the **List** or **Variable** tab from **Attachment**.

Option	Description
List	<ul style="list-style-type: none"> <li>• Select the attachment from a location:                             <ul style="list-style-type: none"> <li>• <b>Control Room file</b>: Select an attachment from a folder.</li> <li>• <b>Desktop profile</b>: Select an attachment from your device.</li> </ul> </li> </ul> <p>You can provide a combination of a static path or string variable. To use it as a string variable, copy the static path from your desktop and create a variable of type String. Enter the <b>Variable</b> name and paste the file path in the <b>Default value</b> field. Press F2 to insert the value of the filepath.</p> <ul style="list-style-type: none"> <li>• <b>Variable</b>: Specify the file variable that contains the location of the attachment.</li> </ul> <ul style="list-style-type: none"> <li>• Specify the path that you want to attach in the <b>Value</b> field. Click <b>Add</b> to attach multiple files.</li> </ul>
Variable	<p>Specify file variable that contains the location of the attachments.</p> <p>Create a new variable of type <b>List</b> with subtype <b>File</b>, and add the filepath in the <b>Default value</b> field (optional). You can choose the file from the <b>Desktop</b> or <b>Control Room</b>.</p>

5. Optional: Select the **Raise error if attachments are missing (desktop only)** check box to verify that you have attached a file and the attached file exists.

Option	Result
The <b>Raise error if attachments are missing (desktop only)</b> check box is selected	If a file is not attached, the email is not sent and the bot encounters an error.

Option	Result
The <b>Raise error if attachments are missing (desktop only)</b> check box is not selected	The email is sent even if a file is not attached.

6. Select the format that you want to use from the following options:

Option	Description
Plain text	Use regular text in your email body, without any formatting effects, such as: bold, italic, underline, or special layout options.
HTML code	Use HTML script in your email body to display your content using a consistent layout every time. You can also include interactive elements, such as links.
HTML design editor	Use to create and customize your email layout and body. You can use the editor toolbar to change your text, such as applying bold, italic, and other formatting effects, inserting links, and changing the text font and size of the text. You can copy the content from the design editor and paste it to other browser locations.

7. Enter the content you want to send with the email in the **Message** field.  
The email will be appended to the message you specified.
8. Optional: Select the **Include Go Green message** at the end of the email check box.  
The Go Green message appends the following text to the bottom of the email body: `Please consider the environment before printing. Let's Go Green!`
9. Select the **Email server**, **EWS**, or **Outlook** option from the **Send email via** list to specify whether to send the emails using Microsoft Outlook or a mail server.
- If you selected the **Outlook** option, you do not need to provide any additional details.
  - If you selected the **Email server** option, enter information for the following fields:

---

**Note:** For information about which host and port to use for the various mail servers, see [Email server settings](#) on page 2528.

---

- Email server host:** Enter the host you want to connect.

---

**Note:** If you use the host Outlook.office365.com, there is a limit of 30 messages sent per minute, and 10,000 recipients per day.

---

- Email server port:** Enter the port you want to use to establish the connection.
- Use secure connection (SSL/TLS):** Select this option to use a secure connection with the mail server.
- Authentication mode:** Select the authentication modes:

- **Basic**
- **OAuth2 – Authorization code with PKCE**

Depending on the authentication mode that you select, you must specify the any applicable details in the following fields:

- **Username:** Enter the username used to access the mail server.  
For example, `john.smith@myCompanyName.com`
- **Password:** Enter the password for the username you provided.
- For **Client ID**, **Tenant ID**, **Redirect URI**, and **Client secret** fields, enter the information that is provided for your account on your [Azure portal](#).
- **Email provider:** Select your email service provider from the drop-down list.
  - Outlook/Office365  
If you select this option, then enter the **Tenant ID**.
  - Gmail

For **Username**, **Password**, **Tenant ID**, **Client ID**, and **Client secret** fields, choose from the **Credential**, **Variable**, or **Insecure string** tab:

- **Credential:** Use a value available in the credential Vault.
  - **Variable:** Use a user-defined variable that stores the values.
  - **Insecure string:** Manually enter a value.
- If you have selected the **EWS** option, you do not need to provide any additional details.

## Using Reply action

Use the **Reply** action to send a response to an email with the same subject.

To send a reply to emails as plain text or HTML through Exchange Web Services (EWS), Microsoft Outlook, or other email servers, use this action within a **Loop** action. This action does not include any files attached to the original email.

Follow these to reply to an email:

1. In the **Actions** palette, double-click or drag the **Reply** action from the **Email** package.
2. In the **Cc** and **Bcc** fields, enter the email address of additional recipients.

---

**Note:** The **Cc** and **Bcc** fields are not case sensitive.

---

3. Optional: To specify whether to attach multiple files as a list or create a variable to hold the list values of the file object, select the **List** or **Variable** tab from **Attachment**.



Option	Description
List	<ul style="list-style-type: none"> <li>Select the attachment from a location:                             <ul style="list-style-type: none"> <li><b>Control Room file:</b> Enables you to select an attachment that is available in a folder.</li> <li><b>Desktop profile:</b> Enables you to select an attachment that is available on your device.</li> </ul> <p>You can provide a combination of static path or string variable. To use it as a string variable, copy the static path from your desktop and create a variable of type string. Enter the <b>Variable</b> name and paste the file path in the <b>Default value</b> field. Press F2 to insert the value of the filepath.</p> </li> <li><b>Variable:</b> Enables you to specify the file variable that contains the location of the attachment.</li> <li>Specify the path that you want to attach in the <b>Value</b> field. Click <b>Add</b> to attach multiple files.</li> </ul>
Variable	<p>Enables you to specify the list of file objects that contain the location of the attachments.</p> <p>Create a new variable of type <b>List</b> with subtype <b>File</b>, and add the filepath in the <b>Default value</b> field (optional). You can choose the file from the <b>Desktop</b> or <b>Control room</b>.</p>

When you are attaching multiple files to an email, to separate the file paths, if you are connected with EWS, use a comma (,), and if you are connected to an email server or Microsoft 365 Outlook, use a semicolon (;).

- Optional: Select the **Raise error if attachments are missing (desktop only)** check box to verify that you have attached a file and the attached file exists.

Option	Result
The <b>Raise error if attachments are missing (desktop only)</b> check box is selected	If a file is not attached, the email is not sent and the bot encounters an error.
The <b>Raise error if attachments are missing (desktop only)</b> check box is not selected	The email is sent even if a file is not attached.

- Select the format that you want to use from the following options:

Option	Description
Plain text	Use regular text in your email body, with no formatting effects, such as bold, italic, or underline, or special layout options.
HTML code	Use HTML script in your mail body when you want your content to be displayed in a certain layout every time. You can also include interactive elements, such as links.
HTML design editor	Use this option to create and customize your email layout and body. Use the editor toolbar to make various changes to your text, such as applying bold, italic, and other formatting effects, inserting links, and changing the font and size of the text. You can copy the content from the design editor and paste it to other windows.

6. Enter the content you want to send along with the email in the **Message** field.  
The email will be appended to the message you have specified.
7. Optional: Select the **Include Go Green message at the end of the email** check box.  
The Go Green message appends the following text to the email body: `Please consider the environment before printing. Let's Go Green!`
8. Use the **Send email via** field to select one of the following options to send the emails using Microsoft 365 Outlook or a mail server.

- **Email server:** Update the following fields:

---

**Note:** For information about the host and port to be used for the various mail servers, see [Email server settings](#) on page 2528.

---

- **Email server host:** Enter the host you want to connect.

---

**Note:** If you use the host Outlook.office365.com, there is a limit of 30 messages sent per minute and 10,000 recipients per day.

---

- **Email server port:** Enter the port you want to use to establish the connection.
- **Use secure connection (SSL/TLS):** Select this option if you want to use a secure connection with the mail server.
- **My server requires authentication:** Select this option if the server requires credentials for access.
- **Authentication mode:** Select the authentication modes:
  - **Basic**
  - **OAuth2 – Authorization code with PKCE**

Depending on the authentication mode that you selected, you must specify the details in the following fields as applicable.

- **Username:** Enter the username that you want to use to access the mail server.  
For example, `john.smith@myCompanyName.com`
- **Password:** Enter the password for the username you provided.

- For **Client ID**, **Tenant ID**, **Redirect URI**, and **Client secret** fields, enter the information that is provided for your account on your [Azure portal](#).
- **Email provider**: Select your email service provider from the drop-down list.
  - **Outlook/Office365**  
If you select this option, then provide the **Tenant ID**.
  - **Gmail**

For **Username**, **Password**, **Tenant ID**, **Client ID**, and **Client secret** fields, choose from **Credential**, **Variable**, or **Insecure string** tab:

- **Credential**: Use a value available in the credential vault.
  - **Variable**: Use a user-defined variable that stores the values.
  - **Insecure string**: Manually enter a value.
- 
- **Outlook**: No additional details are required.
  - **EWS Server**: No additional details are required.

9. Click **Save**.

## Save all attachments action

Use the **Save all attachments** action to save attachments from all emails on the email server to a specified folder.

### Settings

- In the **Session name** field, enter the name of the session that you used to connect to the email server in the **Connect** .
- Select which emails to save: **All**, **Read**, or **Unread**.
- In the **Save attachments to folder** field, specify the location to save the attachments.

---

**Note:** This field is not case-sensitive.

- **Overwrite file(s)**: Select this option to overwrite an existing file with the same name. If this option is not selected, the downloaded attachment is saved with the same filename suffixed with a numeric value; it does not overwrite the existing file.

---

**Note:**

- You can save attachments with a filename that contains a TAB character.
  - If connected to an Outlook server, images embedded in the emails are downloaded along with attachments.
-

## Save attachment action

Use the **Save attachment** action to save attachments from one email to a specified folder. Use this action within a **Loop** action.

### Settings

- In the **Save attachments to folder** field, specify the location to save the attachments.

---

**Note:** This field is not case-sensitive.

- **Overwrite file(s):** Select this option to overwrite an existing file with the same name. If this option is not selected, the downloaded attachment is saved with the same filename suffixed with a numeric value; it does not overwrite the existing file.

---

**Note:** The **Save attachment** action does not support downloading or saving the embedded attachments.

---

## Save email action

Use the Save email action in the Email package to save an email message as an EML file to a folder. Use this action within a **Loop** action.

### Settings

- In the **Session name** field, enter the name of the session that you used to connect to the email server in the **Connect** .
- In the **Save emails to folder** field, specify the location to save the email.

---

**Note:** This field is not case-sensitive.

- **Overwrite file(s):** select this option to overwrite the existing file with the same name. If this option is not selected, the email message is saved with the same filename suffixed with a numeric value; it does not overwrite the existing file.

---

**Note:** Microsoft Outlook supports this action.

---

## Using Send action

Use the **Send** action to send an email. This action enables you to send an email to one or more recipients from Microsoft Outlook or a mail server, attach files, and select to send the email in plain text or HTML format.

The **Send** action enables you to attach multiple files of various formats to an email. There is no restriction on the type of file you can attach or its size. However, restrictions implemented by the mail server you are using to send an email apply. For example, a task will fail if the files you have attached to the email you are sending do not adhere to the restrictions applied by the mail server.

**Note:** Attachments sent as part of email automation are subject to the policies and rules set at the level of the proxy server, firewall, antivirus, email server, customer environment, and so on.

---

To send an email from a Gmail or Yahoo account, enable access to a less secure app for that account. See [Email server settings](#) on page 2528.

1. In the **Actions** palette, double-click or drag the **Send** action from the **Email** package.
  2. In the **To address** field and the optional **Cc** and **Bcc** fields, enter the email addresses of the recipients.
- 

**Note:** The **To address**, **Cc**, and **Bcc** fields are not case-sensitive.

---

3. When you send an email, and if you are uncertain about the validity or activation of any user email address, you can select the **Raise error if the email ids are invalid** option. When you select the **Raise error if the email ids are invalid** option and execute, the bot will display an error message if any invalid or deactivated email IDs are found.
- 

**Note:** Depending on the email server connection, the bot might or might not detect an invalid or deactivated email ID.

---

4. In the **Subject** field, enter the subject for the email.
  5. Optional: To specify whether to attach multiple files as a list or create a variable to hold the list values of the file object, select the **List** or **Variable** tab from **Attachment**.
- 

**Note:** When you create a bot, if the attachment includes the less-than symbol (<) as a special character in the filepath, the special character will be removed after bot execution because the Windows operating system does not support this special character.

---

Option	Description
List	<ul style="list-style-type: none"> <li>Select the attachment from a location:                             <ul style="list-style-type: none"> <li><b>Control Room file:</b> Enables you to select an attachment that is available in a folder.</li> <li><b>Desktop profile:</b> Enables you to select an attachment that is available on your device.</li> </ul> </li> </ul> <p>You can provide a combination of static path or string variable. To use it as a string variable, copy the static path from your desktop and create a variable of type string. Enter the <b>Variable</b> name and paste the file path in the <b>Default value</b> field. Press F2 to insert the value of the filepath.</p> <ul style="list-style-type: none"> <li><b>Variable:</b> Enables you to specify the file variable that contains the location of the attachment.</li> </ul> <ul style="list-style-type: none"> <li>Specify the path that you want to attach in the <b>Value</b> field. Click <b>Add</b> to attach multiple files.</li> </ul>
Variable	<p>Enables you to specify the list of file objects that contain the location of the attachments.</p> <p>Create a new variable of type <b>List</b> with subtype <b>File</b>, and add the filepath in the <b>Default value</b> field (optional). You can choose the file from the <b>Desktop</b> or <b>Control room</b>.</p>

6. Optional: Select the **Raise error if attachments are missing (desktop only)** check box to verify that you have attached a file and the attached file exists.

Option	Result
The <b>Raise error if attachments are missing (desktop only)</b> check box is selected	If a file is not attached, the email is not sent and the bot encounters an error.
The <b>Raise error if attachments are missing (desktop only)</b> check box is not selected	The email is sent even if a file is not attached.

7. Select the format that you want to use from the following options:

Option	Description
Plain text	Use regular text in your email body, with no formatting effects, such as bold, italic, or underline, or special layout options.

Option	Description
HTML code	Use HTML script in your mail body when you want your content to be displayed in a certain layout every time. You can also include interactive elements, such as links.
HTML design editor	Use this option to create and customize your email layout and body. Use the editor toolbar to make various changes to your text, such as applying bold, italic, and other formatting effects, inserting links, and changing the font and size of the text. You can copy the content from the design editor and paste it to other windows.

8. Enter the content you want to send along with the email in the **Message** field.  
The email will be appended to the message you have specified.
9. Optional: Select the **Include Go Green message at the end of the email** check box.  
The Go Green message appends the following text to the email body: Please consider the environment before printing. Let's Go Green!
10. Select the **Email server, EWS** or **Outlook** option from the **Send email via** list to specify whether to send the emails using Exchange Web Services (EWS), Microsoft Outlook, or a mail server.
  - If you selected the **Outlook** option, you do not have to provide any additional details.

---

**Note:** Multiple accounts are not supported on the local system. Set up only one account to access mails using bots.

- **Email server:** For information about the host and port to be used for the various mail servers, see [Email server settings](#) on page 2528.
  - **From address** Enter the email address.

---

**Note:** If the mail server does not support sending an email using an alias email address, use the same email ID in the **From address** as provided in the **Username** field while configuring the mail server.

- **Use secure connection (SSL/TLS):** Select **True** or **False**, or insert a Boolean variable.
- **Email server host:** Enter the host you want to connect.

---

**Note:** If you use the host Outlook.office365.com, there is a limit of 30 messages sent per minute and 10,000 recipients per day.

- **Email server port:** Enter the port you want to use to establish the connection.
- **My server requires authentication:** Select **True** or **False**, or insert a Boolean variable.
- **Authentication mode:** Select the authentication type:
  - **Basic**
  - **OAuth2 – Authorization code with PKCE**

Depending on the authentication mode that you selected, you must specify the details in the following fields as applicable.

- **Username:** Enter the username that you want to use to access the mail server.  
For example, john.smith@myCompanyName.com
- **Password:** Enter the password for the username you provided.
- For **Client ID**, **Tenant ID**, **Redirect URI**, and **Client secret** fields, enter the information that is provided for your account on your [Azure portal](#).
- **Email provider:** Select your email service provider from the drop-down list.
  - **Outlook/Office365**  
If you select this option, then provide the **Tenant ID**.
  - **Gmail**

For **Username**, **Password**, **Tenant ID**, **Client ID**, and **Client secret** fields, choose from **Credential**, **Variable**, or **Insecure string** tab:

- **Credential:** Use a value available in the credential vault.
- **Variable:** Use a user-defined variable that stores the values.
- **Insecure string:** Manually enter a value.
- **EWS Server:**
  - **Exchange Version:** Select the version that your organization is using:
    - Exchange Server 2013
    - Exchange2010\_SP2
    - Exchange2010\_SP1
    - Exchange2010
    - Exchange2007\_SP1
  - **Azure cloud:** Select the product that your organization is using:
    - **Azure Global:** For customers of Microsoft 365 Commercial version (login.microsoftonline.com)
    - **Azure US GCC High:** For customers of Microsoft 365 Government version (login.microsoftonline.us)
  - Optional: **Domain name:**
    - If you are an Microsoft 365 customer and you leave this field blank, Automation Workspace uses smtp.office365.com to connect to the server.
    - If you are an Microsoft 365 customer and you have entered a domain name in the **username** field, you must enter `smtp.office365.com` in this field.
    - If you are not an Microsoft 365 customer, enter the domain name of your organization. Otherwise, Automation Workspace uses the domain name you provided in the **Username** field.
  - **Authentication mode:** Select the authentication types:

---

**Note:** From Automation 360 v.27 or later, the authorization type **OAuth2-Silent authentication mode** is renamed to **OAuth2-ROPC**, and the **OAuth2-Interactive authentication mode** is renamed to **OAuth2-Implicit**.

---

- **Basic**
- **OAuth2-ROPC**



- **OAuth2-Implicit**
- **OAuth2 – Authorization code with PKCE**
- **OAuth2 – Client credentials**

Depending on the authentication mode that you selected, you must specify the details in the following fields as applicable.

- **Username:** Enter the username that you want to use to access the mail server.  
For example, `john.smith@myCompanyName.com`
- **Password:** Enter the password for the username you provided.
- For **Client ID**, **Tenant ID**, **Redirect URI**, and **Client secret** fields, enter the information that is provided for your account on your [Azure portal](#).
- **Test connection:** Click **Test connection** to sign in to your account, accept the permissions requested to authenticate, and establish a connection with the server.

---

**Note:** When you perform desktop operation and click **Test connection** to sign in to your account, then add this redirect URI: `https://outlook.office365.com`.

---

For **Username**, **Password**, **Tenant ID**, **Client ID**, and **Client secret** fields, choose from **Credential**, **Variable**, or **Insecure string** tab:

- **Credential:** Use a value available in the credential vault.
- **Variable:** Use a user-defined variable that stores the values.
- **Insecure string:** Manually enter a value.

11. Click **Save**.

## Using the For each mail in mail box iterator

You must use certain **Email** actions within a **Loop** action. Use the **For each mail in mail box** iterator to repeat a set of actions on all the emails within the specific parameters.

First, connect to the email server. [Using Connect action in Email package](#) on page 2523

When you establish a connection with Microsoft Outlook, email messages are processed from the shared mailbox. Ensure that you have set up the shared mailbox in your Outlook application.

---

**Note:** This feature is supported only for Outlook.

---

You must use the following Email actions within a loop:

- **Change status**
- **Delete**
- **Save attachments**
- **Save email**

Emails are retrieved based on the sequence of the folders listed in the inbox field. Within each folder, emails are retrieved based on received date and time in the last in, first out (LIFO) order. Additionally, you can apply filters on the following fields:

- Types of emails: **All**, **Read**, and **Unread**

- Subject
- From a specific folder
- From specific sender
- Before, on, or after received date

To use an Email action within a loop, follow these steps:

1. Double-click or drag the **Loop** action from the **Loop** package in the **Actions** palette.
2. Select the **For each mail in mail box** option from the **Iterator** list.
3. In the **Session name** field, enter the name of the session that you used to connect to the email server in the **Connect** action.
4. In the **ALL**, **READ**, or **UNREAD** options, specify the type of email to retrieve from the email server.

---

**Note:** For an email server that uses the POP3 protocol, all emails are retrieved.

---

5. Optional: Specify the folder from which you want to retrieve the emails.
  - Microsoft Outlook and Yahoo: You can specify the name of the folder.  
For example, `Inbox`, `Sent`, `Inbox/Sales`, `Inbox/IT` and so on. The `Sales` and `IT` folders in this example are user-created folders and not available by default.
  - Gmail:
    - To retrieve emails from the default folders, you must use `[Gmail]/FOLDER`, except for the `Inbox` folder.  
For example, `[Gmail]/Draft`, `[Gmail]/Important`, `[Gmail]/Trash`, and so on.
    - To retrieve emails from the folders you have created or the `Inbox` folder, you must specify the folder names as they are.  
For example, if you have created folders called `Bank` and `Sports` in your Gmail, specify `Bank` and `Sports` without the `[Gmail]` prefix to retrieve emails from these folders.

6. Optional: In the **When subject contains** field, specify a value to retrieve emails containing the value you specified in their subject.

You can enter multiple text separated by semi-colon. When you specify multiple text separated by semi-colon, the emails are retrieved with any text or combination of text. For example, `[Subject]=[Automation Anywhere]`: The filter searches and retrieves emails where subject text includes `Automation` or `Automation Anywhere`.

To know about the behavior of the subject filter for package version 3.13.1-20220713-173156 and later using Microsoft Outlook server or Email server, see [How subject filter works when moving emails](#).

7. Optional: In the **From specific senders** field, specify the email addresses to retrieve the emails.
8. Optional: In the **When received date is on or after** list, select an option to retrieve specific emails on or after a certain date.
9. Optional: In the **When received date is on or before** list, select an option to retrieve specific emails on or before a certain date.

If you have specified values for Steps 6 through 9, the system retrieves only those emails that meet all the criteria. For example, if you specify `Bank` in Step 5, `Statement` in Step 6, and `abcbank@xyz.com` in Step 7, the system retrieves emails from the `Bank` folder that contain `Statement` in the subject and were received from the `abcbank@xyz.com` email address.

10. Choose one of the following options from **Use local timezone**
  - True: The email received date and time is displayed in the local time zone.
  - False: The email received date and time is displayed in the UTC time zone.
  - Variable: Enter a Boolean variable.
11. Optional: In the **Assign the current value to variable** list, select or create a dictionary variable.  
The dictionary variable stores the properties of each email. [Using dictionary variable for email properties](#) on page 2547.
12. Click **Save**.

Insert a **Message Box** action into the **Loop** container to print the subject of each email. Use the following message body, substituting the generic variable name for the one you used in Step 10:  
`$dictionaryVar{emailSubject}$`

## Using dictionary variable for email properties

When you automate an email-related task, Automation Workspace retrieves various properties of an email and stores the values of these properties in a dictionary variable. These properties are stored in a dictionary variable when you use an email action within a loop action.

Some of the email properties that Automation Workspace retrieves are its subject, recipients, senders, message, and received date and time. The email properties are stored in a dictionary variable within the following dictionary keys:

Email property	Data type	Description
emailSubject	String	Retrieves the value of the email subject.
emailFrom	String	Retrieves the email ID which is received from. The from address is what your recipients will see.
emailTo	String	Retrieves the recipient's email ID.
emailCc	String	Retrieves the recipient mail id from the CC list.
emailBcc	String	Retrieves the recipient mail id from the BCC list.
emailMessage	String	Retrieves the text from the email body.
emailReceivedTime	String	Retrieves the time when the email was received.
emailReceivedDate	String	Retrieves the date when the email was received.
emailSentTime	String	Retrieves the time when the email was sent.

---

Email property	Data type	Description
emailSentDate	String	Retrieves the date when the email was sent.
emailNoOfAttachments	String	Retrieves the attachment count. If there are no attachments, the count displayed is 0.

---

**Note:** The email received and sent date and time are retrieved in the following format:

- Date: dd/MM/yyyy HH:mm:ss  
Sample output: 22/09/2022 17:07:13
- Time: HH:mm:ss Z  
Sample output: 17:07:13 +0900

---

The system automatically associates the properties of an email with the appropriate dictionary keys. You can use the values stored in these dictionary keys in another task, store them in a database, or for any other purpose. These keys are available in the system and you must use them as specified above. For example, if you have created a dictionary variable 'Test' and want to display the subject and sender of an email in a message prompt, you must enter `Test{emailSubject}` and `Test{emailFrom}` in the appropriate fields.

If you press F2 to use a variable in a field, you must select `Test` from the **Choose a variable** list and enter `emailSubject` in the **Dictionary key** field in the **Insert a variable** dialog box to store the subject of an email in that field. Similarly, you can enter `emailFrom` in the **Dictionary key** field to use the email address of the sender of an email in a field.

The dictionary key variable is required for all email-related tasks you automate from Microsoft Outlook and any mail server if you want to use the email properties. You can use the dictionary key variable for the following **Email** actions:

- **Change status**
- **Delete**
- **Forward**
- **Reply**
- **Save attachments**
- **Save email**

---

**Note:** The time required to save an email varies based on the size of the attachments available in that email.

---

## How subject filter works when moving emails

In the **Move all** action and the **Loop** action in the Email package, learn how the subject filter works in order to move your emails from one folder to another in the email or Microsoft Outlook server.

You can use the keywords in the email subject field to filter emails. If keywords are added within quotes, the bot will look for an exact match of keywords in the subject field to filter and retrieve emails.

### Outlook server

The following table explains how the subject filter works when the subject field contains single, multiple texts, or multiple subjects separated by semi-colon.

- Single text

Result	Example
With double quotes: Retrieves emails with the exact subject text and is case-sensitive.	Example: [Subject]=[ "Automation" ]: The filter retrieves emails where the subject text includes "Automation" as an exact word.
Without double quotes: Retrieves emails that have the similar text and is not case-sensitive.	Example: [Subject]=[Automation]: The filter searches and retrieves emails where the subject text includes Automation.

- Multiple text

Result	Example
With double quotes: Retrieves emails with the exact subject text and is case-sensitive.	Example: [Subject]=[ "Automation Anywhere" ]: The filter retrieves emails where subject text includes "Automation Anywhere" as an exact phrase.
Without double quotes: Retrieve emails with any text or combination of text and is not case-sensitive.	Example: [Subject]=[Automation Anywhere]: The filter searches and retrieves emails where subject text includes Automation or Automation Anywhere.

- Multiple subjects separated by semi-colon

Result	Example
With double quotes:Retrieves emails with the complete subject line that is an exact match including the semicolon and double quotation marks.	Example: [Subject 1] =["Delivery Failure"];[Subject 2] =["Mail server not found"], separated by a semicolon.  The filter retrieves emails with the subject line as one string that is an exact match with the semicolon, such as "Delivery Failure ; Mail server not found".
Without double quotes: Retrieve emails with the complete subject line including the semicolon.	Example: [Subject 1]= ["Delivery Failure"];[Subject 2]= ["Mail server not found"], separated by a semicolon.  The filter retrieves emails with the subject line that includes text as one string with the semicolon but is not an exact match, such as: Delivery Failure ; Mail server not found or delivery failure ; mail server not found.
Some with double quotes and some without double quotes: Retrieve emails with the complete subject line that is an exact match including the semicolon.	Example: [Subject 1]= [Delivery Failure];[Subject 2]= ["Mail server not found"], separated by a semicolon.  The filter retrieves emails with the subject line as one string that is an exact match with the semicolon, such as: Delivery Failure ; Mail server not found.

## Email server

The following table explains how the subject filter works when the subject field contains single, multiple texts, or multiple subjects separated by semi-colon.

- Single text

Result	Example
With double quotes: Retrieves emails with the exact subject text and is case-sensitive.	Example: [Subject]=["Automation"]: The filter retrieves emails where the subject text includes "Automation" as an exact word.
Without double quotes: Retrieves emails that have the similar text and is not case-sensitive.	Example: [Subject]=[Automation]: The filter searches and retrieves emails where the subject text includes Automation.

- Multiple text

Result	Example
With double quotes: Retrieves emails with the exact subject text and is case-sensitive.	Example: [Subject]=[ "Automation Anywhere" ]: The filter retrieves emails where subject text includes "Automation Anywhere" as an exact phrase.
Without double quotes: Retrieve emails with any text or combination of text and is not case-sensitive.	Example: [Subject]=[Automation Anywhere]: The filter searches and retrieves emails where subject text includes Automation Or Automation Anywhere.

- Multiple subjects separated by semi-colon

Result	Example
With double quotes: Retrieve emails for each subject that is an exact match and is case-sensitive.	Example: [Subject 1] =[ "Delivery Failure" ]; [Subject 2] =[ "Mail server not found" ]  Individual subjects separated by a semicolon with an exact match are searched. The filter retrieves emails with the subject line "Delivery Failure" and/or "Mail server not found".
Without double quotes: Retrieve emails for each subject and is not case-sensitive.	Example: [Subject 1]= [Delivery Failure]; [Subject 2]= [Mail server not found]  The filter retrieves emails that include the subject line with text as Delivery Failure or Mail server not found.
Some with double quotes and some without double quotes: Retrieve emails for each subject. Subjects within double quotation marks are an exact match. Subjects without double quotes are not case-sensitive.	Example: [Subject 1]= [Delivery Failure]; [Subject 2] = [ "Mail server not found" ]  <ul style="list-style-type: none"> <li>For Subject 1, the filter searches and retrieves emails that include the text in the subject line.</li> <li>For Subject 2, the filter searches and retrieve emails with the exact text in the subject line.</li> </ul>

## EWS Server

The following table explains how the subject filter works when the subject field contains single or multiple texts with, or without, double quotes.

Email Subject										
Search with keyword:	move email	move email (Include space)	Move email	"move email"	"Move email"	" move email" (I space)	" Move email" (I space)	move email test	move email	email
move email	Yes	Yes	Yes	Yes	Yes	Yes	Yes	Yes	-	-
move email	-	-	-	-	-	Yes	Yes	-	-	-
Move email	Yes	Yes	Yes	Yes	Yes	Yes	Yes	Yes	-	-
"move email"	Yes	Yes	-	Yes	-	Yes	-	Yes	-	-
"Move email"	-	-	Yes	-	Yes	-	Yes	-	-	-
" move email"	-	-	-	-	-	Yes	-	-	-	-
" Move email"	-	-	-	-	-	-	Yes	-	-	-
move email test	-	-	-	-	-	-	-	Yes	-	-
move email	Yes	Yes	Yes	Yes	Yes	Yes	Yes	Yes	Yes	-
email	Yes	Yes	Yes	Yes	Yes	Yes	Yes	Yes	-	Yes
email"	-	-	-	Yes	Yes	Yes	Yes	-	-	-
"move email"	-	-	-	Yes	Yes	-	-	-	-	-

**Note:**

- When you search with keywords such as `move email`, `Move email`, or `move`, the bot will look for the keywords in the **Subject** field to filter and retrieve emails.
- When you search with keywords inside a pair of double quotation marks in the **Subject** field such as `"Move email"`, `"Move email"`, `"move`, or `email"`, the bot will look for an exact match of keywords and is case-sensitive to filter and retrieve emails.

## Error handler package

If a bot encounters an error due to an abnormal condition or exceptions during execution, the normal execution of the bot is hindered, and the bot fails to complete the task. The Error handler package contains actions that enable you to easily handle exceptions a bot encounters and transfers control to the other actions within that bot.



The actions in the package enable you to separate the actions you want to use to perform a task from the actions you want to use to handle an exception. Handling exceptions ensures that a bot completes a task when it encounters an error and defines actions when an error occurs. Exceptions can be handled by the parent bot or any of the available child bots. However, the bot execution will fail if there is no error handling available in either the parent or child bots.

The following image illustrates how bot execution works when you use and do not use error handling in your task.

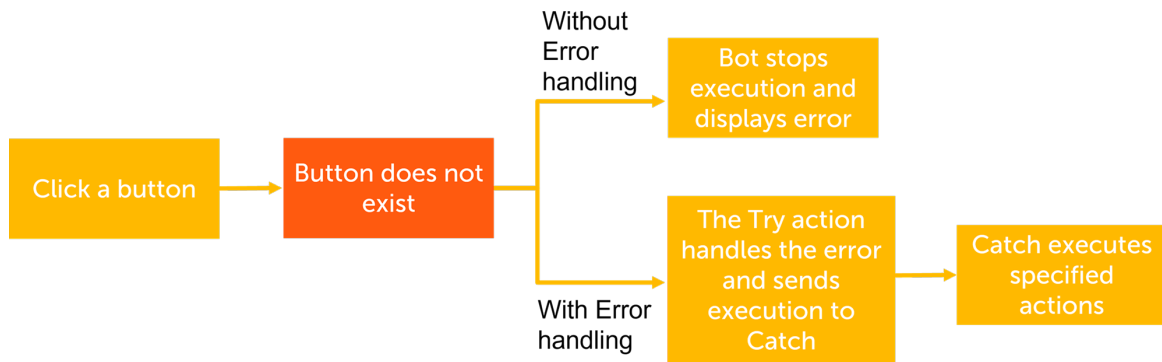

### Actions in the Error handler package

The Error handler package includes the following actions:

Action	Description
Try	See <a href="#">Try action in Error handler</a> on page 2555.
Catch	See <a href="#">Catch action in Error handler</a> on page 2556.
Finally	See <a href="#">Finally action in Error handler</a> on page 2557.
Throw	See <a href="#">Throw action in Error handler</a> on page 2557.

### How Error handler handles exceptions

The following image illustrates the flow of actions of the Error handler package when an external error is encountered during bot execution.

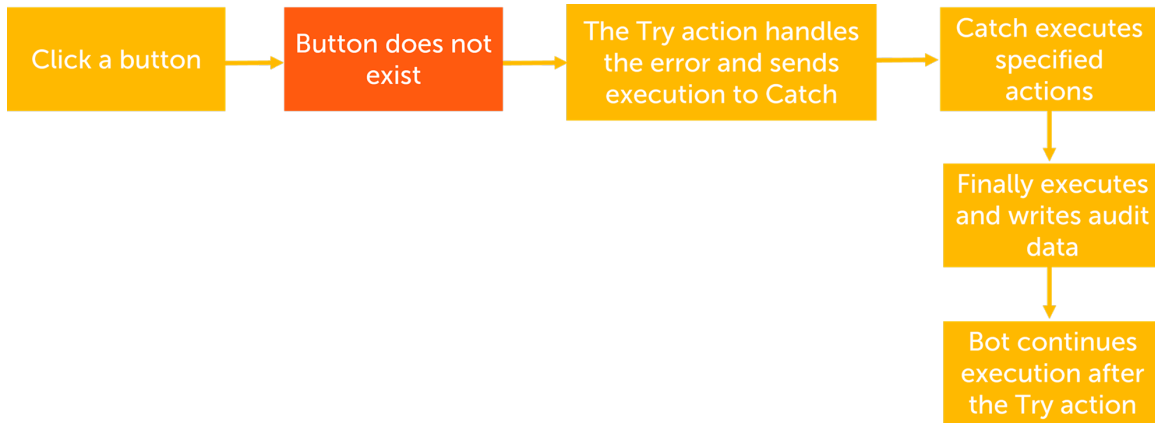

The following image illustrates the flow of actions of the Error handler package when an internal error is encountered during bot execution.

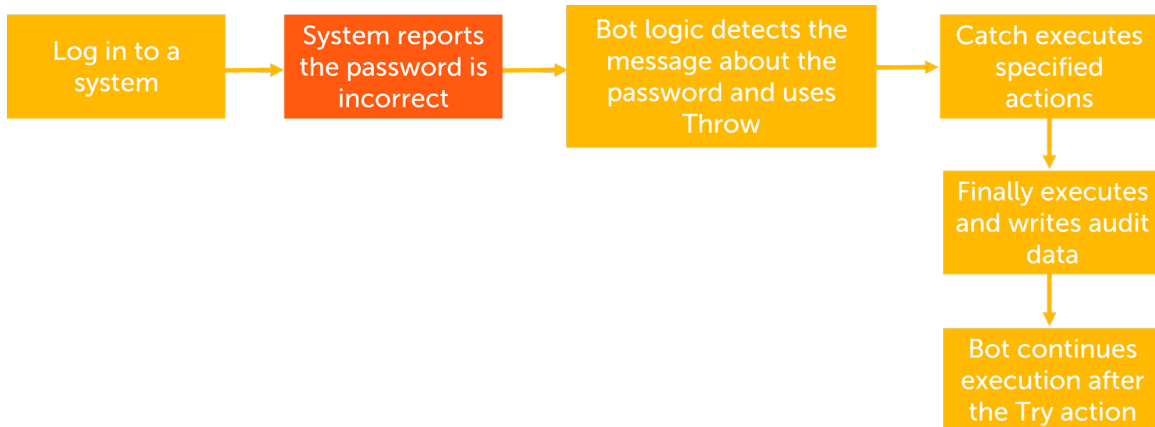

### Example: Using the actions in the Error handler package

For example, if you have a bot that reads data from a Microsoft Excel file and stores it in a database. The bot might encounter an error if the required file is not available or while updating a table in the database. Use the following methods to handle the errors:

- Exception 1:
  - The Microsoft Excel spreadsheet from which you want to extract data is not available.
  - How to handle: Use another file that contains the same data.
- Exception 2:
  - The table that you want to use to store the data is not available in the database.
  - How to handle: Display a message that the required table is not available.

Based on this example, perform the following to handle the mentioned exceptions:

1. Place all the actions that are for reading the data from the Microsoft Excel spreadsheet and storing the extracted data into a table in the database within the **Try** action.
2. Place the actions to run for the following exceptions within the **Catch** action:

- a) Exception 1: Place the actions to use the alternate file that contains the same data.
  - b) Exception 2: Place the **Message box** action to display a relevant message.
3. Place the **Database > Disconnect** action to terminate the connection with the database within the **Finally** action, which occurs regardless of the **Try** outcome.

Related reference

[Error handler package updates](#) on page 878

Review the updates in released versions of the Error handler package such as new and enhanced features as well as fixes and limitations. The page also lists the release dates of each version, and the compatible Control Room and Bot Agent versions.

## Try action in Error handler

The **Try** action in the Error handler package can be used to add the other actions for the bot.

### Settings

By including the **Catch** action, an error or exception message is displayed when any of the actions that you have added in the **Try** action encounter an error. If the bot does not encounter any errors, execution continues to the **Finally** action if it exists. Consider the following example of using the **Try** action where you want to copy a file from one location to another, and open it. The following image shows the **Copy** and **Open** actions in the **Try** action:

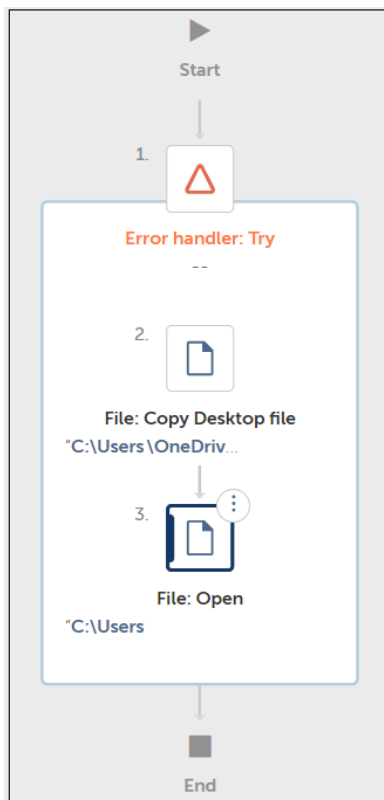

In the above scenario, an error can occur for the following:

- If the file that you are trying to copy does not exist.
- If you have specified a wrong filepath in the **Copy** action and the file was copied elsewhere.

In either case, the bot will be executed. However, if you have the **Catch** action, an error message can be displayed.

## Catch action in Error handler

Use the **Catch** action in the Error handler package to take control of the bot execution when an error occurs within the **Try** action.

You can assign values for the error description and the line number to variables within the **Catch** action. You can add additional actions within a **Catch** block to handle errors. These actions can include an Email **Send** action (sending an email about the error), a **Log to file** action (logging the error condition to a file), or a Screen **Capture window** to capture a screenshot of the window or application when the error occurs.

You can use the **Try** and **Catch** actions multiple times in a bot. This enables you to run a different set of actions based on any exceptions that might be encountered.

Consider a scenario where you want to copy a file from one location to another, open this file to view it, and then log any errors that are encountered during this process. You can use the **Copy** and **Open** actions from the **File** package in the **Try** block. You can then use the **Log text to file** action in the **Catch** block to capture any errors encountered during the bot run. The following

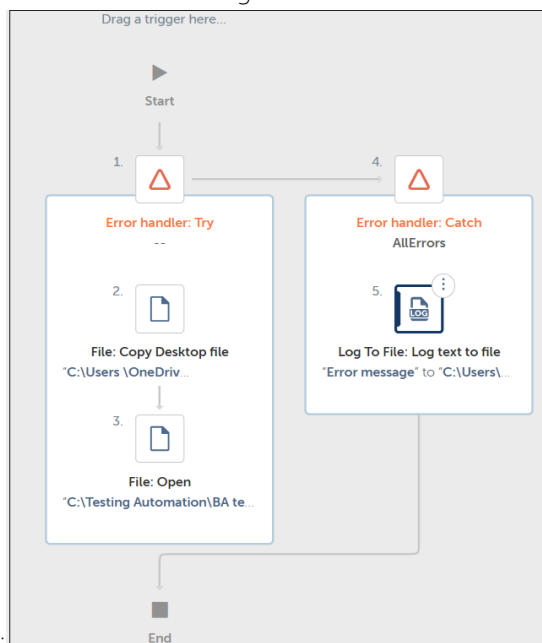

image shows the flow for this sample scenario:

## Settings

- Use the **Exception** drop-down to select **Error handler**.  
The **Error handler** applies to all the exceptions or errors that are encountered in the **Catch** block. You can then use the **Assign exception message to** field to provide a variable to store the exception message.
- Select the **On error, continue with next action** check box.

When you select the **On error, continue with next action** check box, even if there is an error from an action in the **Catch** block, no exception is thrown and the bot continues to the next action.

---

**Note:** This enhancement applies to all the nested actions in the **Catch** block. For example, you add a nested **Catch** block inside an existing (main) **Catch** block. If you select the **On error, continue with next action** check box in the main **Catch** block, errors from any of the actions in the nested **Catch** block are also handled (ignored).

---

- (Optional) Use the **Assign exception message to** field to select an existing variable.

Use this field to provide a variable to store the exception if any of the actions encounter an error. For example, if you have used the **File > Open** action and it encountered an error, the **Assign exception message to** can be used to review the error message. The error message must be stored in a variable that you reference when logging the error so that you can have some insight into what has caused the issue. If there are no existing variables, click the **Create variable** icon to create one.

- (Optional) Use the **Assign the line number to** field to select an existing variable.

Use this field to provide a number variable to hold the exact line number where an error occurred in the **Try** action. Like the exception error message, the line number is also stored in a log file for troubleshooting and further investigation. You can use the line number in either the **List** or **Dual** view of the bot editor to review the actions.

---

**Note:** The code inside the **Catch** action is only executed if there is an error. If everything in the **Try** block runs successfully the **Catch** action will not be executed.

---

## Finally action in Error handler

Use the **Finally** action in the Error handler package to enable you to execute actions after **Try** and **Catch**, regardless of whether an exception occurs or not.

### Settings

The **Finally** action is most useful in logging audit information or any action that must follow the end of the **Try** and **Catch** actions.

## Throw action in Error handler

Use the **Throw** action in the Error handler package to create an error condition, which will immediately shift the bot execution to the **Catch** action.

If a logical error occurs in the **Try** action, you can use the **Throw** action to create an error condition, which will immediately shift the bot execution to the **Catch** action. You can edit the **Throw** action properties to set the error message to be sent to the **Catch** action. Outside of a **Try** action, the **Throw** action causes a standard error dialog box to be displayed, requiring a user to manually click the **Close** button to dismiss it.

Consider a scenario where your bot is reading data from a spreadsheet that contains employee IDs in column A. If there is an empty row or an invalid employee ID, the **Throw** action will trigger the **Catch** block to record the error. The **Try**, **Catch**, and **Finally** actions can be used within a

loop. This ensures that capturing such errors does not have to necessarily stop the processing of the entire automation. Instead, just stop the processing of that one data record and log the error.

## Settings

- (Optional) Use the **Please enter exception message** field to enter a message that must be displayed when the bot encounters an error.

You can also click the **Insert a variable** icon to select an existing variable.

- Use the **Exception** drop-down to select a botexception.

## Excel basic package

The Excel basic package contains actions that enable you to automate many of the repetitive tasks in XLSX workbooks. You use these actions when Microsoft Excel is not available on the device that you want to use to automate Microsoft Excel-related tasks.

---

**Note:** The XLS and CSV formats are not supported and you cannot set a value in the XFD column of a spreadsheet.

---

**Important:** If you use different versions of the Excel basic package in a parent bot and a child bot, the capability to share a session across bots is currently not supported. To share a session across parent and child bots, ensure that you use the same version of the package in both the parent and child bots.

---

**Important:** When you use Microsoft Excel Version 2208 and a bot tries to open an unprotected macro, a security warning is displayed indicating that the macros are blocked as they are not from a trusted source.

See [Macros from the internet will be blocked by default in Office](#) for more details.

---

## Choosing the Excel package in Automation 360

Automation 360 includes packages to support three types of Microsoft Excel usage. For optimal results, use the package that corresponds to the type of Excel that is available on the device you are running bots on.

- No Excel installed: If you do not have Microsoft Excel installed on the device on which you are running bots to automate Excel-related processes, use the Excel basic package.
- Desktop Excel installed: If you have a desktop version of Microsoft Excel installed on your computer, use the Excel advanced package in your bots.
- Online Microsoft 365 Excel only: If you are using Microsoft Excel 365 on a web browser, use the Microsoft 365 Excel package for automating tasks related to Excel.

---

**Recommendation:** For any bot automation use case that cannot be fulfilled by the Excel basic package, we recommend that you use the Excel advanced package. When you use that Excel basic package, you might experience limitations because of the Apache POI API that the package

uses. Because of this, the Excel basic package has limited capability when compared to the Excel advanced package that uses the MS API.

To learn more, search for the Automating Excel Workbooks course in [Automation Anywhere University: RPA Training and Certification \(A-People login required\)](#).

## Before you start

Perform the following actions within the Excel basic package as part of using the set of available actions:

1. Open the Microsoft Excel spreadsheet that you want to read data from using the **Open** action.

---

**Note:** The Excel basic package supports files that are a maximum size of 30 MB.

---

You must associate the details of the file you want to use with a session name, and use the session name in the other actions in the Excel basic package, so that you do not have to provide the details of the file in those actions again.

2. Use the different actions available in the Excel basic package to automate the Microsoft Excel-related tasks.
3. After you have automated all the Microsoft Excel-related tasks, close the spreadsheet using the **Close** action.

## Actions in the Excel basic package

The Excel basic package includes the following actions:

Action	Description
Close	See <a href="#">Close action</a> on page 2560.
Delete cells	See <a href="#">Delete cells action</a> on page 2560.
Find	See <a href="#">Using Find action in Excel</a> on page 2587.
Get cell address	See <a href="#">Get cell address action</a> on page 2562.
Get column name	See <a href="#">Get column name action</a> on page 2562.
Get multiple cells	See <a href="#">Get multiple cells action</a> on page 2561.
Get row number	See <a href="#">Get row number action</a> on page 2562.
Get single cell	See <a href="#">Get single cell action</a> on page 2561.

Action	Description
Go to cell	. See <a href="#">Go to cell action</a> on page 2563.
Open	See <a href="#">Using the Open action</a> .
Replace	See <a href="#">Using the Replace action</a> on page 2593.
Save workbook	See <a href="#">Save workbook action</a> on page 2564.
Set cell	See <a href="#">Set cell action</a> on page 2564.
Switch to sheet	See <a href="#">Switch to sheet action</a> on page 2565.

Related reference

[Excel basic package updates](#) on page 881

Review the updates in released versions of the Excel basic package such as new and enhanced features as well as fixes and limitations. The page also lists the release dates of each version, and the compatible Control Room and Bot Agent versions.

## Close action

The Close action in the Excel basic package enables you to close an excel spreadsheet and **Save changes** when closing the file.

### Settings

Closes the current workbook and provides an option to **Save changes** when closing the file. Enter the name of the session used to open the workbook with the **Open** .

---

**Note:** This action terminates the process for the session.

---

## Delete cells action

The Delete cells action in the Excel basic package enables you to delete the **Active cell** or a **Specific cell** from the current worksheet.

### Settings

- Select the **Active cell** or **Specific cell** option to specify whether to retrieve the values from the active cell or a specific cell.
- Select the **Shift cells left** or **Shift cells up** option to specify whether to shift the cell one position to the left or up after the cell is deleted.
- Select the **Entire row** or **Entire column** option to specify whether to delete the entire row or column of the cell.
- Enter the name of the session used to open the workbook with the **Open** .



## Get multiple cells action

The Get multiple cells action in the Excel basic package enables you to retrieve the values from cells in a Microsoft Excel spreadsheet and stores them in a table variable.

### Settings

This action retrieves cell values as string data types. It supports Excel cell formats, including Number, Percentage, Currency, Scientific, and Date. For example, a value from a cell of Currency formatting retains the currency symbol when passed to a table or record variable.

**Note:** You must convert the values to perform non-string operations.

- Select any of the following options from the **Loop through** field:

Option	Action
<b>All rows:</b>	Enables you to retrieve the values from all the rows.
<b>Specific row:</b>	Enables you to retrieve the values from the row you have specified in the <b>From row</b> and <b>to row</b> fields.
<b>Cell range:</b>	Enables you to retrieve the values from the range of cells you have specified in the <b>From cell</b> and <b>to cell</b> field.

- Enter the name of the session used to open the workbook with the **Open** .
- In the **Get value to the variable (optional)** field, create or insert an existing string variable.

## Get single cell action

The Get single cell action in the Excel basic package enables you to retrieve the values from a single cell in a Microsoft Excel spreadsheet and stores them in a string variable .

### Settings

This retrieves cell values as string data types. It supports Excel cell formats, including Number, Percentage, Currency, Scientific, and Date. For example, a value from a cell of Currency formatting retains the currency symbol when passed to a table or record variable.

**Note:** You must convert the values to perform non-string operations.

- Select the **Active cell** or **Specific cell** option to specify whether to retrieve the values from the active cell or a specific cell.
- Enter the name of the session used to open the workbook with the **Open** .
- In the **Store cell contents to** field, create or insert an existing string variable.

You can use the output value to

[Example of using a conditional statement](#) on page 3208

## Get cell address action

The Get cell address action in the Excel basic package enables you to retrieve the location of the active cell and stores it to a string variable.

### Settings

- Enter the name of the session used to open the workbook with the **Open** .
- In the **Save the active cell address in local variable** field, create or insert an existing string variable.

## Get column name action

The Get column name action in the Excel basic package enables you to retrieve the letter value of the column of the active or specific cell and store it to a string variable.

### Settings

- Select the **Active cell** or **Specific cell** option to specify whether to retrieve the column name from the active cell or a specific cell.
- Enter the name of the session used to open the workbook with the **Open** .
- In the **Save the column name into local variable** field, create or insert an existing string variable.

## Get row number action

The Get row number action in the Excel basic package enables you to retrieve the row number of the active or specific cell and stores it to a string variable.

### Settings

- Select the **Active cell** or **Specific cell** option to specify whether to retrieve the row number from the active cell or a specific cell.
- Enter the name of the session used to open the workbook with the **Open** .
- In the **Save the row number into local variable** field, create or insert an existing string variable.

## Go to cell action

The Go to cell action in the Excel basic package enables you to select a specific cell in a Microsoft Excel spreadsheet.

### Settings

- Select the **Active cell** or **Specific cell** option to specify which cell to select.
- Enter the name of the session used to open the workbook with the **Open** .

## Using the Open action for Excel basic

Use the **Open** action to open Microsoft Excel spreadsheet in read-only mode or read-write mode, use a password to open the spreadsheet, and so on.

To open a Microsoft Excel spreadsheet, do the following:

1. Double-click or drag the **Open** action from the **Excel basic** package in the **Actions** palette.
2. Select from where you want to open the Microsoft Excel spreadsheet:

---

**Note:** The Excel basic package supports files that are a maximum size of 30 MB.

---

- **Control Room file:** Enables you to open a file from the Control Room.

---

**Note:** When you open an excel file from the Control Room and make changes in the file, the updated file does not save in the Control Room This action is supported only for Excel files opened from the desktop.

---

- **Desktop file:** Enables you to open a file from the device. This field also accepts the file path input as a string variable or global value.
  - **Variable:** Enables you to open a file by specifying a file variable.
3. Select the **Sheet contains a header** check box if the Microsoft Excel spreadsheet contains a header row.
  4. Select the **Specific sheet name** option and specify the name of the sheet to activate when the Microsoft Excel spreadsheet opens.
  5. Select **Read-only mode** or **Read-write mode** to open the Microsoft Excel spreadsheet in read-only or edit mode, respectively.
  6. Select the **Password is required** check box if a password is required to open the Microsoft Excel spreadsheet.
  7. Select any of the following tabs to create an Excel session:
    - **Local session:** Specify a session name that can be used only in the current bot.
    - **Global session:** Specify a session name that can be used across multiple bots, such as parent bots, child bots, and other child bots of the parent bots .

You can also use the **Global session** option to loop through each row in an Excel advanced worksheet.

**Note:** You can open an Excel worksheet by using the **Global session** option and use it across multiple bots without having to share the session by using the **Set session variable** action.

---

You can also close the session from the child bot when you are using the **Global session** option and sharing the session across child bots.

---

**Important:** If you close the session from the child bot and run the parent bot, then in the parent bot, the actions that come after the child bot are not run, and the bot fails with an error because the session has already been closed from the child bot.

---

- **Variable:** Specify a session variable that can be used to share that session with other child bots.
- 

**Note:** When you use more than one workbook to automate an operation, you must use different session names for each workbook. If you want to use the same session name to automate all the workbooks, you must first close the session of one workbook before using the same session name for another workbook.

---

8. Enter the name of the session in the **Session name** field.
9. Click **Save**.

## Save workbook action

The **Save workbook** action in the Excel basic package enables you to save a Microsoft Excel workbook in the same location from where it is opened for any automation.

### Settings

- Double-click or drag the **Save workbook** action from the Excel basic package in the **Actions** palette.
- Use one of the following options to provide session name:
  - **Session name** - Enter the name of the session used to open the workbook with the **Open** . See, [Using the Open action for Excel basic](#) on page 2563.
  - **Variable** - Enter the basic session variable that you have added in the **Set session variable** action or from the parent bot.

## Set cell action

The Set cell action in the Excel basic package enables you to set the value you have specified in a cell in a Microsoft Excel spreadsheet.

### Settings

- Select the **Active cell** or **Specific cell** option to specify whether to set the value in the active cell or a specific cell.

- Enter the cell value to set in the **Value to set** field.
- Enter the name of the session or variable used to open the workbook with the **Open** action.

## Switch to sheet action

The Switch to sheet action in the Excel basic package enables you to activate a specific worksheet.

### Settings

- Select to activate the worksheet by the **Index** value or worksheet **Name**.  
The index is the numeric value assigned to the worksheet.
- Enter the name of the session used to open the workbook with the **Open** .

## Excel advanced package

The Excel advanced package contains actions that enable you to automate many of the repetitive tasks when working with Microsoft Excel spreadsheets.

You can automate tasks related to the workbook, worksheet, rows, columns, and cell operations. You can use these actions when Microsoft Excel is installed on the device that you want to use to automate the Microsoft Excel-related tasks.

---

### Note:

- The Excel file that you use from the Control Room is applicable only for the current bot session. If you modify the file during bot execution, the updated file cannot be uploaded back to the Control Room
- You need not install the Microsoft Access Database Engine as an additional component in your system to use Excel as Database if you are using any of the following office versions:
  - Microsoft 365 Apps for Enterprise
  - Office 2016, 2019, or 2021 (Consumer Version 2009 or later)

However, if you have both Microsoft 365 Apps and the Microsoft Access Database Engine are installed on your system, then you can uninstall the Microsoft Access Database Engine and repair Microsoft 365 Apps.

Microsoft recommends that you do not install the Microsoft Access Database Engine driver separately because both the Microsoft Access Database Engine 2016 and Microsoft 365 Apps use the same major version identifier (16.0). To learn more about the Microsoft Access Database Engine driver installation requirement, see [Unable to use the Access ODBC or OLEDB provider](#)

---

**Important:** When you use Microsoft Excel Version 2208 and a bot tries to open an unprotected macro, a security warning is displayed indicating that the macros are blocked as they are not from a trusted source.

See [Macros from the internet will be blocked by default in Office](#) for more details.

---

---

**Note:** If you use different versions of the Excel advanced package in a parent bot and a child bot, the capability to share a session across bots is currently not supported. To share a session across parent and child bots, ensure that you use the same version of the package in both the parent and child bots.

---

Actions in the Excel advanced package support Microsoft Office 2016 through Microsoft Office 2019, Microsoft 365, and the following file formats:

- .xls
- .xlsx
- .xlsb
- .xml
- .xlsm
- .txt
- .ods
- .htm
- .html
- .mht
- .mhtml
- .slk
- .pdf

---

**Important:**

- For files with .ods extension, unless you specify the sheet name in the **Specify sheet name** field of the **Open** action, the action always opens the .ods file with the first sheet as active, by default. If the sheet name contains a space character, after you save and close the Excel sheet, the space character is displayed as underscore.
- Files with the .htm, .html, .mht, and .mhtml extensions cannot be converted into PDF.
- Files with the .slk and .pdf extensions contain only a single sheet. The sheet cannot be renamed. If you rename the sheet and save the Excel sheet, the sheet does not retain the new name.
- Files with .htm, .html, .mht, .mhtml, .slk, and .pdf extensions cannot retain passwords.
- You cannot run a macro in files with the .pdf extension.
- Note: Macro-enabled Excel applications with VBA using 32-bit and 64-bit code are not supported. If you encounter a `Compile error in hidden module` error message when

running a macro, then see the following image to add the VBA code manually in the Excel file

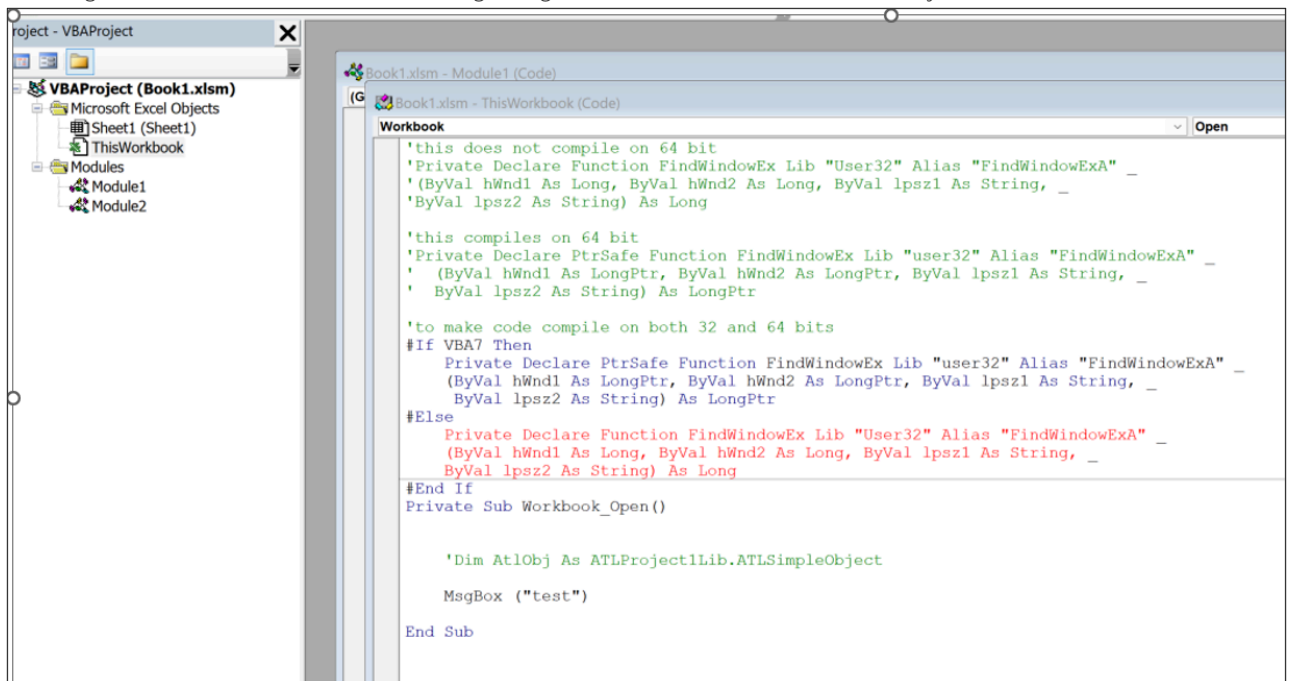

You can also use some of the actions with the .csv format. See [CSV operations in Excel advanced](#) on page 2599.

See [Example of migrating data from Excel to a database](#) on page 3231.

## Choosing the Excel package in Automation 360

Automation 360 includes packages to support three types of Microsoft Excel usage. For optimal results, use the package that corresponds to the type of Excel that is available on the device you are running bots on.

- No Excel installed: If you do not have Microsoft Excel installed on the device on which you are running bots to automate Excel-related processes, use the Excel basic package.
- Desktop Excel installed: If you have a desktop version of Microsoft Excel installed on your computer, use the Excel advanced package in your bots.
- Online Microsoft 365 Excel only: If you are using Microsoft Excel 365 on a web browser, use the Microsoft 365 Excel package for automating tasks related to Excel.

## Before you start

Perform the following actions within the Excel advanced package as part of using the set of available actions:

1. Open the Microsoft Excel spreadsheet that you want to use to automate the Microsoft Excel-related tasks. Use the **Open** action to open the spreadsheet. See [Using the Open action for Excel advanced](#) on page 2571.

**Note:** For files containing large data sets, use actions from the Database package to automate create, read, and update operations. See [Using Connect action for database](#) on page 2469.

2. Use the different actions available in the Excel advanced package to automate the Microsoft Excel-related tasks.
3. After you have automated all the Microsoft Excel-related tasks, close the spreadsheet using the **Close** action.

## Actions in the Excel advanced package

The actions in the Excel advanced package enable you to perform the following operations:

Action	Description
Cell operations	Perform operations such as extracting data from cells, deleting values from a cell, moving a cursor to a specific cell, and finding and replacing content. See <a href="#">Cell operations in Excel advanced</a> on page 2586.
Row and column operations	Perform operations such as inserting new rows and columns, and hiding and unhiding rows and columns. See <a href="#">Row and column operations in Excel advanced</a> on page 2581.
Table operations	Perform operations such as sorting and filtering data in a table, inserting and deleting columns, and getting the table range. See <a href="#">Table operations in Excel advanced</a> on page 2595.
Workbook operations	Perform operations such as opening a workbook, appending data, protecting and unprotecting a workbook, and converting a Microsoft Excel workbook to a PDF file. See <a href="#">Workbook operations in Excel advanced</a> on page 2569.
Worksheet operations	Perform operations such as creating and deleting a worksheet, appending data, and hiding and unhiding a worksheet. See <a href="#">Worksheet operations in Excel advanced</a> on page 2574.

### Example tasks:

- [Example of transferring data from CSV file to Excel worksheet](#) on page 3216
- [Example of using a conditional statement](#) on page 3208

### More resources

- Free Automation 360 bot examples for Excel from Bot Store:
  - [Merge Excel Sheets Example](#)
  - [Convert XML to Excel](#)



- [Convert multiple Excel files to CSV files](#)
- Tutorial on using Excel packages: [Work with large Excel datasets in a bot](#)
- Training course Automating Excel Workbooks - [Automation Anywhere University: RPA Training and Certification \(A-People login required\)](#)

Related tasks

[Using Find action in Excel](#) on page 2587

Use the **Find** action to find a particular string in a Microsoft Excel spreadsheet or a CSV file.

Related reference

[Excel advanced package updates](#) on page 879

Review the updates in released versions of the Excel advanced package such as new and enhanced features as well as fixes and limitations. The page also lists the release dates of each version, and the compatible Control Room and Bot Agent versions.

## Workbook operations in Excel advanced

A workbook is a file that contains one or more worksheets. The **Excel advanced** package contains various actions that you can use to automate workbook-related tasks.

### Workbook actions in the Excel advanced package

The **Excel advanced** package includes the following actions:

Action	Description
Append workbook	See <a href="#">Append workbook action</a> on page 2569
Close	See <a href="#">Close action</a> on page 2570
Convert excel to PDF	See <a href="#">Convert excel to PDF action</a> on page 2570
Create workbook	See <a href="#">Create workbook action</a> on page 2570
Open	See <a href="#">Using the Open action for Excel advanced</a> on page 2571.
Protect workbook	See <a href="#">Protect workbook action</a> on page 2573
Save workbook	See <a href="#">Save workbook action</a> on page 2574
Unprotect workbook	See <a href="#">Unprotect workbook action</a> on page 2574

### Append workbook action

The Append workbook action in the Excel advanced package enables you to add all the worksheets from the specified workbook to the end of the currently open workbook.

### Settings

- Enter the name of the session used to open the workbook with the **Open** .
- Specify the workbook from which you want to append the worksheets in the **Append from workbook** field.

- If the workbook is protected, select the **Password is required** check box and enter the password in the **To open** field.
- In the **To open** field, provide your password with one of the following options:
  - **Credential**: Select a credential from the . [Credentials and credential variables in the Bot editor](#) on page 2344
  - **Variable**: Select a variable holding a credential data type value. [Your variables \(user-defined\)](#) on page 2331
  - **Insecure string**: Enter a value or select a variable.

---

**Important:** Values entered using this option are not encrypted.

---

## Close action

The Close action in the Excel advanced package enables you to close the current workbook and provide an option to save changes when closing the file.

## Settings

Enter the name of the session used to open the workbook with the **Open** .

## Convert excel to PDF action

The Convert excel to PDF action of the Excel advanced package enables you to convert the entire workbook, specific worksheets in a workbook, or a CSV file to a PDF file.

## Settings

- Enter the name of the session used to open the workbook with the **Open** .
- Specify whether you want to convert the **Entire excel file**, **Active sheet**, or **Specific sheet** to a PDF file.
- Enter a name for the PDF file in the **Select PDF file name** field.
- Specify the location where you want to save the file in the **Select PDF storage location** field.

## Create workbook action

The Create workbook action of the Excel advanced package enables you to create a Microsoft Excel workbook or a CSV file.

## Settings

- Enter the name of the session used to open the workbook with the **Open** .
- Specify the location where you want to save the workbook in the **File path** field.
- Specify the name of the worksheet in the **Sheet name** field.
- Specify the passwords to open and edit the workbook in the **Password to open** and **Password to edit** fields. Provide your password with one of the following options:

- **Credential:** Select a credential from the . [Credentials and credential variables in the Bot editor](#) on page 2344
- **Variable:** Select a variable holding a credential data type value. [Your variables \(user-defined\)](#) on page 2331
- **Insecure string:** Enter a value or select a variable.

---

**Important:** Values entered using this option are not encrypted.

---

- Select any of the following tabs to create an Excel session:
  - **Local session:** Specify a session name that can be used only in the current bot.
  - **Global session:** Specify a session name that can be used across multiple bots, such as parent bots, child bots, and other child bots of the parent bots.

You can also use the **Global session** option to loop through each row in an Excel advanced worksheet.

---

**Note:** You can open an Excel worksheet by using the **Global session** option and use it across multiple bots without having to share the session by using the **Set session variable** action.

---

You can also close the session from the child bot when you are using the **Global session** option and sharing the session across child bots.

---

**Important:** If you close the session from the child bot and run the parent bot, then in the parent bot, the actions that come after the child bot are not run, and the bot fails with an error because the session has already been closed from the child bot.

---

- **Variable:** Specify a session variable that can be used to share that session with other child bots.

---

**Note:** If the Microsoft sensitivity label feature is enabled for Microsoft 365 Excel application, see [Automation Anywhere interaction with Microsoft Labels \(A-people login required\)](#)

---

## Using the Open action for Excel advanced

Use the **Open** action to open a Microsoft Excel spreadsheet or a CSV file. This action enables you to specify whether to open the spreadsheet in read-only mode or read-write mode, a password to open the spreadsheet, and so on.

When you use the Open action to open a macro-enabled Excel workbook of .x1sm format, the Auto\_Open VBA procedure does not run automatically because the VBA procedure runs only when the Excel workbook is opened manually. This is a default behavior of Microsoft Excel. See [Behavior difference between Workbook\\_Open and Auto\\_Open procedure](#).

---

**Note:** You can use wildcard pattern based search to open an existing excel file that matches the search criteria. For example, if you have multiple files with similar names such as table1.xlsx, table2.xlsx, table3.xlsx, you can open the file by specifying the (\*) wildcards in the file path as table\*.xlsx to open the first file that matches the pattern.

---

1. Double-click or drag the **Open** action from the **Excel advanced** package in the **Actions** palette.
2. Select from where you want to open the Microsoft Excel spreadsheet:

- **File:** Select one of the following options to open a Microsoft Excel spreadsheet:
  - **Control Room file:** Enables you to open a file from the Control Room.
  - **Desktop file:** Enables you to open a file from the device. This field also accepts the file path input as a string variable or global value.

---

**Note:** In the **Desktop file** field, if you enter a file path or browse to a particular file from the system and if the file path is separated by the backslash (\) characters, when you save the bot, the backslash characters are changed to slash (/) characters because the bot uses slash characters to separate file paths. Your bots continue to run successfully even if the backslash characters are is changed to slash characters during bot run.

---

- **Variable:** Enables you to open a file by specifying a file variable.
  - **SharePoint:** In the **File path** field, enter the exact file path of the Excel spreadsheet on SharePoint. To copy the URL of the Excel spreadsheet from SharePoint, perform the following steps:
    - Open the Microsoft Excel spreadsheet on SharePoint.
    - In the Microsoft Excel spreadsheet, navigate to **File > Info**.
    - Click **Copy path**.
3. Select the **Sheet contains a header** check box if the Microsoft Excel spreadsheet contains a header row.
  4. Select the **Specific sheet name** option and specify the name of the sheet to activate when the Microsoft Excel spreadsheet opens.
  5. Select **Read-only mode** or **Read-write mode** to open the Microsoft Excel spreadsheet in read-only or edit mode respectively.
  6. Select the **Password is required** check box if a password is required to open or edit the Microsoft Excel spreadsheet.
  7. Select the **Load Add-ins** check box if you want to load the add-ins available in the Microsoft Excel spreadsheet.
  8. Select the **Exclude hidden sheets** check box if you want to ignore the excel sheets that are hidden and do not want to perform any operation on those hidden sheets.
  9. Select any of the following tabs to create an Excel session:
    - **Local session:** Specify a session name that can be used only in the current bot.
    - **Global session:** Specify a session name that can be used across multiple bots, such as parent bots, child bots, and other child bots of the parent bots .

You can also use the **Global session** option to loop through each row in an Excel advanced worksheet.

---

**Note:** You can open an Excel worksheet by using the **Global session** option and use it across multiple bots without having to share the session by using the **Set session variable** action.

---

You can also close the session from the child bot when you are using the **Global session** option and sharing the session across child bots.

---

**Important:** If you close the session from the child bot and run the parent bot, then in the parent bot, the actions that come after the child bot are not run, and the bot fails with an error because the session has already been closed from the child bot.

---

- **Variable:** Specify a session variable that can be used to share that session with other child bots.

---

**Note:** When you use more than one workbook to automate an operation, you must use different session names for each workbook. If you want to use the same session name to automate all the workbooks, you must first close the session of one workbook before using the same session name for another workbook.

---

**10. Click Save.**

## Protect workbook action

The **Protect workbook** action of the Excel advanced package enables you to protect the workbook and its structure using a password.

### Settings

- (Optional) Select the **Protect workbook** check box.

Protecting a workbook prevents other users from accessing the content without a password.

Use the **Enter password** field to select one of the following options to specify the password you want to use to protect the workbook:

- **Credential:** To use a value available in the Credential Vault.  
Click the **Pick** button to select a credential.
- **Variable:** To use a value that is stored as a credential variable.
- **Insecure string:** To manually specify the values.

(Optional) Click the **Insert a value** icon to insert an existing variable.

- (Optional) Select the **Protect workbook structure** check box.

Protecting the structure of a workbook prevents other users from adding, moving, deleting, hiding, and renaming worksheets within that workbook.

Use the **Enter password** field to select one of the following options to specify the password you want to use to protect the workbook:

- **Credential:** To use a value available in the Credential Vault.  
Click the **Pick** button to select a credential.
- **Variable:** To use a value that is stored as a credential variable.
- **Insecure string:** To manually specify the values.

(Optional) Click the **Insert a value** icon to insert an existing variable.

- Use the **Session name** field to select one of the following options:

- **Session name:** Enter the name of the session used to open the workbook with the **Open ..**
- **Variable:** Enter the session variable that you have used in the **Set session variable** action or in the parent bot.

## Save workbook action

The Save workbook action of the Excel advanced package enables you to save the current workbook.

### Settings

Enter the name of the session used to open the current workbook with the **Open** action.

---

**Note:** When you open an Excel file from the Control Room and make changes to the file, the updated file is not saved in the Control Room. This action is supported only for Excel files opened from the desktop.

---

## Unprotect workbook action

The Unprotect workbook action of the Excel advanced package enables you to unprotect a workbook and its structure. Unprotecting a workbook removes the restriction applied on opening the workbook, and unprotecting the structure of a workbook removes the restriction applied on modifying the structure of the workbook. Unprotecting allows other users to open the workbook, add, move, delete, hide, and rename worksheets within the workbook.

### Settings

- Enter the name of the session used to open the workbook with the **Open** .
- Select the **Unprotect workbook** and **Unprotect workbook structure** check boxes and provide a password to unprotect the workbook structure.

## Worksheet operations in Excel advanced

The **Excel advanced** package contains various actions that you can use to automate worksheet-related tasks.

### Worksheet actions in the Excel advanced package

The **Excel advanced** package includes the following actions:

Action	Description
Access password protected worksheet	See <a href="#">Access password protected worksheet action</a> on page 2575
Append worksheet	See <a href="#">Using Append worksheet action</a> on page 2575.
Create worksheet	See <a href="#">Create worksheet action</a> on page 2576
Delete worksheet	See <a href="#">Delete worksheet action</a> on page 2576
Disable or enable real-time screen update	See <a href="#">Disable or enable real-time screen update action</a> on page 2576

Action	Description
Get current worksheet name	See <a href="#">Get current worksheet name action</a> on page 2577
Get worksheet as data table	See <a href="#">Get worksheet as data table action</a> on page 2577
Get worksheet names	See <a href="#">Get worksheet names action</a> on page 2578
Hide worksheet	See <a href="#">Hide worksheet action</a> on page 2578
Password protect worksheet	See <a href="#">Password protect worksheet action</a> on page 2578
Rename worksheet	See <a href="#">Rename worksheet action</a> on page 2579
Retrieve sheets count	See <a href="#">Retrieve sheets count action</a> on page 2579
Run macro	See <a href="#">Run macro action</a> on page 2580
Switch to sheet	See <a href="#">Switch to sheet action</a> on page 2580
Unhide all worksheets	See <a href="#">Unhide all worksheets action</a> on page 2581
Unhide worksheet	See <a href="#">Unhide worksheet action</a> on page 2581
Write from data table	See <a href="#">Write from data table action</a> on page 2581

## Access password protected worksheet action

The Access password protected worksheet action of the Excel advanced package enables you to access a password-protected worksheet in the current workbook.

### Settings

- Enter the name of the session used to open the workbook with the **Open** .
- Enter the password to access the worksheet.

## Using Append worksheet action

Use the **Append worksheet** action to append a worksheet from another workbook to the current workbook.

---

**Note:** If the current workbook already has a worksheet with the same name, you must rename the worksheet being appended.

---

To append a worksheet, do the following:

1. Double-click or drag the **Append worksheet** action from the **Excel** node in the **Actions** palette.
2. Select an option to specify the location of the spreadsheet from which you want to append the worksheet:
  - From 'My bots': Enables you to open a Microsoft Excel spreadsheet from an existing bot.
  - **From local device:** Enables you to open a Microsoft Excel spreadsheet from a local device.

- **Select an existing file variable:** Enables you to open a Microsoft Excel spreadsheet using a file variable.
3. Select the **Password is required** option if the Microsoft Excel spreadsheet requires a password to open it.
  4. Optional: In the **User password** or **Owner password** field, enter a password to restrict access to the encrypted PDF file.
    - **User password:** Allow users to perform specific operations on the encrypted PDF file.
    - **Owner password:** Allow users to use a password to open the file.
  5. Select the **Enter worksheet name** or **Enter worksheet index** option to specify the name or number of the worksheet that you want to append.
  6. Enter the name of the session used to open the workbook with the **Open** .
  7. Click **Save**.

### Create worksheet action

The Create worksheet action of the Excel advanced package enables you to create a worksheet in the current workbook.

#### Settings

- Enter the name of the session used to open the workbook with the **Open** .
- Specify either an index number in the **Sheet by Index** field or a name in the **Sheet by Name** field for the worksheet. The index number is the number assigned to a worksheet. For example, if you want to perform an operation on the worksheet at the third position in the workbook, enter 3 in the field.

### Delete worksheet action

The Delete worksheet action of the Excel advanced package enables you to delete a spreadsheet from the current workbook.

#### Settings

- Enter the name of the session used to open the workbook with the **Open** .
- Specify either an index number in the **Sheet by Index** field or a name in the **Sheet by Name** field for the worksheet. The index number is the number assigned to a worksheet. For example, if you want to perform an operation on the worksheet at the third position in the workbook, enter 3 in the field.

---

**Note:** You can delete a worksheet only if the workbook contains more than one worksheet.

---

### Disable or enable real-time screen update action

The Disable or enable real-time screen update action of the Excel advanced package enables you to disable the real-time screen update.



## Settings

- Select the **Disable** option to disable real-time screen update when you perform actions in a Microsoft Excel worksheet with large data sets.
- Select the **Enable** option to re-enable real-time screen update for other, subsequent actions.
- Enclose the action that has performance issues within the **Disable or enable real-time screen update** action.

For example, if you are using the **Run macro** action to run a macro on a worksheet that has large data sets and if you are facing performance issues, use the **Disable or enable real-time screen update** action before the **Run macro** action and select the **Disable** option to disable real-time screen update for enhanced performance. Use the **Disable or enable real-time screen update** action again after the **Run macro** action and select the **Enable** option to re-enable real-time screen update for other, subsequent actions.

---

**Important:** We recommend using this action only if you face performance issues when you run actions with large data sets.

---

## Get current worksheet name action

The Get current worksheet name action of the Excel advanced package enables you to get the name of the current worksheet and assign it to a string variable.

## Settings

- Enter the name of the session used to open the workbook with the **Open** .
- Select a string variable that you want to use to store the name of the worksheet from the **Assign the output to variable** list. The shows a descriptive default variable name. If you create several output variables, subsequent variable names are appended with a -1, -2, -3, and so on to avoid duplication.

## Get worksheet as data table action

The Get worksheet as data table action of the Excel advanced package enables you to get data from a worksheet and save it to a table variable.

## Settings

- Specify either an index number in the **Sheet by Index** field or a name in the **Sheet by Name** field for the worksheet. The index number is the number assigned to a worksheet. For example, if you want to perform an operation on the worksheet at the third position in the workbook, enter 3 in the field.
- Choose from the **Read** option to read either the visible text or value of the cell.

For example, if the cell has 70% as cell content, **Read cell value** option will read the value as 70 ignoring the % format whereas **Read visible text** option will read the content as 70%.

---

**Recommendation:** Use option **Read cell value** as reading value from a cell gives better performance than reading a visible text.

---

- Enter the name of the session used to open the workbook with the **Open** .
- Select a table variable that you want to use to store the data from the worksheet from the **Assign value to the variable** list. The shows a descriptive default variable name. If you create several output variables, subsequent variable names are appended with a -1, -2, -3, and so on to avoid duplication.

### Get worksheet names action

The Get worksheet names action of the Excel advanced package enables you to get the names of all the worksheets and assign them to a list variable of string data type.

#### Settings

- Enter the name of the session used to open the workbook with the **Open** .
- Select a string variable that you want to use to store the name of the worksheet from the **Assign the output to variable** list. The shows a descriptive default variable name. If you create several output variables, subsequent variable names are appended with a -1, -2, -3, and so on to avoid duplication.

### Hide worksheet action

The Hide worksheet action of the Excel advanced package enables you to hide a worksheet from the current workbook.

#### Settings

- Specify the name of the worksheet to hide in the **Enter worksheet name to hide** field.

---

**Note:** You can hide a worksheet only if the workbook contains more than one worksheet.

---

- Enter the name of the session used to open the workbook with the **Open** .

### Password protect worksheet action

The **Password protect worksheet** action of the Excel advanced package enables you to protect a worksheet with a password. You can also specify the operations to restrict on the worksheet.

#### Settings

- Double-click or drag the **Password protect worksheet** action from the Excel advanced package in the **Actions** palette.
- Use the **Password** field to select one of the following options to specify the password you want to use to protect the worksheet:
  - **Credential:** To use a value available in the Credential Vault.  
Click the **Pick** button to select a credential.
  - **Variable:** To use a value that is stored as a credential variable.

- **Insecure string**: To manually specify the values.  
(Optional) Click the **Insert a value** icon to insert an existing variable.

- (Optional) Select any of the check boxes for the operation that you want to restrict on the worksheet.

For example, select the **Delete row** and **Delete column** check boxes to restrict a user from deleting a row or column from the worksheet.

---

**Note:** The functionality of the **Edit objects** and **Edit scenarios** are different from the other options. When you select these options in the Excel advanced package, they are disabled in the Microsoft Excel. For more information, see [Worksheet Protect method](#).

---

- Use the **Session name** field to select one of the following options:
  - **Session name**: Enter the name of the session used to open the workbook with the **Open** .
  - **Variable**: Enter the session variable that you have used in the **Set session variable** action or in the parent bot.

## Rename worksheet action

The Rename worksheet action of the Excel advanced package enables you to rename a worksheet in the current workbook.

### Settings

- Specify the index number or name of the worksheet to rename in the **Sheet by Index** or **Sheet by Name** field.

The index number is the number assigned to a worksheet. For example, if you want to perform an operation on the worksheet at the third position in the workbook, enter 3 in the field.

---

**Note:** You cannot rename the worksheet if a worksheet with the same name already exists in the workbook.

---

- Enter the new worksheet name that is under 31 characters.
- Enter the name of the session used to open the workbook with the **Open** .

## Retrieve sheets count action

The Retrieve sheets count action of the Excel advanced package enables you to get the number of sheets available in the current workbook and store it in a number variable.

### Settings

- Select the appropriate option to specify whether to include the hidden worksheet or not and assign the count to a variable.
- Enter the name of the session used to open the workbook with the **Open** .
- Select a number variable that you want to use to store the name of the worksheet from the **Select the variable to assign to** list. The shows a descriptive default variable name. If you

create several output variables, subsequent variable names are appended with a -1, -2, -3, and so on to avoid duplication.

## Run macro action

The Run macro action in the Excel advanced package enables you to run macros in a worksheet.

### Settings

- Specify the name of the macro you want to run and its arguments.
- Enter the name of the session used to open the workbook with the **Open** .

---

#### Note:

- When you write a macro code, always end the code by adding `Exit Sub`.
- If you add `End` to terminate the macro, then on execution, the bot can fail with an error.
- Ensure that a macro code contains only one instance of the `End` or `End Sub` statement in the macro code to terminate the macro. If there is more than one instance of the statement, then on execution, the bot might fail with an error.

Example:

```
Public Sub main()  
MsgBox "Hello"  
MsgBox "Hello2"  
End Sub
```

---

## Switch to sheet action

The **Switch to sheet** action enables you to activate the specified worksheet from the selected Microsoft Excel file.

### Settings

- Double-click or drag the **Switch to sheet** action from the **Excel advanced** package in the **Actions** palette.
- Use the **Activate sheet by** field to select one of the following options:
  - **Index**: to specify the number of the worksheet from which you want to get the number of rows.  
Ensure that the number is not 0 as the worksheet numbers start from 1.
  - **Name**:: to specify the name of the worksheet from which you want to get the number or rows.
- Use the **Session name** field to select one of the following tabs:
  - **Session name**: Enter the name of the session used to open the workbook with the **Open** .
  - **Variable**: Enter the Excel advanced session variable that you have created.
- Click **Save**.

**Note:** The bot containing the **Switch to sheet** action switches to the hidden worksheet and performs operations on it. After the operations are completed, the worksheet remains hidden and is not activated.

---

## Unhide all worksheets action

The Unhides all worksheets action in the Excel advanced package unhides all the worksheets in the current workbook.

### Settings

Unhides all worksheets in the current workbook. Enter the name of the session used to open the current workbook with the **Open** action.

## Unhide worksheet action

The Unhide worksheet action in the Excel advanced package unhides a specific worksheet in the current workbook.

### Settings

- Enter the name of the worksheet you want to unhide.
- Enter the name of the session used to open the workbook with the **Open** .

## Write from data table action

The Write from data table action in the Excel advanced package enables you to write values from a data table into a worksheet.

### Settings

- Specify the data table variable that contains the data you want to write in a worksheet.
- Specify whether you want to write data in the currently **Active worksheet** or **Specific worksheet**.
- Specify the address of the cell that you want to use as the starting point of the data in the **Specify the first cell** field.
- Enter the name of the session used to open the workbook with the **Open** .

## Row and column operations in Excel advanced

The **Excel advanced** package contains various actions that you can use to automate tasks related to the row and column operations in a Microsoft Excel spreadsheet.

## Row and column actions in the Excel advanced package

The **Excel advanced** package includes the following actions:

Action	Description
Get column name	See <a href="#">Get column name action</a> on page 2582
Get row number	See <a href="#">Get row number action</a> on page 2582
Hide rows/columns in selection	See <a href="#">Hide rows/columns in selection action</a> on page 2583
Insert/Delete Rows/Columns	See <a href="#">Using Insert/Delete rows/columns action</a> on page 2583.
Read column	See <a href="#">Read column action</a> on page 2584
Read row	See <a href="#">Read row action</a> on page 2584
Remove blank rows	See <a href="#">Remove blank rows action</a> on page 2585
Select cell(s)/row(s)/column(s)	See <a href="#">Using Select action for cells, rows, and columns</a> on page 2585.
Unhides rows/columns in selection	See <a href="#">Unhides rows/columns in selection action</a> on page 2585

## Get column name action

The Get column name in the Excel advanced package enables you to retrieve the column name that contains the specific cell and stores it to a string variable. This action supports .xlsx and .xlsm files.

### Settings

- Select the **Active cell** or **Specific cell** option to specify the cell location.
- Enter the name of the session used to open the workbook with the **Open** .
- Select a string variable from the **Save the column name to variable** list. The shows a descriptive default variable name. If you create several output variables, subsequent variable names are appended with a -1, -2, -3, and so on to avoid duplication.

## Get row number action

The Get row number action in the Excel advanced package enables you to retrieve the row number that contains the specific cell and stores it to a string variable. This action supports .xlsx and .xlsm files.

### Settings

This action supports .xlsx and .xlsm files.

- Select the **Active cell** or **Specific cell** option to specify the cell location.
- Enter the name of the session used to open the workbook with the **Open** .
- Select a string variable from the **Save the row number to variable** list. The shows a descriptive default variable name. If you create several output variables, subsequent variable names are appended with a -1, -2, -3, and so on to avoid duplication.

## Hide rows/columns in selection action

The Hide row/columns in selection action in the Excel advanced package enables you to hide rows or columns in the current worksheet.

### Settings

- Select the appropriate option to specify whether to hide one or more rows and columns.
- Enter the name of the session used to open the workbook with the **Open** .

## Using Insert/Delete rows/columns action

Use the **Insert/Delete rows/columns** action to add or remove rows or columns from the current worksheet or CSV file.

To change the name or value of an **Active cell** or a **Specified cell** in a Microsoft Excel spreadsheet or a CSV file in a row or a column, see [Set cell](#).

To insert or delete rows or columns in a worksheet, do the following:

1. Double-click or drag the **Insert/Delete rows/columns** action from the **Excel advanced** node in the **Actions** palette.
2. Select one of the following options:

- **Row operations:** if you want to insert or delete rows from the spreadsheet.

Select one of the following options under **Row operations**:

- **Insert Row at:** to insert a row and specify the location where you want to insert the row in the field.
- **Delete Row(s) at:** to delete rows.

You must specify the row number you want to delete in the field. For example, if you want to delete the tenth row in the worksheet, you must enter 10 in the field. Similarly, if you want to delete the first five rows, you must enter 1 : 5 in the field.

- **Column operations:** if you want to insert or delete columns from the spreadsheet.

Select one of the following options under **Column operations**:

- **Insert Column at:** to insert a column and specify the location where you want to insert the column in the field.
- **Delete Column(s) at:** to delete columns.

You must specify the address of the column you want to delete in the field. For example, if you want to delete column 'D' in the worksheet, you must enter D in the field. Similarly, if you want to delete the first five columns, you must enter A : E in the field.

---

**Note:** You cannot insert multiple rows or columns in an Excel worksheet. Instead, you can loop this action any number of times in order to add multiple rows or column.

---

3. Use the **Session name** field to select one of the following tabs:
  - **Session name:** Enter the name of the session used to open the workbook with the **Open** .

- **Variable:** Enter the Excel advanced session variable from **Set session variable** action or from the parent bot.

4. Click **Save**.

## Read column action

The Read column action in the Excel advanced package enables you to extract data from a column and stores it in a list variable of string data type.

### Settings

- Select the **From active cell** or **From specific cell** option to specify the starting point. You can also select the **Read full column** option to extract data for the entire column.
- Choose from the **Read** option to read either the visible text or value of the cell.

For example, if the cell has 70% as cell content, **Read cell value** option will read the value as 70 ignoring the % format whereas **Read visible text** option will read the content as 70%.

---

**Recommendation:** Use the **Read cell value** option as reading value from a cell for better performance than reading visible text.

- Enter the name of the session used to open the workbook with the **Open** .
- Select a table variable to store the extracted values.

---

**Note:** This action overwrites any existing values in the selected table.

---

The shows a descriptive default variable name. If you create several output variables, subsequent variable names are appended with a -1, -2, -3, and so on to avoid duplication.

## Read row action

The Read row action in the Excel advanced package enables you to extract data from a row and stores it in a list variable of string data type.

### Settings

Extracts data from a row and stores it in a list variable of string data type.

- Select the **From active cell** or **From specific cell** option to specify the starting point. You can also select the **Read full row** option to extract data for the entire row.
- Choose from the **Read** option to read either the visible text or value of the cell.

For example, if the cell has 70% as cell content, **Read cell value** option will read the value as 70 ignoring the % format whereas **Read visible text** option will read the content as 70%.

---

**Recommendation:** Use option **Read cell value** as reading value from a cell gives better performance than reading a visible text.

- Enter the name of the session used to open the workbook with the **Open** .



- Select a list variable of string data type that you want to use to store the extracted values. The shows a descriptive default variable name. If you create several output variables, subsequent variable names are appended with a -1, -2, -3, and so on to avoid duplication.

## Remove blank rows action

The Remove blank rows action in the Excel advanced package enables you to remove blank rows from the current worksheet.

## Settings

You can specify the range from which you want to delete the blank rows.

## Using Select action for cells, rows, and columns

Use the **Select** action to select cells, rows, or columns.

To select cells, rows, or columns do the following:

1. Double-click or drag the **Select** cell, row, or column action from the **Excel** node in the **Actions** palette.
2. Select an option from the **Select** list to specify whether you want to select a cell, row, or column.
  - a) If you have selected the **Cell** option, select any of the following options:
    - **Active cell**: Enables you to select the active cell from the worksheet.
    - **Specific cell**: Enables you to select the cell you have specified in the field.
    - **Cell range**: Enables you to select all the cells in the range you have specified in the field.
    - **All cells in the sheet**: Enables you to select all the cells in the worksheet.
  - b) If you have selected the **Column** option, select any of the following options:
    - **Column of active cell**: Selects the column of the current active cell in the worksheet.
    - **Specific column**: Enables you to select the column you have specified in the field.
    - **Column range**: Enables you to select all the columns in the range you have specified in the field.
  - c) If you have selected the **Row** option, select any of the following options:
    - **Row of active cell**: Selects the row of the current active cell in the worksheet.
    - **Specific row**: Enables you to select the row you have specified in the field.
    - **Row range**: Enables you to select all the rows in the range you have specified in the field.
3. Enter the name of the session used to open the workbook with the **Open** .
4. Click **Save**.

## Unhides rows/columns in selection action

The Unhide rows/columns in selection action in Excel advanced package enables you to unhide the hidden rows or columns in the current worksheet.

## Settings

- Select the appropriate option to specify whether you want to unhide a row or column and which row or column to unhide.
- Enter the name of the session used to open the workbook with the **Open** .

## Cell operations in Excel advanced

The **Excel advanced** package contains various actions that you can use to automate tasks related to cell operations.

### Cell actions in the Excel advanced package

The **Excel advanced** package includes the following actions:

Action	Description
Delete cells	See <a href="#">Delete cells action</a> on page 2587
Find next empty cell	See <a href="#">Using Find next empty cell action</a> on page 2587.
Find	See <a href="#">Using Find action in Excel</a> on page 2587.
Get cell address	See <a href="#">Using the Get cell address action</a> on page 2588
Get cell color	See <a href="#">Using Get cell color action</a> on page 2590.
Get multiple cells	See <a href="#">Get multiple cells action</a> on page 2590
Get number of rows	See <a href="#">Using Get number of rows action</a> on page 2591.
Get single cell	See <a href="#">Get single cell action</a> on page 2592
Go to cell	See <a href="#">Go to cell action</a> on page 2592
Go to next empty cell	See <a href="#">Go to next empty cell action</a> on page 2593
Read cell formula	See <a href="#">Read cell formula action</a> on page 2593
Replace	See <a href="#">Using the Replace action</a> on page 2593.
Set cell	See <a href="#">Set cell action</a> on page 2594
Set cell formula	See <a href="#">Set cell formula action</a> on page 2594

## Delete cells action

The Delete cell action in the Excel advanced package enables you to delete the Active cell or a Specific cell from the current worksheet or a CSV file.

### Settings

---

**Note:** You can enter a cell range in the **Specific - cell** field using the `starting - cell:ending cell` format. For example, to perform this operation on all cells in the second row and from the first through third column, enter `A2:C2`.

---

After deleting the cell, you can:

- **Shift cells left:** Deletes the specified cell and shifts the cell one position to the left.
- **Shift cells up:** Deletes the specified cell and shifts the cell one position up.
- **Entire row:** Deletes the entire row that contains the cell you have specified to delete.
- **Entire column:** Deletes the entire column that contains the cell you have specified to delete.

## Using Find next empty cell action

Use the **Find next empty cell** action to find the next empty cell in the current worksheet.

To find the next empty cell, do the following:

1. Double-click or drag the **Find next empty cell** action from the **Excel** node in the **Actions** palette.
2. Select the **row** or **column** option from the **Traverse by** section to specify whether you want to find the empty cell in a row or column.
3. Select the **active cell** or **specific cell** option from the **Start from** section to specify the point from where you want to start the search.
4. Select the string variable you want to use to store the address of the empty cell from the **Assign the output to variable** list.  
The shows a descriptive default variable name. If you create several output variables, subsequent variable names are appended with a -1, -2, -3, and so on to avoid duplication.
5. Enter the name of the session used to open the workbook with the **Open**.
6. Click **Save**.

## Using Find action in Excel

Use the **Find** action to find a particular string in a Microsoft Excel spreadsheet or a CSV file.

Consider a scenario where you have a Microsoft Excel document titled `YTDSales.xls` that contains annual sales data. You want to find all the values from the `July` spreadsheet that are equal to 1500.

1. Double-click or drag the **Find** action from the **Excel** node in the **Actions** palette.
2. Click the **From** drop-down menu and select **Beginning**.
  - **Beginning:** Starts the search from the beginning of the spreadsheet.
  - **End:** Starts the search from the end of the spreadsheet.
  - **Active cell:** Starts the search from the active cell in the spreadsheet.

- **Specific cell:** Enables you to specify the address of the cell from where you want to start the search.
3. Click the **Till** drop-down menu and select **End**.  
Use the **Find** and **Till** menu to specify the start and end point of the cell range for search.
  4. In the **Find** field, enter **1500**.
  5. From the **Search options**, select **By rows**.  
The **By rows** option enables you to search the spreadsheet by rows, while the **By columns** enables you to search by columns.
  6. Select the **Match case** check box.
    - **Match case:** Only performs this action on cells that contain a string that matches the uppercase and lowercase characters of the string you specified in the **Find** field.
    - **Match entire cell contents:** Enables you to find only those cells that contain the entire string you have specified in the **Find** field.
  7. Enter the name of the session used to open the workbook with the **Open**.
  8. Optional: Click the **Assign cell addresses to variable** drop-down menu and select the list variable of string data type that you want to use to store the output from the list.
  9. Click **Save**.

A list of cell addresses that contain the value 1500 is displayed.

---

**Note:** An empty list is displayed if the specified value is not found.

---

## Using the Get cell address action

Use the Get cell address action to retrieve the location of the active cell and store it to a string variable. This action supports .xlsx and .xlsm files.

Open a worksheet using the **Open** action. You must select the **Contains header** option when configuring the **Open** action in order to use this action to retrieve the cell address based on the column title name.

1. Double-click or drag the **Get cell address** action from the Excel advanced node in the **Actions** palette.
2. Select whether to retrieve the cell address from the **Active cell** or **Based on header**:

Option	Steps
Active cell	If you select this option, the bot will retrieve the cell address of the currently active cell. Skip to Step 5.

Option	Steps
Based on header	<p>If you select this option, the bot will retrieve the cell address of the cell specified by the column title name and cell position. Complete the following fields:</p> <p><b>a) Enter the column title:</b> If you selected the <b>Sheet contains header</b> option when you opened this sheet using the <b>Open</b> action, enter the column name. For example, <code>First Name</code>.</p> <p>If you did not select that option, enter the default column name. For example, <code>A</code>.</p> <hr/> <p><b>Note:</b> This field is not case-sensitive.</p> <hr/> <p><b>b) Enter cell position from column title:</b> Enter the number of cells between the header cell and the cell from which you want to retrieve the address. Enter up to three digits.</p> <p>For example, if the header cell is located at B1 and you specify 2 as the cell position, the action will return B3.</p>

3. Select whether to retrieve the cell address from the **Active cell** or a **Specific cell**.
  - If you have selected the **Active cell** option, the bot will retrieve the cell address of the currently active cell. Skip to Step 5.
  - If you have selected the **Specific cell** option, the bot will retrieve the cell address of the cell specified by the column title name and cell position. Complete the following fields:
    - **Enter the column title:** Enter the column name. For example, `Name`.

---

**Note:** This field is not case-sensitive.

---

    - **Enter cell position from column title:** Enter the number of cells between the header cell and the cell from which you want to retrieve the address. Enter up to three digits.

For example, if the header cell is located at B1 and you specify 2 as the cell position, the action will return B3.
4. In the **Save active or user specified cell address in local variable** field, create or insert an existing string variable.

The shows a descriptive default variable name. If you create several output variables, subsequent variable names are appended with a -1, -2, -3, and so on to avoid duplication.
5. Enter the name of the session used to open the workbook with the **Open**.
6. Click **Save**.

Next, you can insert the string variable containing the cell address into the **Specific cell** field of actions related to cell operations. See [Cell operations in Excel advanced](#) on page 2586.

## Using Get cell color action

Use the **Get cell color** action to get the color of the background or text in a cell.

This action retrieves the color of a cell as RGB values. For example, if the background or text in a cell is of red color, the value retrieved is 255,0,0.

1. Double-click or drag the **Get cell color** action from the **Excel** node in the **Actions** palette.
2. Select the **Background color** option to get the background color of the cell or the **Text color** option to get the color of the text.
3. Select the **Active cell** option to get the color from the current active cell or the **Specific cell** option to get the color from the address of the cell you have specified.
4. Select a variable from the **Assign the output to variable** list to assign the address of the empty cell to the variable you have selected from the list.
5. Select the string variable you want to use to store the address of the empty cell from the **Assign the output to variable** list.  
The shows a descriptive default variable name. If you create several output variables, subsequent variable names are appended with a -1, -2, -3, and so on to avoid duplication.
6. Enter the name of the session used to open the workbook with the **Open** .
7. Click **Save**.

## Get multiple cells action

The **Get multiple cells** action in the Excel advanced package enables you to retrieve the values from the cells in a Microsoft Excel spreadsheet and store them in a table variable.

## Settings

This retrieves cell values as string data types. It supports Excel cell formats, including Number, Percentage, Currency, Scientific, and Date. For example, a value from a cell of Currency formatting retains the currency symbol when passed to a table or record variable.

---

**Note:** You must convert the values to perform non-string operations.

---

- Use the **Select range of cells to be returned** drop-down to select one of the following options:

- **All rows:** Select one of the following options under **Read options**:
  - **Read visible text in cell:** cell value is read as is.
  - **Read cell value:** formatting is ignored while reading the cell value.

For example, if the cell content is '70%', **Read visible text in cell** option will read the content as 70%, whereas the **Read cell value** option will read the value as 70 ignoring the '%' format.

---

**Recommendation:** Use the **Read cell value** option as the reading value for a better performance than reading visible text.

---

- **Specific rows:** Use the following fields to specify the rows:
  - **From row**

- **to row**
- **Cell range:** Use the following fields to specify the range for cells:
  - **From cell**
  - **To cell**
- Enter the name of the session used to open the workbook with the **Open** .
- Select a table variable to store the retrieved values in the **Assign value to variable** list. The shows a descriptive default variable name. If you create several output variables, subsequent variable names are appended with a -1, -2, -3, and so on to avoid duplication.

## Using Get number of rows action

Use the **Get number of rows** action to get the number of rows that contain data.

1. Double-click or drag the **Get number of rows** action from the **Excel advanced** package in the **Actions** palette.
2. Use the **Select worksheet by** field to select one of the following options:
  - **Index:** to specify the number of the worksheet from which you want to get the number of rows.  
Ensure that the number is not 0 as the worksheet numbers start from 1.
  - **Name:** to specify the name of the worksheet from which you want to get the number or rows.
3. Select one of the following options:
  - **Non-empty rows:** returns the total number of non-empty rows only.
  - **Total rows with data:** returns the total number of rows including empty cells.

Consider the following illustration of an Excel file for monthly sales target achieved:

	A	B
1	<b>Month</b>	<b>Target achieved</b>
2	May	75%
3	June	60%
4		
5	September	82%
6		
7	November	90%

- **Non-empty rows:** returns the value 5.  
The rows 1, 2, 3, 5 and 7 are not empty.
  - **Total rows with data:** returns the value 7.  
This includes empty and rows with data in the table.
4. Use the **Session name** field to select one of the following tabs:
    - **Session name:** Enter the name of the session used to open the workbook with the **Open** .
    - **Variable:** Enter the Excel advanced session variable that you have created.

5. Click the **Assign to variable** drop-down menu to select a variable that you want to assign the output value to.  
Click the **Create variable** icon if you have not created a variable.
6. Click **Save**.

## Get single cell action

The Get single cell action in the Excel advanced package enables you to retrieve the values from a single cell in a Microsoft Excel spreadsheet or a CSV file and store them in a string variable.

### Settings

This retrieves cell values as string data types. It supports Excel cell formats, including Number, Percentage, Currency, Scientific, and Date. For example, a value from a cell of Currency formatting retains the currency symbol when passed to a table or record variable.

---

**Note:** You must convert the values to perform non-string operations.

---

- Select the **Active cell** option to retrieve the value from the active cell, or select **Specific cell** to retrieve the value from a specific cell in a Microsoft Excel spreadsheet.
- Choose from the **Read** option to read either the visible text or value of the cell.  
For example, if the cell has 70% as cell content, **Read cell value** option will read the value as 70 ignoring the % format whereas **Read visible text** option will read the content as 70%.

---

**Recommendation:** Use the **Read cell value** option as the reading value from a cell for a better performance than reading visible text.

---

- Enter the name of the session used to open the workbook with the **Open** .
- Select a string variable to store the retrieved values in the **Store cell contents to** list. The shows a descriptive default variable name. If you create several output variables, subsequent variable names are appended with a -1, -2, -3, and so on to avoid duplication.

---

**Note:** If the character limit in a single cell of a Microsoft Excel spreadsheet exceeds 8200, then the bot reads only the first 8200 characters. This behaviour is specific only to Microsoft Excel spreadsheet.

---

[Example of using a conditional statement](#) on page 3208

## Go to cell action

The Go to cell action in the Excel advanced package enables you to move the cursor to a specific cell in a Microsoft Excel spreadsheet or a CSV file.

### Settings

- Select the **Specific cell** option to specify the cell to which the cursor should be moved, or select an option from the **Active cell** list.



**Note:** You can enter a cell range in the **Specific cell** field to select the entire range of cells. For example, to select all the cells in the second row and from the first through third column, enter `A2 : C2`.

---

- Enter the name of the session used to open the workbook with the **Open** .

## Go to next empty cell action

The Go to next empty cell action in the Excel advanced package enables you to find the next empty cell in the current worksheet. You can specify whether to find the empty cell toward the left, right, up, or down.

### Settings

- Select the **Active cell** or **Specified cell** option to specify the cell from which to start searching for the empty cell. If you have selected the **Specified cell** option, specify the address of the cell in the field.
- Select the **left**, **right**, **up**, or **down** option to specify the direction in which to search for the next empty cell.
- Enter the name of the session used to open the workbook with the **Open** .

## Read cell formula action

The Read cell formula action in the Excel advanced package enables you to retrieve the formula available in the **Active cell** or **Specified cell** and assign the output to a string variable. This action returns a blank value if the specified cell does not contain a formula.

### Settings

- Enter the name of the session used to open the workbook with the **Open** .
- Select the **Active cell** or **Specified cell** option to specify the cell from which to read the formula. If you have selected the **Specified cell** option, specify the address of the cell in the field.
- Select a string variable to store the name of the formula from the **Assign the output to variable** list. The shows a descriptive default variable name. If you create several output variables, subsequent variable names are appended with a -1, -2, -3, and so on to avoid duplication.

## Using the Replace action

Use the **Replace** action to find cells that contain a specific string and replace it with another string. This action supports .xlsx, .xlsm, and .csv files.

1. Double-click or drag the **Replace** action from the Excel advanced node in the **Actions** palette.
2. Click the **From** drop-down menu and select **Beginning**.
  - **Beginning:** Starts the search from the beginning of the spreadsheet.
  - **End:** Starts the search from the end of the spreadsheet.
  - **Active cell:** Starts the search from the active cell in the spreadsheet.

- **Specific cell:** Enables you to specify the address of the cell from where you want to start the search.
3. Click the **Till** drop-down menu and select **End**.  
Use the **Find** and **Till** menu to specify the start and end point of the cell range for search.
  4. In the **Find** field, enter **1500**.
  5. From the **Search options**, select **By rows**.  
The **By rows** option enables you to search the spreadsheet by rows, while the **By columns** enables you to search by columns.
  6. Select **Replace with** and specify the replacement string, or leave the field blank to replace the matching cells with an empty character.
  7. Enter the name of the session used to open the workbook with the **Open** .
  8. Click **Save**.

### Set cell action

The **Set cell** action enables you to set a value into an Active or Specific cell within a Microsoft Excel spreadsheet or a CSV file.

### Settings

- Double-click or drag the **Set cell** action from the **Excel advanced** package in the **Actions** palette.
- Use the **Cell option** field to select one of the following:
  - **Active cell:** to select a cell from the Excel sheet that you have specified in the **Session name** field.
  - **Specified cell:** to specify the address of the cell from the Excel sheet.

---

**Note:** You can enter a cell range in the **Specified cell** field to set a particular value. For example, to set a value of 5 in all cells in the second row and from the first through third column, enter **A2 : C2**.

---

- In the **Cell value** field, enter the value that you want to set.
- Enter the name of the session used to open the workbook with the **Open** .
- Click **Save**.

### Set cell formula action

The Set cell formula action in the Excel advanced package enables you to set a formula in the active cell or a specific cell in a Microsoft Excel spreadsheet or a CSV file.

To generate a random number, use the **Number > Random** action. See [Random action](#).

### Settings

- Select the **Set formula for active cell** or **Set formula for specified cell** option to specify the cell in which to set the formula. If you have selected the **Set formula for specified cell** option, specify the address of the cell in the field.

- Enter the formula to set in the **Enter formula for specific cell** field.
- Enter the name of the session used to open the workbook with the **Open** .

## Table operations in Excel advanced

The **Excel advanced** package contains various actions that you can use to automate tasks related to table operations in a Microsoft Excel spreadsheet.

### Table actions in the Excel advanced package

---

**Note:** Ensure that a table is available in the workbook. A worksheet that contains data in various rows and columns is not considered as a table.

---

The **Excel advanced** package includes the following actions:

Action	Description
Delete table column	See <a href="#">Delete table column action</a> on page 2595
Filter table	See <a href="#">Using Filter action</a> on page 2595.
Get table range	See <a href="#">Get table range action</a> on page 2597
Insert table column	See <a href="#">Insert table column action</a> on page 2597
Sort table	See <a href="#">Using Sort action</a> on page 2598

### Delete table column action

The Delete table column action in the Excel advanced package enables you to delete a column in a table.

### Settings

- Specify the **Table name** from which you want to delete a column.
- 

**Note:** The table name is a string value. It is NOT a data table name. For information on how to retrieve the Excel table name, see [Rename an Excel table](#).

---

- Select the **Name** or **Position** to specify the name or position of the column to delete.
- Enter the name of the session used to open the workbook with the **Open** .

### Using Filter action

Use the **Filter** action to filter data from a column in a specific table or worksheet.

1. Double-click or drag the **Filter** action from the **Excel** node in the **Actions** palette.
2. Click one of the following tabs:
  - **Table**
    - a) **Table name:** to specify the name of the table where you want to filter data.

**Note:** The table name is a string value and NOT a data table name. For information on how to retrieve the Excel table name, see .

---

**b)** Use the **Filter for** field to specify the column of the table where you want to filter the data:

- **Column name:** To specify the name of the column.
- **Column position:** To specify the position of the column.

For example, you have a table called `Monthly sales` that contains three columns: `April`, `May` and `June`. If you want to filter the data of the column `May` in the table, enter **May** in the **Column name** field or enter **2** in the **Column position** field.

- **Worksheet**

**a)** **Worksheet name:** to specify the name of the worksheet where you want to filter data.

**b)** Select the **Remove existing filter from the sheet** check box if you want to remove any existing filters in the specified worksheet.

**c)** Use the **Cell range** drop-down menu to specify one of the following cell ranges:

- **All cells:** to filter data across all the cells in the worksheet.
- **Specific:** enter the range for the cells in the **Range** field.

For example, you have a worksheet that contains five columns: A, B, C, D and E. If you want to filter data from the second to fourth column, enter `B2:D4` in the **Range** field.

**d)** Use the **Filter for** field to specify the column of the table where you want to filter the data:

- **Column name:** To specify the name of the column.
- **Column position:** To specify the position of the column.

**3.** Use the **Filter** field to select one of the following tabs:

- • **Number:** If the column you have specified contains number data.

Click the drop-down menu to select one of the following filters:

- **Equals:** Filters the data that is equal to the value you have specified.
- **Does not equal:** Filters the data that is not equal to the value you have specified.
- **Greater than:** Filters the data that is greater than the value you have specified.
- **Greater than or equal to:** Filters the data that is greater than or equal to the value you have specified.
- **Less than:** Filters the data that is less than the value you have specified.
- **Less than or equal to:** Filters the data that is less than or equal to the value you have specified.
- **Between:** Filters the data that is between the two values you have specified.

- **Text:** If the column you have specified contains textual data.

Click the drop-down menu to select one of the following filters:

- **Begins with:** Filters the data that begins with the value you have specified.
- **Ends with:** Filters the data that ends with the value you have specified.

- **Contains:** Filters the data that contains the value you have specified.
- **Does not contain:** Filters the data that does not contain the value you have specified.

From the `Monthly sales` table example mentioned above, consider a scenario where you want to only view data that is greater than the target number of 150 in the `May` column. So in `Step 3`, you select **Column name** and enter `May`. You can then use the **Number > Greater than** option and enter 150 in the field to filter the column values.

4. Enter the name of the session used to open the workbook with the **Open** .  
You can also click the **Variable** tab and select an existing Excel advanced session variable.
5. Click **Save**.

## Get table range action

The Get table range action in the Excel advanced package enables you to get the range of a table available in a worksheet and store the output in a string variable.

### Settings

- Specify the **Table name** for which you want to get the range.

---

**Note:** The table name is a string value and NOT a data table name. For information on how to retrieve the Excel table name, see .

- Select the options to specify whether you want to include a header and pivot table in the range and a variable to store the output. The shows a descriptive default variable name. If you create several output variables, subsequent variable names are appended with a `-1`, `-2`, `-3`, and so on to avoid duplication.
- Enter the name of the session used to open the workbook with the **Open** .

## Insert table column action

The Insert table column action in the Excel advanced package enables you to insert a column in a table.

### Settings

- Specify the **Table name** in which you want to insert a column.

---

**Note:** The table name is a string value and NOT a data table name. For information on how to retrieve the Excel table name, see .

- Specify the name of the column in the **Column name** field and the position where you want to insert the column in the **Column position** field.
- Enter the name of the session used to open the workbook with the **Open** .

## Using Sort action

The **Sort** action in the Excel advanced package enables you to sort numeric and text data within a specific column of a table or worksheet.

### Settings

---

**Important:** Ensure that Microsoft Excel is set to the same language as that of the computer operating system.

---

- Double-click or drag the **Sort** action from the **Excel** node in the **Actions** palette.
- Click one of the following tabs:

- **Table**

- Specify the **Table name** for which you want to sort the data.

---

**Note:** The table name is a string value and NOT a data table name. For information on how to retrieve the Excel table name, see .

---

- In **Sort for**, select one of the following options:

- **Column name:** Enter the column name or click the **Insert a value** icon to select an existing variable.
- **Column position:** Enter the column number or click the **Insert a value** icon to select an existing variable.

For example, you have a table called `Monthly sales` that contains three columns: `April`, `May` and `June`. If you want to sort the order of the column `May` in the table, enter `May` in the **Column name** field or enter `2` in the **Column position** field.

- **Worksheet**

1. **Worksheet name:** to specify the name of the worksheet where you want to sort data.
2. Use the **Sort for** field to specify the column of the table that you want to sort the data:
  - **Column name:** To specify the name of the column.
  - **Column position:** To specify the position of the column.

3. Use the **Cell range** field to enter the range of cells in the worksheet where you want to sort the data.

For example, you have a worksheet that contains three columns: `A`, `B`, and `C`. If you want to sort data in the second and third columns, enter `B2`, `C3` in the **Range** field.

4. Use the **Apply sort on** field to select one of the following options:
  - **All columns:** to sort data across all the columns in the worksheet.
  - **Only mentioned column:** to sort data for only the column mentioned in the **Column name** or **Column position** field above.
5. Clear the **Data has headers** check box if the specified columns in the worksheet does not have any headers.

- In **Sort order**, select one of the following options:
  - **Number**: Click the drop-down menu to select an ascending or descending sort order for the values in the column.
  - **Text**: Click the drop-down menu to sort the column values in an alphabetical order (A-Z or Z-A).

From the previous example, if the **May** column contains numerical values and you want to sort them in a descending order, select **Number > Largest to smallest** in the drop-down menu. However, if the values are alphabets or text, select **Text > Z-to-A**.
- Enter the name of the session used to open the workbook with the **Open** .  
You can also click the **Variable** tab and select an existing Excel advanced session variable.
- Click **Save**.

## CSV operations in Excel advanced

You can use some of the actions available in the **Excel advanced** package to perform various operations on a CSV file.

### CSV actions in the Excel advanced package

The following table lists the actions that you can use with a CSV file:

Supported	Not Supported
Open	Find next empty cell
Set cell	Get cell colour
Go to cell	Go to next empty cell
Insert/Delete row column	Run macro
Insert/Delete row column	Unhide all worksheets
Get cell	Hide row/column in selection
Find/Replace	Unhide row/column in selection
Convert excel to pdf	Access password protected worksheet
Delete cells	Protect/Unprotect workbook
Set cell formula	Table related commands
Create workbook	Create worksheet

You can use the **Loop** action to retrieve data from each row in a CSV file. You can also use any of the above action that supports the use of a CSV file within a **Loop** action.

**Note:** All the other actions available in the **Excel advanced** package that are not listed in the above table cannot be used with a CSV file.

## File package

Automate various file-related operations, such as creating, opening, copying, renaming, and deleting a file, by using the actions available in the `File` package.

You can use the actions in the `File` package either individually, to perform an action one time, or in a **Loop** action, to perform that action for each file available in a folder.

### Actions in the File package

**Note:** You can use the **Zip** action available in the `Folder` package to compress a file. See [Zip action](#) on page 2612.

The `File` package includes the following actions:

Action	Description
Assign	See <a href="#">Assign action</a> on page 2601
Copy Desktop file	See <a href="#">Using Copy Desktop file action for file</a> on page 2601.
Create	See <a href="#">Create action</a> on page 2603
Copy Control Room file	See <a href="#">Copy Control Room file action</a> on page 2605
Create shortcut	. See <a href="#">Create shortcut action</a> on page 2611
Create symbolic link	See <a href="#">Create symbolic link action</a> on page 2611
Delete	See <a href="#">Using Delete action for file</a> on page 2603.
Get name	See <a href="#">Get name action</a> on page 2605
Get path	See <a href="#">Get path action</a> on page 2606
Open	See <a href="#">Open action</a> on page 2607
Print	See <a href="#">Using Print action for file</a> on page 2607.
Print multiple files	See <a href="#">Using Print multiple files action</a> on page 2608.
Rename	See <a href="#">Using Rename action for file</a> on page 2609.

Related reference

[If package](#) on page 2724

Use the actions in the `If` package to control the sequence of execution based on one or more conditions of a task.

[Loop package](#) on page 2784



Use the Loop package to run a sequence of actions repeatedly for a specific number of times or until a specific condition is met.

[Variables overview](#) on page 2326

Automation 360 offers a variety of variables, each designed to hold specific types of data and is intended for specific use. Use the topics below to learn more about each variable and how to use them.

[File package updates](#) on page 882

Review the updates in released versions of the File package such as new and enhanced features as well as fixes and limitations. The page also lists the release dates of each version, and the compatible Control Room and Bot Agent versions.

## Assign action

The Assign action in the File package enables you to assign a file from the Control Room, Desktop, or an existing File variable to a user-defined File variable.

### Settings

Assigns a file from the Control Room, Desktop, or an existing File variable to a user-defined File variable.

Do the following steps to assign a file:

1. In the File variable or value to be assigned tab, select one of the following options to specify the location of your file:
  - **Control Room file:** Enables you to select the file that is available in a folder in the Control Room.
  - **Desktop file:** Enables you to select the file that is available on your device.
  - **Variable:** Enables you to specify the File variable that contains the location of the file.
2. Select one of the following options to specify the file path:
  - **Static file path:** Enables you to browse the Control Room repository or your device and select the file. Use this option when the file path is static.
  - **Dynamic file path:** Enables you to browse the Control Room repository or your device and select the file. In addition, it also enables you to insert variables in a file path to copy a file from the Control Room repository or your device where the file path is dynamic. You can insert a variable that holds the entire file path or part of the file path. For example, `Bots\FileBots\${csvName}`
3. In the **Assign the input to** field, select a File variable to save the output.

## Using Copy Desktop file action for file

Use the **Copy Desktop file** action to copy an existing file from Desktop to another location. This action enables you to copy a file based on its size and the date it was created or modified.

To copy an existing file, follow these steps:

1. In the Actions palette, from the File package, double-click or drag the **Copy Desktop file** action.

2. From the **Source file** field select one of the following options:

- **Specific:** Specify the name and location of the file.
- For **Regex:** Specify the source folder path.

You can use a regular expression (regex) in your source file or folder path to support a pattern-based search. Select the regular expression either as a **String** or **Pattern** for each regular expression condition and enter the value.

For example, if want to copy, delete, rename or print multiple files from your source folder using pattern based search, use regular expressions either as a **String** and enter the value as `My_` for all file name starting with `My_` or as a **Pattern** such as `[a-z]{3}(.txt|xlsx)` to retrieve files that matches this pattern.

3. In the **Destination file/folder** field, specify the name of the file and location.

4. Select the **Overwrite existing files** check box to overwrite an existing file with the same name at the specified location.

- If the **Overwrite existing files** option is not selected, the system appends the name of the copied file with a numeric value. For example, if you have copied a file named `June_Quarter_report.pdf` and a file with the same name exists in the location where you want to save the copied file, the system saves the copied file as `Copy of June_Quarter_report.pdf` for the first time. When you copy the same file in the same folder for the second time, it saves the copied file as `Copy (2) of June_Quarter_report.pdf`. The numeric value is incremented each time you copy a file with the same name when the overwrite check box is not selected.
- If you want to copy a file that is already available in the destination folder where the source and the destination folders are different and the **Overwrite existing files** check box is not selected, then the system shows the following error message: `Unable to copy file(s) <path\filename> as the specified file(s) exists.`

5. Select the **Copy multiple files at the same time to increase the copy speed** check box to copy large number of files simultaneously thus improving the speed of copy operation.

---

**Note:** If you already have existing automations to copy large files that is taking more time and have dependent automations that are tuned per the existing copy speed, then when you use the **Copy multiple files at the same time to increase the copy speed** option, ensure that you make specific adjustments to your bot code per the increased copy speed before you use the option.

---

6. Select the **Size** check box to copy a file based on its size.

a) Select any of the following options from the list:

- **Atleast:** Copies a file only if the file size is more than the size you have specified.
- **Atmost:** Copies a file only if the file size is less than the size you have specified.
- **Exact:** Copies a file only if the file size is the same as the size you have specified.

b) Specify a value in the **Size** field.

7. Select the **Date** check box to copy a file based on the date it was created or modified.

a) Select one of the options from the list:

- **Created:** Enables you to copy a file based on the date it was created.
- **Modified:** Enables you to copy a file based on the date it was modified.

- b)** Select the **Is within last** option and specify a value in the field.  
This option enables you to perform the operation on the file if it was created or modified within the number of days you have specified. For example, if you specify 7 in the field, the system performs the operation on the file if it was created or modified in the last 7 days.
- c)** Select the **Is between** option to specify a period.  
This option enables you to specify a **Start date** and an **End date** for the period. For example, if you specify 01/01/19 as the start date and 01/31/19 as the end date of the period, the system performs the operation on the file if it was created or modified between this period.
- 
- Note:** The **Start date** and **End date** are included in the period.
- 
- d)** Select the **Is before** option and specify a value in the field.  
This option enables you to perform the operation on the file if it was created or modified on or before the date you have specified.
- e)** Select the **On a date** option and specify a date in the field.  
This option enables you to perform the operation on a file if it was created or modified on the date that you specified.

- 8.** Click **Save**.

## Create action

The **Create** action in the File package enables you to create a new file.

---

**Note:** You can use the **Create** action to create only human readable files that contains raw data or text that is not formatted, and needs no specific software to read or open. For example, files with extensions such as `.txt`, `.log`, `.csv`, `.json`, `.xml`, `.html` and so on.

However, files that are system generated and require specific software for opening or reading the contents are not supported by **Create** action. For example, files with extensions such as `.png`, `.jpeg`, `.excel`, `.exe`, `.dll`, `.jar` and so on.

---

## Settings

- In the **File** field, enter filepath where you to store the file or click **Browse** to select it.
- In the **Overwrite an existing file** option, select an existing file with the same name to overwrite it. If existing files are not overwritten, the Control Room appends the name of the new file with a numeric value.

## Using Delete action for file

Use the **Delete** action to delete a file. This action enables you to delete a file based on its size and the date it was created or modified.

Follow these steps to delete a file:

1. In the **Actions** palette, double-click or drag the **Delete** action from the **File** package.
2. From the **Source file** field select one of the following options:
  - **Specific**: Specify the name and location of the file.
  - For **Regex**: Specify the source folder path.

You can use a regular expression (regex) in your source file or folder path to support a pattern-based search. Select the regular expression either as a **String** or **Pattern** for each regular expression condition and enter the value.

For example, if want to copy, delete, rename or print multiple files from your source folder using pattern based search, use regular expressions either as a **String** and enter the value as `My_` for all file name starting with `My_` or as a **Pattern** such as `[a-z]{3}(.txt|xlsx)` to retrieve files that matches this pattern.

---

**Note:**

- If the file does not exist in the file path, an error message is displayed.
- When you use this action to delete a file, it is deleted permanently and not moved to the recycle bin.

- 
3. Select the **Size** check box to delete a file based on its size.
    - a) Select any of the following options from the list:
      - **Atleast**: Deletes a file only if the file size is more than the size you have specified.
      - **Atmost**: Deletes a file only if the file size is less than the size you have specified.
      - **Exact**: Deletes a file only if the file size is the same as the size you have specified.
    - b) Specify a value in the **Size** field.
  4. Select the **Date** check box to delete a file based on the date it was created or modified.
    - a) Select one of the options from the list:
      - **Created**: Enables you to delete a file based on the date it was created.
      - **Modified**: Enables you to delete a file based on the date it was modified.
    - b) Use the second drop-down menu to select one of the following additional options:
      - **Relative to runtime**: select this option and specify a value in the field. This option enables you to perform the operation on the file if it was created or modified within the number of days you have specified. For example, if you specify 7 in the field, the system performs the operation on the file if it was created or modified in the last 7 days.
      - **Between two dates**: To specify the time period.

This option enables you to specify a **Start date** and an **End date** of the period. For example, if you specify 01/01/19 and 01/31/19 as the start date and end date, the system performs the operation on the file if it was created or modified between these dates.

---

**Note:** The **Start date** and **End date** are included in the period.

- 
- **On a date**: To specify a particular date.

This option enables you to set a specific date that a file was created or modified.

- **Before a date:** To specify a date prior to which the files were created.

For example, if you set the date as 07/28/20, files created or modified before this date are selected

**Optional:** Select the **Including date** check box if you want include the date you have specified for the **Before a date** option.

5. Click **Save**.

## Copy Control Room file action

The Copy Control Room file action in the File package enables you to copy a Control Room file to a specific location.

### Settings

- In the **Control Room file** field, specify the file to copy. Select one of the following options to copy a file from the Control Room repository:
  - **Static file path:** Enables you to browse the Control Room repository and select the file. Use this option when the file path is static.

---

**Note:** When you browse the Control Room repository using **Static file path**, files with the `.bot` extension are not displayed.

---

- **Dynamic file path:** Enables you to browse the Control Room repository and select the file. In addition, it also enables you to insert variables in a file path to copy a file from the Control Room repository where the file path is dynamic. You can insert a variable that holds the entire file path or part of the file path.

For example, `C:\user\My Docs\test.csv` or `C:\user\My Docs\${fileName}`

- In the **Target file path** field, specify the path to the location where you want to save the file. You can insert a variable that holds the entire file path or part of the file path.

For example, `C:\user\My Docs\test.csv` or `C:\user\My Docs\${fileName}`

---

**Note:** If the folder structure does not exist, the bot creates all the folders as needed.

---

- Select True or False, or insert a Boolean variable to specify whether to overwrite the existing file.

## Get name action

The Get name action in the File package enables you to get the name and the extension of the file.

### Settings

Do the following steps to retrieve the file name and extension:

1. In the **Source file** tab, select one of the following options to specify the location of your file:
  - **Control Room file**: Enables you to select the file that is available in a folder in the Control Room.
  - **Desktop file**: Enables you to select the file that is available on your device.
  - **Variable**: Enables you to specify the file variable that contains the location of the file.
2. In the **Save the outcome to a variable** field, select a string variable to save the output.

## Get path action

The Get path action in the File package enables you to retrieve the file path.

### Settings

Do the following steps to retrieve the file path:

1. In the **Source file** tab, select one of the following options to specify the location of your file:
  - **Control Room file**: Enables you to select the file that is available in a folder in the Control Room.
  - **Desktop file**: Enables you to select the file that is available on your device.
  - **Variable**: Enables you to specify the file variable that contains the location of the file.

---

**Note:** When you select the **Control Room file** option to retrieve the file path, the bot displays the local file path of the downloaded Control Room file.

---

**File: Get path**

Retrieves the path of a file.

Required bot agent version: 20.11 or above

**Source file**

Control Room file Desktop file Variable

C:\Temp\Data table\_input.csv (x) Browse...

**Save the outcome to a variable**

Filetest1 (x) +

2. In the **Save the outcome to a variable** field, select a string variable to save the output.

## Open action

The Open action in the File package enables you to open an existing file.

### Settings

In the **File** field, specify the name including the location to store the file.

You can use a regular expression (regex) or a pattern-based search to open an existing file that matches the search criteria. Select the regular expression either as a **String** or **Pattern** for each regular expression condition and enter the value.

## Using Print action for file

Use the **Print** action to print a file. This action enables you to print a file based on its size and the date it was created or modified.

Follow these steps to print a file:

1. In the Actions palette, double-click or drag the **Print** action from the File package.
2. In the **File** field, specify the name and location of the file.
3. Select the **Size** check box to print a file based on its size.
  - a) Select one of the options from the list:
    - **Atleast**: Prints a file only if the file size is more than the size you have specified.
    - **Atmost**: Prints a file only if the file size is less than the size you have specified.
    - **Exact**: Prints a file only if the file size is the same as the size you have specified.
  - b) Specify a value in the **Size** field.
4. Select the **Date** check box to print a file based on the date it was created or modified.
  - a) Select any of the following options from the list:
    - **Created**: Enables you to print a file based on the date it was created.
    - **Modified**: Enables you to print a file based on the date it was modified.
  - b) Select the **Is within last** option and specify a value in the field.

This option enables you to perform the operation on the file if it was created or modified within the number of days you have specified. For example, if you specify 7 in the field, the system performs the operation on the file if it was created or modified in the last 7 days.
  - c) Select the **Is between** option to specify a period.

This option enables you to specify a **Start date** and an **End date** for the period. For example, if you specify 01/01/19 as the start date and 01/31/19 as the end date of the period, the system performs the operation on the file if it was created or modified between this period.

---

**Note:** The **Start date** and **End date** are included in the period.

---
  - d) Select the **Is before** option and specify a value in the field.

This option enables you to perform the operation on the file if it was created or modified on or before the date you have specified.

- e) Select the **On a date** option and specify a date in the field.  
This option enables you to perform the operation on a file if it was created or modified on the date that you specified.

5. Click **Save**.

## Using Print multiple files action

Use **Print multiple files** to print multiple files based on the size and the date they were created or modified.

Follow these steps to print multiple files:

1. In the **Actions** palette, double-click or drag the **Print multiple files** action from the **File** package.
2. In the **Folder** field, specify the name and location of the folder.
3. From the **File type** field, select **String** to specify the file type of your files or **Regex**  
Use the regular expression in your source file or folder path to support pattern based search. Select the regular expression (Regex) either as a **String** or **Pattern** for each regex condition and input the regex value.

For example, you can use regular expressions either as a **String** and enter the value as `My_*` for all file name starting with `My_*` or as a **Pattern** such as `[a-z]{3} (.txt|xlsx)` to retrieve files that matches this pattern.

4. Select the **Include subfolders** check box to include all the subfolders in your selected folder.
5. Select the **Size** check box to print multiple files based on their size.
  - a) Select any of the following options from the list:
    - **Atleast**: Prints multiple files only if the file size is more than the size you have specified.
    - **Atmost**: Prints multiple files only if the file size is less than the size you have specified.
    - **Exact**: Prints multiple files only if the file size is the same as the size you have specified.
  - b) Specify a value in the **Size** field.
6. Select the **Date** check box to print multiple files based on the date they were created or modified.
  - a) Select one of the options from the list:
    - **Created**: Enables you to print multiple files based on the date they were created.
    - **Modified**: Enables you to print multiple files based on the date they were modified.
  - b) Select the **Is within last** option and specify a value in the field.  
This option enables you to perform the operation on the files if they were created or modified within the number of days you have specified. For example, if you specify 7 in the field, the system performs the operation on the files if they were created or modified in the last 7 days.
  - c) Select the **Is between** option to specify a period.  
This option enables you to specify a **Start date** and an **End date** for the period. For example, if you specify 01/01/19 as the start date and 01/31/19 as the end date of the



period, the system performs the operation on the files if they were created or modified between this period.

---

**Note:** The **Start date** and **End date** are included in the period.

---

- d) Select the **Is before** option and specify a value in the field.  
This option enables you to perform the operation on the files if they were created or modified on or before the date you have specified.
- e) Select the **On a date** option and specify a date in the field.  
This option enables you to perform the operation on a file if it was created or modified on the date that you specified.

7. Click **Save**.

## Using Rename action for file

Use the **Rename** action to rename a file. This action enables you to rename a file based on its size and the date it was created or modified.

To rename a file, follow these steps:

1. In the **Actions** palette, double-click or drag the **Rename** action from the **File** package.
2. From the **Source file** field select one of the following options:

- **Specific:** Specify the name and location of the file.
- For **Regex:** Specify the source folder path.

You can use a regular expression (regex) in your source file or folder path to support a pattern-based search. Select the regular expression either as a **String** or **Pattern** for each regular expression condition and enter the value.

For example, if want to copy, delete, rename or print multiple files from your source folder using pattern based search, use regular expressions either as a **String** and enter the value as `My_` for all file name starting with `My_` or as a **Pattern** such as `[a-z]{3}(.txt|xlsx)` to retrieve files that matches this pattern.

3. In the **New file name** field, specify a new name for the file.
4. Select the **Size** check box to rename a file based on its size.
  - a) Select one of the options from the list:
    - **Atleast:** Renames a file only if the file size is more than the size you have specified.
    - **Atmost:** Renames a file only if the file size is less than the size you have specified.
    - **Exact:** Renames a file only if the file size is the same as the size you have specified.
  - b) Specify a value in the **Size** field.
5. Select the **Date** check box to rename a file based on the date it was created or modified.
  - a) Select any of the following options from the list:
    - **Created:** Enables you to rename a file based on the date it was created.
    - **Modified:** Enables you to rename a file based on the date it was modified.
  - b) Select the **Is within last** option and specify a value in the field.

This option enables you to perform the operation on the file if it was created or modified within the number of days you have specified. For example, if you specify 7 in the field, the system performs the operation on the file if it was created or modified in the last 7 days.

- c) Select the **Is between** option to specify a period.

This option enables you to specify a **Start date** and an **End date** for the period. For example, if you specify 01/01/19 as the start date and 01/31/19 as the end date of the period, the system performs the operation on the file if it was created or modified between this period.

---

**Note:** The **Start date** and **End date** are included in the period.

---

- d) Select the **Is before** option and specify a value in the field.

This option enables you to perform the operation on the file if it was created or modified on or before the date you have specified.

- e) Select the **On a date** option and specify a date in the field.

This option enables you to perform the operation on a file if it was created or modified on the date that you specified.

6. Click **Save**.

## Example of using Rename action

In this example, you will build a bot to rename an existing file in a specified location. Use Regex expression to locate the specific file and rename it.

## Prerequisites

Before you start building the bot, create the following files and name them:

- Automation360.txt
- Automation360\_Old.txt
- Automation360-New.txt
- Datatable\_new.csv

## Procedure

1. Create a bot.
  - a) On the left panel, click **Automation**.  
A list of available bots and forms is displayed.
  - b) Click **Create a bot**.
  - c) Enter the bot name: `File_Rename`.
  - d) Click **Create and Edit**.
2. Rename the `Automation360-New.txt` file.

- a) From the **File** > **Regex** option, in the **Folder path** field, enter `C:\Temp\`
- b) In the **File name** field, select **Type** as **Pattern**.
- c) In the **Value** field, enter `([A-Za-z0-9]*)-\w+(\.txt|\.csv)` to search for the file.
- d) In the **New file name** field, enter `Automation360-latest.txt`
- e) Select the **Date** option.
- f) From the **Date** option, select **Created** > **On a date**.
- g) In the **Date** field, enter `11/03/2023`.

---

**Note:** Enter the date on which you created the file.

---

3. Click **Save** and then **Run**.

The bot renames the `Automation360-New.txt` file to `Automation360-latest.txt`.

## Create shortcut action

The Create shortcut action in the File package enables you to create a shortcut to a target file.

### Settings

Creates a shortcut to a file at a user-specified location. The shortcut is dependent on the source file, so any changes you make to the source file will also apply to the shortcut.

- In the **Target location** field, specify the name and location.
- In the **Shortcut location** field, specify the name and location.

---

**Note:** Users with a valid role and required permission can create a shortcut to a file at a specified location.

---

## Create symbolic link action

The Create a symbolic link action in the File package enables you to create a symbolic link to a target file.

### Settings

Creates a symbolic link to a file at a user-specified location. The shortcut is dependent on the source file, so any changes you make to the source file will also apply to the shortcut.

- In the **Target location** field, specify the name and location.
- In the **Symbolic link location** field, specify the name and location.

---

**Note:** Users with only admin access can create a shortcut to a file at a specified location.

---

## Folder package

Automate folder-related operations by using the actions available in the `Folder` package.

### Actions in the Folder package

The `Folder` package includes the following actions:

Action	Description
Zip	See <a href="#">Zip action</a> on page 2612.
Copy	See <a href="#">Copy action in Folder</a> on page 2613.
Create	See <a href="#">.Create action in Folder</a> on page 2614.
Unzip	See <a href="#">Unzip action</a> on page 2614.
Delete	See <a href="#">Delete action in Folder</a> on page 2615.
Create shortcut	See <a href="#">Create shortcut action</a> on page 2616.
Open	See <a href="#">Open action in Folder</a> on page 2616.
Rename	See <a href="#">Rename action in Folder</a> on page 2616.
Create symbolic link	See <a href="#">Create symbolic link action</a> on page 2618.

Related reference

[Folder package updates](#) on page 884

Review the updates in released versions of the `Folder` package such as new and enhanced features as well as fixes and limitations. The page also lists the release dates of each version, and the compatible Control Room and Bot Agent versions.

### Zip action

The **Zip** action enables you to compress files and folders into a `.zip` format.

1. In the `Actions` palette, double-click or drag the **Zip** action from the **Folder** package.
2. In the **Specify file(s)/folder(s) to compress** field, specify the location.
3. In the **Specify file type(s) to compress** field, select one of the following options:

- **String**: Specify the file extension.

For example, you can specify `.txt` and `.png` to compress only text files and PNG images. The system compresses the entire folder if you do not specify any file type. You can also specify the name of a file to compress a specific file.

- **Regex**: Select the regular expression (regex) either as a **String** or **Pattern** for each regular expression condition and enter the value.

For example, you can use regular expressions either as a **String** and enter the value as `My_` for all file name starting with `My_` or as a **Pattern** such as `[a-z]{3}(.txt|xlsx)` to retrieve files that matches this pattern.

4. In the **Specify destination filename and location** field, specify the zip file name and location.

5. Select the **Update only if newer** check box to compress the files only if one or more files were updated after the last compression.  
This option is useful when you are repeatedly compressing the same set of files and storing the output zip file with the same name at the same location. For example, you compress five PDF files from the `Reports` folder on a monthly basis and save the output zip file with the `Monthly Report` name in the `D:` drive. When this option is selected, the system compresses the files only if one or more PDF files are updated after the last compression.
6. Select the **Delete original files** check box if you want to delete the original files after they are included in the zip file.
7. In the **Compression** list, select between **Normal**, **Fast**, and **Superfast** to specify the speed for compression.
8. Optional: In the **Password protection** field, click one of the following tabs to set a password:
  - **Credential**: To specify a stored password.
  - **Variable**: To set a variable for password.
  - **String**: To enter a password manually.
9. Click **Save**.

## Copy action in Folder

The **Copy** action enables you to copy an existing folder into a specific location.

1. In the **Actions** palette, double-click or drag the **Copy** action from the **Folder** package.
2. In the **Source folder** field, specify the name and location.
3. In the **Destination folder** field, specify the folder name and location to save the copied folder.
4. Select the **Overwrite existing files/folders** check box to overwrite existing folders with the same name.

If this option is not enabled, the system appends a numeric value at the end of the file name. For example, if you save the `June_Quarter_report` file in a location that has a file with the same name, the system saves the file as `June_Quarter_report_(1).pdf`. The numeric value is incremented each time you save the file as long as the option is enabled.

5. Optional: Select the **Size** check box to copy a folder based on its size.
  - a) Use the drop-down menu to select one of the following options:
    - **Atleast**: Copies a folder only if the folder size is more than the size you have specified.
    - **Atmost**: Copies a folder only if the folder size is less than the size you have specified.
    - **Exact**: Copies a folder only if the folder size is the same as the size you have specified.
  - b) In the **Size (KB)** field, specify the folder size.
6. Optional: Select the **Date** check box to copy a folder based on the date.
  - a) Use the drop-down menu to select one of the following options:
    - **Created**: To copy a folder based on the date it was created.
    - **Modified**: To copy a folder based on the date it was modified.
  - b) Use the second drop-down menu to select one of the following additional options:
    - **Relative to runtime**: To set the date in regards to the bot runtime.
    - **Between two dates**: To specify the time period.

This option enables you to specify a **Start date** and an **End date** of the period. For example, if you specify 01/01/19 and 01/31/19 as the start date and end date, the system performs the operation on the folder if it was created or modified between these dates.

---

**Note:** The **Start date** and **End date** are included in the period.

---

- **On a date:** To specify a particular date.

This option enables you to set a specific date that a folders was created or modified.

- **Before a date:** To specify a date prior to which the folders were created.

For example, if you set the date as 07/28/20, folders created or modified before this date are selected

(Optional) Select the **Including date** check box if you want include the date you have specified for the **Before a date** option.

7. Click **Save**.

## Create action in Folder

The **Create** action enables you to create a folder.

### Settings

- In the **Folder** field, specify the name and location.

Folder names cannot include system actions or device references such as **AUX**, **CON**, **LPT**, **NUL**, and **PRN**.

- (Optional) Select the **Overwrite an existing folder** check box to overwrite an existing folder.

---

**Note:** If this option is not selected, the system appends the name of the new folder with a numeric value.

---

## Unzip action

The **Unzip** action enables you to extract compressed content (files and folders) into a specific location from a **.zip** file.

1. In the **Actions** palette, double-click or drag the **Unzip** action from the **Folder** package.
2. In the **Zip file name with full path** field, specify the name and location.
3. In the **Extract to path** field, specify the location.
4. Select the **Replace existing file** check box to overwrite the file.
5. Optional: In the **Password to access zip file** field, click one of the following tabs to set a password:
  - **Credential:** To specify a stored password.
  - **Variable:** To set a variable for password.
  - **String:** To enter a password manually.

6. Click **Save**.

## Delete action in Folder

The **Delete** action enables you to remove or delete folder from specific location.

1. In the **Actions** palette, double-click or drag the **Delete** action from the **Folder** package.
2. In the **Folder** field, specify the name and location.
3. Optional: Select the **Size** check box to delete a folder based on its size.
  - a) Use the drop-down menu to select of the following options:
    - **Atleast**: Deletes a folder only if the folder size is more than the size you have specified.
    - **Atmost**: Deletes a folder only if the folder size is less than the size you have specified.
    - **Exact**: Deletes a folder only if the folder size is the same as the size you have specified.
  - b) In the **Size** field, specify the folder size.
4. Optional: Select the **Date** check box to delete a folder based on the date it was created or modified.
  - a) Use the drop-down menu to select one of the following options:
    - **Created**: To delete a folder based on the date it was created.
    - **Modified**: To delete a folder based on the date it was modified.
  - b) Use the second drop-down menu to select one of the following additional options:
    - **Relative to runtime**: select this option and specify a value in the field. This option enables you to perform the operation on the file if it was created or modified within the number of days you have specified. For example, if you specify 7 in the field, the system performs the operation on the file if it was created or modified in the last 7 days.
    - **Between two dates**: To specify the time period.

This option enables you to specify a **Start date** and an **End date** of the period. For example, if you specify 01/01/19 and 01/31/19 as the start date and end date, the system performs the operation on the folder if it was created or modified between these dates.

---

**Note:** The **Start date** and **End date** are included in the period.

---

- **On a date**: To specify a particular date.

This option enables you to set a specific date that a folders was created or modified.

- **Before a date**: To specify a date prior to which the folders were created.

For example, if you set the date as 07/28/20, folders created or modified before this date are selected

(Optional) Select the **Including date** check box if you want include the date you have specified for the **Before a date** option.

5. Click **Save**.

## Create shortcut action

The **Create shortcut** action enables you to create a shortcut of a folder at a specified location. As the folder shortcut is dependent on the source folder, any changes to the source folder is applied to the shortcut as well.

### Settings

- Use the **Target location** field to select one of the following tabs:
  - **Desktop folder**: Click **Browse** to select the folder that you want to create a shortcut for.
  - **Variable**: Enter or paste the filepath of the folder that you want to create a shortcut for.
- Use the **Shortcut location** field to select one of the following tabs:
  - **Desktop folder**: Click **Browse** to select the folder where the folder shortcut must be created.
  - **Variable**: Enter the filepath where the folder shortcut must be created.

---

**Note:** Only the users with administrator role can create a shortcut of the source folder at a specified location.

---

## Open action in Folder

The **Open** action enables you to open a folder from a specific location.

### Settings

1. In the **Folder** field, specify the file path of the folder you want to open. For example, `C:\Temp`
2. Alternatively, you can click the **Insert a value** icon to select a variable or a global value.
3. If the specific variable is not available, then create a variable. See the following example of a variable:
  - a) Create a variable named `$FolderPath$`.
  - b) In the **Default value** field, enter `C:\Temp`.

To know more about global values, see [Global values](#) on page 2350.

To create a variable, see [Create a variable](#) on page 2336.

## Rename action in Folder

The **Rename** action enables you to rename an existing folder.

1. In the **Actions** palette, double-click or drag the **Rename** action from the **Folder** package.



2. In the **Folder** field, specify the name and location.
3. In the **New folder name** field, specify a new name.
4. Select the **Size** check box to rename a folder based on its size.
  - a) Select any of the following options from the list:
    - **Atleast**: Renames a folder only if the folder size is more than the size you have specified.
    - **Atmost**: Renames a folder only if the folder size is less than the size you have specified.
    - **Exact**: Renames a folder only if the folder size is the same as the size you have specified.
  - b) In the **Size** field, specify the folder size.
5. Select the **Date** check box to rename a folder based on the date it was created or modified.
  - a) Select any of the following options from the list:
    - **Created**: To rename a folder based on the date it was created.
    - **Modified**: To rename a folder based on the date it was modified.
  - b) Use the second drop-down menu to select one of the following additional options:
    - **Relative to runtime**: To set the date in regards to the bot runtime.
    - **Between two dates**: To specify the time period.

This option enables you to specify a **Start date** and an **End date** of the period. For example, if you specify 01/01/19 and 01/31/19 as the start date and end date, the system performs the operation on the folder if it was created or modified between these dates.

---

**Note:** The **Start date** and **End date** are included in the period.

---

    - **On a date**: To specify a particular date.

This option enables you to set a specific date that a folders was created or modified.
    - **Before a date**: To specify a date prior to which the folders were created.

For example, if you set the date as 07/28/20, folders created or modified before this date are selected

(Optional) Select the **Including date** check box if you want include the date you have specified for the **Before a date** option.
6. Click **Save**.

## Create symbolic link action

The **Create symbolic link** action enables you to create a symbolic link to a folder at a specified location. As this link is dependent on the source folder, any changes you make to the source folder is applied to the symbolic link.

### Settings

---

**Note:** This action only works when the automation is run with elevated privileges by enabling the **Run with administrative privileges** option. For more information, see [Run a bot in elevated mode](#) on page 2285.

---

- Use the **Target location** field to select one of the following tabs:
  - **Desktop folder:** Click **Browse** to select the folder that you want to create a shortcut for.
  - **Variable:** Enter or paste the filepath of the folder that you want to create a shortcut for.
- Use the **Symbolic link location** field to select one of the following tabs:
  - **Desktop folder:** Click **Browse** to select the folder where the folder shortcut must be created.
  - **Variable:** Enter the filepath where the folder shortcut must be created.

## FTP / SFTP package

Use the FTP / SFTP package to automate FTP / SFTP operations.

An FTP/SFTP server hosts the files to share. The client accesses, downloads, or uploads files to the server. The transfer of data between the client and server is done using a TCP/IP network, which is the standard protocol of communication over the internet.

- The following are some forms of authentication for an FTP server:
  - User credentials: Requires an FTP username and password.
  - Anonymous: This form of authentication is enabled on sites where files are available for public access and the users need not identify themselves to the server.
  - Key-based: SFTP authentication is usually done with a private and public key. The key pair is automatically generated by the computer. The private key is kept with the SFTP client and the corresponding public key with the SFTP server. When establishing a connection, the client shares the private key to be matched with the corresponding public key on the server.
- FTP can run in active or passive transfer mode.
  - In the active mode, the client informs the server about the port used for listening and starts listening for incoming data connections from the server.
  - In the passive mode, the client receives a server IP address and server port number from the server. The client opens a data connection to the server IP address and server port number that are received. Most organizations prefer the passive mode because it involves less or no alterations to the firewall settings.
- FTP supports binary and ASCII file transfer types:
  - Use the binary option when transferring executable files.

- Use the ASCII option when transferring text files.

## Before you start

Perform the following actions within the FTP / SFTP package.

1. Establish a connection with the FTP/SFTP server using the **Connect** action. When establishing a connection, associate the FTP/SFTP server details with a session name. Use the same session name for all corresponding actions.
2. Use the FTP/SFTP actions to automate a task. The actions enable you to perform following tasks:
  - Upload, download, delete, or rename files.
  - Upload, download, create, or delete folders.
  - Navigate to the parent folder or a specific folder.
3. After you have automated the tasks related to FTP / SFTP, terminate the connection to the server using the **Disconnect** action.

---

**Note:** SFTP with SSH1 protocol is no longer supported by SFTP.

---

View how to use FTP/SFTP connect action in the following video:

## Actions in the FTP / SFTP package

The FTP / SFTP package includes the following actions:

---

**Note:** Regarding the use of a semicolon (;) in folder or file names, the following guidelines apply:

- You can use a semicolon (;) in the folder name for the following actions: **Delete** or **Create** folder
- You must not use a semicolon (;) in the folder or file name for other actions, such as the following: **Change folder**, **Delete files**, **Get files**, **Get folder**, **Put files**, **Put folders**, and **Rename files**

---

Action	Description
Change folder	See <a href="#">Change folder action</a> on page 2620.
Connect	See <a href="#">Connect action</a> on page 2620.
Create folder	See <a href="#">Create folder action</a> on page 2622.
Delete folder	See <a href="#">Delete folder action</a> on page 2622.
Delete files	See <a href="#">Delete files action</a> on page 2623.
Disconnect	See <a href="#">Disconnect action</a> on page 2623.
Get folders	See <a href="#">Get folders action</a> on page 2623.

Action	Description
Get files	See <a href="#">Get files action</a> on page 2624.
Put folders	See <a href="#">Put folders action</a> on page 2624.
Put files	See <a href="#">Put files action</a> on page 2625.
Rename files	See <a href="#">Rename files action</a> on page 2625.

Related reference

[FTP/SFTP package updates](#) on page 886

Review the updates in released versions of the FTP / SFTP package such as new and enhanced features as well as fixes and limitations. The page also lists the release dates of each version, and the compatible Control Room and Bot Agent versions.

## Change folder action

The **Change folder** action enables you to navigate to either a parent folder or a specific folder on an FTP/SFTP server.

### Settings

- In the **Session name** field, enter the session name for FTP/SFTP server.  
Use the same session name that you have provided when establishing a connection with the FTP/SFTP server using the **Connect** action.
- Use the **Navigate to** field to select one of the following options:
  - **Go to parent folder**
  - **Specific folder**

Ensure that you enter the complete folder path when you select the **Specific folder** option.

## Connect action

The **Connect** action enables you to establish a connection with an FTP/SFTP server that you want to use for automating tasks. This must be the first action you use to automate an FTP/SFTP-related task.

Specify details of the FTP/SFTP server and associate it with a session name. Use the session name provided in this action in the other actions so that you do not have to provide details of the server in those actions.

1. Double-click or drag the **Connect** action in the **FTP/SFTP** node in the **Actions** palette.
2. In the **Server name** field, enter the FTP/SFTP server name.
3. In the **Port** field, enter the FTP/SFTP server port number.
4. Use the **Server type** field to select one of the following server type:

Server type	Steps
FTP	<p><b>Authentication type:</b> You can choose to authenticate by either using <b>Username &amp; password</b> or logging in as <b>Anonymous</b>. If you choose <b>Username &amp; password</b>, complete the following fields:</p> <ul style="list-style-type: none"> <li>In <b>Username &amp; password</b>, select <b>Credential, variable,</b> or <b>Insecure string</b>.</li> <li>Enter values in the <b>Username</b> and <b>Password</b> fields.</li> </ul> <p>If you choose to authenticate using the user credentials (username and password), insert a Credential Vault for enhanced security or enter the value directly in the <b>Insecure string</b> field.</p> <p><b>Transfer Mode:</b> Select the transfer mode to be <b>Active</b> or <b>Passive</b>.</p> <p><b>Transfer type:</b> Select the type to be either <b>Binary</b> or <b>ASCII</b> for transferring files between server and client.</p> <p>Optional: Enter the default directory path on the FTP server.</p>
FTP Secure	<p><b>Authentication type:</b> You can choose to authenticate by either using <b>Username &amp; password</b> or logging in as <b>Anonymous</b>. If you choose <b>Username &amp; password</b>, complete the following fields:</p> <ul style="list-style-type: none"> <li>In <b>Username &amp; password</b>, select <b>Credential, variable,</b> or <b>Insecure string</b>.</li> <li>Enter values in the <b>Username</b> and <b>Password</b> fields.</li> </ul> <p>If you choose to authenticate using the user credentials (username and password), insert a Credential Vault for enhanced security or enter the value directly in the <b>Insecure string</b> field.</p>
Secure FTP	<p>Choose <b>Key and username, Key and credentials,</b> or <b>Credentials</b> to authenticate the user:</p> <ul style="list-style-type: none"> <li><b>Key and username:</b> Select the <b>Private Key File</b> from <b>Control Room file, Desktop file,</b> or <b>Variable</b>. To enter the <b>Username</b>, select from the following options: <b>Credential, variable,</b> , and <b>Insecure string</b>.</li> <li><b>Key and credentials:</b> Select the <b>Private Key File</b> from <b>Control Room file, Desktop file,</b> or <b>Variable</b>. To enter the <b>Username</b>, select from the following options: <b>Credential, variable,</b> , and <b>Insecure string</b>.</li> </ul> <hr/> <ul style="list-style-type: none"> <li><b>Note:</b> Ensure that the SFTP server has a corresponding public key file.</li> </ul> <hr/> <ul style="list-style-type: none"> <li><b>Credentials:</b> Select <b>Credential , Variable,</b> or <b>Insecure string</b> to enter the value in the <b>Username</b> and <b>Password</b> fields.</li> </ul> <p>If you choose to authenticate using the user credentials (username and password), insert a Credential Vault for enhanced security or enter the value directly in the <b>Insecure string</b> field.</p>

- Optional: Select **Reconnect if connection fails** check box.  
Use the following drop-down menus to select additional options while reconnecting:

- a) **Attempts:** Select the number of times the action must attempt to reconnect.
- b) **Time between attempts:** Select the time lapse between each attempt.

---

**Note:** If the connection fails due to incorrect credentials, the action will not attempt to reconnect.

---

6. Select any of the following tabs to create an FTP/SFTP session:
  - **Local session:** Specify a session name that can be used only in the current bot.
  - **Global session:** Specify a session name that can be used across multiple bots, such as parent bots and child bots.
  - **Variable:** Specify or create a session variable of subtype FTP/SFTP session.
7. Click **Save**.

## Create folder action

The **Create folder** action enables you to create a folder on an FTP/SFTP server.

### Settings

- In the **Session name** field, enter the session name for FTP/SFTP server.  
Use the same session name that you have provided when establishing a connection with the FTP/SFTP server using the **Connect** action.
- Use the **Remote folder** field to specify the filepath where the folder must be created on the FTP/SFTP server.

---

**Note:** The system encounters an error if a folder with the same name exists in the parent folder.

---

## Delete folder action

The **Delete folder** action enables you to remove or delete a folder (including all the subfolders and files within it) from an FTP/SFTP server.

### Settings

- In the **Session name** field, enter the session name for FTP/SFTP server.  
Use the same session name that you have provided when establishing a connection with the FTP/SFTP server using the **Connect** action.
- Use the **Remote folder** field to specify the filepath of the folder that must be deleted from the FTP/SFTP server.

## Delete files action

The Delete files action enables you to remove or delete files from an FTP/SFTP server.

### Settings

- In the **Session name** field, enter the session name for FTP/SFTP server.  
Use the same session name that you have provided when establishing a connection with the FTP/SFTP server using the **Connect** action.
- Use the **Remote files** field to specify the filepath of the file(s) that must be deleted from the FTP/SFTP server.

## Disconnect action

The **Disconnect** action enables you to close or terminate an active connection to the FTP/SFTP server.

### Settings

Select any of the following tabs to create an FTP/SFTP session:

- **Session name:** Enter or select a local or global session name variable.
- **Variable:** Enter or create a session variable of subtype FTP/SFTP session.

Use the same session name that you have provided when establishing a connection with the FTP/SFTP server using the **Connect** action.

## Get folders action

The **Get folders** action enables you to download a folder on an FTP/SFTP server into a client machine.

### Settings

- In the **Session name** field, enter the session name for FTP/SFTP server.  
Use the same session name that you have provided when establishing a connection with the FTP/SFTP server using the **Connect** action.
- Use the **Remote folder** field to enter the filepath of the folders on the remote FTP/SFTP server that you want to download.  
Specify filters using wildcard characters to download only specific types of files.
- Use the **Local folder** field to enter the location on your local device where you want to download the folders from the FTP/SFTP server.
- (Optional) Click the **Select date** drop-down menu to specify folders based on the date they were modified or created.

## Get files action

The **Get files** action enables you to download files from a remote FTP/SFTP folder to a specific location on a client machine.

---

**Note:** When you use this action, it only downloads the files without removing them from the server.

---

### Settings

- In the **Session name** field, enter the session name for FTP/SFTP server.  
Use the same session name that you have provided when establishing a connection with the FTP/SFTP server using the **Connect** action.
- Use the **Remote files** field to enter the filepath of the files on the remote FTP/SFTP server that you want to download.  
Specify filters using wildcard characters to download only specific types of files.
- Use the **Local folder** field to enter the location of the client machine where you want to download the files from the FTP/SFTP server.
- Use the **Transfer Type** to select one of the following formats of the download files:
  - **Binary**
  - **ASCII**
- (Optional) Use the **Select date** drop-down menu to specify files based on the date they are modified or created.

## Put folders action

The **Put folders** action enables you to upload a folder from a client machine to the FTP/SFTP server.

### Settings

- In the **Session name** field, enter the session name for FTP/SFTP server.  
Use the same session name that you have provided when establishing a connection with the FTP/SFTP server using the **Connect** action.
- Use the **Local folder** field to enter the location of the client machine from where you want to upload folder to FTP/SFTP server.  
Specify filters using wild card characters to restrict uploads to specific types of files.
- (Optional) Use the **File types** field to specify the type of files that must be included in the upload folder.



## Put files action

The **Put files** action enables you to upload one or more files from a client machine to an FTP/SFTP server.

### Settings

- In the **Session name** field, enter the session name for FTP/SFTP server.  
Use the same session name that you have provided when establishing a connection with the FTP/SFTP server using the **Connect** action.
- Use the **Local files** field to enter the location of the client machine from where you want to upload files to FTP/SFTP server.  
Specify filters using wild card characters to restrict uploads to specific types of files.
- Use the **Transfer type** field to select one of the following upload format of the files:
  - **Binary**
  - **ASCII**

## Rename files action

The **Rename files** action enables you to edit or change the name of files on an FTP/SFTP server.

### Settings

- In the **Session name** field, enter the session name for FTP/SFTP server.  
Use the same session name that you have provided when establishing a connection with the FTP/SFTP server using the **Connect** action.
- Use the **Remote file** field to specify the filepath of the file that you want to rename.
- Use the **New remote file** field to enter the new name of the file.

## Fuzzy match package

Use the **Fuzzy match** action to compare the values of two strings or files for similarity. This action returns a decimal value; the closer the value to 1.0, the greater the similarity between the two strings.

---

**Important:** This is a beta package and is currently not available with the Automation 360 Enterprise and Cloud editions.

---

Use this action to automate the process of evaluating strings of data for similarity. For example, you have an automation sequence in which a bot extracts data from invoices, searches a database for the company record, and updates the record with data from the invoice. Use the **Fuzzy match** action to handle two possible scenarios:

- A mistake occurs at the extraction step where a letter is incorrectly extracted. Instead of Apple, the bot extracts App1e, with a numerical one instead of the letter l.

- There is a small variation between the company name on the invoice and in the database. The invoice contains the company name Apple Inc, but the database has a record for the company name Apple.

## Generative AI packages

Generative AI models use deep learning techniques, particularly generative models such as Large Language Models (LLMs). LLMs are deep learning models trained on massive datasets of text to generate human-like text or language-based content. With Automation Anywhere's Generative AI packages, you can select the model that best fits your automation needs.

**Note:** Generative AI models can produce errors and/or misrepresent the information they generate. It is advisable to verify the accuracy, reliability, and completeness of the content generated by the AI model.

Automation Anywhere provides prompt and chat (completion) actions for Google Vertex AI, Microsoft Azure OpenAI, and OpenAI.

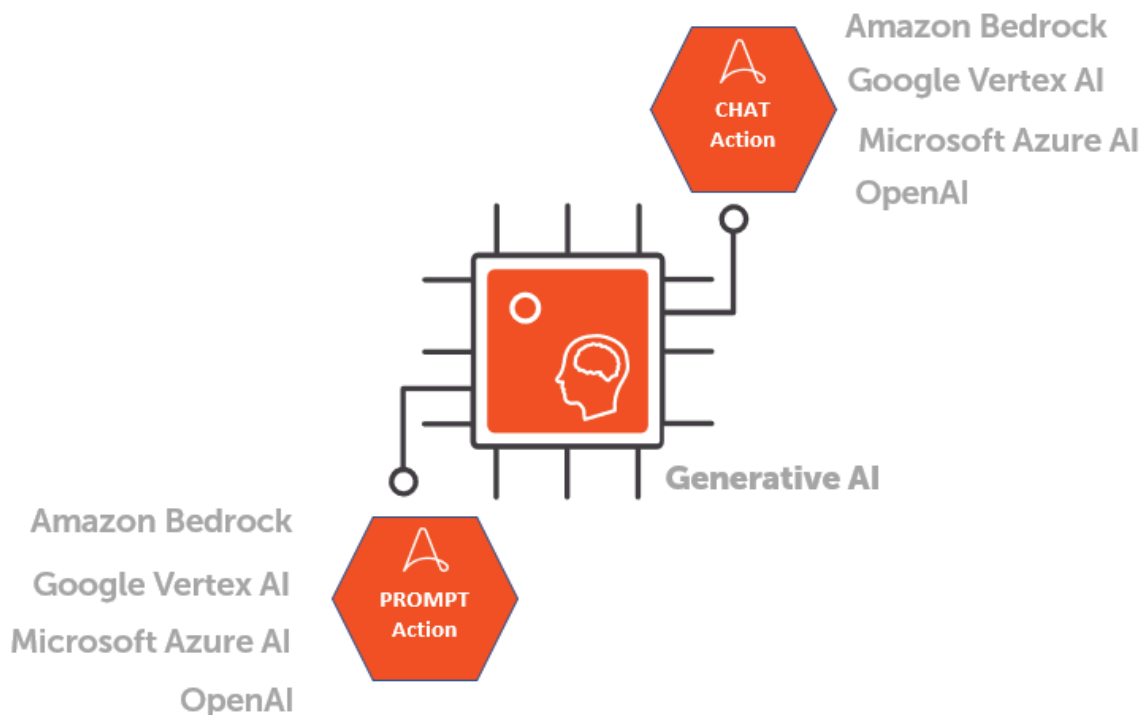

Related concepts

[Data security for generative AI - FAQ](#) on page 1081

We have introduced generative AI (GenAI) infused features to help our customers realize productivity gains by building better and smarter automations. Our customers can realize the

power of GenAI with features such as Automation Co-Pilot for Business Users and Document Automation.

## Amazon Bedrock

Enhance your automation capabilities with the integration of Amazon Bedrock actions with Automation 360. This empowers you to use AI models from AI21 Labs, Anthropic, and Stability AI, integrated within your Automation 360 instance.

Leverage the potential of AI-powered conversations with AI21 Labs Chat AI and Anthropic Chat AI, enabling you to create engaging and interactive dialog experiences. Use AI21 Labs Prompt AI and Anthropic Prompt AI to generate creative text formats.

Transform your text into visuals with Stability Text to Image AI with visual imagery. Tap into the capabilities of Amazon Titan Chat AI and Amazon Titan Prompt AI, proprietary AI models from Amazon, for versatile text generation and embedding tasks.

### Authenticate action

To authenticate access to Amazon Bedrock from the Control Room, you need to obtain Amazon Web Services (AWS) access key ID and secret access key. You can include a session token, which is a temporary token used when working with temporary security credentials.

1. Create an AWS account ([Create a standalone AWS account](#)) or create a member account in your organization ([Creating a member account in your organization](#)).
2. Log in to your AWS account and create a project. If you already have access to a project, you can view it after you log in into your AWS account.

Perform the steps in this procedure to acquire the following key components and use them in the Control Room to authenticate to Amazon Bedrock:

- **AWS access key:** The AWS access key serves as your unique identifier within the AWS ecosystem. It is a fundamental part of the authentication process, allowing AWS services to recognize and validate your access.
- **Secret access key:** The Secret access key is the confidential counterpart to your Access Key ID. This key is used to sign requests made to AWS, enhancing security by ensuring that only authorized individuals or systems can access your AWS resources.
- **Session token (Optional):** Additionally, you have the option to include a Session token. A Session token is a temporary, time-bound token used when working with temporary security credentials. It provides an added layer of security, particularly in scenarios where temporary access is required, such as when using temporary security credentials.

1. Log in to your AWS Console and select the project.
2. Click **Command line or programmatic access** corresponding to the project you selected.
3. Click **Windows** and scroll down the screen to copy the: **AWS access key ID**, **AWS Secret access key**, and **AWS session token**.
4. Log in to the Control Room.
5. Create a new bot.  
For more details, see [Create your first bot](#) on page 1489.
6. From the **Actions** pane, select **Generative AI** > **Amazon Bedrock** > **Authentication** and place it under the **Start** of the bot flow.
7. Paste all the credentials you copied as follows:

**Note:** You can use one of the following options to specify the **Access key/Secret access key/Session token (optional)**:

- **Credential:** To implement stronger security, you can use values in the Credential Vault that contains information about the AWS access key/Secret access key/Session token (optional).
- **Variable:** To implement stronger security, you can use a credential variable that contains information about the AWS access key/Secret access key/Session token (optional).
- **Insecure string:** Enables you to enter the AWS access key/Secret access key/Session token (optional).

- 
- a) In the **Access key** field, paste the **Access key** copied from your AWS environment.
  - b) In the **Secret access key** field, paste the **Secret access key** copied from your AWS environment.
  - c) In the **Session token (optional)** field, paste the **Session token (optional)** copied from your AWS environment.
  - d) Enter **Default** as the local session name or create a global session or store the session in a variable.

8. Click **Run** to ensure you are successfully authenticated.

## AI21 Labs Chat AI action

AI21 Labs Chat AI action connects automations to Amazon Bedrock AI21 Labs chat AI functionality. This action enables automations to engage in natural, informative, and context-aware conversations with users, providing a more personalized and engaging automation experience.

- You must have the Bot creator role to use the AI21 Labs Chat AI action in a bot.
- Ensure that you have the necessary credentials to send a request and have included [Authenticate action](#) on page 2627 before calling any Amazon Bedrock actions.

This example shows how to send a natural language message using the AI21 Labs Chat AI action and get an appropriate response.

1. In the Control Room, navigate to the **Actions** pane, select **Generative AI > Amazon Bedrock**, drag **AI21 Labs: Chat AI** and place it in the canvas.
2. Enter or select the following fields:

The screenshot displays the Amazon Bedrock console interface for configuring an automation. On the left, the 'Actions' pane shows 'AI21 Labs Chat AI' selected under 'Amazon Bedrock'. The central 'Flow' pane shows a sequence of steps: 'Start', 'Authentication', 'Step', 'Generative AI: AI21 Labs Chat...', and 'Message box'. The right-hand pane provides configuration options for the 'Generative AI: AI21 Labs Chat AI' action, including Region, Model, Message, Max completion length, Temperature, Session name, and Output.

- a) Enter the Region. For information on Region, see [Amazon Bedrock GA regions](#).
- b) Click the Model drop-down and select a model with which to communicate.
  - Jurassic-2 Mid: Jurassic-2 Mid is the mid-sized model in the Jurassic-2 series and is used for a wide range of language comprehension and generation tasks.
  - Jurassic-2 Ultra: Jurassic-2 Ultra is a better model in the Jurassic-2 series, designed for the most complex language generation tasks.
- c) Enter a chat **Message** to use by the model to generate a response.

---

**Note:** Chat actions retain the result of the previous chat action within the same session. If you call chat actions consecutively, the model can understand subsequent messages and relate them to the previous message. However, all chat history is deleted after the session ends.

---

- d) Enter the maximum completion length.  
By default, if you do not enter a value, then the maximum completion length is automatically set to keep it within the maximum context length of the selected model by considering the length of the generated response.
- e) Enter a **Temperature**. This value refers to the randomness of the response. As the temperature approaches zero, the response becomes more specific. The higher the value, the more random is the response.
- f) Enter Default as the session name to limit the session to the current session.

- g)** To manage the optional parameters, click **Show more options** and select **Yes**. If you select Yes, you can add other parameters such as: **Top P**, **Add instructions**, **Presence penalty**, **Count penalty**, **Frequency penalty**, **Penalize special tokens**, and **Stop sequences**. For information about these optional parameters, see [Learn Models](#).
- h)** Save the response to a variable. In this example, the response is saved to `str_AI21Labs_chatResponse`.

- 3.** Click **Run** to start the bot.

You can read the value of the field by printing the response in a Message box action. In this example, `str_AI21Labs_chatResponse` prints the response. You can add additional chat requests to get additional responses.

---

**Tip:** To maintain multiple chats in the same bot, you will need to create multiple sessions with different names or variables.

---

### AI21 Labs Prompt AI action

AI21 Labs prompt AI action connects automations to Amazon Bedrock AI21 Labs prompt AI functionality. This action enables automations to generate human-quality text, translate languages, write different kinds of creative content, and answer questions in an informative way, all based on user-defined prompts.

- You must have the Bot creator role to use the AI21 Labs Prompt AI action in a bot.
- Ensure that you have the necessary credentials to send a request. For more information on acquiring the credentials, see [Authenticate action](#) on page 2627.

This example shows how to send a natural language message using the AI21 Labs Prompt AI action and get an appropriate response.

- 1.** In the Control Room, navigate to the **Actions** pane, select **Generative AI > Amazon Bedrock**, drag **AI21 Labs Prompt AI** and place it in the canvas.
- 2.** Enter or select the following fields:

The screenshot displays the Amazon Bedrock console interface for configuring an automation. On the left, the 'Actions' panel shows a search for 'gen' and a list of actions under 'Generative AI', with 'AI21 Labs Prompt AI' highlighted. The central 'Flow' pane shows a sequence of steps: 'Start', 'Authentication' (aws), 'Step', 'Generative AI: AI21 Labs Prompt AI' (aws), and 'Message box'. The right-hand 'Configuration' pane for the 'Generative AI: AI21 Labs Prompt AI' action includes the following settings:

- Region:** us-east-1
- Model:** Jurassic-2 Mid
- Message:** Tell me about Automation Anywhere
- Max completion length:** 512
- Temperature:** 0.7
- Session:** Default
- Show more options:** Yes
- Output:** str\_AI21Labs\_promptResponse

- Enter the **Region**.  
For information on Region, see [Amazon Bedrock GA regions](#).
- Click the **Model** drop-down and select a model with which to communicate.
  - Jurassic-2 Mid:** Jurassic-2 Mid is the mid-sized model in the Jurassic-2 series and is used for a wide range of language comprehension and generation tasks.
  - Jurassic-2 Ultra:** Jurassic-2 Ultra is a better model in the Jurassic-2 series, designed for the most complex language generation tasks.
- Enter a Prompt **Message** to use by the model to generate a response.
- Enter the maximum completion length.  
By default, if you do not enter a value, then the maximum completion length is automatically set to keep it within the maximum context length of the selected model by considering the length of the generated response.
- Enter a **Temperature**. This value refers to the randomness of the response. As the temperature approaches zero, the response becomes more specific. The higher the value, the more random is the response.
- Enter **Default** as the session name to limit the session to the current session.
- To manage the optional parameters, click the **Show more options** and select **Yes**. If you select Yes, you can add other parameters such as: **Top P**, **Add instructions**, **Presence penalty**, **Count penalty**, **Frequency penalty**, **Penalize special tokens**, and **Stop sequences**. For information about these optional parameters, see [Learn Models](#).

h) Save the response to a variable. In this example, the response is saved to `str_AI21Labs_promptResponse`.

3. Click **Run** to start the bot.

You can read the value of the field by printing the response in a Message box action. In this example, `str_AI21Labs_promptResponse` prints the response.

## Anthropic Chat AI action

Anthropic Chat AI action connects automations to Amazon Bedrock Anthropic chat AI functionality. This action enables automations to engage in natural, informative, and context-aware conversations with users, providing a more personalized and engaging automation experience.

- You must have the Bot creator role to use the Anthropic Chat AI action in a bot.
- Ensure that you have the necessary credentials to send a request. For more information on acquiring the credentials, see [Authenticate action](#) on page 2627.

This example shows how to send a natural language message using the Anthropic Chat AI action and get an appropriate response.

- In the Control Room, navigate to the **Actions** pane, select **Generative AI > Amazon Bedrock**, drag **Anthropic: Chat AI** and place it in the canvas.
- Enter or select the following fields:

The screenshot displays the Amazon Bedrock Control Room interface. On the left, the 'Actions' pane shows a search for 'gen' and a list of actions under 'Generative AI' and 'Amazon Bedrock', with 'Anthropic Chat AI' highlighted. The central canvas shows a flowchart with five steps: 1. Start, 2. Authentication, 3. Generative AI: Anthropic Chat AI (highlighted with a yellow box), and 4. Message box. The right-hand configuration panel for the 'Generative AI: Anthropic Chat AI' action is visible, with fields labeled a through h corresponding to the list items below.

a) Enter the Region. For information on Region, see [Amazon Bedrock GA regions](#).



- b)** Click the Model drop-down and select a model with which to communicate.
- Claude v1.1: Claude v1.1 enables natural language processing, including question answering, summarization, and creative text generation. However, it had limitations in handling complex tasks and maintaining consistent safety and reliability.
  - Claude v1.3: Claude v1.3 enables consistency in responses, and better handling of complex tasks. It introduces a new "Instant" mode for faster responses in less demanding scenarios.
  - Claude v2: Claude v2 handles longer and more complex prompts, generate more creative and informative text, and maintain consistent safety across various tasks.

- c)** Enter a chat **Message** to use by the model to generate a response.

---

**Note:** Chat actions retain the result of the previous chat action within the same session. If you call chat actions consecutively, the model can understand subsequent messages and relate them to the previous message. However, all chat history is deleted after the session ends.

---

- d)** Enter the maximum length.  
By default, if you do not enter a value, then the maximum length is automatically set to keep it within the maximum context length of the selected model by considering the length of the generated response.
- e)** Enter a **Temperature**. This value refers to the randomness of the response. As the temperature approaches zero, the response becomes specific. The higher the value, the more random is the response.
- f)** Enter Default as the session name to limit the session to the current session.
- g)** To manage the optional parameters, click **Show more options** and select **Yes**. If you select Yes, you can add other parameters such as: **Top P**, **Top K**, **Add instructions**, **Stop sequences**, or enter an **Anthropic version**. For information about these optional parameters, see [Learn Models](#).
- h)** Save the response to a variable..  
In this example, the response is saved to str\_Anthropic\_chatResponse

- 3.** Click **Run** to start the bot.

You can read the value of the field by printing the response in a Message box action. In this example, str\_Anthropic\_chatResponse prints the response. You can add additional chat requests to get additional responses.

---

**Tip:** To maintain multiple chats in the same bot, you will need to create multiple sessions with different names or variables.

---

## Anthropic Prompt AI action

Anthropic Prompt AI action connects automations to Amazon Bedrock Anthropic prompt AI functionality. This action enables automations to generate human-quality text, translate languages, write different kinds of creative content, and answer questions in an informative way, all based on user-defined prompts.

- You must have the Bot creator role to use the Anthropic Prompt AI action in a bot.

- Ensure that you have the necessary credentials to send a request. For more information on acquiring the credentials, see [Authenticate action](#) on page 2627.

This example shows how to send a natural language message using the Anthropic Prompt AI action and get an appropriate response.

1. In the Automation Anywhere Control Room, navigate to the **Actions** pane, select **Generative AI** > **Amazon Bedrock**, drag **Anthropic: Prompt AI** and place it in the canvas.
2. Enter or select the following fields:

The screenshot displays the Amazon Bedrock configuration interface. The workflow canvas shows a sequence of actions: Start, Authentication, Step, Generative AI: Anthropic Prompt AI (highlighted), and Message box. The configuration panel on the right is titled "Generative AI: Anthropic Prompt AI" and contains the following fields:

- a) Region:** us-east-1
- b) Model:** Claude v2
- c) Message:** Write a code snippet in python to parse a spreadsheet
- d) Maximum length:** 300
- e) Temperature:** 1
- f) Session name:** Default
- g) Show more options:** Yes
- h) Output:** str\_Anthropic\_promptResponse

- a) Enter the Region. For information on Region, see [Amazon Bedrock GA regions](#).
- b) Click the Model drop-down and select a model with which to communicate.
  - Claude v1.1: Claude v1.1 enables natural language processing, including question answering, summarization, and creative text generation. However, it had limitations in handling complex tasks and maintaining consistent safety and reliability.
  - Claude v1.3: Claude v1.3 enables consistency in responses, and better handling of complex tasks. It introduces a new "Instant" mode for faster responses in less demanding scenarios.
  - Claude v2: Claude v2 handles longer and more complex prompts, generate more creative and informative text, and maintain consistent safety across various tasks.
- c) Enter a prompt **Message** to use by the model to generate a response.
- d) Enter the maximum length.

By default, if you do not enter a value, then the maximum length is automatically set to keep it within the maximum context length of the selected model by considering the length of the generated response.

- e) Enter a **Temperature**. This value refers to the randomness of the response. As the temperature approaches zero, the response becomes more focused and deterministic. The higher the value, the more random is the response.
- f) Enter Default as the session name to limit the session to the current session.
- g) To manage the optional parameters, click **Show more options** and select **Yes**. If you select Yes, you can add other parameters such as: **Top P**, **Top K**, **Stop sequences**, or enter an **Anthropic version**. For information about these optional parameters, see [Learn Models](#).
- h) Save the response to a variable.  
In this example, the response is saved to str\_Anthropic\_promptResponse.

3. Click **Run** to start the bot.

You can read the value of the field by printing the response in a Message box action. In this example, str\_Anthropic\_promptResponse prints the response.

## Amazon Titan: Chat AI action

Amazon Titan: Chat AI action connects automations to Amazon Bedrock Titan chat AI functionality. This action enables automations in natural, informative, and context-aware conversations with users, providing a more personalized and engaging automation experience.

- You must have the Bot creator role to use the Amazon Titan: Chat AI action in a bot.
- Ensure that you have the necessary credentials to send a request and have included [Authenticate action](#) on page 2627 before calling any Amazon Bedrock actions.

This example shows how to send a natural language message using the Titan Chat AI action and get an appropriate response.

1. In the Automation Anywhere Control Room, navigate to the **Actions** pane, select **Generative AI > Amazon Bedrock**, drag **Amazon Titan: Chat AI**, and place it in the canvas.
2. Enter or select the following fields:

The screenshot displays the Amazon Bedrock automation interface. On the left, the 'Actions' pane shows a search for 'gen' and a list of generative AI actions, with 'Amazon Titan: Chat AI' highlighted. The main workspace shows a workflow with steps: 1. Authentication, 2. Generative AI: Authenticate, 3. Amazon Titan: Chat AI (highlighted), 4. Message box (Sstr\_ChatResponse-15), 5. Generative AI: Amazon Titan: 'Include addition', 6. Message box (Sstr\_ChatResponse-25), 7. Generative AI: Amazon Titan: 'Include multiplication', and 8. Message box (Sstr\_ChatResponse-35). The right pane shows the configuration for the 'Generative AI: Amazon Titan: Chat AI' action, with fields labeled a through h.

**Generative AI: Amazon Titan: Chat AI**

This action executes Amazon Titan Foundation Models which are pre-trained on large datasets, making them powerful, general-purpose models.

Required bot agent version: 21.240 or above

Region:  (a)

Model:  (b)

Message:  (c)

Response length:  (d)

Temperature:  (e)

Session name:  (f)

Show more options:   (g)

Output:  (h)

- Enter the Region. For information on Region, see [Amazon Bedrock GA regions](#).
- Click the Model drop-down and select a model with which to communicate.
  - Titan Text G1 - Lite: Amazon's Titan Text G1-Lite is a smaller and more efficient version of the larger Titan Text G1 model, making it more suitable for devices with limited resources.
  - Titan Text G1 - Express: Amazon's Titan Text G1 - Express model is a versatile and cost-effective large language model (LLM) designed for a wide range of text generation tasks.
- Enter a chat **Message** to use by the model to generate a response.

**Note:** Chat actions retain the result of the previous chat action within the same session. If you call chat actions consecutively, the model can understand subsequent messages and relate them to the previous message. However, all chat history is deleted after the session ends.

- Enter the maximum length.

By default, if you do not enter a value, then the maximum length is automatically set to keep it within the maximum context length of the selected model by considering the length of the generated response.

- e) Enter a **Temperature**. This value refers to the randomness of the response. As the temperature approaches zero, the response becomes specific. The higher the value, the more random is the response.
- f) Enter Default as the session name to limit the session to the current session.
- g) To manage the optional parameters, click the **Show more options** and select **Yes**. If you select Yes, you can add other parameters such as: **Top P**, **Add Instructions**, , and **Stop Sequences**. For information about these optional parameters, see [Learn Models](#).
- h) Save the response to a variable. In this example, the response is saved to str\_ChatResponse-1.

3. Click **Run** to start the bot.

You can read the value of the field by printing the response in a Message box action. In this example, the first chat response is stored instr\_ChatResponse-1. You can add additional chat requests to get additional responses as shown in the example.

---

**Tip:** To maintain multiple chats in the same bot, you will need to create multiple sessions with different names or variables.

---

## Amazon Titan: Prompt AI action

Amazon Titan: Prompt AI action connects automations to Amazon Bedrock Titan prompt AI functionality. This action enables automations to generate human-quality text, translate languages, write different kinds of creative content, and answer questions in an informative way, all based on user-defined prompts.

- You must have the Bot creator role to use the Amazon Titan: Prompt AI action in a bot.
- Ensure that you have the necessary credentials to send a request and have included [Authenticate action](#) on page 2627 before calling any Amazon Bedrock actions.

This example shows how to send a natural language message using the Titan Prompt AI action and get an appropriate response.

1. In the Automation Anywhere Control Room, navigate to the **Actions** pane, select **Generative AI > Amazon Bedrock**, drag **Amazon Titan: Prompt AI**, and place it in the canvas.
2. Enter or select the following fields:

The screenshot displays the Amazon Bedrock Bot configuration interface. On the left, the 'Actions' panel lists various AI services, with 'Amazon Titan: Prompt AI' highlighted. The central workflow editor shows a sequence of steps and actions. Step 4, 'Generative AI: Amazon Titan: Prompt AI', is highlighted with a yellow box. The right panel provides configuration options for this action, including Region, Model, Message, Response length, Temperature, Session, and Show more options.

- a) Enter the Region. For information on Region, see [Amazon Bedrock GA regions](#).
- b) Click the Model drop-down and select a model with which to communicate.
  - Titan Text G1 - Lite: Amazon's Titan Text G1-Lite is a smaller and more efficient version of the larger Titan Text G1 model, making it more suitable for devices with limited resources.
  - Titan Text G1 - Express: Amazon's Titan Text G1 - Express model is a versatile and cost-effective large language model (LLM) designed for a wide range of text generation tasks.
- c) Enter a prompt **Message** to use by the model to generate a response.
- d) Enter the **Response Length**.  
By default, if you do not enter a value, then the Response Length is automatically set to keep it within the maximum context length of the selected model by considering the length of the generated response.
- e) Enter a **Temperature**. This value refers to the randomness of the response. As the temperature approaches zero, the response becomes specific. The higher the value, the more random is the response.
- f) Enter Default as the session name to limit the session to the current session.
- g) To manage the optional parameters, click the **Show more options** and select **Yes**. If you select Yes, you can add other parameters such as: **Top P** and **Stop Sequences**. For information about these optional parameters, see [Learn Models](#).

h) Save the response to a variable. In this example, the response is saved to str\_PromptResponse.

3. Click **Run** to start the bot.

You can read the value of the field by printing the response in a Message box action. In this example, str\_PromptResponse prints the response.

## Stability Text to Image AI action

Stability Text to Image AI action connects automations to Amazon Bedrock Stability text-to-image AI functionality. This action enables automations to generate photorealistic images from text descriptions, unlocking a new dimension of automation possibilities.

- You must have the Bot creator role to use the Stability Text to Image AI action in a bot.
- Ensure that you have the necessary credentials to send a request. For more information on acquiring the credentials, see [Authenticate action](#) on page 2627.

This example shows how to send a natural language message using the Stability Text to Image AI action and get an appropriate response.

- In the Automation Anywhere Control Room, navigate to the **Actions** pane, select **Generative AI > Amazon Bedrock**, drag **Stability Text to Image AI** and place it in the canvas.
- Enter or select the following fields:

The screenshot displays the Amazon Bedrock interface with a workflow canvas and a configuration panel for the 'Generative AI: Stability AI Text-to-Image AI' action. The workflow steps are: 1. Start, 2. Step 'Authentication', 3. Step 'Stability AI', 4. Generative AI: Stability AI Text-to-Image AI (highlighted with a yellow box), and 5. Message box. The configuration panel on the right shows the following settings:

- Region: us-east-1
- Model: Stable Diffusion XL v0.8
- Message: A dog with blue eyes
- Prompt strength: 10
- Destination folder: C:\temp
- Session name: Default
- Show more options: No
- File path: str\_FilePath\$

- Enter the Region. For information on Region, see [Amazon Bedrock GA regions](#).
- Click the Model drop-down and select a model with which to communicate. Currently, the only available model is Stable Diffusion XL v0.8.

- Stable Diffusion XL v0.8: This text-to-image model leverages diffusion-based techniques to generate photo realistic images from text descriptions.
  - c) Enter a **Message** to use by the model to generate an image.
  - d) Enter the **Prompt Strength**.  
By default, if you do not enter a value, it is set to 10. This parameter ranges from 0 to 30 and specifies how strict the diffusion process adheres to the prompt text (higher values keep your image closer to your prompt).
  - e) Enter a **Destination Folder**. This refers to the folder where the output image is saved.
  - f) Enter Default as the session name to limit the session to the current session.
  - g) To manage the optional parameters, click **Show more options** and select **Yes**. If you select Yes, you can add other parameters such as: **Generation Step** and **Seed**. For information about these optional parameters, see [text-to-image parameters](#).
  - h) Save the entire file path including the file name in a variable. In this example, the response is saved to filePath.
3. Click **Run** to start the bot.
- You can read the value of the file path including file name by printing the response in a Message box action. In this example, the image is stored in filePath

## Google Vertex AI

Google Vertex AI is a cloud machine learning (ML) platform on which you can train and deploy generative AI based ML models and AI applications, and customize large language models (LLMs) to use in your AI-powered applications.

Automation Anywhere's Google package leverages Google Vertex AI features to build automations using the hosted model endpoints.

Watch the following videos that illustrates a Google Vertex AI use case:

### Connect action

You can connect to a Google Cloud Platform (GCP) instance using the Connect action. The GCP manages access to your Google Vertex AI instance.

---

**Note:** The examples and graphics provided on this page are for representation purposes only and may not accurately reflect your specific instance. We do not assume responsibility for their maintenance or accuracy.

---

- Create a GCP account ([GCP Cloud](#)) and create a GCloud project.
- Log in to your GCloud account at [Google Cloud Project](#) and create a project. If you already have access to a project, you can view it here.
- Create an OAuth 2.0 Client ID. A client ID is used to identify a single application to Google's OAuth Servers. For more details, see [Google connect](#).

You can connect to a GCP instance using the **Connect** action from Automation 360. To connect to a GCP, you can use one of the following connection methods:

- **User Account:** Enter the GCloud account credentials to establish a connection.



- **Service Account:** Enter the GCloud service account key to authenticate between servers using the certificate. To create a service account key, see [Creating a service account](#).
- **Control Room OAuth Connection:** Select the previously configured OAuth connection in your Automation Anywhere Control Room. For more information on creating OAuth connection, see [Create OAuth connection](#) on page 1893.

1. Open the [Google Cloud console](#).
2. At the top-left, click **Menu > APIs & Services > Credentials**.
3. Click an application under OAuth 2.0 Client IDs that you want to connect.

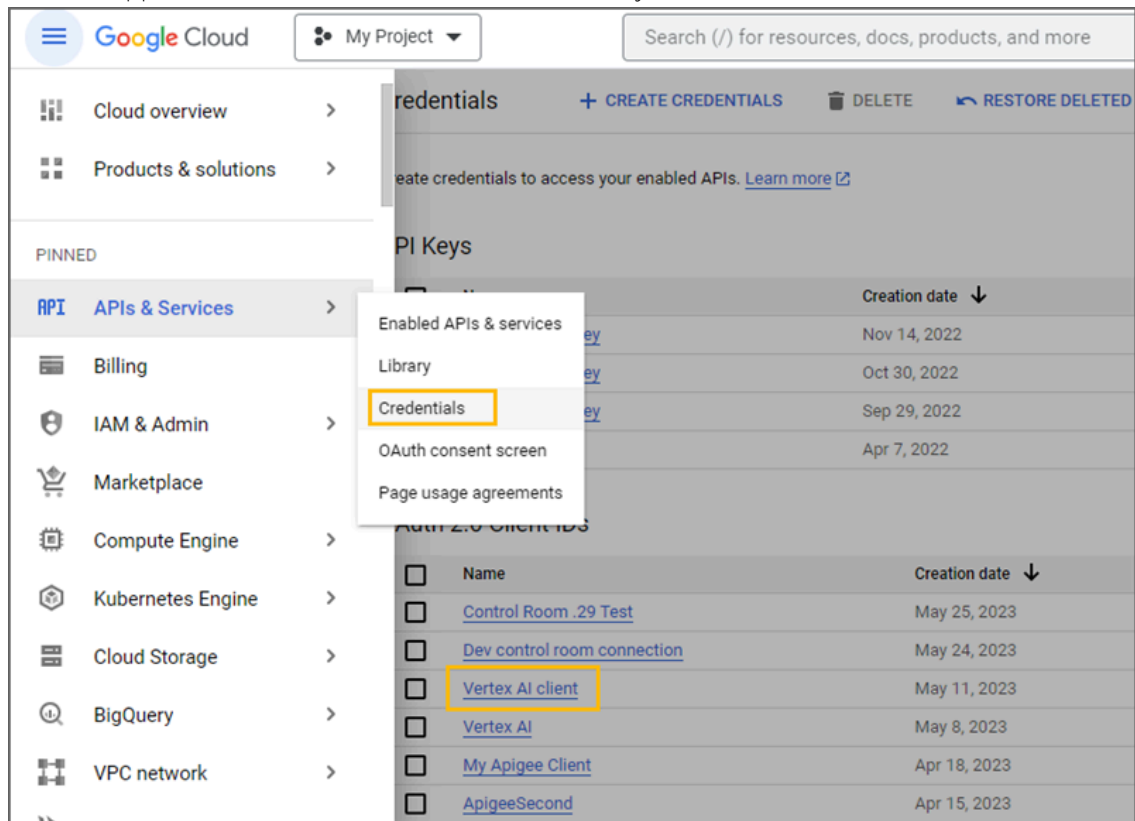

4. Copy the values from the **Client ID**, **Client secret**, and **URI** fields.
5. Create a new bot. For more details, see [Create your first bot](#) on page 1489.
6. In the Automation Anywhere Control Room, navigate to the **Actions** pane, select **Generative AI > Google**, drag **Connect**, and place it in the canvas.
7. Connect to the GCP using one of these methods: User Account, Service Account, or Control Room OAuth.

Connect using User Account

To connect using the User Account method:

- a) In the **User Email Address** field, enter the email address that is used to log in to the GCloud account.
- b) In the **Client ID** field, paste the **Client ID** copied from the GCloud. This example uses **Insecure string** (for stronger security, you can use **Credential** or **Variable**).

**Note:** You can use one of the following options to specify the **User Email Address/Client ID/Client secret/Redirect URI**:

- **Credential:** To implement stronger security, you can use values in the Credential Vault that contains information about the User Email Address/Client ID/Client secret/Redirect URI.
- **Variable:** To implement stronger security, you can use a credential variable that contains information about the User Email Address/Client ID/Client secret/Redirect URI.
- **Insecure string:** Enables you to enter the User Email Address/Client ID/Client secret/Redirect URI.

- 
- c) In the **Client Secret** field, paste the **Client Secret** copied from the GCloud.
  - d) In the **Redirect URI** field, enter the redirect URI from the GCloud account.
  - e) Enter **Default** as the session name.

Connect using Service Account

To connect using the Service Account method:

- a) In the **Service Account Key** field, enter the GCloud service account key. This example uses **Insecure string** (for stronger security, you can use **Credential** or **Variable**).
- b) In the **Create Vertex AI session** field, the session name is displayed as **Default**

---

**Note:** If you do not have access to generate and retrieve the **Service Account Key**, contact your Google Cloud Admin.

---

Connect using Control Room OAuth connection

To connect using the Control Room OAuth, select an available OAuth connection. For information on setting up an OAuth connection, see [Create OAuth connection](#) on page 1893.

## Vertex AI: Chat AI action

The Vertex AI: Chat AI action uses Google's Vertex AI completion API for interacting with the models. It generates text in a conversational format.

- You must have the Bot creator role to use the Vertex Chat AI action in a bot.
- Ensure that you have the necessary credentials to send a request and have included [Connect action](#) on page 2640 before calling any Google Cloud actions.

This example shows how to send a natural language message using the Vertex AI: Chat AI action and get an appropriate response.

1. In the Automation Anywhere Control Room, navigate to the **Actions** pane, select **Generative AI > Google**, drag **Vertex AI: Chat AI**, and place it in the canvas.
2. Enter or select the following fields:

The screenshot displays the Automation Anywhere interface for building an automation named 'generative-ai-bot'. The workflow is shown in the center, with five steps: 14. 'Generative AI: Connect' (Start a session 'Default'), 15. 'Generative AI: Vertex AI: Chat AI' (Tell me about the history of ...), 16. 'Generative AI: Vertex AI: Chat AI' ('Where is their headquarter?'), 17. 'Message box' (Tell me about the history of ...), and 18. 'Generative AI: Disconnect' (End a session 'Default'). The right-hand panel shows the configuration for the 'Generative AI: Vertex AI: Chat AI' action, with various fields labeled a) through i).

- a) Enter the Project Number/Name. This is the unique Project ID from the GCP. For information on Project ID, see [Google Cloud Project's Project ID](#).
- b) Click Publisher drop-down and select Google; or select 3rd Party to enter a third-party publisher.
- c) Click the Model drop-down and select a model with which to communicate.
  - chat-bison: A model fine-tuned for multi-turn conversation use cases.
  - codechat-bison: A model fine-tuned for chatbot conversations that help answer code-related questions.
  - Custom: Select Custom to add a custom model.
- d) Enter a chat **Message** to use by the model to generate a response.

**Note:** Chat actions retain the result of the previous chat action within the same session. If you call chat actions consecutively, the model can understand subsequent messages and relate them to the previous message. However, all chat history is deleted after the session ends.

- e) Enter the maximum number of tokens to generate. By default, if you do not enter a value, then the maximum number of tokens generated is automatically set to keep it within the maximum context length of the selected model by considering the length of the generated response.
- f) Enter a **Temperature**. This value refers to the randomness of the response. As the temperature approaches zero, the response becomes more focused and deterministic. The higher the value, the more random is the response.
- g) Enter Default as the session name to limit the session to the current session.



The screenshot displays the Automation Anywhere interface for configuring a workflow. The workflow is titled 'generative-ai-bot' and is saved. The 'Actions' pane on the left shows the 'Vertex AI: Prompt AI' action selected. The workflow canvas shows a sequence of steps: 13. Vertex AI Actions, 14. Generative AI: Connect (Start a session 'Default'), 15. Generative AI: Vertex AI: Prompt AI (Automate data preprocessing...), 16. Message box (\$google-vertex\_prompt-resp...), and 17. Generative AI: Disconnect (End a session 'Default'). The right-hand pane shows the configuration for the 'Generative AI: Vertex AI: Prompt AI' step, with fields for Project Number/Name, Publisher, Model, Prompt, Max tokens, Temperature, Session name, and Response. Yellow callouts 'a' through 'i' are placed over the configuration fields.

- a) Enter the Project Number/Name. This is the unique Project ID from the GCP. For more information on Project ID, see [Google Cloud Project's Project ID](#).
- b) Click Publisher drop-down and select Google; or select 3rd Party to enter a third-party publisher.
- c) Click the Model drop-down and select a model to send prompt.
  - code-bison@001: A model fine-tuned to generate code based on a natural language description of the desired code. For example, it can generate a unit test for a function.
  - code-gecko@001: A model fine-tuned to suggest code completion based on the context in code that is written.
  - text-bison@001: A model fine-tuned to follow natural language instructions and is suitable for a variety of language tasks.
  - text-bison (latest): The latest version of the text-bison.
  - Custom: Select Custom to add a custom model.

---

#### Note:

- Bison: Best value in terms of capability and cost.
- Gecko: Smallest and lowest cost model for simple tasks.

- d) Enter a **Prompt** to use by the model to generate a response.
- e) Enter the maximum number of tokens to generate. By default, if you do not enter a value, then the maximum number of tokens generated is automatically set to keep it within the maximum context length of the selected model by considering the length of the generated response.

- f) Enter a **Temperature**. This value refers to the randomness of the response. As the temperature approaches zero, the response becomes more focused and deterministic. The higher the value, the more random is the response.
  - g) Enter Default as the session name to limit the session to the current session.
  - h) To manage the optional parameters, click the **Show more options** and select **Yes**. If you select Yes, you can add other parameters such as: **Top K** and **Top P**. For information about these optional parameters, see [Learn Models](#).
  - i) Save the response to a variable. In this example, the response is saved to google-vertex\_prompt-response.
3. Click **Run** to start the bot. You can read the value of the field by printing the response in a Message box action. In this example, google-vertex\_prompt-response prints the response.

### Disconnect action

You can disconnect from your Google Cloud Platform (GCP) instance and clear the session using the Disconnect action.

1. In the Automation Anywhere Control Room, navigate to the **Actions** pane, select **Generative AI > Google**, drag **Disconnect**, and place it in the canvas at the end of your bot logic.
2. Enter the session name.
3. After the bot runs, your Generative AI instance is disconnected.

## Microsoft Azure OpenAI

Microsoft Azure OpenAI service enables generative AI capabilities by training on massive amounts of data to learn the patterns and relationships between words, phrases and sentences. It offers coding and language AI models that you can use to your specific needs for a variety of use cases.

Microsoft Azure OpenAI service provides REST API access to language models including the GPT-3, Codex, and Embeddings model series. You can use Automation Anywhere's Microsoft Azure OpenAI package to connect with the Microsoft Azure OpenAI service REST APIs to build generative AI based automations that respond to your general natural language queries.

### Configuring the Azure OpenAI

This topic describes configuring the Microsoft Azure OpenAI so that Automation Anywhere Control Room can access it.

---

**Note:** The examples and graphics provided on this page are for representation purposes only and may not accurately reflect your specific instance. We do not assume responsibility for their maintenance or accuracy.

---

Create a developer account in Microsoft Azure OpenAI to copy the login credentials. For information on OpenAI, see the [Azure OpenAI Service Documentation](#).

In addition to the developer account,

- Make sure you have added the following Azure OpenAI endpoints to the trusted list:
  - [https://\\*.openai.azure.com/api/\\*.completions](https://*.openai.azure.com/api/*.completions)
  - [https://\\*.openai.azure.com/api/\\*.chatCompletions](https://*.openai.azure.com/api/*.chatCompletions)

- You need to have an Microsoft Azure OpenAI resource. This is a resource that you will use to deploy and manage your models.
1. Log in to the [Microsoft Azure portal](#) and search for **Azure OpenAI**.
  2. On the **Cognitive Services Azure OpenAI** page, click **Create**. The Create Azure OpenAI page appears.
  3. Enter or select the following

The screenshot shows the 'Create Azure OpenAI' page in the Microsoft Azure portal. The page is titled 'Create Azure OpenAI' and includes a search bar at the top. Below the title, there is a brief description of the service and a 'Learn more' link. The main section is divided into three parts: Project Details, Instance Details, and Content review policy. In the Project Details section, the Subscription is set to 'Azure subscription 1' and the Resource group is '(New) aaintegration'. In the Instance Details section, the Region is 'East US', the Name is 'azureopenai-aa-integration' (highlighted with a purple border and a checkmark), and the Pricing tier is 'Standard S0'. At the bottom, there are 'Previous' and 'Next' buttons, and a 'Give feedback' link.

details:

- a) Create or select an existing **Resource group**. A resource group is a collection of resources that share the same lifecycle, permissions, and policies.
- b) Select the Azure region for your specific location. For example, East US.
- c) Enter the **Name** of your resource. This will also be your custom domain name in your endpoint.

**Note:** Your resource name can include alphanumeric characters and hyphens, but cannot start or end with a hyphen.

- d) Select a **Pricing tier**.
4. Click **Next**.
  5. On the **Create Azure OpenAI, Network** page, select **All networks, including the internet, can access this resource**.
  6. Click **Next**.

7. On the **Create Azure OpenAI, Tags** page, you can create tags. For more information, see [Using tags to organize Azure resources and management hierarchy](#). No tags are created in this example.
8. Click **Next**.
9. On the **Create Azure OpenAI, Review+Submit** page, review all the information and click **Create**.

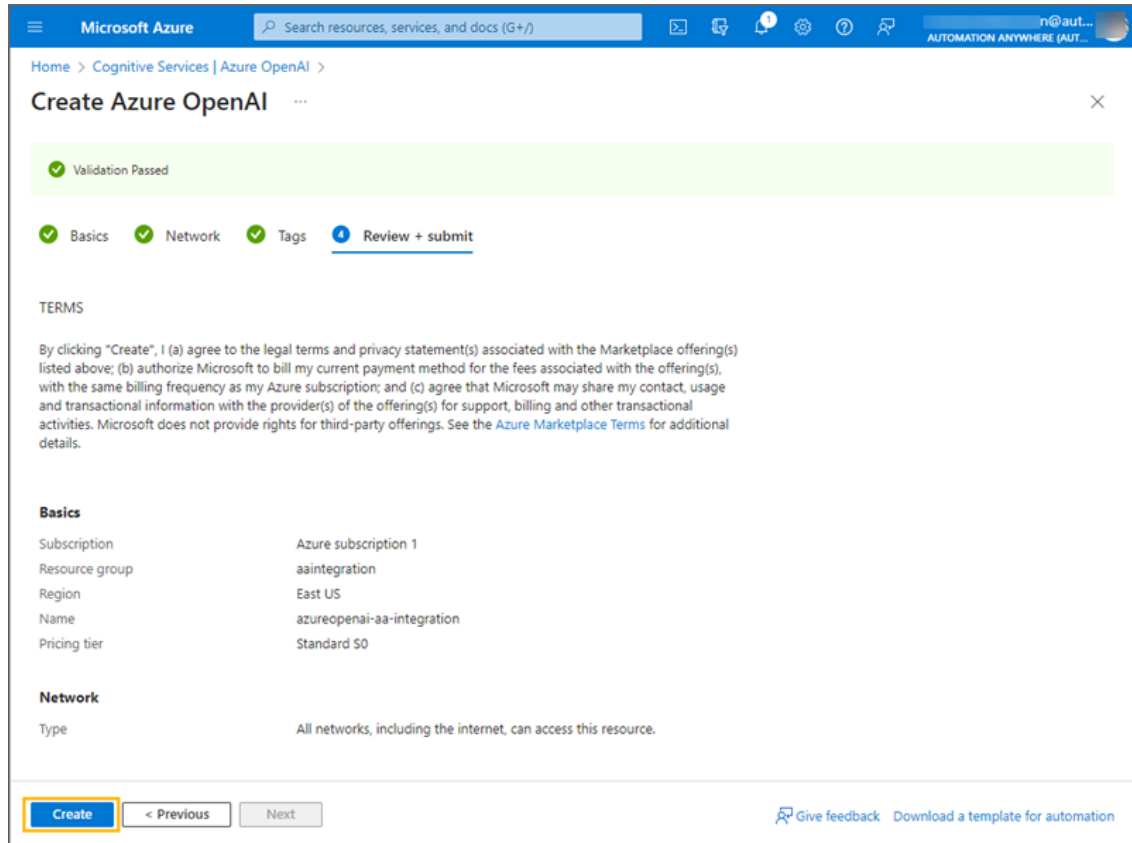

You can view status messages such as initiating deployment and submitting deployment. After the Azure OpenAI service is successfully initialized and deployed, the **Your deployment is complete** message displays at the top of the page.



10. Click **Go to Resource** to view the app

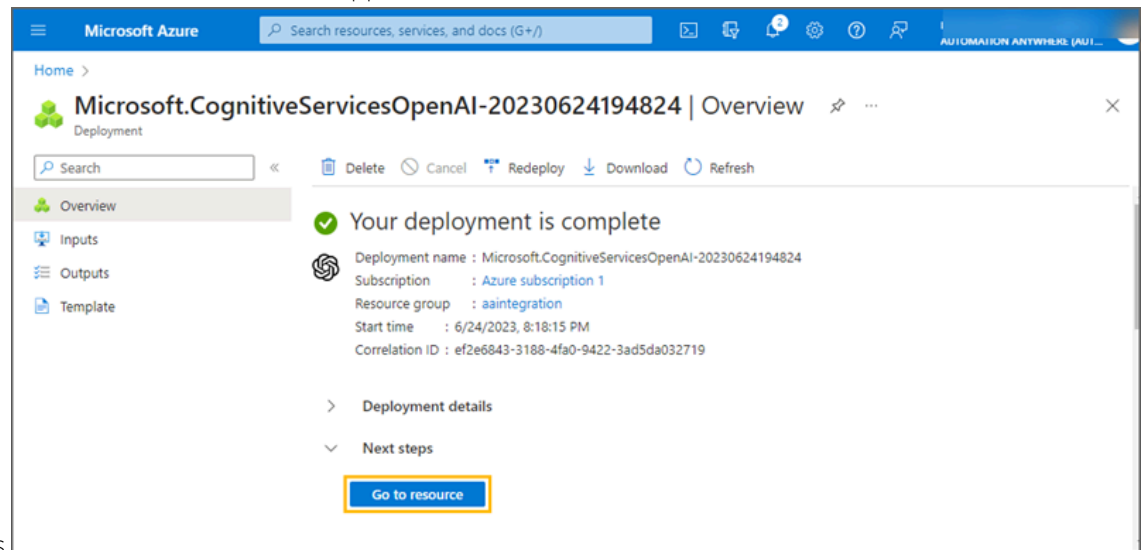

details.

11. In the left navigation, under Resource Management, click **Keys and**

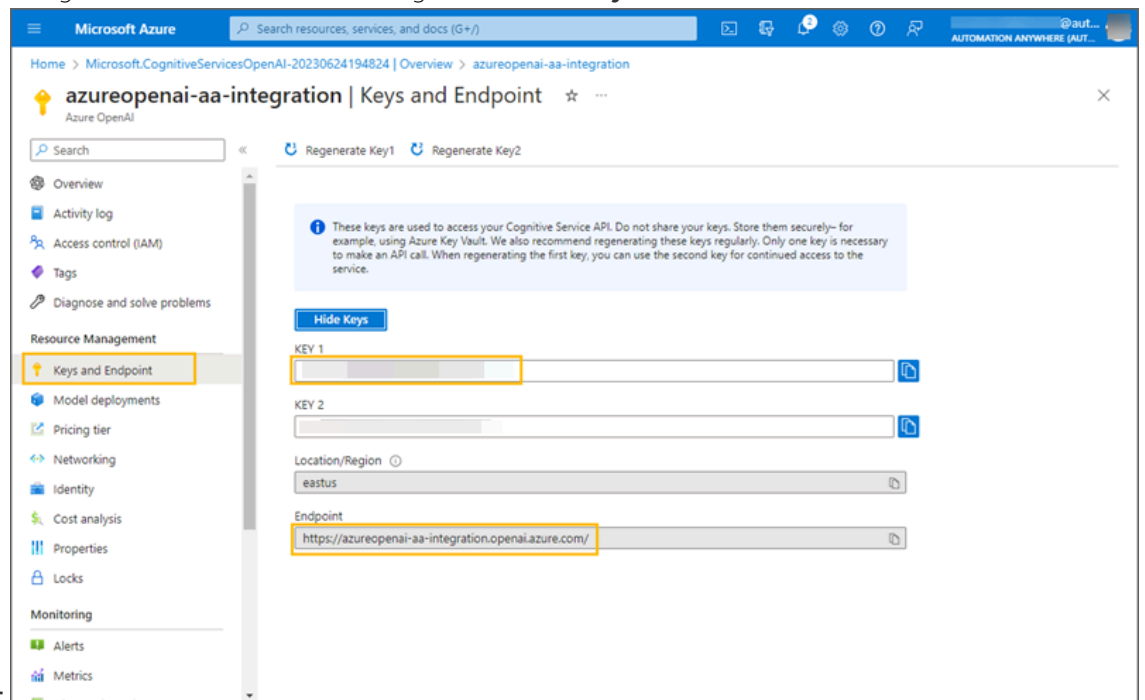

Endpoint.

12. Click **Show Keys**.
13. Copy the **API Key** (in the first key field) and the **Endpoint**.
14. Click **Model deployments** and then click **Manage Deployments** to navigate to the Azure OpenAI studio where you can create and deploy models. For more information on deploying a model, see [Deploy a model](#).
15. Copy the Model you deployed.

- You should have all the credentials to communicate with the Microsoft Azure OpenAI.
- Copy the **API Key**, **Endpoint**, and **Model** to use in the [Azure OpenAI: Chat AI action](#) on page 2651 and [Azure OpenAI: Prompt AI action](#) on page 2652.

## Authenticate action

This topic describes how to authenticate with the endpoint and API key to get access to the Microsoft Azure OpenAI models.

- You must have the Bot creator role to use the Microsoft Azure OpenAI Authenticate action in a bot.
- Ensure that you have the endpoint and API Key to send a request. For more information on obtaining these credentials, see [Configuring the Azure OpenAI](#) on page 2646 and [Azure OpenAI Service REST API reference](#).

To authenticate before using the Microsoft Azure OpenAI action:

- In the Automation Anywhere Control Room, navigate to the **Actions** pane, select **Generative AI > Microsoft Azure OpenAI**, drag **Authenticate**, and place it in the canvas.
- Do the

The screenshot shows the 'Microsoft OpenAI bot' configuration window. On the left, the 'Actions' pane is open, showing the 'Authenticate' action under 'Generative AI > Microsoft Azure OpenAI'. The main canvas displays a workflow starting with a 'Start' trigger, followed by the 'Generative AI: Authenticate' action, and then a 'Message box' output. The 'Authenticate' action is configured with the following fields:

- Endpoint:** https://...:openai.azure.com
- API key:** [Redacted] (Options: Credential, Variable, Insecure string)
- API version:** 2023-05-15
- Create AI session:** Local session (Options: Local session, Global session, Variable)
- Local session name:** Default

The workflow ends with a 'Message box' output displaying 'Sstr\_promptai\_response[0]\$'.

following:

- In the **Endpoint** field, enter the **Endpoint** from the Microsoft Azure portal.
- In the **API Key** field, paste the **API Key** copied from the Microsoft Azure portal.

**Note:** You can use one of the following options to specify the **API Key**:

- Credential:** To implement stronger security, you can use the Credential Vault.
- Variable:** To implement stronger security, you can use a credential variable.
- Insecure string:** Enables you to enter the API key directly.

- In the **API version** field, enter the **API version** to use for this operation. This follows the YYYY-MM-DD format.

- d) Enter Default as the session name to confine to the current session.

## Azure OpenAI: Chat AI action

The Azure OpenAI: Chat AI action uses Microsoft's ChatGPT and GPT-4 models to generate text in a chat-like format.

- You must have the Bot creator role to use the Azure OpenAI: Chat AI action in a bot.
- Ensure that you have the necessary credentials to send a request and have include [Authenticate action](#) on page 2650 before calling any Microsoft Azure OpenAI actions.

This example shows how to send a natural language message using the Azure OpenAI: Chat AI action and get an appropriate response.

- In the Automation Anywhere Control Room, navigate to the **Actions** pane, select **Generative AI > Microsoft Azure OpenAI**, drag **Azure OpenAI: Chat AI**, and place it in the canvas.
- Enter or select the following fields:

- a) For **Authenticate**, select **Latest version** to use the [Authenticate action](#) on page 2650 with the API Key.  
If you select **To be deprecated**, you can authenticate using the API Key without calling the Authenticate action.

**Note:** The **To be deprecated** option will be deprecated in the up coming release.

- b) Enter Default as the session name to confine to the current session.
- c) Enter the **Deployment ID**. The Deployment ID is linked to the large language model (LLM) you want to use for your prompt.
- d) Enter a chat **Message** to use by the model to generate a response.

**Note:** Chat actions retain the result of the previous chat action within the same session. If you call chat actions consecutively, the model can understand subsequent messages and relate them to the previous message. However, all chat history is deleted after the session ends.

---

- e) Enter the maximum number of tokens to generate. By default, if you do not enter a value, then the maximum number of tokens generated is automatically set to keep it within the maximum context length of the selected model by considering the length of the generated response.
  - f) Enter a **Temperature**. This value refers to the randomness of the response. As the temperature approaches zero, the response becomes more focused and deterministic. The higher the value, the more random is the response.
  - g) Enter Default as the session name to limit the session to the current session.
  - h) To manage the optional parameters, click the **Show more options** and select **Yes**. If you select Yes, you can add other parameters such as: **Top P**, **Stop**, **Presence Penalty**, **Frequency Penalty**, and **User**. For information about these optional parameters, see [Azure Open AI chat completions](#).
  - i) Save the response to a variable. In this example, in the response is saved to str\_chatai-response.
3. Click **Run** to start the bot. You can read the value of the field by printing the response in a Message box action. In this example, str\_chatai-response prints the response.
- 

**Tip:** To maintain multiple chats in the same bot, you will need to create multiple sessions with different names or variables.

---

## Azure OpenAI: Prompt AI action

The Azure OpenAI: Prompt AI action uses the Microsoft Azure AI's completions endpoint to generate text. This endpoint gives you access to the model's text input and output interface. You can give the model a text prompt in natural language, and it will generate a completion.

- You must have the Bot creator role to use the Azure OpenAI: Prompt AI action in a bot.
- Ensure that you have the necessary credentials to send a request and have include [Authenticate action](#) on page 2650 before calling any Microsoft Azure OpenAI actions.

This example shows how to send a natural language prompt using the Azure OpenAI: Prompt AI action and get an appropriate response.

1. In the Automation Anywhere Control Room, navigate to the **Actions** pane, select **Generative AI > Microsoft**, drag **Azure OpenAI: Prompt AI**, and place it in the canvas.
2. Enter or select the following fields:

The screenshot displays the configuration for the 'Generative AI: Azure OpenAI: Prompt AI' action. The flowchart on the left shows a sequence: Start -> Generative AI: Azure OpenAI: Prompt AI (step 2, highlighted) -> Message box (str\_promptai\_response[0]) -> End. The configuration panel on the right includes the following fields:

- a) Authenticate:** Latest version (To be deprecated)
- b) Session:** Default
- c) Deployment ID:** gpt-35-turbo-0301
- d) Prompt:** help me automate the process of onboarding new customers
- e) Max tokens:** 256
- f) Temperature:** 1
- g) Show more options:** Yes
- h) Response:** str\_promptai\_response

- a) For **Authenticate**, select **Latest version** to use the [Authenticate action](#) on page 2650 with the API Key.  
If you select **To be deprecated**, you can authenticate using the API Key without calling the Authenticate action.

**Note:** The **To be deprecated** option will be deprecated in the up coming release.

- b) Enter **Default** as the session name to limit the session to the current session.
- c) Enter the **Deployment ID**. The Deployment ID is linked to the large language model (LLM) you want to use for your prompt.
- d) Enter a **Prompt** to use by the model to generate a response.
- e) Enter the maximum number of tokens to generate. By default, if you do not enter a value, then the maximum number of tokens generated is automatically set to keep it within the maximum context length of the selected model by considering the length of the generated response.
- f) Enter a **Temperature**. This value refers to the randomness of the response. As the temperature approaches zero, the response becomes more focused and deterministic. The higher the value, the more random is the response.
- g) To manage the optional parameters, click the **Show more options** and select **Yes**, if you want to manage the optional parameters. If you select Yes, you can add other parameters such as: **API version**, **Suffix**, **Top P**, **N**, **Logprobs**, **Echo**, **Stop**, **Presence Penalty**, **Frequency Penalty**, **Best of**, **Logit bias**, and **User**. For more information about these optional parameters, see [Azure Open AI completions](#).
- h) Save the response to a variable. In this example, the response is saved to str\_promptai\_response.

3. Click **Run** to start the bot. The output of a prompt is a list where you can set **N** as the optional parameter, generate multiple prompts for each input. To read the response of the prompt, you can print the response in a Message box action. In this example, the first element of the list `str_promptai_response[0]` prints the response because N is set to 1.

## OpenAI

OpenAI models combines machine learning algorithms and deep learning techniques to train its generative AI systems. Automation Anywhere's OpenAI package connects seamlessly with OpenAI APIs to build automations using the OpenAI models.

Watch the following videos that illustrates an Open AI use case:

### Authenticate action

This topic describes how to generate an API Key to authenticate and get access to use the OpenAI models.

- You must have the Bot creator role to use the OpenAI Authenticate action in a bot.
- Ensure that you have the necessary credentials (API Key) to send a request.

To use OpenAI models, you send a request containing the inputs and your API key, and then get authenticated to use the models. The `Chat Completions API` and `Completions API` of OpenAI are both supported using the OpenAI Chat AI action and OpenAI Prompt AI action. The difference between these APIs derives from the underlying GPT models. To use either of these APIs, you will need to create an OpenAI API key.

To create an OpenAI API key:

1. Create an account at: [Create OpenAI Account](#).
2. Log in to your OpenAI account.
3. Access this link: [API-Keys](#).
4. Click **Create new secret key**.
5. Copy the secret to your clipboard.
6. In the Automation Anywhere Control Room, navigate to the **Actions** pane, select **Generative AI > OpenAI**, drag **Authenticate**, and place it in the canvas.

## 7. Do the

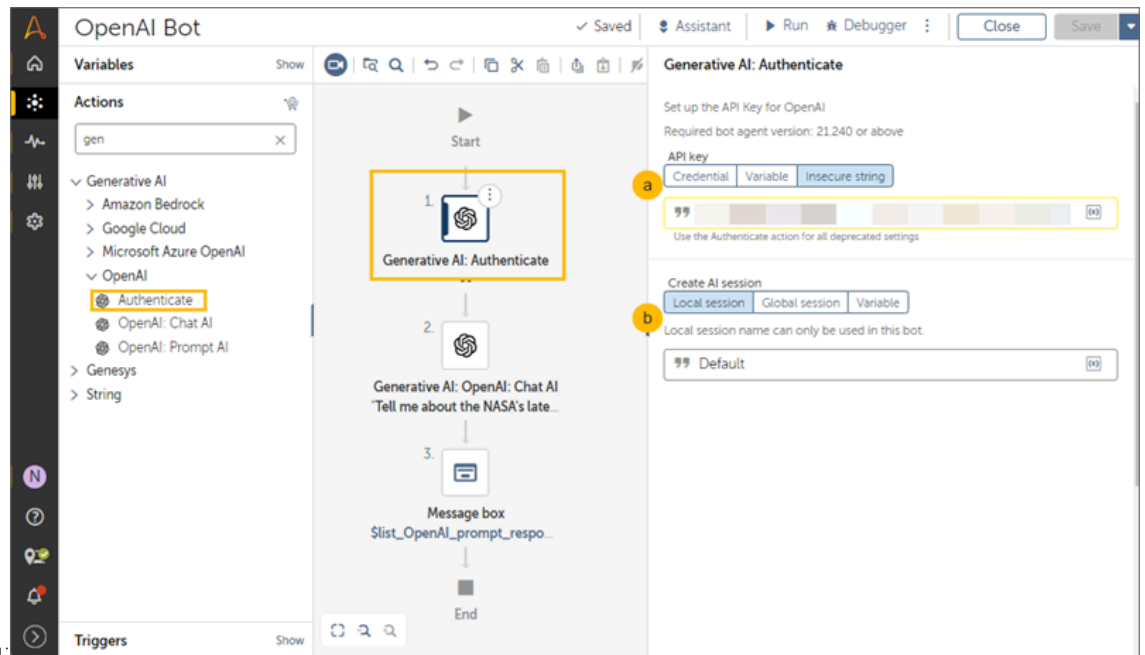

following:

- a) In the **API Key** field, paste the **API Key** copied.

**Note:** You can use one of the following options to specify the **API Key**:

- **Credential:** To implement stronger security, you can use the Credential Vault.
- **Variable:** To implement stronger security, you can use a credential variable.
- **Insecure string:** Enables you to enter the API key directly.

- b) Enter Default as the session name to confine to the current session.

## OpenAI: Chat AI action

The OpenAI: Chat AI action behaves like ChatGPT (a subset of generative AI) by taking a message as input and generating a response as output.

- You must have the Bot creator role to use the OpenAI Chat AI action in a bot.
- Ensure that you have the necessary credentials to send a request and have included [Authenticate action](#) on page 2654 before calling any OpenAI actions.

This example shows how to send a natural language message using the OpenAI Chat AI action and get an appropriate response.

1. In the Automation Anywhere Control Room, navigate to the **Actions** pane, select **Generative AI > OpenAI**, drag **OpenAI: Chat AI**, and place it in the canvas.
2. Enter or select the following fields:

- a) For **Authenticate**, select **Latest version** to use the [Authenticate action](#) on page 2654 with the API Key.  
If you select **To be deprecated**, you can authenticate using the API Key without calling the Authenticate action.

---

**Note:** The **To be deprecated** option will be deprecated in the up coming release.

---

- b) Enter Default as the session name to confine to the current session.
- c) Select a large language model (LLM) to use for your chat from the list of models listed in the dropdown. The model type defaults to **gpt-3.5-turbo**. You can also select the following models: **gpt-4**, **gpt-4-32k**, and **custom** to add your own custom model.
- d) Enter a chat **Message** to use by the model to generate a response.

---

**Note:** Chat actions retain the result of the previous chat action within the same session. If you call chat actions consecutively, the model can understand subsequent messages and relate them to the previous message. However, all chat history is deleted after the session ends.

---

- e) Enter the maximum number of tokens to generate. By default, if you do not enter a value, then the maximum number of tokens generated is automatically set to keep it within the maximum context length of the selected model by considering the length of generated response.
- f) Enter a **Temperature**. This value refers to the randomness of the response. As the temperature approaches zero, it makes the response more focused and deterministic. The higher the value, the more random is the response.



- g)** To manage the optional parameters, click **Show more options** and select **Yes**. If you select Yes, you can add other parameters such as: **Top P**, **Stop**, **Presence Penalty**, **Frequency Penalty**, and **User**. For information about these optional parameters, see [OpenAI Chat Create](#).
  - h)** Save the response to a variable. In this example, the response is saved to STR\_OpenAIChatResponse.
- 3.** Click **Run** to start the bot. You can read the value of the field by printing the response in a Message box action. In this example, STR\_OpenAIChatResponse prints the response.
- 

**Tip:** To maintain multiple chats in the same bot, you will need to create multiple sessions with different names or variables.

---

### OpenAI: Prompt AI action

The OpenAI: Prompt AI action mimics OpenAI's completions, by taking a prompt as input and returning a model-generated one or more predicted completions.

- You must have the Bot creator role to use the OpenAI Prompt AI action in a bot.
- Ensure that you have the necessary credentials to send a request and have included [Authenticate action](#) on page 2654 before calling any OpenAI actions.

This example shows how to send a natural language prompt using the OpenAI Prompt AI action and get an appropriate response.

- 1.** In the Automation Anywhere Control Room, navigate to the **Actions** pane, select **Generative AI > OpenAI**, drag **OpenAI: Prompt AI**, and place it in the canvas.
- 2.** Enter or select the following fields:

- a) For **Authenticate**, select **Latest version** to use the [Authenticate](#) action on page 2654 with the API Key.

If you select **To be deprecated**, you can authenticate using the API Key without calling the Authenticate action.

---

**Note:** The **To be deprecated** option will be deprecated in the up coming release.

---

- b) Enter **Default** as the session name to confine to the current session.
- c) Select a large language model (LLM) to use for your prompt from models listed in the drop-down. The model type defaults to **text-davinci-003**. You can also select the following models: **text-davinci-003**, **text-davinci-002**, **davinci**, **text-curie-001**, **curie**, **text-babbage-001**, **babbage**, **text-ada-001**, **ada**, and **custom** to add your own custom model.
- d) Enter a **Prompt** to use by the model to generate a response.
- e) Enter the maximum number of tokens to generate. By default, if you do not enter a value, then the maximum number of tokens generated is automatically set to keep it within the maximum context length of the selected model by considering the length of generated response.
- f) Enter a **Temperature**. This value refers to the randomness of the response. As the temperature approaches zero, it makes the response more focused and deterministic. The higher the value, the more random is the response.
- g) To manage the optional parameters, click the **Show more options** and select **Yes**. If you select Yes, you can add other parameters such as: **Suffix**, **Top P**, **N**, **Logprobs**,

**Echo, Stop, Presence Penalty, Frequency Penalty, Best of, Logit bias, and User.** For information about these optional parameters, see [Open AI completions](#).

- h) Save the response to a variable. In this example, the response is saved to `list_OpenAI_prompt_response`.
3. Click **Run** to start the bot. The output of a prompt is a list where you can set **N** as the optional parameter, generate multiple prompts for each input. To read the response of the prompt, you can print the response in a Message box action. In this example, the first element of the list `list_OpenAI_prompt_response[0]` prints the response because N is set to 1.

## Genesys package

Automate the repetitive tasks related to onboarding and updating the details of contacts by using the actions in the Genesys package.

### Intended use

The actions in the Genesys package are intended for use with the Automation Anywhere for Genesys integration. Currently, data cannot be passed directly from the integration to Genesys. These actions require a source data file to call from. You can then choose to manipulate the data by using variables or another worksheet before passing the final changes back to the Genesys source file. The actions included in this package are intended to offer automated solutions for common tasks.

### Actions in the Genesys package

Use the following actions in the Genesys package to automate common onboarding and updating tasks.

Action	Description
Authentication	Perform the required authentication for API connection. <a href="#">Authentication action in Genesys</a> on page 2660
Conversation	Call details of a conversation in Genesys. <a href="#">Conversation action in Genesys</a> on page 2661
Division	Perform actions related to division details, such as adding and removing roles to a division. <a href="#">Division palette</a> on page 2662
External contact	Perform actions such as adding and updating contact details. <a href="#">External contact palette</a> on page 2665
Group	Perform actions such as adding and deleting members from a group. <a href="#">Group palette</a> on page 2667
Language	Perform actions such as adding, listing, and removing routing languages. <a href="#">Language palette</a> on page 2670
External organization	Perform actions such as creating, updating, and deleting organizations. <a href="#">External organization palette</a> on page 2673

Action	Description
Phone	Perform actions such as assigning, creating, and removing phone records. <a href="#">Phone palette</a> on page 2675
Queues	Perform actions such as adding and removing selections from queues. <a href="#">Queues palette</a> on page 2679
Role	Perform actions such as adding, setting, and removing roles for users. <a href="#">Role palette</a> on page 2681
Skill	Perform actions such as adding, replacing, and removing skills. <a href="#">Skill palette</a> on page 2685
User	Perform actions such as creating, deleting, and getting users. <a href="#">User palette</a> on page 2689

## Authentication action in Genesys

The **OAuth authenticate** action calls your Genesys credential token and is required for the bot to connect with the API.

You can use different connection methods to connect to Genesys:

- **OAuth2 - Client Credentials:** Use this connection method by providing the Genesys credentials.
- **Control room OAuth connection:** Use this connection method by creating an OAuth connection and storing it in the Control Room.

### Procedure

1. Log in to the Control Room.
2. Create a new bot or edit an existing bot. For more details, see [Create your first bot](#) on page 1489.
3. From the Actions pane, select **Genesys > Authentication > OAuth authenticate** and place it under the **Start** of the bot flow.
4. In the **Authentication Type** field, select the authentication method from the drop-down list.
5. To connect using **OAuth2 - Client Credentials**, complete the following steps:
  - a) Enter the URL for the **Genesys cloud environment**.
  - b) Select how you would like your credentials passed.
    - Use **Credential** to pick a preconfigured credential locker.
    - Use **Variable** to select a preconfigured credential variable.
    - Use **Insecure string** to enter your credential in the field without encryption.
  - c) Enter the credential required to access the environment for the **Client ID**.
  - d) Select how you would like your secret passed.
    - Use **Credential** to pick a preconfigured credential locker.
    - Use **Variable** to select an established variable.

- Use **Insecure string** to enter your secret in the field without encryption.
  - e) Enter the secret code for the OAuth client used in credential grants for the **Client secret**.
6. To configure a **Control room OAuth connection** in Genesys, complete the following steps:
- a) Complete step 1 to step 5 in [Create OAuth connection](#) on page 1893.
  - b) Log in to your Genesys environment as an Admin.
  - c) Navigate to **Admin > Integrations > OAuth**.
  - d) Click **Add client**.
  - e) Enter the following information:
    - Name of the app.
    - Token duration (default will be 86400).
    - Select **Grant Types** as **Code Authorization**.
    - Add the Callback URL from [Create OAuth connection](#) on page 1893 as an authorized redirect URI.
- 
- Note:** For the OAuth connection to be successful you must provide the callback URL.
- 
- Click **Save**.
  - Copy the Client ID and Client Secret to use during authentication.
- f) Go to [Create OAuth connection](#) on page 1893 and complete the remaining steps to create an OAuth connection with the above details.
7. To connect using **Control room OAuth connection**, pick a custom connection you have created and stored in the Control Room. For more details, see [Configure OAuth connections in Control Room](#) on page 1889.
8. Enter the **Session name** for your changes to the repository.

## Conversation action in Genesys

Use the Get conversation action to call details on a conversation from Genesys.

### Settings

- Enter the **Conversation ID** of the conversation in Genesys that you want to call details for.
- Enter the **Session name**.
- Select how the outcome data will be saved.
  - If using **Multiple variables**, use the following steps for each variable:
    - Click **Add variable mapping**.
    - Enter the **Key** of the variable.
    - **Choose a variable** where the data will be saved.
    - Click **Add** for this division to be saved to the configured variable.

- If using a **Dictionary** variable, then select the established variable.

## Division palette

The Genesys package offers a palette of actions to detail and access the role of divisions.

### Division palette for Genesys

A division is a way to group and segregate objects while keeping them inside the same organization. For example, you can organize divisions by business unit, country, and office location and then assign respective objects that are configured for each individual division. After you organize and configure divisions, you can use roles to grant user access to division configurations and thus the objects within the respective division.

The Genesys package includes the following division actions:

Action	Description
Add role into division	Detail a role for a division. <a href="#">Add role into division action</a> on page 2662
Bulk-add roles into division	Detail multiple roles in a division. <a href="#">Bulk-add roles into division action</a> on page 2662
Bulk-remove roles for division	Delete multiple roles from a division. <a href="#">Bulk-remove roles for division action</a> on page 2663
Bulk-replace roles in division	Replace multiple roles in a division. <a href="#">Bulk-replace roles in division action</a> on page 2663
Get the home division	Retrieve the home division for the organization. <a href="#">Get the home division action</a> on page 2664
List/search divisions	Retrieve the home division for the organization. <a href="#">List/search divisions action</a> on page 2664
Remove role from division	Delete a grant of a role in a division. <a href="#">Remove role from division action</a> on page 2665

### Add role into division action

#### Settings

Detail a role for a division.

- Enter the ID of the user account for **Internal user ID**.
- Enter the ID of the division for **Division ID**.
- Enter the role of the division for **Role ID**.
- Enter the **Session name** for your changes to the repository.

### Bulk-add roles into division action

## Settings

Detail multiple roles in a division.

- Select how data is organized within your **Division dataset**.
  - If using a **Table**:
    - Click **Edit table** to create your table.
    - Enter the data into the cells of your table.
  - If using **Variable**, then select the established variable of the data to be added to the division.
- Select the proper ID of the first, second, and third columns. These must correspond with the User, Role, and Division IDs of your dataset.
- Enter the **Session name** for your changes to the repository.
- Optionally, **Choose a variable** where the data will be saved.

## Bulk-remove roles for division action

### Settings

Delete multiple roles from a division.

- Select how data is organized within your **Division dataset**.
  - If using a **Table**:
    - Click **Edit table** to create your table.
    - Enter the data into the cells of your table.
  - If using **Variable**, then select the established variable of the data to be removed from the division.
- Select the proper ID of the first, second, and third columns. These must correspond with the User, Role, and Division IDs of your dataset.
- Enter the **Session name** for your changes to the repository.
- Optionally, **Choose a variable** where the data will be saved.

## Bulk-replace roles in division action

### Settings

Replace multiple roles in a division.

- Select how data is organized within your **Division dataset**.
  - If using a **Table**:
    - Click **Edit table** to create your table.
    - Enter the data into the cells of your table.
  - If using **Variable**, then select the established variable of the data to replace in the division.

- Select the proper ID of the first, second, and third columns to map the corresponding User, Role, and Division IDs of your dataset.
- Enter the **Session name** for your changes to the repository.
- Optionally, **Choose a variable** where the data will be saved.

## Get the home division action

### Settings

Retrieve the home division for the organization.

- Enter the **Session name** for your changes to the repository.
- Select how the outcome data will be saved.
  - If using **Multiple variables**, use the following steps for each variable:
    - Click **Add variable mapping**.
    - Enter the **Key** of the variable.
    - **Choose a variable** where the data will be saved.
    - Click **Add** for this division to be saved to the configured variable.
  - If using a **Dictionary** variable, then select the established variable.

## List/search divisions action

Retrieve a list of all divisions defined for the organization.

### Settings

- Optionally, enter the **Division name**.
- Enter the **Session name** for your changes to the repository.
- **Choose a variable** where the data will be saved.

---

**Note:** The output is retrieved as a list of type . To read an individual record (row) in this list, you need to loop through all the dictionary items using the action and read or extract the records (rows) individually. For example, the output of get multiple records is saved in the variable list\_of\_records\_any. If the variable contains five



records, then each record is passed to the Loop action to be processed one at a

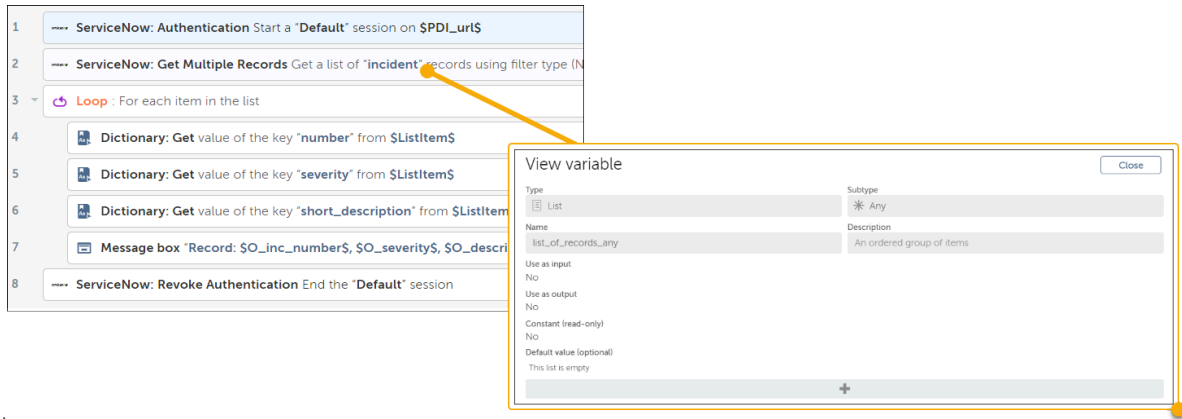

time.

## Remove role from division action

### Settings

Delete a grant of a role in a division.

- Enter the ID of the user account for **Internal user ID**.
- Enter the ID of the division for **Division ID**.
- Enter the role of the division for **Role ID**.
- Enter the **Session name** for your changes to the repository.

## External contact palette

The Genesys package offers a palette of actions to detail and access data for external contact records.

### External Contact palette for Genesys

An external contact includes a comprehensive repository of data relevant to making contact with an individual or external organization. From an external contact record, you have a streamlined view of all contact and organization data.

Detail as much or as little relevant data beyond the first and last name of the contact. Optional data can include salutation, title, external organization ID, multiple phones, addresses, and an external system URL.

**Note:** When providing the organization ID that represents an external organization in Genesys, the contact will be linked to that org.

The Genesys package includes the following external contact actions:

Action	Description
Create contact	Add details of a new contact. <a href="#">Create contact action</a> on page 2666

Action	Description
Delete contact	Delete an external contact. <a href="#">Delete contact action in Genesys</a> on page 2666
List/search contacts	Find and view specific contacts that match your search query. <a href="#">List/search contacts action</a> on page 2666
Update contact	Update the details for an external contact. <a href="#">Update contact action</a> on page 2667

## Create contact action

Add details of a new contact.

### Settings

- Enter the first name.
- Enter the last name.
- Enter optional data.
- Select **Yes** or **No** for the **Survey opt out**.
- Enter the **Session name** for your changes to the repository.
- Optionally, **Choose a variable** where the external contact ID will be saved.

## Delete contact action in Genesys

Delete an external contact.

### Settings

- Enter the **External contact ID**.
- Enter the **Session name** for your changes to the repository.

## List/search contacts action

Find and view specific contacts that match your search query.

### Settings

- Optionally, enter the **External contact ID**.
- Optionally, enter keywords for your **Search query**.
- Enter the **Session name** for your changes to the repository.
- **Choose a variable** where the outcome data will be saved.
- **Note:** The output is retrieved as a list of type `dict`. To read an individual record (row) in this list, you need to loop through all the dictionary items using the `read` action and read

or extract the records (rows) individually. For example, the output of get multiple records is saved in the variable list\_of\_records\_any. If the variable contains five records, then each record is passed to the Loop action to be processed one at a

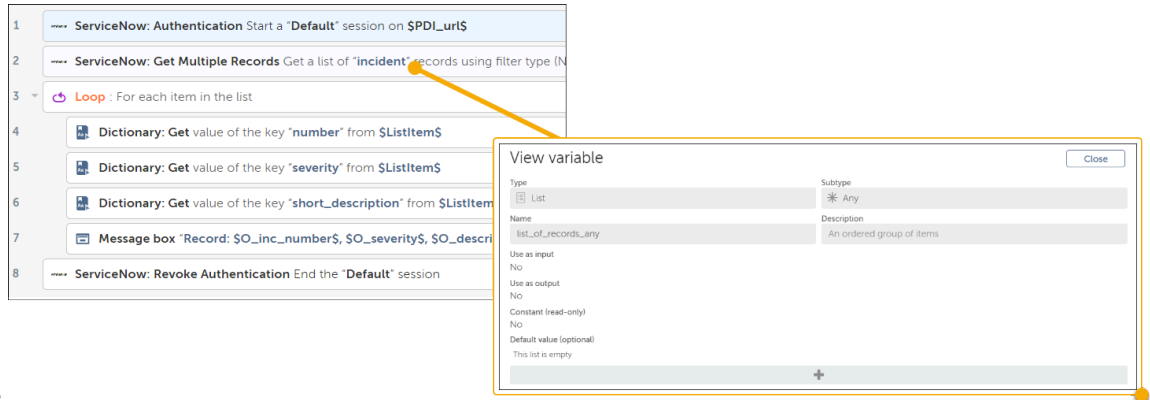

time.

## Update contact action

Update the details for an external contact.

## Settings

- Enter the **External contact ID** of the record that you want to update.
- Enter the first name
- Enter the last name
- Enter optional data.
- Select **Yes** or **No** for **Survey opt out**.
- Enter the **Session name** for your changes to the repository.

## Group palette

The Genesys package offers a palette of actions to detail and access data for grouping records.

## Group palette for Genesys

Groups organize people with similar traits. For example, users that share skills, locations, or other information maintained in Genesys Cloud can be grouped for organizational functions.

Groups can be work-related or social to assist in project and priorities. Examples of groups include the following:

- Subject Matter Experts (SMEs): A group of SMEs can let others in the organization know the most current information.
- Projects: Groups related to projects streamline information to the team and expedite updates and planning.
- Locations: Groups can simplify communication for geographical updates and events.

The Genesys package includes the following group actions:

---

Action	Description
Bulk-add members into group	Add multiple members into a group. <a href="#">Bulk-add members into group action</a> on page 2668
Delete member	Delete a member from a group. <a href="#">Delete member action in Genesys</a> on page 2668
List groups	View all groups. <a href="#">List groups action</a> on page 2668
List members	List all the members in a specific group. <a href="#">List members (Group) action</a> on page 2669

## Bulk-add members into group action

Add multiple members into a group.

### Settings

- Enter the **Group ID**.
- Select how the data will be entered to begin adding user data.
  - If using a **List**:
    - Select the data **Type**.
    - Enter the **Value** of the data in the list.
  - If using **Variable**, then select the established variable of the data to be entered in the group.
- Enter the **Session name** for your changes to the repository.

## Delete member action in Genesys

Delete a member from a group.

### Settings

- Enter the **Group ID**.
- Select how the data will be entered to begin deleting user data from the group.
  - If using a **List**:
    - Select the data **Type**.
    - Enter the **Value** of the data in the list.
  - If using **Variable**, then select the established variable of the data to be deleted from the group.
- Enter the **Session name** for your changes to the repository.

## List groups action

View all groups.

## Settings

- Enter the **Session name** for your changes to the repository.
- **Choose a variable** where the outcome data will be saved.

**Note:** The output is retrieved as a list of type . To read an individual record (row) in this list, you need to loop through all the dictionary items using the action and read or extract the records (rows) individually. For example, the output of get multiple records is saved in the variable list\_of\_records\_any. If the variable contains five records, then each record is passed to the Loop action to be processed one at a

The screenshot shows an automation workflow with the following steps:

- ServiceNow: Authentication Start a "Default" session on \$PDI\_url\$
- ServiceNow: Get Multiple Records Get a list of "incident" records using filter type (N
- Loop : For each item in the list
- Dictionary: Get value of the key "number" from \$ListItem\$
- Dictionary: Get value of the key "severity" from \$ListItem\$
- Dictionary: Get value of the key "short\_description" from \$ListItem\$
- Message box "Record: \$O\_inc\_number\$, \$O\_severity\$, \$O\_descri
- ServiceNow: Revoke Authentication End the "Default" session

The 'View variable' dialog box shows the following details:

Type	Subtype
List	* Any
Name	Description
list_of_records_any	An ordered group of items
Use as input	No
Use as output	No
Constant (read-only)	No
Default value (optional)	This list is empty

time.

## List members (Group) action

List all the members in a specific group.

## Settings

- Enter the **Group ID**.
- Enter the **Session name** for your changes to the repository.
- **Choose a variable** where the outcome data will be saved.

**Note:** The output is retrieved as a list of type . To read an individual record (row) in this list, you need to loop through all the dictionary items using the action and read or extract the records (rows) individually. For example, the output of get multiple records is saved in the variable list\_of\_records\_any. If the variable contains five

records, then each record is passed to the Loop action to be processed one at a

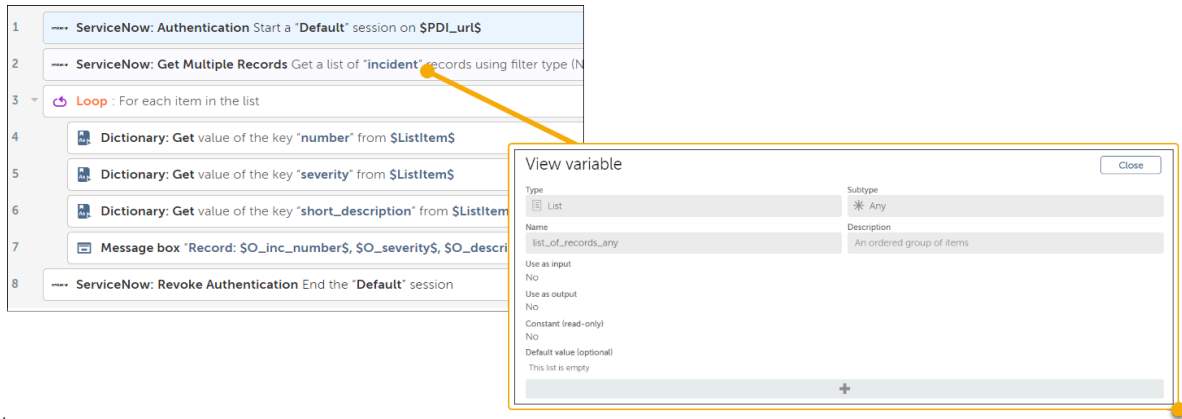

time.

## Language palette

The Genesys package offers a palette of actions to detail languages for call-routing purposes.

### Language palette for Genesys

Languages are separate from Automatic Call Distribution (ACD) skills. For example, Genesys Cloud will prioritize an agent that speaks the language requested by the customer over an agent who is more skilled but cannot speak the requested language. An agent that cannot speak the language of the customer does not receive that interaction regardless of ACD skill.

Attributing users with languages empowers your team to handle diverse calls with effective communication. The Genesys package includes the following language actions:

Action	Description
Add routing language	Add a routing language to a user. <a href="#">Add routing language action</a> on page 2671
Bulk-add routing languages to user	Attribute multiple users with languages. <a href="#">Bulk-add routing languages to user action</a> on page 2671
List user's routing languages	List the languages attributed to a user. <a href="#">List user's routing languages action</a> on page 2671
List all routing languages	List all the supported languages. <a href="#">List all routing languages action</a> on page 2672
Remove routing language from user	Remove an attributed language from a user. <a href="#">Remove routing language from user action</a> on page 2673

## Add routing language action

Add a routing language to a user.

### Settings

- Enter a unique user ID for the **Internal user ID**.
- Enter the **Language ID** that is to be added to the user.
- Enter the user's language **Proficiency** with a value of 0-5. Zero is low proficiency.
- Enter the **Session name** for your changes to the repository.

## Bulk-add routing languages to user action

Attribute multiple users with languages.

### Settings

- Select how the dataset will be entered.
  - If using a **Table**:
    - Click **Edit table** to create your table.
    - Enter the data of the cells for your table.
  - If using **Variable**, then select the established variable of the data to be added to the user.
- Select the proper ID of the first, second, and third columns to map the corresponding User, Role, and Division IDs of your dataset.
- Enter the **Session name** for your changes to the repository.
- Optionally, **Choose a variable** where the outcome data will be saved.

## List user's routing languages action

List the languages attributed to a user.

### Settings

- Enter the unique user ID for the **Internal user ID**.
- Enter the **Session name** for your changes to the repository.
- **Choose a variable** where the outcome data will be saved.

---

**Note:** The output is retrieved as a list of type `list`. To read an individual record (row) in this list, you need to loop through all the dictionary items using the `get` action and read or extract the records (rows) individually. For example, the output of `get multiple records` is saved in the variable `list_of_records_any`. If the variable contains five

records, then each record is passed to the Loop action to be processed one at a

The screenshot shows an automation workflow with the following steps:

- ServiceNow: Authentication Start a "Default" session on \$PDI\_url\$
- ServiceNow: Get Multiple Records Get a list of "incident" records using filter type (N
- Loop : For each item in the list
- Dictionary: Get value of the key "number" from \$ListItem\$
- Dictionary: Get value of the key "severity" from \$ListItem\$
- Dictionary: Get value of the key "short\_description" from \$ListItem\$
- Message box "Record: \$O\_inc\_number\$, \$O\_severity\$, \$O\_descri
- ServiceNow: Revoke Authentication End the "Default" session

A yellow arrow points from the 'Loop' action to a 'View variable' dialog box. The dialog box shows the following details for the variable:

Type	Subtype
List	Any
Name	Description
list_of_records_any	An ordered group of items

Additional properties shown in the dialog:

- Use as input: No
- Use as output: No
- Constant (read-only): No
- Default value (optional): This list is empty

time.

## List all routing languages action

List all the supported languages.

## Settings

- Enter the **Session name** for your changes to the repository.
- **Choose a variable** where the outcome data will be saved.

**Note:** The output is retrieved as a list of type . To read an individual record (row) in this list, you need to loop through all the dictionary items using the action and read or extract the records (rows) individually. For example, the output of get multiple records is saved in the variable list\_of\_records\_any. If the variable contains five records, then each record is passed to the Loop action to be processed one at a

The screenshot shows an automation workflow with the following steps:

- ServiceNow: Authentication Start a "Default" session on \$PDI\_url\$
- ServiceNow: Get Multiple Records Get a list of "incident" records using filter type (N
- Loop : For each item in the list
- Dictionary: Get value of the key "number" from \$ListItem\$
- Dictionary: Get value of the key "severity" from \$ListItem\$
- Dictionary: Get value of the key "short\_description" from \$ListItem\$
- Message box "Record: \$O\_inc\_number\$, \$O\_severity\$, \$O\_descri
- ServiceNow: Revoke Authentication End the "Default" session

A yellow arrow points from the 'Loop' action to a 'View variable' dialog box. The dialog box shows the following details for the variable:

Type	Subtype
List	Any
Name	Description
list_of_records_any	An ordered group of items

Additional properties shown in the dialog:

- Use as input: No
- Use as output: No
- Constant (read-only): No
- Default value (optional): This list is empty

time.



## Remove routing language from user action

Remove an attributed language from a user.

### Settings

- Enter the unique user ID for the **Internal user ID**.
- Enter the **Language ID** to be removed.
- Enter the **Session name** for your changes to the repository.

## External organization palette

The Genesys package offers a palette of actions to detail and access data for external organization records.

### External organization palette for Genesys

External organizations are your customers, partners, and other businesses that you interact with. An organization (org) can also be considered an account and is related to External Contacts in that contacts belong to an org. Simply put, contacts are customers and the relationship defines what business a contact might be calling about. Allowing an agent to view customer information and the org of the customer help the agent to quickly understand the relevant business details to best serve their needs. Therefore, having the org details available to bots can enable workflows, such as automatically importing account data into Genesys from other systems, using Genesys Org details to look up open cases for the account from an external case management tool, and so on.

Similar to contacts, you can detail as much or as little relevant data beyond the name of the org. Optional data can include company type, industry, multiple phones, addresses, tags, and websites. The Genesys package includes the following external organization actions:

Action	Description
Create organization	Create the initial external organization record. <a href="#">Create organization action</a> on page 2674
Delete organization	Delete a record of an external organization. <a href="#">Delete organization action</a> on page 2674
Get organization	Call the details of an external organization record. <a href="#">Get organization action</a> on page 2674
List/search organizations	Call a list of external organizations that match your search query. <a href="#">List/search organizations action</a> on page 2674
Update organization	Update an external organization record with new or additional data. <a href="#">Update organization action</a> on page 2675

## Create organization action

Create the initial external organization record.

### Settings

- Enter the **Name** of the org.
- Enter the optional data.
- Select whether the org approved to be contacted through **Phone SMS**.
- Select whether the org approved to be contacted through **Fax SMS**.
- Enter the **Session name** for your changes to the repository.
- Optionally, **Choose a variable** where the org ID can be saved.

## Delete organization action

Delete a record of an external organization.

### Settings

- Enter the **ID** for the external organization.
- Enter the **Session name** for your changes to the repository.

## Get organization action

Call the details of an external organization record.

### Settings

- Enter the **ID** for the external organization.
- Enter the **Session name** for your changes to the repository.
- Select how the outcome data will be saved.
  - If using **Multiple variables**, use the following steps for each variable:
    - Click **Add variable mapping**.
    - Enter the **Key** of the variable.
    - **Choose a variable** where the data will be saved.
    - Click **Add** for this data to be saved to the configured variable.
  - If using a **Dictionary** variable, then select the established variable where the outcome data can be saved.

## List/search organizations action

Call a list of external organizations that match your search query.

## Settings

- Optionally, enter keywords for your **Search query**.
- Enter the **Session name** for your changes to the repository.
- **Choose a variable** where the outcome data will be saved.

**Note:** The output is retrieved as a list of type . To read an individual record (row) in this list, you need to loop through all the dictionary items using the action and read or extract the records (rows) individually. For example, the output of get multiple records is saved in the variable list\_of\_records\_any. If the variable contains five records, then each record is passed to the Loop action to be processed one at a

The screenshot shows an automation workflow with the following steps:

- ServiceNow: Authentication Start a "Default" session on \$PDI\_urls
- ServiceNow: Get Multiple Records Get a list of "incident" records using filter type (N
- Loop : For each item in the list
- Dictionary: Get value of the key "number" from \$ListItem\$
- Dictionary: Get value of the key "severity" from \$ListItem\$
- Dictionary: Get value of the key "short\_description" from \$ListItem\$
- Message box "Record: \$O\_inc\_number\$, \$O\_severity\$, \$O\_descri
- ServiceNow: Revoke Authentication End the "Default" session

An orange arrow points from the "Get Multiple Records" step to the "View variable" dialog. The dialog shows the following details:

Type	Subtype
List	Any
Name	Description
list_of_records_any	An ordered group of items
Use as input	No
Use as output	No
Constant (read-only)	No
Default value (optional)	This list is empty

time.

## Update organization action

Update an external organization record with new or additional data.

## Settings

- Enter the **ID** of the external organization record.
- Enter the **Name** of the org.
- Enter the optional data.
- Select whether the org approved contact through **Phone SMS**.
- Select whether the org approved contact through **Fax SMS**.
- Enter the **Session name** for your changes to the repository.

## Phone palette

The Genesys package offers a palette of actions to detail and access data for phone records.

## Phone palette for Genesys

Genesys Cloud supports the WebRTC technology with the Genesys Cloud WebRTC phone. The Genesys Cloud WebRTC phone runs from a browser, that is, there are no special hardware

requirements or software to download. When the Genesys Cloud WebRTC phone is enabled, you can immediately use it to make and receive calls. It is an important part of the onboarding process that phones be created and assigned to agents so that calls are effectively routed from the queue to agents.

Configuring a Genesys Cloud WebRTC phone is a two-step operation. First, base settings must be created and configured by the admin and must already be established. Second, the phone is created and configured to retrieve established base settings. These secondary tasks can be automated. The Genesys package includes the following phone actions:

Action	Description
Assign phone	Assign a phone line to a user. <a href="#">Assign phone action</a> on page 2676
Create a phone	Create a phone record. <a href="#">Create a phone action</a> on page 2676
List phone base settings	Get a list of phone base settings. <a href="#">List phone base settings action</a> on page 2677
List/search phones	Get a list of phones. <a href="#">List/search phones action</a> on page 2677
List/search sites	Get a list of sites. <a href="#">List/search sites action</a> on page 2678
Remove a phone	Remove a phone record. <a href="#">Remove a phone action</a> on page 2679

## Assign phone action

Assign a phone line to a user.

### Settings

- Enter a unique user ID for the **Internal user ID**.
- Enter a line ID to assign the **Phone's line ID** to the user.
- Enter the **Session name** for your changes to the repository.

## Create a phone action

Create a phone record.

### Settings

- Enter a **Name** for the phone.
- Enter the **Phone base setting ID** to route the preconfigured base settings.
- Enter the **Site ID** where the phone is located.
- Enter the **Web rtc user ID** of the WebRTC user.
- Enter the **Session name** for your changes to the repository.
- Optionally, **Choose a variable** for the Phone ID.
- Optionally, **Choose a variable** for the Phone's line ID.

## List phone base settings action

Get a list of phone base settings.

### Settings

- Optionally, enter a **Name** for the list.
- Enter the **Session name** for your changes to the repository.
- **Choose a variable** where the outcome data can be saved.

**Note:** The output is retrieved as a list of type . To read an individual record (row) in this list, you need to loop through all the dictionary items using the action and read or extract the records (rows) individually. For example, the output of get multiple records is saved in the variable list\_of\_records\_any. If the variable contains five records, then each record is passed to the Loop action to be processed one at a

The screenshot shows an automation workflow with the following steps:

- ServiceNow: Authentication Start a "Default" session on SPDI\_urls
- ServiceNow: Get Multiple Records Get a list of "incident" records using filter type (N
- Loop : For each item in the list
- Dictionary: Get value of the key "number" from \$ListItem\$
- Dictionary: Get value of the key "severity" from \$ListItem\$
- Dictionary: Get value of the key "short\_description" from \$ListItem\$
- Message box "Record: \$O\_inc\_number\$, \$O\_severity\$, \$O\_descri
- ServiceNow: Revoke Authentication End the "Default" session

The 'View variable' dialog box shows the following details:

Type	Subtype
List	Any
Name	Description
list_of_records_any	An ordered group of items
Use as input	No
Use as output	No
Constant (read-only)	No
Default value (optional)	This list is empty

time.

## List/search phones action

Get a list of phones.

### Settings

- Optionally, enter a **Name** for the list.
- Enter the **Session name** for your changes to the repository.
- **Choose a variable** where the outcome data can be saved.

**Note:** The output is retrieved as a list of type . To read an individual record (row) in this list, you need to loop through all the dictionary items using the action and read or extract the records (rows) individually. For example, the output of get multiple records is saved in the variable list\_of\_records\_any. If the variable contains five

records, then each record is passed to the Loop action to be processed one at a

The screenshot shows an automation workflow with the following steps:

- ServiceNow: Authentication Start a "Default" session on \$SPDI\_url\$
- ServiceNow: Get Multiple Records Get a list of "incident" records using filter type (N
- Loop : For each item in the list
- Dictionary: Get value of the key "number" from \$ListItem\$
- Dictionary: Get value of the key "severity" from \$ListItem\$
- Dictionary: Get value of the key "short\_description" from \$ListItem\$
- Message box "Record: \$O\_inc\_number\$, \$O\_severity\$, \$O\_descri
- ServiceNow: Revoke Authentication End the "Default" session

The 'View variable' dialog box shows the following details:

Type	Subtype
List	Any
Name	Description
list_of_records_any	An ordered group of items

Additional properties shown in the dialog:

- Use as input: No
- Use as output: No
- Constant (read-only): No
- Default value (optional): This list is empty

time.

## List/search sites action

Get a list of sites.

## Settings

- Optionally, enter a **Name** for the list.
- Enter the **Session name** for your changes to the repository.
- **Choose a variable** where the outcome data can be saved.

**Note:** The output is retrieved as a list of type . To read an individual record (row) in this list, you need to loop through all the dictionary items using the action and read or extract the records (rows) individually. For example, the output of get multiple records is saved in the variable list\_of\_records\_any. If the variable contains five records, then each record is passed to the Loop action to be processed one at a

The screenshot shows an automation workflow with the following steps:

- ServiceNow: Authentication Start a "Default" session on \$SPDI\_url\$
- ServiceNow: Get Multiple Records Get a list of "incident" records using filter type (N
- Loop : For each item in the list
- Dictionary: Get value of the key "number" from \$ListItem\$
- Dictionary: Get value of the key "severity" from \$ListItem\$
- Dictionary: Get value of the key "short\_description" from \$ListItem\$
- Message box "Record: \$O\_inc\_number\$, \$O\_severity\$, \$O\_descri
- ServiceNow: Revoke Authentication End the "Default" session

The 'View variable' dialog box shows the following details:

Type	Subtype
List	Any
Name	Description
list_of_records_any	An ordered group of items

Additional properties shown in the dialog:

- Use as input: No
- Use as output: No
- Constant (read-only): No
- Default value (optional): This list is empty

time.

## Remove a phone action

Remove a phone record.

### Settings

- Enter the **Phone ID** to be removed.
- Enter the **Session name** for your changes to the repository.

## Queues palette

The Genesys command package offers a palette of actions to detail and access data for grouping records.

### Queues palette for Genesys

Queues are the waiting lines of interactions. Agents select the **On Queue** status to enter their predefined queues. Contact center queue settings include creating and managing queues for voice and chat channels for the entire organization. The Genesys package includes the following queues actions:

Action	Description
Add to queue	Add selection to queue. <a href="#">Add to queue action in Genesys</a> on page 2679
List members	List the members of a queue. <a href="#">List members (Queues) action</a> on page 2680
List/search queues	Retrieve a list of queues that match your input criteria. <a href="#">List/search queues action</a> on page 2680
Remove from queue	Remove selected users from a queue. <a href="#">Remove from queue action</a> on page 2681

### Add to queue action in Genesys

Add selection to queue.

### Settings

- Enter the **Session name** for your changes to the repository.
- Enter the **Queue ID** of the queue that you want to add.
- Select how the data will be entered to begin adding user data to the queue.
  - If using a **List**:
    - Select the data **Type**.
    - Enter the **Value** of the data in the list.

- If using **Variable**, then select the established variable of the data to be entered in the queue.

## List members (Queues) action

List the members of a queue.

### Settings

- Enter the **Session name** for your changes to the repository.
- Enter the **Queue ID** of the queue that you want to add.
- **Choose a variable** where the outcome data can be saved.

**Note:** The output is retrieved as a list of type . To read an individual record (row) in this list, you need to loop through all the dictionary items using the action and read or extract the records (rows) individually. For example, the output of get multiple records is saved in the variable list\_of\_records\_any. If the variable contains five records, then each record is passed to the Loop action to be processed one at a

The screenshot shows an automation workflow with the following steps:

- ServiceNow: Authentication Start a "Default" session on \$PDI\_url\$
- ServiceNow: Get Multiple Records Get a list of "incident" records using filter type (N
- Loop : For each item in the list
- Dictionary: Get value of the key "number" from \$ListItem\$
- Dictionary: Get value of the key "severity" from \$ListItem\$
- Dictionary: Get value of the key "short\_description" from \$ListItem\$
- Message box "Record: \$O\_inc\_number\$, \$O\_severity\$, \$O\_descri
- ServiceNow: Revoke Authentication End the "Default" session

An orange arrow points from the 'Get Multiple Records' step to the 'View variable' dialog box. The dialog box shows the following details:

Type	Subtype
List	Any
Name	Description
list_of_records_any	An ordered group of items
Use as input	No
Use as output	No
Constant (read-only)	No
Default value (optional)	This list is empty

time.

## List/search queues action

Retrieve a list of queues that match your input criteria.

### Settings

- Optionally, enter a **Name** for the list.
- Enter the **Session name** for your changes to the repository.
- **Choose a variable** where the outcome data can be saved.

**Note:** The output is retrieved as a list of type . To read an individual record (row) in this list, you need to loop through all the dictionary items using the action and read or extract the records (rows) individually. For example, the output of get multiple records is saved in the variable list\_of\_records\_any. If the variable contains five



records, then each record is passed to the Loop action to be processed one at a

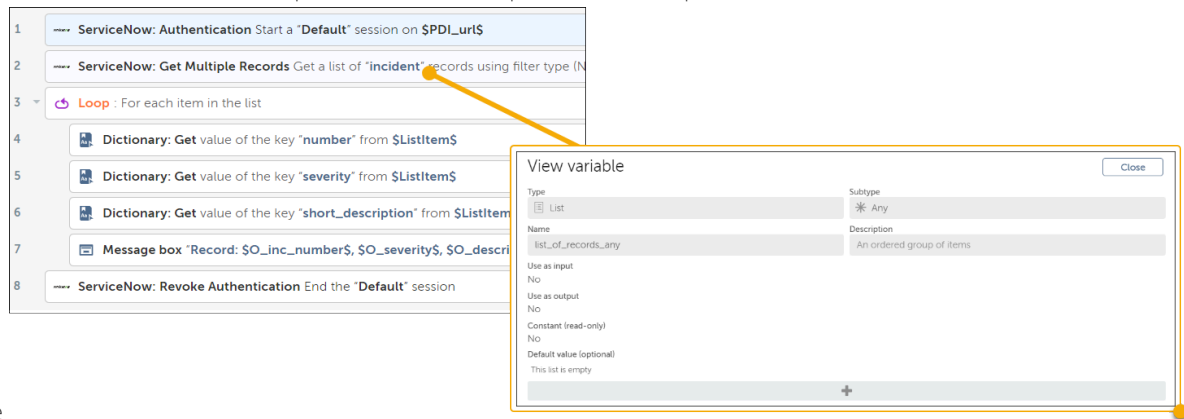

time.

## Remove from queue action

Remove selected users from a queue.

## Settings

- Enter the **Session name** for your changes to the repository.
- Enter the **Queue ID** for the queue that you want to remove users from.
- Select how the data will be entered to begin adding user data to the queue.
  - If using a **List**:
    - Select the data **Type**.
    - Enter the **Value** of the data in the list.
  - If using **Variable**, then select the established variable of the data to be entered in the queue.

## Role palette

The Genesys package offers a palette of actions to detail and access data for the roles of users.

## Role palette for Genesys

Because permissions are based on the assigned role, the role of users is important in the onboarding process. Tasks are then assigned based on the permissions that a user has. The Genesys package includes the following role actions:

Action	Description
Add users to role	Add a list of users to a role. <a href="#">Add users to role action</a> on page 2682
List/search roles	Retrieve a list of roles for the organization. <a href="#">List/search roles action</a> on page 2682

Action	Description
List user's roles	Retrieve a list of roles and permissions for a user. <a href="#">List user's roles action</a> on page 2683
List users in a role	Retrieve a list of the unique user IDs of the users in the specified role. <a href="#">List users in a role action</a> on page 2684
Remove users from role	Remove a list of users from a specific role. <a href="#">Remove users from role action</a> on page 2685
Set the user's roles	Set the roles for a specific user. <a href="#">Set the user's roles action in Genesys</a> on page 2685

### Add users to role action

Add a list of users to a role.

#### Settings

- Enter the **Role ID** of the role that you want to add users to.
- Select how the data will be entered to begin adding user data to the role.
  - If using a **List**:
    - Select the data **Type**.
    - Enter the **Value** of the data in the list.
  - If using **Variable**, then select the established variable of the data to be added to the role.
- Enter the **Session name** for your changes to the repository.

### List/search roles action

Retrieve a list of roles for the organization.

#### Settings

- Optionally, enter the **Role name** for the list.
- Enter the **Session name** for your changes to the repository.
- **Choose a variable** where the outcome data can be saved.

---

**Note:** The output is retrieved as a list of type . To read an individual record (row) in this list, you need to loop through all the dictionary items using the action and read or extract the records (rows) individually. For example, the output of get multiple records is saved in the variable list\_of\_records\_any. If the variable contains five

records, then each record is passed to the Loop action to be processed one at a

The screenshot shows an automation workflow with the following steps:

- ServiceNow: Authentication Start a "Default" session on \$PDI\_url\$
- ServiceNow: Get Multiple Records Get a list of "incident" records using filter type (N
- Loop : For each item in the list
- Dictionary: Get value of the key "number" from \$ListItem\$
- Dictionary: Get value of the key "severity" from \$ListItem\$
- Dictionary: Get value of the key "short\_description" from \$ListItem\$
- Message box "Record: \$O\_inc\_number\$, \$O\_severity\$, \$O\_descri
- ServiceNow: Revoke Authentication End the "Default" session

A yellow arrow points from the 'Loop' action to a 'View variable' dialog box. The dialog box shows the following details for the variable 'list\_of\_records\_any':

Type	Subtype
List	Any
Name	Description
list_of_records_any	An ordered group of items

Additional properties shown in the dialog:

- Use as input: No
- Use as output: No
- Constant (read-only): No
- Default value (optional): This list is empty

time.

## List user's roles action

Retrieve a list of roles and permissions for a user.

## Settings

- Enter the unique ID of the user for the **Internal user ID**.
- Enter the **Session name** for your changes to the repository.
- Select how the outcome data will be saved.
  - If using **Multiple variables**, use the following steps for each variable:
    - Click **Add variable mapping**.
    - Enter the **Key** of the variable.
    - **Choose a variable** where the data will be saved.
    - Click **Add** for this list to be saved to the configured variable.
  - If using a **Dictionary** variable, then select the established variable where the outcome data can be saved.

**Note:** The output is retrieved as a list of type . To read an individual record (row) in this list, you need to loop through all the dictionary items using the action and read or extract the records (rows) individually. For example, the output of get multiple records is saved in the variable list\_of\_records\_any. If the variable contains five

records, then each record is passed to the Loop action to be processed one at a

time.

### List users in a role action

Retrieve a list of the unique user IDs of the users in the specified role.

### Settings

Retrieve a list of the unique user IDs of the users in the specified role.

- Enter the **Role ID** for the list.
- Enter the **Session name** for your changes to the repository.
- **Choose a variable** where the outcome data can be saved.

**Note:** The output is retrieved as a list of type . To read an individual record (row) in this list, you need to loop through all the dictionary items using the action and read or extract the records (rows) individually. For example, the output of get multiple records is saved in the variable list\_of\_records\_any. If the variable contains five records, then each record is passed to the Loop action to be processed one at a

time.

## Remove users from role action

Remove a list of users from a specific role.

### Settings

- Enter the **Role ID** that you want to remove users from.
- Select how the data will be entered to begin adding user data that will be removed from the role.
  - If using a **List**:
    - Select the data **Type**.
    - Enter the **Value** of the data in the list.
  - If using **Variable**, then select the established variable of the data to be removed from the role.
- Enter the **Session name** for your changes to the repository.

## Set the user's roles action in Genesys

Set the roles for a specific user.

### Settings

- Enter the unique ID of the user for the **Internal user ID**.
- Select how the data will be entered to begin adding role data that will be attributed to the user.
  - If using a **List**:
    - Select the data **Type**.
    - Enter the **Value** of the data in the list.
  - If using **Variable**, then select the established variable of the data to be attributed to the user.
- Enter the **Session name** for your changes to the repository.

## Skill palette

The Genesys package offers a palette of actions to detail and access the skills of agents.

### Skill palette for Genesys

Genesys allows for defining Automatic Call Distribution (ACD) and profile-based skills for agents. An ACD skill routes each contact to the available agents who can best meet the contact's needs. Profile skill data becomes keywords for advanced searches and parameters for creating groups and can also be used by the Workforce Management capabilities to create schedule scenarios. The Genesys package includes the following skill actions:

Action	Description
Add user routing skills	Attribute routing skills to a user. <a href="#">Add user routing skills action</a> on page 2686
Bulk-add routing skills	Add multiple routing skills to a single user. <a href="#">Bulk-add routing skills action</a> on page 2686
Bulk-replace routing skills	Replace multiple routing skills for a single user. <a href="#">Bulk-replace routing skills action</a> on page 2687
List/search routing skills	Retrieve a list of routing skills. <a href="#">List/search routing skills action</a> on page 2687
List user's routing skills	Retrieve a list of user's routing skills. <a href="#">List user's routing skills action</a> on page 2688
Remove user routing skills	Remove routing skills for a user. <a href="#">Remove user routing skills action</a> on page 2688

## Add user routing skills action

Attribute routing skills to a user.

### Settings

- Enter a unique user ID for the **Internal user ID**.
- Enter the **Skill ID** that is to be added to the user.
- Enter the user's skill **Proficiency** with a value of 0-5. Zero is low proficiency.
- Enter the **Session name** for your changes to the repository.

## Bulk-add routing skills action

Add multiple routing skills to a single user.

### Settings

- Select how the skill dataset will be entered.
  - If using a **Table**:
    - Click **Edit table** to create your table.
    - Enter the data in the cells for your table.
  - If using **Variable**, then select the established variable of the data to be added to the user.
- Select the proper data of the first, second, and third columns to map the corresponding **User ID**, **Skill ID**, and **Skill proficiency** of your dataset.
- Enter the **Session name** for your changes to the repository.
- Optionally, **Choose a variable** where the outcome data will be saved.

## Bulk-replace routing skills action

Replace multiple routing skills for a single user.

### Settings

- Select how the skill dataset will be entered.
  - If using a **Table**:
    - Click **Edit table** to create your table.
    - Enter the data in the cells for your table.
  - If using **Variable**, then select the established variable of the data to be replaced.
- Select the proper data of the first, second, and third columns to map the corresponding **User ID**, **Skill ID**, and **Skill proficiency** of your dataset.
- Enter the **Session name** for your changes to the repository.
- Optionally, **Choose a variable** where the outcome data will be saved.

## List/search routing skills action

Retrieve a list of routing skills.

### Settings

- Optionally, enter a **Skill name** for the list.
- Enter the **Session name** for your changes to the repository.
- **Choose a variable** where the outcome data will be saved.

**Note:** The output is retrieved as a list of type . To read an individual record (row) in this list, you need to loop through all the dictionary items using the action and read or extract the records (rows) individually. For example, the output of get multiple records is saved in the variable list\_of\_records\_any. If the variable contains five records, then each record is passed to the Loop action to be processed one at a

The screenshot shows an automation workflow with the following steps:

- ServiceNow: Authentication Start a "Default" session on \$PDI\_url\$
- ServiceNow: Get Multiple Records Get a list of "incident" records using filter type (N
- Loop : For each item in the list
- Dictionary: Get value of the key "number" from \$ListItem\$
- Dictionary: Get value of the key "severity" from \$ListItem\$
- Dictionary: Get value of the key "short\_description" from \$ListItem\$
- Message box "Record: \$O\_inc\_number\$, \$O\_severity\$, \$O\_descri
- ServiceNow: Revoke Authentication End the "Default" session

An orange arrow points from the 'Get Multiple Records' step to a 'View variable' window. The window displays the following information:

Type	Subtype
List	Any
Name	Description
list_of_records_any	An ordered group of items
Use as input	
No	
Use as output	
No	
Constant (read-only)	
No	
Default value (optional)	
This list is empty	

time.

## List user's routing skills action

Retrieve a list of user's routing skills.

### Settings

- Enter a unique user ID for the **Internal user ID**.
- Enter the **Session name** for your changes to the repository.
- **Choose a variable** where the outcome data will be saved.

**Note:** The output is retrieved as a list of type . To read an individual record (row) in this list, you need to loop through all the dictionary items using the action and read or extract the records (rows) individually. For example, the output of get multiple records is saved in the variable list\_of\_records\_any. If the variable contains five records, then each record is passed to the Loop action to be processed one at a

The screenshot shows an automation workflow with the following steps:

- ServiceNow: Authentication Start a "Default" session on SPDI\_urls
- ServiceNow: Get Multiple Records Get a list of "incident" records using filter type (N
- Loop : For each item in the list
- Dictionary: Get value of the key "number" from \$ListItem\$
- Dictionary: Get value of the key "severity" from \$ListItem\$
- Dictionary: Get value of the key "short\_description" from \$ListItem\$
- Message box "Record: \$O\_inc\_number\$, \$O\_severity\$, \$O\_descri
- ServiceNow: Revoke Authentication End the "Default" session

An orange arrow points from the 'Get Multiple Records' step to the 'View variable' dialog box. The dialog box shows the following details:

Type	Subtype
List	Any
Name	Description
list_of_records_any	An ordered group of items
Use as input	No
Use as output	No
Constant (read-only)	No
Default value (optional)	This list is empty

time.

## Remove user routing skills action

Remove routing skills for a user.

### Settings

- Enter a unique user ID for the **Internal user ID**.
- Enter the **Skill ID** that you want to remove.
- Enter the **Session name** for your changes to the repository.



## User palette

The Genesys package offers a palette of actions to detail and access user records.

### User palette for Genesys

A person is on-boarded as a user. User records can then be assigned with different attributes and roles. The user record begins the process of building out a fully organized work force. The Genesys package includes the following user actions:

Action	Description
Create user	Create a new user. <a href="#">Create user action in Genesys</a> on page 2689
Delete user	Delete an existing user. <a href="#">Delete user action in Genesys</a> on page 2689
Get user	Retrieve the details of a user. <a href="#">Get user action in Genesys</a> on page 2690
List/search users	Retrieve a list of users that match your input criteria. <a href="#">List/search users action</a> on page 2690
Update user	Update the details of a user. Leave any field blank if no update is needed. <a href="#">Update user action in Genesys</a> on page 2691

### Create user action in Genesys

Create a new user.

#### Settings

- Enter the user's **Email (login ID)**.
- Select how you would like your password entered.
  - Use **Credential** to pick a preconfigured credential locker.
  - Use **Variable** to select an established credential variable.
  - Use **Insecure string** to enter your credential in the field.
- Enter the **Password** required for the user to sign in.
- Enter the **Full name** of the user.
- Enter a **Division ID** for the user.
- Select whether the user **State** is active or inactive in the repository.
- Optionally, enter the user's **Title** and **Department**.
- Enter the **Session name** for your changes to the repository.

### Delete user action in Genesys

Delete an existing user.

## Settings

- Enter the unique user ID for the **Internal user ID** that you want to delete.
- Enter the **Session name** for your changes to the repository.

## Get user action in Genesys

Retrieve the details of a user.

## Settings

- Enter a unique user ID for **Internal user ID**.
- Enter the **Session name** for your changes to the repository.
- Select how the outcome data will be saved.
  - If using **Multiple variables**, use the following steps for each variable:
    - Click **Add variable mapping**.
    - Enter the **Key** of the variable.
    - **Choose a variable** where the data will be saved.
    - Click **Add** for this data to be saved to the configured variable.
  - If using a **Dictionary** variable, then select the established variable where outcome data can be saved.

## List/search users action

Retrieve a list of users that match your input criteria.

## Settings

- Select how the data will be entered to begin adding user data to the search.
  - If using a **List**:
    - Select the data **Type**.
    - Enter the **Value** of the data in the list.
  - If using **Variable**, then select the established variable of the data to be added to the list.
- Optionally, select whether the **State** of the user is active or inactive.
- Enter the **Session name** for your changes to the repository.
- **Choose a variable** where the outcome data can be saved.

---

**Note:** The output is retrieved as a list of type `dict`. To read an individual record (row) in this list, you need to loop through all the dictionary items using the `loop` action and read or extract the records (rows) individually. For example, the output of get multiple records is saved in the variable `list_of_records_any`. If the variable contains five

records, then each record is passed to the Loop action to be processed one at a

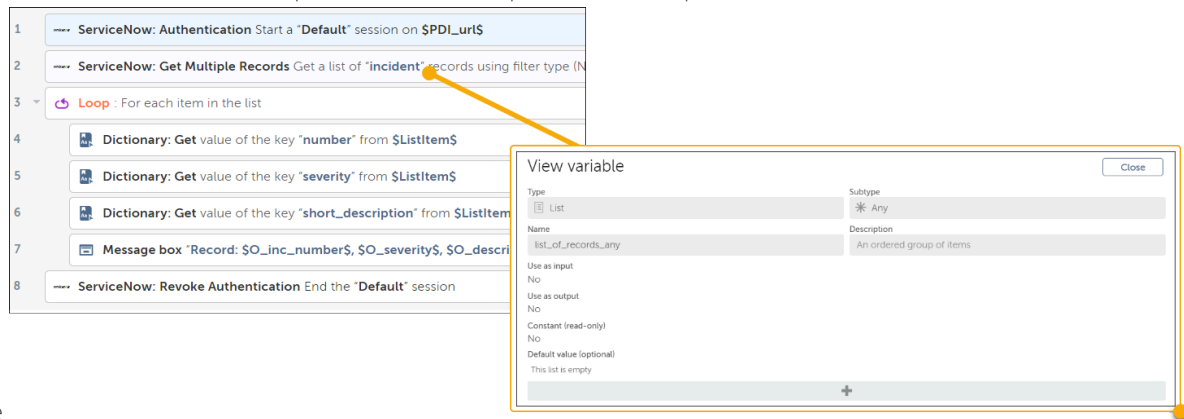

time.

## Update user action in Genesys

Update the details of a user. Leave any field blank if no update is needed.

### Settings

- Enter a unique user ID for the **Internal user ID**.
- Enter the data that you want to update, such as the following:
  - **Email (login ID)**
  - **Department**
  - **Manager**
  - **Date hired**
  - **Employee type**
  - **Biography, Interests, or Hobbies**
  - **Spouse**
- Select to turn **Auto answer** on or off for connecting calls to the user.
- Enter the **Session name** for your changes to the repository.

## Google packages

Google packages include Google Calendar, Google Drive and Google Sheets that contain actions which enable you to automate task faster and better.

### Benefits of using Google packages

- **Boost productivity:** Automation can save time and effort by automating tasks such as creating or deleting an event in Google Drive or automating repetitive tasks involving cells, columns, rows, and sheets in Google sheets.
- **Improved accuracy:** Improve the reliability of automations by reducing errors.
- **Enhanced security and compliance:** Provides a more secure and standard model for automations to authenticate and authorize Google Workspace applications.

- **Cost reduction:** Automation reduces manual work and increases the team's efficiency, ultimately lowering operational costs.

## Google Calendar package

The **Google Calendar** package contains actions that enable you to automate creating and deleting events.

### Before you start

Use the actions in the Google Calendar package in the following order:

1. Use the **Connect** to establish a connection to the Google server.  
See [Connect action for Google packages](#) on page 2717.
2. Use a combination of available in this to automate tasks.

---

**Note:** To use from other Google, establish a connection using the **Connect** from that.

---

3. Use the **Disconnect** to terminate the connection.

### Actions in the Google Calendar package

The **Google Calendar** package includes the following actions:

Action	Description
Create event	See <a href="#">Using the Create event action in Google Calendar</a> on page 2692.
Connect	See <a href="#">Connect action for Google packages</a> on page 2717.
Disconnect	See <a href="#">Disconnect action for Google packages</a> on page 2720.
Delete event	See <a href="#">Delete event action in Google Calendar</a> on page 2693.

Related reference

[Google Calendar package updates](#) on page 889

Review the updates in released versions of the Google Calendar package such as new and enhanced features as well as fixes and limitations. The page also lists the release dates of each version, and the compatible Control Room and Bot Agent versions.

### Using the Create event action in Google Calendar

Use the **Create event** action to create an event and specify event attendees, duration, location, recurrence, and title. During run time, this action triggers an email notification to meeting attendees.

To create a new calendar event, do the following:

1. Enter the session name you used to connect to the G-Suite server in the **Connect** action.  
See [Connect action for Google packages](#) on page 2717.
2. Enter the event title.
3. Optional: Enter the location.
4. Optional: Enter the attendees' email addresses, separated with commas.
5. Enter the start date.  
Use the format yyyy-MM-dd.
6. Enter the end date.  
Use the format yyyy-MM-dd.
7. Select the **All Day** or **Specify Time** option from the **Event Time** option.
  - If you select the **All Day** option, you do not need to provide any additional details.
  - If you select the **Specify Time** option, complete the following fields:
    - Specify the **Start Time** using the HH:mm:ss format.
    - Specify the **End Time** using the HH:mm:ss format.
8. Select the **Use System Timezone** or **Specify Timezone** option from the **Timezone** option.
  - If you select the **Use System Timezone** option, you do not need to provide any additional details.
  - If you select the **Specify Timezone** option, complete the following fields:
    - Specify the **Start Timezone**.
    - Specify the **End Timezone**.
9. Optional: Mark the **Recurring** option to make this event repeat.
10. Select a Visibility option from the drop-down list.  
Select from **Default**, **Public**, or **Private**.
11. Optional: Enter an event description.
12. Optional: Select a string variable from the drop-down list to store the id of the created event.
13. Click **Save**.

## Delete event action in Google Calendar

You can remove an event from the calendar using the **Delete event** action.

### Settings

Removes the event from the calendar.

- Enter the same session name that you provided in the **Connect** .
- Enter the **Event Id**. This is the string in the URL that appears after `/eventedit/` when you open an event for editing.
- Optional: Assign the event to a String variable.

## Google Drive package

Automate tasks related to files and folders by using the actions in the **Google Drive** package.

### Before you start

Use the actions in the Google Drive package in the following order:

1. Use the **Connect** to establish a connection to the Google server.  
See [Connect action for Google packages](#) on page 2717.
2. Use a combination of available in this to automate tasks.

---

**Note:** To use from other Google , establish a connection using the **Connect** from that .

---

3. Use the **Disconnect** to terminate the connection.  
See [Disconnect action for Google packages](#) on page 2720.

### Actions in the Google Drive package

The **Google Drive** package includes the following actions:

Action	Description
Check permissions	See <a href="#">Check permissions action in Google Drive</a> on page 2696.
Copy file	See <a href="#">Copy file action in Google Drive</a> on page 2696.
Copy folder	See <a href="#">Copy folder action in Google Drive</a> on page 2697.
Create file permission	See <a href="#">Create file permission action in Google Drive</a> on page 2697.
Create folder	See <a href="#">Create folder action in Google Drive</a> on page 2698.
Delete file	See <a href="#">Delete file action in Google Drive</a> on page 2698.
Delete file permission	See <a href="#">Delete file permission action in Google Drive</a> on page 2698.
Delete folder	See <a href="#">Delete folder action in Google Drive</a> on page 2699.
Download file	See <a href="#">Download file action in Google Drive</a> on page 2699.
Find file/folder	See <a href="#">Find file/folder action in Google Drive</a> on page 2699.

Action	Description
Get file information	See <a href="#">Get file information action in Google Drive</a> on page 2700.
Get file permission	See <a href="#">Get file permission action in Google Drive</a> on page 2701.
Move file	See <a href="#">Move file action in Google Drive</a> on page 2701.
Move folder	See <a href="#">Move folder action in Google Drive</a> on page 2701.
Open file	<p>Opens a file from the specified directory in Google Drive.</p> <ul style="list-style-type: none"> <li>• Enter the same username that you provided in the <b>Connect</b> .</li> <li>• Select whether to identify the file by file path and name, or by ID.</li> </ul> <hr/> <p><b>Note:</b> The ID is the value in the URL after the last forward slash. For example, if the URL is <code>https://docs.google.com/spreadsheets/d/12d1AwvrEA4JeLysfFky9</code>, the ID is <code>12d1AwvrEA4JeLysfFky9</code>.</p> <hr/>
Open folder	<p>Opens a folder from the specified directory in Google Drive.</p> <ul style="list-style-type: none"> <li>• Enter the same username that you provided in the <b>Connect</b> .</li> <li>• Select whether to identify the folder by directory path and name, or by ID.</li> </ul> <hr/> <p><b>Note:</b> The ID is the value in the URL after the last forward slash. For example, if the URL is <code>https://docs.google.com/spreadsheets/d/12d1AwvrEA4JeLysfFky9</code>, the ID is <code>12d1AwvrEA4JeLysfFky9</code>.</p> <hr/>
Rename file	See <a href="#">Rename file action in Google Drive</a> on page 2702.
Rename folder	See <a href="#">Rename folder action in Google Drive</a> on page 2702.
Upload file	See <a href="#">Upload file action in Google Drive</a> on page 2702.

Action	Description
Update file permission	<p>Update the permissions for a file.</p> <ul style="list-style-type: none"> <li>Select whether to identify the file by file path and name, or by ID.</li> </ul> <hr/> <p><b>Note:</b> The ID is the value in the URL after the last forward slash. For example, if the URL is <code>https://docs.google.com/spreadsheets/d/12d1AwvrEA4JeLysfFky9</code>, the ID is <code>12d1AwvrEA4JeLysfFky9</code>.</p> <hr/> <ul style="list-style-type: none"> <li>In the <b>Permission id</b> field, enter your user ID.</li> <li>Select a role. For more information, see <a href="#">Google Drive Roles</a>.</li> <li>Optional: Select or create a variable to hold the permission ID.</li> </ul>

Related reference

[Google Drive package updates](#) on page 890

Review the updates in released versions of the Google Drive package such as new and enhanced features as well as fixes and limitations. The page also lists the release dates of each version, and the compatible Control Room and Bot Agent versions.

## Check permissions action in Google Drive

The **Check permissions** action enables you to check permissions for a file or folder on Google Drive and returns `read`, `write`, or `delete` to a list variable.

### Settings

Checks for a file or folder permissions and returns `read`, `write`, or `delete` to a list variable.

- Enter the same username that you provided in the **Connect** .
- Select whether to check permissions for a file or a folder. Select **File** or **Folder** and enter the name and path to the file or folder. To check the permissions of files shared with you in Google Drive, select **File ID** to enter the file id. You can extract the file id from the URL of the file name and enter it in the **File ID** field.

---

**Note:** If you select the **File ID** option, the user with a **Commenter** role with the write access will observe that the bot does not check the write permission and returns the value as false.

---

- To check the various kinds of permissions, select **Read**, **Write**, or **Delete**. This returns `read`, `write`, or `delete` to a Boolean variable.
- Select or create a Boolean variable to hold the permissions.

## Copy file action in Google Drive

The Copy file action enables you to copy a file from one folder to another on Google Drive.



## Settings

- Enter the same username that you provided in the **Connect** .
- Select whether to identify the source file by file path and name, or by ID.

---

**Note:** The ID is the value in the URL after the last forward slash. For example, if the URL is `https://docs.google.com/spreadsheets/d/12d1AwvrEA4JeLysfFky9`, the ID is `12d1AwvrEA4JeLysfFky9`.

---

- Select whether to identify the destination folder by directory path and name, or by ID.
- Optional: Mark the **Rename file** option and enter the new file name.

## Copy folder action in Google Drive

Use Copy folder action to copy a folder from one location to another.

### Settings

Copies a folder from one location to another.

- Enter the same username that you provided in the **Connect** .
- Select whether to identify the source file by folder path and name, or by ID. If this is a shared folder, you must use the **Folder ID** option.

---

**Note:** The ID is the value in the URL after the last forward slash. For example, if the URL is `https://docs.google.com/spreadsheets/d/12d1AwvrEA4JeLysfFky9`, the ID is `12d1AwvrEA4JeLysfFky9`.

---

- Select whether to identify the destination folder by directory path and name, or by ID.

## Create file permission action in Google Drive

You can create a new permission for a file by using the Create file permission action.

### Settings

Creates a new permission for a file.

- Enter the same username that you provided in the **Connect** .
- Select whether to identify the file by file path and name, or by ID.

---

**Note:** The ID is the value in the URL after the last forward slash. For example, if the URL is `https://docs.google.com/spreadsheets/d/12d1AwvrEA4JeLysfFky9`, the ID is `12d1AwvrEA4JeLysfFky9`.

---

- Select a role. For more information, see [Google Drive Roles](#).
- Select the grantee type. Choose from:
  - User
  - Group
  - Domain

- Anyone
- If you select User or Group, enter the email address. If you select domain, enter the domain.
- Optional: Select or create a variable to hold the permission ID.

## Create folder action in Google Drive

This action enables you to create a folder in Google drive.

### Settings

Creates a folder.

- Enter the same username that you provided in the **Connect** .
- Enter the parent folder where to create the folder. To create the folder in the root folder enter root.
- Enter the folder name.
- Optional: Select or create a string variable to hold the ID of the new folder.

---

**Note:** You cannot create a folder in the Shared with me folder because Google API does not support it.

---

## Delete file action in Google Drive

Use the Delete file action to delete a file on your Google Drive.

### Settings

- Enter the same username that you provided in the **Connect** .
- Select whether to identify the file by file path and name, or by ID.

---

**Note:** The ID is the value in the URL after the last forward slash. For example, if the URL is <https://docs.google.com/spreadsheets/d/12d1AwvrEA4JeLysfFky9>, the ID is 12d1AwvrEA4JeLysfFky9.

---

- Optional: Select or create a boolean variable to hold the file delete status.

## Delete file permission action in Google Drive

You can delete a file permission for a file by using the Delete file permission action.

### Settings

- Enter the same username that you provided in the **Connect** .
- Select whether to identify the file by file path and name, or by ID.

---

**Note:** The ID is the value in the URL after the last forward slash. For example, if the URL is <https://docs.google.com/spreadsheets/d/12d1AwvrEA4JeLysfFky9>, the ID is 12d1AwvrEA4JeLysfFky9.

---

- In the **Permission id** field, enter the permission ID.
- Optional: Select or create a variable to hold the permission ID.

## Delete folder action in Google Drive

Delete folder action enables you to delete a folder from the Google Drive.

### Settings

- Enter the same username that you provided in the **Connect** .
- Select whether to identify the folder by path and name, or by ID.

---

**Note:** The ID is the value in the URL after the last forward slash. For example, if the URL is `https://drive.google.com/drive/folders/0B0MqCb--3Y8QQz1JcVRJb3UxcTg`, the ID is `0B0MqCb--3Y8QQz1JcVRJb3UxcTg`.

---

- Optional: Select or create a boolean variable to hold the folder delete status.

## Download file action in Google Drive

You can download a file from your Google Drive to a specific location on your desktop.

### Settings

- Enter the same username that you provided in the **Connect** .
- Select whether to identify the file by file path and name, or by ID.

---

**Note:** The ID is the value in the URL after the last forward slash. For example, if the URL is `https://docs.google.com/spreadsheets/d/12d1AwvrEA4JeLysfFky9`, the ID is `12d1AwvrEA4JeLysfFky9`.

---

- Specify the download file path. For example, `C:/Users/Downloads`.
- Optional: Mark the **Overwrite existing file** option to overwrite the file of the same name.
- Optional: Mark the **Rename file** option to enter a new name for the downloaded file.
- Optional: Select or create a variable to hold the ID of the downloaded file.

## Find file/folder action in Google Drive

The Find file/folder action enables you to find files or folders in a specific directory in your Google Drive.

### Settings

- Enter the same username that you provided in the **Connect** .
- Choose one of the following options:
  - To find a file or files, click **File**.
  - To find a folder or folders, click **Folder**.

- After selecting either **File** or **Folder**, you can specify the source folder path or the source folder ID.
  - **Source folder path:** Specify the folder where the file or folder you are trying to find is located. For example, if the file or folder you are trying to find is within a folder called `Home/Accounts` in Google Drive, enter `Home/Accounts` as the source folder path. If it is within a folder called `Home`, enter just `Home` without any forward slash. If the file or folder is in the root directory (My Drive), enter `root` as the source folder path.
  - **Source folder id:** Enter the ID of the folder where the file or folder you are trying to find is located. If there are multiple folders with the same name, using the folder ID can help you search for files or folders in a specific folder.
- From **Match type**, you can choose one of the following options:
  - If you want the API to return results that exactly match the specified file or folder name, select **Exactly matches**.
  - If you want the API to return results that partially match the specified file or folder name, select **Contains**.
- In **File/Folder name**, specify the name of the file or folder you want to locate. If the file has a file extension in Google Drive, make sure to include the file extension as well.
- The Find file/folder API returns a dictionary with information about matched files. The dictionary contains a key called `NumberOfFiles`. It provides the count of files that matched. The dictionary also contains keys named `File1`, `File2`, and so on, depending on the number of matched files. These keys contain information such as file names and file IDs in JSON format. The following is an example of a dictionary returned by the Find file/folder API call:

```
{NumberOfFiles,1},{File1,
{"fileName":"contacts","fileId":"171yBUzqH80ZW_KLEp23DwebzkCdDZgnGFWBzB6K9kco"}}
```

You can use one of the following options to retrieve the results:

- **Multiple variables:** Use this option if you want to map each key to a variable.
- **Dictionary:** You can also create a dictionary variable with the subtype as `Any` and store the dictionary returned by the API to the variable. You can then retrieve information, such as file names, file IDs, folder names, and folder IDs, by parsing the JSON string. For more information, see [Example of using Find file/folder action from Google Drive package](#) on page 3219

## Get file information action in Google Drive

Use the **Get file information** action in the Google Drive package to enable you to get the file information of a file from Google Drive.

### Settings

- Enter the same username that you provided in the **Connect**.
- Select whether to identify the file by file path and name, or by ID. If this is a shared folder, you must use the **FILE ID** option.

---

**Note:** The ID is the value in the URL after the last forward slash. For example, if the URL is `https://docs.google.com/spreadsheets/d/12dlAwvrEA4JeLysfFky9`, the ID is `12dlAwvrEA4JeLysfFky9`

---

- Select or create a dictionary variable to hold the file information which is stored in two keys: the `name` key holds the file name and the `extension` key holds the file extension.

## Get file permission action in Google Drive

Use the **Get file permission** action in the Google Drive package to enable you to retrieve file permission of a file or a folder from Google Drive.

### Settings

- Enter the same username that you provided in the **Connect** .
- Select whether to identify the file by file path and name, or by ID.

---

**Note:** The ID is the value in the URL after the last forward slash. For example, if the URL is `https://docs.google.com/spreadsheets/d/12d1AwvrEA4JeLysfFky9`, the ID is `12d1AwvrEA4JeLysfFky9`.

---

- Select or create a list variable to hold the file permissions.

## Move file action in Google Drive

Use the **Move file** action in the Google Drive package to enable you to move file from one folder to another on Google Drive.

### Settings

- Enter the same username that you provided in the **Connect** .
- Select whether to identify the file by file path and name, or by ID.

---

**Note:** The ID is the value in the URL after the last forward slash. For example, if the URL is `https://docs.google.com/spreadsheets/d/12d1AwvrEA4JeLysfFky9`, the ID is `12d1AwvrEA4JeLysfFky9`.

---

- Select whether to identify the destination folder by directory path and name, or by ID.

---

**Note:** The ID is the value in the URL after the last forward slash. For example, if the URL is `https://docs.google.com/spreadsheets/d/12d1AwvrEA4JeLysfFky9`, the ID is `12d1AwvrEA4JeLysfFky9`.

---

## Move folder action in Google Drive

Use the **Move folder** action in the Google Drive package to enable you to move a folder from one location to another on Google Drive.

### Settings

- Enter the same username that you provided in the **Connect** .
- Select whether to identify the source file by folder path and name, or by ID. If this is a shared folder, you must use the **Folder ID** option.

**Note:** The ID is the value in the URL after the last forward slash. For example, if the URL is <https://docs.google.com/spreadsheets/d/12d1AwvvrEA4JeLysfFky9>, the ID is 12d1AwvvrEA4JeLysfFky9.

---

- Select whether to identify the destination folder by directory path and name, or by ID.

## Rename file action in Google Drive

Use the **Rename file** action in the Google Drive package to enable you to rename a file on Google Drive.

### Settings

- Enter the same username that you provided in the **Connect** .
  - Select whether to identify the file by file path and name, or by ID.
- 

**Note:** The ID is the value in the URL after the last forward slash. For example, if the URL is <https://docs.google.com/spreadsheets/d/12d1AwvvrEA4JeLysfFky9>, the ID is 12d1AwvvrEA4JeLysfFky9.

---

- Enter the new file name.

## Rename folder action in Google Drive

Use the **Rename folder** action in the Google Drive package to enable you to rename a folder in a specific directory on Google Drive.

### Settings

- Enter the same username that you provided in the **Connect** .
  - Select whether to identify the folder by directory path and name, or by ID.
- 

**Note:** The ID is the value in the URL after the last forward slash. For example, if the URL is <https://docs.google.com/spreadsheets/d/12d1AwvvrEA4JeLysfFky9>, the ID is 12d1AwvvrEA4JeLysfFky9.

---

- Enter the new folder name.

## Upload file action in Google Drive

Use the **Upload file** action in the Google Drive package to enable you to upload a file from your computer to Google Drive.

### Settings

- Enter the same username that you provided in the **Connect** .
- Enter the file path and name.
- Select whether to identify the folder where to upload the file by directory path and name, or by ID.

**Note:** The ID is the value in the URL after the last forward slash. For example, if the URL is <https://docs.google.com/spreadsheets/d/12d1AwvvrEA4JeLysfFky9>, the ID is 12d1AwvvrEA4JeLysfFky9.

- Optional: Mark the **Overwrite existing file** option to overwrite the file of the same name.
- Optional: Select or create a variable to hold the ID of the uploaded file.

## Google Sheets package

The **Google Sheets** package contains actions that enable you to automate tasks involving cells, columns, rows, and sheets.

### Before you start

Use the actions in the Google Sheets package in the following order:

1. Use the **Connect** to establish a connection to the Google server.  
See [Connect action for Google packages](#) on page 2717.
2. Use a combination of available in this to automate tasks.

**Note:** To use from other Google , establish a connection using the **Connect** from that .

3. Use the **Disconnect** to terminate the connection.

### Actions in the Google Sheets package

The actions in the **Google Sheets** package enable you to perform the following operations:

Action	Description
Activate sheet	See <a href="#">Activate sheet action in Google Sheets</a> on page 2705.
Autofit columns	See <a href="#">Autofit columns action in Google Sheets</a> on page 2705.
Autofit rows	See <a href="#">Autofit rows action in Google Sheets</a> on page 2705.
Close	See <a href="#">Close action in Google Sheets</a> on page 2706.
Create sheet	See <a href="#">Create sheet action in Google Sheets</a> on page 2706.
Create workbook	See <a href="#">Create workbook action in Google Sheets</a> on page 2706.
Delete cell	See <a href="#">Delete cell action in Google Sheets</a> on page 2707.

Action	Description
Delete range	See <a href="#">Delete range action in Google Sheets</a> on page 2707.
Delete row/column	See <a href="#">Delete row/column action in Google Sheets</a> on page 2708.
Delete sheet	See <a href="#">Delete sheet action in Google Sheets</a> on page 2708.
Disconnect	See <a href="#">Disconnect action</a> on page 2708.
Format cells	See <a href="#">Format cells action</a> on page 2709.
Get All Sheet Names	See <a href="#">Get All Sheet Names action</a> on page 2709.
Get Cell/text color	See <a href="#">Get Cell/text color action</a> .
Get Current Sheet Name	See <a href="#">Get Current Sheet Name action</a> .
Get multiple cells	See <a href="#">Get multiple cells action in Google Sheets</a> on page 2710.
Get number of rows	See <a href="#">Get number of rows action</a> on page 2710.
Get single cell	See <a href="#">Get single cell action in Google Sheets</a> on page 2711.
Go to cell	See <a href="#">Go to cell action in Google Sheets</a> on page 2711.
Hide worksheet	See <a href="#">Hide worksheet action</a> on page 2712.
Insert cell	See <a href="#">Insert cell action</a> on page 2712.
Insert range	See <a href="#">Insert range action</a> .
Insert row/column	See <a href="#">Insert row/column action in Google Sheets</a> on page 2712.
Open spreadsheet	See <a href="#">Open spreadsheet action in Google Sheets</a> on page 2713.
Paste cell	See <a href="#">Paste cell action</a> on page 2713
Read cell formula	See <a href="#">Read cell formula action</a> on page 2714
Read column	See <a href="#">Read column action in Google Sheets</a> on page 2714.
Read row	See <a href="#">Read row action in Google Sheets</a> on page 2714.
Rename sheet	See <a href="#">Rename sheet action</a> on page 2714.
Retrieve Sheets count	See <a href="#">Retrieve Sheets count action</a> .
Set cell	See <a href="#">Set cell action in Google Sheets</a> on page 2715.



Action	Description
Set cell formula	See <a href="#">Set cell formula action</a> on page 2715
Set cell or text color	See <a href="#">Set cell or text color action</a> on page 2716
Show worksheet	See <a href="#">Show worksheet action</a> on page 2716
Write from data table	See <a href="#">Write from data table action in Google Sheets</a> on page 2717.

Related reference

[Google Sheets package updates](#) on page 892

Review the updates in released versions of the Google Sheets package such as new and enhanced features as well as fixes and limitations. The page also lists the release dates of each version, and the compatible Control Room and Bot Agent versions.

## Activate sheet action in Google Sheets

Activate sheet action enables you to activate a specific sheet in the open spreadsheet.

### Settings

Activates a specific sheet in the open spreadsheet.

- Enter the name of the session used to open the current spreadsheet with the **Open spreadsheet** action.
- Specify whether to activate the sheet by index or name.

---

**Note:** The sheet index count begins at 1.

---

## Autofit columns action in Google Sheets

Autofit columns action enables you to resize the columns that contain data to accommodate the data.

### Settings

Resizes the columns that contain data to accommodate the data. Enter the name of the session used to open the current spreadsheet with the **Open spreadsheet** action.

## Autofit rows action in Google Sheets

Autofit rows action enables you to resize the rows that contain data to accommodate the data.

### Settings

Resizes the rows that contain data to accommodate the data. Enter the name of the session used to open the current spreadsheet with the **Open spreadsheet** action.

## Close action in Google Sheets

With Close action, you can save and close the current spreadsheet.

### Settings

Saves and closes the current spreadsheet. Enter the name of the session used to open the current spreadsheet with the **Open spreadsheet** action.

## Create sheet action in Google Sheets

Create sheet action enables you to create a new sheet in the open workbook.

### Settings

Creates a new sheet in the open workbook.

- Enter the name of the session used to open the current spreadsheet with the **Open spreadsheet**.
- Specify whether to create the sheet by index or name.

---

**Note:** The sheet index count begins at 1.

---

## Create workbook action in Google Sheets

Create workbook action enables you to create a new workbook in your Google Sheets.

### Settings

Creates a new Google Sheets workbook.

---

**Note:** You cannot create a workbook in the Shared with me folder because Google API does not support it.

---

- Enter the username you used in the **Connect** action.
- Enter the name of the session used to open the current spreadsheet with the **Open spreadsheet**.
- Enter the workbook name with one of the following file extensions: .xlsx, .xls, or .xlsm
- Enter the file path for the new workbook or select a file variable.

## Example

The following example provides information to create a file in Google Drive:

1. Double-click or drag the **Connect** action. See [Connect action for Google packages](#) on page 2717.

**Note:** When you create bot, replace the values below with yours.

---

- a) In the **Username** field, select the **Insecure string** option and enter `aatest@gmail.com`
  - b) Enter `Default` in the **Session name** field.
  - c) In the **Client Id** field, select the **Insecure string** option and enter `55064436-7t68im3caev0941oqa1iae.apps.googleexample.com`.
  - d) In the **Client Secret** field, select the **Insecure string** option and enter `b129wCSpmYcwzXg77_DOC`.
  - e) Specify the wait time (in minutes) in the **Wait for action to complete (In minutes)** field.
2. Double-click or drag the **Create workbook** action.
- a) In the **Username** field, select the **Insecure string** option and enter `aatest@gmail.com`
  - b) Enter `Default` in the **Session name** field.
  - c) Enter `Investment plan.xlsx` in the **Workbook name** field.
  - d) For the **File path**, select **From my shared location** option and enter `My Drive/Finance 2023` in the **File Name (optional)** field.
3. Double-click or drag the **Disconnect** action. See [Disconnect action](#) on page 2708
- a) In the **Username** field, select the **Insecure string** option and enter `aatest@gmail.com`
  - b) Enter `Default` in the **Session name** field.
4. Click **Save** and then **Run**.

## Delete cell action in Google Sheets

Delete cell action enables you to delete cells within a worksheet.

### Settings

Deletes cells within a worksheet.

- Enter the name of the session used to open the current spreadsheet with the **Open spreadsheet**.
- Select either the **Active cell** or **Specific cell** option. If you have selected the **Specific cell**, enter the cell address.
- Select from the following delete options:
  - Shift cells left
  - Shift cells up
  - Entire row
  - Entire column

## Delete range action in Google Sheets

Delete range action enables you to delete a range of cells.

## Settings

Deletes a range of cells.

- Enter the name of the session used to open the current spreadsheet with the **Open spreadsheet**.
- Enter the range address. For example A1 : B4.
- Select the direction in which to shift the remaining active cells: **Up** or **Left**.

## Delete row/column action in Google Sheets

Delete row/column action enables you to delete a row or column in a worksheet.

### Settings

Deletes a row or column in a worksheet.

- Enter the name of the session used to open the current spreadsheet with the **Open spreadsheet**.
- Select whether to perform a row or column operation.
- Specify whether to delete the sheet by index or name.
- Specify whether to delete by index, active cell, or range.
  - If you select index, enter the row/column index

---

**Note:** The index count begins at 1.

---

- If you select range, specify the range of the rows/columns to delete. For example 1 : 10 to delete the first ten rows.

## Delete sheet action in Google Sheets

Use the **Delete sheet** action in the Google Sheets package to delete a sheet from a workbook.

### Settings

- Enter the name of the session used to open the current spreadsheet with the **Open spreadsheet**.
- Specify whether to delete the sheet by index or name.

## Disconnect action

The Disconnect action terminates the connection with the Google Sheets app. Enter the session name that you used in the **Connect** action. Add this action at the end of automation sequences that use actions from this Google Sheets package.

### Settings

- In the **Username** field, you can provide a valid username or select the credential or credential variable that contains your Google username. To enter a value, click **Insecure string**.

- Enter the session name that you used in the **Connect** action.
- Select the check box **Logout from the browser** if you want to sign off from your account.

## Format cells action

The **Format cells** action enables you to format specific cells of a workbook.

### Settings

- Enter the session name that you used in the **Connect** action.
- Use the **Cell options** field to select one of the following format options:
  - **Active cell**: Is the default selection and is used to format the current or active cell from the workbook.
  - **Specific cell**: Use the **Cell Name** field to enter the name of the cell from the workbook.
  - **Multiple cells**: Use the **Cell range** field to specify the range for of all the cells from the workbook that you want to format.
- (Optional) Select **Font** check box to change the font specifications of the content such as name, size and color.
- (Optional) Select **Alignment** check box to change the vertical or horizontal alignment of the content.
- (Optional) Select **Wrap Text** check box to change the default text wrap option of the content.
- (Optional) Select **Merge Type** check box to choose from various merge options.

## Get All Sheet Names action

The **Get All Sheet Names** action enables you to retrieve the names of all the sheets within a specific workbook and store it as a variable.

### Settings

- Enter the session name that you used in the **Connect** action.
- Use the **Store All Sheet Names to** field for one of the following options:
  - Select an existing variable from the **Choose a variable** drop-down menu.
  - Click **Create variable** icon for a new variable.  
Use the **Create Variable** screen to enter a name, variable type (input or output), and a subtype.

## Get Cell/text color action

Use the **Get cell/text color** action to get the color of the background or text in a cell. This action retrieves the color of a cell as RGB values. For example, if the background or text in a cell is of red color, the value retrieved is 255,0,0.

### Settings

- Enter the name of the session used to open the workbook with the **Open** action.

- To get the color from the current active cell, select **Active cell**, or, to get the color from a specific cell, select **Specific cell**.
- Specify the cell name or address in the **Cell name**.
- to get the background color of the cell, select **Cell Color**.
- To get the color of the text, or both, select **Text Color**.
- Specify whether to retrieve the cell color by **Name** or **Code**.
- To assign the cell/text color to a List variable, select one of the options from the **Assign the output to variable** drop-down.

## Get Current Sheet Name action

The **Get Current Sheet Name** action for the Google Sheets package enables you to retrieve the name of the current worksheet in a workbook.

### Settings

- Enter the session name or select an existing variable used in the **Session name** field.
- In the **Store Current Sheet Name to** field, enter the destination to store the current sheet or select it from the variables.

## Get multiple cells action in Google Sheets

Use the **Get multiple cells** action in the Google Sheets package to retrieve values from cells in a Google sheet and store them in a table variable.

### Settings

- Enter the name of the session used to open the current spreadsheet with the **Open spreadsheet**.
- Select the **Multiple cells** option to retrieve values from a range of cells, or select **All cells** to retrieve values from all cells.
- Select or create a table variable to hold the output.

## Get number of rows action

The **Get number of rows** action in the Google Sheets package enables you to get the number of rows that are not empty or contain data.

### Settings

- Enter the name of the session used to open the current spreadsheet with the **Open spreadsheet** action.
- Select the **Non-empty rows** option to get the number of rows that are not empty or the **Total rows with data** option to get the number of rows that contain data.
- Select the number variable from the **Assign output to a variable** field to store the output.

## Get single cell action in Google Sheets

Use the **Get single cell** action in the Google Sheets package to retrieve the value from a specific cell in a Google sheet and store it in a string variable.

### Settings

- Enter the name of the session used to open the current spreadsheet with the **Open spreadsheet**.
- Select either the **Active cell** or **Specific cell** option. If you have selected the **Specific cell**, enter the cell address.
- Select or create a string variable to hold the output.

## Go to cell action in Google Sheets

Use the **Go to cell** action in the Google Sheets package to go to the specified cell.

### Settings

- Enter the name of the session used to open the current spreadsheet with the **Open spreadsheet**.
- You can navigate to different cells in a Google Sheet using the **Cell Options**. To activate a cell, choose one of the following **Cell options**:
  - To select a specific cell, click **Specific cell** and enter the address of the cell you want to select. For example, **A2**.
  - To select a cell adjacent to the active cell, choose one of the following options:
    - **One cell to the left**: Selects the cell to the left of the active cell. For example, if the active cell is **B3**, **A3** is selected.
    - **One cell to the right**: Selects the cell to the right of the active cell. For example, if the active cell is **B3**, **C3** is selected.
    - **One cell above**: Selects the cell above the active cell. For example, if the active cell is **B3**, **B2** is selected.
    - **One cell below**: Selects the cell below the active cell. For example, if the active cell is **B3**, **B4** is selected.
- To move the cursor to the beginning or the end of the current row, choose one of the following options:
  - **Beginning of the row**: Selects the first cell in the current row.
  - **End of the row**: Selects the last cell with data in the current row.
- To move the cursor to the beginning or the end of the current column, choose one of the following options:
  - **Beginning of the column**: Selects the first cell in the current column.
  - **End of the column**: Selects the last cell with data in the current column.

## Hide worksheet action

The Hide worksheet action in the Google Sheets package enables you to hide a worksheet from the current workbook.

### Settings

- In the **Worksheet name** field, specify the name of the worksheet to hide.

---

**Note:** You can hide a worksheet only if the workbook contains more than one worksheet.

---

- Enter the name of the session that you used to open the workbook with the **Open spreadsheet** action.

## Insert cell action

The **Insert cell** action enables you to insert a cell at a specific point in a workbook by shifting any existing cell.

### Settings

- Enter the session name that you used in the **Connect** action.
- Use the **Cell options** field to select one of the following format options:
  - **Active cell:** Is the default selection and is used to format the current or active cell from the workbook.
  - **Specific cell:** Use the **Cell Name** field to enter the name of the cell from the workbook.
- Use the **Shift type** field to select how an existing cell must be shifted.

## Insert range action

The **Insert range** action of the Google Sheets package enables you to insert the range into the current worksheet without overwriting the existing value.

### Settings

- Enter the session name or select an existing variable used in the **Session name** field .
- Enter the cell range in the **Range address**. For example A1:B4. This inserts a range of cells consisting of the first four rows by the first two columns.

After inserting the cell, set the **Shift type** to **Down** to shift the existing values down by the specified number of rows. Or **Right** to shift the existing values right by the specified number of columns.

## Insert row/column action in Google Sheets

Use the **Insert Row/Column** action in the Google Sheets package to insert a blank row or column into a spreadsheet.



## Settings

- Enter the name of the session used to open the current spreadsheet with the **Open spreadsheet**.
- Select whether to insert a row or column.
  - If you chose **Row Operations**, select whether to insert the row at a specific index, above the active cell, or in a range.

---

**Note:** The index count begins at 1.

---

- If you chose **Column Operations**, select whether to insert the column at a specific address, to the left of the active cell, or in a range.

## Open spreadsheet action in Google Sheets

Use the **Open spreadsheet** action in the Google Sheets package to open an existing spreadsheet.

## Settings

- In the **Username** field, enter the same username that you provided in the **Connect** action.
- Enter a session name. Use this session name in subsequent actions to associate them with this spreadsheet.
- Select whether to open the spreadsheet by name, URL, or spreadsheet ID:
  - Name: Enter the file name.
  - URL: Enter the entire URL.
  - Spreadsheet ID: The ID is the value in the URL after the last forward slash. For example, if the URL is `https://docs.google.com/spreadsheets/d/12d1AwvrEA4JeLysfFky9`, the ID is `12d1AwvrEA4JeLysfFky9`.
- If the spreadsheet contains multiple sheets, select the **Specific sheet name** option and enter the sheet name.

## Paste cell action

The **Paste cell** action in the Google Sheets package enables you to copy a value from a cell and pastes to a specified cell.

## Settings

- Enter the name of the session used to open the current spreadsheet with the **Open spreadsheet** action.
- Select the **Active cell** or **Specific cell** option to specify the cell from which to read the format. If you have selected the **Specific cell** option, enter the cell name and specify the address of the cell in the field.

## Read column action in Google Sheets

Use the **Read column** action in the Google Sheets package to retrieve data from a column and store it in a list variable.

### Settings

- Enter the name of the session used to open the current spreadsheet with the **Open spreadsheet** .
- In the **Cell options** field, specify the cell location from which to read the values. For example, enter A5 to retrieve all the values located in the first column, below the fifth row.
- You can also select the **Read full column** option to extract values from the entire column.
- Select or create a list variable to hold the output.

## Read row action in Google Sheets

Use the **Read row** action in the Google Sheets package to retrieve data from a row and store it in a list variable.

### Settings

- Enter the name of the session used to open the current spreadsheet with the **Open spreadsheet** .
- In the **Cell options** field, specify the cell location from which to read the values. For example, enter D5 to retrieve the values located in the fifth row and right of the fourth column.
- You can also select the **Read full row** option to extract values from the entire row.
- Select or create a list variable to hold the output.

## Read cell formula action

The Read cell formula action in the Google Sheets package enables you to retrieve the formula available in the **Active cell** or **Specific cell** and assign the output to a string variable. This action returns a blank value if the specified cell does not contain a formula.

### Settings

- Enter the name of the session that you used to open the workbook with the **Open spreadsheet** action
- Select the **Active cell** or **Specific cell** option to specify the cell from which to read the formula.

---

**Note:** If you have selected the **Specific cell** option, specify the address of the cell in the field.

---

- In the **Assign the output to variable** field, select a string variable to store the name of the formula. The shows a descriptive default variable name. If you create several output variables, subsequent variable names are appended with a -1, -2, -3, and so on to avoid duplication.

## Rename sheet action

The **Rename sheet** action enables you to rename a specific sheet of a workbook.

## Settings

- Enter the session name that you used in the **Connect** action.
- Use the **Sheet** field to select one of the following format options:
  - **Index**: Use this option to select an index that must be renamed.
  - **Name**: Use this option and enter the name of the sheet that you want to rename.
- Use the **Enter new name for the sheet** field to enter a name that must be added.

## Retrieve sheets count action

The **Retrieve sheets count** action of the Google Sheets package enables you to get the number of sheets available in the current workbook and store it in a number variable

## Settings

- Enter the session name or select an existing variable used in the **Session name** field.
- Select the **Exclude Hidden Worksheets** option to exclude the hidden worksheet or not and assign the count to a variable.
- From the **Assign the output to a variable list** drop-down, specify the variable to which you want to assign the output.

## Set cell action in Google Sheets

Use the **Set cell** action in the Google Sheets package to set the value of a specific cell.

## Settings

- Enter the name of the session used to open the current spreadsheet with the **Open spreadsheet**.
- Enter the address of the cell. For example, A5.
- Select or create a string variable to hold the value of the cell.

## Set cell formula action

The **Set cell formula** action of the Google Sheets package enables you to set a formula in the active cell or a specific cell in a Google sheet.

## Settings

- In the **Actions** palette, double-click or drag the **Set cell formula** action from the Google Sheets package.
- Use the **Session name** field to enter the name of the session used to open the workbook with the **Open spreadsheet** action.
- Use the **Cell options** field to select one of the following options to specify the cell in which you want to set the formula:
  - **Active cell**: cell that is currently active.

- **Specific cell:** specify the address of the cell in the **Cell name** field.  
(Optional) Click **Insert a value** icon to select an existing variable.
- **Multiple cells:** specify the range of the cells in the **Cell range** field.  
(Optional) Click **Insert a value** icon to select an existing variable.
- Use the **Cell formula** field to enter a formula.  
Ensure that you do not use "=".

## Set cell or text color action

The Set cell or text color action of the Google Sheets package enables you to set the color of the background or text in a cell. This action sets the color of a cell as RGB values. For example, if you want to set red color to the background or text in a cell, enter the value 255,0,0.

### Settings

- Enter the name of the session used to open the workbook with the **Open spreadsheet** action.
- To set the color to the current active cell, select **Active cell**, to set the color to a specific cell, select **Specific cell**, or to set the color to multiple cells select **Multiple cells**.

---

**Note:**

- If you have selected the **Specific cell** option, specify the address of the cell in the **Cell name** field.
  - If you have selected **Multiple cells** option, specify the range of the cells in the **Cell range** field.
- 
- In the **Set color to** field, to apply color to the background area of the cell, select the **Cell** option. To apply color to the text within a specific cell, select the **Text within cell** option.
  - In the **Cell color by Name/Code** field, specify whether you want to set the cell color by name or as an RGB value or choose a variable that has the value.

## Show worksheet action

The **Show worksheet** action in the Google Sheets package enables you to show a hidden google sheet in a worksheet.

### Settings

- Enter the name of the session used to open the current spreadsheet with the **Open spreadsheet** action.
- Enter the worksheet name in the **Google sheet name** field.

---

**Note:** The sheet name should not exceed 31 characters.

---

## Write from data table action in Google Sheets

Use the **Write from data table** action in the Google Sheets package to write the contents of a data table variable to a specific spreadsheet.

### Settings

- Enter the name of the session used to open the current spreadsheet with the **Open spreadsheet**.
- Select whether to write to the currently active sheet or to specify a sheet name.
- Select the data table variable.
- Enter the cell address where to start writing the data.

## Connect action for Google packages

Use the **Connect** action to establish a connection with the Google server in order to use other actions from that same package to automate tasks. All of the fields in this action accept a credential from the Credential Vault, variable, or a user-input value.

Configure the OAuth settings in the Google Cloud Platform and retrieve the credentials necessary to connect Automation Anywhere with your Google G Suite applications.

1. If you have not already done so, [create a project](#).
2. [Enable the APIs](#) for the Google G Suite applications you want to automate, such as the Google Drive API, Google Calendar API, and Google Sheets API.
3. Do the steps in [Setting up OAuth 2.0](#) to generate the Client ID and Secret.

---

**Note:**

- Select the **Web application** option and enter a name.
- Based on the authentication mode, enter the relevant redirect URI as given below:
  - **Authorization code** (default authentication mode): Add this authorized redirect URI `http://localhost:8888/Callback`.
  - **Control Room managed**: Add the Callback URL from **Control Room > Manage > OAuth connections > Connection settings** page. See [Create OAuth connection](#) on page 1893.

- 
1. In the Actions palette, double-click or drag the **Connect** action from the package you want to use.
  2. In the **Username** field, you can provide a valid username or select the credential or credential variable that contains your Google username. To enter a value, click **Insecure string**.
  3. If you are configuring the **Connect** action for the Google Calendar or Google Sheets package, enter a session name.
  4. Click the **OAuth2 Authentication Mode** drop-down and select one of the following authentication modes:

For an attended authentication mode, select **Authorization code**, which is a legacy flow and not secure. For the unattended authentication mode, select **Control Room managed** OAuth2 authentication, a more secure and standard model for automations.

- **Authorization code**

- In the **Client Id** field, select the credential or credential variable that contains the client ID. To enter a value, click **Insecure string**.
- In the **Redirect URI** field, enter `http://localhost:8888/Callback`

---

**Note:** For the Google Sheets package, the **Redirect URI** attribute is not supported. Enter the fixed redirect URL directly in Google Cloud Platform: `http://localhost:8888/Callback`

---

- In the **Client secret** field, select the credential or credential variable that contains the access token. To enter a value, click **Insecure string**.

- **Control Room managed**

To use Control Room managed OAuth2 in Google packages, you must configure the OAuth connection in the Control Room. See [Create OAuth connection](#) on page 1893.

Update the information in the following fields:

- **Connection:** Click the **Pick** button to select a connection type.
- Select **Custom** in the **Provider type** field.
- Select the connection name that you set up in the Control Room for Google Workspace apps.
- Use the **Token type** field to select one of the following options:

For information about the Google Workspace application access and refresh tokens, see [Configure enterprise applications](#) on page 1892

- **Shared:** Select this option when the OAuth2 access token is shared for all users running the automation. Note that this requires the Control Room administrator or any user (with Manage connections and View connections options enabled for the **OAUTH CONNECTIONS**) to set up an OAuth connection in the Control Room. Save the login credentials one time to generate a shared access token that can be consumed by all users running the automation.
- **User-specific:** Select this option when the OAuth2 access token is specific to each user running the automation. Note that this requires the Control Room administrator or any user (with Manage connections and View connections options enabled for the **OAUTH CONNECTIONS**) to set up an OAuth connection in the Control Room. Ensure you do not save the login credentials so that each user running the automation can provide their login credentials and generate an access token that can only be consumed by that specific user.
- Click **Confirm**.

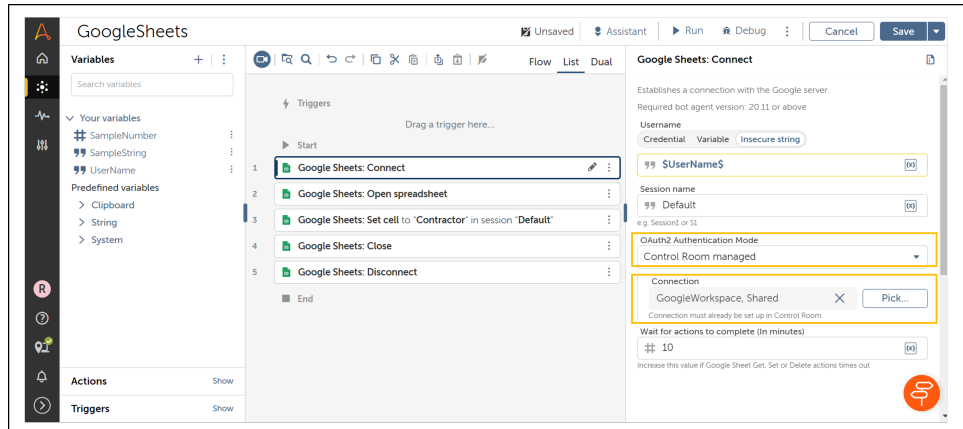

**Note:** When you use **User-specific** option, you must log in to your Google account to authenticate and generate a user-specific token. Perform the following steps to use this option:

- a) In the Control Room, navigate to your profile **My settings > OAuth connections**.
- b) Click **Login to authenticate**.
- c) Sign in to your Google account and select **Continue**.
- d) Verify the services you have access to and Click **Continue**.

If the connection is succeeded, it will display the status as **Active**.

Provider type	Connection name	Shared token status
Custom	GoogleWorkspace	<a href="#">Refresh connection</a> Active

5. For Google Sheets, you can specify the wait time (in minutes) in the **Wait for action to complete (In minutes)** field when performing actions such as **Get**, **Set**, or **Delete**. By default, the wait time is 10 minutes.

If the Google sheet does not open within the time you specify, the task proceeds to execute the next set of actions.

**Note:** When you use **Connect** action to connect to the Google server, the option **Wait for action to complete (In minutes)** is only supported in Google Sheets package.

6. Click **Save**.
7. After you add actions from a specific Google package, use the **Disconnect** action from that same Google package to terminate the connection.

The first time the bot runs, the Google login window is displayed. You must select the Google account and approve the requested access permissions.

The token file gets generated for the first time after you provide the access permissions when the bot gets deployed. It is created based on values that you provide in the **Username**, **Client Id** and

**Client secret** field, and asks for credentials only the first time to provide the access permission. Next time it uses the same token file to connect to the Google Sheets.

The token file is located at `C:\Users\<username>\AppData\Local\AutomationAnywhere\G-SuitAuth`, where `C:\Users\<username>` is the user home directory of the respective system.

If you enter the correct credentials when providing access permissions for the first time and can connect to the Google Sheets successfully, then next time if there is a change in only the password, you need not delete the token file as it will work as expected.

Use other the actions from the same Google package to automate tasks. To use actions from another Google packages, establish a connection using the **Connect** action from that package.

Related reference

[Google Calendar package](#) on page 2692

The **Google Calendar** package contains actions that enable you to automate creating and deleting events.

[Google Drive package](#) on page 2694

Automate tasks related to files and folders by using the actions in the **Google Drive** package.

[Google Sheets package](#) on page 2703

The **Google Sheets** package contains actions that enable you to automate tasks involving cells, columns, rows, and sheets.

## Disconnect action for Google packages

Use the **Disconnect** action from a specific Google package to terminate the connection after you have added actions from the same Google package.

### Settings

- In the **Username** field, you can provide a valid username or select the credential or credential variable that contains your Google username. To enter a value, click **Insecure string**.
- For Google Calendar and Google Sheets packages, enter the session name that you used in the **Connect** action.
- Select the check box **Logout from the browser** if you want to sign off from your account.

## Google Document AI package

Extract data from documents by using the Google Document AI capabilities of the Google Document AI package in your bots.

### Before you start

Create a processor in Google Document AI. [Create a processor](#).

Use the actions in the Google Drive package in the following order:

1. Use the **Connect** action to establish a connection with your Google Cloud service account.



2. Configure the **Extract** action to specify the location of the documents to be extracted and provide the processor details.
3. Use the **Disconnect** action to terminate the connection.

## Actions in the Google Document AI package

The Google Document AI package includes the following actions:

Action	Description
Connect	<p>Establishes a connection with the Google Cloud service account.</p> <p>Provide the following:</p> <ul style="list-style-type: none"> <li>• <b>Key file path</b>: Select the JSON file that contains your Google Cloud service account key.</li> <li>• <b>Google Cloud service session</b>: Enter a unique name for the session.</li> </ul>
Extract	<p>Sends documents to Google Document AI for data extraction.</p> <p><a href="#">Using the Extract action for Google Document AI on page 2721</a></p>
Disconnect	<p>Disconnects from the Google service account.</p> <p>In the <b>Session name</b> field, enter the name of the session that you used to connect to the Google service account in the <b>Connect</b> action.</p>

Related reference

[Google Doc AI package updates](#)

## Using the Extract action for Google Document AI

Configure the **Extract** action to enable your bot to send documents to Google Document AI for data extraction and retrieve the output in JSON format.

Login to your Google Cloud account and go to the Processors page to retrieve your custom endpoint. See [Use your processor endpoint](#).

Your custom endpoint should follow this format: `https://LOCATION-documentai.googleapis.com/API_VERSION/projects/PROJECT_ID/locations/LOCATION/processors/PROCESSOR_ID`. You will need the parameters in bold to configure this action.

1. Double-click or drag the **Google Document AI > Extract** action.
2. In the **Document file path** field, provide the file path to the document you want to process.

**Note:** If using this action within a **Loop** action to process all the documents in a folder, be sure to include a period between the variable holding the file name and the one holding the extension. For example, `C:\Documents\${dictFile (name)}.${dictFile (extension)}`.

---

3. Provide the following information, which is found in your custom endpoint.
  - Project id
  - Processor id
  - Location
4. In the **Session name** field, enter the name of the session you used to connect to the Google service account in the **Connect** action.
5. Optional: Select or create a string variable to hold the output.  
The action returns data in JSON format.
6. Click **Save**.

You can use the actions in the **JSON** package to parse the data and extract values from specific nodes. For an overview of how to do this, refer to the following steps:

1. Initiate the JSON session with the **Start session** action. In the **JSON text** field, insert the string variable holding the output of the **Extract** action.
2. Use the **Get node value** action to parse the output of the **Google Document AI > Extract** action and assign the node values to a list variable.

You can insert a **Loop** action after the **Get node value** action to iterate through each list item to perform an operation on each node value.

3. Terminate the JSON session with the **End session** action.

## IBM Watson Authentication package

The **IBM Watson Authentication** package contains actions that enable you to authenticate the API token and location URL for each service, while connecting to and disconnecting from your IBM Cloud account. With this package, you only have to provide your credentials once.

---

**Important:** This is a beta package and is currently not available with the Automation 360 Enterprise and Cloud editions.

---

### Before you start

Each service requires a unique API key and location URL. Log in to your IBM Cloud account to create an instance of the service to obtain the API Key and location URL. Automation 360 currently includes [Speech to Text](#).

## Actions in the IBM Watson Authentication package

Action	Description
Connect	Establishes a connection with the IBM Cloud account. Insert this action at the beginning of automation sequences that use <b>IBM Watson</b> packages so that you have to input the credentials only once. To use this action, select the services to connect with, then provide the <b>API Key</b> and <b>URL</b> for each service you will use.
Disconnect	Terminates the connection with the IBM Cloud account. Insert this action at the end of automation sequences that use <b>IBM Watson</b> packages.

## IBM Watson Speech to Text package

This package supports the following audio file formats: flac, mpeg, mp3, ogg, pcm, wav, and webm. The following languages are supported: Arabic, Brazilian Portuguese, Chinese (Mandarin), English (United Kingdom and United States), French, German, Japanese, Korean, Spanish (Argentinian, Castilian, Chilean, Colombian, Mexican, and Peruvian).

---

**Important:** This is a beta package and is currently not available with the Automation 360 Enterprise and Cloud editions.

---

Feature	Description
Detect speakers	<p>Identifies the individuals in a conversation between multiple people.</p> <ul style="list-style-type: none"> <li>• Supports English, Japanese, and Spanish.</li> <li>• Use for conversation between two people; maximum six people.</li> <li>• For best results, use an audio file at least a minute long.</li> </ul> <p>The output contains the words spoken by each speaker and the timestamp.</p>
Keyword spotting	Detects specific strings in the transcript. The output contains the timestamp(s) for each keyword and a confidence score.

Feature	Description
Smart formatting	<p>Converts the following types of strings into more conventional representations to make the transcript easier to read:</p> <ul style="list-style-type: none"> <li>• Dates</li> <li>• Times</li> <li>• Series of digits and numbers</li> <li>• Phone numbers</li> <li>• Currency values</li> <li>• Email and web addresses</li> </ul> <p>For examples, see <a href="#">Smart formatting results</a>. This feature supports English, Japanese, and Spanish.</p>
Profanity filter	Obscures profanity by replacing it with asterisks in the transcript.

## If package

Use the actions in the **If** package to control the sequence of execution based on one or more conditions of a task.

Use the actions in the **If** package to check whether an application is running, a folder or file exists, a variable matches the specified value, an application window exists, or a machine or server is running before executing a set of actions.

### Actions in the If package

The **If** package includes the following actions:

Action	Description
If	See <a href="#">If action</a> on page 2730
Else if (optional)	See <a href="#">Else if (optional) action</a> on page 2731
Else	See <a href="#">Else action</a> on page 2731

### Conditions in the If action

Use the following conditions in the **If** action to control the flow of execution in an automation task:

---

**Note:** You can add up to a maximum of 32 conditions in a single **If** action.

---

Condition	Description
Application	<p>Use the <b>Application is running</b> or <b>Application is not running</b> condition to run actions based on whether an application is running or not running.</p> <p>Enter the application path or specify the path using a variable along with the amount of time to wait (in seconds) for the condition to be true.</p> <hr/> <p><b>Note:</b> The <b>Application is running</b> and <b>Application is not running</b> conditions are not applicable for Internet Explorer bots because its corresponding process <code>iexplore.exe</code> runs in the background when <b>Microsoft Edge</b> is launched in <b>IE mode</b>.</p> <hr/>
Boolean	<p>Use the <b>Boolean variable</b> condition to execute actions based on whether a Boolean variable contains the value <b>True</b> or <b>False</b>.</p> <p>You can also use this condition to compare the values of two Boolean variables by selecting the second variable from the <b>Insert a Variable</b> window.</p>
Data table	<p>Use the <b>Data table is empty</b> condition to execute actions based on whether the specified table contains values.</p> <p>Use the <b>Number of rows</b> and <b>Number of columns</b> conditions to execute actions based on whether the number of columns or rows is <b>Equal to</b>, <b>Greater than</b>, or <b>Less than</b> the specified value.</p>
Datetime	<p>Use the <b>Datetime variable</b> condition to execute actions based on whether the value of the source datetime variable is <b>Equal to</b> or <b>Not Equal to</b>, is <b>Greater than</b> or <b>Equal to</b>, or is <b>Lesser than</b> or <b>Equal to</b> the value of the target datetime variable.</p>
Dictionary	<p>Use the <b>Check key</b> condition to execute actions based on whether the value of the specified key is <b>Equal to</b> or <b>Not equal to</b>, or <b>Contains</b> or <b>Does not contain</b> the target value.</p> <hr/> <p><b>Note:</b> The key comparison is case-sensitive.</p> <hr/> <p>Use the <b>Check for a single value</b> condition to execute actions based on whether a specific key contains the target value.</p>
DLL	<p>Use the <b>Dll session exists</b> and <b>Dll session does not exist</b> condition to execute actions based on whether a Dll session is open or closed in a bot.</p>

Condition	Description
File	<p>Use the following conditions to execute the action:</p> <ul style="list-style-type: none"> <li> <b>File date</b>            Use this condition to verify the date and time when a file was created or modified. Specify a date or date range using the <b>On a date</b>, <b>Is within last</b>, <b>Is between</b>, or <b>Is before</b> options. For the <b>On a date</b> option, specify a date to verify whether the file was created or modified on that date. For the <b>Is within last</b> option, specify the number of days or time (in hours, minutes, and seconds). Enter the amount of time (in seconds) to wait for this condition to be true.         </li> <li> <b>File exists and File does not exist</b>            Use these conditions to execute an action based on whether a file exists. For example, if a data file exists, format the file and upload it to a database.         </li> <li> <b>File extension</b>            Use this condition to check the file extension of a selected file and then execute actions based on the results. Use the <b>File path</b> field to select a file.         </li> <li> <b>File size</b>            This condition verifies if the specified file is larger, smaller, not the same, or the same as the size you specify.             Enter the amount of time (in seconds) to wait for this condition to be true.         </li> </ul>
Folder	<p>Use the <b>Folder exists</b> or <b>Folder does not exist</b> condition to execute an action based on whether a folder exists.</p>
Image Recognition	<p>Use these conditions to verify whether:</p> <ul style="list-style-type: none"> <li><b>Image file</b> is found in the <b>Image file</b> or not.</li> <li><b>Image file</b> is found in the <b>Window</b> or not.</li> <li><b>Window</b> is found in the <b>Image file</b> or not.</li> <li><b>Window</b> is found in the <b>Window</b> or not.</li> </ul> <p>For the <b>Window</b> conditions, you can use the <b>Resize window</b> option to specify the window dimensions. This option delivers a more reliable bot. It resizes the window to the dimensions at which the task was recorded, which enhances the bot's ability to identify the target object.</p> <hr/> <p><b>Note:</b> This option is only available for windows that can be resized. It is not available for Desktop or Taskbar options.</p> <hr/> <p>For the <b>Window</b> conditions, you can use the <b>Preview</b> option to select a specific captured occurrence and position your click location relative to the image.</p>

Condition	Description
JavaScript	Use the <b>Script is successful</b> or <b>Script is unsuccessful</b> condition to execute actions based the status of the specified JavaScript. Select the file that contains the script and optionally specify the parameters by selecting a list variable.
Legacy automation	<p>The <b>Legacy automation</b> conditions are only used in migrated bots to ensure that they run seamlessly in Automation 360. We do not recommend using these conditions for new bot development. The following conditions to verify the following:</p> <ul style="list-style-type: none"> <li>• Whether <b>Web control</b> exists or not.</li> <li>• Whether <b>Window control</b> exists or not.</li> <li>• Whether <b>Window control</b> is active or not.</li> <li>• Whether <b>Script</b> is successful or not.</li> <li>• Whether <b>Child window</b> exists or not.</li> </ul> <p>For the <b>Window control</b> conditions, you can use the <b>Resize window</b> option to specify the window dimensions. This option delivers a more reliable bot. It resizes the window to the dimensions at which the task was recorded, which enhances the bot's ability to identify the target object.</p>
List	Use the <b>List variable</b> condition to execute actions based on whether the specified list variable contains a particular value. The value can be of <b>Number</b> , <b>String</b> , or <b>Boolean</b> data type.
Number	Use the <b>Number variable</b> condition to execute actions based on whether the specified number variable is <b>Equal to</b> or <b>Not Equal to</b> , or is <b>Greater than</b> or <b>Equal to</b> , or is <b>Lesser than</b> or <b>Equal to</b> a particular value.
Ping	Use the <b>Ping is successful</b> or <b>Ping is unsuccessful</b> condition to verify if a machine or server is running, and execute actions based on the result. Enter the amount of time (in seconds) to wait for the condition to be true.
Recorder	<ul style="list-style-type: none"> <li>• Use the <b>Object exists</b> condition to detect an object in a window. Select a window or variable to capture the object. Enter the amount of time (in seconds) to wait for this condition to be true, that is, for the object to be detected.</li> <li>• Use the <b>Object does not exist</b> condition to verify whether a specific object exists in a window, and then based on the result, execute actions. Enter the amount of time (in seconds) to wait for this condition to be true. For example, you can use the <b>Object does not exist</b> condition inside the <b>Loop &gt; While</b> condition to make sure that the bot does not execute the next action until the object on the business application is loaded.</li> </ul> <hr/> <p><b>Note:</b> The <b>Object exists</b> and <b>Object does not exist</b> Recorder conditions support Chromium-based Microsoft Edge with Internet Explorer mode.</p> <hr/>

Condition	Description
Service	Use the <b>Service is running</b> or <b>Service is not running</b> condition to execute actions based on whether a service is running or not. Select <b>Service list</b> to choose a service from the list of available services.
String	<p>Use the <b>String variable</b> condition to execute actions based on whether the specified source string value is <b>Equal to</b> or <b>Not equal to</b>, or <b>Includes</b> or <b>Does not include</b> the target value.</p> <p>You can select the <b>Match case</b> option to only execute actions if the two strings have matching uppercase and lowercase letters.</p> <p>When you extract text from a Microsoft application, the extracted text contains the /r/n special characters which indicate a new line. Select the <b>Ignore Carriage return</b> option if you want to ignore the /r special character when you compare the text.</p> <p>To create a condition based on whether a string is empty or not empty, compare the source value to an empty target field using the <b>Equal to</b> operator.</p> <p>See <a href="#">Example of using a conditional statement</a> on page 3208.</p>
Task Bot	Use the <b>Task successful</b> or <b>Task unsuccessful</b> condition to execute actions based on the status of the specified Task Bot.
VBScript	Use the <b>Script is successful</b> or <b>Script is unsuccessful</b> condition to execute actions based on the status of the specified Visual Basic script. Select the file that contains the script and optionally specify the parameters by selecting a variable.



Condition	Description
Window	<p>Use the <b>Window exists</b> or <b>Window does not exist</b> condition to verify if a specific application window is open by entering the <b>Window title</b> or using a variable. Enter the amount of time (in seconds) to wait for the condition to be true. These conditions are used when the window title remains constant and to verify if the specific window is open and execute further actions based on the output.</p> <p>The <b>Window exists</b> condition uses the same window variable to search the specific window from cache. For example, when you open a <code>Yahoo India</code> web page and perform a <b>Click</b> action on the <b>News</b> option on the web page, the action navigates you to another page which changes the title of the window. In this case, when you use the <b>Window exists</b> condition to verify if the window exists, the bot still fetches the <code>Yahoo India</code> web page from the cache and performs action on it because the window is still the same but only the title has changed. For more information on how window variables work, see <a href="#">Your variables (user-defined)</a> on page 2331</p> <p>Use the <b>Window with same title does not exist</b> or <b>Window with same title exist</b> condition to verify whether a window with the same title exists or whether the window title has changed. Enter the amount of time (in seconds) to keep verifying if the condition is true. These conditions are used for window titles that are dynamic. For example, when you open a Google account webpage, enter your username and password to log into your account, the window title changes. If you want to compose a new email as a next action, you can use these conditions before you execute the next action to verify if the window with the same title exists or if the title has changed.</p>

## Group conditions

Use the **Add group** option to add multiple Boolean conditions or combine more than one conditions with **And** and **Or** options within a group and when you want the to check multiple conditions at a time before executing a set of .

You can also add a group within a group.

## Example

[Build a basic bot that uses a desktop application](#) on page 3199

An example of how to build a basic TaskBot that uses the If package.

Related reference

[If package updates](#) on page 894

Review the updates in released versions of the If package such as new and enhanced features as well as fixes and limitations. The page also lists the release dates of each version, and the compatible Control Room and Bot Agent versions.

## If action

The If action in the If package enables you to specify a condition and hold a sequence of actions to run if the condition is true.

## Settings

You can configure multiple conditions within a single **If** action.

1. Click **Add condition**.
2. Select either of the following options:
  - **And**: Both of the conditions must be met for the to run.
  - **Or**: Either of the conditions must be met for the to run.
3. Select the condition from the drop-down list.

See [Using If action](#) on page 2730.

## Using If action

Use the **If Else If** and **If Else** actions to change the flow of execution in an automation task based on certain conditions.

To use the actions in the **If** package, do the following:

1. Double-click or drag the **If** action from the **If** package in the **Actions** palette.
2. Select the required condition from the **Condition** list.  
See [If package](#) on page 2724 for a list of available conditions.
3. Drag the actions to be executed if the condition is satisfied within the **If** condition.
4. Double-click or drag the **Else If** action from the **If** package in the **Actions** palette to include alternative actions to run if the condition for the **If** action is false, and if the condition for the **Else If** action is true.
5. Drag the actions to be executed if the condition is satisfied within the **Else If** condition.
6. Double-click or drag the **Else** action from the **If** package in the **Actions** palette to include actions to run if the conditions for the **If** and **Else If** actions are false.
7. Drag the actions to be executed if the condition is satisfied within the **Else** condition.
8. Click **Save**.

## Else if (optional) action

The Else if (optional) action in the If package enables you to specify an alternative condition to test if the condition specified in the If action is false.

### Settings

If this alternative condition is true, the bot runs the sequence of actions contained within the **Else if** action.

You can configure multiple conditions within a single **Else if** action.

1. Click **Add condition**.
2. Select either of the following options:
  - **And**: Both of the conditions must be met for the to run.
  - **Or**: Either of the conditions must be met for the to run.
3. Select the condition from the drop-down list.

## Else action

The Else action in the If package enables you to specify the alternative sequence of actions.

### Settings

Specifies the alternative sequence of actions if the condition specified in the If action and **Else if** action (if used) is false.

## Image Recognition package

The **Image Recognition** package contains actions that enable you to search for a user interface (UI) element in an application based on an image to automate a task in that application.

### Actions in the Image Recognition package

Use these actions to automate a task when it is not possible to capture UI elements of applications that are:

- Exposed over Citrix
- Accessed using the Remote Desktop Protocol (RDP)
- Developed using legacy technology

Image recognition is also useful when object-based recognition does not work or is unreliable. For example, you can use an image to search for the **Close** button in an application and perform a left-click operation.

The **Image Recognition** package contains the following actions:

Action	Description
Find image in window	See <a href="#">Using Find image in window action</a> on page 2732.
Find window in window	See <a href="#">Using the Find window in window action</a> on page 2735.

## Secure recording

When secure recording mode is enabled, bots display only the target image but not the source image. This ensures that sensitive data is not shown. To see a preview of the source image in the **Preview** window, click the **Preview** button.

**Note:** The target images are still stored in the Control Room because they are required to run the bots.

A user with admin privileges must enable this setting. See [Settings](#) on page 1789.

## Secure recording

When secure recording mode is enabled, bots do not display the target object images after capture. This ensures that sensitive data is not shown.

**Note:** Although the bots do not display the target images after capture, the images are still stored in the Control Room because they are required to run the bots.

When you record a task in secure recording mode, the **Preview** window temporarily shows an image of the captured area. This image is hidden after you navigate away from the Bot editor window or refresh it.

A user with admin privileges must enable this setting. See [Settings](#) on page 1789.

Related reference

[Screen resolution dependent packages](#) on page 1802

The screen resolution between the Bot Runner and Bot Creator device should be consistent as when resolution-dependent packages are used to build bots, any screen resolution difference between the Bot Creator and Bot Runner device will impact the bots during runtime.

[Image Recognition package updates](#) on page 896

Review the updates in released versions of the Image Recognition package such as new and enhanced features as well as fixes and limitations. The page also lists the release dates of each version, and the compatible Control Room and Bot Agent versions.

## Using Find image in window action

Use the **Find image in window** action to search for a UI element in an application window (haystack) using a target image (needle). The target image is an existing image that you can use to search for a UI element.

To find an image inside an application window, follow these steps:

1. Double-click or drag the **Find image in window** action from the **Image Recognition** package in the **Actions** palette.
2. Specify the target image (needle) that you want to find in the application window.
  - **Control Room file**: Uses an image file that is available on the Control Room.
  - **Desktop file**: Uses an image file that is available on your device.
  - **Variable**: Uses a file variable to specify the location of the image file you want to use.

---

**Note:** Images of .jpeg, .jpg, .jpe, .jfif, .bmp, .png, and .gif formats are supported.

---

3. Specify the window in which you want to find the source image (haystack):  
Choose from the **Application**, **Browser**, or **Variable** tab.

Option	Description
Application	Select from a list of currently active windows. This option shows a list of all the application and browser windows that are open on the Bot Creator device.
Browser	Select from a list of supported browser tabs.  <b>Note:</b> This option supports , Chromium-based , and browsers. For all other browsers, use the <b>Application</b> option.
Variable	Select an existing window variable to specify the title of the application window title.

Insert a wildcard character (\*) in the **Window title** field to search for window titles that can change. You can specify one or more wildcards (\*) at the start, middle, or end of the value. For example, to perform an operation on any window that has `Microsoft` in the title, use a wildcard to indicate any string by adding it before or after the value: `*Microsoft*`. The first searches for the exact window title (`Microsoft`), and if it does not find a match, it searches for windows with the term `Microsoft` anywhere in the title.

You can use a regular expression (regex) to identify a window title. Select the regular expression condition as either **String** or a **Pattern** and then enter the value. By default, the **Window title** field is case-sensitive.

To identify a browser title, you can enable the **Case sensitive** option to match the letter case, or disable the option to identify a window title where the letter case does not match.

---

**Note:** Ensure that the minimum version installed on your system is the version that was released with v.26. If you have a version released with v.25 or earlier, then by default, the window title will be identified only with matching letter case (case-sensitive).

---

For example, you can enter the **String** value as `( (\w*) -Notepad` for all window title names starting with `( (\w*) -Notepad`, or use **Pattern** value as `( (\w) \s) *document-Notepad` for only those window titles that match this pattern.

---

**Note:**

- When you use a regular expression of type **String** with `-title` as the input value for a window title in any , the might encounter a run time error. To prevent the run time error,

ensure that when you add the string input as `*-title`, the application with the specific title is open. The asterisk (\*) is just a character, not a wild card character.

- When you use a regular expression of type **Pattern** with `-title` as the input value for a window title in any , the might encounter a run time error because the input value `*-title` is incorrect.

Ensure that you use valid regex patterns.

- 
4. Optional: Select the **Resize window** option to specify the window dimensions.

This option delivers a more reliable bot. It resizes the window to the dimensions at which the task was recorded, which enhances the ability of the bot to identify the target object.

- If the window is maximized when you record the task, this option is not selected.
- If the window is not at the maximum size when you record the task, this option is selected, by default, and the width and height fields are automatically filled with the dimensions of the window.

---

**Note:** This option is available only for windows that can be resized. It is not available for the **Desktop** or **Taskbar** options.

---

5. Click **Capture region**.

The selected window appears.

6. Drag the mouse to select the area and right-click when done.

The captured area appears in the **Preview** section with the image coordinates underneath.

7. In the **Wait in ms before capturing the image** field, specify the delay (in milliseconds) before searching for the image.

8. Select the **Repeat if image not found** check box if you want the system to retry searching for the target image if it is not found.

a) In the **Times** field, specify the number of times the system must repeat the process to find the target image.

b) In the **Wait between repeats (ms)** field, specify the time period the system must wait before repeating the process of finding the target image.

9. In the **Match percentage** field, specify the acceptable percentage of matching pixels between the two images.

For example, if you specify 20 in the field as the match percentage, the system considers the images as matching even if there is up to 80% of pixel mismatch between the two images.

10. In the **Selected match number** field, enter a value to specify the occurrence of the target image on which you want to perform this action.

You can insert a variable when you do not know the number of times the image might appear on the screen. Ensure you assign variables that support numeric values.

11. Use the **Preview** option if you want to select an image that is relative (offset) to the existing target image you are searching on the application screen, or you want to select a specific occurrence if there are multiple occurrences of the target image.

12. Click **Preview**.

If a target image occurs multiple times in the **Preview** window, each occurrence is highlighted in a rectangular box and displays a number against each occurrence.

13. Select the specific highlighted occurrence, and you can position your click location relative to an existing image.

**Note:** If there are multiple images on an application screen that you are automating and when the target image is not easily searchable; in that case, you can select an easily identifiable image in the captured region and position your click relative to it.

14. If the target image is found multiple times in the captured region. In that case, you can select the occurrence of a particular target image or select the occurrence number from the drop-down in the **Match number (optional)** field on the right pane.

The **Match number (optional)** and the **Target Offset** fields on the right pane display the image occurrence you selected and its offset coordinates of the target image.

15. Click **Submit**.

16. In the **Target coordinate selections** field, the coordinate options **Center of match** or **Offset from match** will be selected automatically based on the action you performed in the **Preview** window.

- **Center of match:** The image is selected based on the coordinates at the center of the matched image.
- **Offset from match:** The image is selected based on the coordinates relative to that of the matched image.

**Note:** The offset coordinates measure the number of pixels from the top left corner of the image.

17. Select an option from the **Action to take on target coordinates** list to specify the action you want to perform on the matched image in the application window.
18. Click **Save**.

## Using the Find window in window action

Use the **Find window in window** action to search for a UI element in an application window using a screenshot of a window. This action enables you to capture an image of a UI element in an application and use the captured image to search for that UI element in another window.

To use an image available in an application window to find an image in another application window, follow these steps:

1. Double-click or drag the **Find image in window** action from the **Image Recognition** package in the **Actions** palette.
2. Specify the target image (needle) that you want to find in the application window.

Option	Description
Browser	Select from a list of supported browser tabs.  <b>Note:</b> This option supports , Chromium-based , and browsers. For all other browsers, use the <b>Application</b> option.
Application	Select from a list of currently active windows. This option shows a list of all the application and browser windows that are open on the Bot Creator device.

You can use a regular expression (regex) to identify a window title. Select the regular expression either as a **String** or **Pattern** for each regular expression condition and enter the value. By default, the **Window title** field is case-sensitive. You can enable **Case insensitive** regex flag to identify a window title that is not case-sensitive.

To identify a browser title, you can enable the **Case sensitive** option to match the letter case, or disable the option to identify a window title where the letter case does not match.

**Note:** Ensure that the minimum version installed on your system is the version that was released with v.26. If you have a version released with v.25 or earlier, then by default, the window title will be identified only with matching letter case (case-sensitive).

3. Click **Capture image** to capture the target image.
4. Drag the mouse pointer over an area of the application window.  
The captured area appears in the **Preview** section.
5. Specify the window in which you want to find the source image (haystack):  
Choose from the **Application**, **Browser**, or **Variable** tab.

Option	Description
Application	Select from a list of currently active windows. This option shows a list of all the application and browser windows that are open on the Bot Creator device.
Browser	Select from a list of Google Chrome tabs that are currently open on the Bot Creator device.  <b>Note:</b> Currently, this option only supports Google Chrome tabs. For all other browsers, use the <b>Application</b> option.
Variable	Select an existing window variable to specify the title of the application window title.

Insert a wildcard character (\*) in the **Window title** field to search for window titles that can change. You can specify one or more wildcards (\*) at the start, middle, or end of the value.

For example, to perform an operation on any window that has `Microsoft` in the title, use a wildcard to indicate any string by adding it before or after the value: `*Microsoft*`. The bot first searches for the exact window title (`Microsoft`), and if it does not find a match, it searches for windows with the term `Microsoft` anywhere in the title.

You can use a regular expression (regex) to identify a window title. Select the regular expression either as a **String** or **Pattern** for each regular expression condition and enter the value. By default, the **Window title** field is case-sensitive. You can enable **Case insensitive** regex flag to identify a window title that is not case-sensitive. You can enable the **Case sensitive** option to identify a static window or browser title and a title with a wildcard character that is case-sensitive and disable the option to identify a window title that is not case-sensitive.

For example, you can enter the **String** value as `((\w*)-Notepad)` for all the window title names starting with `((\w*)-Notepad)`, or use **Pattern** such as `((\w)\s)*document-Notepad` for only those window titles that match this pattern.

6. Select the **Resize window** option to specify the window dimensions.



This option delivers a more reliable bot. It resizes the window to the dimensions at which the task was recorded, which enhances the bot's ability to identify the target object.

- If the window is maximized when you record the task, this option is unselected.
- If the window is not at the maximum size when you record the task, this option is selected by default and the width and height fields auto-fill with the window dimensions.

---

**Note:** This option is only available for windows that can be resized. It is not available for the **Desktop** or **Taskbar** options.

---

7. Click **Capture region**.

The selected window appears.

8. Drag the mouse to select the area and right-click when done.

The captured area appears in the **Preview** section with the image coordinates underneath.

9. In the **Wait in ms before capturing window** field, specify the delay (in milliseconds) before searching for the image.

10. Select the **Repeat if image not found** check box if you want the system to retry searching for the target image if it is not found.

a) In the **Times** field, specify the number of times the system must repeat the process to find the target image.

b) In the **Wait between repeats (ms)** field, specify the time period the system must wait before repeating the process of finding the target image.

11. In the **Match percentage** field, specify the acceptable percentage of matching pixels between the two images.

For example, if you specify 20 in the field as the match percentage, the system considers the images as matching even if there is up to 80% of pixel mismatch between the two images.

12. In the **Selected match number** field, enter a value to specify the occurrence of the target image on which you want to perform this action.

You can insert a variable when you do not know the number of times the image might appear on the screen. Ensure you assign variables that support numeric values.

13. Use the **Preview** option if you want to select an image that is relative (offset) to the existing target image you are searching on the application screen, or you want to select a specific occurrence if there are multiple occurrences of the target image.

14. Click **Preview**.

If a target image occurs multiple times in the **Preview** window, each occurrence is highlighted in a rectangular box and displays a number against each occurrence.

15. Select the specific highlighted occurrence, and you can position your click location relative to an existing image.

---

**Note:** If there are multiple images on an application screen that you are automating and when the target image is not easily searchable; in that case, you can select an easily identifiable image in the captured region and position your click relative to it.

---

16. If the target image is found multiple times in the captured region. In that case, you can select the occurrence of a particular target image or select the occurrence number from the drop-down in the **Match number (optional)** field on the right pane.

The **Match number (optional)** and the **Target Offset** fields on the right pane display the image occurrence you selected and its offset coordinates of the target image.

17. Click **Submit**.
  18. In the **Target coordinate selections** field, the coordinate options **Center of match** or **Offset from match** will be selected automatically based on the action you performed in the **Preview** window.
    - **Center of match**: The image is selected based on the coordinates at the center of the matched image.
    - **Offset from match**: The image is selected based on the coordinates relative to that of the matched image.
- 
- Note:** The offset coordinates measure the number of pixels from the top left corner of the image.
- 
19. Select an option from the **Action to take on target coordinates** list to specify the action you want to perform on the matched image in the application window.
  20. Click **Save**.

## Interactive forms package

The interactive forms package contains actions that handle exceptions encountered by a bot. All the actions performed by users on the interactive forms can be monitored to execute logic using subtasks.

Interactive forms are first-class citizens within the bot repository and have the same workflows for moving forms between public and private workspaces, and for export or import actions. Handling exceptions ensures that a bot completes a task when it encounters an error.

Interactive forms should be used as containers for data to be consumed, collected, and used during bot automation. No human interaction occurs in this type of form. Bot actions can interact with these forms when data is mapped during the bot build from sources like web applications and databases. Users wanting forms during human interaction should use process automation where data can be entered during run time. [Add Form Task to a process automation](#) on page 3458

### Actions in the Interactive forms package

The interactive forms package includes form-level and element-level actions.

The following actions are available at the form level:

Action	Description
<b>Display</b>	Load and display the selected form.  Select or insert a variable in the <b>Form name</b> field to display the form when an event is triggered. Optionally, select the check box to always display the form window in front.
<b>Close</b>	Closes the selected form.

Action	Description
<b>Show</b>	<p>Loads or displays a hidden form.</p> <p>Select or insert a variable in the <b>Form name</b> field for a hidden form, which is displayed on the desktop when an event is triggered.</p>
<b>Hide</b>	Hides the selected form from the user's view.
<b>Reset</b>	<p>Resets the selected form to its default value.</p> <p>Select or insert a variable in the <b>Form name</b> field for a form. All the values of this specified form are reset when an event is triggered.</p>
<b>Validate form</b>	<p>Validates all the elements within the selected form.</p> <ul style="list-style-type: none"> <li>• Select or insert a variable in the <b>Form name</b> field for a specific form, which is validated when an event is triggered.</li> <li>• Select the next event by creating or selecting a variable using the <b>Assign the return value to a boolean variable</b> field.</li> </ul> <hr/> <p><b>Note:</b> The <b>Validate form</b> action is not applicable to <b>Rich Text Editor</b> elements.</p> <hr/>
<b>Change Form Title</b>	<p>Changes the title of the selected form.</p> <ul style="list-style-type: none"> <li>• Select or insert a variable in the <b>Form name</b> field for a specific form.</li> <li>• Enter the new title that must appear for the selected form in the <b>New Title (optional)</b> field.</li> </ul>

The following actions are available at the element level:

Action	Description
<b>Assign</b>	<p>Assigns dynamic values to the <b>Dropdown</b> element of a form.</p> <ul style="list-style-type: none"> <li>• Select or insert a variable in the <b>Form name</b> field.</li> <li>• Select the <b>Dropdown</b> element of the form from the <b>Form element</b> field, which is enabled when an event is triggered.</li> <li>• Use <b>Assign</b> to set one of the following actions: <ul style="list-style-type: none"> <li>• <b>Append:</b> Specified values or variables are added to the selected <b>Dropdown</b> element.</li> <li>• <b>Overwrite:</b> Specified values or variables replace the existing data in the selected <b>Dropdown</b> element.</li> </ul> </li> </ul> <hr/> <p><b>Note:</b> The <b>Assign</b> action is now applicable for the <b>Checkbox</b> and <b>Radio Button</b> elements in interactive forms.</p> <hr/>

Action	Description
<b>Enable</b>	<p>Enables the specified element of the selected form.</p> <ul style="list-style-type: none"> <li>• Select or insert a variable in the <b>Form name</b> field.</li> <li>• Select a specific element of the form from the <b>Form element</b> field, which is enabled when an event is triggered.</li> </ul>
<b>Disable</b>	<p>Disables the specified element of the selected form.</p>
<b>Get</b>	<p>Retrieves the value from the specified element of the selected form.</p> <ul style="list-style-type: none"> <li>• Select or insert a variable in the <b>Form name</b> field and use the <b>Form element</b> to select a specific element of the form.</li> <li>• Use the <b>Returns the value</b> drop-down menu to assign this value to a variable when an event is triggered.</li> </ul> <p><a href="#">Create a variable</a> on page 2336</p>
<b>Set</b>	<p>Assigns the user-defined or global variable to the selected element of the specified form.</p> <ul style="list-style-type: none"> <li>• Select or insert a variable in the <b>Form name</b> field and use the <b>Form element</b> to select a specific element of the form.</li> </ul> <p>If you select <b>Table</b> as the <b>Form element</b>, use the <b>Set Value Type</b> to enable the following additional options:</p> <ul style="list-style-type: none"> <li>• <b>Table</b>: Sets the variable value to the entire table.</li> <li>• <b>Row</b>: Sets the variable value to the selected row.</li> </ul> <ul style="list-style-type: none"> <li>• Use the <b>Input value</b> to assign a user-defined or system variable into this element when an event is triggered.</li> </ul>
<b>Set focus</b>	<p>Sets the focus on the selected element of a form.</p> <ul style="list-style-type: none"> <li>• Select or insert a variable in the <b>Form name</b> field.</li> <li>• Use the <b>Form element</b> to select the specific element of the form and set the focus: <ul style="list-style-type: none"> <li>• For form elements such as a text box, text area, number or date, the cursor appears on the element.</li> <li>• For form elements such as a check box or radio button, the emphasis is on the first option.</li> </ul> </li> </ul>

Action	Description
<b>Highlight</b>	<p>Highlights the specified element of the selected form.</p> <ul style="list-style-type: none"> <li>• Select or insert a variable in the <b>Form name</b> field.</li> <li>• Use the <b>Form element</b> to select the specific element of the form to highlight it when an event is triggered.</li> <li>• Use the <b>Highlight Type</b> drop-down menu to select one of the following: <ul style="list-style-type: none"> <li>• <b>Warning</b>: Displays a warning alert on the specified form element.</li> <li>• <b>Error</b>: Displays an error alert on the specified form element.</li> </ul> </li> </ul>
<b>Unhighlight</b>	Removes the highlight from the specified element of the selected form.
<b>Change label</b>	<p>Changes the label of the selected form element.</p> <ul style="list-style-type: none"> <li>• Select or insert a variable in the <b>Form name</b> field.</li> <li>• Use the <b>Form element</b> to select the specific element of the form for which the label must change when an event is triggered.</li> <li>• Enter the name in <b>New label</b> field.</li> </ul> <hr/> <p><b>Note:</b> The <b>Change label</b> action is now applicable for <b>Button</b> elements in interactive forms.</p> <hr/>
Dynamic area	
<b>Add row in Dynamic area</b>	<p>Applies only to forms that have a <b>Dynamic</b> element. This action renders the selected form field as a single row when the bot starts.</p> <ul style="list-style-type: none"> <li>• Select or insert a variable in the <b>Form name</b> field.</li> <li>• Use the <b>Dynamic area</b> drop-down menu to select the dynamic element of the form.</li> <li>• Use <b>Append</b> or <b>Overwrite</b> to add a row for the specified dynamic area.</li> <li>• Use <b>Add element</b> to insert elements into the dynamic area. <ul style="list-style-type: none"> <li>• Use the <b>Type</b> drop-down menu to select the element type such as Checkbox group, Drop-down, File, Radio group, Snapshot, Text area, or Textbox.</li> <li>• Use the <b>Label</b> field to enter a name for the element.</li> <li>• Click <b>Add</b> to add the element.</li> </ul> </li> </ul> <p>You can add up to four elements.</p>
<b>Clear</b>	Clears all the dynamic elements in the specified form.

## IQ Bot Pre-processor package

Use the IQ Bot Pre-processor package to extract content from documents or process image files before they are sent to Automation 360 IQ Bot.

Windows Media Foundation platform must be installed on your Bot Runner machine in order to use the following actions without any errors.

### Actions in the IQ Bot Pre-processor package

The following table lists the actions used for processing image file:

Actions	Description
<b>Concatenate Images</b>	See <a href="#">Using Concatenate Images action</a> on page 2742
<b>Convert Image To PDF</b>	See <a href="#">Using Convert Image To PDF action</a> on page 2743
<b>Edit Image</b>	See <a href="#">Using Edit Image action</a> on page 2743
<b>Enhance Image</b>	See <a href="#">Using Enhance Image action</a> on page 2745
<b>Orient Image</b>	See <a href="#">Using Orient Image action</a> on page 2749

The following table lists the actions used for extracting content from documents:

Actions	Description
<b>Get Bar Codes</b>	See <a href="#">Using Get Bar Codes action</a> on page 2744
<b>Get Document Info</b>	See <a href="#">Using Get Document Info action</a> on page 2744
<b>Get Page Content</b>	See <a href="#">Using Get page content action</a> on page 2745

To learn more, review the courses in IQ Bot Developer learning trail: [IQ Bot Developer Training \(A-People login required\)](#).

## Using Concatenate Images action

Use the **Concatenate Images** action in the IQ Bot Pre-processor package to link two image files.

1. Drag the **IQ Bot pre-processor > Concatenate Images** action into your workflow.
2. Use the **Input file path 1** field to select the first input file from **Control Room file**, **Desktop file** or **Variable**.
3. Optional: If you selected **Control Room file** or **Desktop file**, click **Browse** to change the default filepath.
4. Use the **Input file path 2** field to select the second input file.
5. Select the output folder from the **Output Path** field.
6. Optional: Click **Browse** to change the default output filepath.
7. Use the **Concatenate Type** field to select one of the following options:
  - **Vertical**: To vertically concatenate or link the selected images.

- **Horizontal:** To horizontally concatenate or link the selected images.
8. Optional: Use the **Assign output status to variable** field to set the output status of action during bot runtime.
  9. Click **Save**.  
When the bot runs successfully, the combined image file is saved in the specified output folder.

## Using Convert Image To PDF action

Use the **Convert Image To PDF** action in the IQ Bot Pre-processor package to convert a selected image file to a text-enabled PDF document. The converted PDF file retains the name of the input image file by default.

1. Drag the **IQ Bot pre-processor > Convert Image To PDF** action into your workflow.
2. Select the input file from **Control Room file**, **Desktop file** or **Variable**.
3. Optional: If you selected **Control Room file** or **Desktop file**, click **Browse** to change the default filepath.
4. Use the **Output Path** field to select the output folder for the PDF document.
5. Optional: Click **Browse** to change the default output filepath.
6. Optional: Choose from the following advance settings:
  - **Input file settings:** Use this field to select various input file settings.  
For example, if the input file is a legal document (a bank check), select the **Has MICR** check box.
  - **Process settings:** Use this field for processing the output file.  
For example, select the **Process text blocks independently** check box if the OCR engine must process various blocks of the input file as a specific text type.
7. Optional: Use the **Save the output status of the action as boolean** to set the output status.
8. Click **Save**.  
When the bot runs successfully, the processed PDF file is saved in the specified output folder.

## Using Edit Image action

Use the **Edit Image** action in the IQ Bot Pre-processor package to resize an image file.

1. Drag the **IQ Bot pre-processor > Edit Image** action into your workflow.
2. Select the input file from **Control Room file**, **Desktop file** or **Variable**.
3. Optional: If you selected **Control Room file** or **Desktop file**, click **Browse** to change the default filepath.
4. Use the **Output Path** field to select the output folder.
5. Optional: Click **Browse** to change the default output filepath.
6. Use the **Select Image Edits** drop-down menu to select one of the following options:
  - **Crop:** Use an auto-crop or manual option to crop the image.
  - **Resize:** Change the height and width of the image.

7. Optional: Use the **Assign output status to variable** field to set the output status of action during bot runtime.
8. Click **Save**.  
When the bot runs successfully, the edited image file is saved in the specified output folder and is suffixed by the word processed.  
  
For example, if the image filename is `Sales.png`, the processed file is saved as `Sales_processed.png`

## Using Get Bar Codes action

Use the **Get Bar Codes** action in the IQ Bot Pre-processor package to detect and extract all available barcodes from a document.

1. Drag the **IQ Bot pre-processor > Get Bar Codes** action into your workflow.
2. Select the input file from **Control Room file**, **Desktop file** or **Variable**.
3. Optional: If you selected **Control Room file** or **Desktop file**, click **Browse** to change the default filepath.
4. Use the **List of dictionaries with 7 keys** drop-down menu to select the output format for the extracted strings.

If the document has multiple barcodes, multiple dictionaries are used as each dictionary corresponds to a single barcode. Each dictionary has the following seven keys that relate to the various attributes of the barcode in a document:

- Page number of the document where a barcode is available
- Type of the barcode
- Value of the barcode
- X coordinate of the barcode
- Y coordinate of the barcode.
- Width of the barcode
- Height of the barcode

5. Click **Save**.  
When the bot runs successfully, the extracted barcodes are assigned to the output variable.

## Using Get Document Info action

Use the **Get Document Info** action in the IQ Bot Pre-processor package to extract document information such as the page count and extension type.

1. Drag the **IQ Bot pre-processor > Get Document Info** action into your workflow.
2. Select the input file from **Control Room file**, **Desktop file** or **Variable**.
3. Optional: If you selected **Control Room file** or **Desktop file**, click **Browse** to change the default filepath.
4. Use the **Dictionary object with 5 keys** drop-down menu to select the output format for the extracted information.

Each dictionary has the following five keys that relate to the various attributes of the document:

- Filepath of the document location



- Extension type of the document
  - File type of the document
  - Total number of pages in the document
  - File size of the document
5. Click **Save**.
- When the bot runs successfully, all the extracted information for the selected document is assigned to the output variable.

## Using Get page content action

Use the **Get page content** action in the IQ Bot Pre-processor package to extract text from a specific page of a document (PDF, image file) into a list of strings.

1. Drag the **IQ Bot pre-processor > Get page content** action into your workflow.
2. Select the input file from **Control Room file, Desktop file** or **Variable**.
3. Optional: If you selected **Control Room file** or **Desktop file**, click **Browse** to change the default filepath.
4. Enter the page number of the selected document from which the content must be extracted.
5. Use the **List of strings extracted from page** drop-down menu to select the output format for the extracted strings.

You can use this menu to create a variable with **Type > List** and **Subtype > String**. Alternatively, you can select an existing variable with **Type > List**, and **Subtype > String** or **Subtype > Any**.

6. Click **Save**.
- When the bot runs successfully, the content extracted from the specific page of the selected document assigned to the output variable.

## Using Enhance Image action

Use the **Enhance Image** action in the IQ Bot Pre-processor package to enhance a selected image file.

1. Drag the **IQ Bot pre-processor > Enhance Image** action into your workflow.
2. Select the input file from **Control Room file, Desktop file** or **Variable**.
3. Optional: If you selected **Control Room file** or **Desktop file**, click **Browse** to change the default filepath.
4. Use the **Output Path** field to select the output folder.
5. Optional: Click **Browse** to change the default filepath.
6. Optional: Click **Add effect** and use **Effect type** drop-down menu for image enhancement options.

For more information on the available options, see [Image enhancement options in Enhance Image action](#) on page 2746.

Consider a scenario where you have uploaded a low quality image. Use the following options to improve the clarity and increase the brightness:

- Select **Effect type > SHARPEN**.

Additional fields associated with sharpening an image such as Gaussian blur, Alpha, Beta and Gama are displayed.

- For this example, enter 5 in the **Alpha** field.

Value between 0 to 10 can be used in the additional fields. Optionally, you can also press F2 or click **Insert a value** option to select a system value.

- Select **Effect type > BRIGHTNESS**.
- Enter 7 in the **Brightness factor** field.

The selected enhancement options are listed in the **Effect type** field, and you can edit or delete a specific effect type.







7. Click **Add**.
8. Optional: Use the **Assign output status to variable** field to set the output status of action during bot runtime.
9. Click **Save**.  
When the bot runs successfully, the enhanced image file is saved in the specified output folder.

## Image enhancement options in Enhance Image action

Improve the quality of an image that you have uploaded in the **Enhance Image** action by using additional options available.

Option	Use
<b>Grayscale</b>	Convert the color pixels in an image to grayscale. Recommended: Convert color images to grayscale to improve the OCR extraction accuracy.
<b>Blur</b>	Smoothen out areas that are pixelated and improve image quality. Recommended values: Any odd number (such as 3, 7, and 11), as long as it is less than the pixel size of the uploaded image.

Option	Use
<b>Sharpen</b>	<p>Improve clarity by removing distorted and blurred aspects of the original image.</p> <p>Consider a scenario where you have an image file called ImageA. When you apply Gaussian blur = 5 to this image, a blurred version of this image is created called ImageB. You can then use the following <b>Sharpen</b> parameters:</p> <ul style="list-style-type: none"> <li>• Alpha: 3</li> <li>• Beta: -1</li> <li>• Gamma: 0</li> </ul> <p>The following formula is applied for output:  Output = ImageA*Alpha + ImageB*Beta + Gamma</p> <p>Where:</p> <ul style="list-style-type: none"> <li>• ImageA: First input array (Input image)</li> <li>• Alpha: Weight of the first array elements</li> <li>• ImageB: Second input array image with the same size and channel number as ImageA</li> <li>• Beta: Weight of the second array elements</li> <li>• Gamma: Scalar added to each sum</li> </ul> <hr/> <p><b>Note:</b> The principal use of the preceding equation is to sharpen an image by removing the blurriness from the original image.</p> <hr/> <p>Recommended values:</p> <ul style="list-style-type: none"> <li>• Gaussian blur: 0 to 10</li> <li>• Alpha: 1 to 15</li> <li>• Beta: -0.5 to -5</li> <li>• Gamma: 0 to 50</li> </ul>
<b>Denoise</b>	<p>Smoothen out pixels that are not grayscale to remove distortion or speckling from the image.</p> <p>Recommended value: 21. However, it can be any odd number as long as it is less than the pixel size of the uploaded image.</p>
<b>Contrast</b>	<p>Increase or decrease the contrast of the pixels. Values can range from 0 (no change) to 2 (maximum contrast).</p> <p>Recommended values: From 0.8 through 2.</p>
<b>Brightness</b>	<p>Increase or decrease the brightness level of all the pixels in the image. Values can range from -100 (minimum contrast) to 100 (maximum contrast), with 0 representing no change.</p> <p>Recommended values: From 0 through 100</p>

Option	Use
<p><b>Thresholding</b></p>	<p>A form of image segmentation. Thresholding is an image processing method that creates a bi-tonal (binary) image by setting a threshold value on the pixel intensity of the original image. In image processing, thresholding is typically used to separate objects or foreground pixels from background. For example, the following image has been processed using Thresholding value as 200 and 100 respectively.</p> <div style="display: flex; justify-content: space-around; align-items: center;"> <div style="text-align: center;">  </div> <div style="text-align: center;">  </div> <div style="text-align: center;">  <p data-bbox="1307 940 1599 972">Thresholding Value: 200</p> </div> </div> <div style="display: flex; justify-content: space-around; align-items: center; margin-top: 20px;"> <div style="text-align: center;">  </div> <div style="text-align: center;">  </div> <div style="text-align: center;">  <p data-bbox="1307 1480 1599 1512">Thresholding Value: 100</p> </div> </div> <p data-bbox="613 1570 1128 1602">Recommended value: From 0 through 255</p>
<p><b>Remove RGB</b></p>	<p>Provide upper and lower bound values to pixels in a color image. Pixels in a color image are represented by three primary color channels: red, green, and blue (RGB). The output of this effect is a binary image with pixels that are black (0) or white (255). Consider a scenario where you want to transform high-intensity red pixels in the range of 200 to 255 to white (255). You can set the lower bound for red to (200,0,0) and upper bound to (255,0,0).</p>

## Using Orient Image action

Use the **Orient Image** action in the IQ Bot Pre-processor package to change the orientation of a selected image file.

1. Drag the **IQ Bot pre-processor > Orient Image** action into your workflow.
2. Select the input file from **Control Room file**, **Desktop file** or **Variable**.
3. For the **Control Room file** and **Desktop file** tabs, click **Browse** to change the default filepath.
4. Use the **Apply settings** field to change the following orientation options:
  - **Flip**: Use the drop-down menu to flip the image horizontally, vertically, or horizontally and vertically.
  - **Rotate**: Use the drop-down menu to:
    - Rotate the image clockwise or anti-clockwise.
    - Change the angle of the image.

For example, enter 45 if you want to change the image angle by 45 degrees.

5. Click **Save**.

When the bot runs successfully, the modified image file is saved in the specified output folder.

## IQ Bot Extraction package

Capability to automatically extract values provides enhanced content extraction from invoices.

Learning instance is an IQ Bot environment that enables you to train sample documents for content extraction. By constantly refining the learning instance, you can achieve a high content extraction accuracy before deploying the learning instance across a production environment.

IQ Bot Extraction package combines learning instance (new or existing) and a pretrained machine learning model to automatically extract content. The pretrained machine learning model uses data points to extract content from the supported document types. By providing additional training to an existing learning instance, you can extract content from other document types as well.

---

**Note:** This package is deprecated from Automation 360 v.26. IQ Bot Document Automation provides all the capabilities provided by the IQ Bot Extraction package. To move your bots from the IQ Bot Extraction package to Document Automation, see [Move from IQ Bot Extraction package to Document Automation](#) on page 2752.

---

The following diagram shows the IQ Bot Extraction package workflow:

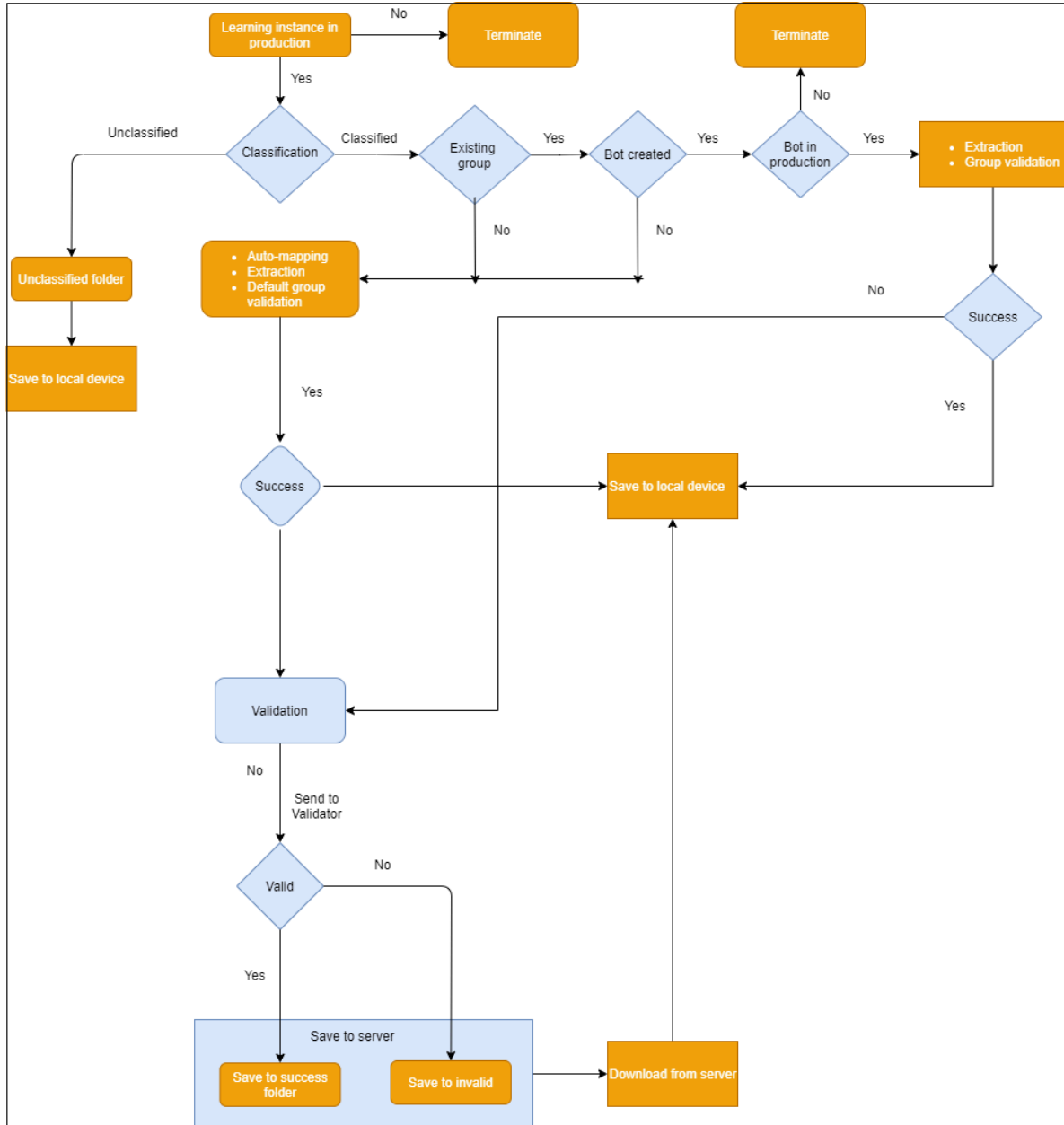

Contact your Customer Success Manager (CSM) or Partner Enablement Manager (PEM) for more information on the high level architecture, design and folder structure.

[High level architecture, design overview, folder structure of IQ Bot Extraction package \(A-People login required\)](#)

IQ Bot Extraction package provides the following extraction methods:

Content extraction with minimum training

The IQ Bot Extraction package is designed to extract values with minimum training from specific document type such as an invoice or purchase order.

**Note:** For this content extraction method, ensure you always use the ABBYY FineReader Engine OCR 12.4 engine.

Consider a scenario where you want extract sales data from various invoices. Create a learning instance by selecting a pretrained domain or document type used to extract data. In this scenario, you can select the document type as invoice, which provides a set of preset fields for content extraction. Ensure you upload a sample invoice document as a reference. Additional training of the learning instance group is not required. Use the IQ Bot Extraction package to link this learning instance to a bot. You can then run this bot to retrieve sales data based on the preset fields for various invoices.

#### Enhanced extraction with additional training

The IQ Bot Extraction package uses a combination of backend engine with IQ Bot server for enhanced document extraction. You can use an existing learning instance to provide additional training for all the available document groups. By customizing the various fields and validation settings of the learning instance group, you can use this package content extraction across other document types.

**Important:** This package is not available as part of the standard Automation 360 IQ Bot installation. To download and install this package, perform these steps:

1. Download the package from the Automation Anywhere support site. The package is a .jar file available in the IQ Bot **Installation Setup** folder.

[A-People Downloads page \(Login required\)](#)

2. Upload the package to Control Room.

[Add packages to the Control Room](#) on page 1908

### Before you start

- Ensure you create a learning instance using a supported OCR.
- Select documents with common layouts.

The preset model contains logical group. It is important to select an existing group for default validation rules to avoid documents with errors in the Success folder.

- Ensure that the Bot Agent version is not older than the previous two versions.

For example, if you upgrade to Automation 360 v.23 Build 11513 (On-Premises), ensure that the Bot Agent version is not older than 21.82.10342.

See [Bot Agent compatibility](#) on page 1332.

### Action in the IQ Bot Extraction package

The following action is available to build a bot for extracting data:

Action	Description
IQ Bot Extraction	See <a href="#">Using IQ Bot Process documents action</a> on page 2757.

Watch the following video to understand how to use the IQ Bot Extraction package:

Related tasks

[Select an OCR engine](#) on page 3748

You can select an OCR engines that suits your requirement for data extraction based on your document types. Restarting IQ Bot services is not necessary for implementing an engine change.

## Move from IQ Bot Extraction package to Document Automation

As of the Automation 360 v.26 release, the IQ Bot Extraction package will be deprecated. Instead, configure your learning instances from Automation 360 IQ Bot to extract data in the new document processing solution, Document Automation.

Check if any bots in use the IQ Bot Extraction package: Navigate to **Manage > Packages**, and search for the IQ Bot Extraction package. If the status is **Enabled**, you must do steps on this page to identify the bots that contain the Process documents action and the associated learning instances, and configure those learning instances to run in Document Automation.

## Packages

 Download free bots and packages from [Bot Store](#) 

Status	Name ↑	Vendor	Version	Bo
Enabled	<a href="#">IQ Bot Extraction</a>	Automation Anywhere	1.0.0-20220307-024320	21

Set up your [Set up your Document Automation environment](#) on page 3636, which includes creating a custom role and users to perform tasks in Document Automation.

In this page, you connect your learning instances from Automation 360 IQ Bot, build a bot to upload documents to Document Automation, publish the learning instance assets, and deploy them to a Bot Runner.

1. Identify the learning instances that you must connect to Document Automation:
  - a) Navigate to **Automation** page, under the **Public** tab, locate the **Bots** folder.
  - b) Click on a Task Bot to open the Bot editor.
  - c) If the Task Bot contains the **IQ Bot Extraction > Process documents** action, locate the **Learning instance name** field and note the value. This is the name of the learning instance that you must connect to Document Automation.
  - d) Repeat these steps to identify all the learning instances that must be connected to Document Automation.

Connect your learning instances to Document Automation



When you connect a learning instance that was created in Automation 360 IQ Bot, the system creates learning instance assets (RPA bots, Automation Co-Pilot process, and form) to enable the learning instance to start processing documents in Document Automation.

---

**Note:**

- This feature is accessible only within Document Automation (not available in Community Edition). If you are an IQ Bot customer, you can use this feature within Document Automation.
  - The Automation 360 IQ Bot environment must be associated with the Control Room where Document Automation is installed. In addition, Automation 360 IQ Bot must be in a version that is compatible with the Control Room.
  - You can connect one learning instance at a time.
- 

2. Login to the Control Room as the Admin user. Navigate to **Manage > Learning Instances**. Click **Connect learning instance**. This takes you to **Connect Learning Instances from IQ Bot classic page** which contains a list of Automation 360 IQ Bot learning instances.

3. Select the learning instance from version Automation 360 IQ Bot to connect with. Move it from left to right. Click **Connect**.

## Connect Learning Instances from IQ Bot classic

You can edit the Learning Instance only in IQ Bot

Name

Search

Q

**Learning Instances (4)** (1 selected)

↻

	Name	Document type
<input checked="" type="radio"/>	multilan_extractionbot	Invoices
<input type="radio"/>	S_MS	Purchase Orders
<input type="radio"/>	Z_T1	Purchase Orders
<input type="radio"/>	INT1	Invoices

→

←

Select learning instance

Click learn left

The newly-connected learning instance appears in the Learning instances table in private mode.

4. Upload documents to the learning instance that you connected in the previous step to test its extraction capability.
  - a) Click **Process documents**.

AUTOMATION ANYWHERE

Automation 360

- Home
- Automation
- Activity
- Manage
- Learning Instances

**Learning Instances**

Import Connect learning instance Create Learning Instance

Name

Search

Q

**Learning instances (26)**

↻

Name	Provider	Doc...	U...	Last ran	S...	Actions
[blurred]	Automation Anywhere (Pre-trained)	Invoi...	0		P...	Process documents Validate docur
multilan_extractionbot	User-trained	Purc...	2	1 Jun 2022 4:45:50 AM	P...	Process documents Validate docur
[blurred]	User-trained	Invoi...	7	1 Jun 2022 12:26:54 AM	P...	Process documents Validate docur

- b) In the **Process Documents** window, click **Browse** to select the files to upload.

- c)** In the **Download data to** field, enter the file path that will hold extracted data.  
When the process runs, it creates the following three folders in the provided file path:

- **Success:** Contains the extracted data in the specified format (CSV or JSON).
- **Invalid:** Holds documents marked invalid.
- **Failed:** Holds documents that could not be processed.

You can provide an output folder path based on one of the following options:

- **Option 1:** The local device path if you have set up document processing and validation on the same device.

This option is typically used when you are testing the learning instance.

- **Option 2:** The shared folder path if you have set up distributed validation on separate devices.

This option is typically used for published learning instances. For example, `\10.239.192.60\Sharepath\Output`.

- d)** Click **Process documents**.

The Bot Runner window appears. The window disappears when the documents are done processing. Refresh the **Learning instances** table to see the updated metrics.

If there is a value next to the **Validate documents** link, you must manually validate the document fields. Otherwise, proceed to step 3.

## 5. Fix the validation errors

- a)** Click **Validate documents**.

The Automation Co-Pilot Task Manager opens in a new tab, with the first failed document in queue. For an introduction to the Validator user interface, see [Using the Automation Co-Pilot Task Manager Validator for Document Automation](#) on page 3688.

- b)** Review each field to verify the data type and extracted value.

Document Automation supports the following data types: text, number, date, address, and check box

Alternatively, from the drop-down list on the right panel, you can select **Show fields that need validation**.

---

**Note:** When documents are awaiting validation, if you edit the learning instance, click **Reprocess** to reattempt extraction.

Reprocessing documents does not affect the uploaded documents metric.

---

- c)** Update the fields with errors.

Click the field or draw a box around the values that you want to extract.

For Automation Anywhere pre-trained models, you can configure the learning instance to extract specific values in a field and ignore others. For more information, see [Using validation feedback to extract specific values in a table](#) on page 3664.

- To skip a document without correcting errors, click **Skip** to proceed to the next document in the validation queue.
- To remove a document that cannot be processed, click **Mark as Invalid**.

- d) After you make the necessary corrections, click **Submit** so that the document can finish processing.  
The next document in queue appears. When all the documents are corrected, the system displays a message stating that no more tasks are available.
  - e) Close the tab to return to the **Learning Instances** page.
6. Verify the output results:
- a) Open the file in the **Success** folder that contains the extracted data and review the results to ensure that it matches your use case.  
The Microsoft forms return extracted values (OCR data) in the JSON format, such as `GUID_0-MSFormTableResult.json`. Along with the extracted document data in `<<GUID>>_FileName` CSV file, the **Success** folder also shows the extracted table data separately in another CSV files. Based on the number of tables in the document, you can find different CSV files for each table. For example, `<<GUID_PAGE_NUMBER-Table_FILENAME_PAGENUMBER_TABLENUMBER`.  
  
With separate table data, you can compare extracted data with Microsoft engine data in the `GUID_0-MSFormTableResult.json` file.
  - b) Optional: Review the **Learning Instance** dashboard.  
The dashboard displays the total number of uploaded documents and the number of documents pending validation.

Configure the learning instance to process documents in production

- 7. Build the **Extraction-Scheduler** bot to automate uploading documents to the learning instance: [Build a bot to upload documents to Document Automation](#) on page 3682
- 8. Publish the process.
  - a) Navigate to **Automation > Private tab > Bots > Document Workspace processes** and select the folder with the same name as the learning instance.
  - b) Mouse over the vertical ellipses to the right of the process to open the actions menu and click **Check in process**.  
The **Check in Process** window opens with the bots and form auto-selected to also be checked in.
  - c) In the **Check in Process** window, add your comment and click **Check in**.  
The process appears in the same folder structure in the public workspace.

See these steps in a video:

---

**Note:** The **Private** mode is used for testing in a controlled environment and cannot be viewed by other users. The **Public** mode is used when the bot is production-ready, allowing it to be viewed and accessed by others based on permissions set by the administrator.

---

- 9. Publish the **Extraction-Scheduler** bot.
  - a) Locate the **Extraction-Scheduler** bot in the private tab.

- b) Mouse over the triple ellipses to the right of the bot to open the menu and click **Check in Task**

Private bots and files cannot be viewed by other people. If a bot or file has been checked out from the Public tab, it can be viewed and run by other people, but cannot be edited.

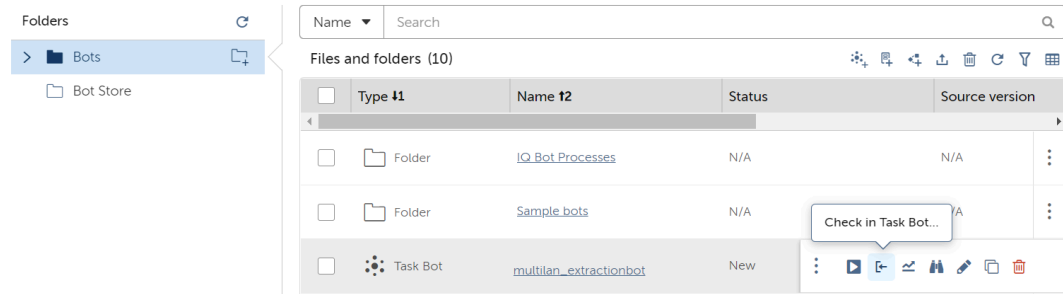

**bot.**

The **Check in Task bot** page opens with the bot auto-selected.

- c) Add a comment and click **Check in**.

10. Login as the `Document Automation Admin` user to deploy the process and bots to unattended Bot Runner devices: [Deploy the learning instance assets](#) on page 3687

Build a bot to upload documents to a specific learning instance for processing and extraction: [Build a bot to upload documents to Document Automation](#) on page 3682

## Using IQ Bot Process documents action

Use this action to extract values from invoices using a pretrained model.

1. Drag the **Process documents** action into the workflow.
2. Use the **Learning instance name** drop-down menu to select an existing learning instance.
3. Select one of the following tabs for the input documents:
  - **Desktop folder:** Enter the folder path or click **Browse** to choose a folder.
  - **Variable:** Enter a variable name or browse to select a variable from the list.
4. Select the folder (instead of a single document) that has all the documents that must be processed.
5. Select the output folder from the **Output folder path** field.
6. Optional: Select the **Send documents to IQ Bot Validator for validation** check box.
 

Although the documents are processed using Bot Runners on your local machine, you must use this option if you want to validate the documents in the IQ Bot Validator.
7. Optional: In the **Group Label** field, provide the string variable that holds the name of the folder containing the sorted documents.
 

This is necessary for defining a user-created document group. For more information, see [Create a new document group](#) on page 3745.
8. Click **Save**.

After the Task Bot is run, the output folder can have up to four subfolders:

- **Success:** Contains documents that the package successfully extracted all the fields from and appear as `.csv` files.
- **Validate:** Contains documents that require validation.

The documents appear as `.csv` files and IQ Bot extracts the data before you validated it. However, if you select this option, these documents will be available in the Validator and you can download the validated output separately.

- **Retrain:** Contains documents that were sent for validation.

These documents are stored in their original input format and you can train them by uploading them to your existing learning instance. The package does not create new groups. To create new groups and train the failed documents, use the **Upload** option to send the documents from the `output\Retrain` folder to your learning instance. The groups are created based on the **Groups Creation Threshold** defined in the learning instance.

- **Unprocessed:** Contains documents that were not processed due to runtime errors.

These documents are stored in their original input format and you can process them using the IQ Bot Extraction package.

If you use the IQ Bot Validator, the validated files are stored on the IQ Bot server output folder. Use the **IQ Bot > Download all documents IQ Bot: Download all documents** action to download files to your output folder on the local device.

## IQ Bot package

The IQ Bot package enables you to upload and download documents from an IQ Bot server.

### Actions in the IQ Bot package

The IQ Bot package includes the following actions:

Action	Description
Download all documents	See <a href="#">Download all documents action</a> on page 2758.
Upload document	See <a href="#">Upload document action</a> on page 2759.

To perform these tasks using APIs, see [APIs to upload files, check file status, and downloading CSV file \(A-People login required\)](#)

### Download all documents action

Use the **Download all documents** action to download the extracted results from an IQ Bot server that were created by running a Bot with the **Upload Document** action.

**Note:** To perform this task using an API, see [using APIs to upload files, check file status, and download CSV files \(A-People login required\)](#).

IQ Bot extracts fields from documents and exports them as CSV files. This action can also download any unclassified, untrained, and invalid documents to your local directory.

Follow these steps to download extracted results from the IQ Bot server:

1. In the Actions palette, double-click or drag the **Download all documents** action from the **IQ Bot** package.

2. In the **Learning instance name** field, select the name.
3. In the **Document status**, select the appropriate status for the documents.
  - **Success**: Documents have been processed and are in `.csv` format.
  - **Invalid**: Documents were marked as invalid during the validation process.
  - **Unclassified**: Documents could not be classified into any groups.
  - **Untrained**: Documents were classified into new groups during processing and require training.
  - **Fail**: Documents that failed to process and require re-processing. A document reflects **Document status** as **Fail** if an exception occurs during data extraction, validation, or storing of the final output to the database.

Unprocessed documents in **Invalid**, **Unclassified**, **Untrained** and **Fail** folders are available in their original format. For example, if your input documents were in a `.pdf` format, the output in the above folders are obtained in the `.pdf` format as well.

---

**Note:** After you upload a document by using the **Upload** action, to retrieve the latest results from the server, you need to run the **Download** action periodically. Ensure to maintain a delay of 30 seconds to 1 minute between the execution of two consecutive IQ Bot **Download** action of the same nature.

---

4. In the **Local output folder** field, provide the path to the file that will hold the output.
5. In the **Delete files from the server after downloading** check box, select the option to delete documents.

When you choose this option, even if your download fails, a compressed `.zip` file containing the failed documents is available for downloading again. Therefore, you must select this option.
6. Optional: In the **Save the response to a variable** field, add a variable. For example, select **prompt-assignment - string** from the drop-down list.

A variable value in this field provides information on whether the download was successful or failed, and the reason for the failure.
7. Click **Update**.
8. Click **Save**.
9. Click **Run now**.
10. Click **Close**.

---

**Note:** If the download fails, verify the variable value using a **Message Box** or **Log to File** action. See the **Save the response to a variable** description.

---

11. Navigate to the local output folder to review the downloaded files.

## Upload document action

The **Upload Document** action enables you to upload a document with IQ Bot. IQ Bot extracts fields from the document and exports them to CSV files.

- Gain access to an Control Room.
- Ensure your local host is a registered device in the Control Room.

**Note:** To perform these tasks using APIs, see [using APIs to upload files, check file status, and download CSV files \(A-People login required\)](#).

---

Use the **Upload Document** action to upload a single document to the Control Room.

---

**Note:** Azure confidential computing enables organizations to upload encrypted data to secured storage, such as private folders on a virtual machine. If you upload documents from such secured folders to IQ Bot, these are moved to **Unclassified** status as data extraction is not supported for such documents.

---

Follow these steps to upload a document:

1. In the Actions palette, double-click or drag the **Upload Document** action from the **IQ Bot** package.
- 

**Note:** A file size of 50 MB is supported for the upload action.

---

**Note:** The file names of the documents that you upload should not start with special characters, such as the hyphen (-).

---

2. In the **Learning instance name** field, select the name.
3. In the **File path** field, specify the location or type of the file.
4. Optional: In the **Group Label** field, provide the string variable that holds the name of the folder containing the sorted documents.  
This is necessary for defining a user-created document group. .
5. Optional: In the **Save the response to variable** field, add a variable. For example: select **prompt-assignment - string** from the drop-down list.  
A variable value in this field provides information about the file upload process: if the upload was successful or failed, and the reason for the failure.
6. Click **Apply**.
7. Click **Save**.
8. Click **Run now**.
9. Click **Close**.

To upload multiple files, insert the **Upload Document** action into a **Loop** action. See the [Loop package](#) on page 2784.

## JavaScript package

The JavaScript package contains actions to run a JavaScript from a bot. These actions can run JavaScript on Windows, Linux, and UNIX based devices.

### Before you start

1. Open a JavaScript file, or specify the script you want to run using the **Open** action. You must associate the details of the file or script you want to run with a session name. Use this same session name for other JavaScript actions.



2. Use the **Run JavaScript** action to run a function within a script or an entire script. You must use the same JavaScript session name established in the **Open** action.
3. Close the JavaScript session after running the script.

To review the bot launcher logs, navigate to `C:\ProgramData\AutomationAnywhere\BotRunner\Logs\<current month>\Bot_Launcher-<today's date>.log.zip`. Each zipped folder contains a file with data on the code execution, which is useful for debugging.

---

**Note:** Review the following known JavaScript exceptions (other exceptions might exist based on individual scenarios):

- All JavaScript run with JavaScript actions on the terminal.
  - We do not support any JavaScript that requires a browser to run.
- 

## Actions in the JavaScript package

The JavaScript package includes the following actions:

---

**Note:** If you built a bot using actions from the JavaScript package from Build 5322 or earlier, the actions will be missing when you open the bot with the default package version. You must reinsert the actions and repopulate the fields.

---

Action	Description
Close	See <a href="#">Close action in JavaScript</a> on page 2761.
Open	See <a href="#">Open action in JavaScript</a> on page 2762.
Run JavaScript	See <a href="#">Run JavaScript action</a> on page 2762.

Related reference

[JavaScript package updates](#) on page 902

Review the updates in released versions of the JavaScript package such as new and enhanced features as well as fixes and limitations. The page also lists the release dates of each version, and the compatible Control Room and Bot Agent versions.

## Close action in JavaScript

This action enables you to close the session.

### Settings

To close the JavaScript, specify the same session name from the **Open** action.

## Open action in JavaScript

You can open a JavaScript file using this action.

### Settings

Opens a JavaScript file.

- In the JavaScript **session** field, specify a session name. Use this same session name for other JavaScript actions.
- Choose one of the following options:
  - In the **Import existing file** option, select an existing JavaScript file.

---

**Note:** If you are uploading a script from a file on your desktop, the file and any dependencies must be in a standalone folder. When you select a file for upload, all files and folders at the same folder level are uploaded.

---

- In the **Manual input** option, enter the JavaScript.

## Run JavaScript action

This action enables you to run a function within the JavaScript file.

### Settings

Runs a function within the JavaScript.

- In the JavaScript **session** field, specify a session name. Use the same session name from the **Open** action.
- Optional: Specify the function name to run and the arguments to pass to the function.

---

**Note:** You can pass only a list variable as an argument for the function. You can use the list variable to pass multiple arguments of different data types such as Boolean, datetime, number, and string.

---

- Optional: In the **Assign the output to variable** field, specify the variable. The shows a descriptive default variable name. If you create several output variables, subsequent variable names are appended with a -1, -2, -3, and so on to avoid duplication.

## Json package

Extract the required information from Json text or file by using the Json package and use the extracted values in your bots.

### Before you start

Use the actions in the Json package in the following order:

1. Start the Json session using the **Start session** action. Use this session name for all corresponding actions.
2. Use the different actions available in the Json package to automate Json-related tasks.
3. End the session using the **End session** action to complete a task.

## Actions in the Json package

The Json package includes the following actions:

Action	Description
End session	See <a href="#">End session action in JSON</a> on page 2763.
Get node list	See <a href="#">Get node list action in JSON</a> on page 2763.
Get node value	See <a href="#">Get node value action in JSON</a> on page 2764.
Start session	See <a href="#">Start session action in JSON</a> on page 2765.

## End session action in JSON

You can close a JSON session using the **End session** action.

### Settings

Closes a Json session.

- Enter the session name or select a variable used in the **Start session** action.
- Save and close the session.

## Get node list action in JSON

This action enables you to retrieve a list of nodes for a node path.

### Settings

Retrieves the list of child nodes for a node path.

---

**Note:** When you run the **Json > Get node list** action to retrieve numbers, and if a number contains a decimal point and has more than seven digits, the number retrieved is converted to scientific notation (exponential number) and does not display correctly. For example, the number 77777778.07 is retrieved as 7.7777778E7.

Workaround: To retrieve a correctly formatted number, perform the following steps-

1. In the bot, use the **String to locale number** action to convert a string to a locale-formatted number.
2. Use the **Number to string** action with decimal point accuracy to convert a user-specified number to a string.

- Enter the key or node path to retrieve multiple nodes or select a variable.
- Enter the session name or select an existing variable used in the **Start session** action.
- In the **Save the outcome to variable** field, select a list type variable to hold the output.

For more information on how to use some of the actions (including Get node list), see this example topic [Example of using JSON package actions in a bot](#) on page 3267

## Get node value action in JSON

You can retrieve the node value in JSON.

### Settings

Retrieves the value of a node.

- Enter the key or node path to retrieve multiple nodes or select an existing variable.

You can select a single record from an array of records and pass an index number to select the specific record from an array. For example,

```
{
  "CompanyName": "XYZ Inc.",
  "CompanyAddress": "NY, USA",
  "CompanyPhone": "9876543210",
  "CompanyEmployees": [
    {
      "id": 1,
      "first_name": "Hilly",
      "last_name": "Triplet",
      "email": "htriplet0@earthlink.net",
      "gender": "Male",
      "ip_address": "152.189.110.100"
    },
    {
      "id": 2,
      "first_name": "Nathaniel",
      "last_name": "Pagitt",
      "email": "npagitt1@google.de",
      "gender": "Male",
      "ip_address": "54.93.141.163"
    },
    {
      "id": 3,
      "first_name": "Lauree",
      "last_name": "Gendrich",
      "email": "lgendrich2@nba.com",
      "gender": "Female",
      "ip_address": "117.24.49.36"
    }
  ],
}
```

```
{
  "id": 4,
  "first_name": "Ike",
  "last_name": "Caines",
  "email": "icaines3@adobe.com",
  "gender": "Male",
  "ip_address": "166.174.181.87"
}
]
```

When you enter the node path `CompanyEmployees[2].first_name`, the output is retrieved as Lauree, and if you enter the node key `CompanyAddress`, the output is retrieved as NY, USA.

- Enter the session name or select a variable used in the **Start session** action.
- In the **Save the outcome to variable** field, select a string type variable to hold the output.

## Start session action in JSON

This action enables you to create a new JSON session based on a JSON file or specified text.

### Settings

Creates a new JSON session based on a JSON file or specified text.

- Start the JSON session.
- In the **Data Source** field, select either **File** or **Text**:
  - File: Select from the **Control Room file**, **Desktop file**, or an existing **Variable** of File type.
  - Text: Specify the text name or select a variable.

---

**Note:** `.json` and `.txt` extensions are supported in the file path for the **Desktop** option.

---

- Select any of the following tabs from the JSON object session to create a JSON session:
  - **Local session:** Specify a session name that can be used only in the current bot.
  - **Global session:** Specify a session name that can be used across multiple bots, such as parent bots, child bots, and other child bots of the parent bots.
  - **Variable:** Specify a session variable that can be used to share that session with other child bots.

## Legacy Automation package

The actions in the Legacy Automation package are only used in migrated bots to ensure that they run seamlessly in Automation 360. We do not recommend using this package for new bot development.

---

**Note:** If you built a bot using actions from the Legacy Automation package from Build 5322 or earlier, the actions will be missing when you open the bot with the default package version. You must reinsert the actions and repopulate the fields.

---

## Expressions

Expressions appear in action input fields. This package has the following expressions:

Expression	Description	Use example
DictionaryToString	Converts a dictionary variable to a string variable	<pre>{{DictionaryVar.LegacyAutomation:dictionary}}</pre> <p>The output is a string variable with the following value: {key1,value1}, {key2,value2}</p>
GetAbsolutePath	<p>Provides you the relative path of all (non-Automation Anywhere) files present on your system by having a global variable at the start of the path. In Enterprise 11 or Enterprise 10, the equivalent of GetAbsolutePath is present at <b>Tools &gt; Options &gt; Runtime Settings &gt; Start in path of task</b>.</p> <p>In Enterprise 11 or Enterprise 10, any folder in the repository can be used as a starting path for the GetAbsolutePath value. If the path in the Enterprise 11 or Enterprise 10 bot is an absolute path, the migration process does not make any change to the migrated bot. If the path in the Enterprise 11 or Enterprise 10 bot is a relative path and contains a variable, the migration process adds a global variable at the start of the path as prefix alongside the relative value path.</p>	<ul style="list-style-type: none"> <li>• <code>variable.txt</code>: The input provided in this example is a relative path, and the output will be <code>C:\testing\variable.txt</code>, where, <code>C:\testing\variable.txt</code> is a start-in path.</li> <li>• <code>\\datashare\variable.txt</code>: The input provided in this example is a network path, and the output will be <code>\\datashare\variable.txt</code>.</li> <li>• <code>D:\testing\Automation Anywhere Files\Automation Anywhere\My Docs\mydoc.docx</code>: The input provided in this example is an absolute path, and the output will be <code>D:\testing\Automation Anywhere Files\Automation Anywhere\My Docs\mydoc.docx</code>.</li> </ul>

Expression	Description	Use example
GetBotPath	Modifies the value of the bot path variable in the Enterprise 11 or Enterprise 10 bots and replaces it with the relative bot path according to the Automation 360 repository. The value of the bot path is based on the <code>ApplicationPath</code> of the local path or network path.	<ul style="list-style-type: none"> <li>D:\testing\Automation Anywhere Files\Automation Anywhere\Bots\My Tasks\test.atmx: The input provided in this example is an absolute path, and in this case, the output path will be <code>My Tasks/test</code>.</li> <li><code>\$\$\$ApplicationPath\Automation Anywhere Files\Automation Anywhere\Bots\My Tasks\test.atmx</code>: The example provided in this input is related to <code>\$\$\$ApplicationPath</code>, and the output will be <code>My Tasks/test</code>.</li> <li><code>\\Automation Anywhere Files\Automation Anywhere\Bots\My Tasks\test.atmx</code>: The example provided in this input is a network path, and the output will be <code>My Tasks/test</code>.</li> </ul>
GetDecrementedListIndex	Decrements the value of the respective variable by 1. It is used mostly in the index positions of list, record, array or table variables.	<code>myArray[\$Loop-Counter-1].LegacyAutomation:getDecrementedListIndex</code> The output of <code>myNumber</code> decreases by 1 with each iteration of the loop.
GetIncrementedListIndex	Increments the value of the respective variable by 1. It is used mostly in the index positions of list, record, array or table variables.	<code>myArray[\$Loop-Counter+1].LegacyAutomation:getIncrementedListIndex</code> The output of <code>myNumber</code> increases by 1 with each iteration of the loop.
GetKeystrokeCount	Calculates the values of keystrokes in a phrase/text  <b>Note:</b> A special character, such as [TAB], [END], or [PAGE DOWN], is counted as one keystroke.	<code>myText.LegacyAutomation:getKeystrokeCount</code> The output is the average delay for each keystroke.

Expression	Description	Use example
GetLegacyIndex	Retrieves the value from the specific index position of the list variable in the bots migrated from Enterprise 11 or Enterprise 10. If the index position is greater than the size of the list variable, the system retrieves the value from the first index position of the list in the migrated bots	
ListToString	Converts a list variable to a string variable.	<pre>{{ \$listVar.LegacyAutomation:listToString \$}}</pre> <p>The output is a string variable with the following value: value1,value2,value3</p>
ListToTable	Converts a list variable to a table variable.	<pre>{{ \$my-list-variable.LegacyAutomation:listToTable \$}}</pre> <p>The output is a table variable where each list value is cell in a single column.</p>
ParseLegacyKeys	<p>Ensures that the <b>Insert Key Stroke</b> command of the Enterprise 10/Enterprise 11 bots stored in variables is successful upon execution. This expression converts them into equivalent Automation 360 key strokes during the execution.</p> <hr/> <p><b>Note:</b> The appearance of some special characters differs between Version 11.3 and Automation 360. For example, the Page Up key appears as [PAGE UP] in Version 11.3 and [PAGE-UP] in Automation 360. This difference does not impact bot function.</p>	<pre>\$Test.LegacyAutomation:parseLegacyKeys \$</pre>
ParseVariable	<p>Parses the expression provided in the Enterprise 10/Enterprise 11 <b>Variable Operation</b> command. This expression ensures that Automation 360 returns the same output as Enterprise 10/Enterprise 11 bots upon execution.</p>	<pre>\$prompt-assignment.LegacyAutomation:parseVariable \$</pre>



Expression	Description	Use example
TableToString	<p>Converts a table variable to a string variable.</p> <p>You can also use delimiters such as a colon, semicolon, or space to separate the values of the string variable in the output.</p>	<pre>{{ \$tableVar.LegacyAutomation:tableToString }} \$ }</pre> <p>The output is a string variable with the following value: {value1,value2}, {value3,value4}</p> <p>Use a colon, semicolon, or space as &lt;"delimiter"&gt;:  {{ \$tableVar.LegacyAutomation:tableToString }} For example:  {{ \$tableVar.LegacyAutomation:tableToString }} \$ } <p>The output is a string variable with the following value: {value1:value2}: {value3:value4}</p> </p>
TableToList	Converts a table variable to a list variable.	<pre>{{ \$DataTable.LegacyAutomation:tableToList }} For example: {{ \$DataTable.LegacyAutomation:tableToList }} \$ }</pre> <p>The output is a list variable with the following value: [value1,value2,value3]</p>
StringToList	Converts a string type variable to a list type variable	<pre>\$SampleString.LegacyAutomation:stringToList \$ }</pre> <p>The output is a list variable of size 1 with value same as "SampleString"</p>
StringToTable	Converts a string type variable to a data table type variable	<pre>\$SampleString.LegacyAutomation:stringToTable \$ }</pre> <p>The output is a data table variable with size (1*1) and value at index [0,0] same as SampleString</p>

Related reference

[Legacy Automation package updates](#) on page 905

Review the updates in released versions of packages such as new and enhanced features as well as fixes and limitations. The page also lists the release dates of each version, and the compatible Control Room and Bot Agent versions.

## Using legacy Web actions

In Automation 360, all the commands (except Find broken links and Download files) of Web recorder are migrated to their respective actions within the Legacy Automation package. We do not recommend using the Legacy Automation package for new bot development.

### Web actions in the Legacy Automation package

The Legacy Automation package includes the following actions:

Action	Description
Close page	Closes the browser session for an opened browser window or tab.
Update window title	<p>Updates the window title during migration of bots, from Internet Explorer to Microsoft Edge with IE mode. On execution of this action, the window title is changed to *Microsoft*Edge format. This action is used only when the window title is determined by a variable and not when the window title is static. The window title is updated when the bot is run and not during the conversion process.</p> <ul style="list-style-type: none"> <li>In the <b>Window</b> field, select an option: Choose the <b>Application</b>, <b>Browser</b>, or <b>Variable</b> tab. <ul style="list-style-type: none"> <li><b>Application</b>: Select from a list of windows, including browser windows, that are currently open on the Bot Creator device.</li> <li><b>Browser</b>: Select from a list of supported browser tabs.</li> <li><b>Variable</b>: Select an existing window variable to specify the title of the application window title.</li> </ul> </li> </ul> <hr/> <p><b>Note:</b> Although the property panel contains the <b>Browser</b> and <b>Application</b> options, only the <b>Variable</b> option is used during migration.</p> <hr/> <ul style="list-style-type: none"> <li>Select an option to specify whether the window title is a regular expression or not.</li> <li>When this action is executed, the <b>New window title</b> field displays the changed window title (Microsoft Edge with IE mode).</li> </ul>

Action	Description
Execute java script function	<p>Executes JavaScript internally on a web page in Internet Explorer or Microsoft Edge (IE mode).</p> <p>You can run JavaScript inside a web page by providing JavaScript as an action input. When you run a JavaScript function, you can see and edit the properties of the selected iFrame.</p> <ul style="list-style-type: none"><li>• Specify the URL.</li><li>• Specify the function name to run and the arguments to pass to the function.</li><li>• Specify the variable in <b>Assign the output to variable field (optional)</b>.</li></ul>
Extract data	<p>Extracts data from a specified URL in Internet Explorer or Microsoft Edge (IE mode).</p> <ul style="list-style-type: none"><li>• Specify the website URL to extract data from a web page.</li><li>• Enter the control type and control value.</li><li>• If you want to reuse an existing tab or window, mark the check boxes and specify the <b>Page Title</b> or <b>Page URL</b> properties to the action.</li><li>• Specify the time in seconds in <b>Wait for the control to exist</b>. The default time is 30 seconds.</li><li>• In the <b>Save outcome to a variable</b> field, select either <b>Multiple variables</b> or <b>Dictionary</b>:<ul style="list-style-type: none"><li>• <b>Multiple variables</b>: Click <b>Add variable mapping</b> to associate each dictionary key with a variable in the parent bot. Use this option if you do not want to use actions to extract the dictionary values.</li><li>• <b>Dictionary</b>: Insert or create a dictionary variable to hold the output variables and values in key-value pairs.</li></ul></li></ul>

Action	Description
Extract pattern data	<p>Extracts pattern-based data from an Internet Explorer page. Use pattern-based data extraction when the web entries follow a pattern. This feature recognizes the pattern and extracts the data even if it spans several pages. The extracted data is saved to a CSV file.</p> <ul style="list-style-type: none"><li>• To extract pattern-based data, enter the website URL and page title. You can preview the extracted captured data and its value.</li><li>• Specify the location of the CSV file in which you want to write the data.</li><li>• Select an option to specify what to do when writing data to a file:<ul style="list-style-type: none"><li>• Append to the file</li><li>• Override the file</li></ul></li><li>• Select an option from the encoding list to specify the encoding that you want to apply on the file. The default encoding is set to ANSI.<ul style="list-style-type: none"><li>• ANSI</li><li>• UTF-8</li><li>• Unicode</li></ul></li></ul>
Extract source	Extracts the source of an element on a specified webpage and assigns the value to a variable.

Action	Description
Extract table	<p>Extracts the table from a specified URL and optionally saves to a new CSV file or appends to an existing CSV file.</p> <ul style="list-style-type: none"> <li>Specify the URL to open a web page in an Internet Explorer window.</li> <li>Specify the table number to extract the table data.</li> <li>Specify the location of the CSV file in which you want to write the data.</li> <li>Select the <b>Append to an already existing csv file</b> check box when writing data to an existing file.</li> <li>Select an option from the encoding list to specify the encoding that you want to apply on the file. The default encoding is set to ANSI. <ul style="list-style-type: none"> <li>ANSI</li> <li>UTF-8</li> <li>Unicode</li> </ul> </li> <li>Specify the time in seconds in <b>Wait for the control to exist</b>. The default time is 30 seconds.</li> <li>Enter the session name in the session name field.</li> <li>If you want to reuse an existing tab or window, mark the check boxes and specify the <b>Page Title</b> or <b>Page URL</b> properties to the action.</li> <li>Provide the tag details (Tag name and Attribute name) of the extracted table data and save the result in a CSV file or assign the output to a data table variable.</li> </ul>
Go back	Navigates to the previous page.
Manage web controls	<p>Identifies the properties of a UI control from a specified website.</p> <ul style="list-style-type: none"> <li>Select the option to open a <b>new URL</b> or <b>Select page</b>.</li> <li>You can provide the search criteria of the captured object. Search the object by specifying <b>Control name, Value</b> or <b>Index</b>.</li> <li>If you want to reuse an existing tab or window, mark the check boxes and specify the <b>Page Title</b> or <b>Page URL</b> properties to the action.</li> <li>Select the control type from the drop-down menu.</li> <li>Specify the time in seconds in <b>Wait for the control to exist</b>. The default time is 30 seconds.</li> <li>Choose a variable to assign an output to a variable.</li> </ul>
Navigate to page	<p>Opens a web page in an existing Internet Explorer window.</p> <ul style="list-style-type: none"> <li>Specify the URL in the <b>Navigate URL</b> field to open a new window with a specified URL.</li> <li>If you want to overwrite an existing tab or window, mark the check boxes and specify the <b>Page Title</b> or <b>Page URL</b> properties to the action.</li> </ul>

Action	Description
Open page	<p>Opens a web page in Internet Explorer to a specified URL.</p> <ul style="list-style-type: none"> <li>Specify the URL to open a web page in an Internet Explorer window.</li> <li>If you want to reuse an existing tab or window, mark the check boxes and specify the <b>Page Title</b> or <b>Page URL</b> properties to the action.</li> </ul>
Search by caption	<p>Searches the first opened Internet Explorer window for the specified caption and occurrence frequency. You can update the <b>Caption</b> and <b>Occurrence</b> in the bot.</p>
Configure settings	<p>Set the configuration option for the web actions. You can select one of the following options or all:</p> <p>When you configure this action with the following settings, the settings configured will apply to all the actions under the Web group.</p> <ul style="list-style-type: none"> <li>Launch Internet Explorer as a process.</li> <li>Open a browser in the background.</li> <li>Launch Internet Explorer in Edge compatibility mode.</li> </ul> <hr/> <p><b>Note:</b> When you select the <b>Launch Internet Explorer in Edge compatibility mode</b> check box, all the automation you previously built on Internet Explorer 11 using Web actions will run and work in Microsoft Edge with IE mode. The actions within the Web group run seamlessly in Microsoft Edge with IE mode.</p> <hr/>

## List package

The **List** package contains actions that enable you to perform various operations on a variable of the list data type.

### Working with variables of list data type

A list is a collection of ordered values. The values can be of Boolean, number, or string data subtype. When initializing a list variable, you can select the **Any** data subtype in order to hold any of the three data subtypes. You can manually enter values by creating a new variable or selecting an existing one from the **Variables** menu, and then clicking **Add**.

Common uses of list variables include:

- Sending an email to multiple recipients.
- Searching multiple web addresses.

---

**Note:**

- Sorting of list values is currently not supported.
- You cannot directly assign values from the record to a list. However, you can use **Loop** action to loop through all the record items and then add them to the list variable.

## Actions in the List package

If you are using a **List** action in a **Loop** action, you must use the **For each item in the list** iterator.

The following actions are available in the **List** package:

Action	Description
<b>Add item</b>	See <a href="#">Add item action in List</a> on page 2777.
<b>Append</b>	See <a href="#">Append action in List</a> on page 2777.
<b>Assign</b>	See <a href="#">Assign action in List</a> on page 2778.
<b>Clear</b>	See <a href="#">Clear action in List</a> on page 2778.
<b>Get item</b>	See <a href="#">Get item action in List</a> on page 2778.
<b>Join items</b>	See <a href="#">Join items action in List</a> on page 2780.
<b>Remove item</b>	See <a href="#">Remove item action in List</a> on page 2781.
<b>Set item</b>	See <a href="#">Set item action in List</a> on page 2781.
<b>Size</b>	See <a href="#">Size action in List</a> on page 2781.

## Example

Create a bot to add items to a list and retrieve data from a list. To achieve this functionality, perform the following steps:

1. Create a bot.
  - a) On the left panel, click **Automation**.  
A list of available bots and forms is displayed.
  - b) Click **Create a bot**.
  - c) Enter the bot name: `ListBot`
  - d) Click **Create and Edit**.
2. Create the following variables.
  - Variable: `StringList`
    - **Type:** List
    - **Subtype:** String
    - **Name:** `StringList`
    - **Default value at 0:** `Automation`

- **Default value at 1:** Anywhere
  - Variable: SampleString
    - **Name:** SampleString
    - **Default value:** PvtLtd
  - Variable: ListOutput
    - **Type:** Any
    - **Name :** ListOutput
3. To insert an item into a list variable, from the Actions pane, double-click or drag the **List > Add item** action.
    - a) In the **List variable** field, select `StringList`.
    - b) In the **Items to be added** field, select `SampleString`.
    - c) To insert the item at the end of the list, select the **To end of list** option.
  4. To retrieve a value at a specified position in a list, from the Actions pane, double-click or drag the **List > Get item** action.
    - a) In the **List variable** field, select `StringList`.
    - b) In the **Index number** field, enter 0. This is to specify the position in the list from where you want to retrieve a value.
    - c) To store the output from **Assign the output to variable list**, select `ListOutput`.
  5. To print the value of the Index 0, double-click or drag the **Message box** action. Click **Save** and **Run**.

The bot displays the zero index data of the list variable, which is **Automation**.

Related reference

[Loop package](#) on page 2784

Use the Loop package to run a sequence of actions repeatedly for a specific number of times or until a specific condition is met.

[Variables overview](#) on page 2326

Automation 360 offers a variety of variables, each designed to hold specific types of data and is intended for specific use. Use the topics below to learn more about each variable and how to use them.

[List package updates](#) on page 906



Review the updates in released versions of the List package such as new and enhanced features as well as fixes and limitations. The page also lists the release dates of each version, and the compatible Control Room and Bot Agent versions.

## Add item action in List

The **Add item** action enables you to insert an item into a list variable.

### Settings

You can choose to add the item at the end of the list or specify a position in the list.

- Select the list variable in which to add an item from the **List variable** list.
- Select the variable that contains the value to add from the **Item to be added** list.

---

**Note:** The variable must be of the same sub-data type as the other list items.

---

- Select the **To end of list** option to insert the item at the end of the list or select **At list index** to specify the index in the list where to insert the item.

The list index starts from 0. The first item in the list is at position 0, the second item at 1, and so on. For example, to add an item at the fourth position in a list, enter 3 in the **At list index** field.

## Append action in List

The **Append** action enables you to add a list variable into the column index of a data table.

### Settings

You can choose to add the list variable at the start or end, or specify a position in the data table.

- Select the list variable that contains the value to be added.
- In the **Assign the outcome to Data Table** field, select a table variable that you want to use to store the output.
- Choose from the following options to insert a column at index:
  - **First index:** Sets the value to the first position (0 index) in a data table.
  - **Last index:** Sets the value at the end of the data table.
  - **Specific index:** Specify the index where you want to enter the column index. For example, to set a value to the first column, enter 0.

The index number starts from 0. The first item in the data table is at position 0, the second item at 1, and so on. For example, to add an item at the third position in a data table, enter 2 in the **Specific index** field.

## Assign action in List

The **Assign** action enables you to assign the value of the source list to the destination list variable.

### Settings

- On the **List** tab, select the source list variable from the drop-down list and specify a value in the **Value at 0** field or create a new list variable.
- On the **Variable** tab, insert a value for the list variable.
- Select a destination list variable or create one to hold the output.

## Clear action in List

Use the Clear action to clear all items from the selected list variable.

### Settings

Select the list variable from which you want to clear the items.

## Get item action in List

You can retrieve a value at the specified position in a list and store the output to a variable using the **Get item** action.

### Settings

- Select the list variable from which you want to retrieve a value from the **List variable** list.
- Specify the position in the list from where you want to retrieve the value in the **Index number** field. The list index starts from 0. The first item in the list is at position 0, the second item at 1, and so on.
- Select a variable that you want to use to store the output from the **Assign the output to variable** list.

## Example

For example, to create a bot to retrieve data from a list where you want to see data from sales of the iPhone14 on product launch day, perform the following steps:

1. Create a bot.
  - a) On the left panel, click **Automation**.  
A list of available bots and forms is displayed.
  - b) Click **Create a bot**.
  - c) Enter the bot name: `List_Get_item`.

- d) Click **Create and Edit**.
2. Create the user-defined variables using the **Create variable (+)** icon at the top of the **Variables** menu.
- a) Create a variable of **List** type and select the **Any** data subtype to include any data subtypes (String, Boolean, Number, Datetime, or File).
- b) Select the type and enter the following values:

Type	Value
Datetime	6/15/2023
Number	100
String	Customer footfall
String	Apple Oakridge - San Jose store
String	Phone type - iPhone
String	iPhone 14 pro max
String	iPhones sold - 10 Qty
Boolean	true

3. To retrieve a value at a specified position in a list, from the **Actions** pane, double-click or drag the **List > Get item** action.
- a) In the **List variable** field, select `CustomerData`.
- b) In the **Index number** field, enter 1 to specify the position in the list from where you want to retrieve a value.
- c) To store the output from **Assign the output to variable list**, select `SampleNumber`.
4. To print the value of the Index 1, double-click or drag the **Message box** action. Enter the value `$CustomerData[1].Number.toString$` in the **Enter the message to display** field.
5. Click **Save** and then **Run**.  
The bot displays the one position index data of the list variable (**100**).
6. Repeat Step 3.
7. Drag the **Datetime > To String** action.
- a) Select the **Variable** option from the **Source date and time variable** field.
- b) Select `SampleString` from **Assign the output to a variable** field.
8. To print the values, drag the **Message box**. Enter the following values in the **Enter the message to display** field:
- `$SampleString$`
  - `$CustomerData[1].Number.toString$`
  - `$CustomerData[2]$`
  - `$CustomerData[3]$`

- \$CustomerData[4]\$
- \$CustomerData[5]\$
- \$CustomerData[6]\$
- \$CustomerData[7].Boolean.toString\$

9. Click **Save** and then **Run**.

The output is displayed as:

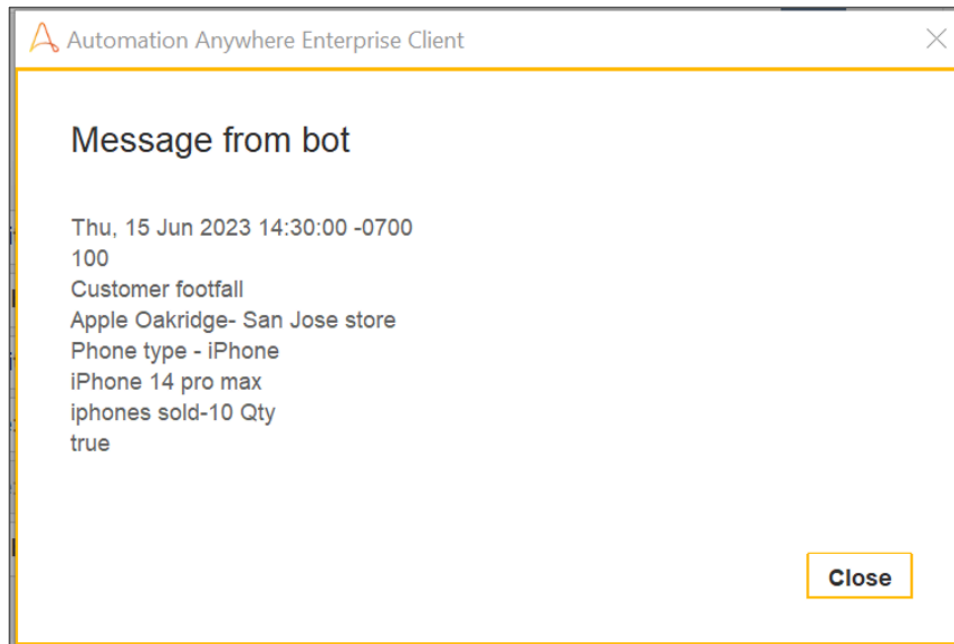

The output shows that on June 15, 100 customers visited the Apple store in San Jose on the product launch day, and ten iPhones were sold. The `true` value indicates that iPhone is the best-selling smartphone of 2023.

## Join items action in List

The **Join items** action enables you to combine all the available values in a list variable and store the output to a string variable.

### Settings

Combines all the available values in a list variable and stores the output to a string variable. You can specify the delimiter you want to use as a separator in the output.

- Select the list variable that you want to use from the **List variable** list.
- Specify the delimiter you want to use to separate values in the output in the **Delimiter** field.
- Select a variable that you want to use to store the output from the **Assign the output to variable** list.

## Remove item action in List

The **Remove item** action enables you to remove an item from a list and assign the output to a variable.

### Settings

- Select the list variable from which you want to remove an item from the **List variable** list.
- Specify the position in the list from where you want to remove the value in the **Index number** field. The list index starts from 0. The first item in the list is at position 0, the second item at 1, and so on.
- Select a variable that you want to use to store the output from the **Assign the output to variable** list.

## Set item action in List

You can set an item at the specific position in a list and store the output in a variable using the **Set item** action.

### Settings

- Select the list variable in which you want to set a value from the **List variable** list.
- Specify the position in the list where you want to set the item in the **Index number** field. The list index starts from 0. The first item in the list is at position 0, the second item at 1, and so on.
- Select a variable from the drop-down list in the **Replace with** field to replace the list variable.
- Select a variable that you want to use to store the output from the **Assign the output to variable** list.

## Size action in List

The **Size** action enables you to retrieve the number of items in a list and assign the output to a number variable.

### Settings

- Select the list variable for which you want to retrieve the size from the **List variable** list.
- Select a number variable that you want to use to store the output from the **Assigns the number of items to variable** list.

## Log To File package

Use the `Log To File` package to create a log file with data.

The `Log To File` package enables the following:

- Verify that a bot ran properly.

- Create a new log file.
- Specify custom text to be included in the log file.
- Add a time stamp to the log file.
- Use a log file as a variable.

---

**Note:** The package supports ANSI, Unicode, and UTF8. It can save files as .csv and .txt.

---

## Actions in the Log To File package

The Log To File package includes the following action:

Action	Description
Log to file	See <a href="#">Using Log text to file action</a> on page 2782.

## Using Log text to file action

The **Log text to file** action in the Log To File package enables you to create a log file with data about the events that occur when a Task Bot runs.

Follow these steps to log text into a file:

1. In the **Actions** palette, double-click or drag the **Log to file** action from the Log To File package.
2. In the **File path** field, specify the file location or variable.
3. In the **Enter text to log** field, enter the text to log in the file.
4. Select the **Append timestamp** check box to add a time stamp.
5. In the **When logging** field, choose **Append to existing log file** to append the log file or **Overwrite existing log file** to overwrite the content in the log file.
6. Select the **Encoding** type.
  - **ANSI:** Used to encode Latin alphabet.
  - **UNICODE**
  - **UTF8:** Can encode all possible characters.
  - **UTF-16LE:** Inserts a byte order mark (BOM) Unicode character at the beginning of the file.

---

**Note:** Shift-JIS files must use **ANSI** as encoding to read text file content.

---

If you selected the **Append to existing log file** option in Step 5, ensure that the selected encoding type matches that of the original file, otherwise some of the characters might not be logged.

7. Click **Save**.

## Log variables to file action

You can use the **Log variables to file** action in the Log To File package to log user-defined variables to a log file. When an automation (bot) fails, you can use this action to troubleshoot issues offline by reviewing the log file and value of the variables for correctness.

### Procedure

1. In the **Output file path** field, browse and select the file path of the log file. If the specified log file does not exist, then a new log file is created at run time.

---

**Note:** We support .txt format for the log file.

---

2. In the **When logging** field, select one of the following options:
  - **Append to existing log file:** To append the content to an existing log file.
  - **Overwrite existing log file:** To overwrite the content in the log file.
3. **Append timestamp:** Select this check box to add a timestamp. If you select this option, the log file will display information about the logging timestamp (date and time). For example, if you change the value of the variables at different times, you can select this option to pinpoint the date and time of the changes, and the Task Bot name these changes occurred.
4. Select one of the following options from the **Variables to log** field:

---

**Note:** We support logging user-defined variables of String, Number, Boolean, and Datetime data types only.

---

- **By type:** You can use this option to log user-defined variables of basic data types based on type selection. You can log all String variables, all Number variables, all DateTime, and all Boolean variables simultaneously.

---

**Note:** When you select the **By type** option, you can also log variables that are created later after you have added the **Log variables to file** action.

---

- **Custom selection:** You can use this option to select and log individual variables of basic data types such as String, Number, DateTime, and Boolean.

---

**Note:** If you created any new variable after you added the **Log variables to file** action to the bot and enabled the **Select all variables** check box, the new variable is not auto-selected and will not be logged even if you selected the **Select all variables** option. The variable appears unchecked in the **Custom selection** list where you must select that variable explicitly.

---

The following video shows how to log user defined variables to a log file.

See on how to use the Log variables to file action [Example of using Custom selection option in Log variables to file action](#) on page 3287.

## Loop package

Use the Loop package to run a sequence of actions repeatedly for a specific number of times or until a specific condition is met.

The Loop package enables you to repeatedly run specific actions within a bot. For example, repeat the set of actions that read data from each row of a Microsoft Excel file, rename all files in a folder, and save each email in a mailbox. You can also use the **If** action within the Loop action to validate a condition, and based on the outcome of it, skip the current iteration in the loop or even break the loop.

For conditional loops, different actions are taken depending on whether the conditional parameters are met. For loops that have a specified number of iterations, the loop exits on the last iteration and goes to the next step in the bot.

When you run a sequence of actions repeatedly for a specific number of times within a loop, the end condition within the loop is evaluated in every iteration.

For example, when you loop through a Data Table that has 10 columns, enter dynamic values of column count for the end condition in the loop, use the **Data Table > Delete column** action to delete the column of index 0 inside the loop body, and then run the bot, the bot deletes a column in every iteration. Hence it reduces the iteration count because the loop end condition is evaluated in each iteration.

---

**Note:** You can run the bots with a maximum number of 97 nested loops.

---

## Loop labels

You can use the **Label** field in the actions of the Loop package to label the loops used in a bot. By labeling of loops, you can break or continue a specific loop from nested loops.

---

**Note:** To use this feature, ensure that you build your bots using Loop package version (3.7.4) to use this feature. This feature is not backward compatible.

---

To add labels to the **Loop**, **Continue**, or **Break** actions, in the **Label** field, specify a label for the loop.

---

**Note:**

- Ensure that each loop label in a specific bot is unique.
  - The **Label** field supports only alphanumeric characters.
- 

The following example describes how to use the **Label** field to break or continue a loop in a bot:

- In the **Label** field of the first Loop action, specify a label as `outerloop`.
- In the **Label** field of the second Loop action, specify a label as `innerloop`.
- In the **Loop > Continue** action, in the **Label** field, select the label of the loop from which you want to continue.
- In the **Loop > Break** action, in the **Label** field, select the label of the loop from which you want to break.

Click the video to see how labeling loops work.



In a bot, if you have multiple nested loops with **Loop** > **Continue** and **Break** actions within the nested loops, and if you have not labeled the loops, then on bot execution, the bot breaks or continues the nearest loop by default.

For example, you have:

- An outer loop and an inner loop nested within the outer loop.
- A **Loop** > **Continue** and **Break** action within the inner loop.

If you have not labeled any of these loops, when you run the bot, the bot will break or continue the nearest loop (the inner loop).

## Actions in the Loop package

The following Loop actions are available:

Action	Description
Loop	See <a href="#">Using Loop action</a> on page 2794.
Continue	See <a href="#">Continue action</a> on page 2794. See <a href="#">If package</a> on page 2724.
Break	See <a href="#">Break action</a> on page 2794. See <a href="#">If package</a> on page 2724.

## Iterator-related conditions within the Loop action

Select the **Iterator** option to specify the number of times the set of actions will be repeated as part of the Loop action:

Iterator	Description
For each row in CSV/TXT	Repeats the set of actions for each row in the specified CSV or text file and assigns the values in the current row to a record variable. See <a href="#">Using the For each row in CSV/TXT iterator</a> on page 2795.
For each row in Data Table	Repeats the set of actions for each row in the specified table and assigns the values in the current row to a record variable. See <a href="#">Using the For each row in table iterator</a> on page 2796.
For each row in a SQL query dataset	Repeats the set of actions for each row in the specified SQL query dataset and assigns the values in the current row to a record variable. Provide the session name that you have used to establish a connection with the database.

Iterator	Description
For each key in the Dictionary	<p>Repeats the set of actions for each key in the specified Dictionary variable and assigns the name of the current key to a variable.</p> <hr/> <p><b>Note:</b> When a bot runs a <b>Loop</b> action that contains a <b>Dictionary &gt; Put</b> action, the bot only iterates on the original number of items in a dictionary; it ignores items inserted using the <b>Put</b> action.</p> <hr/>
For each value in the Dictionary	<p>Repeats the set of actions for each value in the specified Dictionary variable and assigns the current value to a variable. Because this variable type can hold various subtypes (String, Number, Boolean, and so on), if you quick-create a variable when configuring the action, the variable is of Any type.</p> <hr/> <p><b>Note:</b> When a bot runs a <b>Loop</b> action that contains a <b>Dictionary &gt; Put</b> action, the bot only iterates on the original number of items in a dictionary; it ignores items inserted using the <b>Put</b> action.</p> <hr/>
For each mail in mailbox	<p>Repeats the set of actions for each email in the specified mailbox. See <a href="#">Using the For each mail in mail box iterator</a> on page 2545.</p>

Iterator	Description
For each row in worksheet (Excel basic or Excel advanced)	<p>Repeats the set of actions for each row that contains data in a worksheet and assigns the values in the current row to a record variable. Provide the session name that you have used to open the Excel basic or Excel advanced worksheet. Specify whether to repeat the actions for all the rows, specified rows, or a specified cell range. Select a record variable from the <b>Assign the current row to this variable</b> list or create a new one. See <a href="#">Record variable</a> on page 2340.</p> <p>This iterator retrieves cell values as string data types. It supports Excel cell formats, including Number, Percentage, Currency, Scientific, and Date. For example, a value from a cell of Currency formatting retains the currency symbol when passed to a table or record variable.</p> <ul style="list-style-type: none"> <li>You must convert the values to perform non-string operations.</li> <li>In Excel advanced, when you choose loop iterator as <b>For each row in worksheet</b>, you have a <b>Read</b> option to read either the visible text or value of the cell.</li> </ul> <p>For example, if the cell has 70% as cell content, <b>Read cell value</b> option will read the value as 70 ignoring the % format whereas <b>Read visible text</b> option will read the content as 70%.</p> <hr/> <p><b>Recommendation:</b> Use the <b>Read cell value</b> option as reading value from a cell for better performance than reading visible text.</p> <hr/> <p>Use of <b>Global session</b> option to share an Microsoft Excel session using the Excel advanced package is not available with this option.</p> <p>Alternate solution: Use the <b>Get multiple cells</b> action and save the data into a datatable variable and then, use the Loop package with the <b>Data Table</b> option selected.</p>
For each file in folder	<p>Repeats the set of actions for each file in the specified folder and assigns the properties of the current file to a Dictionary variable containing two keys: the <code>name</code> key holds the file name and the <code>extension</code> key holds the file extension.</p> <p>To open files with different extensions, use the variable option to assign the folder path, file name, and file extension. First, create a variable for the folder path, <code>\$\$Folder\$</code>. Then, for the files in the folder path, create two variables, one for file name <code>\$\$name\$</code> and another for file extension <code>\$\$extension\$</code>. To open a file, combine the variables as a string, such as <code>\$\$Folder\$\\$name\$. \$extension\$</code>. For the extension to work with different file types and different open options, you can add conditional logic.</p>
For each folder in folder	<p>Repeats the set of actions for each folder in the specified folder and assigns the current folder name to a String variable.</p> <p>Use the <b>Include all sub-folders</b> option to recursively iterate through each sub-folder within a folder including hidden folders.</p>

Iterator	Description
For each item in the list	<p>Repeats the set of actions for each item in the specified list and assigns the current item to a variable. Specify whether to repeat the action for all items in the list or only for the range of items in the list. Because this variable type can hold various subtypes (String, Number, Boolean, and so on), if you quick-create a variable when configuring the action, the variable is of Any type.</p> <hr/> <p><b>Note:</b> The index in a list starts from zero. For example, to repeat the action for items from the third position to the sixth position of the list, specify 2 and 5 in the appropriate fields.</p> <hr/>
For n times	Repeats the actions in the container the specified number of times. You can assign the iteration count to a Number variable.
For each value in record	Repeats the actions for each value in the specified record and assigns the current value to a variable. Because this variable type can hold various subtypes (String, Number, Boolean, and so on), if you quick-create a variable when configuring the action, the variable is of Any type..
For each meeting in calendar	Use this option to repeat the set of actions for each meeting in the specified calendar. See <a href="#">Using Microsoft 365 Calendar actions in a loop</a> on page 2820.
For each row in worksheet (Microsoft 365 Excel)	<p>Repeats the set of actions for each row that contains data in a worksheet.</p> <ul style="list-style-type: none"> <li>• Provide the session name that you have used to open the worksheet.</li> <li>• Specify whether to repeat the actions for all the rows or specific rows.</li> <li>• You can assign the values in the current row to a record variable.</li> </ul>
For each node in a XML dataset	Repeats the set of actions for each node in an XML dataset and assigns the current node to String variable. Provide the session name that you have used to open the XML file.

## While related conditions in the Loop action

You can configure multiple while related conditions within a single Loop action:

1. Click **Add condition**.
2. Select either of the following options:
  - **And:** Both of the conditions must be met for the actions to run.
  - **Or:** Either of the conditions must be met for the actions to run.
3. Select the conditions from the drop-down list.

Select the **While** option to use the following conditions:

While	Description
Application	<p>Use the <b>Application is running</b> or <b>Application is not running</b> condition to run actions based on whether an application is running or not running.</p> <p>Enter the application path or specify the path using a variable along with the amount of time to wait (in seconds) for the condition to be true.</p> <hr/> <p><b>Note:</b> The <b>Application is running</b> and <b>Application is not running</b> conditions are not applicable for Internet Explorer bots because its corresponding process <code>iexplore.exe</code> runs in the background when <b>Microsoft Edge</b> is launched in <b>IE mode</b>.</p> <hr/>
Boolean	Use this condition to execute actions based on the value of a Boolean variable. Use this condition to compare the values of two Boolean variables or one Boolean variable to a selected Boolean value.
Data table	<p>Use the <b>Data table is empty</b> condition to execute actions based on whether the specified table contains values.</p> <p>Use the <b>Number of rows</b> and <b>Number of columns</b> conditions to execute actions based on whether the number of columns or rows is <b>Equal to</b>, <b>Greater than</b>, or <b>Less than</b> the specified value.</p>
Datetime	Use the <b>Datetime variable</b> condition to execute actions based on whether the value of the source datetime variable is <b>Equal to</b> or <b>Not Equal to</b> , is <b>Greater than</b> or <b>Equal to</b> , or is <b>Lesser than</b> or <b>Equal to</b> the value of the target datetime variable.
Dictionary	<p>Use this condition to repeat the set of actions based on whether the selected dictionary variable contains the specified key.</p> <hr/> <p><b>Note:</b> The key comparison is case-sensitive.</p> <hr/>

While	Description
File	<p>Use the following conditions to execute the action:</p> <ul style="list-style-type: none"> <li> <b>File date</b>            Use this condition to verify the date and time when a file was created or modified. Specify a date or date range using the <b>On a date</b>, <b>Is within last</b>, <b>Is between</b>, or <b>Is before</b> options. For the <b>On a date</b> option, specify a date to verify whether the file was created or modified on that date. For the <b>Is within last</b> option, specify the number of days or time (in hours, minutes, and seconds). Enter the amount of time (in seconds) to wait for this condition to be true.         </li> <li> <b>File exists and File does not exist</b>            Use these conditions to execute an action based on whether a file exists. For example, if a data file exists, format the file and upload it to a database.         </li> <li> <b>File extension</b>            Use this condition to check the file extension of a selected file and then execute actions based on the results. Use the <b>File path</b> field to select a file.         </li> <li> <b>File size</b>            This condition verifies if the specified file is larger, smaller, not the same, or the same as the size you specify.             Enter the amount of time (in seconds) to wait for this condition to be true.         </li> </ul>
Folder does or does not exist	Use these conditions to repeat the set of actions based on whether a folder exists.
Image Recognition	<p>Use these conditions to verify whether:</p> <ul style="list-style-type: none"> <li><b>Image file</b> is found in the <b>Image file</b> or not.</li> <li><b>Image file</b> is found in the <b>Window</b> or not.</li> <li><b>Window</b> is found in the <b>Image file</b> or not.</li> <li><b>Window</b> is found in the <b>Window</b> or not.</li> </ul> <p>For the <b>Window</b> conditions, you can use the <b>Resize window</b> option to specify the window dimensions. This option delivers a more reliable bot. It resizes the window to the dimensions at which the task was recorded, which enhances the bot's ability to identify the target object.</p> <hr/> <p><b>Note:</b> This option is only available for windows that can be resized. It is not available for Desktop or Taskbar options.</p> <hr/> <p>For the <b>Window</b> conditions, you can use the <b>Preview</b> option to select a specific captured occurrence and position your click location relative to the image.</p>

While	Description
JavaScript	Use the <b>Script is successful</b> or <b>Script is unsuccessful</b> condition to execute actions based the status of the specified JavaScript. Select the file that contains the script and optionally specify the parameters by selecting a list variable.
Legacy automation	<p>The <b>Legacy automation</b> conditions are only used in migrated bots to ensure that they run seamlessly in Automation 360. We do not recommend using these conditions for new bot development. The following conditions to verify the following:</p> <ul style="list-style-type: none"> <li>• Whether <b>Web control</b> exists or not.</li> <li>• Whether <b>Window control</b> exists or not.</li> <li>• Whether <b>Window control</b> is active or not.</li> <li>• Whether <b>Script</b> is successful or not.</li> <li>• Whether <b>Child window</b> exists or not.</li> </ul> <p>For the <b>Window control</b> conditions, you can use the <b>Resize window</b> option to specify the window dimensions. This option delivers a more reliable bot. It resizes the window to the dimensions at which the task was recorded, which enhances the bot's ability to identify the target object.</p>
List	Use the <b>List variable</b> condition to execute actions based on whether the specified list variable contains a particular value. The value can be of <b>Number</b> , <b>String</b> , or <b>Boolean</b> data type.
Number	Use the <b>Number variable</b> condition to execute actions based on whether the specified number variable is <b>Equal to</b> or <b>Not Equal to</b> , or is <b>Greater than</b> or <b>Equal to</b> , or is <b>Lesser than</b> or <b>Equal to</b> a particular value.
Ping	Use the <b>Ping is successful</b> or <b>Ping is unsuccessful</b> condition to verify if a machine or server is running, and execute actions based on the result. Enter the amount of time (in seconds) to wait for the condition to be true.
Recorder	<ul style="list-style-type: none"> <li>• Use the <b>Object exists</b> condition to detect an object in a window. Select a window or variable to capture the object. Enter the amount of time (in seconds) to wait for this condition to be true, that is, for the object to be detected.</li> <li>• Use the <b>Object does not exist</b> condition to verify whether a specific object exists in a window, and then based on the result, execute actions. Enter the amount of time (in seconds) to wait for this condition to be true. For example, you can use the <b>Object does not exist</b> condition inside the <b>Loop &gt; While</b> condition to make sure that the bot does not execute the next action until the object on the business application is loaded.</li> </ul> <hr/> <p><b>Note:</b> The <b>Object exists</b> and <b>Object does not exist</b> Recorder conditions support Chromium-based Microsoft Edge with Internet Explorer mode.</p> <hr/>

While	Description
Service	Use the <b>Service is running</b> or <b>Service is not running</b> condition to execute actions based on whether a service is running or not. Select <b>Service list</b> to choose a service from the list of available services.
String	<p>Use the <b>String variable</b> condition to execute actions based on whether the specified source string value is <b>Equal to</b> or <b>Not equal to</b>, or <b>Includes</b> or <b>Does not include</b> the target value.</p> <p>You can select the <b>Match case</b> option to only execute actions if the two strings have matching uppercase and lowercase letters.</p> <p>When you extract text from a Microsoft application, the extracted text contains the /r/n special characters which indicate a new line. Select the <b>Ignore Carriage return</b> option if you want to ignore the /r special character when you compare the text.</p> <p>To create a condition based on whether a string is empty or not empty, compare the source value to an empty target field using the <b>Equal to</b> operator.</p> <p>See <a href="#">Example of using a conditional statement</a> on page 3208.</p>
Task Bot	Use the <b>Task successful</b> or <b>Task unsuccessful</b> condition to execute actions based on the status of the specified Task Bot.
VBScript	Use the <b>Script is successful</b> or <b>Script is unsuccessful</b> condition to execute actions based on the status of the specified Visual Basic script. Select the file that contains the script and optionally specify the parameters by selecting a variable.



While	Description
Window	<p>Use the <b>Window exists</b> or <b>Window does not exist</b> condition to verify if a specific application window is open by entering the <b>Window title</b> or using a variable. Enter the amount of time (in seconds) to wait for the condition to be true. These conditions are used when the window title remains constant and to verify if the specific window is open and execute further actions based on the output.</p> <p>The <b>Window exists</b> condition uses the same window variable to search the specific window from cache. For example, when you open a <b>Yahoo India</b> web page and perform a <b>Click</b> action on the <b>News</b> option on the web page, the action navigates you to another page which changes the title of the window. In this case, when you use the <b>Window exists</b> condition to verify if the window exists, the bot still fetches the <b>Yahoo India</b> web page from the cache and performs action on it because the window is still the same but only the title has changed. For more information on how window variables work, see <a href="#">Your variables (user-defined)</a> on page 2331</p> <p>Use the <b>Window with same title does not exist</b> or <b>Window with same title exist</b> condition to verify whether a window with the same title exists or whether the window title has changed. Enter the amount of time (in seconds) to keep verifying if the condition is true. These conditions are used for window titles that are dynamic. For example, when you open a Google account webpage, enter your username and password to log into your account, the window title changes. If you want to compose a new email as a next action, you can use these conditions before you execute the next action to verify if the window with the same title exists or if the title has changed.</p>

## Group conditions

Use the **Add group** option to add multiple Boolean conditions or combine more than one conditions with **And** and **Or** options within a group and when you want the to check multiple conditions at a time before executing a set of .

You can also add a group within a group.

Related tasks

[Example of transferring data from CSV file to Excel worksheet](#) on page 3216

Build a bot that reads data from a CSV file and updates the data in an Excel worksheet, using actions from the CSV/TXT, Excel advanced, IF/ELSE, and Loop packages.

[Example of entering data into a web form from a spreadsheet](#) on page 3204

Build a bot that reads multiple rows of data from an XLSX sheet and enters it into a web form. Use actions from the Excel advanced, Loop, and Recorder packages to build the bot.

Related reference

[Loop package updates](#) on page 908

Review the updates in released versions of the Loop package such as new and enhanced features as well as fixes and limitations. The page also lists the release dates of each version, and the compatible Control Room and Bot Agent versions.

[Record variable](#) on page 2340

A record variable holds a row of data extracted from a database, spreadsheet, or table in name-field pairs. The fields can store values of Boolean, datetime, number, or string data type.

Related information

[Using loops to control a bot](#)

## Continue action

The Continue action in the Loop package enables you to continue the loop in your operation.

### Settings

Use the **Continue** action along with the **If** action to skip the current iteration and continue with the next iteration in the loop based on the condition you have specified in the **If** action.

## Break action

The Break action in the Loop package enables you to terminate the loop in your operation.

### Settings

Use the **Break** action along with the **If** action to terminate the loop based on the condition you have specified in the **If** action. When you terminate the loop, the actions immediately following the **Loop** action run.

## Using Loop action

Use the Loop action to repeatedly run a sequence of actions for a specific number of times or until a condition is met.

To repeatedly run a sequence of actions, do the following:

1. Double-click or drag the **Loop** action from the **Actions** palette.
2. Set the desired conditions for the loop.

Option	Action
Select the <b>Iterator</b> option to repeat the sequence of actions for a specific number of times.	Select an option from the <b>Iterator</b> list to specify how many times the sequence of actions is to be repeated.  See <a href="#">Loop package</a> on page 2784 for the list of available options.

Option	Action
Select the <b>While</b> option to repeat the sequence of actions until a condition is met.	<p><b>a)</b> Select an option from the <b>Condition</b> list to specify the condition.</p> <p><b>b)</b> Select the <b>Check the condition at the end of the iteration</b> to validate the condition at the end of each iteration. This option enables you to ensure that the set of actions run at least one time, even if the condition is not met.</p>

3. Double-click or drag the actions to be repeated within the **Loop**.
4. Optional: Double-click or drag the **Continue** action from the **Loop** package to skip the current iteration and continue with the next iteration of the loop.
5. Click **Save**.

## Using the For each row in CSV/TXT iterator

Use the **For each row in CSV/TXT** iterator in the **Loop** action to read the data of each row in a CSV or text file and assign the current row to a record variable. The bot reads the values in each cell as string-type values, even if there are numerical values.

First, open the CSV or text file. [Using the Open action for CSV/TXT file](#) on page 2450

**Note:** The **For each row in CSV/TXT** iterator only supports CSV/TXT files that conform to the RFC 4180 standard. For more information about the standard, see [Common format and MIME type for CSV files](#).

To use the **For each row in CSV/TXT** iterator in a **Loop** action, do the following:

1. Double-click or drag the **Loop** action from the **Loop** package in the **Actions** palette.
2. Select the **For each row in CSV/TXT** option from the **Iterator** list.
3. Enter the name of the session that you have used to open the CSV or text file in the **Open** action.
4. Select a record variable from the **Assign the current row to this variable** list or create a new one.

**Note:** If you select an existing record variable, ensure that the column headers capitalization in the CSV or text file match that of the schema of the record variable. [Schema](#) on page 2341

Insert actions to use the values from the CSV or text file in your automation. Use the record variable to retrieve the values by index number or column name. For example, if the first column of the file is titled EmployeeID, to retrieve the value of the first cell of each row enter `$rYourVariableName[0]$` or `$rYourVariableName{EmployeeID}$`.

**Note:** You must select the **Contains header** option in the **CSV/TXT > Open** action to specify the record values by column name.

For an example, see [Build a Bot Insight dashboard bot](#) on page 3253.

## Using the For each row in table iterator

Use the **For each row in table** iterator in the Loop action to read the data of each row in a table variable and assign the current row to a record variable.

First, retrieve the table values and store them to a table variable.

---

**Example:** [Example of extracting data from a web table](#) on page 3201

---

To use the **For each row in table** iterator in a **Loop** action, do the following:

1. Double-click or drag the **Loop** action from the **Loop** package in the **Actions** palette.
2. Select the **For each row in table** option from the **Iterator** list.
3. Select the variable that holds the values from the **Table variable** list.
4. Select a record variable from the **Assign the current row to this variable** list or create a new one.
5. Click **Save**.

Insert actions to use the values from the data table in your automation. Use the record variable to retrieve the values by index number or column name. For example, if the first column of the file is titled EmployeeID, to retrieve the value of the first cell of each row enter `$rYourVariableName[0]$` or `$rYourVariableName{EmployeeID}$`.

## Message box package

Use the **Message box** action from the **Message box** package to insert a message box that shows a message when the task runs. For example, you can insert a **Message Box** action to follow a web form so that the action displays the message: `Web Form Filled and Complete`.

For more information, see [Using the Message box action](#) on page 2796.

Use the following examples to learn how to use the **Message box** action when building automations.

- [Build a Go be Great bot](#) on page 3198  
Build a basic TaskBot using a Message Box action and a variable.
- [Build a basic bot that uses a desktop application](#) on page 3199  
An example of how to build a basic TaskBot that uses the calculator application.

Related reference

[Message Box package updates](#) on page 910

Review the updates in released versions of the Message Box package such as new and enhanced features as well as fixes and limitations. The page also lists the release dates of each version, and the compatible Control Room and Bot Agent versions.

## Using the Message box action

The **Message box** action in the Message Box package enables you to insert a message box that shows a message when the task runs.

1. Double-click or drag the **Message box** action from the **Message box** package in the **Actions** palette.

2. In the **Enter the message box window title** field, enter a window title for the message box.
3. In the **Enter the message to display** field, enter a message that you want the bot to display. This field holds up to 65535 alphanumeric characters, and empty values.

---

**Note:** To provide a string that includes a dollar sign (\$), you must enter two dollar signs. For example, if you enter `Pay $$5.00`, the output will be `Pay $5.00`.

---

4. In the **Scrollbar after lines** field, specify the number of lines at which you want to show a scroll bar.
5. Optional: Select the **Close message box after** option and specify the number of seconds after which you want the message box to close automatically.

---

**Important:** Select this check box if the bot will run on an unattended machine.

---

6. Click **Save**.

## Microsoft LUIS NLP package

The **Microsoft LUIS NLP** package contains actions that enable you to connect to and consume the Microsoft Cognitive Services Text Analytics API to identify the language, sentiment, key phrases, and entities. This package supports the following languages: English, Chinese (Simplified), French, German, and Spanish.

---

**Important:** This is a beta package and is currently not available with the Automation 360 Enterprise and Cloud editions.

---

### Before you start

You must have an Azure Cognitive Services resource to use these actions. See [Create a Cognitive Services resource using the Azure portal](#).

You also require the following in order to use the actions:

- **Service Endpoint URL:** the endpoint URL that identifies the Azure service.
- **Subscription Key:** the unique key that authenticates Automation Anywhere Enterprise.

### Actions in the Microsoft LUIS NLP package

Action	Description
<b>Detect language</b>	Identifies the language of the provided content and returns it in ISO 639-1 language code. The output is stored in a string variable.
<b>Get key phrases</b>	Identifies the main points and returns a list of key phrases. For example, if the input text is about a basketball game, this action returns the names of teams, the name of the venue, and the final score.

Action	Description
<b>Get named entities</b>	<p>Identifies the entities in the provided content such as people, places, organizations, date/time, quantities, branded products, and book titles.</p> <p>The output is stored in a dictionary variable, where each name is a key, and the corresponding entity is the value.</p>
<b>Get sentiment</b>	<p>Analyzes the provided content and returns a sentiment and score.</p> <ul style="list-style-type: none"> <li>• If the score is greater than 0.6, the sentiment is Positive.</li> <li>• If the score is in the 0.2 through 0.6 range, the sentiment is Neutral.</li> <li>• If the score is less than 0.2, the sentiment is Negative.</li> </ul> <p>The output is stored in a dictionary variable containing two keys and their corresponding values: <code>sentiment</code> and <code>score</code>.</p>

## Mouse package

Use the `Mouse` package to simulate mouse actions.

### Automation 360 extension setting

If the bot execution takes longer when you use the `Mouse` package to simulate mouse actions a static page running on the Google Chrome or Microsoft Edge browser, then follow these steps to enable the setting in the Automation 360 extension:

- Click the extensions icon at the top right corner of the browser window.
- Click the vertical ellipses next to the `plugin` and select **Manage extension**.
- Enable the **Allow access to file URLs** option.
- Restart the browser and run the .

### Actions in the Mouse package

The `Mouse` package includes the following actions:

**Note:** When you create an automation that contains **Mouse** actions to capture a UI element, (such as the screen or window), and if the target application is not responding, the bot times out after 30 seconds (default time) and displays a detailed message including: what went wrong at line number and the corresponding corrective action to take.

Action	Description
Click	See <a href="#">Using the Click action</a> on page 2799.
Move	See <a href="#">Using the Move action</a> on page 2801.

---

Action	Description
Scroll	See <a href="#">Using the Scroll action</a> on page 2801.

## Secure recording

When secure recording mode is enabled, bots do not display the target object images after capture. This ensures that sensitive data is not shown.

---

**Note:** Although the bots do not display the target images after capture, the images are still stored in the Control Room because they are required to run the bots.

---

When you record a task in secure recording mode, the **Preview** window temporarily shows an image of the captured area. This image is hidden after you navigate away from the Bot editor window or refresh it.

A user with admin privileges must enable this setting. See [Settings](#) on page 1789.

Related reference

[Screen resolution dependent packages](#) on page 1802

The screen resolution between the Bot Runner and Bot Creator device should be consistent as when resolution-dependent packages are used to build bots, any screen resolution difference between the Bot Creator and Bot Runner device will impact the bots during runtime.

[Mouse package updates](#) on page 920

Review the updates in released versions of the Mouse package such as new and enhanced features as well as fixes and limitations. The page also lists the release dates of each version, and the compatible Control Room and Bot Agent versions.

## Using the Click action

The **Click** action in the Mouse package enables a bot to simulate mouse clicks. This action enables to capture the UI element such as the screen or window, and to specify the click event and click button.

Ensure that the screen scale and resolution of the Bot Creator device is the same as the Bot Runner device. If the screen scale and resolution are different, the bot might fail when deployed to the Bot Runner device.

If you are using Internet Explorer, the bot waits until the browser is completely rendered and is in a ready state before executing the **Click** action.

Follow these steps to add a **Click** action:

1. In the **Actions** palette, double-click or drag the **Click** action from the **Mouse** package.
2. Specify the window in which to capture the mouse click:  
Choose from the **Application**, **Browser**, or **Variable** tab.

Option	Description
Application	Select from a list of currently active windows.  <b>Note:</b> You can use the <b>Screen</b> option to capture coordinates on the device screen, however we recommend specifying a window because screen sizes can change, which distorts the captured coordinates.
Browser	Select from a list of supported browser tabs.  <b>Note:</b> This option supports , Chromium-based , and browsers.
Variable	Select an existing window variable to specify the title of the application window title.  <b>Note:</b> This option deactivates the <b>Capture</b> option. Use this option only after you have completed the capture step.

Insert a wildcard character (\*) in the **Window title** field to search for window titles that can change. You can specify one or more wildcards (\*) at the start, middle, or end of the value. For example, to perform an operation on any window that has `Microsoft` in the title, use a wildcard to indicate any string by adding it before or after the value: `*Microsoft*`. The first searches for the exact window title (`Microsoft`), and if it does not find a match, it searches for windows with the term `Microsoft` anywhere in the title.

You can use a regular expression (regex) to identify a window title. Select the regular expression condition as either **String** or a **Pattern** and then enter the value. By default, the **Window title** field is case-sensitive.

To identify a browser title, you can enable the **Case sensitive** option to match the letter case, or disable the option to identify a window title where the letter case does not match.

**Note:** Ensure that the minimum version installed on your system is the version that was released with v.26. If you have a version released with v.25 or earlier, then by default, the window title will be identified only with matching letter case (case-sensitive).

For example, you can enter the **String** value as `(\w*)-Notepad` for all window title names starting with `(\w*)-Notepad`, or use **Pattern** value as `(\w)\s)*document-Notepad` for only those window titles that match this pattern.

**Note:**

- When you use a regular expression of type **String** with `-title` as the input value for a window title in any , the might encounter a run time error. To prevent the run time error, ensure that when you add the string input as `*-title`, the application with the specific title is open. The asterisk (\*) is just a character, not a wild card character.
- When you use a regular expression of type **Pattern** with `-title` as the input value for a window title in any , the might encounter a run time error because the input value `*-title` is incorrect.



Ensure that you use valid regex patterns.

- 
- Optional: Select the **Resize window** option to specify the window dimensions. This option delivers a more reliable bot. It resizes the window to the dimensions at which the task was recorded, which enhances the ability of the bot to identify the target object.
    - If the window is maximized when you record the task, this option is not selected.
    - If the window is not at the maximum size when you record the task, this option is selected, by default, and the width and height fields are automatically filled with the dimensions of the window.

---

**Note:** This option is available only for windows that can be resized. It is not available for the **Desktop** or **Taskbar** options.

---

- Click **Capture coordinate**.  
The selected window appears.
- Drag the mouse to select the click spot and left-click to capture it.  
The captured spot appears in the **Preview** section with the coordinates underneath.
- In the **Button** option, specify the button to click.  
Choose from **Left Button**, **Right Button**, or **Middle Button**.
- In the **Event** option, specify the event.  
Choose from **Click**, **Double click**, **Button up**, or **Button down**.
- Click **Save**.

## Using the Move action

The **Move** action in the Mouse package enables you to simulate moving the mouse pointer from one location to another.

Follow these steps to add a **Move** action:

- In the **Actions** palette, double-click or drag the **Move** action from the **Mouse** package.
- In the **Mouse from** and **Mouse to** fields, specify the **X** and **Y** coordinates.
- Click **Capture coordinate** to capture the starting point location.
- Click **Capture coordinate** to capture the end point location.
- Optional: In the **Delay in milliseconds** field, specify the total duration of the movement in milliseconds.
- Click **Save**.

## Using the Scroll action

The **Scroll** action in the Mouse package enables you to simulate scrolling the mouse wheel up or down.

Follow these steps to add a **Scroll** action:

- In the **Actions** palette, double-click or drag the **Scroll** action from the **Mouse** package.
- In the **Select scroll option**, select the **Up** or **Down** option.

3. In the **Number of iterations** field, specify the number of times to scroll.
4. Optional: In the **Delay in milliseconds** field, specify the total duration of the scrolling in milliseconds.
5. Click **Save**.

## Number package

The Number package contains actions that enable you to perform various operations on a number variable. A number variable holds numeric values, including integers and decimals. It holds values from -9,223,372,036,854,775,808 to 9,223,372,036,854,775,807, and up to 15 decimal digits.

### Actions in the Number package

The actions in the Number package accept a variable as an input and assign the output to a variable. These actions enable you to assign a value to a Number variable, decrement or increment a number, or convert a Number variable to a String variable.

You can use large numbers in number variables or in actions to perform mathematical operations. In the bot editor, use the actions menu (vertical ellipsis at the top-right) to select the **Advanced settings > Enable improved number support**.

---

**Note:** Ensure you update to the latest version of the package to use this feature.

---

The Number package includes the following actions:

Action	Description
Assign	See <a href="#">Assign action in Number</a> on page 2803
Decrement	See <a href="#">Decrement action in Number</a> on page 2803
Increment	See <a href="#">Increment action in Number</a> on page 2803
Random	See <a href="#">Random action in Number</a> on page 2804
To string	See <a href="#">To string action in Number</a> on page 2804

Related reference

[Number package updates](#) on page 921

Review the updates in released versions of packages such as new and enhanced features as well as fixes and limitations. The page also lists the release dates of each version, and the compatible Control Room and Bot Agent versions.

## Assign action in Number

The Assign action in the Number package enables you to assign a specified number or result of an expression to a user-defined Number variable. You can use expressions built using the +, -, \*, and / operators and use parentheses to group expressions. For example,  $(3*4)+5$  or  $(\$Variable2*\$Variable3)/\$Variable1$ .

### Settings

- In the **Select the source number variable/value**, enter a number or select a predefined Number variable.
- In the **Select the destination number variable**, select a predefined Number variable or create a new one to hold the output.

## Decrement action in Number

The Decrement action in the Number package enables you to decrement (decreases by set intervals) a number by a user-specified value.

### Settings

- In the **Enter number** field, enter a number or select a predefined Number variable.
- In the **Enter decrement value** field, enter the decrement value or select a predefined Number variable.
- In the **Assign the output to variable** field, select a predefined Number variable or create a new one to hold the output.

## Increment action in Number

The Increment action in the Number package enables you to increment (increases by set intervals) a number by a user-specified value.

### Settings

- In the **Enter number** field, enter a number or select a predefined Number variable.
- In the **Enter increment value** field, enter the increment value, the value must be greater than zero or select a predefined Number variable.
- In the **Assign the output to variable** field, select a predefined Number variable or create a new one to hold the output.

## Random action in Number

The Random action in the Number package enables you to generate a random integer from a user-specified range and assign it to a number variable.

### Settings

- In the **Beginning of range** field, enter a number or select a predefined number variable.

---

**Note:** This field accepts values in the range of -9,223,372,036,854,775,808 through 9,223,372,036,854,775,807, and up to 15 decimal digits.

---

- In the **End of range** field, enter a number or select a predefined number variable that is greater than the value in the **Beginning of range** field.

---

**Note:** This field accepts values in the range of -9,223,372,036,854,775,808 through 9,223,372,036,854,775,807, and up to 15 decimal digits.

---

- Enter the number of digits after the decimal by selecting the **Specify number of decimals** check box.
- In the **Save the outcome to a variable** field, select a predefined Number variable or create a new one to hold the output.

## To string action in Number

The To string action in the Number package enables you to convert a user-specified number to a string.

### Settings

- In the **Enter number** field, enter a number or select a predefined Number variable.
- In the **Enter number of digits after decimal** field, enter the amount of digits after the decimal. To remove all the digits after the decimal, leave the default value of 0.
- In the **Assign the output to variable** field, select a pre-defined String variable or create a new one to hold the output. You can use prompt-assignment during building and testing of the bot.

---

**Important:** Ensure that you reassign the values from prompt-assignment to a user-created variable before deploying the bot into production.

---

## OCR package

The OCR package contains actions that enable you to extract text from images or applications.

The OCR package enables you to:

- Extract text from a window or a specific area of an application.
- Extract text from images or files stored on a local machine, a website, or the Control Room folder.

- Filter extracted text and store it as a variable.

---

**Note:** You can extract text from images in .jpeg, .jpg, .bmp, .gif, and .png formats.

---

ABBYY FineReader 12.2.27.12 is installed along with A2019 and does not require any additional setup.

## Actions in the OCR package

The OCR package includes the following actions:

Action	Description
Capture image by path	See <a href="#">Using Capture image by path action</a> on page 2806.
Capture image by url	See <a href="#">Using Capture image by URL action</a> on page 2807.
Capture window	See <a href="#">Using Capture window action from OCR package</a> on page 2807.
Capture area	See <a href="#">Using Capture area action from OCR package</a> on page 2809.

---

### Note:

Below is a sample .ini template file that you can use to load profiles. You can use the parameters and set their values, as required. You can also add new parameters supported by ABBYY Fine Reader Engine.

```
;Sample parameter1
[BarcodeParams]
;Parameter value
EnableAdvancedExtractionMode=True
;Sample parameter2
[ObjectsExtractionParams]
;Parameter value
DetectTextOnPictures=True
```

For detailed information about pre-defined profiles specifications, see [ABBYY Profiles](#).

---

## Secure recording

When secure recording mode is enabled, bots do not display the target object images after capture. This ensures that sensitive data is not shown.

---

**Note:** Although the bots do not display the target images after capture, the images are still stored in the Control Room because they are required to run the bots.

---

When you record a task in secure recording mode, the **Preview** window temporarily shows an image of the captured area. This image is hidden after you navigate away from the Bot editor window or refresh it.

A user with admin privileges must enable this setting. See [Settings](#) on page 1789.

Related reference

[Screen resolution dependent packages](#) on page 1802

The screen resolution between the Bot Runner and Bot Creator device should be consistent as when resolution-dependent packages are used to build bots, any screen resolution difference between the Bot Creator and Bot Runner device will impact the bots during runtime.

[OCR package updates](#) on page 923

Review the updates in released versions of the OCR package such as new and enhanced features as well as fixes and limitations. The page also lists the release dates of each version, and the compatible Control Room and Bot Agent versions.

## Using Capture image by path action

Use the **Capture image by path** action to extract text from an image on a device or a folder in the Control Room. The extracted text can assigned as a variable.

Follow these steps to use the **Capture image by path** action:

1. In the **Actions** palette, double-click or drag the **Capture image by path** action from the **OCR** package.
2. In the **Image path** field, select an option:
  - **Control Room file**: Uses a file that is available on the Control Room.
  - **Desktop file**: Uses a file that is available on a device.
  - **Variable**: Uses a file variable to specify the file location.

---

**Note:** If you use a high resolution image, text extraction by OCR might be partial or inaccurate. For best results while extracting text from an image using OCR, ensure that you use images with lower resolution (such as 200 dpi or 300 dpi).

---

3. Select the **Filter the captured text** check box to filter the captured text.  
Specify the text to filter out in the **Before** and **After** fields. For example, if the extracted text is `Name: ABC Inc. Location:`, to retrieve `ABC Inc.`, you must specify `Location:` in the **Before** field and `Name:` in the **After** field.
4. Select the **Trim the captured text** check box to trim the extra spaces.
5. Select the **Load Profile** check box and select an option to load the locale based on the ABBYY profile:

---

**Note:** ABBYY FineReader 12.2.27.12 is installed along with A2019 and does not require any additional setup.

---

- **Control Room file**: Uses a file that is available on the Control Room.
  - **Desktop file**: Uses a file that is available on a device.
  - **Variable**: Uses a file variable to specify the file location.
6. In the **Select locale** list, select the language of the device.

---

**Note:** Currently, only English, Japanese, and Russian locales are supported. If you have selected an option from the **Select locale** list and the **Load Profile** option, the system considers the locale based on the **Load Profile** selection.

---

7. In the **Assign value to variable** list, select a string variable.
8. Click **Save**.

## Using Capture image by URL action

Use the **Capture image by url** action to extract text from an online image. You can filter the extracted text and assign it to a string variable.

Follow these steps to use the **Capture image by url** action:

1. In the **Actions** palette, double-click or drag the **Capture image by url** action from the **OCR** package.
2. In the **Image url** field, specify the URL.

---

**Note:** A URL of an image on a shared drive or an FTP server is not supported.

---

3. Select the **Filter the captured text** check box to filter the captured text.  
Specify the text to filter out in the **Before** and **After** fields. For example, if the extracted text is **Name: ABC Inc. Location:**, to retrieve **ABC Inc.**, you must specify **Location:** in the **Before** field and **Name:** in the **After** field.
4. Select the **Trim the captured text** check box to trim the extra spaces.
5. Select the **Load Profile** check box and select an option to load the locale based on the ABBYY profile:

---

**Note:** ABBYY FineReader 12.2.27.12 is installed along with A2019 and does not require any additional setup.

---

- **Control Room file:** Uses a file that is available on the Control Room.
- **Desktop file:** Uses a file that is available on a device.
- **Variable:** Uses a file variable to specify the file location.

6. In the **Select locale** list, select the language of the device.

---

**Note:** Currently, only English, Japanese, and Russian locales are supported. If you have selected an option from the **Select locale** list and the **Load Profile** option, the system considers the locale based on the **Load Profile** selection.

---

7. In the **Assign value to variable** list, select a string variable.
8. Click **Save**.

## Using Capture window action from OCR package

Use the **Capture window** action to extract text from an application window. You can filter the extracted text and assign it to a string variable.

---

**Note:** When you use the **Capture window** action to extract text from an application window and, if the target application is not responding, the bot times out after 30 seconds (default time) and displays a more detailed message including: what went wrong at line number and the corresponding corrective action to take.

---

Follow these steps to use the **Capture window** action:

1. In the **Actions** palette, double-click or drag the **Capture window** action from the **OCR** package.
2. In the **Window title** field, select an option:

- **Window:** Captures a window on a desktop. In the **Window title** field, specify the application title.
- **Variable:** Inserts an existing window variable. Click **Variable** tab to create a new string variable.

Insert a wildcard character (\*) in the **Window title** field to search for window titles that can change. You can specify one or more wildcards (\*) at the start, middle, or end of the value. For example, to perform an operation on any window that has `Microsoft` in the title, use a wildcard to indicate any string by adding it before or after the value: `*Microsoft*`. The first searches for the exact window title (`Microsoft`), and if it does not find a match, it searches for windows with the term `Microsoft` anywhere in the title.

You can use a regular expression (regex) to identify a window title. Select the regular expression condition as either **String** or a **Pattern** and then enter the value. By default, the **Window title** field is case-sensitive.

To identify a browser title, you can enable the **Case sensitive** option to match the letter case, or disable the option to identify a window title where the letter case does not match.

---

**Note:** Ensure that the minimum version installed on your system is the version that was released with v.26. If you have a version released with v.25 or earlier, then by default, the window title will be identified only with matching letter case (case-sensitive).

---

For example, you can enter the **String** value as `(\w*)-Notepad` for all window title names starting with `(\w*)-Notepad`, or use **Pattern** value as `(\w)\s)*document-Notepad` for only those window titles that match this pattern.

---

**Note:**

- When you use a regular expression of type **String** with `-title` as the input value for a window title in any , the might encounter a run time error. To prevent the run time error, ensure that when you add the string input as `*-title`, the application with the specific title is open. The asterisk (\*) is just a character, not a wild card character.
- When you use a regular expression of type **Pattern** with `-title` as the input value for a window title in any , the might encounter a run time error because the input value `*-title` is incorrect.

Ensure that you use valid regex patterns.

---

**3.** Optional: Select the **Resize window** option to specify the window dimensions.

This option delivers a more reliable bot. It resizes the window to the dimensions at which the task was recorded, which enhances the ability of the bot to identify the target object.

- If the window is maximized when you record the task, this option is not selected.
- If the window is not at the maximum size when you record the task, this option is selected, by default, and the width and height fields are automatically filled with the dimensions of the window.

---

**Note:** This option is available only for windows that can be resized. It is not available for the **Desktop** or **Taskbar** options.

---

**4.** In the **Wait before capturing the image (ms)** field, specify the delay time.



**Recommendation:** If you are capturing in a window that is accessed using Remote Desktop Protocol (RDP), set a minimum delay time of 1000 milliseconds to give the window time to load.

---

5. Select the **Filter the captured text** check box to filter the captured text.  
Specify the text to filter out in the **Before** and **After** fields. For example, if the extracted text is **Name: ABC Inc. Location:**, to retrieve **ABC Inc.**, you must specify **Location:** in the **Before** field and **Name:** in the **After** field.
6. Select the **Trim the captured text** check box to trim the extra spaces.
7. Select the **Load Profile** check box and select an option to load the locale based on the ABBYY profile:

**Note:** ABBYY FineReader 12.2.27.12 is installed along with A2019 and does not require any additional setup.

---

- **Control Room file:** Uses a file that is available on the Control Room.
  - **Desktop file:** Uses a file that is available on a device.
  - **Variable:** Uses a file variable to specify the file location.
8. In the **Select locale** list, select the language of the device.

**Note:** Currently, only English, Japanese, and Russian locales are supported. If you have selected an option from the **Select locale** list and the **Load Profile** option, the system considers the locale based on the **Load Profile** selection.

---

9. In the **Assign value to variable** list, select a string variable.
10. Click **Save**.

## Using Capture area action from OCR package

Use the **Capture area** action to extract text from a specific area in an application window. You can filter the extracted text and assign it as a variable.

---

**Note:** When you use the **Capture area** action to extract text from a specific area in an application window and, if the target application is not responding, the bot times out after 30 seconds (default time) and displays a more detailed message including: what went wrong at line number and the corresponding corrective action to take.

To improve the accuracy of extracting text from a specific area in an application window, see this [Predefined profiles specification](#)

---

Follow these steps to use the **Capture area** action:

1. In the **Actions** palette, double-click or drag the **Capture area** action from the **OCR** package.
2. In the **Window title** field, select an option:
  - **Window:** Captures a window on a desktop. In the **Window title** field, specify the application title.
  - **Variable:** Inserts an existing window variable.

Insert a wildcard character (\*) in the **Window title** field to search for window titles that can change. You can specify one or more wildcards (\*) at the start, middle, or end of the value. For example, to perform an operation on any window that has `Microsoft` in the title, use a wildcard to indicate any string by adding it before or after the value: `*Microsoft*`. The first searches for the exact window title (`Microsoft`), and if it does not find a match, it searches for windows with the term `Microsoft` anywhere in the title.

You can use a regular expression (regex) to identify a window title. Select the regular expression condition as either **String** or a **Pattern** and then enter the value. By default, the **Window title** field is case-sensitive.

To identify a browser title, you can enable the **Case sensitive** option to match the letter case, or disable the option to identify a window title where the letter case does not match.

---

**Note:** Ensure that the minimum version installed on your system is the version that was released with v.26. If you have a version released with v.25 or earlier, then by default, the window title will be identified only with matching letter case (case-sensitive).

---

For example, you can enter the **String** value as `(\w*)-Notepad` for all window title names starting with `(\w*)-Notepad`, or use **Pattern** value as `(\w)\s*document-Notepad` for only those window titles that match this pattern.

---

**Note:**

- When you use a regular expression of type **String** with `-title` as the input value for a window title in any , the might encounter a run time error. To prevent the run time error, ensure that when you add the string input as `*-title`, the application with the specific title is open. The asterisk (\*) is just a character, not a wild card character.
- When you use a regular expression of type **Pattern** with `-title` as the input value for a window title in any , the might encounter a run time error because the input value `*-title` is incorrect.

Ensure that you use valid regex patterns.

---

**3.** Optional: Select the **Resize window** option to specify the window dimensions.

This option delivers a more reliable bot. It resizes the window to the dimensions at which the task was recorded, which enhances the ability of the bot to identify the target object.

- If the window is maximized when you record the task, this option is not selected.
  - If the window is not at the maximum size when you record the task, this option is selected, by default, and the width and height fields are automatically filled with the dimensions of the window.
- 

**Note:** This option is available only for windows that can be resized. It is not available for the **Desktop** or **Taskbar** options.

---

**4.** Specify the **X, Y, Width, and Height** coordinates.

**5.** Click **Capture region**.

The bot captures text from the visible area of the screen even if the target area is below the visible screen.

**6.** In the **Wait before capturing the image (ms)** field, specify the delay time.

---

**Recommendation:** If you are capturing in a window that is accessed using Remote Desktop Protocol (RDP), set a minimum delay time of 1000 milliseconds to give the window time to load.

---

7. Select the **Filter the captured text** check box to filter the captured text.  
Specify the text to filter out in the **Before** and **After** fields. For example, if the extracted text is **Name: ABC Inc. Location:**, to retrieve **ABC Inc.**, you must specify **Location:** in the **Before** field and **Name:** in the **After** field.
8. Select the **Trim the captured text** check box to trim the extra spaces.
9. Select the **Load Profile** check box and select an option to load the locale based on the ABBYY profile:

**Note:** ABBYY FineReader 12.2.27.12 is installed along with A2019 and does not require any additional setup.

---

- **Control Room file:** Uses a file that is available on the Control Room.
  - **Desktop file:** Uses a file that is available on a device.
  - **Variable:** Uses a file variable to specify the file location.
10. In the **Select locale** list, select the language of the device.

**Note:** Currently, only English, Japanese, and Russian locales are supported. If you have selected an option from the **Select locale** list and the **Load Profile** option, the system considers the locale based on the **Load Profile** selection.

---

11. In the **Assign value to variable** list, select a string variable.
12. Click **Save**.

## Microsoft 365 Calendar package

This package contains actions that enable you to automate meeting-related tasks in Microsoft 365 Calendar.

### Before you start

---

**Note:** Microsoft has deprecated EWS API for Exchange Online and has recommended users to move to Graph API. Starting from Automation 360 v.29, Office 365 Calendar package is now called Microsoft 365 Calendar package. Although the package name has changed, the functionality remains the same. So your existing bots from previous releases will continue to work as expected after an update to Automation 360 v.29.

---

Perform the following actions within the Microsoft 365 Calendar package as part of using the set of available actions:

1. Use the **Connect** action to establish a connection to the Microsoft 365 server.  
See [Using Connect action in Microsoft 365 Calendar package](#) on page 2814.

**Note:** Microsoft 365 packages do not currently support multi-factor authentication (MFA) or single sign-on (SSO).

2. Use a combination of actions available in this package to automate tasks.

**Note:** To use actions from other Microsoft 365 packages, establish a connection using the **Connect** action from that package.

3. Use the **Disconnect** action to terminate the connection.

## Actions in the Microsoft 365 Calendar package

The Microsoft 365 Calendar package contains the following actions:

Action	Description
Add attachment	See <a href="#">Add attachment action in Microsoft 365 Calendar</a> on page 2813
Add attendees	See <a href="#">Add attendees action in Microsoft 365 Calendar</a> on page 2813
Cancel meeting	See <a href="#">Cancel meeting action in Microsoft 365 Calendar</a> on page 2814
Connect	Establishes a connection with the Microsoft 365 server using your organization's client ID and tenant ID, and user credentials.  See <a href="#">Using Connect action in Microsoft 365 Calendar package</a> on page 2814.
Create meeting	See <a href="#">Using the Create Meeting action</a> on page 2817.
Delete attendees	See <a href="#">Delete attendees action in Microsoft 365 Calendar</a> on page 2818
Delete meeting information	See <a href="#">Delete meeting information action in Microsoft 365 Calendar</a> on page 2818
Disconnect	Terminates the connection with the Microsoft 365 server. Enter the session name that you used in the <b>Connect</b> action. Insert this action at the end of automation sequences that use actions from this Microsoft 365 package. See <a href="#">Using Disconnect action in Microsoft 365 Calendar package</a> on page 2819.
Get available meeting slot(s)	See <a href="#">Using the Get available meeting slots action</a> on page 2819.
Modify meeting	See <a href="#">Modify meeting action in Microsoft 365 Calendar</a> on page 2819

---

Action	Description
Respond to meeting	See <a href="#">Respond to meeting action in Microsoft 365 Calendar</a> on page 2820

---

**Note:** Some of the actions must be used within a **Loop** action to apply the action to each meeting in the calendar. See [Using Microsoft 365 Calendar actions in a loop](#) on page 2820.

---

Related reference

[Microsoft 365 Calendar package updates](#) on page 911

Review the updates in released versions of the Microsoft 365 Calendar package such as new and enhanced features as well as fixes and limitations. The page also lists the release dates of each version, and the compatible Control Room and Bot Agent versions.

## Add attachment action in Microsoft 365 Calendar

The **Add attachment** action in the Microsoft 365 Calendar package enables you to add one or more attachments to a meeting.

### Settings

Use this action within a **Loop** action to repeat this operation for each meeting in the calendar. See [Loop package](#) on page 2784.

- Provide the session name that you used in the **Connect** action.
- Select the files to attach from the Control Room or your desktop, or insert a file variable. Separate each file path with a comma.

## Add attendees action in Microsoft 365 Calendar

The **Add attendees** action in the Microsoft 365 Calendar package enables you to add one or more attendees to a meeting and specifies whether attendance is optional or required.

### Settings

During run time, this triggers an email notification to meeting attendees. Use this within a **Loop** to repeat this operation for each meeting in the calendar. See [Loop package](#) on page 2784.

- Provide the session name that you used in the **Connect** .
- Enter the attendee emails into the **Required** or **Optional** fields. Separate each email with a comma.

## Cancel meeting action in Microsoft 365 Calendar

The **Cancel meeting** action in the Microsoft 365 Calendar package enables you to cancel the meeting.

### Settings

During run time, this triggers an email notification to meeting attendees. Use this within a **Loop** to repeat this operation for each meeting in the calendar. See [Loop package](#) on page 2784.

## Using Connect action in Microsoft 365 Calendar package

Use the **Connect** action in the Microsoft 365 Calendar package to establish a connection with the Microsoft 365 server using your organization's (client ID and tenant ID) and user credentials.

All the fields in the **Connect** action accepts a credential from the Credential Vault or a user-input value.

---

**Note:** Note the following conditions for the **Connect** action:

- Does not currently support MFA or SSO.
- Ensure that the administrator consent for the permissions is granted.

- 
1. Log in to the [Azure portal](#) using your Microsoft 365 credentials.
  2. Register your application with the Microsoft identity platform to obtain the client ID and tenant ID. See [Register your app](#).
  3. Grant the required permissions for Microsoft Graph to the application.  
See [Permissions for application](#) on page 2816.

---

**Note:** For your app registration on Azure portal, navigate to **Authentication > Advanced Settings > Allow public client flows** and ensure that you select **Yes**.

- 
4. To add a client secret, you must first subscribe to Azure. See [Subscribe to Azure](#).
  5. Add a client secret. See [Add a client secret](#).

For an example on how to setup and connect to the Microsoft 365 OneDrive package, see [Setup Azure App to connect using Microsoft OneDrive package \(A-People login required\)](#).

1. In the Actions palette, double-click or drag the **Connect** action from the package you want to use.
2. In the **Microsoft 365 Calendar user session** field, enter a session name.  
(Optional) Click the **Insert a value** icon to select an existing variable.

---

**Note:** Enter this session name in subsequent actions in this package.

- 
3. Click the **OAuth2 Authentication Mode** to select one of the options:
    - **Control Room managed**

You can use this option to use the connections without having to enter any authentication details. Use the following fields to update the information: Use the following fields to update the information:

- **Connection:** click the **Pick** button to select an existing connection.
  - Click the **Provider type** drop-down menu to select an available or custom provider.  
For information in creating a custom provider, see [Configure OAuth2 parameters in the Control Room](#) on page 2865.
  - Click the **Connection name** to select the corresponding connection for the selected provider.
  - Use the **Token type** field to select one of the following options:

- **Shared:** for a global token.

An access token of shared type is created when a connection is established to the Control Room. This access token is stored as a credential. When you run your automation, the access token is referenced in the automation using the enterprise application provider type set up in the Control Room.

- **User-specific:** for a token that is specific to a user.

If you select this option, ensure that you log in to your Microsoft 365 account to authenticate and generate a user-specific token. Perform the following steps to use this option:

- a) Log in to Control Room and navigate to **My settings > OAuth connections** in your profile.
- b) Under the **OAuth connections** tab, click **Login to authenticate**.
- c) Sign in to your Microsoft 365 account and select **Continue**.
- d) Verify the services you have access to and click **Continue**.

If the connection is succeeded, it will display the status as **Active** under the **OAuth connections > Connections** table.

- Click one of the following tabs in the **Username** field:
  - **Credential:** click the **Pick** button to select a value in the Credential Vault that contains information about the username.
  - **Variable:** to use a user-defined variable that contains information about the username.
  - **Insecure string:** to enter a value.

- **ROPC**

Use the following fields to enter the information that is provided for your account on your [Azure portal](#)

- **Client ID:** enter the Microsoft 365 client ID or insert it from the Credential Vault.
- **Tenant ID:** enter the unique ID for your Microsoft 365 subscription or insert it from the Credential Vault.
- **Username:** enter the username that you want to use for accessing Microsoft 365 Calendar.
- **Password:** specify the Microsoft 365 password:

- **Client secret:** enter your access token or insert it from the Credential Vault.

For all the above fields, you can use one of the following tabs to insert a value:

- **Credential:** to use a value in the Credential Vault that contains information about the Client ID/Client secret/ username/ password..
- **Variable:** to use a user-defined variable that contains information about the Client ID/ Client secret/ username/ password.
- **Insecure string:** to enter a value.

#### 4. Click **Save**.

### Permissions for application

After registering Microsoft 365, you must grant certain permissions to the application. These permissions are required to enable Microsoft 365 packages to perform various operations.

To grant permissions to an application, see [Add permissions](#).

---

**Note:** You must be the co-owner of the application for which you are configuring permissions.

---

The following [Delegated permissions](#) for Microsoft Graph are required for Microsoft 365 packages:

Common permissions	
	<a href="#">openid</a>
	<a href="#">offline_access</a>
	<a href="#">User.Read</a>
	<a href="#">User.ReadBasic.All</a>
One Drive	
	<a href="#">Files.ReadWrite.All</a>
	<a href="#">Sites.ReadWrite.All</a>
Calendar	
	<a href="#">Calendars.Read</a>
	<a href="#">Calendars.Read.Shared</a>
	<a href="#">Calendars.ReadWrite</a>
Email	
	<a href="#">Mail.Read</a>
	<a href="#">Mail.ReadWrite</a>
	<a href="#">MailboxSettings.Read</a>
	<a href="#">MailboxSettings.ReadWrite</a>
Directory	



	Directory.AccessAsUser.All
	Directory.ReadWrite.All

Apart from the above permissions, you can grant additional permissions based on your requirements. See, [Microsoft Graph permission reference](#).

## Using the Create Meeting action

Use the **Create Meeting** action to specify a meeting agenda, attachments, attendees, duration, location, recurrence, and title. During run time, this action sends an invitation email to meeting attendees.

This action uses two Datetime variables to set the meeting start and end. Define the values before you start. The recurrence option also uses two Datetime variables to set the start and end. For more information, see [Your variables \(user-defined\)](#) on page 2331.

To create a meeting, do the following:

1. Enter the session name that you used in the **Connect** action.
2. Enter the calendar name.  
This field is case-sensitive.  
The Calendar appears and is the default Microsoft Office setting.
3. Specify the meeting start date and time.  
Select a DateTime variable from the drop-down list.
4. Specify the meeting end date and time.  
Select a DateTime variable with a value that is the same or after the start time.
5. Optional: Mark the **All day meeting** option.  
For an all day meeting, ensure that there is a one-day difference between the start and end dates.
6. Enter attendee email addresses, separated by commas.
7. Optional: Enter the following details:
  - Attach a file from the Control Room, Desktop, or insert a File variable.
  - Enter a meeting title.
  - Enter a meeting location.
  - Enter an agenda.
  - Set a reminder.
  - Set a recurrence with the following options:
    - Select the recurrence type: **Daily**, **Weekly**, **Monthly**, or **Yearly**.
      - For **Weekly** recurrence, mark the days of the week on which the meeting takes place.
      - For **Monthly** recurrence, either enter the numerical date or select a day.

For example, to schedule a meeting that takes place on the twenty-fifth day of the month enter 25 in the **Specific date** field.

---

**Note:** If you enter 31 in the **Specific date** field, for the months with less than 31 days, the meeting will schedule for the last day of the month.

---

To schedule it for the last Monday of the month, select **Last** from the **Occurrence** drop-down list and **Monday** from the **Weekday** drop-down list.

- For **Yearly** recurrence, either enter the numerical date and month or select a day and month.

For example, to schedule a meeting that takes place on March 15, enter 15 in the **Specific Date** field and **March** in the **Month** field. To schedule it for the second Friday in March, select **Second** from the **Occurrence** drop-down list, select **Friday** from the **Weekday** drop-down list, and **March** from the **Month** drop-down list.

- Enter the recurrence frequency.
- Specify the recurrence start by selecting a DateTime variable from the drop-down list.
- If the recurrence has an end date, select a DateTime variable from the drop-down list.

## Delete attendees action in Microsoft 365 Calendar

The **Delete attendees** action in the Microsoft 365 Calendar package enables you to delete attendees from a meeting.

### Settings

During run time, this action triggers an email notification to meeting attendees. Use this within a **Loop** to repeat this operation for each meeting in the calendar. See [Loop package](#) on page 2784.

- Provide the session name that you used in the **Connect** .
- Select an option to delete: **meeting** or **attendees**. To delete attendees, provide the email addresses of the attendees, separated by commas.

## Delete meeting information action in Microsoft 365 Calendar

The **Delete meeting information** action in the Microsoft 365 Calendar package enables you to delete information related to a meeting such as the title or location.

### Settings

Use this within a **Loop** to repeat this operation for each meeting in the calendar. See [Loop package](#) on page 2784.

- Provide the session name that you used in the **Connect** .
- Select the meeting information to delete. The options are:
  - Title
  - Location
  - Agenda
  - Reminder
  - Recurrence

- Is all day

## Using Disconnect action in Microsoft 365 Calendar package

Use the **Disconnect** action in the specific Microsoft 365 Calendar package to terminate the connection from the application.

### Settings

Enter the user session that you provided in the **Connect** action.

## Using the Get available meeting slots action

Use the **Get available meeting slots** action to retrieve available time slots for attendees in a specified date and time range. This action supports scheduling across time zones.

This action considers a time slot as available if it is within an attendee's working hours and if the attendee has not already accepted a meeting for that time. If an attendee tentatively responds or does not respond to an invitation, this action considers them available.

To retrieve available time slots, perform the following steps:

1. Enter the session name that you used in the **Connect** action.
2. Enter the email addresses of the attendees, separated by commas.
3. Enter the duration of the meeting in minutes.
4. Specify the range start date and time by selecting a DateTime variable from the drop-down list.
5. Specify the range end date and time by select a DateTime variable with a value that is the same or after the start time.
6. Optional: Select the **Check for timeslots outside working hours** option.
7. Select a Table variable from the drop-down list.
8. Click **Save**.

## Modify meeting action in Microsoft 365 Calendar

The **Modify meeting** action in the Microsoft 365 Calendar package enables you to modify information for a meeting.

### Settings

Use this within a **Loop** to repeat this operation for each meeting in the calendar. See [Loop package](#) on page 2784.

- Provide the session name that you used in the **Connect** .
- Modify any of the following:
  - Meeting start or end date.
  - Convert the meeting to all day.

- Revise the meeting title.
- Revise the agenda.
- Update the location.
- Update the reminder.
- Update the recurrence, frequency, start date, and end date.

## Respond to meeting action in Microsoft 365 Calendar

The **Respond to meeting** action in the Microsoft 365 Calendar package enables you to respond to a meeting as accepted, rejected, or tentative.

### Settings

You can also add a message to the response.

Use this within a **Loop** to repeat this operation for each meeting in the calendar. See [Loop package](#) on page 2784.

## Using Microsoft 365 Calendar actions in a loop

You must use certain Microsoft 365 Calendar actions within a **Loop** action.

This action uses two Datetime variables to set the meeting start and end. Define the values before you start. For more information, see [Your variables \(user-defined\)](#) on page 2331.

To use a Microsoft 365 Calendar action within a loop, follow these steps:

1. Double-click or drag the **Loop** action from the **Loop** package in the **Actions** palette.
2. Select the **For each meeting in calendar** iterator.
3. Enter the session name that you used in the **Connect** action.
4. Enter the calendar name.  
This field is case-sensitive.  
The Calendar appears and is the default Microsoft Office setting.
5. Select whether to loop through **All meetings in the calendar** or only meetings with the specific title.
6. Specify the meeting start date and time.  
Select a DateTime variable from the drop-down list.
7. Specify the meeting end date and time.  
Select a DateTime variable with a value that is the same or after the start time.
8. Optional: Enter the location.
9. Optional: Enter the duration in minutes.
10. Optional: Mark the **All day meeting** option.  
For an all day meeting, ensure that there is a one-day difference between the start and end dates.
11. Optional: Enter the meeting owner's email address.
12. Select or create a record variable to hold the output.

## Microsoft 365 Excel package

The Microsoft 365 Excel package contains actions that enable you to automate tasks in the online version of Microsoft Excel.

### Choosing the Excel package in Automation 360

---

**Important:** Microsoft has deprecated EWS API for Exchange Online and has recommended users to move to Graph API. Starting from Automation 360 v.29, Office 365 Excel package is now called Microsoft 365 Excel package. Although the package name has changed, the functionality remains the same. So your existing bots from previous releases will continue to work as expected after an update to Automation 360 v.29.

---

Automation 360 includes packages to support three types of Microsoft Excel usage. For optimal results, use the package that corresponds to the type of Excel that is available on the device you are running bots on.

- No Excel installed: If you do not have Microsoft Excel installed on the device on which you are running bots to automate Excel-related processes, use the Excel basic package.
- Desktop Excel installed: If you have a desktop version of Microsoft Excel installed on your computer, use the Excel advanced package in your bots.
- Online Microsoft 365 Excel only: If you are using Microsoft Excel 365 on a web browser, use the Microsoft 365 Excel package for automating tasks related to Excel.

### Before you start

1. Use the **Connect** action to establish a connection to the Microsoft 365 server.  
See [Using Connect action in Microsoft 365 Excel package](#) on page 2823.
- 

**Note:** Microsoft 365 packages do not currently support multi-factor authentication (MFA) or single sign-on (SSO).

---

2. Use the **Open** action to select a workbook, or the **Create** action to create a new workbook. See [Workbook operations in Microsoft 365 Excel](#) on page 2836.
  3. Optional: If the workbook contains more than one worksheet, use the **Activate sheet** action to specify which worksheet to use.
  4. Use a combination of actions available in this package to automate tasks.
- 

**Note:** To use actions from other Microsoft 365 packages, establish a connection using the **Connect** action from that package.

---

5. Use the **Close** action to exit from the workbook.
6. Use the **Disconnect** action to terminate the connection.

## Actions in the Microsoft 365 Excel package

The actions in the Microsoft 365 Excel package enable you to perform the following operations:

Operations	Description
Connect	Establishes a connection with the Microsoft 365 server using your organization's client ID and tenant ID, and user credentials.  See <a href="#">Using Connect action in Microsoft 365 Excel package</a> on page 2823.
Cell	Perform operations related to cell and range operations, such as append, delete, format, get properties, and insert.  See <a href="#">Cell operations in Microsoft 365 Excel</a> on page 2825
Row and column	Perform operations related to column and row operations such as autofit, delete, and read.  See <a href="#">Column/Row operations in Microsoft 365 Excel</a> on page 2831.
Table	Perform operations related to the table operations such as create, delete, filter, get properties, rename, and sort. See <a href="#">Table operations in Microsoft 365 Excel</a> on page 2834.
Workbook	Automate opening, closing, and creating a workbook.  See <a href="#">Workbook operations in Microsoft 365 Excel</a> on page 2836.
Worksheet	Perform operations related to worksheet operations, such as activate, delete, find, get worksheet names, hide, retrieve worksheet count, and show.  See <a href="#">Worksheet operations in Microsoft 365 Excel</a> on page 2838.

Related reference

[Microsoft 365 Excel package updates](#) on page 913

Review the updates in released versions of the Microsoft 365 Excel package such as new and enhanced features as well as fixes and limitations. The page also lists the release dates of each version, and the compatible Control Room and Bot Agent versions.

## Using Connect action in Microsoft 365 Excel package

Use the **Connect** action in the Microsoft 365 Excel package to establish a connection with the Microsoft 365 server using your organization's (client ID and tenant ID) and user credentials.

All the fields in the **Connect** action accepts a credential from the Credential Vault or a user-input value.

---

**Note:** Note the following conditions for the **Connect** action:

- Does not currently support MFA or SSO.
- Ensure that the administrator consent for the permissions is granted.

- 
1. Log in to the [Azure portal](#) using your Microsoft 365 credentials.
  2. Register your application with the Microsoft identity platform to obtain the client ID and tenant ID. See [Register your app](#).
  3. Grant the required permissions for Microsoft Graph to the application.  
See [Permissions for application](#) on page 2816.

---

**Note:** For your app registration on Azure portal, navigate to **Authentication > Advanced Settings > Allow public client flows** and ensure that you select **Yes**.

- 
4. To add a client secret, you must first subscribe to Azure. See [Subscribe to Azure](#).
  5. Add a client secret. See [Add a client secret](#).

For an example on how to setup and connect to the Microsoft 365 OneDrive package, see [Setup Azure App to connect using Microsoft OneDrive package \(A-People login required\)](#).

1. In the Actions palette, double-click or drag the **Connect** action.
2. In the **Microsoft 365 user session** field, enter a session name.  
(Optional) Click the **Insert a value** icon to select an existing variable.

---

**Note:** Enter this session name in subsequent actions in this package.

- 
3. Click the **OAuth2 Authentication Mode** to select one of the options:
    - **Control Room managed**  
Use the following fields to update the information:
      - **Connection:** click the **Pick** button to select an existing connection.
        - Click the **Provider type** drop-down menu to select an available or custom provider.  
For information in creating a custom provider, see [Configure OAuth2 parameters in the Control Room](#) on page 2865.
      - Click the **Connection name** to select the corresponding connection for the selected provider.

- Use the **Token type** field to select one of the following options:

- **Shared**: for a global token.

An access token of shared type is created when a connection is established to the Control Room. This access token is stored as a credential. When you run your automation, the access token is referenced in the automation using the enterprise application provider type set up in the Control Room.

- **User-specific**: for a token that is specific to a user.

If you select this option, ensure that you log in to your Microsoft 365 account to authenticate and generate a user-specific token. Perform the following steps to use this option:

- a) Log in to Control Room and navigate to **My settings > OAuth connections** in your profile.
- b) Under the **OAuth connections** tab, click **Login to authenticate**.
- c) Sign in to your Microsoft 365 account and select **Continue**.
- d) Verify the services you have access to and click **Continue**.

If the connection is succeeded, it will display the status as **Active** under the **OAuth connections > Connections** table.

- Click one of the following tabs in the **Username** field:
  - **Credential**: click the **Pick** button to select a value in the Credential Vault that contains information about the username.
  - **Variable**: to use a user-defined variable that contains information about the username.
  - **Insecure string**: to enter a value.

- **ROPC**

Use the following fields to enter the information that is provided for your account on your [Azure portal](#)

- **Client ID**: enter the Microsoft 365 client ID or insert it from the Credential Vault.
- **Tenant ID**: enter the unique ID for your Microsoft 365 subscription or insert it from the Credential Vault.
- **Username**: enter the username that you want to use for accessing Microsoft 365 Excel.
- **Password**: specify the Microsoft 365 password:
- **Client secret**: enter your access token or insert it from the Credential Vault.

For all the above fields, you can use one of the following tabs to insert a value:

- **Credential**: to use a value in the Credential Vault that contains information about the Client ID/Client secret/ username/ password..
- **Variable**: to use a user-defined variable that contains information about the Client ID/ Client secret/ username/ password.
- **Insecure string**: to enter a value.

4. Click **Save**.



## Cell operations in Microsoft 365 Excel

The Microsoft 365 Excel package contains actions that you can use to automate tasks related to cell and range operations, such as append, delete, format, get properties, and insert.

The Microsoft 365 Excel package includes the following actions:

Action	Description
Delete cell	See <a href="#">Delete cell action in Microsoft 365 Excel</a> on page 2825.
Delete range	See <a href="#">Delete range action in Microsoft 365 Excel</a> on page 2826.
Format cell	See <a href="#">Using the Format cell action</a> on page 2826.
Get cell	See <a href="#">Get cell action in Microsoft 365 Excel</a> on page 2827.
Get cell/text color	See <a href="#">Using the Get cell/text color action</a> on page 2827.
Get multiple cells	See <a href="#">Get multiple cells action in Microsoft 365 Excel</a> on page 2828.
Go to cell	See <a href="#">Go to cell action in Microsoft 365 Excel</a> on page 2828.
Insert cell	See <a href="#">Insert cell action in Microsoft 365 Excel</a> on page 2829.
Insert range	See <a href="#">Insert range action in Microsoft 365 Excel</a> on page 2829.
Paste cell	See <a href="#">Paste cell action in Microsoft 365 Excel</a> on page 2829.
Read cell format	See <a href="#">Read cell format action in Microsoft 365 Excel</a> on page 2829.
Read cell formula	See <a href="#">Read cell formula action in Microsoft 365 Excel</a> on page 2830.
Set cell	See <a href="#">Set cell action in Microsoft 365 Excel</a> on page 2830.
Set cell color	See <a href="#">Set cell color action in Microsoft 365 Excel</a> on page 2830.
Set cell formula	See <a href="#">Set cell formula action in Microsoft 365 Excel</a> on page 2831.

### Delete cell action in Microsoft 365 Excel

The Delete cell action in Microsoft 365 Excel enables you to delete an active cell or a specific cell from the current worksheet.

#### Settings

- Enter the name of the session used to open the workbook with the **Open** action.
- Select either the active cell or a specific cell. If you select **Specific cell**, enter the cell location. For example **A1**.
- From the delete options, select one of the following options:

- **Shift cells left:** Deletes the specified cell and shifts the cell one position to left.
- **Shift cells up:** Deletes the specified cell and shifts the cell one position up.
- **Entire row:** Deletes the entire row that contains the cell that you have specified to delete.
- **Entire column:** Deletes the entire column that contains the cell that you have specified to delete.

## Delete range action in Microsoft 365 Excel

The Delete range action in Microsoft 365 Excel enables you to delete a specific range of cells.

### Settings

- Enter the name of the session used to open the workbook with the **Open** action.
- Enter the cell range. For example **A1 : B4**. This deletes an area consisting of the first four rows by the first two columns.
- Specify whether to shift the cells up or left.
  - **Shift cells up:** Deletes the specified cells and shifts the cells up by the number of rows deleted.
  - **Shift cells left:** Deletes the specified cells and shifts the cells left by the number of columns deleted.

## Using the Format cell action

Use the **Format cell** action to set the format of a cell or group of cells.

To format a cell or group of cells, do the following:

1. Double-click or drag the **Format cell** action.
2. Enter the name of the session used to open the workbook with the **Open** .
3. Select the **Active cell**, **Specific cell**, or **Multiple cells** option and provide cell location or cell range, as necessary.
4. Mark the **Font** option to modify any of the following:
  - Font name
  - Font size (between 8 and 72)
  - Bold or italicize
  - Underline
  - Font color (accepts color name or hex value). For a list of color names and corresponding hex values, see [Frequently used cell colors](#) on page 2827.
5. Mark the **Alignment** option, then use the drop-down lists to modify the vertical or horizontal alignment.
6. Mark the **wrap text** option to expand the cell(s) vertically to show long strings of text.
7. Mark the **Merge Type** option to select the any of the following operations:
  - Merge and center
  - Merge across
  - Merge cells
  - Unmerge

**8. Click Save.**

## Frequently used cell colors

Review the color names and their corresponding hex values you can use to set a cell color for a cell or text within a cell in a worksheet. These are the most frequently used options for formatting worksheets.

Name	Hex
Aqua	#00FFFF
Black	#000000
Blue	#0000FF
Gray	#808080
Green	#008000
Fuchsia	#FF00FF
Lime	#00FF00
Maroon	#800000
Navy	#000080
Olive	#808000
Purple	#800080
Red	#FF0000
Silver	#C0C0C0
Teal	#008080
White	#FFFFFF
Yellow	#FFFF00

**Get cell action in Microsoft 365 Excel**

Use the Get cell action in Microsoft 365 Excel to retrieve the value of a cell.

**Settings**

- Enter the name of the session used to open the workbook with the **Open** action.
- Select either an **Active cell** or **Specific cell**. If you select a specific cell, enter the cell location.
- Assign the output to a String variable. To perform mathematical operations, convert the string to a number using the **String > To number**. See [To number action](#) on page 3102.

**Using the Get cell/text color action**

Use the **Get cell/text color** action to get the color of the background or text in a cell. This action retrieves the color of a cell as RGB values. For example, if the background or text in a cell is of red color, the value retrieved is 255,0,0.

To get the color of the background or text in a cell, do the following:

1. Double-click or drag the **Get cell/text color** action.
2. Enter the name of the session used to open the workbook with the **Open** .
3. Select the **Active cell** option to get the color from the current active cell or the **Specific cell** option to get the color from the address of the cell you have specified.
4. Select the **Cell color** option to get the background color of the cell, the **Text color** option to get the color of the text, or both.
5. Specify whether to retrieve the cell color by name or as an RGB value.
6. Select a variable from the **Assign the output to variable** list to assign the cell/text color to a List variable.
7. Click **Save**.

If both cell and text colors are retrieved, the List variable contains the cell color at index 0 and text color at index 1.

## Get multiple cells action in Microsoft 365 Excel

Use the Get multiple cells action in Microsoft 365 Excel to retrieve the values of multiple cells within a worksheet and assign the output to a variable.

### Settings

- Enter the name of the session used to open the workbook with the **Open** action.
- Select either the **Multiple cells** or **All cells** option. If you select **Multiple cells**, enter the cell range. For example, if you enter **A1 : D1**, values of the first four cells in the top row are retrieved.
- Assign the output to a String variable. To convert the string to a number, use the **String > To number** action. See [To number action](#) on page 3102.

## Go to cell action in Microsoft 365 Excel

Use the Go to cell action in Microsoft 365 Excel to move the cursor to a specific cell in the worksheet.

### Settings

- Enter the name of the session used to open the workbook with the **Open** action.
- Select from the following cell options:
  - **Specific cell**: Moves to the specified cell address.
  - **One cell to the left**: Moves one cell left.
  - **One cell to the right**: Moves one cell right.
  - **One cell above**: Moves one cell up.
  - **One cell below**: Moves one cell down.
  - **Beginning of the row**: Moves to the first cell in the same row.
  - **End of the row**: Moves to the last cell that contains data in the same row.
  - **Beginning of the column**: Moves to the first cell in the same column.
  - **End of the column**: Moves to the last cell that contains data in the same column.

## Insert cell action in Microsoft 365 Excel

Use the Insert cell action in Microsoft 365 Excel to insert a value to an active cell or a specific cell in the current worksheet without overwriting the existing value.

### Settings

- Enter the name of the session used to open the workbook with the **Open** action.
- Select either **Active cell** or **Specific cell**. If you select **Specific cell**, enter the cell location, for example **A1**.
- After inserting the cell, you can perform these operations:
  - **Shift cell > Down**: Shifts the existing values down by the specified number of rows.
  - **Shift cell > Right**: Shifts the existing values right by the specified number of columns.

## Insert range action in Microsoft 365 Excel

Use the Insert range action in Microsoft 365 Excel to insert a range in the current worksheet without overwriting the existing value.

### Settings

- Enter the name of the session used to open the workbook with the **Open** action.
- Enter the cell range, for example **A1 :B4**. This inserts a range of cells consisting of the first four rows by the first two columns.
- After inserting the cell, you can perform these operations:
  - **Shift cell > Down**: Shifts the existing values down by the specified number of rows.
  - **Shift cell > Right**: Shifts the existing values right by the specified number of columns.

## Paste cell action in Microsoft 365 Excel

Use the Paste cell action in Microsoft 365 Excel to copy a value from a cell and paste it to a specified cell. If there is a value in the destination cell, this action will overwrite the value.

### Settings

- Enter the name of the session used to open the workbook with the **Open** action.
- Select either the **Active cell** or **Specific cell** option to specify the cell from which to copy the value. If you have selected the **Specific cell** option, specify the address of the cell in the **Cell name** field.
- Enter the destination cell address to paste the value. For example, **B3**.

## Read cell format action in Microsoft 365 Excel

Use the Read cell format action to retrieve the format of an active or a specified cell (such as vertical or horizontal alignment and wrap text) and assign the output to a string variable.

## Settings

- Enter the name of the session used to open the workbook with the **Open** action.
- Select the **Active cell** or **Specific cell** option to specify the cell from which to read the format. If you have selected the **Specific cell** option, specify the address of the cell in the **Cell name** field.
- Select a String variable to store the cell format from the **Assign the output to variable** list.

## Read cell formula action in Microsoft 365 Excel

Use the Read cell formula action to retrieve a formula from an active or a specific cell and assign the output to a string variable. This action returns a blank value if the specified cell does not contain a formula.

## Settings

- Enter the name of the session used to open the workbook with the **Open** .
- Select the **Active cell** or **Specific cell** option to specify the cell from which to read the formula. If you have selected the **Specific** option, specify the address of the cell in the field.
- Select a string variable to store the name of the formula from the **Assign the output to variable** list. The shows a descriptive default variable name. If you create several output variables, subsequent variable names are appended with a -1, -2, -3, and so on to avoid duplication.

## Set cell action in Microsoft 365 Excel

Use the Set cell action to set a value in an active or a specific cell of an Excel spreadsheet or a CSV file. You can also use this action to set a formula.

## Settings

- Enter the name of the session used to open the workbook with the **Open** .
- Select the **Active cell** or **Specific cell** option to specify the cell in which to set the value. If you have selected the **Specific cell** option, specify the address of the cell in the field.

---

**Note:** You can enter a cell range in the **Specific cell** field to set a particular value in all the cells of the range. For example, to set a value of 5 on all cells in the second row and from the first through third column, enter **A2 : C2**.

---

- Enter the value to set in the **Cell value** field.

## Set cell color action in Microsoft 365 Excel

Use the Set cell color action to set a color to the background or text of an active cell or a Specific cell in a worksheet.

## Settings

- Enter the name of the session used to open the workbook with the **Open** action.

- Select the **Active cell**, **Specific cell**, or **Cell range** option to specify the cell in which to set the color. If you have selected the **Specific cell** option, specify the address of the cell in the **Cell name** field.
- Select the item to which you want to apply the color: **Cell** or **Text within cell**.
- Enter a cell color by name or code.

Use either the color name or the hex value. For a list of color names and corresponding hex values, see [Frequently used cell colors](#) on page 2827.

## Set cell formula action in Microsoft 365 Excel

The set cell formula action enables you to set the formula of a specified cell in a worksheet.

### Settings

- Enter the name of the session used to open the workbook with the **Open** action.
- Select the **Active cell**, **Specific cell**, or **Multiple cell** option to specify the cell in which to set the formula. If you have selected the **Specific cell** option, specify the address of the cell in the **Cell name** field. For the multiple cell option, specify a cell range.
- Enter the value to set in the **Cell formula** field, without an "=".

## Column/Row operations in Microsoft 365 Excel

The Microsoft 365 Excel package contains actions that you can use to automate tasks related to column and row operations such as autofit, delete, insert, and read.

The Microsoft 365 Excel package includes the following actions:

Actions	Description
Autofit columns	See <a href="#">Autofit columns action in Microsoft 365 Excel</a> on page 2832.
Autofit rows	See <a href="#">Autofit rows action in Microsoft 365 Excel</a> on page 2832.
Delete row/column	See <a href="#">Using Delete row or column action</a> on page 2832.
Get row count	See <a href="#">Get row count action in Microsoft 365 Excel</a> on page 2833.
Insert row/column	See <a href="#">Using Insert row or column action</a> on page 2833.
Read column	See <a href="#">Read column action in Microsoft 365 Excel</a> on page 2833.
Read row	See <a href="#">Read row action in Microsoft 365 Excel</a> on page 2834.

## Autofit columns action in Microsoft 365 Excel

Use the Autofit columns action in the Microsoft 365 Excel package to adjust (automatically fit) the width of columns in a worksheet in a specified session.

### Settings

Enter the name of the session used to open the workbook with the **Open** .

## Autofit rows action in Microsoft 365 Excel

Use the Autofit rows action in the Microsoft 365 Excel package to adjust (automatically fit) the height of the rows in a worksheet in a specified session.

### Settings

Enter the name of the session used to open the workbook with the **Open** .

## Using Delete row or column action

Use the **Delete row or column** action to remove rows or columns from the current worksheet.

To delete rows or columns in a worksheet, do the following:

1. Double-click or drag **Delete row or column**.
2. Enter the name of the session used to open the workbook with the **Open** .
3. Select one of the following:
  - **Row Operations**
    - a) Select the **Delete Row at** option to delete all of the cells in a specific row. Specify the row number to delete in the field. For example, to delete the tenth row in the worksheet, enter 10 in the field.
    - b) Select the **Delete Row by** option to delete all of the cells in either:
      - the row of the active cell.
      - a specific range of cells. Specify the range to delete. For example, to delete the first five rows, enter 1 : 5 in the field.
  - **Column Operations**
    - a) Select the **Delete Column at** option to delete all of the cells in a specific column. Specify the address of the column to delete in the field. For example, to delete column 'D' in the worksheet, enter D in the field.
    - b) Select the **Delete Columns by** option to delete all of the cells in either:
      - the column of the active cell.
      - a specific range of cells. Specify the range to delete. For example, to delete the first five columns, enter A : E in the field.
4. Click **Save**.



## Get row count action in Microsoft 365 Excel

Use the Get row count action in the Microsoft 365 Excel package to retrieve the number of rows that contain data in a worksheet.

### Settings

- Enter the name of the session used to open the workbook with the **Open** action.
- Assign the output value to a Number variable.

To convert the variable to a String variable, use the **Number > To string** action. For more information, see [To string action in Number](#) on page 2804.

## Using Insert row or column action

Use the **Insert row or column** action in Microsoft 365 Excel package to create rows or columns in the current worksheet.

To insert or delete rows or columns in a worksheet, do the following:

1. From the Microsoft 365 Excel package, double-click or drag **Insert row or column** action.
2. Enter the name of the session used to open the workbook with the **Open** .
3. Select one of the following:
  - **Row operations**
    - a) Select the **Insert Row(s) at** option to insert a row and specify the location where to insert the row in the field. For example, to insert a row of cells in the tenth row in the worksheet, enter 10 in the field.
    - b) Select the **Insert Row(s) by** option to insert all of the cells in either:
      - the row of the active cell.
      - a specific range of cells. Specify the range where to insert the row. For example, to insert a row of cells in the first five rows in the worksheet, enter 1 : 5 in the field.
  - **Column operations**
    - a) Select the **Insert Column(s) at** option to insert a column and specify the location where to insert the row in the field. For example, to insert a column of cells in column 'D' in the worksheet, enter D in the field.
    - b) Select the **Insert Columns(s) by** option to insert all of the cells in either:
      - the column of the active cell.
      - a specific range of cells. Specify the range to insert the column. For example, to insert a row of cells in the first five columns, enter A : E in the field.
4. Click **Save**.

## Read column action in Microsoft 365 Excel

Use the Read column action in the Microsoft 365 Excel package to extract data from a column and store it in a List variable.

## Settings

- Enter the name of the session used to open the workbook with the **Open** action.
- Select the cell option as **Active cell** or **Specific cell** to specify the starting point.
- You can also select the **Read full column** option to extract data for the entire column.
- Assign the output value to a List variable.

## Read row action in Microsoft 365 Excel

Use the Read row action in the Microsoft 365 Excel package to extract data from a row and store it in a variable.

## Settings

- Enter the name of the session used to open the workbook with the **Open** action.
- Select the cell option as **Active cell** or **Specific cell** to specify the starting point.
- You can also select the **Read full row** option to extract data for the entire row.
- Assign the output to a variable: Multiple variables or a Record variable.

## Table operations in Microsoft 365 Excel

The Microsoft 365 Excel package contains various actions that you can use to automate tasks related to the table operations such as create, delete, filter, get properties, rename, and sort.

The Microsoft 365 Excel package includes the following actions:

Actions	Description
Create table	See <a href="#">Create table action in Microsoft 365 Excel</a> on page 2834.
Delete table	See <a href="#">Delete table action in Microsoft 365 Excel</a> on page 2835.
Get table column	See <a href="#">Get table column action in Microsoft 365 Excel</a> on page 2835.
Get table names	See <a href="#">Get table names action in Microsoft 365 Excel</a> on page 2835.
Get table row	See <a href="#">Get table row action in Microsoft 365 Excel</a> on page 2835.
Get table row count	See <a href="#">Get table row count action in Microsoft 365 Excel</a> on page 2836.
Rename table	See <a href="#">Rename table action in Microsoft 365 Excel</a> on page 2836.

## Create table action in Microsoft 365 Excel

The Create table action in the Microsoft 365 Excel package enables you to create a new table in the specified table range.

## Settings

- Enter the name of the session used to open the workbook with the **Open** action.
- Enter the table name.
- Enter the cell range in which to create the table. For example, A1:D4.
- Optional: Select the **Table has headers** option to establish the first row as the header row.

## Delete table action in Microsoft 365 Excel

The Delete table action in the Microsoft 365 Excel package enables you to delete a table in the active worksheet.

## Settings

- Enter the name of the session used to open the workbook with the **Open** action.
- Enter the table name that has to be deleted.

## Get table column action in Microsoft 365 Excel

Use the Get table column action in the Microsoft 365 Excel package to retrieve the column values of a specified table and column index, and assign the values to a List variable.

## Settings

- Enter the name of the session used to open the workbook with the **Open** action.
- Enter the table name.
- Enter the column index. For example, enter 5 to indicate the fifth column from the left.
- Select a List variable to store the values.

## Get table names action in Microsoft 365 Excel

The Get table names action in Microsoft 365 Excel enables you to retrieve the names of all the tables in a workbook and assign them to a List variable.

## Settings

- Enter the name of the session used to open the workbook with the **Open** action.
- Optional: Select whether to specify a sheet either by index or name.
- Select a List variable to store the values.

## Get table row action in Microsoft 365 Excel

The Get table row action in Microsoft 365 Excel enables you to retrieve the row values of a specified table and row index, and assign the values to a variable.

## Settings

- Enter the name of the session used to open the workbook with the **Open** action.
- Enter the table name.
- Enter the row index. For example, enter 5 to indicate the fifth row from the top.
- Assign the output to a variable: Multiple variables or a Record variable.

## Get table row count action in Microsoft 365 Excel

The Get table row count action in Microsoft 365 Excel enables you to retrieve the row count of a specified table and assign the values to a number variable.

## Settings

- Enter the name of the session used to open the workbook with the **Open** action.
- Enter the table name.
- Select a Number type variable to store the values.

To convert the variable to a String variable, use the **Number > To string** action. For more information, see [To string action in Number](#) on page 2804 .

## Rename table action in Microsoft 365 Excel

The Rename table action in Microsoft 365 Excel enables you to rename a table.

## Settings

- Enter the name of the session used to open the workbook with the **Open** action.
- Enter the current or existing table name.
- Enter a new table name.

## Workbook operations in Microsoft 365 Excel

The Microsoft 365 Excel package contains actions that enable you to automate opening, closing, or creating a new workbook.

The Microsoft 365 Excel package includes the following actions:

Actions	Description
Close	See <a href="#">Close action</a> .
Create workbook	See <a href="#">Create workbook action</a> .
Open	See <a href="#">Using the Open action</a> on page 2837.

## Close action in Microsoft 365 Excel

Use the Close action in Microsoft 365 Excel package to close a workbook.

## Settings

Enter the name of the session used to open the workbook with the **Open** .

## Create workbook action in Microsoft 365 Excel

Use the Create workbook action in Microsoft 365 Excel package when you want to create a new workbook.

## Settings

- Enter Enter the name of the session used to open the workbook with the **Open** .
- Provide a **File Path** containing the new workbook name with one of the following extensions: .xls, .xlsm, .xlsx.

Either enter the file path or select a String variable. For example, to perform this action on a file named SalesReport.xlsx, located in the Accounts folder, enter `Accounts/SalesReport.xlsx`.

## Using the Open action

Use the **Open** action to open a specific workbook from a Microsoft 365 Excel file. Ensure that you insert this action at the start of your automation sequence.

1. Double-click or drag the **Open** action.
2. Enter the user session name in the **Microsoft 365 user session** field.  
Provide the username entering an unencrypted value or click the **Insert value** icon and select an existing variable.
3. Enter the session name in the **Microsoft 365 Excel session** field.  
Use this same session name in subsequent actions to associate them with this workbook.
4. Use the **File Path** to select one of the following options:
  - **File name including Path**  
Use this option if you know the name of the Microsoft 365 Excel file and the filepath. For example, to perform this action on a file named `SalesReport.xlsx`, located in the Accounts folder of your OneDrive, enter `Documents/OneDrive/Accounts/SalesReport.xlsx`.

---

**Note:** Ensure that the Microsoft Excel file is placed in the **My Files** folder in OneDrive.

---

  - **Select existing file variable**  
Use this option if you want to select an existing variable from the drop-down menu. Optionally, click the **Create variable** icon if there is no variable available.
5. Optional: If you want to open a specific worksheet, select the **Specific sheet name** check box and enter the name of the worksheet.  
If you have stored the name of the worksheet as a variable, click the **Insert a value** icon to select the variable.
6. Optional: Select the **Sheet contains header** check box if the sheet contains a header row.
7. Click **Save**.

## Worksheet operations in Microsoft 365 Excel

The Microsoft 365 Excel package contains actions that you can use to automate tasks related to worksheet operations, such as delete, find, get worksheet names, hide, retrieve worksheet count, and show.

The Microsoft 365 Excel package includes the following actions:

Actions	Description
Copy worksheet	See <a href="#">Using the Copy worksheet action</a> on page 2838.
Create sheet	See <a href="#">Create sheet action in Microsoft 365 Excel</a> on page 2839.
Delete worksheet	See <a href="#">Delete worksheet action in Microsoft 365 Excel</a> on page 2839.
Get current worksheet name	See <a href="#">Get current worksheet name action in Microsoft 365 Excel</a> on page 2839.
Get worksheet names	See <a href="#">Get worksheet names action in Microsoft 365 Excel</a> on page 2840.
Hide worksheet	See <a href="#">Hide worksheet action in Microsoft 365 Excel</a> on page 2840.
Rename worksheet	See <a href="#">Rename worksheet action in Microsoft 365 Excel</a> on page 2840.
Retrieve sheet count	See <a href="#">Retrieve sheet count action in Microsoft 365 Excel</a> on page 2840.
Show worksheet	See <a href="#">Show worksheet action in Microsoft 365 Excel</a> on page 2841.
Switch to sheet	See <a href="#">Switch to sheet action in Microsoft 365 Excel</a> on page 2841.

### Using the Copy worksheet action

Use the **Copy worksheet** action to copy values of a worksheet from one worksheet to another. This action overwrites any existing values. To move values from one worksheet to another without overwriting existing values, use the **Append worksheet** action.

Open the workbook(s) containing the source and target worksheets. See [Using the Open action](#) on page 2837.

---

**Note:** This action identifies the destination and source workbooks by the session names used to open them. If opening two workbooks, enter a session name for the source workbook that is different than the one used to open the destination workbook.

---

To copy the values of a worksheet into another, do the following:

1. Double-click or drag the **Copy worksheet** action.
2. Enter the name of the session that you used to open the destination workbook in the **Open** action.

3. If the workbook contains more than one worksheet, mark the **Specific Sheet** option, then enter the index number or name of the source worksheet.
  - The index number represents the position of the worksheet in the workbook. For example, to perform an operation on the worksheet at the third position in the workbook, enter 3 in the field.
  - The sheet name field is case insensitive.
4. Enter the name of the session that you used to open the source workbook in the **Open** action.
5. If the workbook contains more than one worksheet, mark the **Specific Sheet** option, then enter the index number or name of the destination worksheet.
6. Click **Save**.

### Create sheet action in Microsoft 365 Excel

The **Create sheet** action in the Microsoft 365 Excel package enables you to add an empty sheet in the current workbook.

#### Settings

- Enter the name of the session used to open the workbook with the **Open** action.
- Enter a **Worksheet name** of up to 31 characters. The name cannot contain the following characters: \ / ? \* [ ]

### Delete worksheet action in Microsoft 365 Excel

The **Delete worksheet** action in the Microsoft 365 Excel package enables you to delete a spreadsheet from the current workbook.

#### Settings

- Enter the name of the session used to open the workbook with the **Open** .
- Specify either an index number in the **Sheet by Index** field or a name in the **Sheet by Name** field for the worksheet. The index number is the number assigned to a worksheet. For example, if you want to perform an operation on the worksheet at the third position in the workbook, enter 3 in the field.

---

**Note:** You can delete a worksheet only if the workbook contains more than one worksheet.

---

### Get current worksheet name action in Microsoft 365 Excel

The **Get current worksheet name** action in the Microsoft 365 Excel package enables you to retrieve the name of the currently active worksheet.

#### Settings

- Enter the name of the session used to open the workbook with the **Open** .

- Select a string variable that you want to use to store the name of the worksheet from the **Assign the output to variable** list. The shows a descriptive default variable name. If you create several output variables, subsequent variable names are appended with a -1, -2, -3, and so on to avoid duplication.

## Get worksheet names action in Microsoft 365 Excel

The **Get worksheet names** action in the Microsoft 365 Excel package enables you to retrieve the names of all the worksheets in the workbook.

### Settings

- Enter the name of the session used to open the workbook with the **Open** action.
- Select a list variable to store the worksheet names from the **Assign the output to variable** list.

## Hide worksheet action in Microsoft 365 Excel

The **Hide worksheet** action in the Microsoft 365 Excel package enables you to hide a worksheet from the current workbook.

### Settings

- Specify the name of the worksheet to hide in the **Enter worksheet name to hide** field.

---

**Note:** You can hide a worksheet only if the workbook contains more than one worksheet.

---

- Enter the name of the session used to open the workbook with the **Open** .

## Rename worksheet action in Microsoft 365 Excel

The **Rename worksheet** action in the Microsoft 365 Excel package enables you to rename a worksheet in the current workbook.

### Settings

- Specify the index number or name of the worksheet to rename in the **Sheet by Index** or **Sheet by Name** field.

The index number is the number assigned to a worksheet. For example, if you want to perform an operation on the worksheet at the third position in the workbook, enter 3 in the field.

---

**Note:** You cannot rename the worksheet if a worksheet with the same name already exists in the workbook.

---

- Enter the new worksheet name that is under 31 characters.
- Enter the name of the session used to open the workbook with the **Open** .

## Retrieve sheet count action in Microsoft 365 Excel

The **Retrieve sheet count** action in the Microsoft 365 Excel package enables you to get the number of sheets available in the current workbook and stores it in a number variable.



## Settings

- Select the appropriate option to specify whether to include the hidden worksheet or not and assign the count to a variable.
- Enter the name of the session used to open the workbook with the **Open** .
- Select a number variable that you want to use to store the name of the worksheet from the **Select the variable to assign to** list. The shows a descriptive default variable name. If you create several output variables, subsequent variable names are appended with a -1, -2, -3, and so on to avoid duplication.

## Show worksheet action in Microsoft 365 Excel

The **Show worksheet** action in the Microsoft 365 Excel package enables you to show the hidden worksheet.

## Settings

- Enter the name of the session used to open the workbook with the **Open** action.
- Enter the **Worksheet name**.

## Switch to sheet action in Microsoft 365 Excel

The **Switch to sheet** action in the Microsoft 365 Excel package enables you to activate a particular sheet in a Microsoft Excel file.

## Settings

- Enter the name of the session used to open the workbook with the **Open** action.
- Specify whether to activate the **Sheet by Index** (numerical value) or **Sheet by Name**.

## Microsoft 365 OneDrive package

The Microsoft 365 OneDrive package contains actions that enable you to automate many of the repetitive tasks in Microsoft cloud storage.

## How to use the actions in the Microsoft 365 OneDrive package

---

**Note:** Microsoft has deprecated EWS API for Exchange Online and has recommended users to move to Graph API. Starting from Automation 360 v.29, Office 365 OneDrive package is called Microsoft 365 OneDrive package. Although the package name has changed, the functionality remains the same. So your existing bots from previous releases will continue to work as expected after an update to Automation 360 v.29.

---

Perform the following actions within the **One Drive** package as part of using the set of available actions:

1. Use the **Connect** action to establish a connection to the Microsoft 365 server.

See [Using Connect action in Microsoft 365 OneDrive package](#) on page 2844.

---

**Note:** Microsoft 365 packages do not currently support multi-factor authentication (MFA) or single sign-on (SSO).

---

2. Use a combination of actions available in this package to automate tasks.

---

**Note:** To use actions from other Microsoft 365 packages, establish a connection using the **Connect** action from that package.

---

3. Use the **Disconnect** action to terminate the connection.

For an example on how to setup and connect to the Microsoft 365 OneDrive package, see [Setup Azure App to connect using Microsoft OneDrive package \(A-People login required\)](#).

## Actions in the Microsoft 365 OneDrive package

Use the actions in the Microsoft 365 OneDrive package to perform an operation on a single file or folder. To perform the operation on every file in a folder, use that action in a loop. See [Using the One Drive actions in a loop](#) on page 2850.

---

**Note:** Automation 360 supports the shared drive. To use shared drive items such as a file or folder, ensure that you provide the link and name of that file or folder.

---

The Microsoft 365 OneDrive package includes the following actions:

Action	Description
Check permission	See <a href="#">Check permission action</a> on page 2843.
Connect	Establishes a connection with the Microsoft 365 server using your organization's client ID and tenant ID, and user credentials.  See <a href="#">Using Connect action in Microsoft 365 OneDrive package</a> on page 2844
Copy file or folder	See <a href="#">Copy file or folder action</a> on page 2846.
Create folder	See <a href="#">Create folder action</a> on page 2846.
Delete file or folder	See <a href="#">Delete file or folder action</a> on page 2846
Disconnect	See <a href="#">Using Disconnect action in Microsoft 365 Calendar package</a> on page 2819.
Download file	See <a href="#">Download file action</a> on page 2847.
Export as PDF	See <a href="#">Export to PDF action</a> on page 2847.
Find files and folders	See <a href="#">Find files and folders action</a> on page 2848.

Action	Description
Get file or folder information	See <a href="#">Get file or folder information action</a> on page 2848.
Move file or folder	See <a href="#">Move file or folder action</a> on page 2849.
Rename file or folder	See <a href="#">Rename file or folder action</a> on page 2849.
Restore last version	See <a href="#">Restore last version action</a> on page 2850.
Upload file	See <a href="#">Upload file action</a> on page 2850.

Related reference

[Microsoft 365 OneDrive package updates](#) on page 915

Review the updates in released versions of the Microsoft 365 OneDrive package such as new and enhanced features as well as fixes and limitations. The page also lists the release dates of each version, and the compatible Control Room and Bot Agent versions.

## Check permission action

The **Check permission** action in the Microsoft 365 OneDrive package checks for read and write permission for a file or folder in your OneDrive.

### Settings

- Enter the Microsoft 365 user session that you provided in the **Connect** action.
- Use the **Check Permission for** field to select one of the following options:
  - **File name on OneDrive (including path & extension)**: to enter the file name on OneDrive for which the permissions must be verified.
  - **Folder name on OneDrive (including path)**: to enter a folder name on OneDrive where the permissions must be verified.

(Optional) For the above options, click the **Insert a value** icon to select an existing variable.

- Select one of the following options in the **Check permission type** field to specify the permission type to verify:
  - **Read**
  - **Read & Write**
- Use the **Assign output status to variable** drop-down to select a predefined Boolean type variable to hold the output during bot runtime.

(Optional) Click the **Create variable** icon on the right for a new variable. The Boolean type variable will provide a true (user has permission) or false (user does not have permission) response.

## Using Connect action in Microsoft 365 OneDrive package

Use the **Connect** action in the Microsoft 365 OneDrive package to establish a connection with the Microsoft 365 server using your organization's (client ID and tenant ID) and user credentials.

All the fields in the **Connect** action accepts a credential from the Credential Vault or a user-input value.

---

**Note:** Note the following conditions for the **Connect** action:

- Does not currently support MFA or SSO.
- Ensure that the administrator consent for the permissions is granted.

- 
1. Log in to the [Azure portal](#) using your Microsoft 365 credentials.
  2. Register your application with the Microsoft identity platform to obtain the client ID and tenant ID. See [Register your app](#).
  3. Grant the required permissions for Microsoft Graph to the application.  
See [Permissions for application](#) on page 2816.

---

**Note:** For your app registration on Azure portal, navigate to **Authentication > Advanced Settings > Allow public client flows** and ensure that you select **Yes**.

- 
4. To add a client secret, you must first subscribe to Azure. See [Subscribe to Azure](#).
  5. Add a client secret. See [Add a client secret](#).

For an example on how to setup and connect to the Microsoft 365 OneDrive package, see [Setup Azure App to connect using Microsoft OneDrive package \(A-People login required\)](#).

1. In the Actions palette, double-click or drag the **Connect** action from the package you want to use.
2. In the **Microsoft 365 OneDrive user session** field, enter a session name.  
(Optional) Click the **Insert a value** icon to select an existing variable.

---

**Note:** Enter this session name in subsequent actions in this package.

- 
3. Click the **OAuth2 Authentication Mode** to select one of the options:
    - **Control Room managed**  
Use the following fields to update the information:
      - **Connection:** click the **Pick** button to select an existing connection.
        - Click the **Provider type** drop-down menu to select an available or custom provider.  
For information in creating a custom provider, see [Configure OAuth2 parameters in the Control Room](#) on page 2865.
        - Click the **Connection name** to select the corresponding connection for the selected provider.
        - Use the **Token type** field to select one of the following options:
          - **Shared:** for a global token.

An access token of shared type is created when a connection is established to the Control Room. This access token is stored as a credential. When you run your automation, the access token is referenced in the automation using the enterprise application provider type set up in the Control Room.

- **User-specific:** for a token that is specific to a user.

If you select this option, ensure that you log in to your Microsoft 365 account to authenticate and generate a user-specific token. Perform the following steps to use this option:

- a) Log in to Control Room and navigate to **My settings > OAuth connections** in your profile.
- b) Under the **OAuth connections** tab, click **Login to authenticate**.
- c) Sign in to your Microsoft 365 account and select **Continue**.
- d) Verify the services you have access to and click **Continue**.

If the connection is succeeded, it will display the status as **Active** under the **OAuth connections > Connections** table.

- Click one of the following tabs in the **Username** field:
  - **Credential:** click the **Pick** button to select a value in the Credential Vault that contains information about the username.
  - **Variable:** to use a user-defined variable that contains information about the username.
  - **Insecure string:** to enter a value.

- **ROPC**

Use the following fields to enter the information that is provided for your account on your [Azure portal](#)

- **Client ID:** enter the Microsoft 365 client ID or insert it from the Credential Vault.
- **Tenant ID:** enter the unique ID for your Microsoft 365 subscription or insert it from the Credential Vault.
- **Username:** enter the username that you want to use for accessing Microsoft 365 OneDrive.
- **Password:** specify the Microsoft 365 password:
- **Client secret:** enter your access token or insert it from the Credential Vault.

For all the above fields, you can use one of the following tabs to insert a value:

- **Credential:** to use a value in the Credential Vault that contains information about the Client ID/Client secret/ username/ password..
- **Variable:** to use a user-defined variable that contains information about the Client ID/ Client secret/ username/ password.
- **Insecure string:** to enter a value.

4. Click **Save**.

## Copy file or folder action

The Copy file or folder action in the Microsoft 365 OneDrive package duplicates a file or folder from one folder to another in your OneDrive.

### Settings

- Enter the user session that you provided in the **Connect** .
- Select whether to copy a file or folder.
- Provide the source and destination file/folder names and paths or file/folder link.

To obtain the file or folder link, copy the link generated from [Share OneDrive files and folders](#)

For example, to perform this action on a file named SalesReport.xlsx, located in the Accounts folder, enter `/Accounts/SalesReport.xlsx`.

---

**Note:** The forward slash that indicates that a file or folder is located in the root directory is optional.

---

- Optional: If there is file or folder with the same name in the destination folder, select the **Override existing file/folder** option which replaces the existing file or folder with the one being copied.

## Create folder action

The Create folder action in the Microsoft 365 OneDrive package creates a new folder in a specific directory in your OneDrive.

### Settings

- Enter the user session that you provided in the **Connect** .
- Enter the parent folder name and path, or folder link.

To obtain the folder link, copy the link generated from [Share OneDrive files and folders](#)

For example, to perform this action on a folder named Q1, located in the Survey Results folder, enter `/Survey Results/Q1`.

- Enter the new folder name.

## Delete file or folder action

The Delete file or folder action in the Microsoft 365 OneDrive package removes a file or folder from a specific directory in your OneDrive.

### Settings

- Enter the user session that you provided in the **Connect** .
- Select whether to delete a file or folder.
- Provide the name and path, or file or folder link.

To obtain the file or folder link, copy the link generated from

For example, to perform this on a file named SalesReport.xlsx, located in the Accounts folder, enter `/Accounts/SalesReport.xlsx`.

---

**Note:** The forward slash that indicates that a file or folder is located in the root directory is optional.

---

## Download file action

The Download file action in the Microsoft 365 OneDrive package downloads a file from a specific directory in your OneDrive.

### Settings

- Enter the user session that you provided in the **Connect** .
- Provide the file name and path, or file link.

To obtain the file link, copy the link generated from [Share OneDrive files and folders](#)

For example, to perform this on a file named SalesReport.xlsx, located in the Accounts folder, enter `/Accounts/SalesReport.xlsx`.

---

**Note:** The forward slash that indicates that a file or folder is located in the root directory is optional.

---

- Enter the destination folder path on the local device.
- Optional: If there is file or folder with the same name in the destination folder, select the **Override existing file/folder** option which replaces the existing file or folder with the one being copied.

## Export to PDF action

The Export to PDF action in the Microsoft 365 OneDrive package exports an existing file in your OneDrive to a PDF on your device. This action supports the following file extensions: doc, docx, oentry, odp, pps, ppt, pptx, tf, xls, and.xlsx.

### Settings

- Enter the user session that you provided in the **Connect** .
- Provide the file name and path, or file link. Either enter the values or insert a predefined string variable.

To obtain the file link, copy the link generated from [Share OneDrive files and folders](#)

For example, to perform this on a file named SalesReport.xlsx, located in the Accounts folder, enter `/Accounts/SalesReport.xlsx`.

---

**Note:** The forward slash that indicates that a file or folder is located in the root directory is optional.

---

- Enter the export folder name and path or select a predefined string variable.
- Optional: If there is file or folder with the same name in the destination folder, select the **Override existing file/folder** option which replaces the existing file or folder with the one being copied.

## Find files and folders action

The Find files and folders action in the Microsoft 365 OneDrive package returns a table of files and folders in a specific directory in your OneDrive.

### Settings

- Enter the user session that you provided in the **Connect** .
- Provide directory details in the **Folder to search** field: enter the folder name and path, or folder link.

To obtain the folder link, copy the link generated from

For example, to perform this on a folder named Q1, located in the Survey Results folder, enter `/Survey Results/Q1`.

- Specify whether to search for **All items in folder** or a **Specific file (or folder)**.

---

**Note:** The **Drive Item Name** field accepts wildcard characters in the file name and extension. For example, to search for all documents with extension docx, enter `*.docx` in the **Specific file (or folder)** field.

---

- Assign the output to a table variable.

The variable will hold the following file or folder details: Name, ID, CreatedBy, CreationDate, LastModifiedBy, LastModificationDate, and ParentFolderPath.

## Get file or folder information action

The Get file or folder information action in the Microsoft 365 OneDrive package retrieves information for a specific file or folder from OneDrive.

### Settings

- Enter the user session that you provided in the **Connect** .
- Provide the file or folder name and path, or file/folder link.

To obtain the file or folder link, copy the link generated from

For example, to perform this on a file named SalesReport.xlsx, located in the Accounts folder, enter `/Accounts/SalesReport.xlsx`.

---

**Note:** The forward slash that indicates that a file or folder is located in the root directory is optional.

---

- Assign the output to a record variable.



The variable will hold the following file or folder details: Name, ID, CreatedBy, CreationDate, LastModifiedBy, LastModificationDate, and ParentFolderPath.

## Move file or folder action

The Move file or folder action in the Microsoft 365 OneDrive package moves a file or folder from one folder to another in OneDrive.

### Settings

- Enter the user session that you provided in the **Connect** .
- Select whether to move a file or folder.
- Provide the source and destination file or folder names and paths, or file/folder links.

To obtain the file or folder link, copy the link generated from

For example, to perform this on a file named SalesReport.xlsx, located in the Accounts folder, enter `/Accounts/SalesReport.xlsx`.

---

**Note:** The forward slash that indicates that a file or folder is located in the root directory is optional.

- Optional: If there is file or folder with the same name in the destination folder, select the **Override existing file/folder** option which replaces the existing file or folder with the one being copied.

## Rename file or folder action

The Rename file or folder action in the Microsoft 365 OneDrive package renames a file or folder in a specific directory in OneDrive.

### Settings

- Enter the user session that you provided in the **Connect** .
- Select whether to rename a file or folder.
- Provide the current and new file or folder names, or file/folder link.
- To obtain the file or folder link, copy the link generated from
- Optional: If there is file or folder with the same name in the destination folder, select the **Override existing file/folder** option which replaces the existing file or folder with the one being copied.

## Restore last version action

The Restore last version action in the Microsoft 365 OneDrive package restores a file to the last version.

### Settings

- Enter the user session that you provided in the **Connect** .
- Provide the file name and path, or file link.

To obtain the file or folder link, copy the link generated from

For example, to perform this on a file named SalesReport.xlsx, located in the Accounts folder, enter `/Accounts/SalesReport.xlsx`.

---

**Note:** The forward slash that indicates that a file or folder is located in the root directory is optional.

---

## Upload file action

The Upload file action in the Microsoft 365 OneDrive package uploads a file to a specific directory in OneDrive.

### Settings

- Enter the user session that you provided in the **Connect** .
- Provide the file name and path on the local directory.

For example, `D:/Mydata/HR/EmployeeSurvey.xlsx`.

- Provide the upload folder name and path, or folder link.

To obtain the folder link, copy the link generated from

For example, to perform this action on a folder named Q1, located in the Survey Results folder in home directory, enter `/Survey Results/Q1`

---

**Note:** You cannot provide the private folder path from one drive as it is not supported.

---

- Optional: If there is file or folder with the same name in the destination folder, select the **Override existing file/folder** option which replaces the existing file or folder with the one being copied.

## Using the One Drive actions in a loop

Use the **Find files and folder** action to return a table of files and their properties inside of a specified folder, the **Loop** action to loop through each row in the table, and a **One Drive** action to perform an operation on every file in the table.

To perform an action on every file in a folder, do the following steps:

1. Double-click or drag **One Drive > Find files and folders**.

2. Provide your username with either a credential variable or an unencrypted value.
3. Enter the file path of the folder in which to perform the search.
4. Select the **All items in folder** option.  
You can alternatively select **Specific file (or folder)** to limit the search to a specific folder on your OneDrive.
5. Select or create a table variable to hold the output.  
The table variable holds information on files and folders in rows, under the following columns: name, id, createdBy, creationDate, lastModifiedBy, lastModificationDateTime, parentFolder, and Path.
6. Double-click or drag the **Loop** action.
7. Select the **For each row in table** iterator.
8. Select the table variable holding the output from step 5.
9. Select or create a record variable to temporarily hold each row.  
Insert the action inside of the **Loop** container that you want to repeat on every file in the folder. This example uses the **Download file** action.
10. Double-click or drag **Outlook > Download file**.
11. Provide your username with either a credential variable or an unencrypted value.
12. Enter the following in the **File name including path** field, replacing the generic variable names with the names of the record variables from step 10:  
`$RecordVariable [7] $/$RecordVariable [0] $`
13. Enter the path to the folder where to download the files.
14. Click **Save**.

## Microsoft 365 Outlook package

The Microsoft 365 Outlook package enables you to automate Outlook emails over Microsoft Outlook server.

### Before you start

Microsoft has deprecated EWS API for Exchange Online and has recommended users to move to Graph API.

See [Upcoming API Deprecations in Exchange Web Services for Exchange Online](#).

The Microsoft 365 Outlook package is based on the Graph API and can be used to automate email-related tasks for sending, receiving, and modifying emails and folders in Microsoft 365 Outlook.

---

**Note:** The integration of Graph API requires an administrator to grant access, after which you can configure an application access policy and limit the scope of application permissions. See [Configure application access policy](#).

---

Use this package in the following sequence:

- Use the **Connect** action to create a session.
- Use the various actions to automate tasks related to Microsoft 365 Outlook emails.

- Use the **Disconnect** action to terminate the connection to the Microsoft Outlook server.

The Microsoft 365 Outlook package supports the email automation of a shared mailbox in Outlook 365. You can automate emails retrieved from a shared mailbox and perform email-related tasks by accessing each folder(s) and its subfolder(s) in the shared mailbox. Ensure the following requirements are met:

- Administrator has enabled your access to shared mailbox.
- The required delegated permissions are granted.
- The shared mailbox is setup in your Microsoft 365 Outlook application.

Review the following table for important proxy considerations while using the Microsoft 365 Outlook package:

Proxy type	Description	Status
Authenticated	Same proxy settings for Control Room URL and Graph API Endpoints	Supported
	Different proxy credentials for Control Room URL and Graph API Endpoints	Not supported
	Bypass authenticated proxy for Control Room URL and authenticated proxy settings for Graph API Endpoints	Not supported
Unauthenticated	Same settings for Control Room URL and Graph API Endpoints	Supported
	Different proxy settings for Control Room URL and Graph API Endpoints	Supported
Combination of Authenticated and Unauthenticated	Authenticated proxy for Control Room URL and unauthenticated proxy settings for Graph API Endpoints	Supported
	Unauthenticated proxy for Control Room URL and authenticated proxy settings for Graph API Endpoints	Not supported
None	No Proxy found on the Bot Runner machine	Supported

### Actions in the Microsoft 365 Outlook package

In the Actions palette on the Bot editor screen, double-click or drag any of the following actions in the Microsoft 365 Outlook package:

Action	Description
Change status	See <a href="#">Change status action in Microsoft 365 Outlook package</a> on page 2854.
Check if folder exists	See <a href="#">Check if folder exists action in Microsoft 365 Outlook package</a> on page 2854.
Connect	See <a href="#">Using Connect action in Microsoft 365 Outlook package</a> on page 2855.
Delete	See <a href="#">Delete action in Microsoft 365 Outlook package</a> on page 2868.
Delete all	See <a href="#">Delete all action in Microsoft 365 Outlook package</a> on page 2868.
Disconnect	See <a href="#">Disconnect action in Microsoft 365 Outlook package</a> on page 2869.
Forward	See <a href="#">Forward action in Microsoft 365 Outlook package</a> on page 2869.
Move	See <a href="#">Move action in Microsoft 365 Outlook package</a> on page 2871.
Move all	See <a href="#">Move all action in Microsoft 365 Outlook package</a> on page 2871.
Reply	See <a href="#">Reply action in Microsoft 365 Outlook package</a> on page 2872.
Reply all	See <a href="#">Reply all action in Microsoft 365 Outlook package</a> on page 2874.
Save all attachments	See <a href="#">Save all attachments action in Microsoft 365 Outlook package</a> on page 2876.
Save attachments	See <a href="#">Save attachments action in Microsoft 365 Outlook package</a> on page 2877.
Save email	See <a href="#">Save email action in Microsoft 365 Outlook package</a> on page 2877.
Send	See <a href="#">Send action in Microsoft 365 Outlook package</a> on page 2877.

Related reference

[Microsoft 365 Outlook package updates](#) on page 917

Review the updates in released versions of Microsoft 365 Outlook package such as new and enhanced features as well as fixes and limitations. The page also lists the release dates of each version, and the compatible Control Room and Bot Agent versions.

## Change status action in Microsoft 365 Outlook package

Use the **Change status** action in the Microsoft 365 Outlook package to change the status of emails. Ensure that you use this action within a **Loop** action to mark an email as Unread or Read in Microsoft 365 Outlook.

### Settings

- In the **Microsoft 365 Outlook session** field, click one of the following tabs:
  - **Session name:** to enter the session name that you have used in the **Connect** action.
  - **Variable:** to specify a session variable that can be used to share that session with other child bots.
- Use the **Change status to** field to select one of the following options:
  - **Unread:** to change the status of your email to Unread.  
This is the default selection.
  - **Read:** to change the status of your email to Read.

## Check if folder exists action in Microsoft 365 Outlook package

Use the **Check if folder exists** action in the Microsoft 365 Outlook package to verify if a specific folder is available in the Microsoft Outlook server.

### Settings

- In the **Microsoft 365 Outlook session** field, click one of the following tabs:
  - **Session name:** to enter the session name that you have used in the **Connect** action.
  - **Variable:** to specify a session variable that can be used to share that session with other child bots.
- In the **Folder name** field, enter the name of the folder you want to verify in your Microsoft 365 Outlook inbox.

---

**Note:** Review the following conditions for the **Folder name** field:

- Is not case sensitive.
- Regular expressions are not supported.
- Use \ (backslash) to specify a nested folder path.

For example, `inbox\folder1`

- In the **Save the outcome to variable** field, select a Boolean variable to store the output of the action.

**Note:** The Control Room shows a descriptive default variable name. If you create several output variables, subsequent variable names are appended with a -1, -2, -3, and so on to avoid duplication

---

## Using Connect action in Microsoft 365 Outlook package

Use the **Connect** action in the Microsoft 365 Outlook package to establish a connection with a Microsoft 365 Outlook server. This is the first action you must use to automate Microsoft 365 Outlook related tasks.

OAuth 2.0 is used to connect to the Microsoft 365 Outlook server. Ensure that you configure OAuth 2.0 properties in the Microsoft Azure portal:

- For information on using the **Client credentials** authentication mode, see [Set up OAuth 2.0 using client credentials](#) on page 2857.
- For information on using the **Authorization code with PKCE** authentication mode, see [Set up OAuth 2.0 using authorization code with PKCE](#) on page 2860.
- For information on using the **Control Room managed** authorization mode, see [Set up OAuth 2.0 using Control Room managed](#) on page 2863.

## Settings

- Click the **Azure cloud** drop-down and select one of the following:
  - **Azure Global:** for Microsoft 365 Commercial version (login.microsoftonline.com)
  - **Azure US GCC High:** for Microsoft 365 Government version (login.microsoftonline.us)
- Click the **OAuth2 Authentication mode** drop-down and select one of the following authentication modes:
  - **Client Credentials**

For more information, see [Microsoft identity platform and the OAuth 2.0 client credentials flow](#)

Use the following fields to enter the information that is provided for your account on your [Azure portal](#)

- **Client ID:** enter the Microsoft 365 client or insert it from the Credential Vault.
- **Tenant ID:** enter the unique ID for your Microsoft 365 subscription or insert it from the Credential Vault.
- **Username:** enter the username that you want to use for accessing the Microsoft 365 Outlook server.

If you are accessing shared mailbox, ensure that you provide the email address of the user who has access to the shared mailbox

- **Client secret:** enter your access token or insert it from the Credential Vault.

For all the above fields, you can use one of the following tabs to insert a value:

- **Credential:** to use a value in the Credential Vault that contains information about the Client ID/Client secret/ username/ password..

- **Variable:** to use a user-defined variable that contains information about the Client ID/ Client secret/ username/ password.
- **Insecure string:** to enter a value.
- **Authorization Code with PKCE**

For more information, see [Microsoft identity platform and OAuth 2.0 authorization code flow](#)

Use the following fields to enter the information that is provided for your [Azure portal](#):

- **Client ID:** enter the Microsoft 365 client or insert it from the Credential Vault.
- **Tenant ID:** enter the unique ID for your Microsoft 365 subscription or insert it from the Credential Vault.
- **Redirect URL:** enter the URL address.

The bot must run in an attended mode by providing a log in form for the first time where you can enter your log in credentials.

- **Username:** enter the email address of the mailbox you want to access within Microsoft 365 Outlook server.

OAuth2 credentials configured in the Microsoft Azure portal must be used to access this mailbox. If you are accessing shared mailbox, ensure that you provide the email address of the user who has access to the shared mailbox

---

**Note:** If you have selected the **Authorization Code with PKCE** option, a browser is displayed that implies the connection to the Microsoft 365 Outlook server was established successfully. Ensure that you close this browser to continue.

---

- **Control Room managed**

Use the following fields to update the information:

- **Connection:** click the **Pick** button to select an existing connection.
  - Click the **Provider type** drop-down menu to select an available or custom provider.  
For information in creating a custom provider, see [Configure OAuth2 parameters in the Control Room](#) on page 2865.
  - Click the **Connection name** to select the corresponding connection for the selected provider.
  - Use the **Token type** field to select one of the following options:
    - **Shared:** for a global token.

An access token of shared type is created when a connection is established to the Control Room. This access token is stored as a credential. When you run your automation, the access token is referenced in the automation using the enterprise application provider type set up in the Control Room.

- **User-specific:** for a token that is specific to a user.

If you select this option, ensure that you log in to your Microsoft 365 account to authenticate and generate a user-specific token. Perform the following steps to use this option:

1. Log in to Control Room and navigate to **My settings > OAuth connections** in your profile.
2. Under the **OAuth connections** tab, click **Login to authenticate**.



3. Sign in to your Microsoft 365 account and select **Continue**.
4. Verify the services you have access to and click **Continue**.

If the connection is succeeded, it will display the status as **Active** under the **OAuth connections > Connections** table.

- Click one of the following tabs in the **Username** field:
  - **Credential**: click the **Pick** button to select a value in the Credential Vault that contains information about the username.
  - **Variable**: to use a user-defined variable that contains information about the username.
  - **Insecure string**: to enter a value.

If you are accessing shared mailbox, ensure that you provide the email address of the user who has access to the shared mailbox

- In the **Create Microsoft 365 Outlook session** field, use one of the following tabs for creating a session:
  - **Local session**: to specify a session name that can be used only in the current bot.
  - **Global session**: to specify a session name that can be used across multiple botsbots, such as parent bots, child bots, and all other child bots of the parent bot.
  - **Variable**: to specify a session variable that can be used to share that session with other child bots.

## Set up OAuth 2.0 using client credentials

To set up OAuth 2.0 to use client credentials, you must register your Azure Active Directory application.

To register your Azure Active Directory application with the Microsoft identity platform, perform the following steps.

1. Log in to the Microsoft Azure portal.

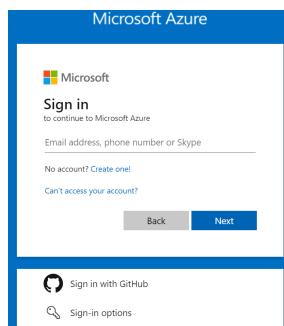

---

**Note:** Enter your complete email address including the domain (for example, abc@domain.com).

---

2. On the **Home** page, click **View** under the **Manage Azure Active Directory** option.

- On the **Overview** page, select **App registrations** from the **Manage** panel and then click **+ New**

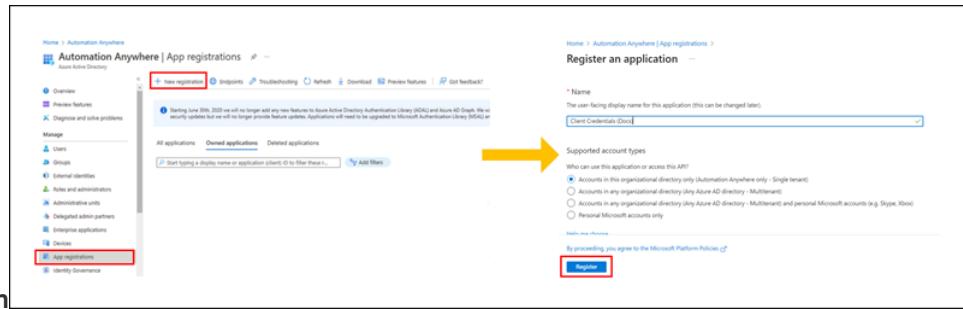

registration

- On the **Register an application** page, enter the appropriate name in the **Name** field, then select the account type and click **Register**.

**Note:** You do not need to enter the Redirect URL because it is not required for the Client Credential flow.

- To set the API permission for the application to access the API resources, select the **API permissions** option under the **Manage** panel.
- Click **+ Add a permission > Microsoft APIs** and select **Microsoft Graph**.

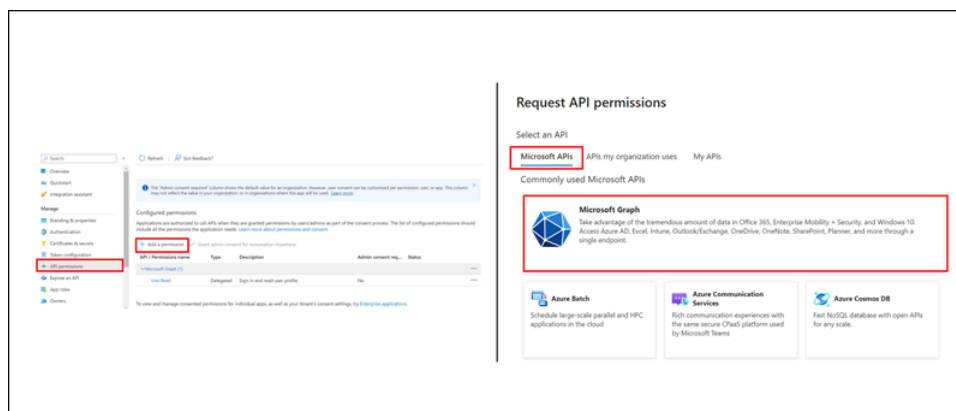

- Select **Application permissions** and perform the following steps:
  - Search with **User** in the **Select permissions** search box and expand the **User** option.
  - Select the **User.Read.All** check box.

**Note:** Enabling the above option can grant access to all the mailboxes in your organization. Therefore it is important to impose access restrictions. Administrators can use `New-ApplicationAccessPolicy` PowerShell cmdlet to limit access to specific mailboxes. For more information, see [Limiting application permissions to specific Exchange Online mailboxes](#).

- Search with **Mail** in the **Select permissions** search box and expand the **Mail** option.
- Select the **Mail.ReadWrite** and **Mail.Send** API permissions check boxes.
- Click **Add permissions**.

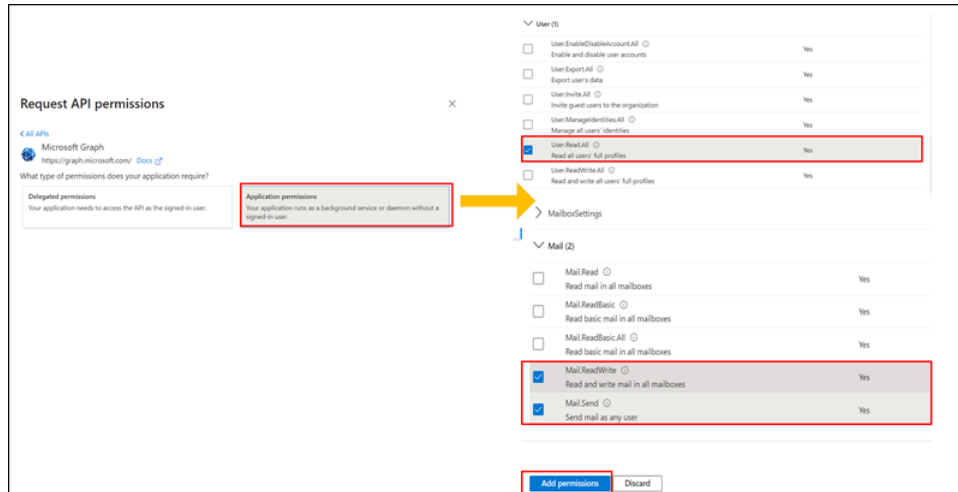

8. Click **Yes** to grant permission to use the API.  
Ensure that the permissions are granted by an administrator or a user with administrator privileges, as shown in the

API / Permissions name	Type	Description	Admin consent requ...	Status
+ Add a permission ✓ Grant admin consent for Automationanywhere Store				
Microsoft Graph (3)				
Mail.ReadWrite	Application	Read and write mail in all mailboxes	Yes	Granted for Automation... ***
Mail.Send	Application	Send mail as any user	Yes	Granted for Automation... ***
User.Read.All	Application	Read all users' full profiles	Yes	Granted for Automation... ***

following:

9. To create a client secret, click **Certificates and secrets** option under the **Manage** panel.
  - a) Click **+New client secret** to open the **Add a client secret** window.
  - b) Enter an appropriate description in the **Description** field and set the expiry duration.
  - c) Click **Add**.

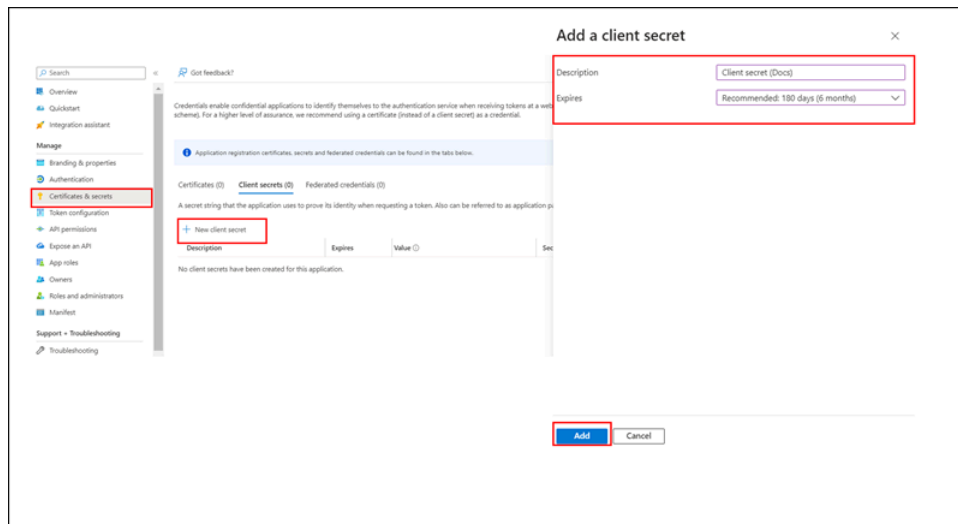

- d) Copy and save the Client secret value to a safe location for your reference. We recommend that you do not share the value with anyone.

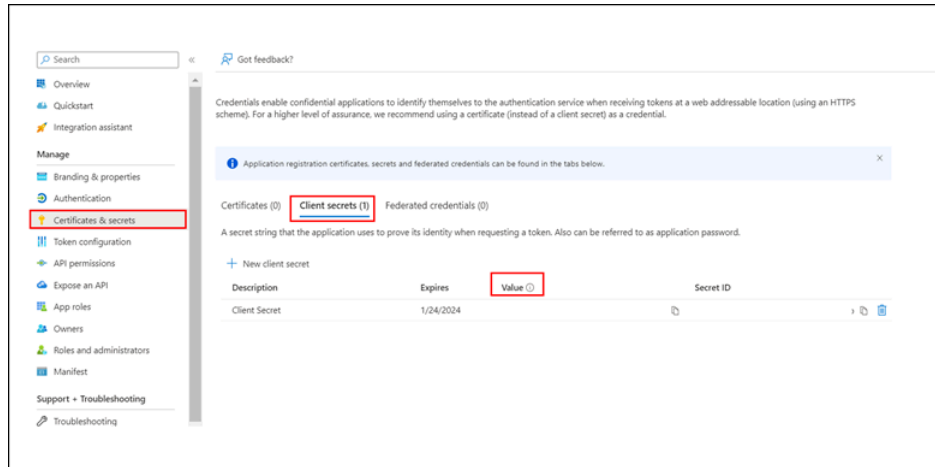

10. After an application is registered, the application is assigned with the **Client ID** and **Tenant ID**. You can click **Copy to clipboard** to copy the tenant and the client IDs.

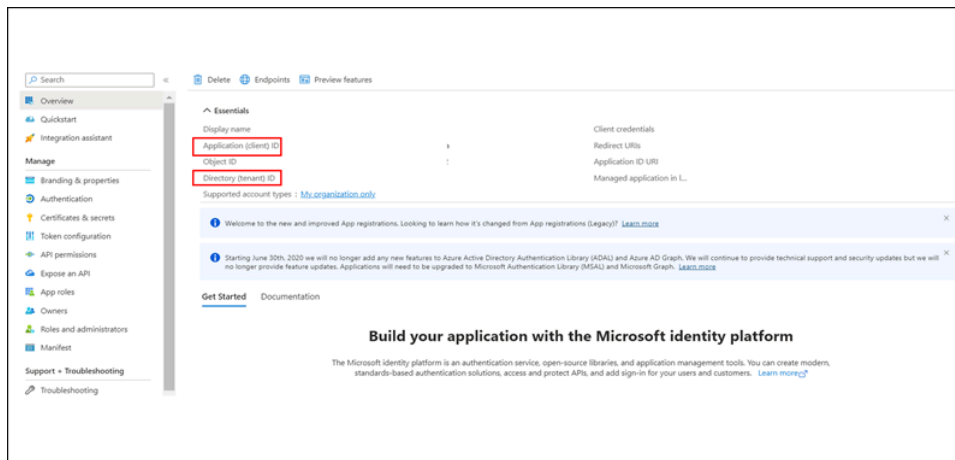

You can use the Client ID, Tenant ID, and Client secret to establish a connection with a Microsoft 365 Outlook server.

**Note:** If the mailbox is used inside a **Loop**, ensure that you register the user who is assigned to perform the automation. For more information, see .

## Set up OAuth 2.0 using authorization code with PKCE

To set up OAuth 2.0 to use authorization code with PKCE, you must register your Azure Active Directory application.

To register your Azure Active Directory application with the Microsoft identity platform, perform the following steps:

1. Log in to the Microsoft Azure portal.

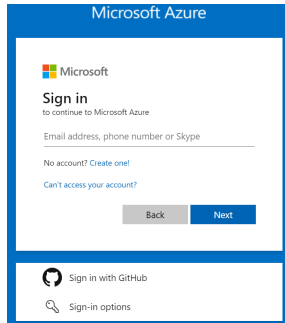

**Note:** Enter your complete email address including the domain (for example: abc@domain.com).

2. On the **Home** page, click **View** under the **Manage Azure Active Directory** option.
3. On the **Overview** page, select **App registrations** from the **Manage** panel and then click **+ New registration**.
4. On the **Register an application** page, enter the appropriate name in the **Name** field, then select the supported account type and configure the Redirect URI.
  - a) For the Redirect URI platform, select the **Public client/native (mobile & desktop)** option.
  - b) Set the Redirect URI to `http://localhost:9999/Callback`. Ensure that port 9999 is open or use any other open port.
  - c) Click **Register** to complete the initial app registration.

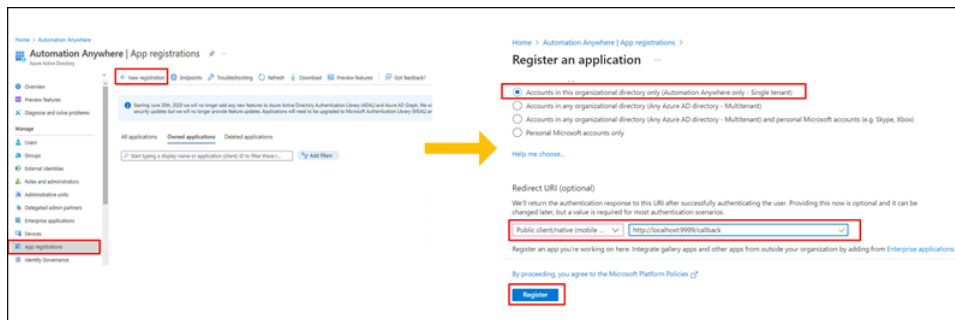

5. To set the API permission for the application to access the API resources, select the **API permissions** option under the **Manage** panel.
6. Click **+ Add a permission > Microsoft APIs** and select **Microsoft Graph**.

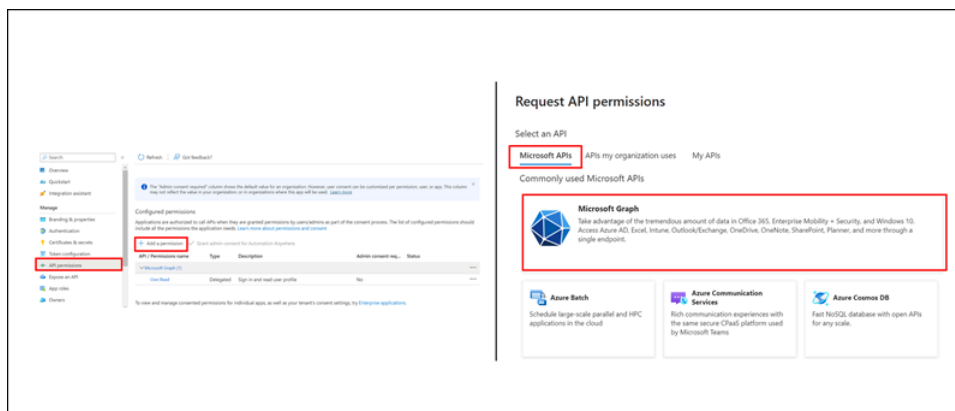

7. Select **Delegated permissions** and perform the following steps:

a) Select the following permissions:

- email
- offline\_access
- openid
- profile

b) Search with **User** in the **Select permissions** search box and expand **User** option.

c) Select the **User.Read** check box.

**Note:** Administrators can use `New-ApplicationAccessPolicy` PowerShell cmdlet to limit access to specific mailboxes. For more information, see [Limiting application permissions to specific Exchange Online mailboxes](#).

d) Search with **Mail** in the **Select permissions** search box and expand the **Mail** option.

e) Select the **Mail.ReadWrite** and **Mail.Send** API permissions.

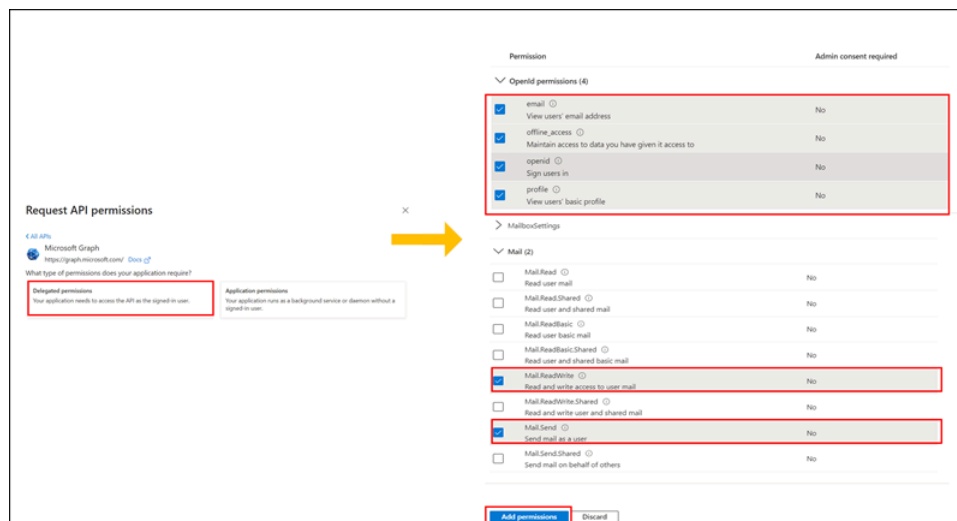

f) Click **Add permissions**.

g) Click **Yes** to grant permission to use the API.

Ensure that the permissions are granted by an administrator or a user with administrator privileges, as shown in the following:

Configured permissions

Applications are authorized to call APIs when they are granted permissions by users/admins as part of the consent process. The list of configured permissions should include all the permissions the application needs. [Learn more about permissions and consent](#)

+ Add a permission ✓ Grant admin consent for Automationanywhere Store

API / Permissions name	Type	Description	Admin consent requ...	Status
Microsoft Graph (7)				
email	Delegated	View users' email address	No	✓ Granted for Automation...
Mail.ReadWrite	Delegated	Read and write access to user mail	No	✓ Granted for Automation...
Mail.Send	Delegated	Send mail as a user	No	✓ Granted for Automation...
offline_access	Delegated	Maintain access to data you have given it access to	No	✓ Granted for Automation...
openid	Delegated	Sign users in	No	✓ Granted for Automation...
profile	Delegated	View users' basic profile	No	✓ Granted for Automation...
User.Read	Delegated	Sign in and read user profile	No	✓ Granted for Automation...

- After an application is registered, the application is assigned with the **Client ID** and **Tenant ID**. You can click **Copy to clipboard** to copy the tenant and the client IDs.

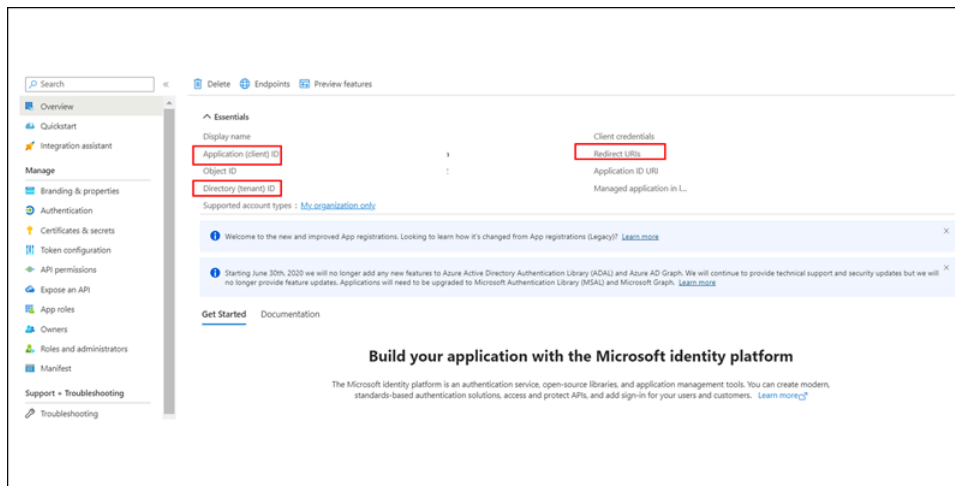

You can use the Client ID, Tenant ID, and Client secret to establish a connection with a Microsoft 365 Outlook server.

**Note:** If the mailbox is used inside a **Loop**, ensure that you register the user who is assigned to perform the automation. For more information, see .

## Set up OAuth 2.0 using Control Room managed

Create an application in the Microsoft Azure Console and retrieve the OAuth 2.0 parameters to configure OAuth connection in the Control Room.

A Control Room administrator or a user who has the required set of permissions (or role) can setup OAuth 2.0 connection.

To register your Azure Active Directory application with the Microsoft identity platform, perform the following steps:

- Log in to the Microsoft Azure portal.

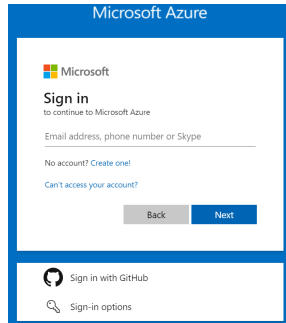

**Note:** Enter your complete email address including the domain (for example: abc@domain.com).

2. On the **Home** page, click **View** under the **Manage Azure Active Directory** option.
3. On the **Overview** page, select **App registrations** from the **Manage** panel and then click **+ New registration**.
4. On the **Register an application** page, enter the appropriate name in the **Name** field, then select the supported account type and configure the Redirect URI.
  - a) For the Redirect URI platform, select the **Web** option.
  - b) Provide the callback URI from OAuth connection.
  - c) Click **Register** to complete the initial app registration.
5. To set the API permission for the application to access the API resources, select the **API permissions** option under the **Manage** panel.
6. Click **+ Add a permission > Microsoft APIs** and select **Microsoft Graph**.

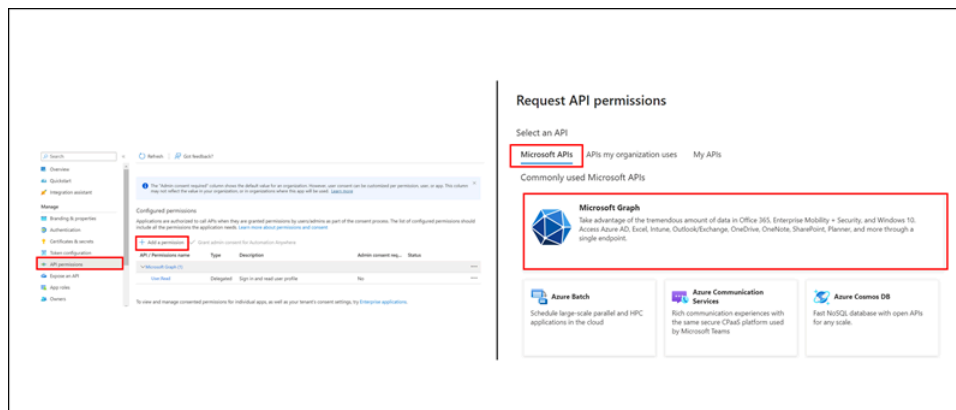

7. Select **Delegated permissions** and add the required permissions. The permissions can vary based on your requirement. For example, email, offline\_access, and so on.
8. After an application is registered, the application is assigned with the **Client ID** and **Tenant ID**. You can click **Copy to clipboard** to copy the tenant and the client IDs.



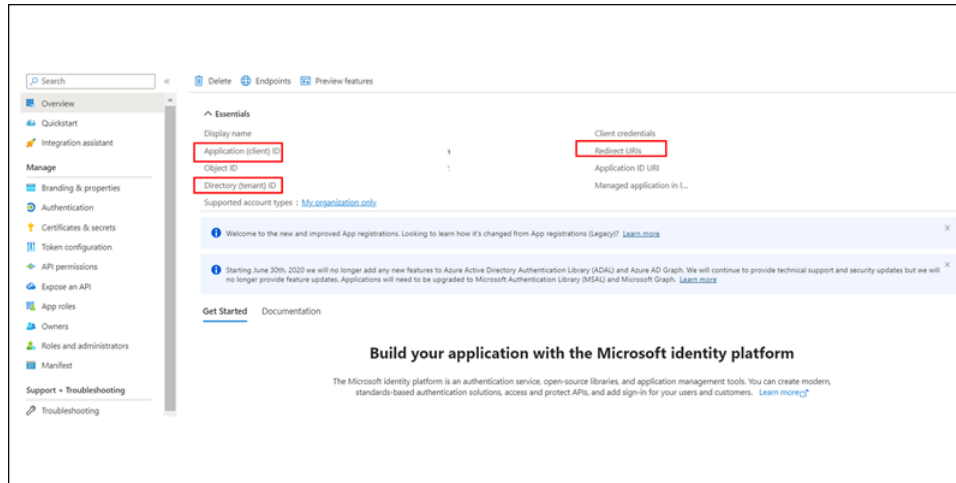

You can use the Client ID, Tenant ID, and Client secret to establish a connection with a Microsoft 365 Outlook server.

After you have established the OAuth 2.0 connection and parameters, administrator or a user who has the required set of permissions (or role) can configure the OAuth 2.0 connection in the Control Room, which is used in various Microsoft 365 packages.

For more information, see [Configure OAuth2 parameters in the Control Room](#) on page 2865.

## Configure OAuth2 parameters in the Control Room

As an administrator, create **OAuth connections** in the Control Room for users to use these connections made in the Google packages.

**Note:** If you want users to view and edit OAuth connections, then you must assign a custom role that has the **Manage connections** and **View connections** options enabled for the **OAuth CONNECTIONS** feature.

Ensure you have [Set up OAuth2 in the Google Cloud Platform](#).

1. Log in to the Control Room.
2. Navigate to **Manage > OAuth connections**.
3. In the **Connection setting** screen, select **Custom** in the **Provide type** field and enter a unique name to identify connection in the **Connection name** field.
4. Click **Next**, the **Authentication** screen appears.

The screenshot shows the 'Create connection' dialog box with the 'Connection settings' tab selected. The 'Provider type' dropdown is set to 'Custom'. The 'Connection name' field contains 'GoogleWorkspace'. The 'Next >' button is highlighted.

5. In the Authentication details screen, enter the following values:

a) Select **Authorization Code Flow** in the Grant type field.

**Note:** Google Workspace does not support Authorization code flow with PKCE.

b) In the **Client ID** and **Client secret** fields, enter the information that is provided for your account.

c) Enter `https://accounts.google.com/o/oauth2/auth?prompt=consent&access_type=offline` in the **Authorization URL** field.

d) Enter `https://oauth2.googleapis.com/token` in the **Token URL** field.

e) Enter the following scopes in the **Scope (optional)** field: `https://www.googleapis.com/auth/calendar`, `https://www.googleapis.com/auth/drive`, `https://www.googleapis.com/auth/spreadsheets`

This information is used as claims (information about the user) in an access token and forwarded to the resource server to limit access.

**Note:** If you are adding more than one scope, ensure that you separate the scopes using commas.

f) Click **Next**.

The screenshot shows the 'Create connection' dialog box with the 'Authentication details' tab selected. The 'Grant type' dropdown is set to 'Authorization Code Flow'. The 'Authorization URL' field contains 'https://accounts.google.com/o/oauth2/auth?prompt=co'. The 'Next >' button is highlighted.

The **Test connection and save credentials** screen appears.

6. In the **Test connection and save credentials** screen, select the **Save login credentials** check box and click **Save changes and test connection** button.  
When you click **Save changes and test connection button**, it redirects you to sign into your Google account.
7. Select the Google account and click **Continue**.
8. Verify the services and click **Continue**.  
The test connection is succeeded.

**Note:** When using the **Authorization Code Flow** grant type, after you click the **Save changes and test connection** option and if the connection is successful, the **Next** button is disabled. Click the **Back** button, enter the Client secret again, and then click **Next**. You need not test the connection again unless you have made any changes to the previously provided authentication details.

9. Click **Next**.  
The **Invite roles** screen appears.
10. Optional: Select the custom roles that you want to invite to use this connection.

11. Click **Create connection**.

## Delete action in Microsoft 365 Outlook package

Use the **Delete** action in the Microsoft 365 Outlook package to delete a specific email from your Microsoft 365 Outlook inbox. Ensure that you use this action within a **Loop** action.

### Settings

In the **Microsoft 365 Outlook session** field, click one of the following tabs:

- **Session name:** to enter the session name that you have used in the **Connect** action.
- **Variable:** to specify a session variable that can be used to share that session with other child bots.

## Delete all action in Microsoft 365 Outlook package

Use the **Delete all** action in the Microsoft 365 Outlook package to delete read, unread, or all emails from a specific folder in Microsoft 365 Outlook inbox.

### Settings

- In the **Microsoft 365 Outlook session** field, click one of the following tabs:
  - **Session name:** to enter the session name that you have used in the **Connect** action.
  - **Variable:** to specify a session variable that can be used to share that session with other child bots.
- Use the **From specific folders** field to specify the email folders from which you want to delete the emails.

For example, `Inbox/folder1`; `Inbox/folder2` or `Inbox/test*`.

---

**Note:** Microsoft 365 Outlook does not allow the use of wildcard entries (such as `*`) to run a search on folders. Ensure that you specify the folders individually in the **From specific folders** field.

---

- Use the **Status of email to delete** field to select one of the following type of emails you want to delete:
  - **Read:** emails that are in Read status.
  - **Unread:** emails that are in Unread status.
  - **Both:** emails in Read and Unread status.
- (Optional) Use the following fields to provide additional email filters:
  - Enter keywords from the email subject line in the **When subject contains** field for the emails you want to delete.
    - This field is not case sensitive.  
For example, the search results are the same for 'Sales information', 'sALes Information' or 'SALES INFORMATION'.
    - An empty space is treated as a character.

For example, `salesinformation` will display different results as compared to `sales information`.

- Enclose the **Subject** link in double quotes ("") for an exact match.

For example, use "July sales information" in the **Subject** line.

For more information, see [How subject filter works when moving emails](#) on page 2549.

- **From specific senders:** to specify the senders' email addresses.

For multiple senders, use semi-colon (;) to separate the email addresses.

- Use the **When the received date is on or after** field to select a date after which you received the emails.

Click the **Create variable** icon if there is no existing variable.

- Use the **When the received date is before** field to select a date before which you received the emails.

Optionally, you can also click the **Create variable** icon if there is no existing variable.

## Disconnect action in Microsoft 365 Outlook package

Use the **Disconnect** action in the Microsoft 365 Outlook package to terminate an active connection with Microsoft 365 Outlook server.

### Settings

In the **Microsoft 365 Outlook session** field, click one of the following tabs:

- **Session name:** to enter the session name that you have used in the **Connect** action.
- **Variable:** to specify a session variable that can be used to share that session with other child bots.

## Forward action in Microsoft 365 Outlook package

Use the **Forward** action in the Microsoft 365 Outlook package to send emails and attachments to one or more recipients as plain text or HTML through Microsoft Outlook server. Ensure that you use this action within a **Loop** action.

### Settings

- In the **Microsoft 365 Outlook session** field, click one of the following tabs:
  - **Session name:** to enter the session name that you have used in the **Connect** action.
  - **Variable:** to specify a session variable that can be used to share that session with other child bots.
- Enter the email addresses of the recipients in the **To** field.
- (Optional) Use the **Cc** and **Bcc** fields to enter email addresses of other recipients you want to mark a copy of the email.
- (Optional) In the **Attachment** field, select one of the following options to upload a file as an email attachment:

Option	Description
<b>List</b>	<ul style="list-style-type: none"> <li>• Click <b>Add</b> to attach files.</li> <li>• Use one of the following tabs in the <b>Value</b> field to specify the location of the files that you want to attach: <ul style="list-style-type: none"> <li>• <b>Control Room file</b>: To select an attachment that is available in the Control Room repository.</li> <li>• <b>Desktop file</b>: To select an attachment that is available on your device.</li> </ul> <p>You can provide a combination of static path and string variable. To use it as a string variable, press F2 and select the string variable that stores the filepath. Or click <b>Browse</b> and select the filepath. After you have selected the filepath, you can insert a variable at any location to make it a dynamic filepath.. Enter the <b>Variable</b> name and paste the file path in the <b>Default value</b> field. Press F2 to insert the value of the filepath.</p> <li>• <b>Variable</b>: To specify or select the file variable from the list..</li> </li></ul>
<b>Variable</b>	Click the <b>Insert a value</b> icon to select an existing variable.

- Use the **Email body** field to select one of the following options for the email body:
  - **Plain text**: Use regular text in your email body, with no formatting effects, such as bold, italic, or underline, or special layout options.
  - **HTML design**: Use HTML script in your mail body when you want your content to be displayed in a certain layout every time. You can also include interactive elements, such as links.
  - **HTML code**: Use this option to create and customize your email layout and body. Use the editor toolbar to make various changes to your text, such as applying bold, italic, and other formatting effects, inserting links, and changing the font and size of the text. You can copy the content from the design editor and paste it in the **Message** field.
- Enter the content you want to send along with the email in the **Message** field.

## Move action in Microsoft 365 Outlook package

Use the **Move** action in the Microsoft 365 Outlook package to move an email from one folder to another in the mailbox. Ensure that you use this action within a **Loop** action.

### Settings

- In the **Microsoft 365 Outlook session** field, click one of the following tabs:
  - **Session name:** to enter the session name that you have used in the **Connect** action.
  - **Variable:** to specify a session variable that can be used to share that session with other child bots.
- Use the **Destination folder path** field to enter the destination folder path that you want to move the email to.  
For example, `Inbox/finance/April`.

## Move all action in Microsoft 365 Outlook package

Use the **Move all** action in the Microsoft 365 Outlook package to move all your emails in Microsoft Outlook server from one folder to another.

The **Move all** action must be used outside a **Loop** action. For more information, see [Can Move all action be used within a loop? \(A-People login required\)](#).

### Settings

- In the **Microsoft 365 Outlook session** field, click one of the following tabs:
  - **Session name:** to enter the session name that you have used in the **Connect** action.
  - **Variable:** to specify a session variable that can be used to share that session with other child bots.
- Use the **Destination folder path** in mailbox field to provide the folder location where you want to move all the emails.
- Use the **Status of email to move** field to select one of the following types of emails to move:
  - **Read:** emails that are in Read status.
  - **Unread:** emails that are in Unread status.
  - **Both:** emails in Read and Unread status.
- Enter the folder path in the **From specific folders** field to specify the folder from where you want to move the emails.  
For example, `Inbox/project1`.
- Enter keywords from the email subject line in the **When subject contains** field for the emails you want to move.
  - This field is not case sensitive.  
For example, the search results are the same for `Sales information`, `sALes Information` or `SALES INFORMATION`.

- An empty space is treated as a character.  
For example, `salesinformation` will display different results as compared to 'sales information'.
- Enclose the **Subject** link in double quotes (") for an exact match.  
For example, use "July sales information" in the Subject line.

For more information, see [How subject filter works when moving emails](#) on page 2549.

- Enter email addresses of specific senders in the **From specific senders** field.  
For multiple senders, use semi-colon (;) to separate the email addresses.
- Use the **When the received date is on or after** field to select a date after which you received the emails.  
Click the **Create variable** icon if there is no existing variable.
- Use the **When the received date is before** field to select a date before which you received the emails.  
Click the **Create variable** icon if there is no existing variable.

## Reply action in Microsoft 365 Outlook package

Use the **Reply** action in the Microsoft 365 Outlook package to send an email response without changing the subject line in the original email. Ensure that you use this action within a **Loop** action. This action does not include any files attached to the original email.

### Settings

- In the **Microsoft 365 Outlook session** field, click one of the following tabs:
  - **Session name**: to enter the session name that you have used in the **Connect** action.
  - **Variable**: to specify a session variable that can be used to share that session with other child bots.
- (Optional) Use the **Cc** and **Bcc** fields to enter the email address of additional recipients.  
The **Cc** and **Bcc** are not case sensitive.
- (Optional) Use the **Attachment** field to select **List** or **Variable**.  
The **Attachment** field enables you to specify if multiple files can be attached as a list or a variable must be created to hold the list values of the file object. Review the following table for more information:



Option	Description
<b>List</b>	<ul style="list-style-type: none"> <li>• Select the attachment from a location:               <ul style="list-style-type: none"> <li>• <b>Control Room file:</b> To select an attachment that is available in the Control Room repository.</li> <li>• <b>Desktop file:</b> To select an attachment that is available on your device.</li> </ul> </li> </ul> <p>You can provide a combination of static path and string variable. To use it as a string variable, press F2 and select the string variable that stores the filepath. Or click <b>Browse</b> and select the filepath. After you have selected the filepath, you can insert a variable at any location to make it a dynamic filepath.. Enter the <b>Variable</b> name and paste the file path in the <b>Default value</b> field. Press F2 to insert the value of the filepath.</p> <ul style="list-style-type: none"> <li>• <b>Variable:</b> To specify or select the file variable from the list..</li> </ul> <ul style="list-style-type: none"> <li>• Specify the path that you want to attach in the <b>Value</b> field. Click <b>Add</b> to attach multiple files.</li> </ul>
<b>Variable</b>	<p>Enables you to specify the list of file objects that contain the location of the attachments.</p> <p>Create a new variable of type List with subtype <b>File</b>, and add the filepath in the <b>Default value</b> field (optional). You can choose the file from the <b>Desktop</b> or <b>Control room</b>.</p>

- Use the **Email body** field to select one of the following format options for the body of the email:
  - **Plain text:** Use regular text in your email body, with no formatting effects, such as bold, italic, or underline, or special layout options.
  - **HTML design:** Use HTML script in your mail body when you want your content to be displayed in a certain layout every time. You can also include interactive elements, such as links.
  - **HTML code:** Use this option to create and customize your email layout and body. Use the editor toolbar to make various changes to your text, such as applying bold, italic, and other formatting effects, inserting links, and changing the font and size of the text. You can copy the content from the design editor and paste it in the **Message** field.

- Enter the content you want to send along with the email in the **Message** field.

The email is appended to the message that you have specified.

## Reply all action in Microsoft 365 Outlook package

Use the **Reply all** action in the Microsoft 365 Outlook package to send an email response with the same or modified subject and include all the recipients of that email. Ensure that you use this action within a **Loop** action.

### Settings

- In the **Microsoft 365 Outlook session** field, click one of the following tabs:
  - **Session name:** to enter the session name that you have used in the **Connect** action.
  - **Variable:** to specify a session variable that can be used to share that session with other child bots.

- (Optional) Use the **Cc** and **Bcc** fields to enter the email address of additional recipients.

The **Cc** and **Bcc** are not case sensitive.

- (Optional) Select the **Exclude the sender of the email** check box to remove the email address of the sender.
- (Optional) Use the **Attachment** field to select **List** or **Variable**.

The **Attachment** field enables you to specify if multiple files can be attached as a list or a variable must be created to hold the list values of the file object. Review the following table for more information:

Option	Description
<b>List</b>	<ul style="list-style-type: none"> <li>• Select the attachment from a location: <ul style="list-style-type: none"> <li>• <b>Control Room file:</b> To select an attachment that is available in the Control Room repository.</li> <li>• <b>Desktop file:</b> To select an attachment that is available on your device.</li> </ul> </li> </ul> <p>You can provide a combination of static path and string variable. To use it as a string variable, press F2 and select the string variable that stores the filepath. Or click <b>Browse</b> and select the filepath. After you have selected the filepath, you can insert a variable at any location to make it a dynamic filepath.. Enter the <b>Variable</b> name and paste the file path in the <b>Default value</b> field. Press F2 to insert the value of the filepath.</p> <ul style="list-style-type: none"> <li>• <b>Variable:</b> To specify or select the file variable from the list..</li> </ul> <ul style="list-style-type: none"> <li>• Specify the path that you want to attach in the <b>Value</b> field. Click <b>Add</b> to attach multiple files.</li> </ul>
<b>Variable</b>	Enables you to specify the list of file objects that contain the location of the attachments. Click the <b>Insert a value</b> icon to select an existing variable.

- Use the **Email body** field to select one of the following format options for the body of the email:
    - **Plain text:** Use regular text in your email body, with no formatting effects, such as bold, italic, or underline, or special layout options.
    - **HTML design:** Use HTML script in your mail body when you want your content to be displayed in a certain layout every time. You can also include interactive elements, such as links.
    - **HTML code:** Use this option to create and customize your email layout and body. Use the editor toolbar to make various changes to your text, such as applying bold, italic, and other formatting effects, inserting links, and changing the font and size of the text. You can copy the content from the design editor and paste it in the **Message** field.
  - Enter any content you want to send along with the email in the **Message** field.
- The email will be appended to the message you have specified.

## Save all attachments action in Microsoft 365 Outlook package

Use the **Save all attachments** action in the Microsoft 365 Outlook package to save all the email attachments on Microsoft Outlook server to a specific folder.

### Settings

- In the **Microsoft 365 Outlook session** field, click one of the following tabs:
  - **Session name:** to enter the session name that you have used in the **Connect** action.
  - **Variable:** to specify a session variable that can be used to share that session with other child bots.
- Use the **Status of email** field to select one of the following type of emails from where you want to save the attachments:
  - **Read:** emails that are in Read status.
  - **Unread:** emails that are in Unread status.
  - **Both:** emails in Read and Unread status.

- Enter the folder path in the **From specific folders** field to specify the folder from where you want to save the attachments.

For example, `Inbox/project1`. Although multiple folder paths separated by semicolon are supported in this field, the regular expressions are not supported.

- (Optional) Enter keywords from the email subject line in the **When subject contains** field.

The **When subject contains** field is case sensitive. When you enter keyword within double quotes (""), the bot retrieves all the emails where the subject matches the text and the case
- (Optional) Enter email addresses of specific senders in the **From specific senders** field.
- (Optional) Use the **When the received date is on or after** field to select a date after which you received the emails.

Click the **Create variable** icon if there is no existing variable.

- (Optional) Use the **When the received date is before** field to select a date before which you received the emails.

Click the **Create variable** icon if there is no existing variable.

- In the **Save attachments to folder** field, enter the filepath of the folder where you want to save the email attachments.

You can also click the **Insert a value** icon to select a variable.

- (Optional) Clear the **Overwrite file(s)** check box if you do not want to overwrite any existing files in the folder.

The **Overwrite file(s)** option is enabled by default.

## Save attachments action in Microsoft 365 Outlook package

Use the **Save attachment** action in the Microsoft 365 Outlook package to save attachments from a specific email to a folder. Ensure that you use this action within a **Loop** action.

### Settings

- In the **Microsoft 365 Outlook session** field, click one of the following tabs:
  - **Session name:** to enter the session name that you have used in the **Connect** action.
  - **Variable:** to specify a session variable that can be used to share that session with other child bots.
- In the **Save attachments to folder** field, enter the filepath of the folder where you want to save the email attachments.
- (Optional) Clear the **Overwrite file(s)** check box if you do not want to overwrite any existing files in the folder.

The **Overwrite file(s)** option is enabled by default.

## Save email action in Microsoft 365 Outlook package

Use the **Save email** action in the Microsoft 365 Outlook package to save an email as an EML file to a folder. Ensure that you use this action within a **Loop** action.

### Settings

- In the **Microsoft 365 Outlook session** field, click one of the following tabs:
  - **Session name:** to enter the session name that you have used in the **Connect** action.
  - **Variable:** to specify a session variable that can be used to share that session with other child bots.
- Enter the location where you want to save the email in **Save emails to folder**.

The **Save emails to folder** is not case sensitive.
- (Optional) Clear the **Overwrite file(s)** check box if you do not want to overwrite any existing files in the folder.

The **Overwrite file(s)** option is enabled by default.

## Send action in Microsoft 365 Outlook package

Use the **Send** action in the Microsoft 365 Outlook package to send an email to one or more recipients from Microsoft 365 Outlook, as plain text or HTML format.

The **Send** action enables you to attach multiple files of various formats to an email. There is no restriction on the type or size of file you can attach. However, restrictions implemented by the Microsoft exchange server you are using to send an email apply.

**Note:** Attachments sent as part of email automation are subject to the policies and rules set at the level of the proxy server, firewall, anti-virus, email server, customer environment, and so on.

## Settings

- In the **Microsoft 365 Outlook session** field, click one of the following tabs:
  - Session name:** to enter the session name that you have used in the **Connect** action.
  - Variable:** to specify a session variable that can be used to share that session with other child bots.
- Enter the email addresses of the recipients in the **To** field.
- (Optional) Use the **Cc** and **Bcc** fields to enter email addresses of other recipients you want to mark a copy of the email.
- Enter the email subject in the **Subject** field.
- (Optional) In the **Attachment** field, select one of the following tabs to upload an file as an email attachment::

Option	Description
<b>List</b>	<ul style="list-style-type: none"> <li>Click <b>Add</b> to attach files.</li> <li>Use one of the following tabs in the <b>Value</b> field to specify the location of the files that you want to attach:               <ul style="list-style-type: none"> <li><b>Control Room file:</b> To select an attachment that is available in the Control Room repository.</li> <li><b>Desktop file:</b> To select an attachment that is available on your device.</li> </ul> <p>You can provide a combination of static path and string variable. To use it as a string variable, press F2 and select the string variable that stores the filepath. Or click <b>Browse</b> and select the filepath. After you have selected the filepath, you can insert a variable at any location to make it a dynamic filepath.. Enter the <b>Variable</b> name and paste the file path in the <b>Default value</b> field. Press F2 to insert the value of the filepath.</p> </li> <li><b>Variable:</b> To specify or select the file variable from the list..</li> </ul>
<b>Variable</b>	Click the <b>Insert a value</b> icon to select an existing variable.

- (Optional) Select the **Raise error if the attachments are missing (Desktop only)** check box if you want to be notified when you have not attached any files to your email.
- Use the **Email** field to select one of the following options for the email body:

- **Plain text:** Use regular text in your email body, with no formatting effects, such as bold, italic, or underline, or special layout options.
  - **HTML design:** Use HTML script in your mail body when you want your content to be displayed in a certain layout every time. You can also include interactive elements, such as links.
  - **HTML code:** Use this option to create and customize your email layout and body. Use the editor toolbar to make various changes to your text, such as applying bold, italic, and other formatting effects, inserting links, and changing the font and size of the text. You can copy the content from the design editor and paste it to other windows.
- (Optional) Enter the content you want to send along with the email in the **Message** field.

## PDF package

Use the PDF package to automate various operations on a PDF file.

The PDF package enables you to perform the following tasks:

- Encrypt or decrypt a PDF file.
- Extract text from a PDF file.
- Convert a PDF file to an image.
- Merge several PDF files into a single file.
- Split a single PDF file into multiple files.

It is not necessary to have a PDF reader installed on your device.

### Actions in the PDF package

The PDF package includes the following actions:

**Note:** The Extract field, Extract image, and Extract text actions in the PDF package are supported only for PDF files that are editable. These packages are not supported for scanned PDF documents that contain the PDF content as images.

Action	Description
Decrypt document	See <a href="#">Using the Decrypt document action</a> on page 2885.
Encrypt document	See <a href="#">Using the Encrypt document action</a> on page 2880.
Extract field	See <a href="#">Using the Extract field action</a> on page 2881
Extract image	See <a href="#">Using the Extract image action</a> on page 2883.
Extract text	See <a href="#">Using Extract text action from PDF</a> on page 2882.
Get property	See <a href="#">Using the Get property action</a> on page 2885
Merge documents	See <a href="#">Using the Merge documents action</a> on page 2886.
Split document	See <a href="#">Using the Split document action</a> on page 2887.

When an operation is performed on a PDF file, the file properties are stored in a dictionary variable. See [Using a dictionary variable for PDF properties](#) on page 2888.

Related reference

[PDF package updates](#) on page 924

Review the updates in released versions of the PDF package such as new and enhanced features as well as fixes and limitations. The page also lists the release dates of each version, and the compatible Control Room and Bot Agent versions.

## Using the Encrypt document action

Use the **Encrypt document** action to encrypt a PDF file.

To encrypt a PDF file, follow these steps:

1. In the **Actions** palette, double-click or drag the **Encrypt document** action from the PDF package.
2. In the **PDF path**, select one of the following options to specify the location of the PDF:
  - **Control Room file**: Enables you to select a PDF file that is available in a folder in the Control Room.
  - **Desktop profile**: Enables you to select a PDF file that is available on your device.
  - **Variable**: Enables you to specify the file variable that contains the location of the PDF file.
3. Optional: In the **User password** or **Owner password** field, enter a password to restrict access to the encrypted PDF file.
  - **User password**: Allow users to perform specific operations on the encrypted PDF file.
  - **Owner password**: Allow users to use a password to open the file.
4. In the **User Permissions to Apply** field, select the following operations:
  - **Print**: Allows users to print the document.
  - **Modify**: Allows users to edit the document.
  - **Copy**: Allows users to copy the document.
  - **Form Fill**: Allows users to fill a form in the document.
  - **Document Assembly**: Allows users to combine multiple PDF files, attach files, and so on.
  - **Annotation**: Allows users to apply annotations in the document.
  - **Accessibility**: Allows users to read text from the document using accessibility devices.
5. In the **Encryption level**, select the **RC4 40-bit**, **RC4 128-bit**, or **AES 128-bit** option to specify the encryption level.
6. In the **Save encrypted PDF as** field, specify a name and location for the encrypted file. You must include the .pdf extension in the name of the encrypted file. For example, if the file name is `June_Quarter_report`, the .pdf extension is `June_Quarter_report.pdf`.
7. Select the **Overwrite files with the same name** check box to overwrite existing files with the same name.

---

**Note:** If this option is not selected and the bot encounters a file with the same name at the specified location, the bot will fail.

---

8. Optional: From the **Assign PDF properties to a dictionary variable** list, select a dictionary variable to hold the file properties.

For more information, see [Using a dictionary variable for PDF properties](#) on page 2888.



9. Click **Save**.

Related tasks

[Using the Decrypt document action](#) on page 2885

Use the **Decrypt document** action to decrypt a PDF file that was previously encrypted using the **Encrypt document** action.

## Using the Extract field action

Use the **Extract field** action to extract fields from a PDF and assign it to variables.

---

### Important:

- When you extract fields from a PDF that contains 20 form fields, processing time might be 30 to 40 % longer than PDFs without form fields.
  - When you use this action to extract a radio button from a PDF file, the value generated might be -1 when no radio button is selected. Previously, when you did not select any radio button, the output was 0.
- 

To extract fields from a PDF file, follow these steps:

1. In the **Actions** palette, double-click or drag the **Extract field** action from the **PDF** package.
  2. In the **PDF path**, select one of the following options to specify the location of the PDF:
    - **Control Room file**: Enables you to select a PDF file that is available in a folder in the Control Room.
    - **Desktop profile**: Enables you to select a PDF file that is available on your device.
    - **Variable**: Enables you to specify the file variable that contains the location of the PDF file.
  3. From the **File is protected** field, select **Yes** if the file is encrypted and provide the **User password** or **Owner password**.
  4. Click **Open PDF viewer**.
  5. In the **Select a PDF file** window, select a PDF file from Control Room file or Desktop file.
  6. Optional: Enter the password.
  7. Click **Load** to open the **PDF Viewer**.  
In the **PDF Viewer** window, the PDF is opened with all the structured fields highlighted in purple dotted rectangles.
  8. Select the rectangular area of the field to be extracted and click **Add field** to add the field and its value under the **Extract fields** table.
  9. Optional: You can add an unstructured field that are not highlighted in the PDF. Select the **Draw a region** option available at the top of the PDF viewer and draw a rectangle box around the required region.  
A red colored dotted rectangle is highlighted with an option **Add custom region**.
  10. Click **Add custom region** to view the captured coordinates in the **Custom region** window. Enter the **Key name** that can be used in the output variable.
- 

**Note:** While extracting PDF text with the **Draw a region > Add custom region** option, ensure the PDF data is in sequential order and has standard font encoding for correct data extraction. Data without encoding such as data from scanned files and images will not be extracted.

---

11. Click **Close** to add the field in the **Extract fields** table.
-

The list of extracted fields appear under the **Extract fields** table on the right panel of **PDF viewer** window.

The extracted fields change to blue dotted rectangles in the PDF viewer. You can edit the extracted fields by selecting the blue rectangle around the field.

Use the vertical ellipse button next to the extracted field in the **Extract fields** table to **Edit**, **Move** or **Delete** the field.

12. Click **Close** to close the PDF viewer .
13. From the **Save the output to a variable** field, choose either a dictionary variable or multiple variables to hold the field values.
14. Click **Save**.

## Using Extract text action from PDF

Extract text from a PDF file and save it as a text file by using the **Extract text** action.

---

### Important:

- If the correct fonts are not embedded in the PDF file, the **Extract text** action does not extract the text correctly.
  - When you use this action to extract text from a PDF file, and if that text is a single line data but the PDF file has the same data in two lines, then the data might appear in two lines.
- 

**Note:** When you extract fields from a PDF that contains 20 form fields, processing time might be 30 to 40 % longer than PDFs without form fields.

---

To extract text from a PDF file, perform the following steps:

1. In the **Actions** palette, double-click or drag the **Extract text** action from the **PDF** package.
2. In the **PDF path**, select one of the following options to specify the location of the PDF:
  - **Control Room file:** Enables you to select a PDF file that is available in a folder in the Control Room.
  - **Desktop profile:** Enables you to select a PDF file that is available on your device.
  - **Variable:** Enables you to specify the file variable that contains the location of the PDF file.
3. Optional: In the **User password** or **Owner password** field, enter a password to restrict access to the encrypted PDF file.
  - **User password:** Allow users to perform specific operations on the encrypted PDF file.
  - **Owner password:** Allow users to use a password to open the file.
4. In the **Text type** field, select one of the following options:
  - **Plain text:** Extract the text and copy it to a text file.

This works similar to copying and pasting text from a PDF file to a text file.
  - **Structured text:** Preserve the original formatting of the text extracted from the PDF file.

You can select the **Reduce Data Loss** option to ensure that the complete text is extracted with minimal overlap of characters. With this functionality, the number of characters overlapped by other characters is reduced.

**Note:** When you select this option to extract text, the extracted text might contain extra space characters.

---

5. In the **Page range** field, select one of the following options:
  - **All pages:** Enables you to save all the pages in the PDF file as an image.
  - **Pages:** Enables you to enter the page numbers of the pages that you want to save as an image.

6. In the **Export data to text file** field, specify a name and location for the text file.

**Note:** You must include the .txt extension in the name of the text file. For example, if the file name is `June_Quarter_report`, the .txt extension is `June_Quarter_report.txt`.

---

7. Select the **Overwrite files with the same name** check box to overwrite existing files with the same name.

**Note:** If this option is not selected and the bot encounters a file with the same name at the specified location, the bot will fail.

---

8. Optional: From the **Assign PDF properties to a dictionary variable** list, select a dictionary variable to hold the file properties.

For more information, see [Using a dictionary variable for PDF properties](#) on page 2888.

9. Click **Save**.

## Using the Extract image action

Use the **Using Extract image** action to save a PDF file as an image.

To save a PDF file as an image, follow these steps:

1. In the **Actions** palette, double-click or drag the **Extract image** action from the **PDF** package.
2. In the **PDF path**, select one of the following options to specify the location of the PDF:
  - **Control Room file:** Enables you to select a PDF file that is available in a folder in the Control Room.
  - **Desktop profile:** Enables you to select a PDF file that is available on your device.
  - **Variable:** Enables you to specify the file variable that contains the location of the PDF file.
3. Optional: In the **User password** or **Owner password** field, enter a password to restrict access to the encrypted PDF file.
  - **User password:** Allow users to perform specific operations on the encrypted PDF file.
  - **Owner password:** Allow users to use a password to open the file.
4. In the **Page range** field, select one of the following options:
  - **All pages:** Enables you to save all the pages in the PDF file as an image.
  - **Pages:** Enables you to enter the page numbers of the pages that you want to save as an image.
5. In the **Type of image to be converted to** list, select one of the following options to specify the format:

- **TIFF:** If you selected this option, select an option from the **TIFF compression type** list.
    - **NONE**
    - **LZE**
    - **RLE**
    - **CCITT Group 3**
    - **CCITT Group 4**
  - **BMP**
  - **JPEG:** If you selected this option, in the **JPEG quality** field, enter a value (between 0 and 100) to specify the quality of the compressed image.
  - **GIF**
  - **PNG**
  - **WMF**
  - **EMF**
  - **EXIF**
6. In the **Folder path** field, specify the location.
7. In the **File prefix** field, enter a value.  
The image files are suffixed with index numbers. For example, if you have specified Report as the **File prefix**, the name of the image files will be Report\_1, Report\_2, and so on.
8. Select the **Overwrite files with the same name** check box to overwrite existing files with the same name.

---

**Note:** If this option is not selected and the bot encounters a file with the same name at the specified location, the bot will fail.

---

9. In the **X Resolution (dpi)** and **Y Resolution (dpi)** fields, specify the resolution.
10. In the **Image output** field, choose **Color** or **Grayscale** to specify the image output type:
- a) In the **Color property** list, select an option.
- **True color (32 bits)**
  - **True color (24 bits)**
  - **High color (16 bits)**
  - **56 color (8 bits)**
  - **16 color (4 bits)**
  - **2 color (1 bit, black/white)**

---

**Note:** This option is available only with the **Color** image output type. Select this option only if **RLE**, **CCITT Group 3**, or **CCITT Group 4** compression type is selected for the **TIFF** image format.

---

11. Optional: From the **Assign PDF properties to a dictionary variable** list, select a dictionary variable to hold the file properties.  
For more information, see [Using a dictionary variable for PDF properties](#) on page 2888.
12. Click **Save**.

## Using the Decrypt document action

Use the **Decrypt document** action to decrypt a PDF file that was previously encrypted using the **Encrypt document** action.

To decrypt an encrypted PDF file, follow these steps:

1. In the **Actions** palette, double-click or drag the **Decrypt document** action from the **PDF** package.
2. In the **PDF path**, select one of the following options to specify the location of the PDF:
  - **Control Room file**: Enables you to select a PDF file that is available in a folder in the Control Room.
  - **Desktop profile**: Enables you to select a PDF file that is available on your device.
  - **Variable**: Enables you to specify the file variable that contains the location of the PDF file.
3. Optional: In the **User/Owner password** field, enter a password to restrict access to the decrypted PDF file.
4. In the **Save the decrypted PDF file as** field, specify a name and location for the decrypted file. You must include the .pdf extension in the name of the decrypted file. For example, if the file name is `June_Quarter_report`, the .pdf extension is `June_Quarter_report.pdf`.
5. Select the **Overwrite files with the same name** check box to overwrite existing files with the same name.

---

**Note:** If this option is not selected and the bot encounters a file with the same name at the specified location, the bot will fail.

---

6. Optional: From the **Assign PDF properties to a dictionary variable** list, select a dictionary variable to hold the file properties.  
For more information, see [Using a dictionary variable for PDF properties](#) on page 2888.
7. Click **Save**.

Related tasks

[Using the Encrypt document action](#) on page 2880

Use the **Encrypt document** action to encrypt a PDF file.

## Using the Get property action

Use the **Get property** action to obtain the properties of the PDF document.

1. In the **Actions** palette, double-click or drag the **Get property** action from the **PDF** package.
2. In the **PDF path**, select one of the following options to specify the location of the PDF:
  - **Control Room file**: Enables you to select a PDF file that is available in a folder in the Control Room.
  - **Desktop profile**: Enables you to select a PDF file that is available on your device.
  - **Variable**: Enables you to specify the file variable that contains the location of the PDF file.
3. From the **File is protected** field, select **Yes** if the file is encrypted and provide the **User password** or **Owner password**.
4. From the **Assign PDF properties to a dictionary variable** field, choose either a dictionary variable or multiple variables to hold the field values.

To assign the output to a dictionary variable, map the PDF properties such as **File**, **Author**, **Title**, and **Subject** to the corresponding dictionary keys.

5. Click **Save**.

## Using the Merge documents action

Use the **Merge documents** action to merge multiple PDF files into a single PDF file.

1. In the **Actions** palette, double-click or drag the **Merge documents** action from the **PDF** package.
2. Click **Add PDF document** to provide details on the first PDF file.  
The **Add PDF document** window appears.
3. In the **PDF path**, select one of the following options to specify the location of the PDF:
  - **Control Room file**: Enables you to select a PDF file that is available in a folder in the Control Room.
  - **Desktop profile**: Enables you to select a PDF file that is available on your device.
  - **Variable**: Enables you to specify the file variable that contains the location of the PDF file.
4. Optional: In the **User password** or **Owner password** field, enter a password to restrict access to the encrypted PDF file.
  - **User password**: Allow users to perform specific operations on the encrypted PDF file.
  - **Owner password**: Allow users to use a password to open the file.
5. In the **Page range** field, select one of the following options:
  - **All pages**: Selects all the pages in the PDF file.
  - **Pages**: Enter the page numbers of the pages that you want to merge.

---

**Note:** If you entered 1-3, 5-7, 8, 10 or 10, 8, 5-7, 1-3 in Enterprise 11, the output was pages 1,2,3,5,6,7,8,10. In Automation 360, if you enter the input as follows:

- In ascending order 1-3, 5-7, 8, 10, the output of the pages is 1,2,3,5,6,7,8,10
  - In descending order 10, 8, 5-7, 1-3, the output of pages is 10,8,5,6,7,1,2,3
- 

6. Click **Yes, Add**.
7. Repeat Steps 2 through 6 to provide details on additional PDF files.  
To modify the details of, or delete a PDF file, open the actions menu (the vertical ellipsis to the right of the file).
8. Place the files in the order that they should appear in the merged file.  
To move a file, open the actions menu. Then use the **Move up** or **Move down** options.
9. In the **Output file path** field, specify a name and location for the merged file.  
You must include the .pdf extension in the name of the decrypted file. For example, if the file name is `June_Quarter_report`, the .pdf extension is `June_Quarter_report.pdf`.
10. Select the **Overwrite files with the same name** check box to overwrite existing files with the same name.

---

**Note:** If this option is not selected and the bot encounters a file with the same name at the specified location, the bot will fail.

---

11. Click **Save**.

## Using the Split document action

Use the **Split document** action to split a PDF file into multiple files.

To split a PDF file into multiple files, follow these steps:

1. In the **Actions** palette, double-click or drag the **Split document** action from the **PDF** package.
2. In the **PDF path**, select one of the following options to specify the location of the PDF:
  - **Control Room file**: Enables you to select a PDF file that is available in a folder in the Control Room.
  - **Desktop profile**: Enables you to select a PDF file that is available on your device.
  - **Variable**: Enables you to specify the file variable that contains the location of the PDF file.
3. Optional: In the **User password** or **Owner password** field, enter a password to restrict access to the encrypted PDF file.
  - **User password**: Allow users to perform specific operations on the encrypted PDF file.
  - **Owner password**: Allow users to use a password to open the file.
4. In the **Output file creation options**, select one of the following options to specify how to split the PDF file:
  - **Number of pages per extracted PDF**: Enables you to specify the number of pages each new file will contain. For example, you can enter 8 if you want each output file to contain only 8 pages.
  - **Single file with selected pages**: Enables you to create a single output file that contains the pages you have specified from the original file.
  - **Blank page as a separator**: Creates a new output file whenever a blank page is encountered in the original PDF file.

PDF split separates a blank page from pages with scanned images.
  - **Bookmark level per file**: Enables you to split the PDF file according to the bookmark level available in the file. For example, if a file contains three bookmark levels, you can split the PDF file based on these three levels.

If you selected this option, specify the bookmark level in the **Bookmark Level** field.
5. In the **Folder path** field, specify the location.
6. In the **File prefix** field, enter a value.

The image files are suffixed with index numbers. For example, if you have specified **Report** as the **File prefix**, the name of the image files will be **Report\_1**, **Report\_2**, and so on.
7. Select the **Overwrite files with the same name** check box to overwrite existing files with the same name.

---

**Note:** If this option is not selected and the bot encounters a file with the same name at the specified location, the bot will fail.

---

8. Optional: From the **Assign PDF properties to a dictionary variable** list, select a dictionary variable to hold the file properties.

For more information, see [Using a dictionary variable for PDF properties](#) on page 2888.

9. Click **Save**.

## Using a dictionary variable for PDF properties

When you automate a PDF-related task, Automation Workspace retrieves various properties of the file and stores the values of these properties in a dictionary variable.

Automation Workspace retrieves the PDF file name and extension, title, subject, and author. The file properties are stored in a dictionary variable within the following keys:

- pdfTitle
- pdfFilename
- pdfSubject
- pdfAuthor

The system automatically associates the properties of a PDF with the appropriate dictionary keys.

For example, if you create a dictionary variable `Test` and want to log the file name and author, you must enter `Test{pdfFilename}` and `Test{pdfAuthor}` in the appropriate fields.

## PGP package

Use the PGP (Pretty Good Privacy) package to automatically encrypt and decrypt files for security.

The PGP package supports two types of encryption, symmetric (single key) and asymmetric (pair of keys) :

- **PGP symmetric** : Requires a single key to encrypt and decrypt files.
- **PGP asymmetric**: Requires PGP public and private key to encrypt and decrypt files.

---

**Note:** The system outputs an error when the proper file extension is not present in the path.

- Public key: File name specified for Public Key is not valid.
  - Private key: File name specified for Private Key is not valid.
- 

## Actions in the PGP package

The PGP package includes the following actions:

Action	Description
Create keys	See <a href="#">Create keys action in PGP</a> on page 2889.
Decrypt files	Decrypts encrypted files. See <a href="#">Using the Decrypt files action</a> on page 2889
Encrypt files	Encrypts files to enable users to send them over the internet securely. See <a href="#">Using the Encrypt files action</a> on page 2890



Related reference

[PGP package updates](#) on page 925

Review the updates in released versions of the PGP package such as new and enhanced features as well as fixes and limitations. The page also lists the release dates of each version, and the compatible Control Room and Bot Agent versions.

## Create keys action in PGP

Use the **Create keys** action in the PGP package to create a pair of public and private encryption keys.

### Settings

- In the **Location to save public key file** field, specify the path to the text file where to save the public key.
- In the **Location to save private key file** field, specify the path to the text file where to save the private key.
- In the **Password to protect private key file** field, select a credential variable or enter a value.
- Select the **Overwrite files with the same file name** check box to replace files with the same name.

## Using the Decrypt files action

Use the **Decrypt files** action to retrieve the contents of encrypted files and folders.

To decrypt a file or folder, do the following steps:

1. Double-click or drag the **Decrypt** action from the PGP package.
2. Select either the **Passphrase** or **Public key file** encryption type.
  - If you have selected **Passphrase**, enter the value or select a credential variable.
  - If you have selected **Private key file**, provide the private key file path.

Optional: In the **Password to protect private key file** field, select a credential variable or enter a value.
3. In the **Source folder/file(s)** field, specify the folders or files to decrypt.

This field supports wildcard characters in the file name and extension. Use an asterisk (\*) to substitute for one or more unknown alphanumeric characters or symbols.
4. In the **Destination folder/file(s)** field, specify the location where to save the decrypted folders and files.

This field supports wildcard characters in the file name and extension. Use an asterisk (\*) to substitute for one or more unknown alphanumeric characters or symbols.
5. Select the **Overwrite Files** option to replace files with the same name.
6. Select the **Remove file extension** option and specify the extension name.
7. Click **Save**.

## Using the Encrypt files action

Use the **Encrypt files** action to prepare files and folders to be shared securely.

To encrypt the files or folder using a public key, create a public-private key pair using the **Create keys** action.

To encrypt a file or folder, do the following steps:

1. Double-click or drag the **Encrypt** action from the PGP package.
2. Select either the **Passphrase** or **Public key file** encryption type.
  - If you have selected **Passphrase**, enter the value or select a credential variable.
  - If you have selected **Public key file**, provide the public key file path.
3. Select the **Encryption algorithm**.  
Choose from:
  - AES128
  - AES192
  - AES256
  - Blowfish
  - CAST5
  - Idea
  - TripleDES
  - TwoFish256
4. In the **Source folder/file(s)** field, specify the folders or files to encrypt.  
This field supports wildcard characters in the file name and extension. Use an asterisk (\*) to substitute for one or more unknown alphanumeric characters or symbols.  
For example:
  - Enter `C:\PGP\encrypt*.csv` to select the .csv files that start with the word encrypt.
  - Enter `C:\PGP\*encrypt*.*` to select files of any extension that contain the word encrypt.
5. In the **Destination folder/file(s)** field, specify the location where to save the encrypted folders and files.  
This field supports wildcard characters in the file name and extension. Use an asterisk (\*) to substitute for one or more unknown alphanumeric characters or symbols.
6. Enter a value to append to the extension of the destination file.
7. Select the **Overwrite Files** check box to replace files with the same name.
8. Select the **Compression type**.  
Choose from:
  - None
  - zip
  - bzip2
  - zlib
9. Select the **Armor data (text output)** check box to enable ASCII Armor output.
10. Click **Save**.

## Play Sound package

The Play Sound package contains actions that enable you to play a beep sound and media file before or after an action is executed in a bot.

The Play Sound package includes the following actions:

Action	Description
Play beep	See <a href="#">Play beep action</a> on page 2891.
Play media file	See <a href="#">Play media file action</a> on page 2891.

Related reference

[Play Sound package updates](#) on page 928

Review the updates in released versions of the Play Sound package such as new and enhanced features as well as fixes and limitations. The page also lists the release dates of each version, and the compatible Control Room and Bot Agent versions.

## Play beep action

The **Play beep** action enables you to play a beep sound before or after an action is executed.

## Play media file action

The **Play media file** action enables you to play an audio file before or after an action is executed.

## Settings

From the **Select a file to play** field, select one of the following tabs to specify the location of the media file:

- **Control Room file:** Use a file that is available on the Control Room.
- **Desktop file:** Use a file that is available on a device.
- **Variable:** Use a variable to specify the file location.

---

**Note:** Only `.wav` and `.mp3` files are supported and do not require any media player installed on the device.

---

## Printer package

Use the actions in the Printer package to automate retrieving and setting the default printer and removing a printer from the list of available printers.

## Actions in the Printer package

The Printer package includes the following actions:

Action	Description
Get Default	See <a href="#">Get default action</a> on page 2892.
Remove	See <a href="#">Remove action</a> on page 2892.
Set Default	See <a href="#">Set default action</a> on page 2892.

Related reference

[Printer package updates](#) on page 929

Review the updates in released versions of the Printer package such as new and enhanced features as well as fixes and limitations. The page also lists the release dates of each version, and the compatible Control Room and Bot Agent versions.

## Get default action

The **Get default** action enables you to retrieve the default printer and assign a value to a string variable.

### Settings

- Click the **Select the destination string variableChoose a variable** drop-down menu to select a variable.
- (Optional) Click **Create variable** icon if you do not have an existing variable.

## Remove action

The **Remove** action enables you to delete or remove a printer.

### Settings

- Click the **Enter the printer name** drop-down menu to view a list of available printers, and select a printer that you want to remove.
- (Optional) If the available printers are not listed, click the **Refresh options** icon.

## Set default action

The **Set default** action enables you to set a default printer.

### Settings

- Click the **Enter the printer name** drop-down menu to view a list of available printers, and select a printer that you want to set as the default one.
- (Optional) If the available printers are not listed, click the **Refresh options** icon.

## Process Composer package

This package contains actions that enable you to configure bots to work on requests, tasks, and team members.

---

**Note:** The Process Composer package was previously known as AARI Web package.

---

### Before you start

Ensure you have met one of the following conditions in order to run this package:

Condition 1

- Access to a process in an assigned team.
- Access to an AARI User license.
- A system-created **AAE\_Robotic\_Interface User** role for the AARI User.

Condition 2

- Access to a Bot Runner license (Attended or Unattended) or Bot Creator license.
- A user-created role with the **View My Bots** and **Run My Bots** permissions.

### Actions in the Process Composer package

The Process Composer package includes the following actions:

Action	Description
Assign Human Task	See <a href="#">Assign Human Task action</a> on page 2894.
Cancel Human Task	See <a href="#">Cancel Human Task action</a> on page 2894.
Create a Request	See <a href="#">Create a Request action</a> on page 2895.
Get Storage file	See <a href="#">Get Storage file action</a> on page 2897.
Query Requests	See <a href="#">Query Requests action</a> on page 2897.
Query Human Tasks	See <a href="#">Query Human Tasks action</a> on page 2899.
Team Members	See <a href="#">Team Members action</a> on page 2900.
Upload Storage file	See <a href="#">Upload Storage file action</a> on page 2901.

## Assign Human Task action

Assigns a specific task to a specified user.

### Settings

- In the **Task ID to be assigned** field, select the variable of the Human Task. Find the Task ID as an output from the Query Task action.
- In the **User ID to assign to task** field, select the variable of the user. Find the User ID as an output from the Query Member action.

For the task and user ID, you can select a value from the **Variable** or **Global value** options.

- Optional: In the **Assign the result to variable** field, assign a variable to store as an output. The output is stored as a string value.

## Cancel Human Task action

This action cancels a human task. Some configuration is required.

### Settings

The cancel action is only valid when the form of the human task has a button of type **Cancel**. The user then has the control when running the task to cancel the form.

---

**Note:** Although the cancel button ends the form, to cancel the process you should use if/else logic to move the process to the end point when cancel is selected.

---

The screenshot shows the 'Upload file to storage process' configuration window. On the left, the 'Elements' palette lists various task types, with 'Form' highlighted. The central canvas shows a process flow starting with 'Start', followed by a 'Form Task' (Human-task-form), then a 'Bot Task' (Upload-bot), then another 'Form Task' (Human-task-display), and finally 'Completed'. The right-hand panel, titled 'Task: Form', contains the following configuration options:

- Element name:** Human-task-form
- Task name:** Business Task (x)
- Hide this task after completion
- Make the form read-only
- Task requester and assignment:** Default (Custom)
- Show this task in "Requested" task list for the request creator
- Task contributor:** Manually assigned
- Select form:** file-renderer (Browse)
- Task expiration time:** No expiration
- Data privacy tag (optional):** (x)
- Add form button:**

Button label	Button style
Cancel task	Cancel

- In the **Task ID to cancel** field, specify a value.  
For the task, you can select a value from the **Variable** or **Global value** options. The variable option enables you to add predefined variables.
- Optional: In the **Assign the result to variable** field, assign a variable to store as an output.  
The output is stored as a string value.

## Create a Request action

Creates a request with input values.

### Settings

- In the **Actions** palette, double-click or drag the **Create a Request** action from the **Process Composer** package.

- In the **Public Process** field, browse and select the public process. The initial form fields from the process are displayed in the **Input values** field. These fields are from supported interactive form elements.
- In the **Input values** field, enter the values or variables to complete the required information to the initial form.

---

**Note:** For passing the values through variables, create a custom variable of any type: **String**, **Number**, **Datetime**, **Boolean**, **Dictionary**, **Table**, or **File**. Use the **Dictionary** variable for completing the check box information in the initial form. Enter the variable information in the **Type**, **Subtype**, **Key**, and **Value** fields. In the **Subtype** field, choose **Boolean**. Follow the format convention while creating **Dictionary** variables.

For example, consider the check box attributes as San Jose, Atlanta, and Sacramento, and we want to select the value Atlanta in the initial form field. Create a **Dictionary** variable of subtype **Boolean** in the format as follows:

Name: CheckBoxGroup0

Attributes	Key	Value
San Jose	CheckBoxGroup0_0	false
Atlanta	CheckBoxGroup0_1	true
Sacramento	CheckBoxGroup0_2	false

---

**Note:** When passing values of a table, the schema of the input table and schema of the initial form (in the process) needs to be the same for the bot to execute.

- Optional: In the **Assign the Request ID to** field, assign a variable to store as output. This returns the ID of the created request.
- Optional: In the **Assign the Request Reference to** field, assign a variable to store as output. This returns the ID of the request that was created.
- Click **Save**.

---

**Note:**

To configure that the request be created by a bot or a user, you select the **Request creation** field. This field is available when you edit the process containing the request. To edit a process, navigate to **Manage > Process** and select the process you want to edit. This opens the **Edit Process** page in the **General** tab. Towards the bottom of the page, you can set to have the request created by a bot or a user. For more details, see [Configure a process](#) on page 3398.

---

To learn how to create a request action, click [Example of using Create a Request action](#) on page 2901.



## Get Storage file action

Downloads a storage file to a local device from a specified path.

### Settings

---

**Important:** The Get Storage file action requires the matching of versions between the process version and the package version. Processes created before Automation 360 v.25 must be used with package versions from before Automation 360 v.25. Similarly, processes created after Automation 360 v.25 must be used with package versions after Automation 360 v.25.

---

- Specify the storage file URI in the **Variable** field.

Enter your file input variable.

---

**Note:** You must only use the **Variable** option and the variable must be a file input that is populated from the process (**Select File** in **Human Task**). Do not use the **Control Room file** and **Desktop file** options.

---

- In the **Full path of file in local device to be saved to**, specify the path to store your file.

You can select from **Variable** or **Global value** option. The variable option enables you to add a user-defined value, clipboard, string (enter, newline, separate, etc), system (task name, control room URL, etc), predefined variable package (date, minute, day, time, IP address, operating system, etc), or table analytic value.

- Optional In the **Result** field, choose a variable.

The output is stored as a variable.

## Query Requests action

Create custom filters with sorting capabilities for requests.

### Settings

---

- Select a filter.
- 

**Note:** The filters for process and request titles, tags, IDs, team name, and PII tags have the same list of options.

---

- Specify the string value in the **List** or **Variable** field.
  - Specify your type in the **List** or **Variable** field.
  - **List:** Input your value information in the **Type** and **Value at 0** fields.
  - Optional: In the **Add** field, add more values.
  - **Variable:** Enter your custom variable.
- In the **Request Status** field, select a status.

You can choose **OPENED**, **SUCCESS**, **ERROR**, and **CANCELLED**
- In the **Page** field, specify a value.

- In the **Table start at offset of data** field, enter a value.
- In the **Number of rows per page** field, enter a value.  
The default value is set **200** for number of rows.
- In the **Sort** field, specify the option.
  - In the **Direction** field, select **Descending** or **Ascending**.  
The default value is set to **Descending** for the direction.
  - In the **Select sort column** field, select an option.  
You can choose between process title or the request creation, ID, title, status, or PII tag.
  - Select the **Enable 2nd degree sort** and specify the **Direction** and **Select sort column** fields.
- In the **Assign the result to variable** field, assign a variable to store as an output.  
The output is stored as a table value.

As a result of the Query Requests action, a table is returned. The following table lists the table column names and the order in which they are returned for further extraction:

Table 5: Table column names

Index	Column name
0	Request-ID
1	Request-Status
2	Request-Title
3	Request-Pii-Tag
4	Request-Full-Name
5	Process-Title
6	Created-Date
7	Updated-Date
8	Request-Ref
9	Created-By
10	Created-By-User-Group
11	Team-Name

## Query Human Tasks action

Create custom filters with sorting capabilities for tasks.

### Settings

This action calls and displays the tasks from your instance of Automation Co-Pilot based on the filter you configure in this action. Select the options to configure the filter that will display your desired results.

- **Request titles:** filter results by matching titles to the entered value.
- **Names of Teams that handle the Request:** filter results by matching the name of Teams to the entered value.
- **Request Refs matching exact string:** filter results by matching the reference ID of the request to the exact entered value. Optionally, enter multiple values separated by commas.
- **Request Refs:** filter results by matching the reference ID of the request to any value of the entered sub-strings. Optionally, enter multiple values separated by commas.
- **Task IDs:** filter results by matching the task ID to any value of the entered numbers.
- **Task State:** filter results by matching the status of the task (in progress or complete).
- **Task Pii Tag:** filter results by matching the Pii tag to any value of the entered strings.
- **Assignee IDs:** filter results by matching the ID of the task assignee to any value of the entered numbers.
- **Task titles:** filter results by matching the title of the task to any value of the entered strings.
- **Page:** filter results by matching a table of a task page to the entered table structure.
- **Sort:** configure how the results should be sorted upon display.

As a result of the Query Human Tasks action, a table is returned. The following table lists the table column names and the order in which they are returned for further extraction:

Table 6: Table column names

Index	Column name
0	Task-ID
1	Task-Status
2	Task-Title
3	Task-Assignee
4	Task-Pii-Tag
5	Request-ID
6	Request-Title
7	Process-ID
8	Created-Date
9	Updated-Date
10	Task-Sub-Status

Index	Column name
11	Created-By
12	Task-Type
13	Task-Sub-Type
14	Created-By-User-Group
15	Team-Name
16	Workspace-Type
17	Request-Ref

## Team Members action

Retrieves a the list of members in a team.

### Settings

- In the **Supply team ID to query it's members** field, specify a value.

For the supply team ID, you can select a value from the **Variable** or **Global value** options. The variable option enables you to add predefined variables ranging from time (minute, hour, day, month, year, etc) or system usages (CPU and RAM).

- In the **Supply team reference to query its members** field, specify a value.

For the supply team reference, you can select a value from the **Variable** or **Global value** options. With the variable option, you can add predefined variables ranging from time (minute, hour, day, month, year, and so on) or system usages (CPU and RAM).

- In the **Assign the result to variable** field, assign a variable to store as an output.

The output is stored as a table value.

## Upload Storage file action

Maps a file to use in a process automation.

### Settings

When using this action, the following best practices should be used. The image demonstrates these best practices in configurations.

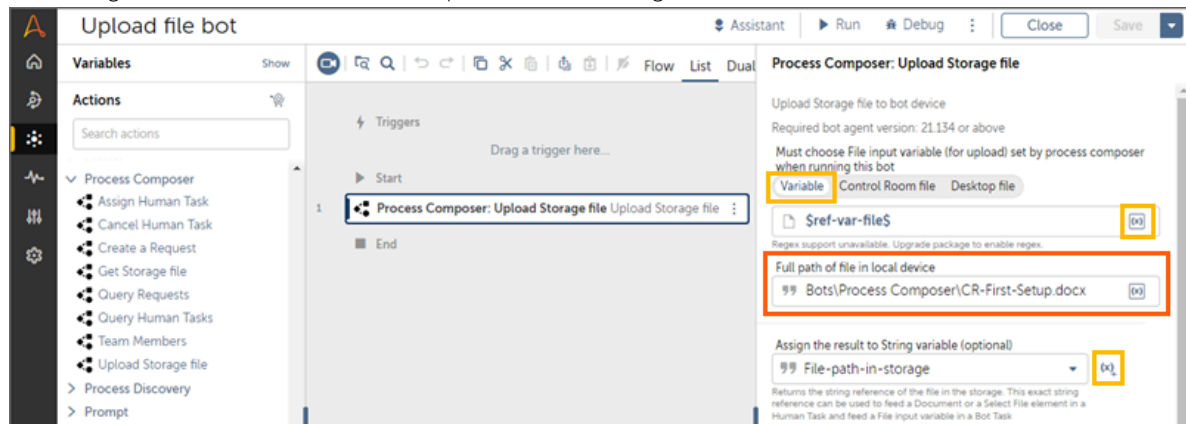

- The file should first be saved as a variable using **File** type and marked as **input**. This variable is then selected as the **File input variable** for the action.

**Note:** Variable is the only valid option. The file is stored in the bot run device through this predefined variable.

- Enter the full path of the exact location of the file on the desktop or local device.
- Assign the result as a string variable that holds the storage path for the file after upload. This output variable must be string and should be used to feed a Select File element of a form or another File input variable of a bot.
- Most major MIME types are supported some among them are: png, jpeg, csv, xls, pdf, exe, dll.

See, [Example: Use Select File to upload or download a file for web](#) on page 3473.

## Example of using Create a Request action

The **Create a Request** action from the Process Composer package enables you to create a new request in Automation Co-Pilot on the web through a bot. In this example, use the **Create a Request** action to pass data through bot variables to initial form of the process.

- You must have a Bot Creator license and be assigned a custom role with the following permissions:
  - Check-in and check-out permission
  - Create folder permission
- Create a process and check-in the process to the public workspace
- Assign at least one team to the process with the default team selected
- Select the **by bot** option in the **Request creation** field

**Note:**

The **Request creation** field is available when you edit the process containing the request. To edit a process, navigate to **Manage > Process** and select the process you want to edit. This opens the **Edit Process** page in the **General** tab. Towards the bottom of the page, you can set to have the request created by a bot. For more details, see [Configure a process](#) on page 3398.

In this example, we will create a process to register new employee details in the company database. The initial form contains basic information such as Name, ID, Date of Birth, Gender, and Location. We will pass the initial form data through bot variables.

1. Log in to the Control Room as a Bot Creator user.
2. Create the initial form.
  - [Create a form](#) on page 3438.
  - a) On the left plane, click **Automation**.
  - b) Click **Create new > Form**.
  - c) Enter the form name `employee_register_initial_form`.
  - d) Enter the folder location `Bots\Employee Registration`.  
To change where your form is stored, click **Choose** and follow the prompts.
  - e) Click **Create & edit**.
  - f) Use the following **Elements** and **Element label** in the form.

Elements	Element label
<b>TextBox</b>	Full Name
<b>Number</b>	ID
<b>Date</b>	Date of Joining
<b>Dropdown</b>	Gender
<b>Checkbox</b>	Location
<b>Select File</b>	Resume

- For the **Dropdown** element, enter `Male, Female` in the **Enter list items separated by commas** field.
  - For the **Checkbox** element, click the **plus** icon in **Checkbox content** field and add the locations `San Jose, Tokyo, India`.
  - For the **Select File** element, you can limit the file type which can be uploaded by specifying it in the **Enter supported file format separated by commas** field. For example; `doc, gif, pdf, png, txt, xls`.
- g) Click **Save**.
  - h) Click **Close**.
3. Create a new process.
    - a) In the same folder location, click **Create new > Process**.  
[Create a process automation in Process Composer](#) on page 3454.

- b) Enter the process name `employee_register`.
- c) Click **Create & edit**.
- d) Click **Start** to add an initial form to the process.
- e) In the **Select initial data form** field, browse and select the initial form, `employee_register_initial_form`.
- f) Select **AARI Storage** in the **File upload storage** dropdown.
- g) Provide **Request title** as `Employee Registration`.
- h) Click **Save**.
- i) Click **Close**.
- j) Check in this process to the public workspace.

4. Create a new bot.

- a) In the same folder location, click **Create new > Bot**.
- b) Enter the bot name `employee_register_request_bot`.
- c) Click **Create & edit**.

5. Create the following variables:

- `emp_name`: String type; use as input.
- `emp_id`: Number type; use as input.
- `emp_date_of_joining`: Datetime type; use as input.
- `emp_gender`: String type; use as input.
- `emp_location`: Dictionary type, Boolean subtype; use as input. From the check box attributes given above, if you want to select the value San Jose for the location attribute in the initial form field, click the **plus** and create the dictionary variable in the format as given below:

Name: `emp_location`

Attributes	Key	Value
San Jose	<code>CheckBoxGroup0_0</code>	True
Tokyo	<code>CheckBoxGroup0_1</code>	False
India	<code>CheckBoxGroup0_2</code>	False

- `emp_resume`: File type; use as input, select **Desktop folder or file** for the **Default value** and browse and select the file you want to upload.
- `employee_registration_request_id`: Number type; use as output.

6. Use the **Create a Request** action from Automation Co-Pilot Web package.

- a) In the **Actions** palette, double-click or drag the **Create a Request** action from the **Process Composer** package.
- b) In the Public Process field, browse and select the public process `employee_register`. The initial form fields from the process are displayed in the **Input values** field. These fields are from supported interactive form elements.

c) In the **Input values** field, enter the values or variables to complete the required information to the initial form as given below:

- emp\_name: \$emp\_name\$
- emp\_id: \$emp\_id\$
- emp\_date\_of\_joining: \$emp\_date\_of\_joining\$
- emp\_gender: \$emp\_genders\$
- emp\_location: \$emp\_location\$. To select the location San Jose in the initial form field, add the key and value pair for the attributes as given below:

Attributes	Key	Value
San Jose	CheckBoxGroup0_0	True
Tokyo	CheckBoxGroup0_1	False
India	CheckBoxGroup0_2	False

- emp\_resume: \$emp\_resume\$
- employee\_registration\_request\_id: \$employee\_registration\_request\_id\$

d) Click **Save**.

e) Click **Close**.

7. Deploy the bot.

a) Click **Run**.

b) In the **Set input variables** field, enter the values for the input variable.

c) Click **Confirm**.

The bot deploys successfully and a new request is created through the default team assigned to the process. The initial form fields are filled with the input provided through the bot. In the web interface, an Automation Co-Pilot admin can verify that a new request is created, and the data has been selected properly.

## Process package

The **Process** package contains a request action that enables the Control Room user to use this action and configure their bots.

### Before you start

**Note:** The **Process** package has been renamed to the AARI Web package in Enterprise A2019.18 with the **Create a Request** action and additional new actions. The AARI Web package is now renamed to the **Process Composer** package with the same actions, in Enterprise A2019.28. See [Process Composer package](#) on page 2893.

Ensure you have met one of the following conditions in order to run this package:

Condition 1

- Access to a process in an assigned team.



- Access to Automation Co-Pilot User license.
- A system-created **AAE\_Robotic\_Interface User** role for the Automation Co-Pilot user.

Condition 2

- Access to a Bot Runner license (Attended or Unattended) or Bot Creator license.
- A user-created role with the **View My Bots** and **Run My Bots** permissions.

## Actions in the Process package

The **Process** package includes the following action:

Action	Description
Create a Request	<p>Creates a request.</p> <ul style="list-style-type: none"> <li>• In the <b>Select Process</b> field, select or upload your process.</li> <li>• Specify your variable in the <b>Dictionary</b> or <b>Variable</b> field.                             <ul style="list-style-type: none"> <li>• <b>Dictionary:</b> Input your variable information in the <b>Type</b>, <b>Key</b>, and <b>Value</b> fields.                                     <p>In the <b>Type</b> field, you can choose between <b>Any</b>, <b>String</b>, <b>Number</b>, <b>Datetime</b>, or <b>Boolean</b>.</p> </li> <li>• Optional: In the <b>Add</b> field, add more dictionary variables.</li> <li>• <b>Variable:</b> Enter your custom variable.</li> </ul> </li> <li>• Optional: In the <b>Assign the Request ID to</b> field, assign a variable to store as an output.                             <p>The output is stored as an ID value.</p> </li> </ul>

## Prompt package

Use the **Prompt** package to accept an input value, a yes/no response, or to open a file or folder.

### Actions in the Prompt package

The **Prompt** package includes the following actions:

Action	Description
For file	See <a href="#">For file action in Prompt</a> on page 2906.
For folder	See <a href="#">For folder action in Prompt</a> on page 2906.
For value	See <a href="#">For value action in Prompt</a> on page 2906.
For yes/no	See <a href="#">For yes/no action in Prompt</a> on page 2907.

Related reference

[Message box package](#) on page 2796

Use the **Message box** action from the **Message box** package to insert a message box that shows a message when the task runs. For example, you can insert a **Message Box** action to follow a web form so that the action displays the message: `Web Form Filled and Complete`.

[Prompt package updates](#) on page 931

Review the updates in released versions of the Prompt package such as new and enhanced features as well as fixes and limitations. The page also lists the release dates of each version, and the compatible Control Room and Bot Agent versions.

## For file action in Prompt

The **For file** action in the **Prompt** package prompts you to select a single or multiple files on bot execution.

### Settings

- In the **Prompt window caption** field, enter a window caption.
- In the **Prompt message** field, enter a message.
- In the **Assign the value to a variable** field, specify a list variable.

## For folder action in Prompt

The **For folder** action in the **Prompt** package prompts you to choose a folder.

### Settings

- In the **Prompt window caption** field, enter a window caption.
- In the **Prompt message** field, enter a message.
- In the **Assign the value to a variable** field, specify a variable.

## For value action in Prompt

The **For value** action in the **Prompt** package prompts you to enter a value.

### Settings

- In the **Prompt window caption** field, enter a window caption.
- In the **Prompt message** field, enter a message.
- In the **Assign the value to a variable** field, specify a variable.

## For yes/no action in Prompt

The **For yes/no** action in the **Prompt** package prompts you to choose a Yes/No response.

### Settings

- In the **Prompt window caption** field, enter a window caption.
- In the **Prompt message** field, enter a message.
- In the **Assign the value to a variable** field, specify a variable.

## Python Script package

The `Python Script` package contains actions that enable Python Script functions in a task.

### Before you start

Ensure the following requirements are met before using the `Python Script` package:

- The appropriate version of Python is installed on the device on which you want to execute the script.

---

**Note:** Python versions 2.x and 3.x are supported.

---

- The "PATH" environment variable is updated to the path of the Python folder.

To verify if the Python environment variable is set correctly, enter `Python` in the command prompt. If it returns the Python version that is installed, the path environment is set up correctly.

Perform the following actions within the `Python Script` package as part of using the set of available actions:

1. Open a Python Script file, or manually enter the script you want to run using the **Open** action. You must associate the details of the file or script you want to run with a session name.
2. Run the script using the **Execute function** or the **Execute script** action. You must use the same Python Script session name established in the **Open** action.
3. Close the Python Script session after running the script.

---

**Note:** When you run a bot that contains Python Script actions, the script runs in the background.

To review the bot launcher logs, navigate to `C:\ProgramData\AutomationAnywhere\BotRunner\Logs\<current month>\Bot_Launcher-<today's date>.log.zip`. Each zipped folder contains a file with data on the code execution, which is useful for debugging.

---

### Actions in the Python Script package

The `Python Script` package includes the following actions:

---

**Note:** The **Open** action must be the first action to use the Python Script in a task. These actions can run a Python Script on Windows, Linux, and UNIX-based devices.

---

Action	Description
Close	See <a href="#">Close action</a> on page 2908.
Execute function	See <a href="#">Execute function action</a> on page 2909. For an example, see <a href="#">Example of using Python script to join a list</a> on page 3209.
Execute script	See <a href="#">Execute script action</a> on page 2909. For an example, see <a href="#">Create a PDF using Python script</a> on page 2910.
Open	See <a href="#">Open action</a> on page 2910.

## More resources

- Free bots that use Python from Bot Store
  - [Python Excel demo](#)
  - [Speech to text using Python](#)
  - [Run Python script](#)
- Developer content on automating with Python: [Automate with Python integration](#)

Related reference

[Python Script package updates](#) on page 932

Review the updates in released versions of the Python Script package such as new and enhanced features as well as fixes and limitations. The page also lists the release dates of each version, and the compatible Control Room and Bot Agent versions.

## Close action

The Close action in the Python Script package closes the session.

## Settings

Specify the same session name from the **Open** action.

---

**Important:** It is mandatory to close the session after the script is executed.

---

## Execute function action

The Execute function action in the Python Script package enables you to execute a function within the Python Script package.

### Settings

- In the Python **session** field, specify a session name. Use the same session name from the **Open** action.
- Specify the function name to run the function.
- Optional: Provide the arguments required for the function while storing the returned values in a variable.

This field supports Boolean, dictionary, list, number, or string variables.

---

**Note:** The interface allows you to select only one argument. Use a list variable to concatenate multiple arguments into one variable.

---

- Optional: In the **Assign the output to variable** field, specify the string variable.

## Execute script action

The Execute script action in the Python Script package enables you to execute a script within the Python Script package.

### Settings

- In the Python **session** field, specify a session name. Use the same session name from the **Open** action.
- Optional: In the **Assign the output to variable** field, specify the string variable.

If the bot executes the script successfully, this action returns the string `True`. Otherwise an error message appears.

The following example shows the difference between the **Execute Script** and **Execute function** actions.

When you open a new Python session, you provide a Python script or file. The script might contain a few lines of code to be executed or might contain a file of functions used to perform certain operations, such as:

```
#executable code flow
file = open("abc.txt", "w")
file.write("Some text")
file.close()

#functions, not in executable flow
def function1():
    return 9+10
```

```
def function2():  
    return "Some Text"  
  
def add(a,b):  
    return a+b
```

- When you use the **Execute script** action, it will only execute the lines of code in the executable flow of the script. Any functions that are defined but not called will not be executed.
- When you use the **Execute function** action, the session can call any function in the script or file, and provide the arguments required for the function while storing the returned values in a variable.

## Open action

The Open action in the Python Script package opens the session.

## Settings

- In the Python **session** field, specify a session name. Use this same session name for other Python Script actions.
- In the Python field, choose one of the following options:
  - In the **Import existing file** option, select an existing Python Script file.

---

**Note:** If you are uploading a script from a file on your desktop, the file and any dependencies must be in a standalone folder. When you select a file for upload, all files and folders at the same folder level are uploaded.

---

- In the **Manual input** option, enter the Python Script.
- In the **Python runtime version** field, select **2** or **3** to specify the runtime version.

---

**Note:** Select the runtime version based on the version of Python installed on the device.

---

## Create a PDF using Python script

Build a bot that runs Python script from a file and generates a PDF.

- To run Python script from Automation 360, you must already have the latest version of Python 3.x installed on your device.
- This example uses the FPDF library to generate the PDF. Therefore, install it before you start building this bot by copying and pasting the following line in the Windows command prompt:

```
pip install fpdf
```

See [FPDF project page](#).

1. Create a file in a standalone folder to hold the following Python script:  
Insert your device username in the angle brackets.

```
from fpdf import FPDF  
pdf = FPDF()
```

```
pdf.add_page ()
pdf.set_font ("Arial", size=12)
pdf.cell (200, 10, txt="Go Be Great!", ln=1, align="C")
pdf.output ("C:/Users/<yourusername>/Desktop/sample_demo.pdf")
```

---

**Note:** If you are uploading a script from a file on your desktop, the file and any dependencies must be in a standalone folder. When you select a file for upload, all files and folders at the same folder level are uploaded.

---

2. Create a new bot:
  - a) On the left panel, click **Automation**.
  - b) Click **Create new > Bot**.
  - c) In the **Create Task Bot** window, enter the bot name.
  - d) Accept the default folder location: `\Bots\`  
To change the default bot storage location, click **Choose** and follow the prompts.
  - e) Click **Create and edit**.
3. Provide the script with a **Python Script > Open** action:
  - a) Double-click or drag the **Python Script > Open**.
  - b) Select the **Import existing file** option.
  - c) Click **Browse** to select the .py file you created in Step 1.
4. Use a **Python Script > Execute script** action to tell the bot to run the script:
  - a) Double-click or drag **Python Script > Execute script**.
5. Close the script execution session with a **Python Script > Close** action:
  - a) Double-click or drag **Python Script > Close**.
  - b) Click **Save**.
6. Click the **Run** icon.

The bot creates a PDF on the desktop with the text `Go Be Great!`.

To review the bot launcher logs, navigate to `C:\ProgramData\AutomationAnywhere\BotRunner\Logs\<current month>\Bot_Launcher-<today's date>.log.zip`. Each zipped folder contains a file with data on the code execution, which is useful for debugging.

If the bot does not create a file, change the last line in the Python script:

```
pdf.output (r"C:/Users/<yourusername>/Desktop/sample_demo.pdf")
```

## Record package

The **Record** package enables you to perform various operations on record-type variables. A record-type variable holds a row of data extracted from a database, spreadsheet, or table in name-field pairs. The fields can store values of Boolean, datetime, number, or string data type.

### Actions in the Record package

The **Record** package includes the following actions:

Add column	See <a href="#">Add column action in the Record package</a> on page 2912.
Assign	See <a href="#">Assign action in the Record package</a> on page 2913.
Delete column	See <a href="#">Delete column action in the Record package</a> on page 2914.
Update column	See <a href="#">Update column action in the Record package</a> on page 2915.

Related reference

[Record package updates](#) on page 934

Review the updates in released versions of packages such as new and enhanced features as well as fixes and limitations. The page also lists the release dates of each version, and the compatible Control Room and Bot Agent versions.

### Add column action in the Record package

Use the **Add column** action to add a new column to an existing record variable at a specific index position, and store the output within a destination record variable. You can then insert this destination record variable into a Data table or Dictionary object.

#### Settings

- In the Actions palette, double-click or drag the **Add column** action from the **Record** package.
- Click the **Source record variable** drop-down and select an existing source record variable.

If there are no existing record variables, create one.

- (Optional) Enter a name for the column you want to add in the **Column name** field.

---

**Note:** The column name is case sensitive. An error message is displayed if you try to add an existing column name. However, you can add a duplicate entry of an empty column name.

---

- Click the **Column type** drop-down and select one of the following options as the type for the column that you are adding:

Option	Description
<b>String</b>	Enter a string value that you want to set to the new column. To insert a variable into the <b>Value</b> field, click the <b>Insert a value</b> icon and select a variable.



Option	Description
<b>Number</b>	Enter a numeric value that you want to set to the new column in the <b>Value</b> field.
<b>Boolean</b>	Click <b>True</b> or <b>False</b> tab to select a Boolean value, or click the <b>Variable</b> tab to insert an existing Boolean variable.
<b>Datetime</b>	<p>Use the <b>Datetime</b> tab to select the following:</p> <ul style="list-style-type: none"> <li>• Select a date from the calendar.</li> <li>• Select the time.</li> <li>• Use the drop-down to select a time zone.</li> </ul> <p>The <b>Datetime</b> is empty by default. If you run the bot without changing the default value, the action will use the current date, time and time zone of the system.</p>

- Use the **Insert column at** field to select one of the following options to specify the index:
  - **first index**: to insert the column at the first position (0 index) in a record variable.
  - **last index**: to insert the column at the last position of the record variable.
  - **specific index**: to insert a column at a specific position in the record variable.

For example, to insert a column at index position 1, enter 0. The index number starts from 0. The first item in the record variable is at position 0, the second item at 1, and so on.
- Click the **Destination record variable** drop-down to select an existing destination record variable.

(Optional) Click the **Create variable** icon to create a record variable. For more information, see [Record variable](#) on page 2340.

## Assign action in the Record package

Use the **Assign** action to assign the value of source record variable to the destination record variable.

### Settings

- In the **Actions** palette, double-click or drag the **Assign** action from the **Record** package.
- Click the **Select the source record variable** drop-down and select an existing source record variable.

If there are no existing record variables, create one.
- Use the **Select the destination record variable** field to select one of the following tabs for the destination record variable:
  - **Multiple variables**: To store the output in multiple variables by providing the key and the variable to which the key is mapped. This variable can be of any type, such as **String**,

**Number, Datetime, Boolean** and so on. For example, if your source record variable contains two entries; name and contact number, you can store the output as given below:

Key	Map to variable
Name	StrName
Contact number	MobileNo

The variables StrName and MobileNo are **String** and **Number** type variables respectively.

- **Record**: To store the output in a record-type variable.

Click the **Choose a variable** drop-down to select an existing variable or create one.

## Delete column action in the Record package

Use the **Delete column** action to delete a column from an existing record variable based on the column name or index.

### Settings

- In the Actions palette, double-click or drag the **Delete column** action from the **Record** package.
- Click the **Source record variable** drop-down and select an existing source record variable. If there are no existing record variables, create one.
- Use the **Delete column by** field to select one of the following options to delete a column :
  - **Column index**: to specify a column position in the record variable. Indexing starts at 0. For example, enter 5 to indicate the sixth column from the left.
  - **Column name**: to specify the name of an existing column.

---

**Note:** The column name is case sensitive. Ensure that you provide the correct column name. If there are duplicate column names, then the first matching column from the left will be deleted.

---

- Click the **Destination record variable** drop-down to select an existing destination record variable.

(Optional) Click the **Create variable** icon to create a record variable. For more information, see [Record variable](#) on page 2340.

## Update column action in the Record package

Use the **Update column** action to update the value of a column within an existing record variable at the specified index or name, and store the output in the destination record variable.

### Settings

- In the **Actions** palette, double-click or drag the **Update column** action from the **Record** package.
- Click the **Source record variable** drop-down and select an existing source record variable.  
If there are no existing record variables, create one.
- Use the **Update column by** field to select one of the following options to update a column:
  - Column index:** to specify the column number.  
Indexing starts from 0. Enter 5 to indicate the sixth column from the left.
  - Column name:** to specify the name of a column.

---

**Note:** The column name is case sensitive. Ensure that you provide the correct column name. If there are duplicate column names, then the first matching column from the left will be updated.

---

- Click the **Column type** drop-down and select one of the following options as the data type for the column that you are updating:

Option	Description
<b>String</b>	Enter a string value that you want to set to the new column. To insert a variable into the <b>Value</b> field, click the <b>Insert a value</b> icon and select a variable.
<b>Number</b>	Enter a numeric value that you want to set to the new column in the <b>Value</b> field.
<b>Boolean</b>	Click <b>True</b> or <b>False</b> tab to select a Boolean value, or click the <b>Variable</b> tab to insert an existing Boolean variable.
<b>Datetime</b>	<p>Use the <b>Datetime</b> tab to select the following:</p> <ul style="list-style-type: none"> <li>Select a date from the calendar.</li> <li>Select the time.</li> <li>Use the drop-down to select a time zone.</li> </ul> <p>The <b>Datetime</b> is empty by default. If you run the bot without changing the default value, the action will use the current date, time and time zone of the system.</p>

- Click the **Destination record variable** drop-down to select an existing destination record variable.  
  
(Optional) Click the **Create variable** icon to create a record variable. For more information, see [Record variable](#) on page 2340.

## Recorder package

Recorder package captures a series of tasks in a process and then automates them. You can automate your business applications (for example, desktop, Web, SAP, and Java applications) using the Recorder to capture actions performed on application objects such as a text box, button, table, radio button, combo box, and list view.

### Automation 360 extension setting

If the bot execution takes longer when you use the Recorder to automate a static page running on the Google Chrome or Microsoft Edge browser, then follow these steps to enable the setting in the Automation 360 extension:

- Click the extensions icon at the top right corner of the browser window.
- Click the vertical ellipses next to the Automation 360 plugin and select **Manage extension**.
- Enable the **Allow access to file URLs** option.
- Restart the browser and run the bot.

### Benefits of using Recorder package instead of SAP package

We recommend that you use the Recorder to automate SAP applications. When you use the Recorder to automate SAP applications, you have the following benefits:

- You can automate objects without creating a session. When you use the SAP package you must create a session.
- You can automate the object directly without generating the field paths or having any prior knowledge of the field paths. When you use the SAP package, the package will execute actions directly on control field paths when properties in the search criteria match the object that the bot searches during execution.
- If the Recorder runtime window overlaps the object that you want to automate, then the Recorder hides the runtime window before you automate the object.
- Recorder supports actions in the If, Loop, and Wait packages that enables you to check if an object exists in the specific browser or window.

---

**Note:** When compared to the Recorder package, the SAP package enables you to automate an application without activating the application window.

---

### Capture using Recorder

Use the **Capture** action to capture an interaction with a user interface (UI) object. This action enables you to add a single interaction when you are building a bot.

**Note:**

- The Capture action replaces the Object Cloning command from Version 11.3.
- If you open a window in any of the supported browsers with a user account that is different from the one used to log in to the computer, the Recorder might not capture and play the control actions accurately.
- When you use the Recorder package (version 2.3.0-20210806-215200 or earlier) with the Bot Agent (version 21.250 or later) released with Automation 360 v.29, you might encounter issues while capturing an object. We recommend you use Recorder package (version 2.4.0-20211118-080716 or later) with the Bot Agent (version 21.250 or later) to capture objects successfully.
- When the Bot Agent is installed at the user level, that is for user-specific installation type, Citrix, Java, and SAP will not be configured since the session in which the Bot Agent is running might not have the required privileges. Only VMWare plugin will be configured for the current user.

---

[Using the Capture action](#) on page 2940

When you are automating web pages running on Google Chrome and Microsoft Edge browsers, the **Recorder > Capture** action no longer scrolls down the web page if the target object is visible on the screen. This improves the user experience and the reliability of automation when there is a fixed top pane on the web page and if some physical actions such as mouse clicks do not work as expected.

Use the **Recorder > Capture** action to automate objects successfully when your device credentials are entered in the UPN format.

## Manual configuration of Silverlight technology

With the Recorder package (version 3.17.2 and later) and new Bot Agent (version 22.1.22) that was released with Automation 360 v.31, we will no longer configure Silverlight technology. If you want to configure Silverlight technology, perform the following steps to run the check.exe file manually.

1. Navigate to `C:\ProgramData\AutomationAnywhere\GlobalCache\embedded-resources`
2. Search for **ec0db824-25eb-4c57-ab44-f77ef67d2579**.  
The search results display a list of Recorder packages.
3. Select the Recorder package that you use.
4. Run check.exe file as administrator from that folder.

Alternatively, you can also perform the following steps to run the check.exe file manually from **Windows PowerShell**.

1. Click the **File** menu.
2. Navigate to **Open Windows PowerShell > Open Windows PowerShell as administrator**.

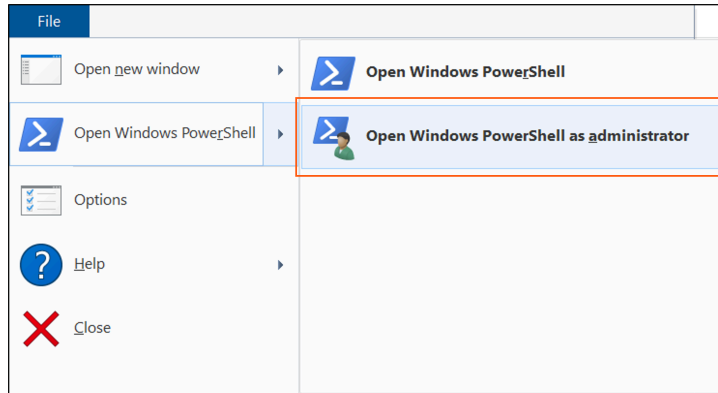

3. Enter `.\Check.exe` in the script and click **Enter**.

Perform the following steps to run the check.exe file manually from the **Command Prompt**.

1. Open the **Command Prompt** and run as administrator.
2. Enter `C:\ProgramData\AutomationAnywhere\GlobalCache\embedded-resources\` followed by the Recorder package version that you use.
3. Enter `check.exe` in the script and click **Enter**.

## Supported applications

You can automate the following applications running on Microsoft Edge Chromium with IE mode:

- Java web applications
- Applications that are accessed through the Citrix Workspace app.
- Citrix Virtual Apps

---

### Note:

- To accurately capture or automate objects on SAP applications, we recommend that you enable scripting. If scripting is not enabled, the following prompt message is displayed below the bot runtime window:

```
SAP scripting disabled: Enable scripting for more reliable captures
```

If you do not enable scripting, instead of using SAP technology, the Recorder uses MSAA technology for capturing objects.

- When automating an Electron application, the Recorder captures specific controls on the application using the Microsoft UI Automation (COM) technology by default. This enables you to automate Electron applications seamlessly without having to recapture the object with a specific technology.
-

## Citrix XenApp support

You can now launch the Google Chrome or Microsoft Edge browser window from a Citrix XenApp application, access the Control Room from the specific browser, and automate other virtual applications which are run as XenApps. This enables reliable object-based automation when you deploy and launch both Control Room and business applications as virtual applications from the same system.

---

**Note:** When you launch the Control Room as a XenApp, Automation Anywhere remote agent for Citrix is not required.

---

You can successfully execute parent and child bots that use different versions of the Recorder package in a Citrix XenApp environment.

---

**Note:** To use and execute multiple versions of the Recorder package in a bot effectively, ensure that your bots, both parent and child, use the Recorder package (version 2.16.0-20231101-165457 and later). Using earlier versions might not support this feature and could cause inconsistencies or errors during bot execution in Citrix environments.

---

## Supported control types

You can automate the following control types when you are automating a web page on a Google Chrome, Microsoft Edge Chromium, or Mozilla Firefox browser:

- Pop-up windows
- Alert dialog boxes
- Confirmation dialog boxes
- Prompt dialog boxes

---

**Note:** When you want to automate an alert dialog box on a web page, we recommend that you add a delay before the **Recorder > Capture** action because sometimes, the alert dialog box appears after a delay on the application window.

---

## Cross-domain support

You can capture and automate objects inside a cross-domain IFrame that has multiple IFrames with same frame source and IFrames that are loaded dynamically during runtime in Google Chrome and Microsoft Edge Chromium browsers. After you have captured an object inside a cross-domain IFrame, the frame path is stored in the **FrameDOMXPath** property, by default.

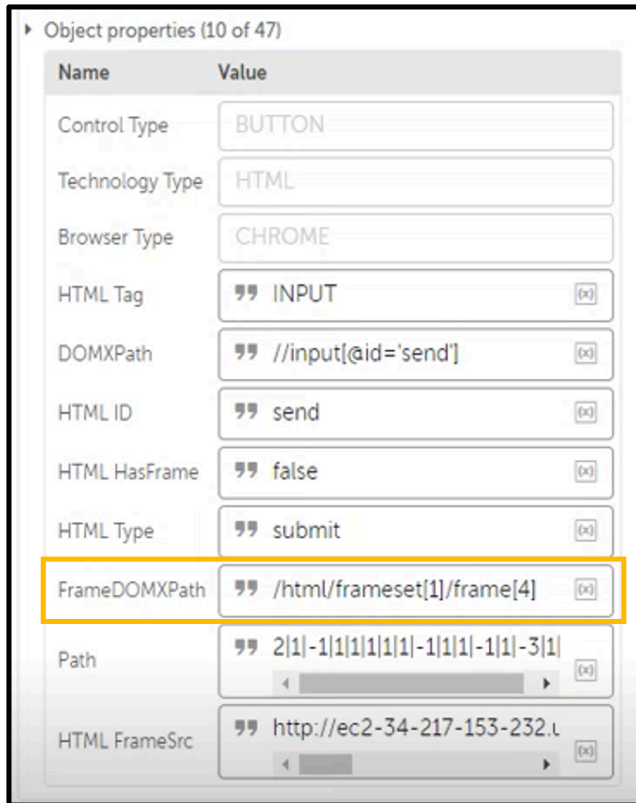

The new **FrameDOMXPath** property identifies the frame in which the object is located. You must select this property to run the bot successfully to automate objects on a cross-domain IFrame.

#### Note:

- When you select the **FrameDOMXPath** property from the search criteria, do not change the value of this property.
- If you clear the **FrameDOMXPath** property from the search criteria, the Recorder fails to identify the frame.

**Important:** In the Google Chrome browser, you can capture and automate objects inside a cross-domain and use multiple frames with the same frame source.

## Automate applications running as an admin user

You can capture objects on applications that are running as an administrator by selecting the **Capture and run with admin privileges** option from the Bot editor.

Before you automate applications running as an admin user, ensure the following:

- Bot Agent is installed in system profile.
- Bot Creators and Bot Runners have admin rights on the device to automate the applications.

When you select the **Start recording** option in the Bot editor to record multiple applications, and switch applications running in elevated and non-elevated mode, the bot might not be able to



identify the change between modes. In such cases, for all captures on applications in elevated mode, select the **Capture and run with admin privileges** option and then re-capture the object.

**Note:** Elevated mode gives you permission to run applications as an administrator.

**Important:** When you try to automate any Java or SAP application that is non-elevated by using the Recorder in elevated mode, the bot encounters an error.

To avoid this error, de-select the **Capture and run with admin privileges** option from the Bot editor and run the Recorder in non-elevated mode to capture Java or SAP applications.

## Object properties

When you select an object to capture, the Universal Recorder collects data on the object's properties in order to identify the object during run time. You can do the following with the object properties:

- Verify that the captured object properties match your intended object.

For example, when capturing a table from a website, ensure the **Control Type** and **HTML Tag** values are **TABLE**.



- Retrieve a property value. Use the **Get property** action and enter the name of the property in the **Property name** field or select an object property from the list of available properties. The list includes suggested property values from the search criteria in the **Object Properties** table. To select an object property from the list of properties, move the mouse pointer to the right of the **Property name** field and click the arrow.

For example, to retrieve the text of a link, use the **Get property** action and enter `HTML InnerText` in the **Property name** field or select `HTML InnerText` from the list of properties.

- You can select a combination of properties for the bot to search the object in your business application window uniquely.

The search algorithm for the Recorder package ensures that when you run a bot an object is captured only if its properties match the exact search criterion that you selected in the **Object properties** table. If the properties of the object do not match the search criterion exactly, then the bot fails with an error message. However, if the search criterion includes a wildcard character, then the bot captures the first object that matches the criterion.

For example, to capture a text box from an application that has three text boxes named **firstname1**, **firstname2**, and **firstname3**, if you select **HTML name** as the search criterion, enter the value `firstname` in the HTML name field, and run the bot, then the bot fails with an error message because a text box with the HTML name `firstname` does not exist. However, in the **HTML name** field, if you enter `firstname*`, and run the bot, then the bot captures the first text box that matches the criterion.

---

**Note:** This functionality is available for the bots you create using the 2.4.0-20211016-070100 version of the Recorder package starting from Automation 360 v.23. If you have created bots using a previous version of the Recorder package, you must recapture the objects to use this functionality.

---

## Actions performed on captured objects

After capturing the object, specify the action for the bot to perform on the object at run time. For example, when you capture a hyperlink, you can select to click the link or to retrieve the link text. To see table of all objects and possible actions, see [Actions performed on objects captured with Universal Recorder](#) on page 2923.

---

**Note:** If you encounter an error when running a bot that captures an object from Internet Explorer and the error message is about Google Chrome, see [Your Chrome Plug-in is either not installed or disabled \(A-People login required\)](#).

---

## Background processing

Background processing enables an automation that involves interacting with an application in the foreground (such as mouse clicks) to run in the background. We recommend that you use the option to run in background to increase the visibility of the target object and improve bot accuracy. The following actions support background processing:

- Click
- Set Text
- Get Text

## Secure recording

When secure recording mode is enabled, bots do not display the target object images after capture. This ensures that sensitive data is not shown.

---

**Note:** Although the bots do not display the target images after capture, the images are still stored in the Control Room because they are required to run the bots.

---

When you record a task in secure recording mode, the **Preview** window temporarily shows an image of the captured area. This image is hidden after you navigate away from the Bot editor window or refresh it.

A user with admin privileges must enable this setting. See [Settings](#) on page 1789.

## Proxy support

If your device is configured with a proxy, all outbound requests from this package are routed through the proxy server. See [Connect Bot Agent to a device with a proxy](#) on page 1351.

## Use cases on how to use recorder

Use these example tasks to become familiar with the use of the recorder in building bots.

- [Example of entering data into a web form from a spreadsheet](#) on page 3204
- [Example of extracting data from a web table](#) on page 3201

Related reference

[Universal Recorder for object-based automation](#) on page 2239

Use the Universal Recorder to record interactions, such as click, read (data extraction), and write (data entry), with user interface (UI) objects on the desktop, taskbar, or in an application or browser window.

[AISense for recording tasks from remote applications](#) on page 2256

AISense is the artificial intelligence (AI) powered capability of Automation 360 that helps you identify objects from an image or an application with a complex user interface (UI) and make automation in all environments faster and more accurate.

[Recorder package updates](#) on page 935

Review the updates in released versions of the Recorder package such as new and enhanced features as well as fixes and limitations. The page also lists the release dates of each version, and the compatible Control Room and Bot Agent versions.

## Actions performed on objects captured with Universal Recorder

After capturing the object, specify the action for the bot to do to the object at runtime. For example, if you capture a hyperlink, you can select an action to click the link or to retrieve the link text. Refer to the table below for the objects and their possible actions.

---

### Note:

- After you have captured an object and open the **Action** drop-down list, the list might offer actions for an object that are not supported. Only use the actions for an object that are listed in the table below.
- You can capture any control type which is not yet supported by Microsoft UI Automation (COM) technology as **Client** control. You can perform all actions that are available in **Client** control type but only those actions that are supported for that specific control. For example, if you are capturing a slider control which is not yet supported by Microsoft UI Automation (COM) technology, it is captured as a **Client** control. You can perform only those actions that

are supported by the slider control. For example, you can perform the **Click**, **Left click**, **Right click**, and **Double click** actions but you cannot perform the **Set text** action.

Object	Actions
Button	<ul style="list-style-type: none"><li>• <b>Get property</b>: retrieves the value of the specified object property (such as the link text) and optionally saves it to a variable. For more information, see the Object properties section.</li><li>• <b>Click</b></li><li>• <b>Left click</b>: use this action if the <b>Click</b> action fails during runtime.</li><li>• <b>Right click</b></li><li>• <b>Double click</b></li></ul>
Calendar	<ul style="list-style-type: none"><li>• <b>Get property</b>: retrieves the value of the specified object property (such as the link text) and optionally saves it to a variable. For more information, see the Object properties section.</li><li>• <b>Set date</b></li><li>• <b>Set month</b></li><li>• <b>Set year</b></li><li>• <b>Left click</b></li><li>• <b>Right click</b></li><li>• <b>Double click</b></li></ul>

Object	Actions
Checkbox	<ul style="list-style-type: none"><li>• <b>Debugger click:</b> use this action when you are unable to execute the Click action on a control whose parent control has an inline JavaScript. Ensure that you recapture the controls if you want to use this action in your existing bots.</li></ul> <hr/> <p><b>Note:</b></p> <ul style="list-style-type: none"><li>• You can use this action to automate controls only on web pages using HTML technology.</li><li>• This supports and browsers.</li><li>• Ensure that you install the 3.1.0.0 version of and extensions and the (version 2.13.6-20230809-153403 ) that was released with v.30.</li><li>• This does not support applications that contain cross-domain or same domain iframes.</li></ul> <hr/> <ul style="list-style-type: none"><li>• <b>Get property:</b> retrieves the value of the specified object property (such as the link text) and optionally saves it to a variable. For more information, see the Object properties section.</li><li>• <b>Get status:</b> retrieves whether the check box is selected. Returns checked or unchecked.</li><li>• <b>Check</b></li><li>• <b>Uncheck</b></li><li>• <b>Set focus</b></li><li>• <b>Toggle:</b> switches the check box to the opposite status. For example, if the check box is checked, use the <b>Toggle</b> action to clear it.</li><li>• <b>Left click:</b> use this action if the <b>Toggle</b> action does not work during Runtime.</li><li>• <b>Right click</b></li><li>• <b>Double click</b></li></ul>

Object	Actions
Client	<ul style="list-style-type: none"><li>• <b>Get property:</b> retrieves the value of the specified object property (such as the link text) and optionally saves it to a variable. For more information, see the Object properties section.</li><li>• <b>Get all children names:</b> retrieves the names of all the child elements of the captured control.  The child elements are the elements or controls that are available under the parent control and are only visible when you use spy tools like AccChecker.</li><li>• <b>Get all children values:</b> retrieves the values of all the child elements of the captured control.</li><li>• <b>Set text:</b> enters text into the UI object. It supports credentials. <a href="#">Credentials and credential variables in the Bot editor</a> on page 2344</li><li>• <b>Click</b></li><li>• <b>Debugger click:</b> use this action when you are unable to execute the Click action on a control whose parent control has an inline JavaScript. Ensure that you recapture the controls if you want to use this action in your existing bots.</li></ul> <hr/> <p><b>Note:</b></p> <ul style="list-style-type: none"><li>• You can use this action to automate controls only on web pages using HTML technology.</li><li>• This supports and browsers.</li><li>• Ensure that you install the 3.1.0.0 version of and extensions and the (version 2.13.6-20230809-153403 ) that was released with v.30.</li><li>• This does not support applications that contain cross-domain or same domain iframes.</li></ul> <hr/> <ul style="list-style-type: none"><li>• <b>Left click:</b> use this action if the <b>Click</b> action fails during runtime.</li><li>• <b>Right click</b></li><li>• <b>Double click</b></li></ul>

Object	Actions
ComboBox (appears as a drop-down list)	<ul style="list-style-type: none"> <li>• <b>Debugger click:</b> use this action when you are unable to execute the Click action on a control whose parent control has an inline JavaScript. Ensure that you recapture the controls if you want to use this action in your existing bots.</li> </ul> <hr/> <p><b>Note:</b></p> <ul style="list-style-type: none"> <li>• You can use this action to automate controls only on web pages using HTML technology.</li> <li>• This supports and browsers.</li> <li>• Ensure that you install the 3.1.0.0 version of and extensions and the (version 2.13.6-20230809-153403 ) that was released with v.30.</li> <li>• This does not support applications that contain cross-domain or same domain iframes.</li> </ul> <hr/> <ul style="list-style-type: none"> <li>• <b>Get property:</b> retrieves the value of the specified object property (such as the link text) and optionally saves it to a variable. For more information, see the Object properties section.</li> <li>• <b>Get total items:</b> retrieves the number of items in the box.</li> <li>• <b>Get selected index:</b> retrieves the item's position in the menu.</li> </ul> <hr/> <p><b>Note:</b> Item index counts start at 1.</p> <hr/> <ul style="list-style-type: none"> <li>• <b>Get selected item key:</b> retrieves the key of the selected item.</li> </ul> <hr/> <p><b>Note:</b> The Microsoft UI Automation (COM) technology does not support this .</p> <hr/> <ul style="list-style-type: none"> <li>• <b>Get selected text:</b> retrieves the data from the selected item.</li> <li>• <b>Select item by index:</b> selects the item that is located at the specified index.</li> </ul> <hr/> <p><b>Note:</b> Item index counts start at 1.</p> <hr/> <ul style="list-style-type: none"> <li>• <b>Select item by text</b> selects the item that matches the specified text.</li> </ul> <hr/> <p><b>Note:</b> The <b>Assign value</b> field is case-sensitive.</p> <hr/> <ul style="list-style-type: none"> <li>• <b>Set focus</b></li> </ul> <hr/> <p><b>Note:</b> The Microsoft UI Automation (COM) technology does not support this .</p> <hr/> <ul style="list-style-type: none"> <li>• <b>Expand</b></li> </ul> <hr/> <p><b>Note:</b> The Microsoft UI Automation (COM) technology does not support this .</p> <hr/> <ul style="list-style-type: none"> <li>• <b>Click</b></li> </ul> <hr/> <p><b>Note:</b> The Microsoft UI Automation (COM) technology does not support this .</p>

Object	Actions
GridView (SAP only)	<ul style="list-style-type: none"> <li data-bbox="605 254 911 289">• <b>Click on cell by index</b></li> </ul> <hr/> <p data-bbox="646 317 997 352"><b>Note:</b> Index count starts at 1.</p> <hr/> <ul style="list-style-type: none"> <li data-bbox="605 369 951 405">• <b>Double click current cell</b></li> <li data-bbox="605 407 1427 443">• <b>Get total rows:</b> retrieves the number of rows that contain values.</li> <li data-bbox="605 445 1427 506">• <b>Get total columns:</b> retrieves the number of columns that contain values.</li> <li data-bbox="605 508 1427 569">• <b>Get cell text by index:</b> retrieves the data in the specified cell located at the row and column index.</li> </ul> <hr/> <p data-bbox="646 604 1427 699"><b>Note:</b> Row and column index counts start at 1. For example, to retrieve the data in cell A2, enter 2 in the <b>Row</b> field and 1 in the <b>Column</b> field.</p> <hr/> <ul style="list-style-type: none"> <li data-bbox="605 720 1427 781">• <b>Get cell index by text:</b> retrieves the index of the cell containing the specified text.</li> </ul> <hr/> <p data-bbox="646 816 1149 852"><b>Note:</b> The <b>Cell Text</b> field is case-sensitive.</p> <hr/> <ul style="list-style-type: none"> <li data-bbox="605 867 1427 961">• <b>Get property:</b> retrieves the value of the specified object property (such as the link text) and optionally saves it to a variable. For more information, see the Object properties section.</li> <li data-bbox="605 963 1427 1058">• <b>Get table:</b> retrieves the table data and saves it to a Table variable. For more information, see <a href="#">Example of extracting data from a web table</a> on page 3201</li> <li data-bbox="605 1060 760 1096">• <b>Select all</b></li> <li data-bbox="605 1098 1427 1159">• <b>Set cell by index:</b> enters text into the cell located at the row and column index.</li> </ul> <hr/> <p data-bbox="646 1194 1427 1289"><b>Note:</b> Row and column index counts start at 1. For example, to enter text into cell A2, enter 2 in the <b>Row</b> field and 1 in the <b>Column</b> field.</p> <hr/> <ul style="list-style-type: none"> <li data-bbox="605 1310 1427 1371">• <b>Set cell by text:</b> enters text into the cell containing the specified text.</li> </ul> <hr/> <p data-bbox="646 1407 1154 1442"><b>Note:</b> The <b>Find Text</b> field is case-sensitive.</p> <hr/> <ul style="list-style-type: none"> <li data-bbox="605 1457 837 1493">• <b>Set current cell</b></li> <li data-bbox="605 1495 837 1530">• <b>Set current row</b></li> <li data-bbox="605 1533 760 1568">• <b>Set focus</b></li> <li data-bbox="605 1570 1427 1606">• <b>Left click:</b> use this action if the <b>Click</b> action fails during runtime.</li> <li data-bbox="605 1608 776 1644">• <b>Right click</b></li> <li data-bbox="605 1646 802 1682">• <b>Double click</b></li> </ul>



Object	Actions
Label	<ul style="list-style-type: none"> <li>• <b>Debugger click:</b> use this action when you are unable to execute the Click action on a control whose parent control has an inline JavaScript. Ensure that you recapture the controls if you want to use this action in your existing bots.</li> </ul> <hr/> <p><b>Note:</b></p> <ul style="list-style-type: none"> <li>• You can use this action to automate controls only on web pages using HTML technology.</li> <li>• This supports and browsers.</li> <li>• Ensure that you install the 3.1.0.0 version of and extensions and the (version 2.13.6-20230809-153403 ) that was released with v.30.</li> <li>• This does not support applications that contain cross-domain or same domain iframes.</li> </ul> <hr/> <ul style="list-style-type: none"> <li>• <b>Get property:</b> retrieves the value of the specified object property (such as the link text) and optionally saves it to a variable. For more information, see the Object properties section.</li> <li>• <b>Set focus</b></li> <li>• <b>Left click:</b> use this action if the <b>Click</b> action fails during runtime.</li> <li>• <b>Right click</b></li> <li>• <b>Double click</b></li> </ul>
Link	<ul style="list-style-type: none"> <li>• <b>Debugger click:</b> use this action when you are unable to execute the Click action on a control whose parent control has an inline JavaScript. Ensure that you recapture the controls if you want to use this action in your existing bots.</li> </ul> <hr/> <p><b>Note:</b></p> <ul style="list-style-type: none"> <li>• You can use this action to automate controls only on web pages using HTML technology.</li> <li>• This supports and browsers.</li> <li>• Ensure that you install the 3.1.0.0 version of and extensions and the (version 2.13.6-20230809-153403 ) that was released with v.30.</li> <li>• This does not support applications that contain cross-domain or same domain iframes.</li> </ul> <hr/> <ul style="list-style-type: none"> <li>• <b>Get property:</b> retrieves the value of the specified object property (such as the link text) and optionally saves it to a variable. For more information, see the Object properties section.</li> <li>• <b>Click</b></li> <li>• <b>Left click:</b> use this action if the <b>Click</b> action fails during runtime.</li> <li>• <b>Right click</b></li> <li>• <b>Double click</b></li> </ul>

Object	Actions
ListView	<ul style="list-style-type: none"> <li>• <b>Debugger click:</b> use this action when you are unable to execute the Click action on a control whose parent control has an inline JavaScript. Ensure that you recapture the controls if you want to use this action in your existing bots.</li> </ul> <hr/> <p><b>Note:</b></p> <ul style="list-style-type: none"> <li>• You can use this action to automate controls only on web pages using HTML technology.</li> <li>• This supports and browsers.</li> <li>• Ensure that you install the 3.1.0.0 version of and extensions and the (version 2.13.6-20230809-153403 ) that was released with v.30.</li> <li>• This does not support applications that contain cross-domain or same domain iframes.</li> </ul> <hr/> <ul style="list-style-type: none"> <li>• <b>Get property:</b> retrieves the value of the specified object property (such as the link text) and optionally saves it to a variable. For more information, see the Object properties section.</li> <li>• <b>Get total items:</b> retrieves the number of items in the list.</li> <li>• <b>Get selected index:</b> retrieves the item's position in the menu.</li> </ul> <hr/> <p><b>Note:</b> Item index counts start at 1.</p> <hr/> <ul style="list-style-type: none"> <li>• <b>Get selected text:</b> retrieves the data from the selected item.</li> <li>• <b>Select item by index:</b> selects the item that is located at the specified index.</li> </ul> <hr/> <p><b>Note:</b> Item index counts start at 1.</p> <hr/> <ul style="list-style-type: none"> <li>• <b>Select item by text</b> selects the item that matches the specified text.</li> </ul> <hr/> <p><b>Note:</b> The <b>Assign value</b> field is case-sensitive.</p> <hr/> <ul style="list-style-type: none"> <li>• <b>Click</b></li> <li>• <b>Left click:</b> use this action if the <b>Click</b> action fails during runtime.</li> <li>• <b>Right click</b></li> <li>• <b>Double click</b></li> </ul>

Object	Actions
<p>Main window</p> <hr/> <p><b>Note:</b> The Microsoft UI Automation (COM) technology does not support this control.</p> <hr/>	<ul style="list-style-type: none"> <li>• <b>Get focus control id:</b> retrieves the ID of the control that is in focus.</li> <li>• <b>Get property:</b> retrieves the value of the specified object property (such as the link text) and optionally saves it to a variable. For more information, see the Object properties section.</li> <li>• <b>Set focus</b></li> <li>• <b>Send key</b></li> <li>• <b>Left click:</b> use this action if the <b>Click</b> action fails during runtime.</li> <li>• <b>Right click</b></li> <li>• <b>Double click</b></li> </ul>
<p>Menu</p>	<ul style="list-style-type: none"> <li>• <b>Get property:</b> retrieves the value of the specified object property (such as the link text) and optionally saves it to a variable. For more information, see the Object properties section.</li> <li>• <b>Get total items:</b> retrieves the number of items in the menu.</li> <li>• <b>Get selected index:</b> retrieves the item's position in the menu.</li> </ul> <hr/> <p><b>Note:</b> Item index counts start at 1.</p> <hr/> <ul style="list-style-type: none"> <li>• <b>Get selected text:</b> retrieves the data from the selected item.</li> <li>• <b>Select item by index:</b> selects the item that is located at the specified index.</li> </ul> <hr/> <p><b>Note:</b> Item index counts start at 1.</p> <hr/> <ul style="list-style-type: none"> <li>• <b>Select item by text</b> selects the item that matches the specified text.</li> </ul> <hr/> <p><b>Note:</b> The <b>Assign value</b> field is case-sensitive.</p> <hr/> <ul style="list-style-type: none"> <li>• <b>Set focus:</b> The Microsoft UI Automation (COM) technology does not support this action.</li> <li>• <b>Left click:</b> use this action if the <b>Click</b> action fails during runtime.</li> <li>• <b>Right click</b></li> <li>• <b>Double click</b></li> </ul>

Object	Actions
Page Tab	<ul style="list-style-type: none"> <li>• <b>Get property:</b> retrieves the value of the specified object property (such as the link text) and optionally saves it to a variable. For more information, see the Object properties section.</li> <li>• <b>Get total items:</b> retrieves the number of items in the tab.</li> <li>• <b>Get selected index:</b> retrieves the item's position in the menu.</li> </ul> <hr/> <p><b>Note:</b> Item index counts start at 1.</p> <hr/> <ul style="list-style-type: none"> <li>• <b>Get selected text:</b> retrieves the data from the selected item.</li> <li>• <b>Select item by index:</b> selects the item that is located at the specified index.</li> </ul> <hr/> <p><b>Note:</b> Item index counts start at 1.</p> <hr/> <ul style="list-style-type: none"> <li>• <b>Select item by text</b> selects the item that matches the specified text.</li> </ul> <hr/> <p><b>Note:</b> The <b>Assign value</b> field is case-sensitive.</p> <hr/> <ul style="list-style-type: none"> <li>• <b>Left click:</b> use this action if the <b>Click</b> action fails during runtime.</li> <li>• <b>Right click</b></li> <li>• <b>Double click</b></li> </ul> <hr/> <p><b>Note:</b> When you capture a Page Tab control using Microsoft UI Automation (COM) technology and perform <b>Left click</b>, <b>Right click</b>, or <b>Double click</b> actions on the control, the actions will click on the point of capture.</p> <hr/>
Password text	<ul style="list-style-type: none"> <li>• <b>Get property:</b> retrieves the value of the specified object property (such as the link text) and optionally saves it to a variable. For more information, see the Object properties section.</li> <li>• <b>Set text:</b> enters text into the UI object. It supports credentials. <a href="#">Credentials and credential variables in the Bot editor</a> on page 2344</li> <li>• <b>Click</b></li> <li>• <b>Left click:</b> use this action if the <b>Click</b> action does not work during Runtime.</li> <li>• <b>Right click</b></li> <li>• <b>Double click</b></li> </ul>

Object	Actions
RadioButton	<ul style="list-style-type: none"> <li>• <b>Debugger click:</b> use this action when you are unable to execute the Click action on a control whose parent control has an inline JavaScript. Ensure that you recapture the controls if you want to use this action in your existing bots.</li> </ul> <hr/> <p><b>Note:</b></p> <ul style="list-style-type: none"> <li>• You can use this action to automate controls only on web pages using HTML technology.</li> <li>• This supports and browsers.</li> <li>• Ensure that you install the 3.1.0.0 version of and extensions and the (version 2.13.6-20230809-153403 ) that was released with v.30.</li> <li>• This does not support applications that contain cross-domain or same domain iframes.</li> </ul> <hr/> <ul style="list-style-type: none"> <li>• <b>Get property:</b> retrieves the value of the specified object property (such as the link text) and optionally saves it to a variable. For more information, see the Object properties section.</li> <li>• <b>Get status:</b> retrieves whether the radio button is selected. Returns selected or deselected.</li> <li>• <b>Select</b></li> <li>• <b>Set focus</b></li> <li>• <b>Left click:</b> use this action if the <b>Click</b> action fails during runtime.</li> <li>• <b>Right click</b></li> <li>• <b>Double click</b></li> </ul>
Shell	<ul style="list-style-type: none"> <li>• <b>Get property:</b> retrieves the value of the specified object property (such as the link text) and optionally saves it to a variable. For more information, see the Object properties section.</li> <li>• <b>Left click:</b> use this action if the <b>Click</b> action fails during runtime.</li> <li>• <b>Right click</b></li> <li>• <b>Double click</b></li> </ul> <hr/> <p><b>Note:</b> The Microsoft UI Automation (COM) technology does not support this control.</p> <hr/>

Object	Actions
Slider	<ul style="list-style-type: none"> <li>• <b>Get property:</b> retrieves the value of the specified object property and optionally saves it to a variable. For more information, see the Object properties section. This action supports the following object properties: <ul style="list-style-type: none"> <li>• <b>RangeMaximum:</b> shows the maximum value of the slider.</li> <li>• <b>RangeMinimum:</b> shows the minimum values of the slider.</li> <li>• <b>Range value:</b> shows the current value of the slider.</li> <li>• <b>RangeSmallChange:</b> represents the smallest increment by which the value of the slider can change.</li> <li>• <b>RangeLargeChange:</b> represents the largest increment by which the value of the slider can change.</li> <li>• <b>RangeisReadyOnly:</b> indicates whether the current state of the slider is read-only or editable.</li> </ul> </li> <li>• <b>Set position</b></li> <li>• <b>Left click</b></li> <li>• <b>Right click</b></li> <li>• <b>Double click</b></li> </ul> <hr/> <p><b>Note:</b></p> <ul style="list-style-type: none"> <li>• You can use the actions in the Slider control to automate Windows Presentation Foundation (WPF) controls and Electron applications.</li> <li>• Automation of WinForms is not yet supported.</li> </ul>
<p>Tab</p> <hr/> <p><b>Note:</b> The Microsoft UI Automation (COM) technology does not support this control.</p> <hr/>	<ul style="list-style-type: none"> <li>• <b>Get property:</b> retrieves the value of the specified object property (such as the link text) and optionally saves it to a variable. For more information, see the Object properties section.</li> <li>• <b>Scroll left</b></li> <li>• <b>Select</b></li> <li>• <b>Set focus</b></li> <li>• <b>Left click:</b> use this action if the <b>Click</b> action fails during runtime.</li> <li>• <b>Right click</b></li> <li>• <b>Double click</b></li> </ul>

Object	Actions
Table	<ul style="list-style-type: none"> <li>• <b>Debugger click:</b> use this action when you are unable to execute the Click action on a control whose parent control has an inline JavaScript. Ensure that you recapture the controls if you want to use this action in your existing bots.</li> </ul> <hr/> <p><b>Note:</b></p> <ul style="list-style-type: none"> <li>• You can use this action to automate controls only on web pages using HTML technology.</li> <li>• This supports and browsers.</li> <li>• Ensure that you install the 3.1.0.0 version of and extensions and the (version 2.13.6-20230809-153403 ) that was released with v.30.</li> <li>• This does not support applications that contain cross-domain or same domain iframes.</li> </ul> <hr/> <ul style="list-style-type: none"> <li>• <b>Deselect all</b></li> <li>• <b>Get property:</b> retrieves the value of the specified object property (such as the link text) and optionally saves it to a variable. For more information, see the Object properties section.</li> <li>• <b>Get cell text by index:</b> retrieves the data in the specified cell located at the row and column index.</li> </ul> <hr/> <p><b>Note:</b> Row and column index counts start at 1. For example, to retrieve the data in cell A2, enter 2 in the <b>Row</b> field and 1 in the <b>Column</b> field.</p> <hr/> <p><b>Note:</b> For the Microsoft UI automation (COM) technology, the row and column index counts start at 1, which includes the header row and the leftmost column.</p> <hr/> <ul style="list-style-type: none"> <li>• <b>Get cell index by text:</b> retrieves the index of the cell containing the specified text.</li> </ul> <hr/> <p><b>Note:</b> The <b>Cell Text</b> field is case-sensitive.</p> <hr/> <ul style="list-style-type: none"> <li>• <b>Get table:</b> retrieves the table data and saves it to a Table variable. For more information, see <a href="#">Example of extracting data from a web table</a> on page 3201. <ul style="list-style-type: none"> <li>• When you use the Microsoft UI Automation (COM) technology to capture the control, the <b>Get table</b> action also extracts the leftmost column and header rows in the table.</li> </ul> </li> <li>• <b>Get total rows:</b> retrieves the number of rows that contain values.</li> </ul> <hr/> <p><b>Note:</b> When you use the Microsoft UI Automation (COM) technology to capture the control, the <b>Get total rows</b> action extracts a greater number of rows (including the header in the rows) when compared to the older technologies .</p> <hr/> <ul style="list-style-type: none"> <li>• <b>Get total columns:</b> retrieves the number of columns that contain values.</li> </ul>

Object	Actions
TextBox	<ul style="list-style-type: none"> <li>• <b>Debugger click:</b> use this action when you are unable to execute the Click action on a control whose parent control has an inline JavaScript. Ensure that you recapture the controls if you want to use this action in your existing bots.</li> </ul> <hr/> <p><b>Note:</b></p> <ul style="list-style-type: none"> <li>• You can use this action to automate controls only on web pages using HTML technology.</li> <li>• This supports and browsers.</li> <li>• Ensure that you install the 3.1.0.0 version of and extensions and the (version 2.13.6-20230809-153403 ) that was released with v.30.</li> <li>• This does not support applications that contain cross-domain or same domain iframes.</li> </ul> <hr/> <ul style="list-style-type: none"> <li>• <b>Get property:</b> retrieves the value of the specified object property (such as the link text) and optionally saves it to a variable. For more information, see the Object properties section.</li> <li>• <b>Set focus</b></li> <li>• <b>Set text:</b> enters text into the UI object. It supports credentials. <a href="#">Credentials and credential variables in the Bot editor</a> on page 2344</li> <li>• <b>Append text:</b> adds text to the end of existing text in the field, instead of overwriting it.</li> <li>• <b>Click</b></li> <li>• <b>Left click:</b> use this action if the <b>Click</b> action fails during runtime.</li> <li>• <b>Right click</b></li> <li>• <b>Double click</b></li> </ul>
Toolbar  <hr/> <p><b>Note:</b> The Microsoft UI Automation (COM) technology does not support this control.</p> <hr/>	<ul style="list-style-type: none"> <li>• <b>Get property:</b> retrieves the value of the specified object property (such as the link text) and optionally saves it to a variable. For more information, see the Object properties section.</li> <li>• <b>Left click:</b> use this action if the <b>Click</b> action fails during runtime.</li> <li>• <b>Right click</b></li> <li>• <b>Double click</b></li> </ul>



Object	Actions
Tree (Control is displayed as a ListView)	<ul style="list-style-type: none"> <li data-bbox="610 254 1419 348">• <b>Get property:</b> retrieves the value of the specified object property (such as the link text) and optionally saves it to a variable. For more information, see the Object properties section.</li> </ul> <hr/> <p data-bbox="646 380 1419 506"><b>Note:</b> When you use the Microsoft UI Automation (COM) technology to capture the control, the <b>Get property</b> action does not retrieve the property of the item element and returns a blank value.</p> <hr/> <ul style="list-style-type: none"> <li data-bbox="610 527 1333 558">• <b>Get total items:</b> retrieves the number of items in the tree.</li> <li data-bbox="610 562 1377 594">• <b>Get selected index:</b> retrieves the item's position in the menu.</li> </ul> <hr/> <p data-bbox="646 625 1057 657"><b>Note:</b> Item index counts start at 1.</p> <hr/> <p data-bbox="646 709 1419 835"><b>Note:</b> When you use the Microsoft UI Automation (COM) technology to capture the control, the <b>Get selected text</b> action returns a list of items instead of a single item in a string similar to other technologies.</p> <hr/> <ul style="list-style-type: none"> <li data-bbox="610 856 1360 888">• <b>Get selected text:</b> retrieves the data from the selected item.</li> </ul> <hr/> <p data-bbox="646 919 1419 1045"><b>Note:</b> When you use the Microsoft UI Automation (COM) technology to capture the control, the <b>Get selected text</b> action returns a list of items instead of a single item in a string similar to other technologies.</p> <hr/> <ul style="list-style-type: none"> <li data-bbox="610 1066 1349 1129">• <b>Select item by index:</b> selects the item that is located at the specified index.</li> </ul> <hr/> <p data-bbox="646 1161 1057 1192"><b>Note:</b> Item index counts start at 1.</p> <hr/> <ul style="list-style-type: none"> <li data-bbox="610 1213 1393 1276">• <b>Select item by text</b> selects the item that matches the specified text.</li> </ul> <hr/> <p data-bbox="646 1308 1198 1339"><b>Note:</b> The <b>Assign value</b> field is case-sensitive.</p> <hr/> <ul style="list-style-type: none"> <li data-bbox="610 1360 1409 1392">• <b>Left click:</b> use this action if the <b>Click</b> action fails during runtime.</li> <li data-bbox="610 1396 781 1428">• <b>Right click</b></li> <li data-bbox="610 1432 805 1463">• <b>Double click</b></li> </ul> <hr/> <p data-bbox="610 1518 1409 1644"><b>Note:</b> When you capture a Tree control using Microsoft UI Automation (COM) technology and perform <b>Left click</b>, <b>Right click</b>, or <b>Double click</b> actions on the control, the actions will click on the point of capture.</p>

## Search criteria used by the Recorder package

When you record a User Interface (UI) control with the Recorder package, a set of properties is captured; these properties are used to identify and interact with the recorded UI control during runtime.

The controls you capture using the Recorder are called objects. When the Recorder captures an object, it captures all possible properties that uniquely identify the object. The selected properties are used as "search criteria" to search and find the control from the target application during runtime.

During bot execution, the recorder goes through the target application control tree and selects the control that matches the saved properties, also known as search criteria.

By default, the recorder selects the best possible search criteria for a recorded control based on the technology. However, bots can encounter problems when trying to find previously recorded UI controls. Some of the common reasons for such failure include ,but are not limited to, the following:

- **Dynamic properties:** If the properties of the captured elements change with each session or page load, and if the search criteria include any of the dynamic properties, bot can fail during runtime.
- **Frequent UI changes:** If the target application is updated frequently with UI changes, and if the properties of the recorded UI controls change, bots can encounter problems when trying to recognize the recorded controls.
- **Controls with duplicate properties:** If there are multiple controls with the same properties, it can result in either unintended results or bot failing to recognize the controls.

In such situations, if your bots depend solely on the default search criteria captured by the recorder, they can face difficulties in recognizing the captured controls. The captured search criteria work consistently as long as there are no other objects that match the criteria or the objects themselves are not periodically updated. Therefore, after recording UI controls, you must consider these factors and try to configure search criteria that can help your bot uniquely identify the recorded controls at the time of bot execution.

### Example of dynamic properties and using custom search criteria

Suppose certain properties of a web page that you are trying to record change at every session. Including the properties that change will result in bot failing to recognize the controls. For example, consider the sample login page shown in the following video. The ID property of the Login button changes every time the page is loaded.

When you record the Login button on the page, the recorder captures the ID as one of the default properties.

The screenshot displays the Automation Anywhere configuration interface. On the left, a workflow diagram shows a 'Triggers' section with a 'Recorder: Capture' step. The step description is 'Left click on button "btn16969...'. On the right, the 'Object properties' panel is expanded, showing a table of properties for the selected 'Login' button. The 'HTML ID' property is highlighted with a red box and contains the value 'btn1696911842030-8845'. Other properties include 'Browser type' (Google Chrome), 'Technology type' (HTML), 'Control type' (Button), 'HTML Tag' (BUTTON), 'DOMXPath' (/html/body/div[1]/button[:]), 'HTML HasFrame' (false), 'HTML Type' (submit), 'Path' (1|-1), and 'HTML FrameSrc' (https://aa2019packagesd...).

If you run the bot without updating the search criteria, the bot fails during runtime because the ID of the login button keeps changing every time the page is loaded.

**⚠ There was a problem at line 4**

This may be due to the following reason:

Unable to find BUTTON. Search Criteria did not match.

Location: Recorder-Test (line 4)

To continue, edit the bot and fix the error. Then, try again.

If you continue to see this message, please contact your system administrator.

Code: bot.execution.error

**Close**

Since the ID property keeps changing, the bot fails because it is unable to find the Login button that has the previously captured ID. So using the ID property in this scenario will not work. The problem can be easily fixed by clearing the ID property and by selecting the **innerHTML** property as shown in the following video. That way the bot does not look for a control with the ID btn1696911842030-8845. Instead, it will depend on the combination of the **DOMXPath** and **innerHTML** properties to uniquely identify the control.

## Considerations for modifying object properties in HTML

Consider the following factors when you capture UI controls using the Recorder package:

- If the web page that you plan to record has dynamic properties, omit them from the recorded object properties. Instead, select properties that will not change during the run time.
- If there are multiple UI controls with the same properties, select properties that can identify a specific UI control uniquely. For example, if there are multiple buttons with the type button and if the innerHTML text (button labels) is different for each button, using the innerHTML as one of the property will help identify the control during runtime.
- Use a dynamic or relative DOMXPath that works with layout changes. Avoid using static DOMXPath if the layout changes or dynamic controls are added to the UI.
- Use wildcard (\*) if certain characters of the property values are dynamic.

## Using the Capture action

Use the **Capture** action to capture a single interaction (click, keystroke, or mouse movement) with an object control including a text box, button, table, menu, radio button, combo box, check box, list view, link, tree, or page tab.

- To use the Recorder, you must already have done the following:
  - [Install Bot Agent and register device](#) on page 1347
  - [Set user device credentials](#) on page 1353

- Configure device display and font scale to 100%.

If you are using Recorder package version 2.0.6-20200626-193519 or later, you can record tasks in Google Chrome, Internet Explorer, Java, Microsoft Active Accessibility, and Microsoft UI automation applications on a computer that has display scale configured to 100%, 125%, or 150%.

- If you are automating a task using a browser, configure the zoom level to 100%.

If you are using Recorder package version 2.0.6-20200626-193519 or later, you can record tasks in a Google Chrome browser that does not have a zoom level setting of 100%.

- If you are automating a task using a Google Chrome browser, ensure that the Automation Anywhere plug-in that corresponds with the Automation 360 build version is enabled.

[Browser requirements for Automation Workspace](#) on page 1210

- To automate web applications running on Microsoft Edge Chromium browser in Internet Explorer mode using the Universal Recorder, ensure that the Internet Explorer compatibility mode is enabled. The objects on the web applications are captured using HTML technology. To enable this mode, perform the following steps:

1. On the Microsoft Edge Chromium browser page, click **Settings**.
2. On the left panel, click **Default browser**.
3. Navigate to the **Allow sites to be reloaded in Internet Explorer mode** option and select **Allow**.
4. Click **Add** to add the URL of the page that you want to load in Internet Explorer mode.

---

**Note:** The pages that you add open in Internet Explorer mode for 30 days from the date when you add the page.

---

Considerations when recording a task:

- Use clicks when possible rather than shortcut keys.

When you click an object using the Recorder, it retrieves the object's properties that enable the bot to identify the object at runtime. Keyboard shortcuts are less reliable, so use them when it is not possible to automate the task by a clicking an object.

- If you are automating a task using a browser, do not use autofill to enter values into fields.
- Record the task at low speed.
- Avoid dragging windows during the recording process.
- Avoid clicking on applications that are not part of the process you are recording and automating.
- When Internet Explorer is used, the action waits until the browser is completely rendered and is in a ready state before executing the action.

To record a single interaction with an object control, follow these steps:

1. Double-click or drag **Recorder > Capture**.
2. Specify the window in which to capture an object.  
Choose from the **Application**, **Browser**, or **Variable** tab.

Option	Description
Application	Select from a list of currently active windows. This option shows a list of all the application and browser windows that are open on the Bot Creator device.
Browser	Select from a list of supported browser tabs.  <b>Note:</b> This option supports , Chromium-based , and browsers. For all other browsers, use the <b>Application</b> option.
Variable	Select an existing window variable to specify the title of the application window title.

3. Optional: Insert a wildcard character (\*) in the **Window title** field to search for window titles that can change. You can specify one or more wildcards (\*) at the start, middle, or end of the value.

For example, to perform an operation on any window that has `Microsoft` in the title, use a wildcard to indicate any string by adding it before or after the value: `*Microsoft*`. The first searches for the exact window title (`Microsoft`), and if it does not find a match, it searches for windows with the term `Microsoft` anywhere in the title.

You can use a regular expression (regex) to identify a window title. Select the regular expression condition as either **String** or a **Pattern** and then enter the value. By default, the **Window title** field is case-sensitive.

To identify a browser title, you can enable the **Case sensitive** option to match the letter case, or disable the option to identify a window title where the letter case does not match.

**Note:** Ensure that the minimum version installed on your system is the version that was released with v.26. If you have a version released with v.25 or earlier, then by default, the window title will be identified only with matching letter case (case-sensitive).

---

For example, you can enter the **String** value as `(\w*) -Notepad` for all window title names starting with `(\w*) -Notepad`, or use **Pattern** value as `(\w)\s)*document-Notepad` for only those window titles that match this pattern.

---

**Note:**

- When you use a regular expression of type **String** with `-title` as the input value for a window title in any , the might encounter a run time error. To prevent the run time error, ensure that when you add the string input as `*-title`, the application with the specific title is open. The asterisk (\*) is just a character, not a wild card character.
- When you use a regular expression of type **Pattern** with `-title` as the input value for a window title in any , the might encounter a run time error because the input value `*-title` is incorrect.

Ensure that you use valid regex patterns.

---

**Note:** During runtime, verify that the Task Bot identifies the correct window. If it does not, do the following:

- a) Open the application or browser window.
  - b) Drag a **Window > Get active window title** action above the **Recorder > Capture** action.
  - c) Insert a string variable into the **Assign the window title to variable** field.
  - d) Drag a **Window > Set title** action below the **Window > Get active window title** action.
  - e) In the **Window** field, insert the window variable generated by the **Recorder > Capture** action.
  - f) In the **New window title** field, insert the string variable from the **Get active window title** action.
  - g) Click **Save**.
- 

4. Optional: Select the **Resize window** option to specify the window dimensions.

This option delivers a more reliable bot. It resizes the window to the dimensions at which the task was recorded, which enhances the ability of the bot to identify the target object.

- If the window is maximized when you record the task, this option is not selected.
  - If the window is not at the maximum size when you record the task, this option is selected, by default, and the width and height fields are automatically filled with the dimensions of the window.
- 

**Note:** This option is available only for windows that can be resized. It is not available for the **Desktop** or **Taskbar** options.

---

5. Click **Capture object**.

The selected window appears.

---

6. Move the mouse over the object you want to automate, for example, a button, form field, or a table.  
A red rectangular box appears around the object.

---

**Note:** If the box does not appear and you are capturing in either the Google Chrome, Microsoft Edge, or Mozilla Firefox browsers, verify that you have enabled the Automation Anywhere extensions for these browsers. See [Google Chrome browser extension requirements](#) on page 2250 for Google Chrome browser.

---

7. Click the object.
8. Review the **Object properties** table.  
Following are the list of object properties that are selected by default based on the technology type:

---

**Note:** You do not have an option to select Java or HTML technology explicitly. When you capture an application in auto-detect mode, the Recorder detects the technology automatically based on the application being captured. When the Recorder detects the specific technology, the technology type is displayed within the **Object properties**.

---

**Important:** The following list does not include all the properties and is restricted to the most commonly used and important properties based on the technology type.

---

Technology type	Object properties	Description
HTML Technology	Control type	This is a read-only property that shows the type of object captured, for example, text box or button.

Technology type	Object properties	Description
	DOMXPath	<p>It is the path that is used to locate the control or object that is captured.</p> <p><b>DOMXPath</b> can be of two types: Relative XPath and Absolute XPath.</p> <ul style="list-style-type: none"> <li>• Absolute Xpath: It contains the complete path from the root element to the desired element. For example, an absolute Xpath for this topic would be <code>/html/body/div/div[1]/main/div[2]/div/div/div[2]/div/div/div[1]/div/article/main/article/div/p[1]</code></li> <li>• Relative Xpath: This is a shorter path that refers to an element you want to identify. A relative path starts with a <code>//</code> symbol. For example, the relative XPath for this topic would be <code>//*[@id="cloud-using-recorder-action"]/div/p[1]</code></li> </ul> <p>For example, if you want to find the <b>DOMXPath</b> of a particular element on Google Chrome browser, perform these steps:</p> <ol style="list-style-type: none"> <li>a) Select the element for which you want to extract the XPath.</li> <li>b) Right-click the element and select <b>Inspect</b>.</li> <li>c) Right-click the highlighted element in the <b>Element</b> tab.</li> <li>d) Go to <b>Copy &gt; Copy XPath</b> to copy the relative path and select <b>Copy &gt; Copy full XPath</b> to copy the absolute path.</li> </ol>
	Path	<p>It is a numeric representation of the position of a particular control in an application. For web applications, the best practise is to use <b>DOMXPath</b> from the search criteria when compared to <b>Path</b>.</p>
	HTML name and ID	<p>These properties are used to identify an HTML object</p>
	HTML inner text	<p>The DOM innerText Property is used to set or return the text content of a specified node and its descendants</p>



Technology type	Object properties	Description
	HTML tag	HTML tags are like keywords that define the way web browser formats and displays the content. For example, if the captured text has an HTML code: <code>&lt;h3 class="search_results-title"&gt;Search results for "string package"&lt;/h3&gt;</code> , then enter h3 in the HTML tag field.
Microsoft Active Accessibility	Control type	This property is used only as a reference to ensure that the correct object is captured
	Path	It is a numeric representation of the position of a particular control in an application
	Name	This specifies a name of an element and works as an identifier
	ID	This specifies the ID of an element and works as an identifier
Java Technology	Control type	This property is used only as a reference to ensure that the correct object is captured
	Path	It is a numeric representation of the position of a particular control in an application
Microsoft UI Automation	Control type	This property is used only as a reference to ensure that the correct object is captured
	Path	It is a numeric representation of the position of a particular control in an application
	Name	This specifies a name of an element and works as an identifier
	ID	This specifies the ID of an element and works as an identifier
	IsFirst	This property enables the bot to detect the first object based on your search criteria instead of traversing the entire tree. You can use this property when an object does not have a unique Automation ID and the object hierarchy changes in the application.
Microsoft UI Automation (COM)	Control type	This property is used only as a reference to ensure that the correct object is captured.
	Path	It is a numeric representation of the position of a particular control in an application.
	Name	This specifies a name of an element and works as an identifier.
	ID	This specifies the ID of an element and works as an identifier.

The bot uses the selected properties to identify the object control at runtime.

- a) Verify that the **Control Type** matches your intended object.

For example, when capturing a table from a website, ensure the **Control Type** and **HTML Tag** values are **Table**.

If the **Control Type** does not match your intended object, recapture the object control.

- b) Select and assign values to the object properties that you want to include in the object search.

For a more reliable bot, we recommend that you select only the properties that have static values (such as **Name**, **Class**, **Type**, **HTML ID**, and **DOMXPath**), and deselect the properties that have dynamic values (such as **HTML Href**, **Path** or **Value**), which are subject to change and cause bot errors.

It is a best practice to use the wildcard character (\*) or variable in object property values to search for objects whose properties are dynamic and changes frequently.

---

**Note:** Wildcard character matching is currently not supported for SAP technology. When you execute a bot with a wildcard character, it matches the property values exactly as specified in the search criteria.

---

9. Select the **Action** from the drop-down list.

For a full list of possible actions by object, see [Actions performed on objects captured with Universal Recorder](#) on page 2923.

- If you record a click and keystrokes in a text box with a **Control Type** of `Password text`, the **Recorder** does not capture the keystrokes entered into the field. Instead, the action selects the **Set text** option and offers options to securely input the password. We recommend that you store the password in the Credential Vault and insert it into the action as a credential.

See [Credentials and credential variables in the Bot editor](#) on page 2344.

If you navigate to the text box using the TAB keystroke instead of a click in an MSAA or SAP application, the **Recorder** is able to identify fields with a **Control Type** of `Password text`.

- If the selected **Action** supports background processing, a **Run in the background** option appears.

See [Background processing](#) on page 2240.

10. From the **Set system time out** field, select either `Basic` or `Advanced`.

- **Basic:** In the Wait for system response (in seconds) field, specify the number of seconds the bot must wait for object control to appear on the application window. This wait time includes the wait time for both page load and object search.

We recommend setting a delay time when using the Set text action to enter keystrokes into a text field.

---

**Note:** The timeout specified for the bot to wait for the control to appear on the application window applies only if the window in which the control is present exists. The Recorder first looks for the application window and only then searches for the object inside that window. The default time to search for the window is 30 seconds. Hence, even if you specify the wait time as 5 seconds, it still waits for 30 seconds by default if the window does not exist.

We recommend that you first use the **If > Window exists** condition, specify a wait time of zero second and ensure that the application window exists. If the window exists then use the Recorder, specify a wait time of 5 seconds, and run the bot to detect the object.

- **Advanced:** Use this option to automate websites that are constantly loading and updating with latest data such as a stocks website. These websites are never technically fully loaded on screen. In such cases, the bot does not need to wait for the web page to load completely and can directly proceed with automating the web page after a certain time.

In the Wait for browser response (in seconds) field, specify the number of seconds the bot must wait for the browser to load. Select one of the below options:

- **Stop the bot and display an error message:** If the web page has not loaded completely within the specified time out, select this option to stop the bot and display an error message.
- **Skip and proceed to the object:** Select this option to proceed to the object directly and capture it even if the web page has not loaded completely.

In the Wait for object response (in seconds) field, specify the number of seconds the bot must wait for object control to appear on the application window.

**11.** Optional: Assign the output to a variable.

The Control Room suggests a descriptive default variable name based on the action you selected in step 8. For example, if you selected **Get property**, the suggested output variable is `PropertyValue`. If you create several output variables, subsequent variable names are appended with a `-1` to avoid duplication.

**12.** Click **Save**.

The captured images are not added as dependencies and will not be displayed in the dependencies list when you check in your bot.

Link an object to a supporting anchor

---

**Note:** You can use object anchoring in Microsoft Active Accessibility, Microsoft UI Automation, or Java applications.

---

At runtime, if the bot cannot reliably identify an object, link it to a nearby object (such as a link or button) that is easier for the bot to find:

1. Open the **Capture** action.
2. Click the **Anchor** tab.
3. Click **Capture anchor**.

The browser or application window activates with the main object highlighted (the object that you previously captured). A dialog box appears, verifying whether the action has correctly identified the main object.

4. If the correct object is highlighted, click **Yes, Select anchor**.

Otherwise, click **No, I need to correct it** to select the correct object.

5. Select a nearby object to the target object that is easier for the bot to find.

The object is highlighted with an anchor icon on the right of the object.

6. Click **Save**.

## Capture using specific technology

In some applications, the **Capture** action might not work accurately if the technology for capturing is selected automatically. In such cases, based on the type of application that you want to automate, you can select a specific technology and use the **Capture** action to capture using that technology.

## Using the Capture action

To select a specific technology, click the drop-down next to **Capture object**.

You can select a specific technology and automate the following applications:

- Automate web applications that have nested iFrames with the same frame source or different frame sources.
- Capture and automate objects on applications where automatic selection of technology might not capture accurately.

---

**Note:** When you capture using a specific technology, the type and the number of object properties differ.

---

- Automate all objects and controls on the Google Chrome and Microsoft Edge browsers for local setting pages.

---

**Note:** This functionality is supported for Google Chrome and Microsoft Edge browsers.

---

## Technology types

You can capture objects with the following technologies:

- Microsoft Active Accessibility (MSAA)
- Microsoft UI Automation
- Microsoft UI Automation (COM)

## Microsoft Active Accessibility (MSAA)

Microsoft Active Accessibility is a legacy accessibility technology that was introduced as a platform add-in for Windows 95. MSAA is designed to help Assistive Technology (AT) products interact with standard and custom user interface elements of an application and also to access, identify, and manipulate an application's UI elements. MSAA is based on the Component Object Model (COM), which defines a mechanism for applications and operating systems to communicate. To know more about the most commonly used properties in this technology, see [Using the Capture action](#) on page 2940.

## Microsoft UI Automation

Microsoft UI Automation is an accessibility framework for Microsoft Windows, and it is available on all operating systems that support Windows Presentation Foundation (WPF). UI Automation

provides programmatic access to most user interface elements on the desktop, enabling AT products such as screen readers to provide information about the UI to end users and to manipulate the UI by means other than standard input. To know more about the most commonly used properties in this technology, see [Using the Capture action](#) on page 2940.

## Microsoft UI Automation (COM)

Microsoft UI Automation (COM) runs on unmanaged code and delivers automation faster than UI Automation. You can capture the following controls using the Microsoft UI Automation (COM) technology:

- Button
- Calendar
- Check box
- Client
- Combo box
- Label
- Link
- List view
- Menu
- Page Tab
- Password text
- Radio button
- Slider
- Table
- Text box
- Tree

When you select this technology to capture an object on an application, if that object is not supported for the technology, that is indicated by a gray highlight around the object.

---

**Note:** Microsoft UI Automation (COM) provides a search criterion (property) called **Automation ID**, which is unique to this technology.

---

## Automate applications running on remote machines

Sometimes business applications run on remote machines and are accessed over VMware Horizon VDIs. You can automate these business applications using our native Remote Agent installed over a VMware VDI device.

## Automate applications accessed over VMware

Our native Remote Agent enables secure communication between VMware VDI and the Bot Agent. It provides object level information for automation creation and play back thus enhancing the automation coverage for new use cases while providing a reliable native desktop user experience.

VMware-based automation is supported for all the VMware protocols such as: VMware Blast, PCoIP, and Microsoft RDP. This eliminates the need for any security exceptions by IT Administrators.

## Prerequisites

Before you automate, you must install and run the Remote Agent on VMware VDI.

---

**Note:** To automate web pages using HTML technology, you must enable the Google Chrome and Microsoft Edge extensions .

---

## Supported applications

VMware-based automation supports the following types of applications:

- Web applications
- Java applications
- Windows applications

## Supported technologies

VMware-based automation supports object detection on the applications built using the following technologies:

- Microsoft Active Accessibility (MSAA)
- Microsoft UI Automation
- Java
- HTML - Chrome, Edge, Edge with IE mode

## Known behavior

- You can only automate applications running inside VMware VDI using the **Capture** action.
- You can only capture applications running over VMware VDI in full screen mode.

---

**Note:** Ensure that you launch the VMware VDI from the VMware Horizon Client.

---

- If you have multiple monitors with full screen mode, then the left monitor must be your primary monitor.
- Anchor capture is currently not supported.
- Microsoft UI Automation (COM) technology is currently not supported.
- SAP technology is currently not supported.

## Automate right-click action on objects hidden behind runtime window

Sometimes the objects that you want to automate appear behind the bot runtime window. In such cases, the window is minimized and then reactivated after the action is executed enabling you to successfully automate such objects.

When you perform a right-click action on a browser window, the context menu opens. When you try to click any option in this menu, it disappears because after you execute the right-click action,

the active browser window changes to a runtime window. As a result, the context menu closes and the bot fails. To automate such scenarios, perform this procedure.

1. Create a window variable.
2. In the **Name** field, enter `RuntimeWindow`.
3. Select a window and in the **Window title** field, enter `Bot running*` and save the updates.
4. From the **Actions** pane, double-click or drag the **Window > Minimize** action.
5. In the **Window** field, select the variable `RuntimeWindow`.
6. Click **Start recording**.
7. From the **Recorder** window, select the specific browser window.
8. In the **Window** field, select the specific browser window.
9. Execute the **Right click** action on the specific browser page.
10. Select any option from the context menu.
11. From the **Actions** pane, double-click or drag the **Window > Restore** action.
12. In the **Window** field, select the variable `RuntimeWindow`.
13. Save and run the bot.

## Simplified recording experience

Professional and Citizen developers can use the Recorder to start a recording directly from a business application. You no longer need to identify the target business application from a list of applications opened. This enables a simpler and faster recording experience with real-time visibility and control of the automated actions.

---

### Important:

- The simplified Recorder feature is not available out of the box and can be enabled on an on-demand basis. Contact your Automation Anywhere account team for assistance.
- This feature is supported with Recorder package (version 2.15.2-20231004-180246 and later).

---

## Real-time feedback

- Simplified Recorder provides real-time feedback on the objects captured.  
For example, if you accidentally have any false clicks, missing clicks, or additional clicks, these are shown in the capture area in the Recorder window. This real-time feedback enables you to review the recorded actions, preview the images that you captured, and take actions in the midst of the recording. The captured object is also highlighted for better visibility.
- You can use the Delete icon to delete any captured object and recapture the object if required.
- You can use the arrow above the captured area to traverse through the objects you captured earlier.

## Using the simplified Recorder

1. Click **Start Recording** from the Bot editor.

2. Select the **Recorder type: Universal** or **AI Sense**.
3. Open the target application.
4. Navigate to the target window or browser tab.
5. Click **Record** to begin.

## Recorder actions supported in various SAP versions

Review the information about the various actions of the Recorder package that are supported with Automation 360 and which SAP GUI versions support them.

Control name	Automation 360 supported action	SAP Logon 730 (Patch 15)	SAP Logon 740 (Patch 19)	SAP Logon 750 (Patch 10)	SAP Logon 760 (Patch 5)	SAP Logon 770 (Patch 6)
Text box  (It includes controls such as: GuiTextField, GuiTextField, GuiOkCodeField, GuiShell:TextEdit, GuiTextEdit, and GuiPasswordField)	Set text	Yes	Yes	Yes	Yes	Yes
	Append text	Yes	Yes	Yes	Yes	Yes
	Get property	Yes	Yes	Yes	Yes	Yes
	Set focus	Yes	Yes	Yes	Yes	Yes
	Left-click	Yes	Yes	Yes	Yes	Yes
	Right-click	Yes	Yes	Yes	Yes	Yes
	Double-click	Yes	Yes	Yes	Yes	Yes
Combo box  It includes the control: GuiComboBox	Select item by index	Yes	Yes	Yes	Yes	Yes
	Select item by text	Yes	Yes	Yes	Yes	Yes
	Select item by key	Yes	Yes	Yes	Yes	Yes
	Expand	Yes	Yes	Yes	Yes	Yes
	Get total items	Yes	Yes	Yes	Yes	Yes
	Get selected text	Yes	Yes	Yes	Yes	Yes
	Get selected item key	Yes	Yes	Yes	Yes	Yes
	Get selected index	Yes	Yes	Yes	Yes	Yes



Control name	Automation 360 supported action	SAP Logon 730 (Patch 15)	SAP Logon 740 (Patch 19)	SAP Logon 750 (Patch 10)	SAP Logon 760 (Patch 5)	SAP Logon 770 (Patch 6)
	Get property	Yes	Yes	Yes	Yes	Yes
	Set focus	Yes	Yes	Yes	Yes	Yes
	Left-click	Yes	Yes	Yes	Yes	Yes
	Right-click	Yes	Yes	Yes	Yes	Yes
	Double-click	Yes	Yes	Yes	Yes	Yes
Check box	Check	Yes	Yes	Yes	Yes	Yes
It includes the control: GuiCheckBox	Uncheck	Yes	Yes	Yes	Yes	Yes
	Toggle	Yes	Yes	Yes	Yes	Yes
	Get status	Yes	Yes	Yes	Yes	Yes
	Get property	Yes	Yes	Yes	Yes	Yes
	Set focus	Yes	Yes	Yes	Yes	Yes
	Left-click	Yes	Yes	Yes	Yes	Yes
	Right-click	Yes	Yes	Yes	Yes	Yes
	Double-click	Yes	Yes	Yes	Yes	Yes
Button	Click	Yes	Yes	Yes	Yes	Yes
It includes the control: GuiButton	Get property	Yes	Yes	Yes	Yes	Yes
	Set Focus	Yes	Yes	Yes	Yes	Yes
	Left-click	Yes	Yes	Yes	Yes	Yes
	Right-click	Yes	Yes	Yes	Yes	Yes
	Double-click	Yes	Yes	Yes	Yes	Yes
Radio button	Select	Yes	Yes	Yes	Yes	Yes
It includes the control: GuiRadioButton	Get status	Yes	Yes	Yes	Yes	Yes
	Get property	Yes	Yes	Yes	Yes	Yes
	Set focus	Yes	Yes	Yes	Yes	Yes
	Left-click	Yes	Yes	Yes	Yes	Yes
	Right-click	Yes	Yes	Yes	Yes	Yes

Control name	Automation 360 supported action	SAP Logon 730 (Patch 15)	SAP Logon 740 (Patch 19)	SAP Logon 750 (Patch 10)	SAP Logon 760 (Patch 5)	SAP Logon 770 (Patch 6)
	Double-click	Yes	Yes	Yes	Yes	Yes
Table It includes the control: GuiTableControl	Set cell by index	Yes	Yes	Yes	Yes	Yes
	Set cell by text	Yes	Yes	Yes	Yes	Yes
	Get cell text by index	Yes	Yes	Yes	Yes	Yes
	Get cell index by text	Yes	Yes	Yes	Yes	Yes
	Get total rows	Yes	Yes	Yes	Yes	Yes
	Get total columns	Yes	Yes	Yes	Yes	Yes
	Select row	Yes	Yes	Yes	Yes	Yes
	Select all	Yes	Yes	Yes	Yes	Yes
	Deselect all	Yes	Yes	Yes	Yes	Yes
	Get property	Yes	Yes	Yes	Yes	Yes
	Set focus	Yes	Yes	Yes	Yes	Yes
	Left-click	Yes	Yes	Yes	Yes	Yes
	Right-click	Yes	Yes	Yes	Yes	Yes
	Double-click	Yes	Yes	Yes	Yes	Yes
	Get table	Yes	Yes	Yes	Yes	Yes
Menu bar It includes the control: GuiMenuBar	Select item by text	Yes	Yes	Yes	Yes	Yes
	Get property	Yes	Yes	Yes	Yes	Yes
	Set focus	Yes	Yes	Yes	Yes	Yes
	Left-click	Yes	Yes	Yes	Yes	Yes
	Right-click	Yes	Yes	Yes	Yes	Yes
	Double-click	Yes	Yes	Yes	Yes	Yes

Control name	Automation 360 supported action	SAP Logon 730 (Patch 15)	SAP Logon 740 (Patch 19)	SAP Logon 750 (Patch 10)	SAP Logon 760 (Patch 5)	SAP Logon 770 (Patch 6)
	Get total items	Yes	Yes	Yes	Yes	Yes
	Select item by index	Yes	Yes	Yes	Yes	Yes
	Select item by text	Yes	Yes	Yes	Yes	Yes
Tree It includes the control: GuiShell: :Tree	Expand node	Yes	Yes	Yes	Yes	Yes
	Get property	Yes	Yes	Yes	Yes	Yes
	Set focus	Yes	Yes	Yes	Yes	Yes
	Get total items	Yes	Yes	Yes	Yes	Yes
	Get selected index	Yes	Yes	Yes	Yes	Yes
	Get selected text	Yes	Yes	Yes	Yes	Yes
	Select item by index	Yes	Yes	Yes	Yes	Yes
	Select item by text	Yes	Yes	Yes	Yes	Yes
	Left-click	Yes	Yes	Yes	Yes	Yes
	Right-click	Yes	Yes	Yes	Yes	Yes
	Double-click	Yes	Yes	Yes	Yes	Yes
Tab It includes the control: GuiTab	Select	Yes	Yes	Yes	Yes	Yes
	Scroll left	Yes	Yes	Yes	Yes	Yes
	Get property	Yes	Yes	Yes	Yes	Yes
	Set focus	Yes	Yes	Yes	Yes	Yes
	Left-click	Yes	Yes	Yes	Yes	Yes
	Right-click	Yes	Yes	Yes	Yes	Yes
	Double-click	Yes	Yes	Yes	Yes	Yes

Control name	Automation 360 supported action	SAP Logon 730 (Patch 15)	SAP Logon 740 (Patch 19)	SAP Logon 750 (Patch 10)	SAP Logon 760 (Patch 5)	SAP Logon 770 (Patch 6)
Grid view It includes the control: GuiShell: GridView	Select all	Yes	Yes	Yes	Yes	Yes
	Select cell by index	Yes	Yes	Yes	Yes	Yes
	Select cell by text	Yes	Yes	Yes	Yes	Yes
	Set current cell row	Yes	Yes	Yes	Yes	Yes
	Select row	Yes	Yes	Yes	Yes	Yes
	Click on cell by index	Yes	Yes	Yes	Yes	Yes
	Double-click current cell	Yes	Yes	Yes	Yes	Yes
	Get total rows	Yes	Yes	Yes	Yes	Yes
	Get total columns	Yes	Yes	Yes	Yes	Yes
	Get cell by index	Yes	Yes	Yes	Yes	Yes
	Get cell index by text	Yes	Yes	Yes	Yes	Yes
	Get property	Yes	Yes	Yes	Yes	Yes
	Set focus	Yes	Yes	Yes	Yes	Yes
	Left-click	Yes	Yes	Yes	Yes	Yes
	Right-click	Yes	Yes	Yes	Yes	Yes
	Double-click	Yes	Yes	Yes	Yes	Yes
	Get table	Yes	Yes	Yes	Yes	Yes
Main window It includes the control: GuiMainWindow	Send VKey	Yes	Yes	Yes	Yes	Yes
	Get focus control ID	Yes	Yes	Yes	Yes	Yes
	Get property	Yes	Yes	Yes	Yes	Yes
	Set focus	Yes	Yes	Yes	Yes	Yes

Control name	Automation 360 supported action	SAP Logon 730 (Patch 15)	SAP Logon 740 (Patch 19)	SAP Logon 750 (Patch 10)	SAP Logon 760 (Patch 5)	SAP Logon 770 (Patch 6)
	Left-click	Yes	Yes	Yes	Yes	Yes
	Right-click	Yes	Yes	Yes	Yes	Yes
	Double-click	Yes	Yes	Yes	Yes	Yes
Toolbar It includes the control:	Click button by index	Yes	Yes	Yes	Yes	Yes
Toolbar control	Select content menu item by text	Yes	Yes	Yes	Yes	Yes
	Get property	Yes	Yes	Yes	Yes	Yes
	Left-click	Yes	Yes	Yes	Yes	Yes
	Right-click	Yes	Yes	Yes	Yes	Yes
	Double-click	Yes	Yes	Yes	Yes	Yes
Label It includes the control:	Get property	Yes	Yes	Yes	Yes	Yes
GuiLabel	Set focus	Yes	Yes	Yes	Yes	Yes
	Left-click	Yes	Yes	Yes	Yes	Yes
	Right-click	Yes	Yes	Yes	Yes	Yes
	Double-click	Yes	Yes	Yes	Yes	Yes
Rest of the control (It includes controls such as:	Get property	Yes	Yes	Yes	Yes	Yes
GuiMainWindow, GuiBox, GuiUserArea, GuiTitlebar, and GuiStatusBar)	Set focus	Yes	Yes	Yes	Yes	Yes
	Left-click	Yes	Yes	Yes	Yes	Yes
	Right-click	Yes	Yes	Yes	Yes	Yes
	Double-click	Yes	Yes	Yes	Yes	Yes

## Recorder actions supported with SAP FIORI

Review the information about the various actions of the Recorder package that are supported with SAP FIORI.

Control name	Automation 360 supported action	SAP Fiori support
Button	Click	Yes
	Get property	Yes
	Left-click	Yes
	Right-click	Yes
	Double-click	Yes
Text box	Set text	Yes
	Append text	Yes
	Get property	Yes
	Click	Yes
	Left-click	Yes
	Right-click	Yes
	Double-click	Yes
Combo box	Select item by index	No
	Select item by text	No
	Select item by key	No
	Expand	No
	Get total items	No
	Get selected text	No
	Get selected item key	No
	Get selected index	No
	Get property	No
	Click	No
	Left-click	No
	Right-click	No
	Double-click	No
	Check box	Check
Uncheck		No
Toggle		No
Get status		Yes

Control name	Automation 360 supported action	SAP Fiori support
	Get property	No
	Click	Yes
	Left-click	Yes
	Right-click	Yes
	Double-click	Yes
Client	Get property	Yes
	Click	
	Left-click	
	Right-click	
	Double-click	
	Get all children name	
	Get all children value	
Radio button	Select	No
	Get status	No
	Get property	Yes
	Left-click	Yes
	Right-click	Yes
	Double-click	Yes
Table	Set cell by index	No
	Set cell by text	No
	Get cell text by index	Yes
	Get cell index by text	Yes
	Get total rows	Yes
	Get total columns	Yes
	Click on cell by index	No
	Click on cell by text	No
	Get property	Yes
	Left-click	No
	Right-click	No
	Double-click	No
	Get table	No
	Click	No

Control name	Automation 360 supported action	SAP Fiori support
Tab	Select	No
	Scroll left	No
	Get property	No
	Set focus	No
	Left-click	No
	Right-click	No
	Double-click	No
Label	Get property	Yes
	Click	Yes
	Left-click	Yes
	Right-click	Yes
	Double-click	Yes
Link	Right-click	No
	Double-click	No
	Left-click	No
	Click	Yes
	Get property	No
Listview	Get property	Yes
	Click	Yes
	Left-click	Yes
	Right-click	Yes
	Double-click	Yes
	Get total items	Yes
	Get selected index	Yes
	Get selected text	Yes
	Select item by text	Yes
	Select item by index	Yes



## REST Web Service package

Use the actions in the REST Web Service package as methods (DELETE, GET, PATCH, POST, or PUT) to send requests to and receive responses from an API.

### Working with REST Web Service actions

Provide the following information to send a REST request and receive a response. Not all parameters are required for all methods.

- **Enter the URI:** A unique address for an API resource.
- **Proxy configuration:** To set the proxy, select the **System** or **Custom** tab from Proxy configuration.

Option	Description
System	System proxy is the proxy configured on the bot runner machine where the bot is running.  If this option is selected, the Bot Agent uses the system proxy.

Option	Description
Custom	<p>This option allows you to configure custom proxy settings within the actions of REST Web Service. For example, if a REST API is required to be routed through a different proxy other than the system proxy, you can select the <b>Custom</b> option and provide proxy details within the REST actions.</p> <p>Provide the following details:</p> <ul style="list-style-type: none"> <li>• <b>Host:</b> The host name or IP address of the proxy</li> <li>• <b>Port:</b> The port number of the proxy</li> <li>• <b>Username (Optional):</b> The username used for the proxy authentication</li> <li>• <b>Password (Optional):</b> The password used for the proxy authentication</li> </ul> <hr/> <p><b>Note:</b> If the proxy to be configured is authenticated proxy, then you must provide authentication credentials in the <b>Username</b> and <b>Password</b> fields.</p> <hr/> <p>For <b>Host, Port, Username, and Password</b> fields, choose from <b>Credential, Variable, or Insecure string</b> tab :</p> <ul style="list-style-type: none"> <li>• <b>Credential:</b> Use a value available in the credential vault.</li> <li>• <b>Variable:</b> Use a variable that stores a credential value in a user-defined variable.</li> <li>• <b>Insecure string:</b> Manually specify the value that you want to use.</li> </ul>

- **Authentication Mode:** There are three supported authentication modes:
  - **No Authentication:** Use this option to access the endpoints that does not require authentication to access their servers.
  - **Basic:** Basic is the simplest way to authenticate users. When you select this option, you will enter the username and password. This technique uses a header called Authorization, with a base64 encoded representation of the username and password entered.
  - **Logged-in AD User:** Active Directory (AD) users that are authorized to access the related API are authenticated through AD. No credentials are required in the request.
  - **Windows NT LAN Manager (NTLM) Authentication (AD User):** A challenge/response authentication method that allows clients to provide their user name and password as encrypted credentials or plain text. We recommend that you use credentials that are stored in the Automation Anywhere Credential Vault.
  - **OAuth2 - Control Room managed:** When you integrate OAuth with the Control Room, you can centrally manage and securely store tokens that are used to authenticate with third-

party providers. You must configure the web service and make note of the authentication details (such as client ID, client secret, authorization URL, and so on) to use the OAuth connection in the Control Room. For more details, see [Configure OAuth connections in Control Room](#) on page 1889

The following video shows how to use OAuth connection in REST Web Service:

- **Header:** Not all methods require a header. Headers represent the metadata associated with the request.
- **Content type:** When a header contains a content type, it defines the content negotiation between the client and the server. REST Web Service actions support the following content types:
  - `application/x-www-form-urlencoded`: Encode the parameters in the URL.
  - `JSON (application/json)`: Enter a JSON request body.
  - `XML (application/xml)`: Enter an XML request body.
  - `Text (text/plain)`
  - `XML (text/xml)`
  - `HTML (text/html)`
  - `multipart/form-data`: Send binary data, in most cases for uploading files to the server.
- **Add substitution:** Allows you to enter variables in the REST request body. A variable is a symbolic representation of data, and it enables you to access a value without having to enter it manually wherever you need it. For example, consider the following REST body request:

```
{
  "name": "{{name}}",
  "email": "{{email}}",
  "status": "Active"
}
```

In the above request body, you can replace the variables enclosed within double braces by clicking **Add substitution** and adding the required values.

- **Advanced options:**
  - **Capture failure response:** Select the check box to capture the failure response except for the `Success/Ok` response. The failure response details are captured in the response body.
  - **Allow insecure connection when using https:** Select the check box to allow insecure connection when using https.
- **Wait for action to complete:** You can set a time-out value when you send a REST request and receive a response. When performing actions such as POST, PUT, DELETE, PATCH, and GET, in the **Wait for action to complete** field, you can specify the wait time (in milliseconds). By default, the wait time is 60000 milliseconds.
- **Output variable:** The response output is captured in a dictionary variable. A dictionary variable is a key-value pair. Use the response header name as key to return the header value, or "Body" as the key to return the response body.

---

**Note:** The response key with its value is available in the dictionary variable to display the response status of the REST API.

---

To obtain a list of the header names for the API resource, perform these steps:

1. Insert a **Loop** action after the REST Web Service action.
2. Select the **For each key in the dictionary** iterator.

3. In the **Dictionary variable** field, select the variable that holds the REST Web Service action output.
4. Assign the value of each key to `$prompt-assignment$`.
5. Insert a Log To File action.
6. Provide the file path to a text file to hold the list of header names.
7. Insert `$prompt-assignment$` in the **Enter text to log** field.
8. Select the **Overwrite existing file** option.
9. Click **Save**.

When you run the bot, it prints the header names from the API resource to the selected file.

## Passing values securely

You can securely pass values from the Credential Vault to the web service by specifying the locker, credential, and attribute in the following supported action fields:

- URI
- Custom headers
- Body: For the `application/x-www-form-urlencoded` content type, click **Add parameter** to select the value from the Credential Vault.

For all other content types, select the **Select credential as parameters** option and click **Pick**.

## Actions in the REST Web Service package

Action	Description
Delete method	Removes the resource that is identified by the URI.
Get method	<p>Retrieves information identified by parameters included in the URI. There is no <b>Content type</b> for the GET method because all the parameters are passed as part of the URI.</p> <p>Limitations and characteristics of the <b>GET</b> method include the following:</p> <ul style="list-style-type: none"> <li>• URI length is limited to 2048 characters.</li> <li>• All parameters are passed in the URI.</li> <li>• The <b>GET</b> method exposes data that is in the URI, making it less secure than the <b>POST</b> method.</li> <li>• <b>GET</b> does not change any data, making it safe for all users regardless of authorization.</li> </ul> <p>See <a href="#">Using the Get method</a> on page 2965.</p>
Patch method	Modifies the resource that is identified by the URI.

Action	Description
Post method	<p>Creates a new resource in the URI.</p> <ul style="list-style-type: none"> <li>Parameters are passed in request body.</li> <li>There is no limit on length for a request body.</li> </ul> <p>See <a href="#">Using the Post method</a> on page 2967.</p>
Put method	<p>Updates or replaces a resource based on parameters passed in the URI or body. See <a href="#">Using the Put method</a> on page 2970.</p>

## Proxy support

If your device is configured with a proxy, all outbound requests from this package are routed through the proxy server. See [Connect Bot Agent to a device with a proxy](#) on page 1351.

Related tasks

[Example of building a bot that uses credential variables](#) on page 2348

Securely pass values to a bot using credential variables to automate the process of logging in to a bank website.

Related reference

[Credentials and credential variables in the Bot editor](#) on page 2344

Use credentials when building bots to pass sensitive information such as passwords and account numbers. Using credentials separates the sensitive information from the bots and Bot Runners, which reduces the risk of data spillage or unauthorized user access.

[Rest Web Services package updates](#) on page 944

Review the updates in released versions of the Rest Web Services package such as new and enhanced features as well as fixes and limitations. The page also lists the release dates of each version, and the compatible Control Room and Bot Agent versions.

## Using the Get method

Use the **Get method** actions from the REST Web Service package to retrieve or get the information identified by parameters included in the URI .

This example uses endpoints from the Swagger Petstore sample API ([Petstore](#)) to demonstrate using Get method action to retrieve data from the Petstore database.

---

**Note:** GET method action does not take any request body.

---

1. Create a new .
  - a) Log in to your instance of the .
  - b) On the left panel, click **Automation**.
  - c) Click **Create new > Bot**.
  - d) In the **Create Task Bot** window, enter the name.
  - e) Accept the default folder location: \Bot.s\  
To change the default storage location, click **Choose** and follow the prompts.

f) Click **Create and edit**.

2. Use the **Get method** action to retrieve a list of all the available pets.

a) Double-click or drag the **REST Web Services > Get method** action.

The screenshot shows the Automation Anywhere Test-bot interface. On the left, the 'Actions' pane is open, and the 'REST Web Services > Get method' action is selected. A red arrow labeled 'a' points to this action in the flowchart. The flowchart shows a sequence: Start -> REST Web Services: Get method (request for URI 'https://petsto...') -> Log to file (\$Output{Body}\$ to 'C:\Temp...') -> End. The configuration panel on the right shows the URI 'https://petstore.swagger.io/v2/pet/findByStatus' (labeled 'b'), Authentication Mode set to 'No Authentication' (labeled 'c'), and the output assigned to a variable named 'Output' (labeled 'd').

b) Enter the following URI:

```
https://petstore.swagger.io/v2/pet/findByStatus?status=available
```

c) Under **Authentication Mode** drop-down, select **No Authentication** as this endpoint does not require authentication.

**Note:** Typically endpoint requires authentication to ensure that only authorized applications are able to access the data. Select an appropriate authentication mechanism to allow access to the endpoint you want to access.

d) Create the variable **Output** in the **Assign the output to a variable** field. For more information on creating a variable, see [Create a variable](#) on page 2336.

3. Insert a **Log to file** action to see the response body.

a) Double-click or drag the **Log to file** action.

b) Provide the file path to a text file.

c) In the **Enter text to log** field, enter `$Output {Body} $`.

4. Click **Save** and then click **Run**.

The bot retrieves the response body and saves it to the text file.

---

**Note:** You cannot use the download API endpoints to download an exported bot or file in the REST Web Service package.

---

See also

- [REST Web Service package](#) on page 2961
- [Using the Post method](#) on page 2967
- [Using the Put method](#) on page 2970
- [Upload file with Put method](#) on page 2971

## Using the Post method

Use the **Post method** actions from the REST Web Service package to create new resources in the URI.

This example uses endpoints from the Swagger Petstore sample API ([Petstore](#)) to demonstrate using Post method action to add data to the Petstore database.

1. Create a new .
  - a) Log in to your instance of the .
  - b) On the left panel, click **Automation**.
  - c) Click **Create new > Bot**.
  - d) In the **Create Task Bot** window, enter the name.
  - e) Accept the default folder location: `\Bots\`  
To change the default storage location, click **Choose** and follow the prompts.
  - f) Click **Create and edit**.
2. Use the **Post method** action to send data to a server. In this example, a new pet is added to the store.

- a) Double-click or drag the **REST Web Services > Post method**

The screenshot displays the Automation Anywhere configuration window for a REST Web Services Post method. The left sidebar shows the 'REST Web Services' folder expanded, with 'Post method' selected. The main workspace shows a flowchart with a 'REST Web Services: Post method' action (labeled 'a') connected to a 'Message box' action. The right-hand configuration pane is open, showing the following settings:

- URI:** `https://petstore.swagger.io/v2/store/order` (labeled 'b')
- Authentication Mode:** No Authentication (labeled 'c')
- Content type:** JSON (application/json) (labeled 'd')
- Custom parameters:** Enter the parameters (labeled 'e') with a JSON body:
 

```
{
  "id": 0,
  "petId": 0,
  "quantity": 0,
  "shipDate": "2022-04-20T22:08:11.97",
  "status": "placed",
  "complete": true
}
```
- Wait for action to complete (in milliseconds):** 60000 (labeled 'f')
- Assign the output to a variable:** Output (labeled 'g')

action.

- b) Enter the following URI:

`https://petstore.swagger.io/v2/store/order`

- c) **Proxy Configuration:** Do one of the following:



- **System:** Under **Authentication Mode** select the authentication. In this example, select No Authentication as this endpoint does not require authentication.

---

**Note:** Typically endpoint requires authentication to ensure that only authorized applications are able to access the data. Select an appropriate authentication mechanism to allow access to the endpoint you want to access.

---

- **Custom:** This option allows you to configure custom proxy settings within the actions of REST Web Service. For more information, see [REST Web Service package](#) on page 2961.

- d) Select the **Content type** that indicates in which format the data is sent to. An incoming request can have an entity attached to it. The Content type determines the type of the request. Some common Content types include such as: application/x-www-form-urlencoded, JSON (application/json), and XML (application/XML). In this example, select JSON (application/json), copy and paste the following into the **Custom parameters** field:

```
{
  "id": 0,
  "petId": 0,
  "quantity": 0,
  "shipDate": "2022-04-20T22:08:11.977Z",
  "status": "placed",
  "complete": true
}
```

- e) **Add substitution:** Allows you to enter variables in the REST request body. A variable is a symbolic representation of data, and it enables you to access a value without having to enter it manually wherever you need it. For example, consider the following REST body request:

```
{
  "name": "{name}",
  "email": "{email}",
  "status": "Active"
}
```

In the above request body, you can replace the variables enclosed within double braces by clicking **Add substitution** and adding the required values.

- f) Enter a time in milliseconds for the action to complete. You can leave it to the default 60,000.
- g) Create the variable `Output` in the **Assign the output to a variable** field. For more information on creating a variable, see [Create a variable](#) on page 2336.
3. Insert a **Message box** action to see the response body.
- a) Double-click or drag the **Log to file** action.
- b) In the **Enter the message to display** field, enter `$Output {Body} $`.
4. Click **Save** and then click **Run**.  
The bot displays the response in the message box.

See also

- [REST Web Service package](#) on page 2961
- [Using the Get method](#) on page 2965
- [Using the Put method](#) on page 2970
- [Upload file with Put method](#) on page 2971

## Using the Put method

Use the **Put method** actions from the REST Web Service package to update or replace existing resource.

This example uses endpoints from the Swagger Petstore sample API ([Petstore](#)) to demonstrate using Put method action to update data to the Petstore database.

1. Use the **Put method** action to update the pet name to "Pluto" and pet status to "sold".

- a) Double-click or drag the **REST Web Services > Put method** action.
- b) Enter the following URI:

```
https://petstore.swagger.io/v2/pet
```

- c) Open the log file saved in [Using the Get method](#) on page 2965 and copy the Pet ID of the first entry.
- d) Copy and paste the following into the **Custom parameters** field, replacing the text in the angle brackets with the value that you copied from the file:

```
{  
  "petId": 0,  
  "name": "Pluto",  
  "status": "sold"  
}
```

- e) Insert the variable `Output` in the **Assign the output to a variable** field.
2. Move the **Message box** action below the **Put method** action:
    - a) Double-click or drag the **Message box** action.
    - b) In the **Enter text to log** field, enter `$Output {Body} $`.

3. Click **Save** and then click **Run**.

The bot retrieves the response body and prints it to the Message box. A successful response includes `"name": "Pluto", "status": "sold"`.

See also

- [REST Web Service package](#) on page 2961
- [Using the Post method](#) on page 2967
- [Using the Get method](#) on page 2965
- [Upload file with Put method](#) on page 2971

## Upload file with Put method

Use the **Put method** action in the REST Web Service package to upload a file or text.

This example uses endpoints from the Petstore sample API ([Petstore](#)) to demonstrate uploading a new file or text using a multipart/form-data.

1. Use the **Put method** action in conjunction with an API that allows uploading a file.

- a) Double-click or drag the **REST Web Services > Put method** action.
- b) Enter the following URI:

```
https://petstore.swagger.io/v2/pet/112/uploadImage
```

c) From the **Content type** drop-down, select **multipart/form-data**.

The screenshot shows the configuration of the REST Web Services action. The URI is set to `https://petstore.swagger.io/v2/pet/112/uploadImage`. The content type is set to `multipart/form-data`. Two parameters are defined:

Enabled	Name	Type	Value
Yes	file	File	"C:\Temp\icon.png"
Yes	additionalMetadata	Text	"*****"

- d) Add the `file` parameter and provide the path of the file to be uploaded.
- e) Add any other required parameters. For instance, this API takes `additionalMetadata` (for example, "hello"), which is a text input parameter. The additional parameter will also be uploaded.

2. Assign the output to a variable, for example, `Test123`.

1. REST Web Services: Post met... request for URI `https://petsto...`

2. Message box `<Test123(Body)>`

Allow insecure connection when using https  
Warning: Transferred data may be visible to attackers

Wait for action to complete (in milliseconds)  
# 60000 (x)

Increase this value if POST action times out

Assign the output to a variable  
Multiple variables Dictionary

Test123 (x)

Use response header name as key to fetch header value and 'Body' as key to fetch body of response

### 3. Print the output in a message box.

Message box

Displays a message box  
Required bot agent version: 20.11 or above

Enter the message box window title  
Automation Anywhere Enterprise Client (x)

Enter the message to display  
\$Test123(Body)\$ (x)

Scrollbar after lines  
# 30 (x)

Close message box after

See also

- [REST Web Service package](#) on page 2961
- [Using the Post method](#) on page 2967
- [Using the Get method](#) on page 2965
- [Using the Put method](#) on page 2970

## Delete method

Use the **Delete** method action in the REST Web Service package to remove a resource that is identified by the URI.

## Patch method

Use the **Patch** method action in the REST Web Service package to action modify the resource that is identified by the URI.

## Salesforce package

Salesforce is a cloud-based platform that provides software and services to create relevant customer experiences. Use the bot actions developed for the Salesforce package to automate Salesforce processes.

---

**Note:**

The Salesforce mark and logo are trademarks or registered trademarks of Salesforce Inc. and are used for identification purposes only.

---

Salesforce is based on a multi-tenant architecture with benefits such as API integration, configuration, scalability, free capacity, platform support, and more. The Salesforce package uses the Lightning Platform APIs to integrate Automation 360 with Salesforce. RPA developers need to authenticate to build automation processes in Salesforce. After authentication, with the Salesforce Connected App, you can upload or download files, perform CRUD (Create/Insert, Read, Update/ Upsert, Delete) operations on Objects (Salesforce stores data as Objects), and query using SOQL.

The following video shows the initial authentication and command actions from Automation 360:

Two types of objects are available in Salesforce, Standard Objects and Custom Objects. Standard Objects include the configuration and default data types. Custom Objects are the objects that are defined according to business requirements. In this topic, sample CRUD operations will be based on the Case Object, which is a Standard Object. A Case Object is typically used to gather customer data (queries, feedback, or problems). All the samples are based on manipulating the fields of the Case Object. For more information on the Case Object, see [Salesforce Case object](#). All the CRUD operations are initiated from the Automation 360 side and will update data on the Salesforce side.

Related reference

[Salesforce package updates](#) on page 945

Review the updates in released versions of the Salesforce package such as new and enhanced features as well as fixes and limitations. The page also lists the release dates of each version, and the compatible Control Room and Bot Agent versions.

## Salesforce Authentication action

Salesforce Authentication is the first command action that you need to call to get authenticated with Salesforce.

---

**Note:** The examples and graphics provided on this page are for representation purposes only and may not accurately reflect your specific instance. We do not assume responsibility for their maintenance or accuracy.

---

Authenticate access to Salesforce by getting the authentication parameters from the Salesforce connected app and using them in Automation 360.

---

**Note:** Recently, Salesforce implemented the following: OAuth 2.0 Username-Password Flow Blocked by Default in New Orgs. Ensure you **allow** these flows in your Salesforce environment to use the Salesforce package. See [OAuth and OpenID Connect Settings](#).

---

You can use different connection methods to connect to Salesforce:

- **OAuth2 - Client Credentials:** Use this connection method by providing the Salesforce account credentials. You need a Salesforce username and password to establish a connection.
- **Control room OAuth connection:** Use this connection method by creating an OAuth connection and storing it in the Control Room.

1. Log in to the Control Room.
2. Create a new bot or modify an existing bot. For more details, see [Create your first bot](#) on page 1489.
3. From the Actions pane, select **Salesforce > Authentication** and place it under the **Start** of the bot flow.
4. In the **Authentication Type** field, select the authentication method from the drop down.
5. To view client ID and client secret details for **OAuth2 - Client Credentials** authentication, complete the following steps:
  - a) Log in to the Salesforce Enterprise Edition (Lightning Experience - [Salesforce Login](#)), click , and select **Setup** on your connected app. For more information about creating a new connected app, see [Salesforce Connected Apps](#).
  - b) In the Lightning Experience App Manager, click **App Manager**.

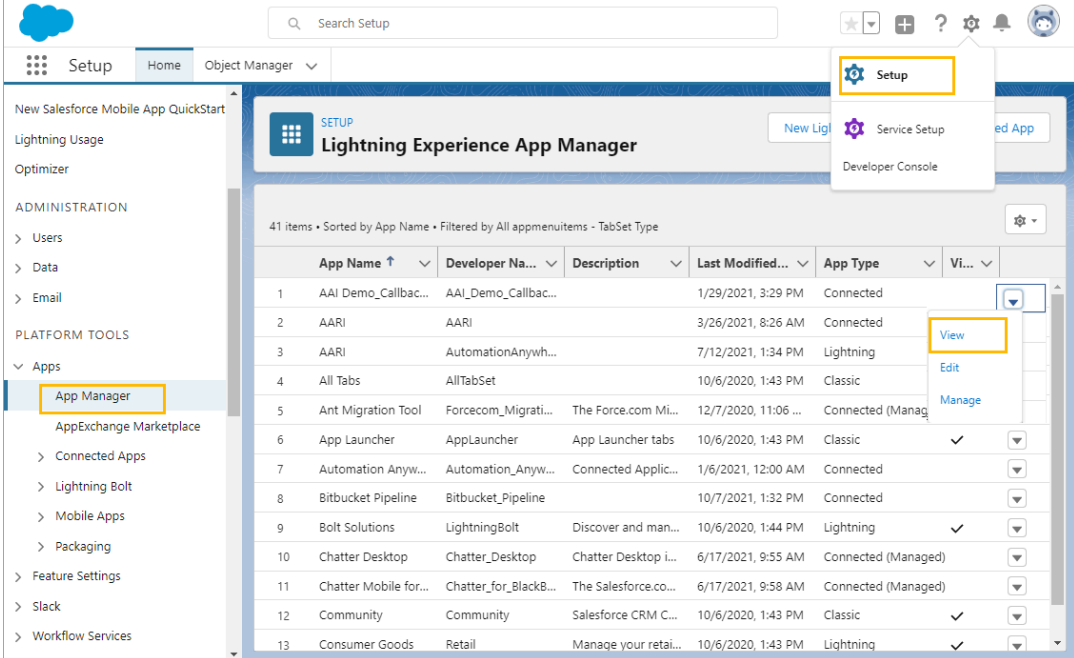

The screenshot shows the Salesforce Lightning Experience App Manager interface. The left sidebar has 'App Manager' highlighted. The main content area displays a table of 41 items, sorted by App Name. The table has columns for App Name, Developer Name, Description, Last Modified, and App Type. A 'View' button is highlighted for the third item, 'AARI'.

	App Name	Developer Name	Description	Last Modified	App Type	VI...
1	AAI Demo_Callbac...	AAI_Demo_Callbac...		1/29/2021, 3:29 PM	Connected	
2	AARI	AARI		3/26/2021, 8:26 AM	Connected	
3	AARI	AutomationAnywh...		7/12/2021, 1:34 PM	Lightning	View
4	All Tabs	AllTabSet		10/6/2020, 1:43 PM	Classic	Edit
5	Ant Migration Tool	Forcecom_Migrati...	The Force.com Mi...	12/7/2020, 11:06 ...	Connected (Manag...	Manage
6	App Launcher	AppLauncher	App Launcher tabs	10/6/2020, 1:43 PM	Classic	✓
7	Automation Anyw...	Automation_Anyw...	Connected Applic...	1/6/2021, 12:00 AM	Connected	✓
8	Bitbucket Pipeline	Bitbucket_Pipeline		10/7/2021, 1:32 PM	Connected	✓
9	Bolt Solutions	LightningBolt	Discover and man...	10/6/2020, 1:44 PM	Lightning	✓
10	Chatter Desktop	Chatter_Desktop	Chatter Desktop i...	6/17/2021, 9:55 AM	Connected (Managed)	✓
11	Chatter Mobile for...	Chatter_for_BlackB...	The Salesforce.co...	6/17/2021, 9:58 AM	Connected (Managed)	✓
12	Community	Community	Salesforce CRM C...	10/6/2020, 1:43 PM	Classic	✓
13	Consumer Goods	Retail	Manage your retai...	10/6/2020, 1:43 PM	Lightning	✓

- c) Click the down arrow next to app name and select **View**.  
The **Manage Connected Apps** screen appears. For more information about managing connected apps, see [Salesforce Manage Connected Apps](#).
- d) Click **Manage Consumer Details**.
- e) Click **Copy** that corresponds to **Consumer Key**.

- f) Click **Copy** that corresponds to **Consumer**

Secret. Administrator

Connected App Name  
AAI Demo\_Callback Connected App

Consumer Details

Consumer Key	3MV...NK3avhIOI72g_	Copy
Consumer Secret	9D684...F77972EC1	Copy

Staged Consumer Details

Generate Apply Cancel

6. To connect using OAuth2 - Client Credentials, complete the following steps:
- a) In the **Client ID** field, paste the **Consumer Key** copied from the Salesforce Connected App. In this illustration **Insecure string** is used, while you can use **Credential** or **Variable** options for better security.

- b) In the **Client Secret** field, paste the **Consumer Key** copied from the Salesforce Connected App.

### Salesforce: Authentication 📄

Salesforce Authentication is the first command action that you need to call to get authenticated with the Salesforce.

Required bot agent version: 21.222 or above

Authentication type  
OAuth2 - Client Credentials ▼

Client ID  
Credential Variable Insecure string

**a** " " 🟢 (x)

Client secret  
Credential Variable Insecure string

**b** " " 🟢 (x)

Salesforce username  
Credential Variable Insecure string

**c** " " @aasd-foundation-int.com 🟢 (x)

Salesforce password  
Credential Variable Insecure string

**d** " " 🟢 (x)

Environment  
 Production  
 Sandbox

API version  
" " 55 🟢 (x)

Session name  
" " Default (x)

---

Save the outcome to a variable (optional)  
Multiple variables Dictionary

str-authresponse ▼ (x)

e.g. 'Authorization' as Credential type, 'InstanceUrl' as String type



- c) Enter the Salesforce username.
- d) Enter the Salesforce password.

---

**Note:** You can use one of the following options to specify the **Client ID/Client secret/ Salesforce username/ Salesforce password**:

- **Credential:** Enables you to use a value in the Credential Vault that contains information about the Client ID/Client secret/salesforce username/salesforce password.
- **Variable:** Enables you to use a credential variable that contains information about the Client ID/Client secret/salesforce username/salesforce password.
- **Insecure string:** Enables you to enter the Client ID/Client secret/salesforce username/salesforce password manually.

- 
- e) Select **Production** to log into a live environment or **Sandbox** to log into a testing environment.

7. To configure a **Control room OAuth connection** in Salesforce, complete the following steps:

- a) Complete step 1 to step 5 in [Create OAuth connection](#) on page 1893.
- b) Log in to Salesforce as an Admin and navigate to **App Manager** to create a new connected app.
- c) Enter the following details:
  - Connected App name
  - API name
  - Contact email
  - Select the **Enable OAuth Settings** check box.
  - Add the Callback URL from [Create OAuth connection](#) on page 1893 as an authorized redirect URI.
  - Select the **OAuth scopes** as `Manage user data via APIs (API)` and `Perform requests at any time (refresh_token, offline_access)`.

---

**Note:** For the Control Room OAuth connection to work, you must ensure to add the appropriate scopes when configuring Salesforce and the appropriate Control Room OAuth connection in the Control Room for Salesforce. For more information, see [Create OAuth connection](#) on page 1893.

- 
- Select the **Authorization Code** and **Credentials Flow** check box.
- d) Click **Save**.
  - e) Click **Manage Consumer Details**. Copy the client key and secret.
  - f) Go to [Create OAuth connection](#) on page 1893 and complete the remaining steps to create an OAuth connection with the above details.

8. To connect using **Control room OAuth connection**, pick a Salesforce OAuth connection you have created and stored in the Control Room. For more details, see [Configure OAuth connections in Control Room](#) on page 1889.

9. Enter the API version. You can find the API version in your Salesforce Enterprise Edition setup. For more details, see [Find Salesforce API version](#).

10. Enter **Default** as the Session name.
11. Create either a **Multiple** or **Dictionary** variable to store the response. You can do one of the following:
  - The authentication command returns a dictionary with 2 key-value pairs. `Authorization` (credential type) and `InstanceUrl` (String type). The `Authorization` is hidden, but you will be able to read the `InstanceUrl`. For example, you can use a message box to print of the value of `, $str_Authresponse{InstanceUrl}$`, this returns the Salesforce URL.
  - You can select Multiple variable as shown below and map to a credential variable and a string variable as keys.

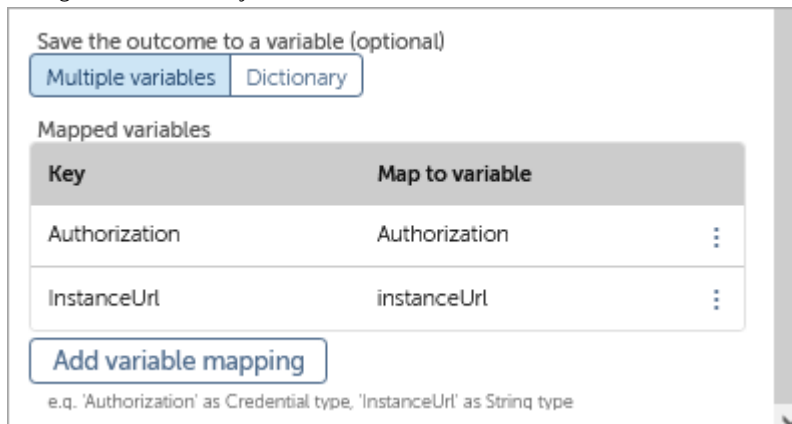

Authorization returns a token, which is hidden as it is a credential type, this token can be passed directly in the [Rest Web Services](#) command.

12. Click **Run** to save and run your bot. Once authenticated, you will be able to use the token to call other Salesforce API services.

## Salesforce Insert record action

Use the Salesforce Insert record action to insert a new record into a Salesforce object along with values of the fields that should be mapped to the object's fields.

**Note:** The examples and graphics provided on this page are for representation purposes only and may not accurately reflect your specific instance. We do not assume responsibility for their maintenance or accuracy.

**Note:** Ensure that you are authenticated before calling any Salesforce action. For more information about authentication, see [Salesforce Authentication action](#) on page 2973.

In this tutorial, you will insert a few fields into a Salesforce object by using the **Insert record** action.

1. From the **Actions** pane, select **Salesforce > Insert record** and place it in the canvas.
2. Enter the following fields:
  - a) Enter the **Object name**, for example, Case.

**Note:** For Salesforce Custom objects, ensure that you provide the API name instead of the Display name of the object. For example, provide API name: `AAIRPA__Salesforce_Connection__c` and not the display name: [Salesforce Connection](#)

" For more information on how to find the API name, see <https://help.salesforce.com/s/articleView?id=000327123&type=1>.

- b) Enter the **Fields and data** that you want to insert. Choose either **Dictionary** or **Entry list**. In this sample, **Dictionary** is selected and a few fields in Case object are modified. For example, Status is set to New and Origin is set to Web.

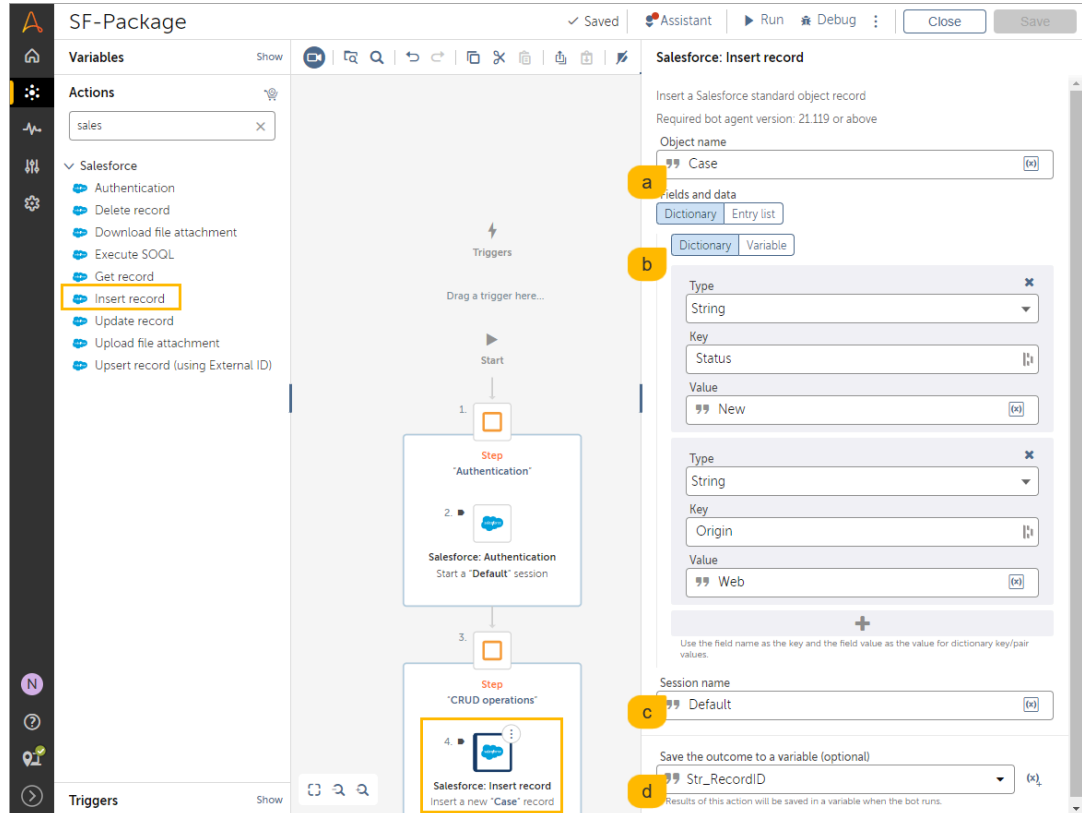

- c) Enter Default as the session name.  
 d) Save the outcome to a variable. For example, the object ID is saved to Str\_RecordID.
3. Verify whether the value is inserted into Salesforce.  
 a) Find the value of the Str\_RecordID variable in the **Debug** mode.

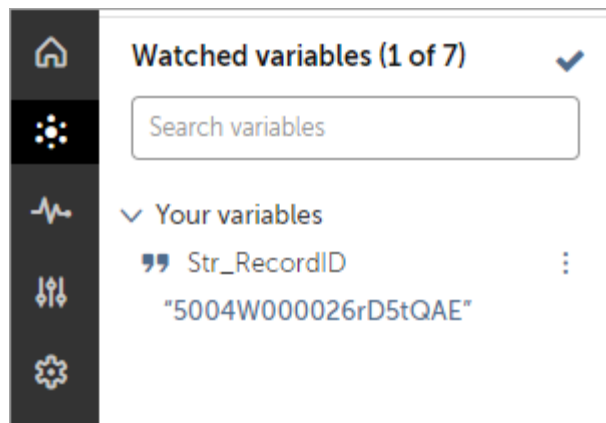

- b) In Salesforce, go to the Case object with the record ID (for example, 5004W000026rD5tQAE) that you received as the response.

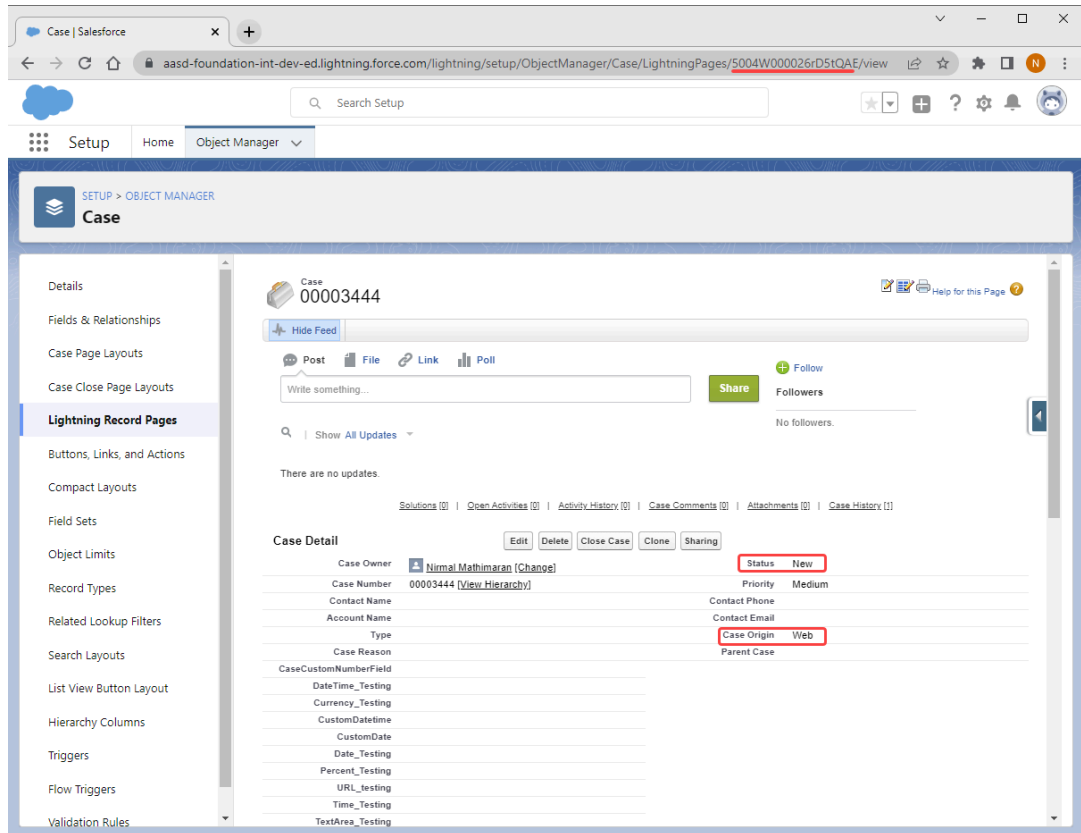

Verify whether the field's values match the input that you sent from Automation 360. For example, in this case, the Status is New and Case Origin is Web.

## Salesforce Get record action

The Salesforce Get record action is used to read the fields of a Salesforce object.

**Note:** Ensure that you are authenticated before calling any Salesforce action. For more information about authentication, see [Salesforce Authentication action](#) on page 2973.

To read the field of a Salesforce object by using the **Get record** action, perform the following steps:

1. From the **Actions** pane, select **Salesforce > Get record** and place it in the canvas.
2. Enter the following fields:
  - a) Enter the **Object name**, for example, Case.

**Note:** For Salesforce Custom objects, ensure that you provide the API name instead of the Display name of the object. For example, provide API name: AAIRPA\_\_Salesforce\_Connection\_\_c and not the display name: [Salesforce Connection](#) " For more information on how to find the API name, see <https://help.salesforce.com/s/articleView?id=000327123&type=1>.

- b) Enter the **Record ID** that you want to read. You will also be able to read data using the **External ID**. For more information on **External ID**, see [Salesforce Upsert record action](#) on page 2984.

The screenshot displays the Salesforce automation configuration interface. On the left, the 'Actions' sidebar lists various Salesforce actions, with 'Get record' highlighted in yellow. The central workspace shows a flowchart with three steps: 1. 'Salesforce: Authentication' (Start a 'Default' session), 2. 'Salesforce: Get record' (Get a 'Case' record with ID '5...'), and 3. 'Message box' (SFDC\_Res{Status}\$). The right-hand panel is titled 'Salesforce: Get record' and contains the following configuration options:

- Object name:** Case (labeled 'a')
- Record ID / External ID:** 5004W000026rD5tQAE (labeled 'b')
- Fields and data (optional):** List (selected), Variable. Under 'Value at 0', the field 'Status' is selected (labeled 'c').
- Session name:** Default
- Save the outcome to a variable:** Multiple variables, Dictionary. The variable 'SFDC\_Res' is selected (labeled 'd').

- c) Select **List** for the **Fields and data (Optional)** field. Enter all the fields that you want to read. In this sample, the field Status is read.
- d) Save the outcome to a variable. For example, the object ID is saved to SFDC\_Res. Output is retrieved as a Dictionary that consists of the field name and field value. Field name is identical to the name specified in the Salesforce object. It is recommended to use the Debugger tool and watch the output variable to view the retrieved record.
3. Click **Run** to start the bot. You will be able to read the value of the field by simply printing the value in a Message box action. For example, in this sample, `$$SFDC_Res{Status}$` will print New

## Salesforce Update record action

Update the fields of Salesforce Objects by using the Salesforce Update record action.

**Note:** Ensure that you are authenticated before calling any Salesforce action. For more information about authentication, see [Salesforce Authentication action](#) on page 2973.

To update a field in a Salesforce Object by using the **Update record** action, perform the following steps:

1. From the **Actions** pane, select **Salesforce > Update record** and place it in the canvas.
2. Enter the following fields:

The screenshot displays the Automation Anywhere interface for configuring a Salesforce automation. The central canvas shows a flow diagram with three steps: 1. 'Salesforce: Authentication' (Start a 'Default' session), 2. 'Salesforce: Get record' (Get a 'Case' record with ID '5...'), and 3. 'Salesforce: Update record' (Update a 'Case' record with I...). The 'Update record' step is highlighted with a yellow box. On the right, the configuration pane for 'Salesforce: Update record' is shown. It includes fields for 'Object name' (Case), 'Record ID' (5004W000026rD5tQAE), and 'Fields and data' (Entry list). A table under 'Update (1)' shows 'Status' being updated to 'In progress'. A button 'Add new field/value pair to update' is also visible. The left pane shows the 'Actions' list with 'Update record' highlighted.

- a) Enter the **Object name**, for example, Case.

**Note:** For Salesforce Custom objects, ensure that you provide the API name instead of the Display name of the object. For example, provide API name: AAIRPA\_\_Salesforce\_Connection\_\_c and not the display name: [Salesforce Connection](#) " For more information on how to find the API name, see <https://help.salesforce.com/s/articleView?id=000327123&type=1>.

- b) Enter the **Record ID** that you want to update.
- c) In the **Fields and data (Optional)** field, select **Entry List**. Click **Add new field/value pair to update** and enter the **Field name** that you want to update and the **Field value (optional)** that you want the field to be updated with. For example, enter Status as **Field name** and In progress as **Field value (optional)** in **Fields and data**. You can also choose **Dictionary** and enter the values as a key/value pair.
- d) Save the outcome to a variable. For example, the object ID is saved to SFDC\_Res.

- e) Enter the **Record ID** that you want to update.
3. To start the bot, click **Run**. You can verify the update by checking it in the Salesforce side. The following video shows the process:

## Salesforce Delete record action

Delete records from Salesforce by using the Salesforce Delete record action.

**Note:** Ensure that you are authenticated before calling any Salesforce action. For more information about authentication, see [Salesforce Authentication action](#) on page 2973.

To delete a field of a Salesforce object, use the **Delete record** action.

1. From the **Actions** pane, select **Salesforce > Delete record** and place it in the canvas.
2. Enter the following fields:
  - a) Enter the **Object name**, for example, Case.

**Note:** For Salesforce Custom objects, ensure that you provide the API name instead of the Display name of the object. For example, provide API name: AAIRPA\_\_Salesforce\_Connection\_\_c and not the display name: [Salesforce Connection](#) " For more information on how to find the API name, see <https://help.salesforce.com/s/articleView?id=000327123&type=1>.

- b) Enter the **Record ID** that you want to delete.

The screenshot displays the Automation Anywhere interface for configuring a bot. On the left, the 'Actions' pane is open, showing a search for 'salesf' and a list of actions under the 'Salesforce' category, with 'Delete record' highlighted. The central canvas shows a flow diagram with two steps: 1. 'Salesforce: Authentication' (Start a 'Default' session) and 2. 'Salesforce: Delete record' (Delete a 'Case' record with ID ...). The right-hand configuration panel for the 'Salesforce: Delete record' action is visible, showing the following fields: 'Object name for deletion' (Case), 'Record ID' (5004W000026rD5tQAE), and 'Session name' (Default). Yellow callouts 'a' and 'b' point to the 'Object name for deletion' and 'Record ID' fields respectively.

3. Click **Run** to start the bot. You will be able to verify the deletion by checking it on the Salesforce side. The following video shows the process:

## Salesforce Upsert record action

Insert or update a record by using the Salesforce Upsert record action. The Upsert action uses a custom external ID as the key to identify a record.

**Note:** Ensure that you are authenticated before calling any Salesforce action. For more information about authentication, see [Salesforce Authentication action](#) on page 2973.

1. From the **Actions** pane, select **Salesforce > Upsert record (using External ID)** and place it in the canvas.

The screenshot displays the configuration for the 'Salesforce: Upsert record (using External ID)' action. The flow canvas shows the following steps:

1. Salesforce: Authentication Start a "Default" session
2. String: Generate random string of length 6 to \$ExternalID\$
3. Salesforce: Upsert record (using External ID) Upsert a "Case" record using the "AAIRPA..." field
4. Message box "Done"

The configuration panel on the right includes the following settings:

- Object name:** Case
- External field name:** AAIRPA\_\_CustomFieldForExternalID
- External ID:** \$ExternalID\$
- Fields and data:**
  - Field 1: Type String, Key Status, Value New
  - Field 2: Type String, Key Origin, Value Email
- Session name:** Default
- Save the outcome to a variable (optional):** Dict\_ExternalID-Insert

2. Enter the **Object name**, for example, Case.
3. Enter the field name that will store the ExternalID.

**Note:** In this sample, the ExternalID is generated by using the **Generate random string** action.

4. Enter the ExternalID generated.
5. Enter the fields that you want to update.
6. To verify, you can store the generated recordID in a variable. The following video demonstrates how to inserting fields to a record created in Salesforce.



7. To update a field by using the Upsert record action, from the **Actions** pane, select **Salesforce > Upsert record (using External ID)** and place it in the canvas.
8. Enter the **Object name**, for example, Case.

**Note:** For Salesforce Custom objects, ensure that you provide the API name instead of the Display name of the object. For example, provide API name: AAIRPA\_\_Salesforce\_Connection\_\_c and not the display name: [Salesforce Connection](#) " For more information on how to find the API name, see <https://help.salesforce.com/s/articleView?id=000327123&type=1>.

9. Enter the same field name that will store the ExternalID.
10. Enter the same ExternalID to refer to the same record.
11. Enter the **Field Name** and new **Field Value** to update in **Fields and data**. You can also choose **Dictionary** and enter the values as a key/value pair.

The screenshot displays the configuration for the 'Salesforce: Upsert record (using External ID)' action. The flow canvas shows the following steps:

1. Salesforce: Authentication Start a "Default" session
2. String: Generate random string of length 6 to \$ExternalId\$
3. Salesforce: Upsert record (using External ID) Upsert a "Case" record using the "AAIRPA\_\_C..."
4. Salesforce: Upsert record (using External ID) Upsert a "Case" record using the "AAIRPA\_\_C..."
5. Message box: "Done"

The configuration panel on the right includes the following fields:

- Object name: Case
- External field name: AAIRPA\_\_CustomFieldForExternalId\_\_c
- External ID: SExternalId\$
- Fields and data: Dictionary (Status: Working)
- Session name: Default
- Save the outcome to a variable (optional): Dict\_ExternalId-update

12. To verify, you can store the outcome to a variable, for example, Dict\_ExternalId-update.

## Salesforce Execute SOQL action

To search your Salesforce data for specific information, run the Salesforce Object Query Language (SOQL) command from Automation 360 by using the Salesforce Execute SOQL action.

SOQL is similar to Structured Query Language (SQL) but is tailored for Salesforce data. For more information about SOQL, see [Salesforce Execute SOQL](#).

To get specific information from Salesforce data, execute a query from Automation 360.

To send an SOQL query to Salesforce by using the **Execute SOQL** action, perform the following steps:

**Note:** Ensure that you are authenticated before calling any Salesforce action. For more information about authentication, see [Salesforce Authentication action](#) on page 2973.

1. From the **Actions** pane, select **Salesforce > Execute SOQL** and place it in the canvas.

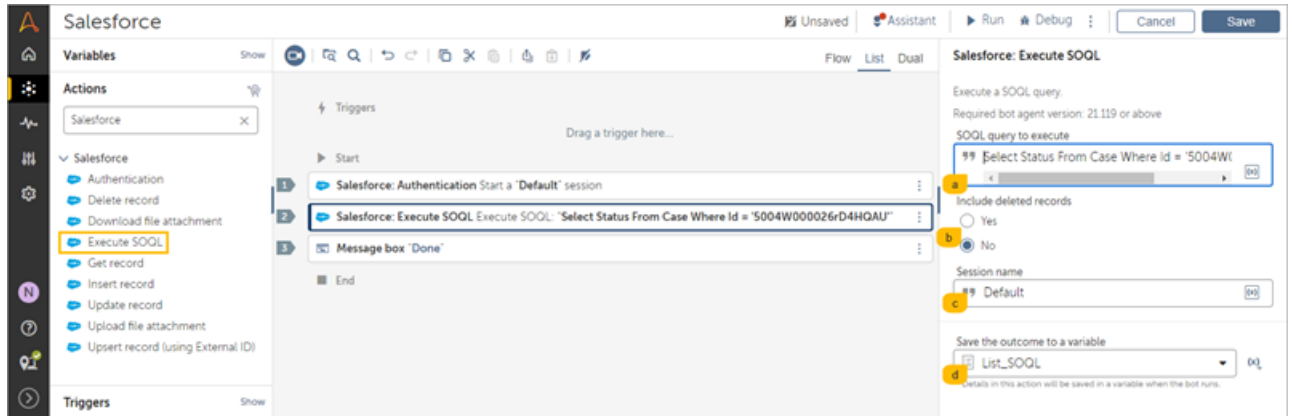

2. Enter the following fields:

- a) Enter the **SOQL query to execute**, for example, `Select Status From Case Where Id = '5004W000026rD4HQAU'`.

**Note:** For Salesforce Custom objects, ensure that you provide the API name instead of the Display name of the object. For example, provide API name: `AAIRPA__Salesforce__Connection__c` and not the display name: `Salesforce Connection`. For more information on how to find the API name, see <https://help.salesforce.com/s/articleView?id=000327123&type=1>.

- b) Select one of the following options:
  - If you want to include the deleted records, select **Yes**.
  - If you do not want to include the deleted records, select **No**.
- c) Enter Default as the session name.
- d) Save the outcome to a variable. For example, all the fields of the records can be stored in a list (List\_SOQL)

3. Verify that you can run the bot in Debug mode with a breakpoint set to an action next to Execute SOQL. For example, in the sample provided previously, there is a Message box action. Open the List\_SOQL variable to view the results.

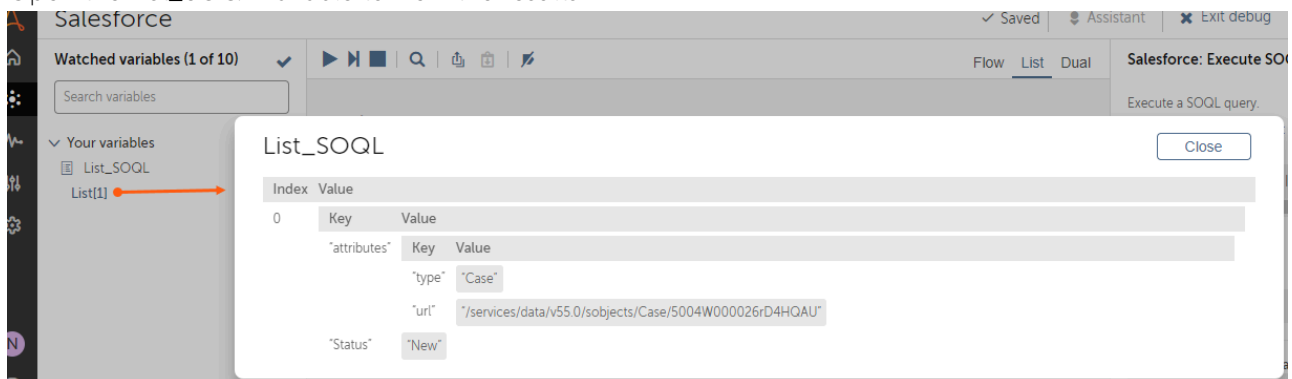

The entire result set is returned as a response of the Salesforce Execute SOQL action and there is no limitation to the number of records returned.

**Note:** The response can have a high volume of data which might potentially degrade the performance of your automation.

**Note:** The output is retrieved as a list of type . To read an individual record (row) in this list, you need to loop through all the dictionary items using the action and read or extract the records (rows) individually. For example, the output of get multiple records is saved in the variable list\_of\_records\_any. If the variable contains five records, then each record is passed to the Loop action to be processed one at a

time.

## Salesforce Upload file attachment action

You can upload a file to a record in Salesforce with the Salesforce Upload file attachment action.

**Note:** Ensure that you are authenticated before calling any Salesforce action. For more information about authentication, see [Salesforce Authentication action](#) on page 2973.

1. From the **Actions** pane, select **Salesforce > Upload file attachment** and place it in the canvas.
2. Enter the following fields:

**Salesforce: Upload file attachment**

Uploads file to a record as a related item.  
 Required bot agent version: 21.119 or above

**a** Object's record ID  
 5004W000026rD4HQAU

**b** Content document record ID (optional)  
 5004W000026rD4HQAU

**c** File to be uploaded  
 Control Room file Desktop file Variable  
 C:\Temp\InsertFilePath

**d** Display name (optional)  
 5004W000026rD4HQAU

**e** Visibility  
 All users  
 Internal users  
 Shared users

**f** Session name  
 Default

**g** Saves the outcome to a variable (optional)  
 DocVersionID

- a) Enter the **Object's record ID** to which you want to upload the file. For example: '5004W000026rD4HQAU'.
- b) Enter a **Content document record ID (optional)**.  
It is necessary only when you want to upload a newer version of an existing file.
- c) Select a location from where you want to upload the file. You will be able to select one of the following:  
**Control Room file:** When you select this option, you can select a file from your Control Room.  
**Desktop file:** When you select this option, you can select a file from your computer. In this sample, a file is uploaded from a folder in the computer.  
**Variable:** When you select this option, you can select variable that points to a file.

---

**Note:** Make sure that the file path that you are referring to contains the file with the exact name as entered in this field.

---

- d) Enter the **Display name (Optional)** to save the uploaded file in this name.
  - e) Set the **Visibility** as required.
    - **AllUsers:** The file is available to all users who have permission to see the file.
    - **InternalUsers:** The file is available only to internal users who have permission to see the file.
    - **SharedUsers:** The file is available to all users who can see the feed to which the file is posted. **SharedUsers** is used only for files shared with users and is available only when an org has private org-wide sharing on by default. The **SharedUsers** value is available in API version 32.0 and later.
  - f) Enter Default as the session name.
  - g) Save the outcome to a variable. For example, the version of the saved document can be saved in a variable, such as DocVersionID.
3. To verify, you can run the bot and see whether the file is uploaded to the record in the Salesforce. The following video demonstrates uploading a file from a computer to Salesforce.

## Salesforce Download file attachment action

You can download a file from a record in Salesforce by using the Salesforce Download file attachment action.

---

**Note:** Ensure that you are authenticated before calling any Salesforce action. For more information about authentication, see [Salesforce Authentication action](#) on page 2973.

---

1. From the **Actions** pane, select **Salesforce > Download file attachment** and place it in the canvas.
2. Enter the following fields:

The screenshot displays the Automation Anywhere configuration window for the 'Salesforce: Download file attachment' action. The interface is divided into several sections:

- Left Sidebar:** Contains 'Variables', 'Actions', and 'Triggers' sections. The 'Actions' section is expanded to show 'Salesforce' actions, with 'Download file attachment' highlighted.
- Main Workspace:** Shows a flowchart with three steps: 'Start', 'Salesforce: Authentication', and 'Salesforce: Download file attachment'. The 'Salesforce: Download file attachment' step is highlighted with a yellow box.
- Right Pane:** Shows the configuration for the 'Salesforce: Download file attachment' action. It includes fields for 'Object's record ID', 'Destination folder', 'Download all files/filter by', 'Session name', and 'Save the outcome to a variable (optional)'. Five callouts (a-e) point to these fields.

- a) Enter the **Object's record ID** from which you want to download the file. For example: '5004W000026rD4HQAU'
  - b) Enter the **Destination folder** where you want to save the file.
  - c) Set **Download all files/filter by** to one of the following options:
    - All files:** Download all the attached files from a record.
    - File name:** Download a file by entering a file name.
    - File extension:** Download all the files with the same extension that you enter.
    - Content document ID:** Download a particular version of a file.
  - d) Enter Default as the session name.
  - e) Save the outcome to a variable. For example, the details of the downloaded files can be saved in a variable, such as ListResponse
3. To verify, you can run the bot and whether the file is downloaded to the specified location. The following video demonstrates how to download a file from Salesforce to a location on a local system.

#### Note:

- The file is downloaded from the ContentDocument Object.
- File names are limited to 50 alphanumeric characters and any special characters are filtered when you download the file. The downloaded file name includes a document version ID that is appended before the file name, this ensures that the file name is unique. For example, if the file name is TEST\_a\_quick\_brown\_fox then the downloaded file name is 0684W00000c30XFQA2-TEST\_a\_quick\_brown\_fox.

**Note:** The output is retrieved as a list of type `List`. To read an individual record (row) in this list, you need to loop through all the dictionary items using the `Loop` action and read or extract the records (rows) individually. For example, the output of `get multiple records` is saved in the variable `list_of_records_any`. If the variable contains five records, then each record is passed to the `Loop` action to be processed one at a

The screenshot shows an automation workflow with the following steps:

- ServiceNow: Authentication Start a "Default" session on SPDI\_urls
- ServiceNow: Get Multiple Records Get a list of "Incident" records using filter type (N
- Loop : For each item in the list
- Dictionary: Get value of the key "number" from \$ListItem\$
- Dictionary: Get value of the key "severity" from \$ListItem\$
- Dictionary: Get value of the key "short\_description" from \$ListItem\$
- Message box "Record: \$O\_inc\_number\$, \$O\_severity\$, \$O\_descri
- ServiceNow: Revoke Authentication End the "Default" session

An orange arrow points from the "Get Multiple Records" step to a "View variable" dialog box. The dialog box shows the following details for the variable `list_of_records_any`:

Type	Subtype
List	Any
Name	Description
list_of_records_any	An ordered group of items
Use as input	No
Use as output	No
Constant (read-only)	No
Default value (optional)	This list is empty

time.

The output contains information such as document title, content document ID, file path, file extension, download status and error message if any of the downloaded file.

## SAP package

The SAP package contains actions to automate tasks and processes on a SAP application.

The SAP package enables you to perform the following tasks:

- Reduce the time required to combine data from disparate systems.
- Eliminate human error and increase efficiency.
- Increase the number of transactions processed.
- Deliver real-time information to various stakeholders.
- Enhance decision-making through comprehensive reports.

**Note:** In SAP **Connect** action, the **Session name** field cannot be shared with Task Bots or any other bots.

## Prerequisites

- Log in to the SAP GUI before capturing objects because the SAP Logon screen is not supported for object capture.
- Enable GUI scripting and accessibility.

See [Enabling Scripting on the Client Side](#), [Enabling Scripting on the Server Side](#), and [Enabling Accessibility settings](#).

- Ensure that one of the following SAP GUI for Windows is installed on the devices that you use to automate SAP-related tasks and to run these tasks:
  - SAP GUI 750 with patch 9
  - SAP GUI 760 with patch 0

- SAP GUI 760 with patch 1
- SAP GUI 760 with patch 5
- SAP GUI 770 with patch 6

---

**Note:** If SAP GUI 760 with patch 0 is installed on your device, you cannot use the SAP Grid view control **Set Table cell text** and **Get Table Cell Text** actions because of an issue with SAP GUI 760 with patch 0.

---

- Install a Scripting Tracker or a similar tool to retrieve the field path of the SAP object.

## Before you start

Perform the following actions within the SAP package as part of using the set of available actions:

1. Establish a connection with the SAP application using the **Connect** action.  
Log in to the SAP application using the SAP GUI application. Then use the **Connect** action from the SAP package to use this connection and assign a session name. Use this same session name for the other actions.
2. Use the actions to automate a task.
3. After you have automated all the SAP-related tasks, terminate the connection to the SAP application using the **Disconnect** action.

## Actions in the SAP package

The SAP package includes the following actions:

---

**Note:** The SAP and the Recorder package can detect SAP elements in the application. However, from a usability standpoint, the Recorder package is preferred over the SAP package as it is more intuitive when compared to the SAP package, such as detecting SAP Object paths automatically. See [Benefits of using Recorder package instead of SAP package](#) on page 2916

---

Action	Description
Check/uncheck checkbox	<a href="#">Check/uncheck check box action</a> on page 2993
Click	<a href="#">Click action</a> on page 2993
Click menu	<a href="#">Click menu action</a> on page 2993
Connect	<a href="#">Using Connect action for SAP</a> on page 2994.
Disconnect	<a href="#">Disconnect action</a> on page 2995
Double click	<a href="#">Double click action</a> on page 2995
Expand	<a href="#">Expand action</a> on page 2996
Export table	<a href="#">Using Export table action</a> on page 2996.

Action	Description
Get cell count	<a href="#">Get cell count action</a> on page 2997
Get children name	<a href="#">Get children names action</a> on page 2997
Get children text	<a href="#">Get children text action</a> on page 2997
Get column count	<a href="#">Get column count action</a> on page 2998
Get row count	<a href="#">Get row count action</a> on page 2998
Get selected item	<a href="#">Get selected item action</a> on page 2998
Get status	<a href="#">Get status action</a> on page 2999
Get table cell index	<a href="#">Get table cell index action</a> on page 2999
Get table cell text	<a href="#">Get table cell text action</a> on page 2999
Get text	<a href="#">Get text action</a> on page 3000
Get item count	<a href="#">Get item count action</a> on page 3000
Left click	<a href="#">Left click action</a> on page 3000
Right click	<a href="#">Right click action</a> on page 3001
Select item	<a href="#">Select item action</a> on page 3001
Select radio option	<a href="#">Select radio option action</a> on page 3001
Send virtual key	Virtual keys in SAP GUI <a href="#">Send virtual key action</a> on page 3002
Set table cell text	<a href="#">Set table cell text.</a>
Set text	<a href="#">Set text action</a> on page 3002

Related reference

[SAP package updates](#) on page 948



Review the updates in released versions of packages such as new and enhanced features as well as fixes and limitations. The page also lists the release dates of each version, and the compatible Control Room and Bot Agent versions.

## Check/uncheck check box action

The Check/uncheck check box action in the SAP package enables you to select or clear a check box in a SAP window.

### Settings

- In the **Session name** field, enter the session name you used to connect to the SAP application in the **Connect** action.
- In the **Field path** field, specify the location or a string variable that contains the location of the object.
- In the **Action** option, select **Check**, **Uncheck**, or **Toggle**.

## Click action

The **Click** action enables you to include the click operation in the SAP application.

### Settings

- Double-click or drag the **Click** action from the SAP package in the **Actions** palette.
- In the **Session name** field, enter the session name you used to connect to the application in the **Connect**.
- In the **Field path** field, specify the location or a string variable that contains the location of the object.

For example, you can install a tool (such as Scripting Tracker or similar) to retrieve the field path of the SAP object.

- Click **Save**

## Click menu action

The **Click menu** action enables you to click a menu item by text or index within a SAP window.

### Settings

- Double-click or drag the **Click menu** action from the SAP package in the **Actions** palette.
- In the **Session name** field, enter the session name you used to connect to the application in the **Connect**.
- In the **Field path** field, specify the location or a string variable that contains the location of the object.

For example, you can install a tool (such as Scripting Tracker or similar) to retrieve the field path of the SAP object.

- Use the **Select** field to select one of the following options:

- **Name:** to retrieve the value using the field name.

For example, you want to use the **Click menu** action on the new file menu in SAP window. In the **Name** field, enter **New**.

(Optional) Click the **Insert a value** icon to insert an existing variable for the **Name** field.

- **Index:** to retrieve the value using the index.

For example, there is a user log-in form that has a drop-down menu called **User type** with the following options:

- **New user**
- **Existing user**

You want to use the **Click menu** action on the **Existing user**. To select **Existing user** from the drop-down, ensure that you enter **2** in the **Index** field.

- Click **Save**.

## Using Connect action for SAP

Use the **Connect** action to establish a connection with a SAP system that you want to use to automate SAP-related tasks. This must be the first action you use to automate an SAP-related task.

1. In the **Actions** palette, double-click or drag the **Connect** action from the **SAP** package.
2. Enter a name for the session in the **Session name** field.
3. Select one of the following options to specify the connection type:

- **Automatic**

No additional information is required to connect to the SAP application. You must be already logged in to SAP application as the system uses the available SAP session to connect to a SAP system.

- **SAP SSO**

In the **Name** field, enter the value that is displayed in the **Name** column of the SAP Logon screen.

---

**Note:** While creating a new entry, the value that you have entered in the **System Connection Parameters > Description** field is displayed under the **Name** field in the SAP Logon screen.

---

- **SAP GUI**

Enter the following details:

- **Name:** Enter the **Connection Name > Description Property Value** that is entered in the SAP Logon screen at the time of creating a new connection using **System Entry Properties**.

(Optional) Click the **Insert a value** icon or press 'F2' from the keyboard to select an existing variable.

- **Client:** Enter a client identifier value.

For example, you can specify any number from 0 through 999.

- **User name:** Click one of the following tabs:

- **Credential:** Enables you to use a value available in the Credential Vault. Click the **Pick** button to select a credential.
- **Variable:** Enables you to use a value that is stored as a credential variable.
- **Insecure string:** Enables you to specify the values.
  
- **Password:** Click one of the following tabs:
  - **Credential:** Enables you to use a value available in the Credential Vault. Click the **Pick** button to select a credential.
  - **Variable:** Enables you to use a value that is stored as a credential variable.
  - **Insecure string:** Enables you to specify the values.
  
- **Language:** Specify the two-letter code for the language set on the SAP server. For example, EN for English.  
  
(Optional) Click the **Insert a value** icon or press 'F2' from the keyboard to select an existing variable.

#### 4. Click **Save**.

Related tasks

[Using Export table action](#) on page 2996

Use the **Export table** action to export a table to a datatable or CSV file.

[Using Set table cell text action](#) on page 3002

Use the **Set table cell text** action to set the text in a specific cell of a table or a grid.

Related reference

[SAP package](#) on page 2990

The **SAP** package contains actions to automate tasks and processes on a SAP application.

## Disconnect action

The Disconnect action in the SAP package enables you to terminate the connection to the SAP application.

### Settings

In the **Session name** field, enter the session name you used to connect to the application in the **Connect** .

## Double click action

The **Double click** action enables you to perform a double-click operation in a SAP window.

### Settings

- Double-click or drag the **Double click** action from the SAP package in the **Actions** palette.
- In the **Session name** field, enter the session name you used to connect to the application in the **Connect** .

- In the **Field path** field, specify the location or a string variable that contains the location of the object.

For example, you can install a tool (such as Scripting Tracker or similar) to retrieve the field path of the SAP object.

- Click **Save**

## Expand action

The Expand action in the SAP package enables you to expand the item by text or index on a SAP window.

### Settings

- In the **Session name** field, enter the session name you used to connect to the application in the **Connect** .
- In the **Field path** field, specify the location or a string variable that contains the location of the object.
- In the **Select** option, select **Text** or **Index** to specify the text or index of the item.

## Using Export table action

Use the **Export table** action to export a table to a datatable or CSV file.

To export a table, follow these steps:

1. In the Actions palette, double-click or drag the **Export table** action from the SAP package.
2. In the **Session name** field, enter the session name you used to connect to the SAP application in the **Connect** action.
3. In the **Field path** field, specify the location or a string variable that contains the location of the object.

You can use Recorder capture action to capture SAP controls and retrieve the field path or install a Scripting Tracker or a similar tool to retrieve the field path of the SAP object.

4. In the **Export As** option, select **CSV** or **Datatable** to specify the export option of the table cell:

Choice	Steps
<b>CSV</b>	<ol style="list-style-type: none"> <li>a) In the <b>File Path</b> field, specify the location or file variable.</li> <li>b) Optional: In the <b>Encoding</b> field, specify the value.</li> <li>c) Select the <b>Export data with header</b> check box to export with header.</li> <li>d) In the <b>When saving</b> field, select <b>Append to existing log file</b> or <b>Overwrite existing log file</b> to append the log file or overwrite the content within the log file.</li> </ol>
<b>Datatable</b>	In the <b>Datatable</b> field, specify the value.

5. Click **Save**.

## Get cell count action

The Get cell count action in the SAP package enables you to get number of cells in a table or grid.

### Settings

- In the **Session name** field, enter the session name you used to connect to the application in the **Connect** .
- In the **Field path** field, specify the location or a string variable that contains the location of the object.
- In the **Assign the output to a variable** field, specify the variable.

## Get children names action

The Get children names action in the SAP package enables you to get children control names.

### Settings

- In the **Session name** field, enter the session name you used to connect to the application in the **Connect** .
- In the **Field path** field, specify the location or a string variable that contains the location of the object.
- In the **Assign the output to list variable** field, specify the list variable.

## Get children text action

The Get children text action in the SAP package enables you to get the text associated with children control.

### Settings

- In the **Session name** field, enter the session name you used to connect to the application in the **Connect** .
- In the **Field path** field, specify the location or a string variable that contains the location of the object.
- In the **Assign the output to list variable** field, specify the list variable.

## Get column count action

The Get column count action in the SAP package enables you to get number of columns in a table or grid.

### Settings

- In the **Session name** field, enter the session name you used to connect to the application in the **Connect** .
- In the **Field path** field, specify the location or a string variable that contains the location of the object.
- In the **Assign the output to a variable** field, specify the variable.

## Get row count action

The Get row count action in the SAP package enables you to get number of rows in a table or grid.

### Settings

- In the **Session name** field, enter the session name you used to connect to the application in the **Connect** .
- In the **Field path** field, specify the location or a string variable that contains the location of the object.
- In the **Assign the output to a variable** field, specify the variable.

## Get selected item action

The Get selected item action in the SAP package enables you to get selected item index from a combo box, page tab, or a tree view control.

### Settings

- In the **Session name** field, enter the session name you used to connect to the application in the **Connect** .
- In the **Field path** field, specify the location or a string variable that contains the location of the object.
- In the **Assign the output to a variable** field, specify the variable.

## Get status action

The Get status action in the SAP package enables you to get status of a radio button or check box.

### Settings

- In the **Session name** field, enter the session name you used to connect to the application in the **Connect**.
- In the **Field path** field, specify the location or a string variable that contains the location of the object.
- In the **Assign the output to a variable** field, specify the variable.

## Get table cell index action

The Get table cell index action in the SAP package enables you to get table cell index for text.

### Settings

- In the **Session name** field, enter the session name you used to connect to the application in the **Connect**.
- In the **Field path** field, specify the location or a string variable that contains the location of the object.
- In the **Search text** field, specify the text.
- Select the **Case sensitive search** option to specify a case-sensitive search.
- Select the **All occurrences** check box.
- In the **Assign the output to a variable** field, specify the variable.

## Get table cell text action

The **Get table cell text** action in the SAP package enables you to get table cell text by index.

### Settings

- In the **Session name** field, enter the session name you used to connect to the application in the **Connect**.
- In the **Field path** field, specify the location or a string variable that contains the location of the object.

For example, you can install a tool (such as Scripting Tracker or similar) to retrieve the field path of the SAP object.

- In the **Row** field, specify the row number from where you want to get the text.

For example, if you want to get text in tenth row, enter 10 in the **Row** field.

(Optional) Click the **Insert a value** icon to select an existing variable for the **Row** field.

- In the **Column** field, specify the column number from where you want to get the text.

For example, if you want to get text from the third column, enter 3 in the **Column** field.

- (Optional) Click the **Insert a value** icon to select an existing variable for the **Column** field.
- Click the **Assign the output to a variable** drop-down menu and select the variable to which you want to assign the output.
- (Optional) Click the **Create variable** icon if there is no existing variable.

## Get text action

The Get text action in the SAP package enables you to get text from a text box, label, or status bar.

### Settings

- In the **Session name** field, enter the session name you used to connect to the application in the **Connect** .
- In the **Field path** field, specify the location or a string variable that contains the location of the object.
- In the **Assign the output to a variable** field, specify the variable.

## Get item count action

The Get item count action in the SAP package enables you to get the count of items in a combo box, page tab, or tree view control.

### Settings

- In the **Session name** field, enter the session name you used to connect to the application in the **Connect** .
- In the **Field path** field, specify the location or a string variable that contains the location of the object.
- In the **Assign the output to a variable** field, specify the variable.

## Left click action

The **Left click** action enables you to perform a left-click operation.

### Settings

- Double-click or drag the **Left click** action from the SAP package in the **Actions** palette.
- In the **Session name** field, enter the session name you used to connect to the application in the **Connect** .
- In the **Field path** field, specify the location or a string variable that contains the location of the object.

For example, you can install a tool (such as Scripting Tracker or similar) to retrieve the field path of the SAP object.

- Click **Save**



## Right click action

The **Right click** action enables you to perform a right-click operation.

### Settings

- Double-click or drag the **Click menu** action from the SAP package in the **Actions** palette.
- In the **Session name** field, enter the session name you used to connect to the application in the **Connect** .
- In the **Field path** field, specify the location or a string variable that contains the location of the object.

For example, you can install a tool (such as Scripting Tracker or similar) to retrieve the field path of the SAP object.

- Click **Save**.

## Select item action

The Select item action in the SAP package enables you to select an item by text or index.

### Settings

- In the **Session name** field, enter the session name you used to connect to the application in the **Connect** .
- In the **Field path** field, specify the location or a string variable that contains the location of the object.
- In the **Select** option, select **Text** or **Index** to specify the text or index of the item.

## Select radio option action

The Select radio option action in the SAP package enables you to select the radio button in a SAP window.

### Settings

- In the **Session name** field, enter the session name you used to connect to the application in the **Connect** .
- In the **Field path** field, specify the location or a string variable that contains the location of the object.

## Send virtual key action

The Send virtual key action in the SAP package enables you to send a virtual key.

### Settings

- In the **Session name** field, enter the session name you used to connect to the application in the **Connect**.
- In the **Select** list, select a key.

See [Virtual keys in SAP GUI](#).

## Using Set table cell text action

Use the **Set table cell text** action to set the text in a specific cell of a table or a grid.

To set a value in a table cell, follow these steps:

1. In the **Actions** palette, double-click or drag the **Set table cell text** action from the SAP package.
2. In the **Session name** field, enter the session name you used to connect to the SAP application in the **Connect** action.
3. In the **Field path** field, specify the location or a string variable that contains the location of the object.
4. In the **Select** option, select **Text** or **Index** to specify the text or index of the table cell:
  - **Text**: In the **Find Text** field, specify the value.  
The system searches for the cell that contains the value.
  - **Index**: In the **Row** and **Column** fields, specify the value.
5. In the **Set Text** field, enter the text to set the table cell.
6. Click **Save**.

## Set text action

The **Set text** action in the SAP package enables you to set the text in an editable field (such as textbox).

### Settings

- Double-click or drag the **Set text** action from the SAP package in the **Actions** palette.
- In the **Session name** field, enter the session name you used to connect to the application in the **Connect**.
- In the **Field path** field, specify the location or a string variable that contains the location of the object.

For example, you can install a tool (such as Scripting Tracker or similar) to retrieve the field path of the SAP object.

(Optional) If you have stored the location of the object as a variable, click the **Insert a variable** icon to select that variable.

- (Optional) In the **Field value** field, enter the text that you want to specify or set.

Alternately, click the **Insert a variable** icon to select an existing variable that contains the text you want to set.

---

**Note:** You can set the fields to any value, including blank values. For example, text field or date field.

- (Optional) Select the **Append text** check box if you want to add or append the text with any existing text in the editable field.

If you do not select the check box, the content in the editable field will be overwritten.

## SAP BAPI package

The SAP BAPI package contains actions to automate tasks and processes using SAP Business Application Programming Interface (BAPI). BAPI is a standardized method that enables a third-party application to interact with an SAP system.

### Overview of SAP BAPIs

[Business Application Programming Interfaces \(BAPIs\)](#) are APIs that enable external applications to access SAP business objects.

Typically, a BAPI consists of the following parameters:

- Import parameters: Used to receive data from the calling applications.
- Export parameters: Used to return data to the calling application.
- Import/export table parameters: Tables used for both receiving data and returning data.

A parameter can be of the following type:

- Data element: Scalar data type
- Structure: Typically contains multiple fields

If an import parameter is of the type structure, you can pass multiple values as key-value pairs.

- Table: A data structure that contains more than one row

For a BAPI method to work, the calling application can call the method in a BAPI using the following:

- BAPI name
- Import parameters (scalar, structure, table)
- Export parameters (scalar, structure, table)

### Before you start

Perform the following actions within the SAP BAPI package as part of using the set of available actions:

1. Establish a connection with the SAP application using the **Connect** action.
2. Use the **Create function** action to create a user-defined function for the specified SAP BAPI function.  
Select the **Begin sequence** option to mark the start of a process followed by the actions to automate a task.
3. Use the **Run function** action to run the function you have created using the **Create function** action.  
Select the **End sequence** option to mark the end of a process and the **Commit transaction** option to commit the changes.

## Actions in the SAP BAPI package

The SAP BAPI package includes the following actions:

Action	Description
Connect	<a href="#">Using Connect action for SAP BAPI</a> on page 3005.
Create function	<a href="#">Create function action</a> on page 3007.
Get field value	<a href="#">Get field value action</a> on page 3007.
Get structure	<a href="#">Get structure action</a> on page 3008.
Get table	<a href="#">Get table action</a> on page 3008.
Run function	<a href="#">Run function action</a> on page 3008.
Set field value	<a href="#">Set field value action</a> on page 3009.
Run standard workflow	<a href="#">Run standard workflow action</a> on page 3009.
Run custom workflow	<a href="#">Run custom workflow action</a> on page 3010.

## Build sample bots using the SAP BAPI package

If you are getting started with the SAP BAPI package, a good place to start is to build some sample bots with the help of the following tutorials. The tutorials are intended to train you on how to use various actions from the SAP BAPI package to invoke SAP BAPIs, pass import parameters, and retrieve data from export parameters.

- [Example of using Get structure command from SAP BAPI package](#) on page 3244: In this tutorial, you will build a bot that invokes BAPI\_FLIGHT\_GETLIST from the SAP demo Flight Data application. When executed, the bot calls the BAPI function by inputting an airline ID and destination details, gets a list of flights, and writes the response data to a CSV file.
- [Example of writing data to SAP using SAP BAPI package](#) on page 3246: In this tutorial, you will build a bot that invokes BAPI\_FLICUST\_CREATEFROMDATA from the SAP demo Flight Data application. You will use the CUSTOMER\_DATA import parameter to pass the customer data to the BAPI. When executed, the bot creates a new customer record in SAP database and displays the customer number returned by the BAPI.

- [Example of using Run standard workflow from SAP BAPI package](#) on page 3248: In this tutorial, you will build a bot that uses a single action to select a BAPI from a list of function modules, to set import parameters, and to get the response data. When executed, the bot gets flight availability data based on the input data, and writes it to a CSV file.

Related reference

[SAP BAPI package updates](#) on page 947

Review the updates in released versions of SAP BAPI package such as new and enhanced features as well as fixes and limitations. The page also lists the release dates of each version, and the compatible Control Room and Bot Agent versions.

## Using Connect action for SAP BAPI

Use the **Connect** action to establish a connection with a SAP system that you want to use to automate SAP-related tasks using SAP Business Application Programming Interface (BAPI). This must be the first action you use to automate an SAP-related task using SAP BAPI.

Download the SAP Java connector package and DLL from the SAP website.

1. In the **Actions** palette, double-click or drag the **Connect** action from the **SAP** package.
2. In the **SAP BAPI Session** field, specify a name for the session.
3. In the **JCo: SAP Java Connector package** field, specify the location of the SAP Java connector package as credential, variable, or an insecure string.

---

**Note:** The credential, variable, and insecure string fields mentioned in this topic are defined as follows:

- **Credential:** Enables you to use a value available in the Credential Vault.
- **Variable:** Enables you to use a value that is stored as a credential variable.
- **Insecure string:** Enables you to manually specify the values.

- 
4. In the **JCo DLL dependency** field, specify the location of the SAP JCo DLL dependency as a credential, variable, or an insecure string.
  5. In the **Connection type**, select one of the following options:
    - **Custom Application Server:**  
Specify the SAP server hostname as a credential, variable, or an insecure string.
    - **Group/Server:**
      - a) Specify the SAP message server hostname as a credential, variable, or an insecure string.
      - b) Optional: Specify the gateway host you want to use to connect to the server in the **Gateway host** field.
      - c) Optional: Specify the logon group you want to use to connect to the server in the **Logon group** field.
  6. In the **System number** field, specify the two digit instance number.
  7. (Optional) In the **SAP instance system ID** field, specify the unique three character code of your SAP instance.
  8. In the **Client number** field, specify the three digit client number.

9. In the **Logon language code** field, specify the two-character language code based on ISO 639-1. For example: EN (for English).
10. (Optional) In the **Router string** field, specify the SAP router path when the target server is behind a firewall.
11. In the **Authentication type** field, select one of the following options:
  - **Username and password:**

Specify the username and password of your SAP BAPI account.
  - **SNC:**

Secure Network Communications (SNC) integrates SAP NetWeaver Single Sign-On (SSO) or an external security product with SAP systems. SNC secures the data communication paths between the various SAP system client and server components. Select this option to strengthen security by using additional security functions that are not directly available with SAP systems.

    - a) Specify the SNC name of the communication partner.
    - b) In the **Protection level** field, select the required data protection level to apply from the drop-down list.
      - When using **Authentication only** protection level, the system verifies the identity of the communication partners. This is the minimal protection level offered by SNC.
      - When using **Integrity Protection**, the system detects any changes or manipulation of the data which might have occurred between the two endpoints of a communication.
      - When using **Privacy Protection**, the system encrypts the messages being transferred. Privacy protection also includes integrity protection of the data.
      - **Default Protection** applies the global default protection level.
      - **Maximum security settings available** is the maximum value that the current security product supports.
    - c) In the **SNC library** field, specify the path and file name of the external security product library as a credential, variable, or an insecure string.
    - d) Select the **Login with username and password** check box and specify the username and password as a credential, variable, or an insecure string.

---

**Note:** For SSO authentication login, you do not have to provide the username and password. To authenticate without SSO, you must provide the username and password.

---

## Create function action

The Create function action in the SAP BAPI package enables you to create an alias for a SAP BAPI function and saves it with an alias name.

### Settings

You can use the alias name in other actions to use that BAPI function in those actions.

- In the **Session name** field, enter the session name you used to connect to the SAP application in the **Connect** action.
- In the **Function alias name** field, enter the alias that you want to use for the BAPI function.
- In the **BAPI name** field, enter name of the SAP BAPI function for which you want to create the alias.
- Select the **Begin sequence** option if you want to execute the BAPI in a particular sequence to mark the start of a process.

## Get field value action

The Get field value action in the SAP BAPI package enables you to obtain data of a specific field from a function, table, or structure.

### Settings

- In the **BAPI function alias** field, enter the alias you have provided for SAB BAPI function using the **Create function** action.
- Select one of the following option to specify whether you want to obtain data from a function, table, or structure:

- **Function**: Enables you to get the value of a field from a function.
- **Table**: Enables you to get the value of a field from a table in a SAP BAPI function.

You must specify the **Table alias** from which you want to obtain data.

You must use the **Get table** action before you use the **Get field** action to obtain the value of a field from a table in a SAP BAPI function. You must also specify the **Table alias** from which you want to get data.

- **Structure**: Enables you to obtain data from a structure in a SAP application.

You must use the **Get structure** action before you use the **Get field** action to obtain the value of a field from a structure in a SAP BAPI function. You must also specify the **Table alias** from which you want to obtain data.

- In the **Field name** field, enter the name of the field from which you want to get data.
- In the **SAP BAPI Session** field, enter the session name you used to connect to the SAP application in the **Connect** action.
- In the **Save the output to a variable** field, specify a string variable.

## Get structure action

The Get structure action in the SAP BAPI package enables you to obtain table data from a structure using the function alias.

### Settings

- In the **BAPI function alias** field, enter the alias you have provided for SAB BAPI function using the **Create function** .
- In the **Structure name** field, enter the name of the structure from which you want to get data.
- In the **SAP BAPI Session** field, enter the session name you used to connect to the application in the **Connect** .
- Select one of the following options to specify how you want to save the data retrieved from the structure:
  - **Alias**: Enables you to provide an alias for the structure and use the alias in other actions.
  - **Variable**: Enables you to store the data retrieved from the structure in a table variable.

## Get table action

The Get table action in the SAP BAPI package enables you to get tabular data from a table using the function alias.

### Settings

- In the **BAPI function alias** field, enter the alias you have provided for SAB BAPI function using the **Create function** .
- In the **Table name** field, enter the name of the table from which you want to obtain data.
- In the **SAP BAPI Session** field, enter the session name you used to connect to the application in the **Connect** .
- Select one of the following options to specify how you want to save the data retrieved from the table:
  - **Alias**: Enables you to provide an alias for the table and use the alias in other actions.
  - **Variable**: Enables you to store the data retrieved from the table in a table variable.

## Run function action

The Run function action in the SAP BAPI package enables you to run the SAP BAPI function.

### Settings

- In the **BAPI function alias** field, enter the alias you have provided for SAB BAPI function using the **Create function** .
- Select the **End sequence** option to mark the end of a process and the **Commit transaction** option to commit the changes made during the process.



If you want to end a sequence, you must select the **Begin sequence** option from the **Create function** action. If you have used queued Remote Function Call (qRFC), you must select the **Commit transaction** option to commit the changes you have made.

- In the **SAP BAPI Session** field, enter the session name you used to connect to the application in the **Connect**.

## Set field value action

The Set field value action in the SAP BAPI package enables you to set data into a function, table, or structure using the function alias.

### Settings

- In the **BAPI function alias** field, enter the alias you have provided for SAB BAPI function using the **Create function**.
- Select one of the following options to specify whether you want to set data in a function, table, or structure:

- **Function**: Enables you to set data in a function.
- **Table**: Enables you to set data in a table in a SAP application.

You must use the **Get table** action before you use the **Get field** action to obtain the value of a field from a table in a SAP BAPI function. You must specify the **Table alias** in which you want to set data. You can also select the **Create new row** option if you want to create a new row in the table and set value in that row.

- **Structure**: Enables you to set data in a structure in a SAP application.

You must use the **Get structure** action before you use the **Get field** action to obtain the value of a field from a structure in a SAP BAPI function. You must also specify the **Structure alias** from which you want to get data.

- In the **Field name** field, enter the name of the field in which you want to set data.
- In the **Field Value** field, enter the value that you want to set.
- In the **SAP BAPI Session** field, enter the session name you used to connect to the application in the **Connect**.

## Run standard workflow action

The **Run standard workflow** action in the SAP BAPI package enables you to run existing workflow.

### Settings

You can use the remote function call as an alternate workflow and specify all the required import, export & table parameters. For more information, see [Example of using remote function call in SAP](#) on page 3262.

- Use the **Select workflow** option to select the workflow from the **Standard BAPI Selector** dialog box.

- The **Import to BAPI** section displays the import parameters for the selected workflow. You can select the **Edit** option from the action menu (vertical ellipsis) to specify a value for the parameters.
  - Select the **Include** option if you want to use that import parameter.
  - Select the **Table** tab to select a table variable containing the values you want to import to BAPI. Alternatively, select the **Strings** tab to specify the value manually.
- The **Export to BAPI** section displays the export parameters for the selected workflow. You can select the **Edit** option from the action menu (vertical ellipsis) to retrieve existing parameters.

Select the **Include** option if you want to use that export parameter.
- The **Tables** section displays the tables you can use as export or import parameters for your selected workflow. You can select the **Edit** option from the action menu (vertical ellipsis) to specify a value for the tables.
  - Select the **Include** option if you want to use that table as an export or import parameter.
  - Select either the **Import** tab to use a table as an import parameter or select the **Export** tab to use a table as an export parameter.
  - Select the **Table** tab to select a table variable containing the values you want to import to BAPI. Alternatively, select the **Strings** tab to specify the value manually.
- Select the **Begin sequence** option if you want to execute the BAPI in a particular sequence to mark the start of a process.
- Select the **End sequence** option to mark the end of a process.
- Select the **Commit transaction** option to commit the changes made during the process.
- In the **SAP BAPI Session** field, enter the session name you used to connect to the application in the **Connect** .
- In the **Save exported structures and scalars** field, specify a dictionary variable.
- In the **Save exported tables** field, specify a dictionary variable.

## Run custom workflow action

The **Run custom workflow** action enables you to run a custom workflow in SAP BAPI.

### Settings

---

**Note:** Adding a custom workflow is not supported in Automation 360. You can use the Remote function call (RFC) to execute the custom BAPI.

---

- Use the **Select Custom workflow** drop-down menu to select one of the following custom workflows that you want to run:
  - **Create Sales Order - VA01**
  - **Update Sales Agreement - VA32**

---

**Note:** There are only two predefined custom workflows available and cannot be edited.

---

- The **Import to BAPI** section displays the import parameters for the selected workflow. You can select the **Edit** option from the action menu (vertical ellipsis) to specify a value for the parameters.

- Select the **Include** option if you want to use that import parameter.
- Select the **Table** tab to select a table variable containing the values you want to import to BAPI. Alternatively, select the **Strings** tab to specify the value manually.
- The **Export to BAPI** section displays the export parameters for the selected workflow. You can select the **Edit** option from the action menu (vertical ellipsis) to specify a value for the parameters.
  - Select the **Include** option if you want to use that export parameter.
- The **Tables** section displays the tables you can use as export or import parameters for your selected workflow. You can select the **Edit** option from the action menu (vertical ellipsis) to specify a value for the tables.
  - Select the **Include** option if you want to use that table as an export or import parameter.
  - Select either the **Import** tab to use a table as an import parameter or select the **Export** tab to use a table as an export parameter.
  - Select the **Table** tab to select a table variable containing the values you want to import to BAPI. Alternatively, select the **Strings** tab to specify the value manually.
- Select the **Begin sequence** option if you want to execute the BAPI in a particular sequence to mark the start of a process.
- Select the **End sequence** option to mark the end of a process.
- Select the **Commit transaction** option to commit the changes made during the process.
- In the **SAP BAPI Session** field, enter the session name you used to connect to the application in the **Connect** .
- In the **Save exported structures and scalars** field, specify a dictionary variable.
- In the **Save exported tables** field, specify a dictionary variable.

## Screen package

Use the `Screen` package to automate the process of capturing screenshots. Using the actions in this package, you can capture an area of an application window, the entire computer screen, or an active open window and save it in a specified location in an image format.

### Actions in the Screen package

The `Screen` package includes the following actions:

Action	Description
Capture area	See <a href="#">Using Capture area action from Screen package</a> on page 3012.
Capture desktop	See <a href="#">Capture desktop action in Screen</a> on page 3014.
Capture window	See <a href="#">Using Capture window action from Screen package</a> on page 3014.

## Secure recording

When secure recording mode is enabled, bots do not display the target object images after capture. This ensures that sensitive data is not shown.

**Note:** Although the bots do not display the target images after capture, the images are still stored in the Control Room because they are required to run the bots.

When you record a task in secure recording mode, the **Preview** window temporarily shows an image of the captured area. This image is hidden after you navigate away from the Bot editor window or refresh it.

A user with admin privileges must enable this setting. See [Settings](#) on page 1789.

Related reference

[Screen resolution dependent packages](#) on page 1802

The screen resolution between the Bot Runner and Bot Creator device should be consistent as when resolution-dependent packages are used to build bots, any screen resolution difference between the Bot Creator and Bot Runner device will impact the bots during runtime.

[Screen package updates](#) on page 949

Review the updates in released versions of the Screen package such as new and enhanced features as well as fixes and limitations. The page also lists the release dates of each version, and the compatible Control Room and Bot Agent versions.

## Using Capture area action from Screen package

Use the **Capture area** action in the Screen package to capture a screenshot of the application window area.

To capture a specified area of an application window, perform these steps:

1. In the **Actions** palette, double-click or drag the **Capture area** action from the Screen package.
2. Specify the window in which to capture an object.  
Choose from the **Application**, **Browser**, or **Variable** tab.

Option	Description
Application	Select from a list of currently active windows. This option shows a list of all the application and browser windows that are open on the Bot Creator device.
Browser	Select from a list of supported browser tabs.  <b>Note:</b> This option supports , Chromium-based , and browsers. For all other browsers, use the <b>Application</b> option.
Variable	Select an existing window variable to specify the title of the application window title.

3. Optional: Insert a wildcard character (\*) in the **Window title** field to search for window titles that can change. You can specify one or more wildcards (\*) at the start, middle, or end of the value.

For example, to perform an operation on any window that has `Microsoft` in the title, use a wildcard to indicate any string by adding it before or after the value: `*Microsoft*`. The first searches for the exact window title (`Microsoft`), and if it does not find a match, it searches for windows with the term `Microsoft` anywhere in the title.

You can use a regular expression (regex) to identify a window title. Select the regular expression condition as either **String** or a **Pattern** and then enter the value. By default, the **Window title** field is case-sensitive.

To identify a browser title, you can enable the **Case sensitive** option to match the letter case, or disable the option to identify a window title where the letter case does not match.

---

**Note:** Ensure that the minimum version installed on your system is the version that was released with v.26. If you have a version released with v.25 or earlier, then by default, the window title will be identified only with matching letter case (case-sensitive).

---

For example, you can enter the **String** value as `(\w*)-Notepad` for all window title names starting with `(\w*)-Notepad`, or use **Pattern** value as `(\w)\s*document-Notepad` for only those window titles that match this pattern.

---

**Note:**

- When you use a regular expression of type **String** with `-title` as the input value for a window title in any , the might encounter a run time error. To prevent the run time error, ensure that when you add the string input as `*-title`, the application with the specific title is open. The asterisk (\*) is just a character, not a wild card character.
- When you use a regular expression of type **Pattern** with `-title` as the input value for a window title in any , the might encounter a run time error because the input value `*-title` is incorrect.

Ensure that you use valid regex patterns.

---

**Note:** During runtime, verify that the Task Bot identifies the correct window. If it does not, do the following:

- a) Open the application or browser window.
  - b) Drag a **Window > Get active window title** action above the **Recorder > Capture** action.
  - c) Insert a string variable into the **Assign the window title to variable** field.
  - d) Drag a **Window > Set title** action below the **Window > Get active window title** action.
  - e) In the **Window** field, insert the window variable generated by the **Recorder > Capture** action.
  - f) In the **New window title** field, insert the string variable from the **Get active window title** action.
  - g) Click **Save**.
- 

**4.** Optional: Select the **Resize window** option to specify the window dimensions.

This option delivers a more reliable bot. It resizes the window to the dimensions at which the task was recorded, which enhances the ability of the bot to identify the target object.

- If the window is maximized when you record the task, this option is not selected.
-

- If the window is not at the maximum size when you record the task, this option is selected, by default, and the width and height fields are automatically filled with the dimensions of the window.

---

**Note:** This option is available only for windows that can be resized. It is not available for the **Desktop** or **Taskbar** options.

---

5. Click the **Capture region**.  
The pixel coordinates of the captured area are displayed in the **X, Y, Width**, and **Height** fields. You can modify these values.
6. Browse to select the **File path to save image**.  
The following file extensions are supported: png, bmp, jpeg, tiff, gif, and wmf.
7. Click **Overwrite file** to replace an existing file with the same name.
8. Click **Save**.

## Capture desktop action in Screen

The **Capture desktop** action in the Screen package enables you to capture an image of the entire desktop.

### Settings

- In the **File path to save image** field, specify the path where you want to save the captured image.  
The following file extensions are supported: png, bmp, jpeg, jpg, tiff, gif, and wmf.
- Select **Overwrite File** check box to overwrite an existing file with the same name.

## Using Capture window action from Screen package

Use the **Capture window** action of the Screen package to capture an open application window.

To capture an application window, perform these steps:

1. In the **Actions** palette, double-click or drag the **Capture window** action from the Screen package.
2. Specify the window in which to capture an object.

Choose from the **Application**, **Browser**, or **Variable** tab.

Option	Description
Application	Select from a list of currently active windows. This option shows a list of all the application and browser windows that are open on the Bot Creator device.

Option	Description
Browser	Select from a list of supported browser tabs.  <b>Note:</b> This option supports , Chromium-based , and browsers. For all other browsers, use the <b>Application</b> option.
Variable	Select an existing window variable to specify the title of the application window title.

3. Optional: Insert a wildcard character (\*) in the **Window title** field to search for window titles that can change. You can specify one or more wildcards (\*) at the start, middle, or end of the value.

For example, to perform an operation on any window that has `Microsoft` in the title, use a wildcard to indicate any string by adding it before or after the value: `*Microsoft*`. The first searches for the exact window title (`Microsoft`), and if it does not find a match, it searches for windows with the term `Microsoft` anywhere in the title.

You can use a regular expression (regex) to identify a window title. Select the regular expression condition as either **String** or a **Pattern** and then enter the value. By default, the **Window title** field is case-sensitive.

To identify a browser title, you can enable the **Case sensitive** option to match the letter case, or disable the option to identify a window title where the letter case does not match.

**Note:** Ensure that the minimum version installed on your system is the version that was released with v.26. If you have a version released with v.25 or earlier, then by default, the window title will be identified only with matching letter case (case-sensitive).

For example, you can enter the **String** value as `(\w*)-Notepad` for all window title names starting with `(\w*)-Notepad`, or use **Pattern** value as `(\w)\s*document-Notepad` for only those window titles that match this pattern.

**Note:**

- When you use a regular expression of type **String** with `-title` as the input value for a window title in any , the might encounter a run time error. To prevent the run time error, ensure that when you add the string input as `*-title`, the application with the specific title is open. The asterisk (\*) is just a character, not a wild card character.
- When you use a regular expression of type **Pattern** with `-title` as the input value for a window title in any , the might encounter a run time error because the input value `*-title` is incorrect.

Ensure that you use valid regex patterns.

**Note:** During runtime, verify that the Task Bot identifies the correct window. If it does not, do the following:

- Open the application or browser window.
- Drag a **Window > Get active window title** action above the **Recorder > Capture** action.
- Insert a string variable into the **Assign the window title to variable** field.
- Drag a **Window > Set title** action below the **Window > Get active window title** action.

- e) In the **Window** field, insert the window variable generated by the **Recorder > Capture** action.
- f) In the **New window title** field, insert the string variable from the **Get active window title** action.
- g) Click **Save**.

- 
4. Optional: Select the **Resize window** option to specify the window dimensions. This option delivers a more reliable bot. It resizes the window to the dimensions at which the task was recorded, which enhances the ability of the bot to identify the target object.
- If the window is maximized when you record the task, this option is not selected.
  - If the window is not at the maximum size when you record the task, this option is selected, by default, and the width and height fields are automatically filled with the dimensions of the window.

---

**Note:** This option is available only for windows that can be resized. It is not available for the **Desktop** or **Taskbar** options.

---

- 5. Browse to select the **File path to save image**.  
The following file extensions are supported: png, bmp, jpeg, tiff, gif, and wmf.
- 6. Click **Overwrite file** to replace an existing file with the same name.
- 7. Click **Save**.

## Service package

Use the Service package to automate operations in Windows and application services including starting, stopping, pausing, resuming, or getting the status of services.

---

**Note:** You must have administrator privileges to start, stop, pause, or resume service operations.

---

### Actions in the Services package

The Services package includes the following actions:

Action	Description
Get service status	See <a href="#">Get service status action in Services</a> on page 3018
Pause service	See <a href="#">Pause service action in Services</a> on page 3017
Resume service	See <a href="#">Resume service action in Services</a> on page 3017
Start service	See <a href="#">Start service action in Services</a> on page 3017



---

Action	Description
Stop service	See <a href="#">Stop service action in Services</a> on page 3018 .

Related reference

[Service package updates](#) on page 951

Review the updates in released versions of packagesuch as new and enhanced features as well as fixes and limitations. The page also lists the release dates of each version, and the compatible Control Room and Bot Agent versions.

## Pause service action in Services

The **Pause service** action in the Services package enables you to pause a Windows or application service that is currently running.

### Settings

Select the **Service list** or **Variable** option to enter the name of the service that you want to pause.

## Resume service action in Services

The **Resume service** action in the Services enables you to resume a selected Windows or application service that was previously paused.

### Settings

Select the **Service list** or **Variable** option to enter the name of the service that you want to resume the services for.

## Start service action in Services

The **Start service** action in the Services package enables you to start a selected Windows or application service that is not running.

### Settings

Select the **Service list** or **Variable** option to enter the name of the service that you want to start the service for.

## Get service status action in Services

The **Get service status** action in the Services enables you to retrieve the current status of a Windows or application service.

### Settings

- Select either the **Service list** or the **Variable** option and to enter the name of the service that you want to get the status for.
- Select an appropriate variable that you can assign the status value to from the **Assign the output to an existing variable** option.

Example: The Windows Audio service status might be running.

## Stop service action in Services

The **Stop service** action in the Services package enables you to stop a selected Windows or application service that is currently running.

### Settings

Select the **Service list** or **Variable** option to enter the name of the service that you want to stop the service for.

## ServiceNow package

ServiceNow is a leading software provider of digital work flows for enterprise operations. The Automation 360 ServiceNow command package uses the ServiceNow APIs to let you build and deploy bots in Automation 360 that work with records and triggers in ServiceNow.

---

### Note:

The ServiceNow mark and logo are trademarks or registered trademarks of ServiceNow and are used for identification purposes only.

---

This package provides actions to authenticate with ServiceNow and perform several actions with records and attachments. To perform these actions in ServiceNow, Automation 360 uses these APIs:

- [Table API](#)
- [Attachment API](#)

Automation 360 bots can increase process efficiency for these types of work flows: customer account creation and management, customer verification, employee on-boarding and off-boarding, data extraction and migration, and claims and invoice processing. Automation 360 helps extend the core work flow capabilities of ServiceNow so that you can automate repetitive tasks for intelligent, end-to-end automation. This Automation 360 command package enables Automation 360 bots and processes to use ServiceNow API features natively within the Automation 360 platform.

## ServiceNow Triggers

You can use the ServiceNow triggers to start Automation 360 bots to respond to the events in ServiceNow such as incident creation, updates, and so on. For more information on ServiceNow triggers, see [ServiceNow New Record trigger](#) on page 2299 and [ServiceNow Updated Record trigger](#) on page 2300.

The following video shows the interaction between Automation 360 and ServiceNow when you use ServiceNow command package:

## Use cases

The key use cases for this package include:

- Create, read, update, and delete records from a ServiceNow table.
- Add, download, and delete attachments on ServiceNow records.
- Streamline Incident responses.
- Trigger specific automations from the creation of new Incidents or Incident updates.

## Prerequisites

- The bot creator must have access to a ServiceNow account with required permissions to perform tasks enabled by this package. See [Roles](#).
- Follow ServiceNow guidelines for authenticating to external client with OAuth 2.0. See [Setup OAuth](#).
- Create a Developer account and Developer instance in ServiceNow. See [Personal Developer Instances](#).

Related reference

[ServiceNow package updates](#) on page 952

Review the updates in released versions of ServiceNow packages such as new and enhanced features as well as fixes and limitations. The page also lists the release dates of each version, and the compatible Control Room and Bot Agent versions.

## Authentication

Use the **Authentication** and **Revoke Authentication** action to connect or disconnect from your ServiceNow instance.

### ServiceNow authentication action

Use the **Authentication** action to connect to your ServiceNow instance. After the authentication is successful, you can use other command actions to perform various operations in ServiceNow.

- You must have the Client ID and Client secret generated in your ServiceNow instance. To generate the Client details, see [Create an OAuth API endpoint for external clients](#).
- You must have the **Bot creator role** for your Automation Anywhere Control Room to use the ServiceNow package in a bot.

You can use different connection methods to connect to ServiceNow:

- **OAuth2 - Client Credentials:** Use this connection method by providing the Salesforce account credentials. You need a Salesforce username and password to establish a connection.
  - **Control room OAuth connection:** Use this connection method by creating an OAuth connection and storing it in the Control Room. You must configure an OAuth connection in ServiceNow before creating the OAuth connection in Control Room. For more details, see [Create an endpoint for clients to access the instance](#).
1. Log in to the Control Room.
  2. Create a new bot or edit an existing bot. See [Create your first bot](#) on page 1489.
  3. From the Actions pane, select **ServiceNow > Authentication** and place it under the start of the bot flow.
  4. In the **Authentication Type** field, select the authentication method from the drop down.
  5. To view client ID and client secret details in ServiceNow for **OAuth2 - Client Credentials** authentication, complete the following steps:
    - a) Log in to your ServiceNow instance.
    - b) Click **All > Application Registry**.
    - c) Select the OAuth you created.
    - d) Use the Client ID and Client Secret in your Authentication action from the Control Room.
  6. To connect using OAuth2 - Client Credentials, complete the following steps:
    - a) In the **ServiceNow URL** field, enter your ServiceNow instance URL.
    - b) (Optional) Enter the API version.
    - c) In the **Client ID** field, enter the Client ID copied from ServiceNow. In the example video below an Insecure string is used, while you can use Credential or Variable options for better security.
    - d) In the **Client Secret** field, enter the Client Secret copied from ServiceNow.
    - e) Enter the ServiceNow user name.
    - f) Enter the ServiceNow password.

---

**Note:** You can use one of the following options to specify the **Client ID/Client secret/username/ password**:

- **Credential:** Enables you to use a value in the Credential Vault that contains information about the Client ID/Client secret/username/password.
- **Variable:** Enables you to use a credential variable that contains information about the Client ID/Client secret/username/password.
- **Insecure string:** Enables you to enter the Client ID/Client secret/username/password manually.

- 
7. To configure a **Control room OAuth connection** in ServiceNow, complete the following steps:
    - a) Complete step 1 to step 5 in [Create OAuth connection](#) on page 1893.
    - b) Log in to your ServiceNow instance.
    - c) Click **New > Create an OAuth API endpoint for external clients**.

- d) Enter the following details:
    1. **Name:** A unique name.
    2. **Client ID:** Client ID is automatically generated by the ServiceNow OAuth server.
    3. **Client Secret:** Client secret is automatically generated.
    4. **Refresh Token Lifespan:** Validity of refresh token in seconds.
    5. **Access Token Lifespan:** Validity of access token in seconds.
    6. **Redirect URL:** Add the Callback URL from [Create OAuth connection](#) on page 1893 as an authorized redirect URI.
    7. **Enforce Token Restriction:** Restricts the access token usage to the API 's defined in the REST API Access Policies. If this option is not selected, access token usage across other REST API's is allowed.
  - e) Click **Submit**.
  - f) Go to **Application Registry**. Click the info icon and copy the client ID and client secret.
  - g) Go to [Create OAuth connection](#) on page 1893 and complete the remaining steps to create an Oauth connection with the above details.
8. To connect using **Control room OAuth connection**, pick a custom connection you have created and stored in the Control Room. For more details, see [Configure OAuth connections in Control Room](#) on page 1889.
  9. Enter **Default** as the Session name.
  10. You can assign the authorization header to a variable by creating either a Multiple or Dictionary variable.
  11. Click **Run** to save and run your bot. Once authenticated, you can use the token to call other ServiceNow API services.

## ServiceNow revoke authentication action

Use the **Revoke Authentication** action to securely discard the refresh token and access token when you do not need them anymore.

1. From the **Actions** pane, select **ServiceNow > Authentication > Revoke Authentication** and place it under the bot flow.
2. Enter the session name and click Run.
3. After the bot runs, your ServiceNow access token is revoked.

## Records

Use the **Records** action to perform various operations in your ServiceNow instance. You can create, update, delete, or get records from a ServiceNow Table.

### ServiceNow create record action

Use the **Create Record** action to create a new data record in the ServiceNow Table app.

- Ensure that you are authenticated before calling any ServiceNow action. For more details, see [ServiceNow authentication action](#) on page 3019.

- You must create a table in your ServiceNow instance as this action only creates a new record for an existing table entry with the data provided. For more details, see [Creating a table](#).

1. From the Actions pane, select **ServiceNow > Records > Create Record** and place it in the canvas.

2. Specify details in the following fields:

- a) Enter the Table name. You can use a standard table name available in ServiceNow, for example: Incident. Or you can use a custom user defined table name, for example: u\_test\_table.

---

**Note:** For ServiceNow tables, ensure that you provide the Table name instead of the Label name.

---

- b) Enter the Fields and data to insert. Choose either Dictionary or Entry list. For this example, Dictionary is selected.

- Select the Type as String, Number, Datetime, or Boolean based on the data you want to insert in the table.
- Enter a key-value pair, where key is the ServiceNow field name and value is the data you want to update in the field.

---

**Note:** The key name for a field is different from the displayed label name. You can view the key name of the file by using one of the following options:

- In your ServiceNow developer instance, navigate to **System Definition > Language File**. You can use the filter option to view fields for specific Tables. For example: Incident.
- Right-click on the field name (as shown below) to display the key name. For example: caller\_id is the key name for the field **Caller**.

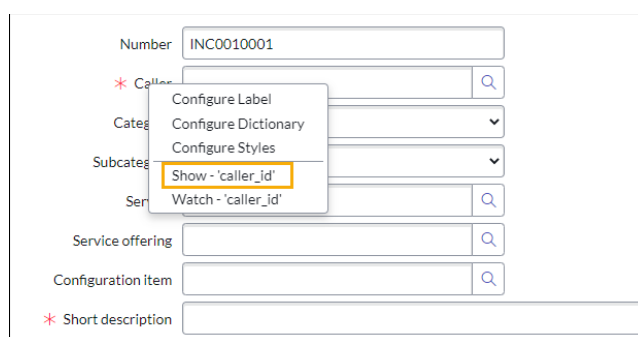

c) Enter Default as the session name.

d) Save the record ID to a variable. For example, the record ID is saved to sys\_id.

**ServiceNow: Create Record**

Inserts one record in the specified table  
Required bot agent version: 21.119 or above

Table name

a)  (x)

Fields and data (optional)

Dictionary

b)

Type	Key	Value
String	caller_id	Jane-1234

+  
Field names and values must be provided for required fields in the specified Table

Session name

c)  (x)

Assign record id to a string variable (optional)

d)  (x)

3. Click **Run** to save and run your bot.
4. Verify whether the record is created in the ServiceNow table.
  - a) Find the sys\_id variable value in the Debug mode.
  - b) Replace the ID in the ServiceNow URL (as shown below) to view the latest record created.

Browser URL: [https://dev85435.service-now.com/now/nav/ui/classic/params/target/incident.do%3Fsys\\_id%3D10256e5307669110efb1f1e08c1ed011%26sys\\_id%3D10256e5307669110efb1f1e08c1ed011](https://dev85435.service-now.com/now/nav/ui/classic/params/target/incident.do%3Fsys_id%3D10256e5307669110efb1f1e08c1ed011%26sys_id%3D10256e5307669110efb1f1e08c1ed011)

now All Favorites History Workspaces Incident - INCO0... Search

Incident INCO010009 Update Resolve

Number	<input type="text" value=""/>	Channel	-- None --
* Caller	<input type="text" value=""/>	State	New
Category	Inquiry / Help	Impact	3 - Low
Subcategory	-- None --	Urgency	3 - Low
Service	<input type="text" value=""/>	Priority	5 - Planning
Service offering	<input type="text" value=""/>	Assignment group	<input type="text" value=""/>
Configuration item	<input type="text" value=""/>	Assigned to	<input type="text" value=""/>
* Short description	<input type="text" value=""/>		
Description	<input type="text" value=""/>		

## ServiceNow delete record action

Use the **Delete Record** action to delete a record from a ServiceNow table.

Ensure that you are authenticated before initiating any ServiceNow action. For more details, see [ServiceNow authentication action](#) on page 3019.

1. From the **Actions** pane, select **ServiceNow > Records > Get Record** and place it in the canvas.
2. Specify details in the following fields:
  - a) **Table name**: Enter the ServiceNow table name.
  - b) **Record Sys\_id**: Enter the sys\_id of the record. If the record ID is captured in a variable, you can provide the variable name.
  - c) The session name displays as **Default**.

**ServiceNow: Delete Record**

Deletes a record from the specified table

Required bot agent version: 21.119 or above

Table name

a)  (x)

Record sys\_id

b)  (x)

Session name

c)  (x)

3. Click **Run** to save and run your bot. When the bot is run successfully, your record in the ServiceNow table is deleted.

## ServiceNow get record action

Use the **Get Record** action to retrieve a record using the record ID stored in sys\_id variable from ServiceNow.

Ensure that you are authenticated before initiating any ServiceNow action. For more details, see [ServiceNow authentication action](#) on page 3019.

1. From the **Actions** pane, select **ServiceNow > Records > Get Record** and place it in the canvas.
2. Specify details in the following fields:
  - a) **Table name**: Enter the ServiceNow table name.
  - b) **Record sys\_id**: Enter the sys\_id of the record. If the record ID is captured in a variable you can provide the variable name.
  - c) Select **List** for the **Field names (Optional)** field. Enter all the fields that you want to read.



- d) The session name displays as **Default**.
- e) Save the outcome to a variable. For example, the object ID is saved to dict\_GetRecordResults.

**ServiceNow: Get Record**

Retrieves the record identified by the specified sys\_id from the specified table

Required bot agent version: 21.119 or above

Table name

a)  (x)

Record sys\_id

b)  (x)

Field names (optional)

List Variable

c)  (x)

Session name

d)  (x)

Assign output to a dictionary variable

Multiple variables Dictionary

e)  (x)

3. Click **Run** to save and run your bot. When the bot is run successfully, the retrieved record is stored in the specified variable.

## ServiceNow get multiple records action

Use the **Get Multiple Records** action to retrieve multiple records from a ServiceNow table.

Ensure that you are authenticated before initiating any ServiceNow action. For more details, see [ServiceNow authentication action](#) on page 3019.

1. From the **Actions** pane, select **ServiceNow > Records > Get Multiple Records** and place it in the canvas.
2. Specify details in the following fields:
  - a) **Table name:** Enter the ServiceNow table name.
  - b) Select **List** in the **List of fields to return in the response (Optional)** field. Enter the **Type** and **Value** for the fields you want to view in the response.
  - c) You can optionally filter the records by using name-value pair or query. For example, select **Query** and specify a query parameter to retrieve records for only the queried fields. For example, you can map the sys\_id to a variable and add it as a query.
  - d) Specify a limit of records to view. If the **Limit** field is blank or set to 0, all records are returned. Response time might vary depending on the volume of the specified Table.

- e) The session name displays as **Default**.
- f) Save the outcome to a variable. For example, the object ID is saved to list\_GetMultipleRecordsResult.

**ServiceNow: Get Multiple Records**

Retrieves multiple records from the specified table

Required bot agent version: 21.119 or above

Table name

a  (x)

List of fields to return in the response (optional)

List Variable

b Type String (Type dropdown) (up/down/delete icons)

Value at 0  (x)

Type String (Type dropdown) (up/down/delete icons)

Value at 1  (x)

+

Filter records by

Name-value pair Query None

c Query (optional)  (x)

d Limit (optional)  (x)

If limit is left blank or set to 0, all records will be returned. Response time may vary depending on the volume of the specified Table

e Session name  (x)

f Assign matched records to a list variable  (x)

3. Click **Run** to save and run your bot. When the bot is run successfully, you will retrieve all the records from ServiceNow.

**Note:** The output is retrieved as a list of type `list`. To read an individual record (row) in this list, you need to loop through all the dictionary items using the `loop` action and read or extract the records (rows) individually. For example, the output of get multiple records is saved in the variable `list_of_records_any`. If the variable contains five

records, then each record is passed to the Loop action to be processed one at a

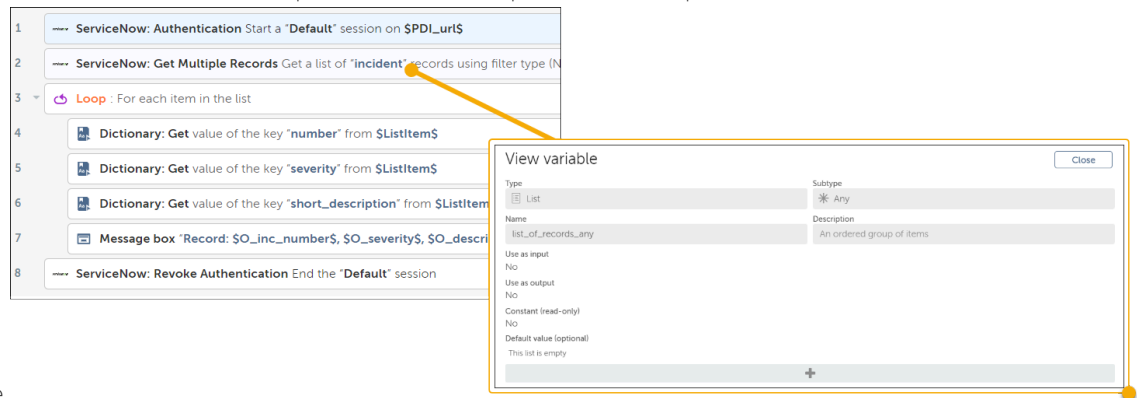

time.

## ServiceNow update record action

Use the **Update Record** action to update a record in ServiceNow with name-value pairs.

Ensure that you are authenticated before initiating any ServiceNow action. For more details, see [ServiceNow authentication action](#) on page 3019.

- From the **Actions** pane, select **ServiceNow > Records > Get Record** and place it in the canvas.
- Specify details in the following fields:
  - Table name:** Enter the ServiceNow table name.
  - Sys\_id:** Enter the sys\_id of the record. If the record ID is captured in a variable, you can provide the variable name.
  - In **Fields and data**, select **Dictionary** or **Entry list**. In the example, **Dictionary** is selected and the name-value pair is specified to update the record.
  - The session name displays as **Default**.

**ServiceNow: Update a Record**

Updates the specified record with the name-value pairs included in the request body

Required bot agent version: 21.119 or above

Table name  
a

Sys\_id  
b

Fields and data  
Dictionary Entry list  
c Dictionary Variable

Type	Key
String	category
Value Hardware	

Session name  
d

3. Click **Run** to save and run your bot. When the bot is run successfully, your record is updated with the specified details.

## Attachments

Use the Attachments action to upload or delete an attachment from a record in the ServiceNow table. You can also download an attachment from a ServiceNow record.

### ServiceNow add attachment action

Use the **Add Attachment** action to add a new attachment to the specified record in a ServiceNow Table app.

Ensure that you are authenticated before initiating any ServiceNow action. For more details, see [ServiceNow authentication action](#) on page 3019.

1. From the Actions pane, select **ServiceNow > Attachments > Add Attachment** and place it in the canvas.
2. Specify details in the following fields:
  - a) Enter the Table name.

---

**Note:** For ServiceNow tables, ensure that you provide the Table name instead of the Label name.

---

- b) Select the File to be uploaded by using one of the following options:

- **Control Room file:** If the file exists within the Control Room folders, select this option.
- **Desktop file:** If the file exists in your local system desktop, select this option and browse the file path.
- **Variable:** You can also store the file path as a variable.

**Note:** Maximum size of the file to upload cannot exceed 25 MB.

- (Optional) You can enter a name in the New file name field.
- The session name displays as **Default**.
- You can assign the attachment ID to a string variable. For example, the attachment ID is saved to str\_AttachmentSysId.

**ServiceNow: Add Attachment**

Adds an attachment to the specified record  
Required bot agent version: 21.119 or above

Table name  
a  (x)

Sys\_id  
b  (x)

File to be uploaded  
Control Room file Desktop file Variable  
c  (x) Browse...

New file name (optional)  
d  (x)

Session name  
e  (x)

Assign attachment sys\_id to a string variable (optional)  
f  (x)

3. Click **Run** to save and run your bot.
4. Verify whether the attachment is added in the ServiceNow record as shown below:

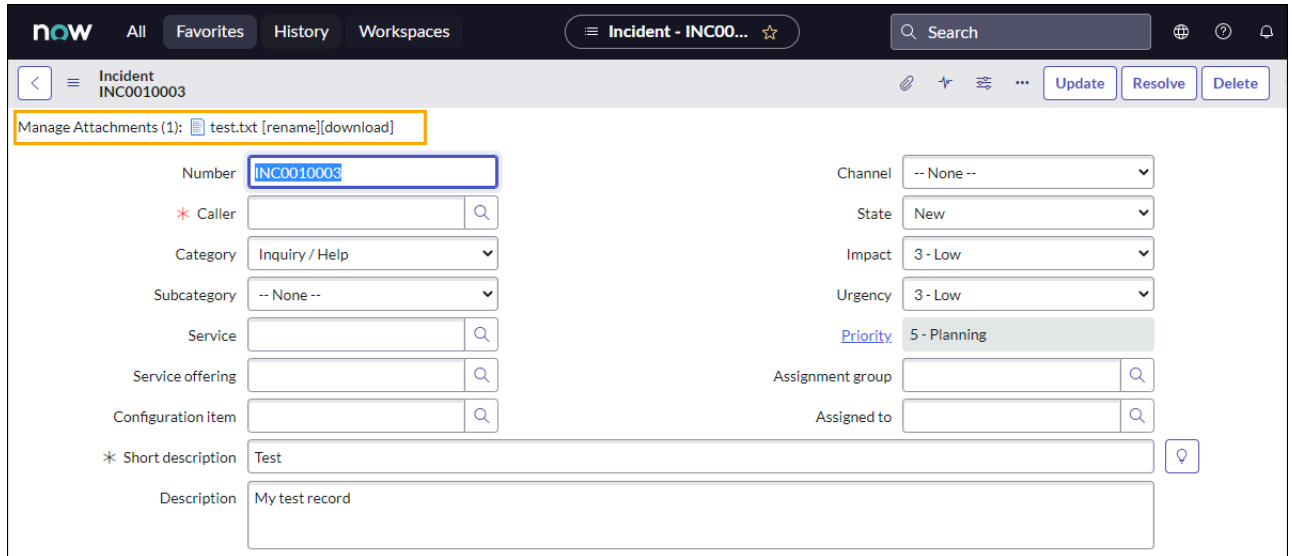

### ServiceNow delete attachment action

Use the **Delete Attachment** action to delete an attachment from a ServiceNow record.

Ensure that you are authenticated before initiating any ServiceNow action. For more details, see [ServiceNow authentication action](#) on page 3019.

1. From the **Actions** pane, select **ServiceNow > Attachments > Delete Attachment** and place it in the canvas.
2. Specify details in the following fields:
  - a) **Sys\_id**: Enter the attachment ID or select the variable where you stored the attachment ID.
  - b) The session name displays as **Default**.

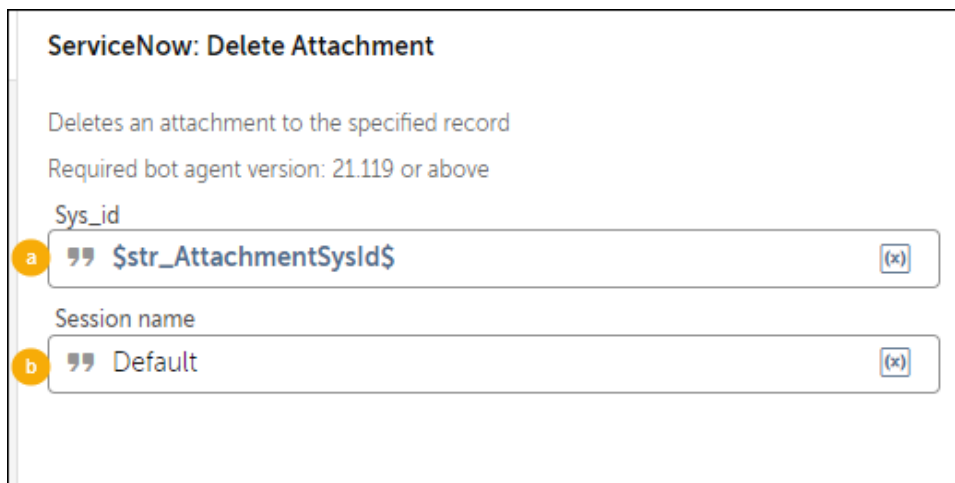

3. Click **Run** to save and run your bot. When the bot is run successfully, your attachment in the ServiceNow record is deleted.

## ServiceNow get attachment action

Use the Get Attachment action to download a new attachment from the specified record in a ServiceNow Table app.

Ensure that you are authenticated before initiating any ServiceNow action. For more details, see [ServiceNow authentication action](#) on page 3019.

1. From the Actions pane, select **ServiceNow > Attachments > Get Attachment** and place it in the canvas.
2. Specify details in the following fields:
  - a) **Filter attachment by.**
    - **Sys\_id:** Specify the attachment ID or select a variable where the attachment ID is stored.
    - **Associated record:** Specify details of the associated record, to download the associated attachment. You must enter the table name and the table ID.
    - **Query:** Specify a query parameter to download the attachments. For example, you can map the sys\_id to a variable and add it as a query.
  - b) Enter a Destination folder path, or select a variable if the path is stored in a variable.
  - c) The session name displays as **Default**.
  - d) You can assign the attachment ID to a string variable. For example, the attachment ID is saved to list\_GetAttachmentResults.

**ServiceNow: Get Attachment**

Downloads attachment(s) to the specified folder location

Required bot agent version: 21.119 or above

Filter attachment by

a) Sys\_id Associated record Query

Sys\_id

» \$str\_AttachmentSysId\$ (x)

Destination folder path

b) » \$str\_DestinationFolderPath\$ (x)

e.g C:\Users\...\attachment-download-folder

Session name

c) » Default (x)

Assign file metadata to a list variable (optional)

d) list\_GetAttachmentResults (x)

3. Click **Run** to save and run your bot.
4. The attachment is downloaded to the specified folder path.

**Note:** The output is retrieved as a list of type . To read an individual record (row) in this list, you need to loop through all the dictionary items using the action and read or extract the records (rows) individually. For example, the output of get multiple records is saved in the variable list\_of\_records\_any. If the variable contains five

records, then each record is passed to the Loop action to be processed one at a

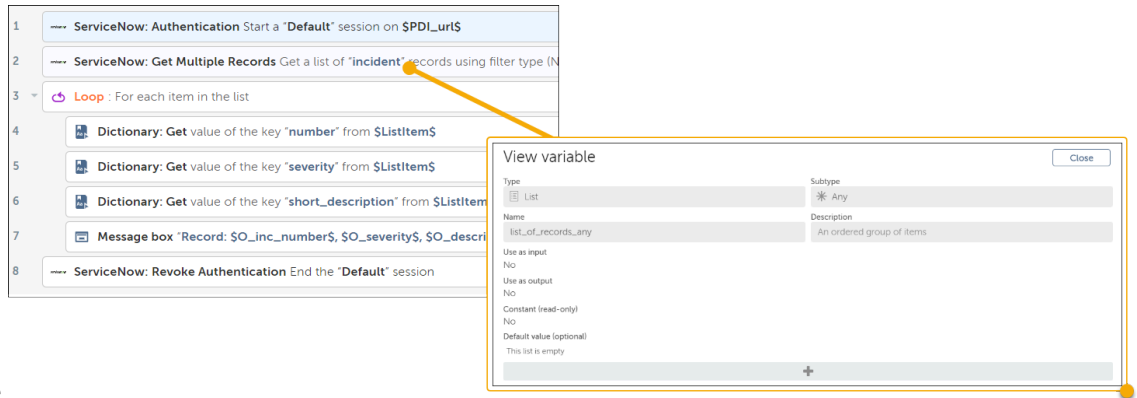

time.

## ServiceNow field types: Table API

The ServiceNow schema contains various fields that you can modify by using the Automation 360 ServiceNow command package. The following table lists alphabetically the supported field types and their corresponding Automation 360 to ServiceNow actions.

Field Type	Create / Update Record	Get Record
Audio	Not supported	Supported
Choice	Supported	Supported
Collection	Not supported	Not supported
Color	Supported	Supported
Condition String	Limited support	Supported
Conditions	Supported	Supported
Currency	Supported	Supported
Data Structure	Supported	Supported
Date	Supported	Supported
Date/Time	Supported	Supported
Decimal	Supported	Supported
Document ID	Supported	Supported
Domain ID	Supported	Supported
Due Date	Supported	Supported



Field Type	Create / Update Record	Get Record
<b>Duration</b>	Supported	Supported
<b>Field Name</b>	Supported	Supported
<b>File Attachment</b>	Not Supported	Supported
<b>Floating Point Number</b>	Supported	Supported
<b>FX Currency</b>	Supported	Supported
<b>HTML</b>	Supported	Supported
<b>Icon</b>	Supported	Supported
<b>Image</b>	Not Supported	Supported
<b>Integer</b>	Supported	Supported
<b>IP address</b>	Supported	Supported
<b>Journal</b>	Supported	Supported
<b>Journal Input</b>	Supported	Supported
<b>Journal List</b>	Supported	Supported
<b>List</b>	Supported	Supported
<b>Long</b>	Supported	Supported
<b>Name-Value Pairs</b>	Supported	Supported
<b>Password (1 Way Encrypted)</b>	Supported	Supported
<b>Password (2 Way Encrypted)</b>	Supported	Supported
<b>Percent Complete</b>	Supported	Supported
<b>Phone Number (E164)</b>	Supported	Supported
<b>Price</b>	Supported	Supported
<b>Reference</b>	Supported	Supported
<b>Script</b>	Not Supported	Supported
<b>Script (Plain)</b>	Supported	Supported

Field Type	Create / Update Record	Get Record
<b>String</b>	Supported	Supported
<b>String (Full UTF-8)</b>	Supported	Supported
<b>Suggestion</b>	Supported	Supported
<b>Sys ID</b>	Supported	Supported
<b>Table Name</b>	Supported	Supported
<b>Time</b>	Supported	Supported
<b>Translated HTML</b>	Supported	Supported
<b>Translated Text</b>	Supported	Supported
<b>True/False</b>	Supported	Supported
<b>URL</b>	Supported	Supported
<b>Video</b>	Not Supported	Supported
<b>Wiki</b>	Not Supported	Supported
<b>Workflow</b>	Supported	Supported

## SharePoint package

SharePoint is a web-based platform that is used for collaboration and document management. You can use the Automation 360 SharePoint command package to manage your documents, sites, and data.

---

### Note:

The SharePoint mark and logo are trademarks or registered trademarks of Microsoft and are used for identification purposes only.

---

SharePoint is a collaborative platform that integrates natively with Microsoft Office. You can use the SharePoint package to securely store, organize, share, and access information. You can streamline processes and reduce manual work using the automated SharePoint operations in Automation 360. You can quickly and easily manage your documents, sites, and data. Automation 360 platform provides automation capabilities for other Microsoft products such as Microsoft Office, Outlook, and Windows. By adding the SharePoint package, you can leverage the full potential of the Microsoft platform from Automation 360.

---

**Note:** This package is new in v.29 and is based on the SharePoint REST v1 API.

---

You can use the SharePoint package to perform the following CRUD (create, read, update, and delete) actions in a SharePoint site:

- [CRUD operations for folder and file](#)
- [CRUD operations for list and list items](#)

### SharePoint workflow

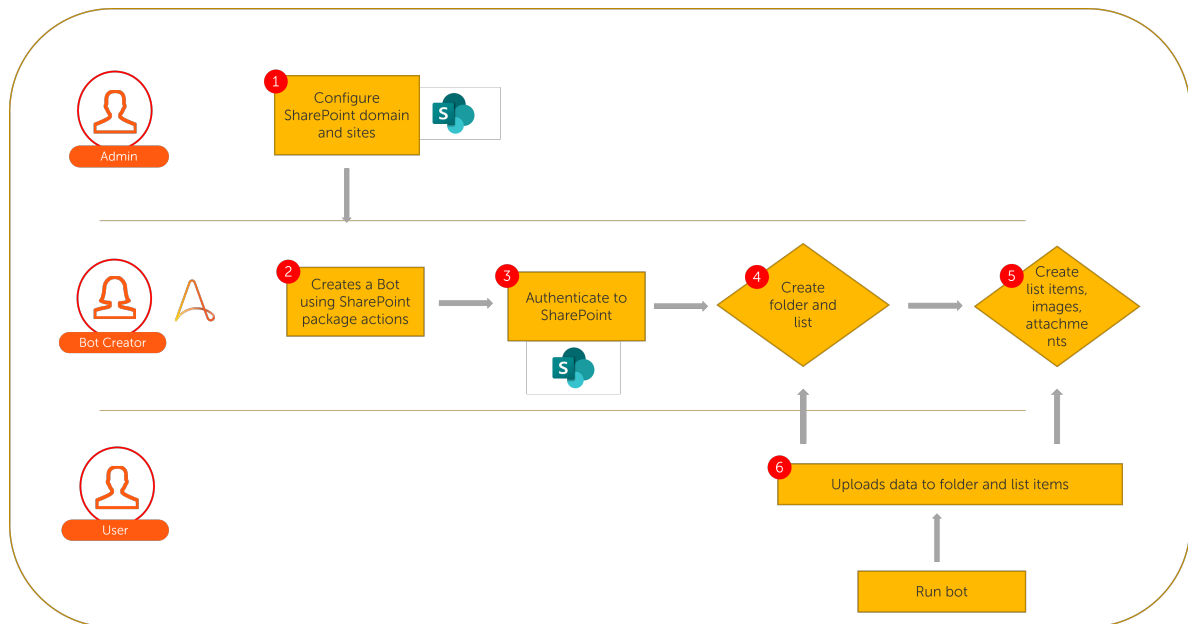

### Actions in SharePoint package

You can perform the following actions in the SharePoint package:

Action	Description
<a href="#">Configuring SharePoint domain and sites</a>	The SharePoint package connects to a particular SharePoint domain using app-based permissions. You must configure your SharePoint domain and add relevant app permissions.
<a href="#">SharePoint authenticate action</a>	Use the <b>Authenticate</b> action to connect to your SharePoint domain. After the authentication is successful, you can use the other command actions to perform various operations in SharePoint.
<a href="#">SharePoint folder and file</a>	Use the <b>Folder and file</b> actions to perform various operations in your SharePoint site. You can create, get details, delete, or rename folders in a specific SharePoint site. You can also upload, delete, download, and get files in a specified folder.
<a href="#">SharePoint list and list items</a>	Use the <b>List and list item</b> actions to perform various operations in your SharePoint site. You can create, get, delete, or update list and list items in a specific SharePoint site.

Related reference

[SharePoint package updates](#) on page 953

Review the updates in released versions of SharePoint packagesuch as new and enhanced features as well as fixes and limitations. The page also lists the release dates of each version, and the compatible Control Room and Bot Agent versions.

## Configuring SharePoint app, sites, and app permissions

The SharePoint package connects to a particular SharePoint domain using app-based permissions. You must configure your SharePoint domain and add relevant app permissions.

**Note:** The examples and graphics provided on this page are for representation purposes only and may not accurately reflect your specific instance. We do not assume responsibility for their maintenance or accuracy.

To register and configure a new app in SharePoint, you must complete the following steps before using the SharePoint package. You can use the client ID and client secret of the newly registered app to log in to SharePoint through the Automation 360 SharePoint package.

### Configure new app

1. To register a new app, go to: [https://{your\\_sharepoint\\_domain}/\\_layouts/15/appregnew.aspx](https://{your_sharepoint_domain}/_layouts/15/appregnew.aspx). Replace {your\_sharepoint\_domain} with your specific SharePoint domain (for example: automationanywhere.sharepoint.com).
2. Click Generate to generate a new client ID and client secret.
3. You can view the app details in the confirmation page. Copy and save the details to use in the package.

**Note:** You must have the SharePoint Administrator role to access the registration link.

The screenshot displays the 'App Information' configuration page in SharePoint. The page includes the following fields and controls:

- Client ID:** A text input field with a 'Generate' button next to it.
- Client Secret:** A text input field with a 'Generate' button next to it.
- Title:** A text input field containing 'My App'.
- App Domain:** A text input field containing 'www.myapp.com'.
- Redirect URI:** A text input field containing 'https://www.myapp.com/default'.

Yellow boxes highlight the Client ID and Client Secret fields, their respective Generate buttons, and the Create button at the bottom right of the form.

## Configure app permissions

Once you have registered the app, you must configure the app-based permission.

1. To configure app permission, go to: `https://{your_sharepoint_domain}/_layouts/15/appinv.aspx`. Replace `{your_sharepoint_domain}` with your specific SharePoint domain (for example: `automationanywhere.sharepoint.com`).
2. Enter the client ID for the newly created app and click **Lookup**. Your app details will be displayed. Copy the following XML snippet and paste it in the **Permission Request XML** box:

```
<AppPermissionRequests AllowAppOnlyPolicy="true">
  <AppPermissionRequest Scope="http://sharepoint/content/sitecollection" Right="FullControl" /> </AppPermissionRequests>
```

3. Click **Create** to save your changes.

The screenshot shows the SharePoint 'App Inv' configuration page. The 'App Id' field has a 'Lookup' button next to it. The 'Title' field is filled with 'My App'. The 'App Domain' field is filled with 'www.myapp.com'. The 'Redirect URL' field is filled with 'https://www.myapp.com/default'. The 'Permission Request XML' field is highlighted with a yellow box and contains the XML snippet from the previous step. The 'Create' button at the bottom right is also highlighted with a yellow box.

4. In the next screen, click **Trust It** to grant the required permissions.

## Configure individual SharePoint sites

You must configure individual SharePoint sites. If you have multiple SharePoint sites in your organization, repeat this process for each individual site you want to connect to.

1. To configure individual sites, go to: `https://{your_sharepoint_domain}/sites/{sitename}/_layouts/15/appinv.aspx`. Replace `{your_sharepoint_domain}` with your specific SharePoint domain (for example: `automationanywhere.sharepoint.com`) and `{sitename}` with the site name you have created.
2. Follow the instructions provided in [Configure app permissions](#) on page 3037, to add the app based permissions to your SharePoint site.

**Important:** You need the **Full Control** permission to access the configuration link. It is recommended that you contact the owner of the SharePoint site, your SharePoint admin, or Microsoft 365 admin to get the **Full Control** permission. If you have Edit, Contribute, or Design permissions to the SharePoint site, you cannot access the configuration link.

---

## Configure OAuth connection in SharePoint

You must configure an OAuth connection in SharePoint before creating the OAuth connection in Control Room.

1. Complete step 1 to step 5 in [Create OAuth connection](#) on page 1893.
2. Log into [Azure portal](#) and navigate to **App Registration**.
3. Click **New registration** and enter the following details:
  - a) Enter a name for the app.
  - b) Select **Single Tenant**.
  - c) In the **Redirect URI** field, select **Web** from the drop-down and enter the callback URL from [Create OAuth connection](#) on page 1893.

---

**Note:** For the OAuth connection to be successful you must enter the callback URL.

---
- d) Click **Register**.
4. Go to **App Overview**.
5. Copy the client ID from the Application (client) ID.
6. Click **Add a certificate or secret** in the **Client credentials** field.
7. Click **New client secret**.
8. Copy the client secret from the **Value** field.
9. Go to [Create OAuth connection](#) on page 1893 and complete the remaining steps to create an OAuth connection with the above details.

## SharePoint authenticate action

Use the **Authenticate** action to connect to your SharePoint domain. After the authentication is successful, you can use the other command actions to perform various operations in SharePoint.

---

**Note:** The examples and graphics provided on this page are for representation purposes only and may not accurately reflect your specific instance. We do not assume responsibility for their maintenance or accuracy.

---

- You must have the client ID and client secret generated for your SharePoint domain. To generate the client details, see [SharePoint package](#) on page 3034.
- You must have the Bot Creator role for your Automation Anywhere Control Room to use the SharePoint package in a bot.

You can authenticate to either a cloud or on-premises SharePoint domain. To access your cloud SharePoint domain, log in to your SharePoint account from a web browser. SharePoint on-premises is an in-house version of SharePoint installed on your local server.

You can use different connection methods to connect to SharePoint:

- **OAuth2 - Client Credentials:** Use this connection method by providing the SharePoint credentials.
- **Control room OAuth connection:** Use this connection method by creating an OAuth connection and storing it in the Control Room.

1. Log in to the Automation Anywhere Control Room.
2. You can create a new bot or modify an existing bot. For more details, see [Create your first bot](#) on page 1489.
3. From the **Actions** pane, select **SharePoint > Authenticate** and place it under the start of the bot flow.
4. In the **Authentication Type** field, select the authentication method from the drop down.

5. To connect using **OAuth2 - Client Credentials**, complete the following steps:
  - a) In the **Client ID** field, enter the client ID copied from SharePoint. This example uses **Insecure string** however, you can use **Credential** or **Variable** options for better security.
  - b) In the **Client secret** field, enter the client secret copied from SharePoint.
  - c) In the **Tenant ID** field, enter the tenant ID copied from SharePoint. To view the tenant ID, go to [https://{your\\_sharepoint\\_domain}/\\_layouts/15/AppPrincipals.aspx](https://{your_sharepoint_domain}/_layouts/15/AppPrincipals.aspx). Replace {your\_sharepoint\_domain} with your SharePoint domain name. In the **App identifier** column, the tenant ID is displayed after the @ symbol as shown in the following image:

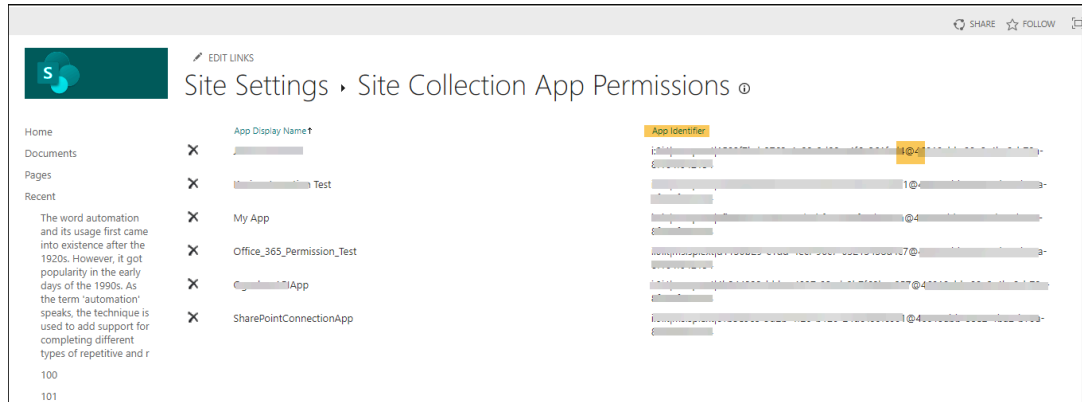

**Note:** You can use one of the following options to specify the **Client ID/Client secret/Tenant ID**:

- **Credential:** Enables you to use a value in the Credential Vault that contains information about the client ID/client secret/tenant ID.
- **Variable:** Enables you to use a credential variable that contains information about the client ID/client secret/tenant ID.
- **Insecure string:** Enables you to enter the client ID/client secret/tenant ID as a string.

6. To connect using **Control room OAuth connection**, pick a custom connection you have created and stored in the Control Room. For more details, see [Configure OAuth connections in Control Room](#) on page 1889.
7. In the **Domain** field, select one of the following options.
  - **Cloud:**
    - Enter the SharePoint subdomain name.
    - Enter the site name.

**Note:** The site name you provide in the authentication action will be the default site selected for the other actions in this package. You can provide a different site name for the individual actions as well.

- **Custom/on premises:**
  - Enter your SharePoint on-premises URL in the format `https://{url}` (for example: `https://sharepoint.automationanywhere.com/`).
  - Enter the site name.

**Note:** The site name you provide in the authentication action will be the default site selected for the other actions in this package. You can provide a different site name for the individual actions as well.



**7** Domain

Cloud Custom/on premises

Subdomain

” automationanywherestore (x)

Https://{subdomain}.sharepoint.com

Site name (optional)

” AutomationAnywhere (x)

https://{subdomain}.sharepoint.com/site/{SiteName}

**8**  Teams site

**9** Create SharePoint session

Local session Global session Variable

Local session name can only be used in this bot.

” Default (x)

8. Select the **Teams site** check box to connect to a SharePoint teams site. By enabling the Teams site checkbox, you can connect to Sharepoint's Team based managed paths and perform operations.

**Note:**

A managed path is a location within a SharePoint web application in which you can have site collections. Managed paths allow you to specify a path users will use to access your site contents. By default, SharePoint Online provides two managed paths:

- **sites:** This managed path is used for creating site collections, and the URLs for site collections created using this path follow this format: `https://<yourdomain>.sharepoint.com/sites/<sitename>`.
- **teams:** This managed path is used for creating modern team sites, and the URLs for team sites created using this path follow this format: `https://<yourdomain>.sharepoint.com/teams/<sitename>`.

9. In the **Create SharePoint session** field, select one of the following options:
- **Local session:** You can use the local session name only for the current bot.
  - **Global session:** You can use the global session name in other parent and child bots.
  - **Variable:** You can add the session name to a variable and use the variable in other actions.

You are successfully authenticated to the SharePoint domain.

## SharePoint folder and file

Use the **Folder and file** actions to perform various operations in your SharePoint site. You can create, get details, delete, or rename folders in a specific SharePoint site. You can also upload, delete, download, and get files in a specified folder.

### Folder and file actions in SharePoint package

The SharePoint package includes the following folder and file actions:

Action	Description
<a href="#">SharePoint create folder Action</a>	Use the <b>Create folder</b> action to create a new folder in the specified path in your SharePoint site.
<a href="#">SharePoint delete folder Action</a>	Use the <b>Delete folder</b> action to delete a folder from the specified path in your SharePoint site.
<a href="#">SharePoint get folder Action</a>	Use the <b>Get folder</b> action to retrieve details of a specific folder or all folders in the specified path in your SharePoint site.
<a href="#">SharePoint rename folder Action</a>	Use the <b>Rename folder</b> action to retrieve details of a specific folder or all folders in the specified path in your SharePoint site.
<a href="#">SharePoint delete file Action</a>	Use the <b>Delete file</b> action to delete a file from the specified path in your SharePoint site.
<a href="#">SharePoint download file Action</a>	Use the <b>Download file</b> action to download a file from a folder in your SharePoint site.
<a href="#">SharePoint get files Action</a>	Use the <b>Get file(s)</b> action to retrieve one or more file details from your SharePoint site.
<a href="#">SharePoint upload file Action</a>	Use the <b>Upload file</b> action to upload a file to a folder in your SharePoint site.

### SharePoint create folder action

Use the **Create folder** action to create a new folder in the specified path in your SharePoint site.

**Note:** The examples and graphics provided on this page are for representation purposes only and may not accurately reflect your specific instance. We do not assume responsibility for their maintenance or accuracy.

- Ensure that you are authenticated before initiating any SharePoint action. For more details, see [SharePoint authenticate action](#) on page 3038.
- You must create a SharePoint site to store the folder and file data. For more details, see [Create new app in SharePoint](#).

1. From the **Actions** pane, select **SharePoint > Folder and file > Create folder** and place it in the canvas.

**SharePoint: Create folder**

Creates a folder in the path provided when the correct information is entered

Required bot agent version: 21.250 or above

Site

2 Default site Other site

Document library path

3 " SiteAssets (x)

Folder path must not be greater than 400 chars

Folder name

4 " Docs\_Test (x)

Folder name must not be greater than 260 chars

Session

Session name Variable

5 " Default (x)

The name you gave the session when you opened it.

Folder path

6 " folder\_path (x)

2. In the **Site** field, select one of the following options:
  - **Default site:** The site name used during authentication is considered the default site.
  - **Other site:** If you want to choose a different site to create a folder, specify the different site name.
3. In the **Document library field**, specify the path where the folder must be created.

---

**Note:** You can create folders only within the **Document library** type of the site contents. To view the path name, hover over one of the document library names and view the folder path as shown in the following image:

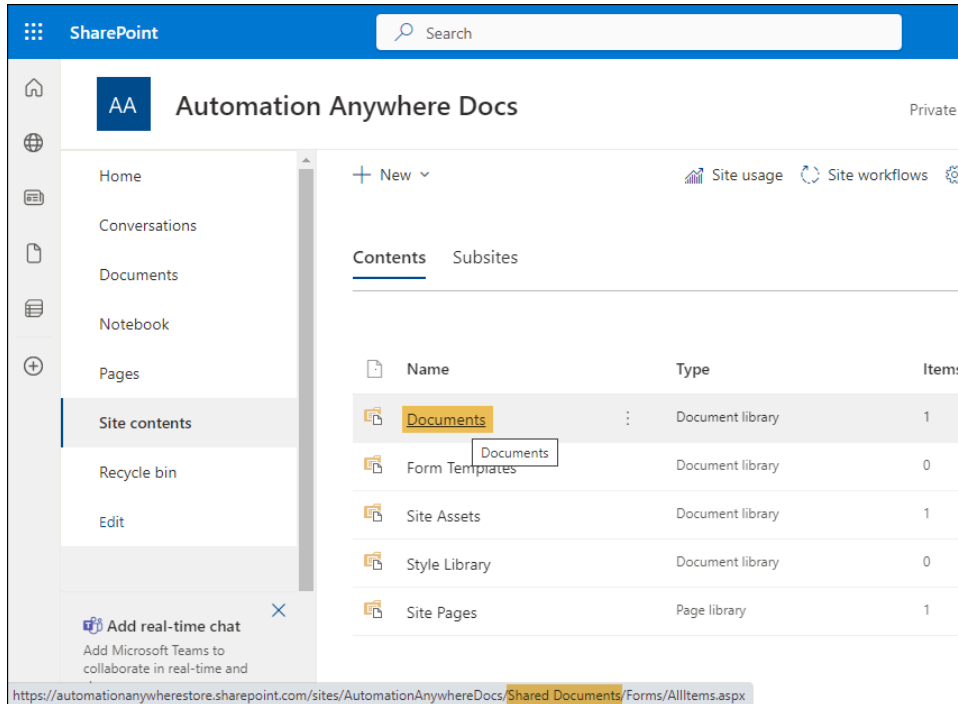

4. In the **Folder name** field, specify the folder name you want to create.
5. In the **Session** field, select one of the following options:
  - **Session name**: The name you provided for the session during authentication.
  - **Variable**: Select a variable which contains the session name.
6. In the **Folder path** field, select a variable to store the created folder path name.

A new folder is created using the specified path.

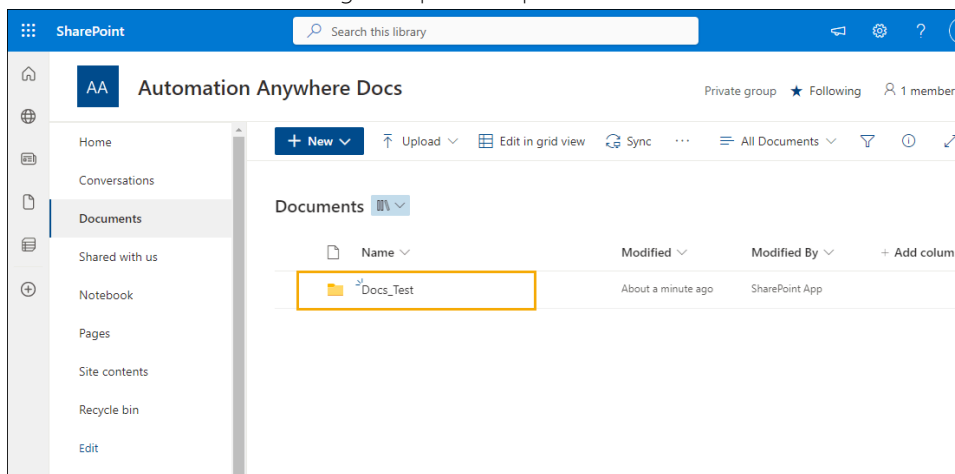

## SharePoint delete folder action

Use the **Delete folder** action to delete a folder in the specified path in your SharePoint site.

Ensure that you are authenticated before initiating any SharePoint action. For more details, see [SharePoint authenticate action](#) on page 3038.

1. From the **Actions** pane, select **SharePoint > Folder and file > Delete folder** and place it in the canvas.
2. In the **Site** field, select one of the following options:
  - **Default site:** The site name used during authentication is considered as the default site.
  - **Other site:** If you want to choose a different site, specify the different site name.
3. In the **Folder path** field, specify the folder path followed by the folder name.
4. In the **Session** field, select one of the following options:
  - **Session name:** The name you have provided for the session during authentication.
  - **Variable:** Select a variable which contains the session name.

The specified folder is deleted.

## SharePoint get folder action

Use the **Get folder** action to retrieve details of a specific folder or all folders in the specified path in your SharePoint site.

---

**Note:** The examples and graphics provided on this page are for representation purposes only and may not accurately reflect your specific instance. We do not assume responsibility for their maintenance or accuracy.

---

Ensure that you are authenticated before initiating any SharePoint action. For more details, see [SharePoint authenticate action](#) on page 3038.

1. From the **Actions** pane, select **SharePoint > Folder and file > Get folder** and place it in the canvas.

**SharePoint: Get folder(s)**

The action should return a list of folders from SharePoint when the correct inputs have been entered

Required bot agent version: 21.250 or above

Site

2

Folder path

3  (x)

Example: SiteAssets/FolderName

Get all / filter by

4  ▼

Session

5  (x)

The name you gave the session when you opened it.

List of folders

7  ▼ (x) <sub>+</sub>

2. In the **Site** field, select one of the following options:
  - **Default site:** The site name used during authentication is considered the default site.
  - **Other site:** If you want to choose a different, specify the different site name.
3. In the **Folder path** field, specify the folder path followed by the folder name.

---

**Note:** You can view the folder path in your SharePoint site. To view the root folder name, hover over one of the document library names and view the folder path as shown in the following image:

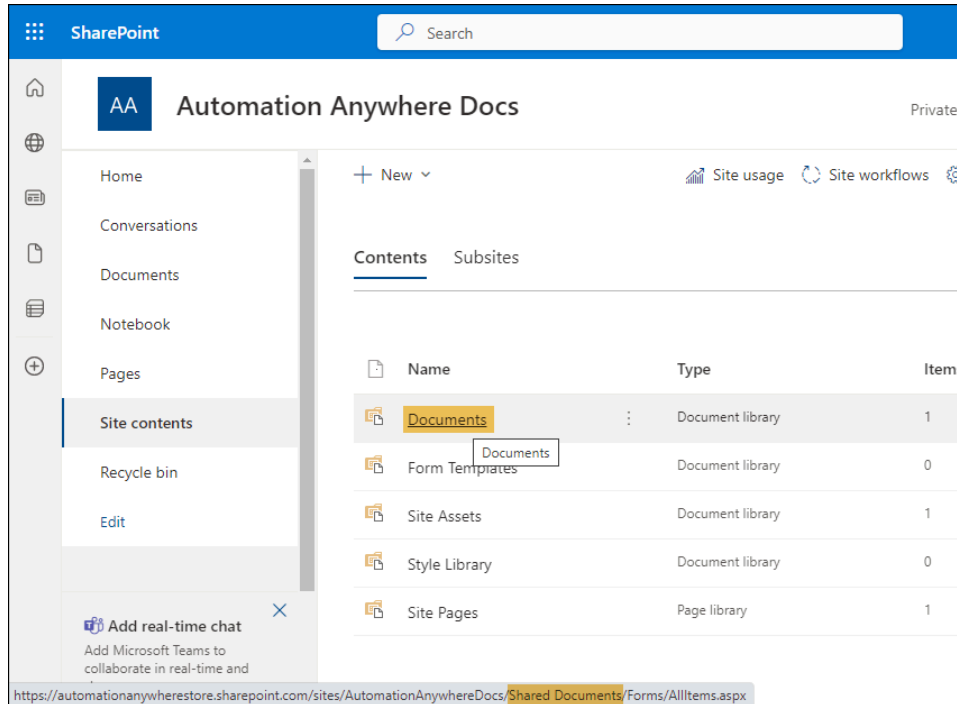

4. In the **Get all / filter by** field, select one of the following options:
  - **All folders:** Retrieve details of all the folders in the specified path.
  - **Folder name:** Specify a folder name to retrieve details of this folder.
5. In the **Session** field, select one of the following options:
  - **Session name:** The name you provided for the session during authentication.
  - **Variable:** Select a variable which contains the session name.
6. In the **List of folders** field, select a variable to store the retrieved folder data.

The specified folder details is retrieved and stored in the variable.

**Note:** The output is retrieved as a list of type `.` To read an individual record (row) in this list, you need to loop through all the dictionary items using the `action` and read or extract the records (rows) individually. For example, if the list is stored in the variable `list_FolderDetails` and it contains five records, then each record is passed to the `Loop` action to be processed

one at a time. The loop reads the Name, URL, last modified time and Unique Id of each

folder.

## SharePoint rename folder action

Use the **Rename folder** action to rename a specific folder in the specified path in your SharePoint site.

Ensure that you are authenticated before initiating any SharePoint action. For more details, see [SharePoint authenticate action](#) on page 3038.

1. From the **Actions** pane, select **SharePoint > Folder and file > Rename folder** and place it in the canvas.

2. In the **Site** field, select one of the following options:
  - **Default site:** The site name used during authentication is considered the default site.
  - **Other site:** If you want to choose a different site, specify the different site name.
3. In the **Folder path** field, specify the folder path followed by the folder name.
4. In the **New folder name** field, specify the new folder name you want to rename the folder to.



5. In the **Session** field, select one of the following options:
  - **Session name**: The name you provided for the session during authentication.
  - **Variable**: Select a variable which contains the session name.

The specified folder is renamed with the new folder name.

### SharePoint delete file action

Use the **Delete file** action to delete a file in the specified path in your SharePoint site.

Ensure that you are authenticated before initiating any SharePoint action. For more details, see [SharePoint authenticate action](#) on page 3038.

1. From the **Actions** pane, select **SharePoint > Folder and file > Delete file** and place it in the canvas.
2. In the **Site** field, select one of the following options:
  - **Default site**: The site name used during authentication is considered the default site.
  - **Other site**: If you want to choose a different site, specify the different site name.
3. In the **File path** field, specify the folder path followed by the file name.
4. In the **Session** field, select one of the following options:
  - **Session name**: The name you provided for the session during authentication.
  - **Variable**: Select a variable which contains the session name.

The specified file is deleted from the folder.

### SharePoint download file action

Use the **Download file** action to download a file from a folder in your SharePoint site.

Ensure that you are authenticated before initiating any SharePoint action. For more details, see [SharePoint authenticate action](#) on page 3038.

1. From the **Actions** pane, select **SharePoint > Folder and file > Download file** and place it in the canvas.

**SharePoint: Download file**

Download the file to the destination folder provided when the correct information is entered

Required bot agent version: 21.250 or above

Site

2 Default site Other site

File path

3 " Shared Documents/Test\_docs/Test File (x)

Example: SiteAssets/FileName.txt

Destination folder

4 " C:\Users\prarthana.reddy\Downloads (x)

Session

Session name Variable

5 " Default (x)

The name you gave the session when you opened it.

File details

Multiple variables Dictionary

6 " filedownload (x)

2. In the **Site** field, select one of the following options:
  - **Default site:** The site name used during authentication is considered the default site.
  - **Other site:** If you want to choose a different site, specify the different site name.
3. In the **File path** field, specify the file path followed by the file name.

---

**Note:** The file path must contain the main **Document Library** folder name followed by the parent folder (if any) and the file name (for example: `Shared Documents/Test_docs/Test File`). You must specify the file extension only if the file name contains the extension in SharePoint.

---

4. In the **Destination folder** field, specify the local folder path where you want to download the file.
5. In the **Session** field, select one of the following options:
  - **Session name:** The name you provided for the session during authentication.
  - **Variable:** Select a variable which contains the session name.
6. In the **File details** field, select one of the following options:
  - **Multiple variables:** Add a key-value pair to store the file details.
  - **Dictionary:** Select a dictionary variable to store the file details.

The specified file is downloaded to the destination folder.

## SharePoint get files action

Use the **Get file(s)** action to retrieve one or more file details from your SharePoint site.

Ensure that you are authenticated before initiating any SharePoint action. For more details, see [SharePoint authenticate action](#) on page 3038.

1. From the **Actions** pane, select **SharePoint > Folder and file > Get file(s)** and place it in the canvas.

**SharePoint: Get file(s)**

Get list of files from SharePoint when the correct inputs have been entered

Required bot agent version: 21.250 or above

**Site**

2  Default site  Other site

**Folder path**

3

Example: SiteAssets/FolderName

**Get all / filter by**

4

**File name (optional)**

**Session**

Session name  Variable

5

The name you gave the session when you opened it.

---

**List of files**

6

2. In the **Site** field, select one of the following options:
  - **Default site:** The site name used during authentication is considered the default site.
  - **Other site:** If you want to choose a different site, specify the different site name.
3. In the **Folder path** field, specify the main **Document Library** folder name followed by the parent folder.
4. In the **Get all / filter by** field, select one of the following options:

- **All files:** Select this option to retrieve all file details available in your SharePoint site.
  - **File name:** Specify a file name to retrieve the file details.
  - **File extension:** Specify a file extension to retrieve all file details with the specified extension.
5. In the **Session** field, select one of the following options:
    - **Session name:** The name you provided for the session during authentication.
    - **Variable:** Select a variable which contains the session name.
  6. In the **List of files** field, select a variable to store the file details.

One or more file details are retrieved and stored in the variable.

**Note:** The output is retrieved as a list of type . To read an individual record (row) in this list, you need to loop through all the dictionary items using the action and read or extract the records (rows) individually. For example, if the list is stored in the variable list\_FileDetails and it contains five records, then each record is passed to the Loop action to be processed one at a time. The loop reads the filename, URL, last modified time and Unique Id of each

file.

## SharePoint upload file action

Use the **Upload file** action to upload a file to a folder in your SharePoint site.

Ensure that you are authenticated before initiating any SharePoint action. For more details, see [SharePoint authenticate action](#) on page 3038.

**Note:** The maximum file size that can be uploaded is 25 MB.

1. From the **Actions** pane, select **SharePoint > Folder and file > Upload file** and place it in the canvas.

### SharePoint: Upload file

Creates a file in the path provided when the correct information is entered

Required bot agent version: 21.250 or above

Site

2

Folder path

3  (x)

Example: SiteAssets/FolderName

File name

4  (x)

File content

5

(x)

Session

6  (x)

The name you gave the session when you opened it.

---

File path

7  (x)

2. In the **Site** field, select one of the following options:
  - **Default site:** The site name used during authentication is considered the default site.
  - **Other site:** If you want to choose a different site, specify the different site name.
3. In the **Folder path** field, specify the main **Document Library** folder name followed by the parent folder.
4. In the **File name** field, specify the name of the file that will be displayed in SharePoint. You can provide the file name with or without an extension.
5. In the **File content** field, select one of the following options:
  - **Control room file:** Choose a file that is available in the Control Room.
  - **Desktop file:** Browse and select a file from your local system.
  - **Variable:** Insert a variable that contains the file path.
6. In the **Session** field, select one of the following options:
  - **Session name:** The name you provided for the session during authentication.

- **Variable:** Select a variable which contains the session name.

7. In the **File path** field, select a variable to store the file path details.

The specified file is uploaded to the destination folder.

## SharePoint list and list items

Use the **List and list item** actions to perform various operations in your SharePoint site. You can create, get, delete, or update list and list items in a specific SharePoint site.

### List and list item actions in SharePoint package

The SharePoint package includes the following list and list item actions:

Action	Description
<a href="#">SharePoint create list Action</a>	Use the <b>Create list</b> action to create a new list in your SharePoint site.
<a href="#">SharePoint delete list Action</a>	Use the <b>Delete list</b> action to delete a list from your SharePoint site.
<a href="#">SharePoint get list Action</a>	Use the <b>Get list</b> action to retrieve the list details from your SharePoint site.
<a href="#">SharePoint update list Action</a>	Use the <b>Update list</b> action to update a list name in your SharePoint site.
<a href="#">SharePoint create list item Action</a>	Use the <b>Create list item</b> action to create a list item within a list in your SharePoint site.
<a href="#">SharePoint delete list item Action</a>	Use the <b>Delete list item</b> action to delete a list item from a list in your SharePoint site.
<a href="#">SharePoint get list item Action</a>	Use the <b>Get list item</b> action to retrieve the list item details from a list in your SharePoint site.
<a href="#">SharePoint update list item Action</a>	Use the <b>Update list item</b> action to update a list item value within a list in your SharePoint site.
<a href="#">SharePoint upload list image Action</a>	Use the <b>Upload list image</b> action to upload an image file to a list item in your SharePoint site.
<a href="#">SharePoint delete list attachment Action</a>	Use the <b>Delete list attachment</b> action to delete an attachment from a list item in your SharePoint site.
<a href="#">SharePoint download list attachment Action</a>	Use the <b>Download list attachment</b> action to download an attachment from a list item in your SharePoint site.
<a href="#">SharePoint upload list attachment Action</a>	Use the <b>Upload list attachment</b> action to upload an attachment to a list item in your SharePoint site.

## SharePoint create list action

Use the **Create list** action to create a new list in your SharePoint site.

**Note:** The examples and graphics provided on this page are for representation purposes only and may not accurately reflect your specific instance. We do not assume responsibility for their maintenance or accuracy.

- Ensure that you are authenticated before initiating any SharePoint action. For more details, see [SharePoint authenticate action](#) on page 3038.
- You must create a SharePoint site to store the list. For more details, see [Create new app in SharePoint](#).

1. From the **Actions** pane, select **SharePoint > List and list items > Create list** and place it in the canvas.

**SharePoint: Create list**

Creates a list with template selected

Required bot agent version: 21.250 or above

Site

2 Default site Other site

List name

3 Task\_List

Template

4 Genericlist

Description (optional)

5 A list of items for documents

Session

Session name Variable

6 Default

The name you gave the session when you opened it.

List ID (optional)

7 List\_ID

2. In the **Site** field, select one of the following options:
  - **Default site:** The site name used during authentication is considered the default site.

- **Other site:** If you want to choose a different site to create a folder, specify the different site name.
3. In the **List name** field, specify a name for the new list.
  4. In the **Template** field, select a template from the drop-down list. For more information, see [SharePoint templates](#).
  5. In the **Description** field, provide a description for the list.
  6. In the **Session** field, select one of the following options:
    - **Session name:** The name you provided for the session during authentication.
    - **Variable:** Select a variable which contains the session name.
  7. In the **List ID** field, select a variable to store the created list ID.

A new list is created in SharePoint.

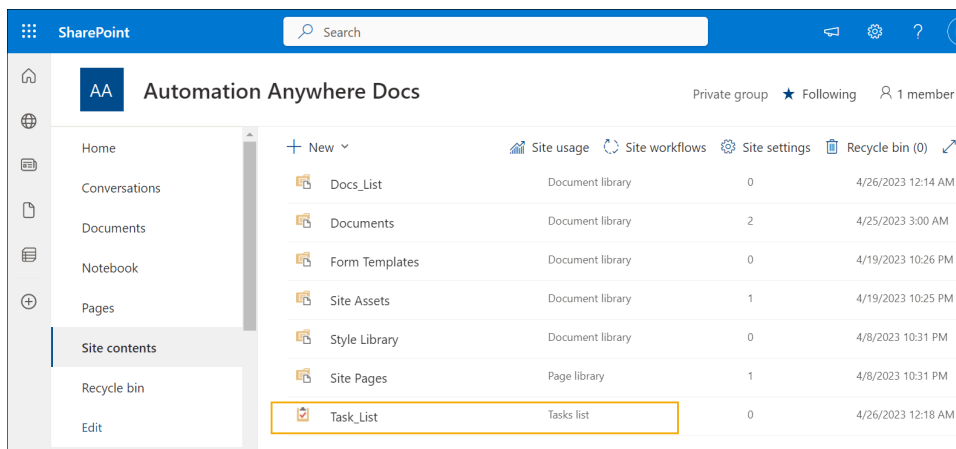

## SharePoint delete list action

Use the **Delete list** action to delete a list from your SharePoint site.

Ensure that you are authenticated before initiating any SharePoint action. For more details, see [SharePoint authenticate action](#) on page 3038.

1. From the **Actions** pane, select **SharePoint > List and list item > Delete list** and place it in the canvas.
2. In the **Site** field, select one of the following options:
  - **Default site:** The site name used during authentication is considered the default site.
  - **Other site:** If you want to choose a different site, specify the different site name.
3. In the **List name** field, specify the list name you want to delete.
4. In the **Session** field, select one of the following options:
  - **Session name:** The name you provided for the session during authentication.
  - **Variable:** Select a variable which contains the session name.

The specified list is deleted.



## SharePoint get list action

Use the **Get list** action to retrieve the list details from your SharePoint site.

Ensure that you are authenticated before initiating any SharePoint action. For more details, see [SharePoint authenticate action](#) on page 3038.

1. From the **Actions** pane, select **SharePoint > List and list items > Get list** and place it in the canvas.

**SharePoint: Get list(s)**

Get list(s) using filters

Required bot agent version: 21.250 or above

**Site**

2 Default site Other site

**Filter**

3 Name

List name (optional)

Test\_list (x)

**Session**

Session name Variable

4 Default (x)

The name you gave the session when you opened it.

**Matched records**

5 \* ListItem (x)₊

2. In the **Site** field, select one of the following options:
  - **Default site:** The site name used during authentication is considered the default site.
  - **Other site:** If you want to choose a different site, specify the different site name.
3. In the **Filter** field, select one of the following options:
  - **All lists:** Retrieve details of all the lists in your SharePoint site.
  - **ID:** Specify the list ID to retrieve details of this specific list.
  - **Name:** Specify a list name to retrieve details of this specific list.
4. In the **Session** field, select one of the following options:
  - **Session name:** The name you provided for the session during authentication.
  - **Variable:** Select a variable which contains the session name.

5. In the **Matched records** field, select a variable to store the list details.

The specified list details are retrieved and stored in the variable.

**Note:** The output is retrieved as a list of type `List`. To read an individual record (row) in this list, you need to loop through all the dictionary items using the `Loop` action and read or extract the records (rows) individually. For example, the output of `get multiple records` is saved in the variable `list_of_records_any`. If the variable contains five records, then each record is passed to the `Loop` action to be processed one at a

The screenshot shows an automation workflow with the following steps:

1. ServiceNow: Authentication Start a "Default" session on \$PDI\_url\$
2. ServiceNow: Get Multiple Records Get a list of "incident" records using filter type (N
3. Loop : For each item in the list
4. Dictionary: Get value of the key "number" from \$ListItem\$
5. Dictionary: Get value of the key "severity" from \$ListItem\$
6. Dictionary: Get value of the key "short\_description" from \$ListItem\$
7. Message box "Record: \$O\_inc\_number\$, \$O\_severity\$, \$O\_descri
8. ServiceNow: Revoke Authentication End the "Default" session

An orange arrow points from the "Matched records" field in step 2 to the "View variable" dialog box. The dialog box shows the following details:

Type	Subtype
List	Any
Name	Description
list_of_records_any	An ordered group of items
Use as input	No
Use as output	No
Constant (read-only)	No
Default value (optional)	This list is empty

time.

## SharePoint update list action

Use the **Update list** action to update a list name in your SharePoint site.

Ensure that you are authenticated before initiating any SharePoint action. For more details, see [SharePoint authenticate action](#) on page 3038.

1. From the **Actions** pane, select **SharePoint > List and list items > Update list** and place it in the canvas.
2. In the **Site** field, select one of the following options:
  - **Default site:** The site name used during authentication is considered the default site.
  - **Other site:** If you want to choose a different site, specify the different site name.
3. In the **Current list name** field, specify the existing name for the list.
4. In the **New list name** field, specify a new name for the list.
5. In the **Description** field, add a description for the list.
6. In the **Session** field, select one of the following options:
  - **Session name:** The name you provided for the session during authentication.
  - **Variable:** Select a variable which contains the session name.

The list is updated with the specified new name.

## SharePoint create list item action

Use the **Create list item** action to create a list item within a list in your SharePoint site.

- Ensure that you are authenticated before initiating any SharePoint action. For more details, see [SharePoint authenticate action](#) on page 3038.

- You must create a list in your SharePoint site. For more details, see [SharePoint create list action](#) on page 3055.
- From the **Actions** pane, select **SharePoint > List and list items > Create list item** and place it in the canvas.

### SharePoint: Create list item

Adds list item to a list

Required bot agent version: 21.250 or above

**2** Use SharePoint discovery assistant

Site

**3** Default site Other site

List name/List Id

**4** Task\_List (x)

Columns (3) (optional)

<b>5</b> Column name	Type	Value	
Title	Text	--	⋮
Predecessors	Lookup	--	⋮
Priority	Choice	(2) Normal	⋮

Add entry

Session

Session name Variable

**6** Default (x)

The name you gave the session when you opened it.

---

List item ID (optional)

**7** ListItem (x)

- Click **Use SharePoint discovery assistant** to connect to your SharePoint domain and automatically retrieve the lists. Enter the SharePoint domain credentials to connect and select a list from the populated lists.

Connect to SharePoint Cancel Connect

Domain  
 Cloud  Custom/on premises

Subdomain  
 automationanywherestore  
https://(subdomain).sharepoint.com

Site name (optional)  
 AutomationAnywhereDocs

Client ID  
 Insecure string

Client secret  
 Insecure string

Tenant ID  
 Insecure string

Select a list Cancel Select

Lists

- Converted Forms
- Docs\_List
- Documents
- Form Templates
- List Template Gallery
- Master Page Gallery
- Site Assets
- Site Pages
- Solution Gallery
- Style Library
- Task\_List**
- Taxonomy/HiddenList
- Theme Gallery
- User Information List

Columns

Column Name	Type	Default Value
Title	Text	
Predecessors	Lookup	
Priority	Choice	(2) Normal
Status	Choice	Not Started
% Complete	Number	
Assigned To	User	
Task Group	User	
Description	Note	
Start Date	DateTime	[today]
Due Date	DateTime	

- In the **Site** field, select one of the following options:
  - Default site:** The site name used during authentication is considered the default site.
  - Other site:** If you want to choose a different site, specify the different site name.
- In the **List name/List Id** field, specify a list name or list ID. If you have used SharePoint discovery to connect and select a list, the list name is automatically displayed. You must manually input the list ID or pick a variable that contains the list ID.
- In the **Columns** field, click **Add entry** to manually add the column name and value pairs to create a list item. If you used SharePoint discovery to connect and select a list, then the list items are automatically populated.
- In the **Session** field, select one of the following options:
  - Session name:** The name you provided for the session during authentication.
  - Variable:** Select a variable which contains the session name.
- In the **List item ID** field, select a variable to store the list item ID after the list item is created.

The list item is successfully created in the specified SharePoint list.

## SharePoint delete list item action

Use the **Delete list item** action to delete a list item from a list in your SharePoint site.

Ensure that you are authenticated before initiating any SharePoint action. For more details, see [SharePoint authenticate action](#) on page 3038.

1. From the **Actions** pane, select **SharePoint > List and list item > Delete list item** and place it in the canvas.
2. In the **Site** field, select one of the following options:
  - **Default site:** The site name used during authentication is considered the default site.
  - **Other site:** If you want to choose a different site, specify the different site name.
3. In the **List name** field, specify the list name.
4. In the **List item ID** field, specify the ID of the list item.
5. In the **Delete image** field, select if an image that is attached to the list item must be deleted or not.
6. In the **Session** field, select one of the following options:
  - **Session name:** The name you provided for the session during authentication.
  - **Variable:** Select a variable which contains the session name.

The specified list item is deleted.

## SharePoint get list item action

Use the **Get list item** action to retrieve the list item details from a list in your SharePoint site.

Ensure that you are authenticated before initiating any SharePoint action. For more details, see [SharePoint authenticate action](#) on page 3038.

1. From the **Actions** pane, select **SharePoint > List and list items > Get list item** and place it in the canvas.

**SharePoint: Get list item(s)** 

Get list item(s) using filters  
Required bot agent version: 21.250 or above

Site

2  Default site  Other site

List name

3  

Filter

4  

5 Download file item(s)

No  
 Yes

Destination folder



6 Download image column(s)

No  
 Yes

Destination folder





Session

7  Session name  Variable



The name you gave the session when you opened it.

8 Matched records

2. In the **Site** field, select one of the following options:

- **Default site:** The site name used during authentication is considered the default site.
  - **Other site:** If you want to choose a different site, specify the different site name.
3. In the **List name** field, specify the list name.
  4. In the **Filter** field, choose one of the following options:
    - **All list items:** Retrieve details of all the list items in the SharePoint list.
    - **List item ID:** Specify the list item ID to retrieve details of this specific list item.
    - **List item title:** Specify a list item title to retrieve details of this specific list item that contains the title.
  5. In the **Download image(s)** field, select one of the following options:
    - **No:** Select this option if you do not want to download the image attached to the list item.
    - **Yes:** Select this option and specify a destination folder path to download the image attached to the list item.
  6. In the **Session** field, select one of the following options:
    - **Session name:** The name you provided for the session during authentication.
    - **Variable:** Select a variable which contains the session name.
  7. In the **Matched records** field, select a variable to store the list item details.

The specified list item details are retrieved and stored in the variable.

**Note:** The output is retrieved as a list of type . To read an individual record (row) in this list, you need to loop through all the dictionary items using the action and read or extract the records (rows) individually. For example, the output of get multiple records is saved in the variable list\_of\_records\_any. If the variable contains five records, then each record is passed to the Loop action to be processed one at a

The screenshot displays an automation workflow with the following steps:

1. ServiceNow: Authentication Start a "Default" session on \$PDI\_url\$
2. ServiceNow: Get Multiple Records Get a list of "incident" records using filter type (N
3. Loop : For each item in the list
4. Dictionary: Get value of the key "number" from \$ListItem\$
5. Dictionary: Get value of the key "severity" from \$ListItem\$
6. Dictionary: Get value of the key "short\_description" from \$ListItem\$
7. Message box "Record: \$O\_inc\_number\$, \$O\_severity\$, \$O\_descri
8. ServiceNow: Revoke Authentication End the "Default" session

The 'View variable' dialog box shows the following details:

Type	Subtype
List	* Any
Name	list_of_records_any
Description	An ordered group of items
Use as input	No
Use as output	No
Constant (read-only)	No
Default value (optional)	This list is empty

time.

## SharePoint update list item action

Use the **Update list item** action to update a list item value within a list in your SharePoint site.

Ensure that you are authenticated before initiating any SharePoint action. For more details, see [SharePoint authenticate action](#) on page 3038.

1. From the **Actions** pane, select **SharePoint > List and list items > Update list item** and place it in the canvas.

**SharePoint: Update list item**

Update list item of a list  
Required bot agent version: 21.250 or above

**2 Use SharePoint discovery assistant**

Site  
**3** Default site Other site

List name  
**4** Task\_List (x)

List item ID  
**5** \$ListItem\$ (x)

Columns (10) (optional)

<b>6</b> Column name	Type	Value	
Title	Text	--	⋮
Predecessors	Lookup	--	⋮
Priority	Choice	(2) Normal	⋮
Status	Choice	Not Started	⋮
PercentComplete	Number	--	⋮
AssignedTo	User	--	⋮
TaskGroup	User	--	⋮
Body	Note	--	⋮
StartDate	DateTime	[today]	⋮
DueDate	DateTime	--	⋮

Add entry

Session  
Session name Variable

**7** Default (x)  
The name you gave the session when you opened it.

2. Click **Use SharePoint discovery assistant** to connect to your SharePoint domain and automatically retrieve the lists. Enter the SharePoint domain credentials to connect and select a list from the populated lists.



**Connect to SharePoint** [Cancel] [Connect]

Domain  
 Cloud  Custom/on premises

Subdomain  
 automationanywherestore  
https://(subdomain).sharepoint.com

Site name (optional)  
 AutomationAnywhereDocs

Client ID  
 Credential  Insecure string

Client secret  
 Credential  Insecure string

Tenant ID  
 Credential  Insecure string

---

**Select a list** [Cancel] [Select]

**Lists**

- Converted Forms
- Docs\_List
- Documents
- Form Templates
- List Template Gallery
- Master Page Gallery
- Site Assets
- Site Pages
- Solution Gallery
- Style Library
- Task\_List**
- Taxonomy/HiddenList
- Theme Gallery
- User Information List

**Columns**

Column Name	Type	Default Value
Title	Text	
Predecessors	Lookup	
Priority	Choice	(2) Normal
<b>Status</b>	<b>Choice</b>	<b>Not Started</b>
% Complete	Number	
Assigned To	User	
Task Group	User	
Description	Note	
Start Date	DateTime	[today]
Due Date	DateTime	

- In the **Site** field, select one of the following options:
  - Default site:** The site name used during authentication is considered the default site.
  - Other site:** If you want to choose a different site, specify the different site name.
- In the **List name** field, specify a list name. If you have used SharePoint discovery assistant to connect and select a list, the list name is automatically displayed.
- In the **List item ID** field, specify a list item ID or select a variable that contains the list item ID.

---

**Note:** You can update only one list item at a time. Even if you use the SharePoint discovery assistant to populate the list items in the table, you must provide the individual list item ID to update the values.

- In the **Columns** field, click **Add entry** to manually add the column name and value pairs to create a list item. If you have used SharePoint discovery assistant to connect and select a list, then the list items are automatically populated.
- In the **Session** field, select one of the following options:
  - Session name:** The name you provided for the session during authentication.

- **Variable:** Select a variable which contains the session name.

The list item is successfully updated with the values in the specified SharePoint list.

## SharePoint upload list image action

Use the **Upload list image** action to upload an image file to a list item in your SharePoint site.

Ensure that you are authenticated before initiating any SharePoint action. For more details, see [SharePoint authenticate action](#) on page 3038.

1. From the **Actions** pane, select **SharePoint > List and list items > Upload list image** and place it in the canvas.

### SharePoint: Upload list image

Upload image file to a list item

Required bot agent version: 21.250 or above

Site

2 Default site Other site

List name

3 🗨 Tast\_List 🟢 (x)

List item ID

4 # \$ListItem\$ 🟢 (x)

Image file

5 Control Room file Desktop file Variable

🗨 herePictures aa-homepage.png\ 🟢 (x) Browse...

Column name

6 🗨 Image\_Field 🟢 (x)

Session

Session name Variable

7 🗨 Default 🟢 (x)

The name you gave the session when you opened it.

2. In the **Site** field, select one of the following options:
  - **Default site:** The site name used during authentication is considered the default site.

- **Other site:** If you want to choose a different site, specify the different site name.
3. In the **List name** field, specify a list name or select a variable that contains the list name.
  4. In the **List item ID** field, specify a list item ID or select a variable that contains the list item ID.
  5. In the **Image file** field, select one of the following options:
    - **Control Room file:** Choose an image file that is available in the Control Room.
    - **Desktop file:** Browse and select an image file from your local system.
    - **Variable:** Insert a variable that contains the image file path.
  6. In the **Column name** field, specify the column name where the image must be uploaded. Or, select a variable that contains the column name.

---

**Note:** You must upload an image only in the **Image** column type. The **Column name** is the name you have defined while creating the column.

---

7. In the **Session** field, select one of the following options:
  - **Session name:** The name you provided for the session during authentication.
  - **Variable:** Select a variable which contains the session name.

The list image is successfully uploaded to the specified column in your SharePoint list.

## SharePoint delete list attachment action

Use the **Delete list attachment** action to delete an attachment from a list item in your SharePoint site.

Ensure that you are authenticated before initiating any SharePoint action. For more details, see [SharePoint authenticate action](#) on page 3038.

1. From the **Actions** pane, select **SharePoint > List and list items > Delete list attachment** and place it in the canvas.
2. In the **Site** field, select one of the following options:
  - **Default site:** The site name used during authentication is considered the default site.
  - **Other site:** If you want to choose a different site, specify the different site name.
3. In the **List name** field, specify a list name or select a variable that contains the list name.
4. In the **List item ID** field, specify a list item ID or select a variable that contains the list item ID.
5. In the **Attachment name** field, specify the attachment name or select a variable that contains the attachment name.
6. In the **Session** field, select one of the following options:
  - **Session name:** The name you provided for the session during authentication.
  - **Variable:** Select a variable which contains the session name.

The attachment is successfully deleted from the specified list in your SharePoint site.

## SharePoint download list attachment action

Use the **Download list attachment** action to download an attachment from a list item in your SharePoint site.

Ensure that you are authenticated before initiating any SharePoint action. For more details, see [SharePoint authenticate action](#) on page 3038.

1. From the **Actions** pane, select **SharePoint > List and list items > Download list attachment** and place it in the canvas.
2. In the **Site** field, select one of the following options:
  - **Default site:** The site name used during authentication is considered the default site.
  - **Other site:** If you want to choose a different site, specify the different site name.
3. In the **List name** field, specify a list name or select a variable that contains the list name.
4. In the **List item ID** field, specify a list item ID or select a variable that contains the list item ID.
5. In the **Destination folder** field, specify the folder path where you want to download the attachment.
6. In the **Session** field, select one of the following options:
  - **Session name:** The name you provided for the session during authentication.
  - **Variable:** Select a variable which contains the session name.

The attachment is successfully downloaded from the specified list in your SharePoint site.

### SharePoint upload list attachment action

Use the **Upload list attachment** action to upload an attachment to a list item in your SharePoint site.

Ensure that you are authenticated before initiating any SharePoint action. For more details, see [SharePoint authenticate action](#) on page 3038.

1. From the **Actions** pane, select **SharePoint > List and list items > Upload list attachment** and place it in the canvas.

## SharePoint: Upload list attachment

Upload list attachment to a list item

Required bot agent version: 21.250 or above

**Site**

2  Default site  Other site

**List name**

3

**List item ID**

4

**Attachment file**

5  Control Room file  Desktop file  Variable

**Session**

Session name  Variable

6

The name you gave the session when you opened it.

2. In the **Site** field, select one of the following options:
  - **Default site:** The site name used during authentication is considered the default site.
  - **Other site:** If you want to choose a different site, specify the different site name.
3. In the **List name** field, specify a list name or select a variable that contains the list name.
4. In the **List item ID** field, specify a list item ID or select a variable that contains the list item ID.
5. In the **Attachment file** field, select one of the following options:
  - **Control Room file:** Choose an attachment file that is available in the Control Room.
  - **Desktop file:** Browse and select an attachment file from your local system.
  - **Variable:** Insert a variable that contains the attachment file path.

6. In the **Session** field, select one of the following options:
- **Session name**: The name you provided for the session during authentication.
  - **Variable**: Select a variable which contains the session name.

The attachment is successfully uploaded to the specified list in your SharePoint list.

## Simulate keystrokes package

Use the Simulate keystrokes package to simulate keystrokes in Chinese (simplified and traditional), English, French, German, Japanese, Korean, Italian, or Spanish characters.

### Automation 360 extension setting

If the bot execution takes longer when you use the Simulate keystrokes package to simulate keystrokes in a static page running on the Google Chrome or Microsoft Edge browser, then follow these steps to enable the setting in the Automation 360 extension:

- Click the extensions icon at the top right corner of the browser window.
- Click the vertical ellipses next to the plugin and select **Manage extension**.
- Enable the **Allow access to file URLs** option.
- Restart the browser and run the .

### Action in the Simulate keystrokes package

The Simulate keystrokes package includes the following action:

Action	Description
Keystrokes	See <a href="#">Using Keystrokes action</a> on page 3070.

#### Related tasks

[Build a basic bot that uses a desktop application](#) on page 3199

Build a bot that uses a conditional statement to verify that the calculator is open, then uses the calculator to multiply two numbers. This example uses actions from the Application, If, Simulate keystrokes, Message Box, and Window packages.

#### Related reference

[Simulate keystrokes package updates](#) on page 955

Review the updates in released versions of the Simulate keystrokes package such as new and enhanced features as well as fixes and limitations. The page also lists the release dates of each version, and the compatible Control Room and Bot Agent versions.

## Using Keystrokes action

Use the **Keystrokes** action to simulate keystrokes.

Follow these steps to add a **Keystrokes** action:

1. In the Actions palette, double-click or drag the **Keystrokes** action from the **Keystrokes** package.
2. Specify the window in which to capture an object.  
Choose from the **Application**, **Browser**, or **Variable** tab.

Option	Description
Application	Select from a list of currently active windows. This option shows a list of all the application and browser windows that are open on the Bot Creator device.
Browser	Select from a list of supported browser tabs.  <b>Note:</b> This option supports , Chromium-based , and browsers. For all other browsers, use the <b>Application</b> option.
Variable	Select an existing window variable to specify the title of the application window title.

Insert a wildcard character (\*) in the **Window title** field to search for window titles that can change. You can specify one or more wildcards (\*) at the start, middle, or end of the value. For example, to perform an operation on any window that has `Microsoft` in the title, use a wildcard to indicate any string by adding it before or after the value: `*Microsoft*`. The first searches for the exact window title (`Microsoft`), and if it does not find a match, it searches for windows with the term `Microsoft` anywhere in the title.

You can use a regular expression (regex) to identify a window title. Select the regular expression condition as either **String** or **Pattern** and then enter the value. By default, the **Window title** field is case-sensitive.

To identify a browser title, you can enable the **Case sensitive** option to match the letter case, or disable the option to identify a window title where the letter case does not match.

---

**Note:** Ensure that the minimum version installed on your system is the version that was released with v.26. If you have a version released with v.25 or earlier, then by default, the window title will be identified only with matching letter case (case-sensitive).

---

For example, you can enter the **String** value as `((\w*)-Notepad)` for all window title names starting with `((\w*)-Notepad)`, or use **Pattern** value as `((\w)\s)*document-Notepad` for only those window titles that match this pattern.

---

**Note:**

- When you use a regular expression of type **String** with `-title` as the input value for a window title in any , the might encounter a run time error. To prevent the run time error, ensure that when you add the string input as `*-title`, the application with the specific title is open. The asterisk (\*) is just a character, not a wild card character.
- When you use a regular expression of type **Pattern** with `-title` as the input value for a window title in any , the might encounter a run time error because the input value `*-title` is incorrect.

Ensure that you use valid regex patterns.

---

3. Optional: Select the **Resize window** option to specify the window dimensions.
-

This option delivers a more reliable bot. It resizes the window to the dimensions at which the task was recorded, which enhances the ability of the bot to identify the target object.

- If the window is maximized when you record the task, this option is not selected.
- If the window is not at the maximum size when you record the task, this option is selected, by default, and the width and height fields are automatically filled with the dimensions of the window.

---

**Note:** This option is available only for windows that can be resized. It is not available for the **Desktop** or **Taskbar** options.

---

4. In the **Keystrokes**, select a radio button:

- **Enter keystrokes here or use the on-screen keyboard:** Type or use the keyboard to enter keystrokes.
- **Select a credential:** Uses a password stored in the Credential Vault.

---

**Note:** A new key named **Return** has been added to the virtual keyboard to replace the Enter functionality and the Enter key in the Number pad has been renamed to **Num Enter**. As a result, the Return key is the main Enter key on the keyboard.

---

5. Optional: : In the **Delay between each keystroke in ms** field, the delay time.

---

**Note:** The default is set to 10 milliseconds.

---

6. Click **Save**.

## SNMP package

The SNMP package allows you to automate network management tasks, such as retrieving and modifying data, and sending notification messages.

Simple Network Management Protocol (SNMP) is used to find the network management component on one or more computers and the managed component on multiple network devices.

The Automation Anywhere SNMP action offers powerful network management. Using this action, users can easily monitor network devices configured with SNMP agent software. Network devices such as servers, workstations, printers, routers, bridges, and hubs, as well as services such as Dynamic Host Configuration Protocol (DHCP) or Windows Internet Name Service (WINS) can be monitored.

### Actions in the SNMP package

The SNMP package includes the following actions:

Action	Description
Get	See <a href="#">Get action</a> on page 3073
Get next	See <a href="#">Get next action</a> on page 3075
Send trap	See <a href="#">Send trap action</a> on page 3077



Action	Description
Set	See <a href="#">Set action</a> on page 3079
Walk	See <a href="#">Set action</a> on page 3079

Related reference

[Active Directory package](#) on page 2374

Use the [Active Directory](#) package to automate actions in the Active Directory. An Active Directory is a directory service provided by Microsoft to assist the admin in managing users across a group or organization.

[Printer package](#) on page 2891

Use the actions in the [Printer](#) package to automate retrieving and setting the default printer and removing a printer from the list of available printers.

[SNMP package updates](#) on page 957

Review the updates in released versions of the [SNMP](#) package such as new and enhanced features as well as fixes and limitations. The page also lists the release dates of each version, and the compatible Control Room and Bot Agent versions.

## Get action

Use the **Get** action in the [SNMP](#) package to retrieve data of an object that is managed by SNMP agent.

1. In the [Actions](#) palette, double-click or drag the **Get** action from the [SNMP](#) package.
2. In the **Agent** field, enter details of the device on which the SNMP agent is available.
3. Click the **SNMP Version** drop-down menu to select one of the following options to specify the SNMP version that must be used:

Option	Action
V1	Specify the community string you want to use in the <b>Community</b> field.
V2C	Specify the community string you want to use in the <b>Community</b> field.

Option	Action
V3	<p>Specify the community string you want to use in the <b>Community</b> field.</p> <p>Click the <b>Authentication level</b> drop-down menu to specify one of the following level of authentication:</p> <ul style="list-style-type: none"> <li>• <b>None</b>: Authentication will not be used.</li> <li>• <b>Authentication Only</b>: Enables you to use authentication only.                             <ul style="list-style-type: none"> <li>a) Select <b>MD5</b> or <b>SHA</b> from the <b>Authentication method</b> list to specify the authentication method you want to use.</li> <li>b) In the <b>Password</b> field, click one of the following tabs:                                     <ul style="list-style-type: none"> <li>• <b>Credential</b>: To use a value from the Credential Vault. (Optional) Click <b>Pick</b> to choose a credential.</li> <li>• <b>Variable</b>: To use a credential variable.</li> <li>• <b>Insecure string</b>: To manually specify the value you want to use.</li> </ul> </li> </ul> </li> <li>• <b>Authentication and privacy</b>: Enables you to use authentication and privacy.                             <ul style="list-style-type: none"> <li>a) Select <b>MD5</b> or <b>SHA</b> from the <b>Authentication method</b> list to specify the authentication method you want to use.</li> <li>b) In the <b>Password</b> field, click one of the following tabs:                                     <ul style="list-style-type: none"> <li>• <b>Credential</b>: To use a value from the Credential Vault. (Optional) Click <b>Pick</b> to choose a credential.</li> <li>• <b>Variable</b>: To use a credential variable.</li> <li>• <b>Insecure string</b>: To manually specify the value you want to use.</li> </ul> </li> <li>c) Click <b>Privacy method</b> drop-down menu and select <b>DES</b> or <b>AES</b> to specify the privacy method you want to use.</li> <li>d) In the <b>Private key</b> field, click one of the following tabs:                                     <ul style="list-style-type: none"> <li>• <b>Credential</b>: To use a value from the Credential Vault. (Optional) Click <b>Pick</b> to choose a credential.</li> <li>• <b>Variable</b>: To use a credential variable.</li> <li>• <b>Insecure string</b>: To manually specify the value you want to use.</li> </ul> </li> </ul> </li> </ul>

4. In the **Object ID** field, specify the ID of the object for which you want to retrieve details.
5. Use the **Data type** field to select one of the following options to specify the format in which you want to retrieve details of the object:
  - **ASCII**
  - **Hex**
6. Click the **SNMP advanced options** drop-down menu and enter the values in the following fields:
  - **Timeout(ms)**: Specify the time (in milliseconds) for the action to wait before generating an error.
  - **Remote port**: Specify the port number of the remote device.
  - **Retries**: Specify the maximum number of times the action must try to retrieve the details.
7. In the **Log file** field, click one of the following tabs:
  - **Control Room file**: To select a file that is available on the Control Room to store the result.  
Click **Choose** to select a file.
  - **Desktop file**: To select a file that is available on a device to store the result.  
Click **Browse** to locate and select a file.
  - **Variable**: To select a variable by specifying the file location that you want to use to store the result.
8. Select a string variable from the **Assigned to** list.
9. Click **Save**.

## Get next action

Use the **Get next** action in the SNMP package to retrieve data of the next object that is managed by an SNMP agent.

1. In the **Actions** palette, double-click or drag the **Get next** action from the SNMP package.
2. In the **Agent** field, enter details of the device on which the SNMP agent is available.
3. Click the **SNMP Version** drop-down menu to select one of the following options to specify the SNMP version that must be used:

Option	Action
V1	Specify the community string you want to use in the <b>Community</b> field.
V2C	Specify the community string you want to use in the <b>Community</b> field.

Option	Action
V3	<p>Specify the community string you want to use in the <b>Community</b> field.</p> <p>Click the <b>Authentication level</b> drop-down menu to specify one of the following level of authentication:</p> <ul style="list-style-type: none"> <li>• <b>None</b>: Authentication will not be used.</li> <li>• <b>Authentication Only</b>: Enables you to use authentication only. <ul style="list-style-type: none"> <li>a) Select <b>MD5</b> or <b>SHA</b> from the <b>Authentication method</b> list to specify the authentication method you want to use.</li> <li>b) In the <b>Password</b> field, click one of the following tabs: <ul style="list-style-type: none"> <li>• <b>Credential</b>: To use a value from the Credential Vault. (Optional) Click <b>Pick</b> to choose a credential.</li> <li>• <b>Variable</b>: To use a credential variable.</li> <li>• <b>Insecure string</b>: To manually specify the value you want to use.</li> </ul> </li> </ul> </li> <li>• <b>Authentication and privacy</b>: Enables you to use authentication and privacy. <ul style="list-style-type: none"> <li>a) Select <b>MD5</b> or <b>SHA</b> from the <b>Authentication method</b> list to specify the authentication method you want to use.</li> <li>b) In the <b>Password</b> field, click one of the following tabs: <ul style="list-style-type: none"> <li>• <b>Credential</b>: To use a value from the Credential Vault. (Optional) Click <b>Pick</b> to choose a credential.</li> <li>• <b>Variable</b>: To use a credential variable.</li> <li>• <b>Insecure string</b>: To manually specify the value you want to use.</li> </ul> </li> <li>c) Click <b>Privacy method</b> drop-down menu and select <b>DES</b> or <b>AES</b> to specify the privacy method you want to use.</li> <li>d) In the <b>Private key</b> field, click one of the following tabs: <ul style="list-style-type: none"> <li>• <b>Credential</b>: To use a value from the Credential Vault. (Optional) Click <b>Pick</b> to choose a credential.</li> <li>• <b>Variable</b>: To use a credential variable.</li> <li>• <b>Insecure string</b>: To manually specify the value you want to use.</li> </ul> </li> </ul> </li> </ul>

4. In the **Object ID** field, specify the ID of the object for which you want to retrieve details.
5. Use the **Data type** field to select one of the following options to specify the format in which you want to retrieve details of the object:
  - **ASCII**
  - **Hex**
6. Click the **SNMP advanced options** drop-down menu and enter the values in the following fields:
  - **Timeout(ms)**: Specify the time (in milliseconds) for the action to wait before generating an error.
  - **Remote port**: Specify the port number of the remote device.
  - **Retries**: Specify the maximum number of times the action must try to retrieve the details.
7. In the **Log file** field, click one of the following tabs:
  - **Control Room file**: To select a file that is available on the Control Room to store the result.  
Click **Choose** to select a file.
  - **Desktop file**: To select a file that is available on a device to store the result.  
Click **Browse** to locate and select a file.
  - **Variable**: To select a variable by specifying the file location that you want to use to store the result.
8. Select a string variable from the **Assigned to** list.
9. Click **Save**.

## Send trap action

Use the **Send trap** action in the SNMP package to send messages to the SNMP manager from an SNMP agent. These messages are sent by an SNMP agent whenever certain events occur, such as a system restart.

1. In the **Actions** palette, double-click or drag the **Send trap** action from the SNMP package.
2. In the **Agent** field, enter details of the device on which the SNMP agent is available.
3. Click the **SNMP Version** drop-down menu to select one of the following options to specify the SNMP version that must be used:

Option	Action
V1	Specify the community string you want to use in the <b>Community</b> field.
V2C	Specify the community string you want to use in the <b>Community</b> field.

Option	Action
V3	<p>Specify the community string you want to use in the <b>Community</b> field.</p> <p>Click the <b>Authentication level</b> drop-down menu to specify one of the following level of authentication:</p> <ul style="list-style-type: none"> <li>• <b>None</b>: Authentication will not be used.</li> <li>• <b>Authentication Only</b>: Enables you to use authentication only.                             <ul style="list-style-type: none"> <li>a) Select <b>MD5</b> or <b>SHA</b> from the <b>Authentication method</b> list to specify the authentication method you want to use.</li> <li>b) In the <b>Password</b> field, click one of the following tabs:                                     <ul style="list-style-type: none"> <li>• <b>Credential</b>: To use a value from the Credential Vault. (Optional) Click <b>Pick</b> to choose a credential.</li> <li>• <b>Variable</b>: To use a credential variable.</li> <li>• <b>Insecure string</b>: To manually specify the value you want to use.</li> </ul> </li> </ul> </li> <li>• <b>Authentication and privacy</b>: Enables you to use authentication and privacy.                             <ul style="list-style-type: none"> <li>a) Select <b>MD5</b> or <b>SHA</b> from the <b>Authentication method</b> list to specify the authentication method you want to use.</li> <li>b) In the <b>Password</b> field, click one of the following tabs:                                     <ul style="list-style-type: none"> <li>• <b>Credential</b>: To use a value from the Credential Vault. (Optional) Click <b>Pick</b> to choose a credential.</li> <li>• <b>Variable</b>: To use a credential variable.</li> <li>• <b>Insecure string</b>: To manually specify the value you want to use.</li> </ul> </li> <li>c) Click <b>Privacy method</b> drop-down menu and select <b>DES</b> or <b>AES</b> to specify the privacy method you want to use.</li> <li>d) In the <b>Private key</b> field, click one of the following tabs:                                     <ul style="list-style-type: none"> <li>• <b>Credential</b>: To use a value from the Credential Vault. (Optional) Click <b>Pick</b> to choose a credential.</li> <li>• <b>Variable</b>: To use a credential variable.</li> <li>• <b>Insecure string</b>: To manually specify the value you want to use.</li> </ul> </li> </ul> </li> </ul>

4. In the **Object ID** field, specify the ID of the object for which you want to retrieve details.
5. Optional: In the **Authorative ID** field, specify the ID of the SNMP manager that will receive the notification.

---

**Important:** If you have selected **V3** from the **SNMP Version** list, you must provide a value for **Authorative ID**.

---

6. Select an option from the **Select trap type** list to specify the type of trap you want to send.
  - **Cold start:** Occurs when the SNMP agent initializes its configuration tables.
  - **Warm start:** Occurs when the SNMP agent reinitializes its configuration tables.
  - **Link down:** Occurs when the state of a network adapter on the SNMP agent changes from up to down.
  - **Link up:** Occurs when the state of a network adapter on the SNMP agent changes from down to up.
  - **Authentication fail:** Occurs when the SNMP agent receives a message from an SNMP manager with an invalid community name.
  - **EGP neighbour loss:** Occurs when the SNMP agent cannot communicate with its Exterior Gateway Protocol (EGP) peer.
  - **Enterprise specific:** Occurs when specific error conditions and error codes are defined in the system. The user provides a trap-specific number for this option.
7. Click the **SNMP advanced options** drop-down menu and enter the values in the following fields:
  - **Timeout(ms):** Specify the time (in milliseconds) for the action to wait before generating an error.
  - **Remote port:** Specify the port number of the remote device.
  - **Retries:** Specify the maximum number of times the action must try to retrieve the details.
8. In the **Log file** field, click one of the following tabs:
  - **Control Room file:** To select a file that is available on the Control Room to store the result.  
Click **Choose** to select a file.
  - **Desktop file:** To select a file that is available on a device to store the result.  
Click **Browse** to locate and select a file.
  - **Variable:** To select a variable by specifying the file location that you want to use to store the result.
9. Click **Save**.

## Set action

Use the **Set** action in the SNMP package to set a value for an object managed by the SNMP agent.

1. In the **Actions** palette, double-click or drag the **Set** action from the SNMP package.
2. In the **Agent** field, enter details of the device on which the SNMP agent is available.
3. Click the **SNMP Version** drop-down menu to select one of the following options to specify the SNMP version that must be used:

Option	Action
V1	Specify the community string you want to use in the <b>Community</b> field.
V2C	Specify the community string you want to use in the <b>Community</b> field.



Option	Action
V3	<p>Specify the community string you want to use in the <b>Community</b> field.</p> <p>Click the <b>Authentication level</b> drop-down menu to specify one of the following level of authentication:</p> <ul style="list-style-type: none"> <li>• <b>None</b>: Authentication will not be used.</li> <li>• <b>Authentication Only</b>: Enables you to use authentication only.                             <ul style="list-style-type: none"> <li>a) Select <b>MD5</b> or <b>SHA</b> from the <b>Authentication method</b> list to specify the authentication method you want to use.</li> <li>b) In the <b>Password</b> field, click one of the following tabs:                                     <ul style="list-style-type: none"> <li>• <b>Credential</b>: To use a value from the Credential Vault. (Optional) Click <b>Pick</b> to choose a credential.</li> <li>• <b>Variable</b>: To use a credential variable.</li> <li>• <b>Insecure string</b>: To manually specify the value you want to use.</li> </ul> </li> </ul> </li> <li>• <b>Authentication and privacy</b>: Enables you to use authentication and privacy.                             <ul style="list-style-type: none"> <li>a) Select <b>MD5</b> or <b>SHA</b> from the <b>Authentication method</b> list to specify the authentication method you want to use.</li> <li>b) In the <b>Password</b> field, click one of the following tabs:                                     <ul style="list-style-type: none"> <li>• <b>Credential</b>: To use a value from the Credential Vault. (Optional) Click <b>Pick</b> to choose a credential.</li> <li>• <b>Variable</b>: To use a credential variable.</li> <li>• <b>Insecure string</b>: To manually specify the value you want to use.</li> </ul> </li> <li>c) Click <b>Privacy method</b> drop-down menu and select <b>DES</b> or <b>AES</b> to specify the privacy method you want to use.</li> <li>d) In the <b>Private key</b> field, click one of the following tabs:                                     <ul style="list-style-type: none"> <li>• <b>Credential</b>: To use a value from the Credential Vault. (Optional) Click <b>Pick</b> to choose a credential.</li> <li>• <b>Variable</b>: To use a credential variable.</li> <li>• <b>Insecure string</b>: To manually specify the value you want to use.</li> </ul> </li> </ul> </li> </ul>

4. In the **Object ID** field, specify the ID of the object for which you want to retrieve details.
5. From the **Value type** list, select an option to specify the value you want to set.
  - **OctetString**
  - **Integer**
  - **Gauge**
  - **TimeTicks**
  - **IP**
  - **ObjectID**
  - **OctetByteString**
  - **OctetDecimalByteString**
  - **NULL**
6. In the **Set value** field, specify the value you want to set.
7. Click the **SNMP advanced options** drop-down menu and enter the values in the following fields:
  - **Timeout(ms)**: Specify the time (in milliseconds) for the action to wait before generating an error.
  - **Remote port**: Specify the port number of the remote device.
  - **Retries**: Specify the maximum number of times the action must try to retrieve the details.
8. In the **Log file** field, click one of the following tabs:
  - **Control Room file**: To select a file that is available on the Control Room to store the result.  
Click **Choose** to select a file.
  - **Desktop file**: To select a file that is available on a device to store the result.  
Click **Browse** to locate and select a file.
  - **Variable**: To select a variable by specifying the file location that you want to use to store the result.
9. Click **Save**.

## Walk action

Use the **Walk** action in the SNMP package to set up a collection of information about all the devices available on all the connected nodes or subtree.

1. In the **Actions** palette, double-click or drag the **Walk** action from the SNMP package.
2. In the **Agent** field, enter details of the device on which the SNMP agent is available.
3. Click the **SNMP Version** drop-down menu to select one of the following options to specify the SNMP version that must be used:

Option	Action
V1	Specify the community string you want to use in the <b>Community</b> field.
V2C	Specify the community string you want to use in the <b>Community</b> field.

Option	Action
V3	<p>Specify the community string you want to use in the <b>Community</b> field.</p> <p>Click the <b>Authentication level</b> drop-down menu to specify one of the following level of authentication:</p> <ul style="list-style-type: none"> <li>• <b>None</b>: Authentication will not be used.</li> <li>• <b>Authentication Only</b>: Enables you to use authentication only.               <ul style="list-style-type: none"> <li>a) Select <b>MD5</b> or <b>SHA</b> from the <b>Authentication method</b> list to specify the authentication method you want to use.</li> <li>b) In the <b>Password</b> field, click one of the following tabs:                   <ul style="list-style-type: none"> <li>• <b>Credential</b>: To use a value from the Credential Vault. (Optional) Click <b>Pick</b> to choose a credential.</li> <li>• <b>Variable</b>: To use a credential variable.</li> <li>• <b>Insecure string</b>: To manually specify the value you want to use.</li> </ul> </li> </ul> </li> <li>• <b>Authentication and privacy</b>: Enables you to use authentication and privacy.               <ul style="list-style-type: none"> <li>a) Select <b>MD5</b> or <b>SHA</b> from the <b>Authentication method</b> list to specify the authentication method you want to use.</li> <li>b) In the <b>Password</b> field, click one of the following tabs:                   <ul style="list-style-type: none"> <li>• <b>Credential</b>: To use a value from the Credential Vault. (Optional) Click <b>Pick</b> to choose a credential.</li> <li>• <b>Variable</b>: To use a credential variable.</li> <li>• <b>Insecure string</b>: To manually specify the value you want to use.</li> </ul> </li> <li>c) Click <b>Privacy method</b> drop-down menu and select <b>DES</b> or <b>AES</b> to specify the privacy method you want to use.</li> <li>d) In the <b>Private key</b> field, click one of the following tabs:                   <ul style="list-style-type: none"> <li>• <b>Credential</b>: To use a value from the Credential Vault. (Optional) Click <b>Pick</b> to choose a credential.</li> <li>• <b>Variable</b>: To use a credential variable.</li> <li>• <b>Insecure string</b>: To manually specify the value you want to use.</li> </ul> </li> </ul> </li> </ul>

4. In the **Object ID** field, specify the ID of the object for which you want to retrieve details.
5. Use the **Data type** field to select one of the following options to specify the format in which you want to retrieve details of the object:
  - **ASCII**
  - **Hex**
6. In the **Walk type** section, select an option to specify the scope from which to collect information.
  - **All**: Displays the variables that are equal to the specified OID for the given tree type structure.
  - **Within**: All variables in the sub-tree below the given OID are queried.
7. Click the **SNMP advanced options** drop-down menu and enter the values in the following fields:
  - **Timeout(ms)**: Specify the time (in milliseconds) for the action to wait before generating an error.
  - **Remote port**: Specify the port number of the remote device.
  - **Retries**: Specify the maximum number of times the action must try to retrieve the details.
8. In the **Log file** field, click one of the following tabs:
  - **Control Room file**: To select a file that is available on the Control Room to store the result.  
Click **Choose** to select a file.
  - **Desktop file**: To select a file that is available on a device to store the result.  
Click **Browse** to locate and select a file.
  - **Variable**: To select a variable by specifying the file location that you want to use to store the result.
9. Select a string variable from the **Assigned to** list.
10. Click **Save**.

## SOAP Web Service package

Use the **SOAP web service** action from the SOAP Web Service package to access and exchange information between two systems in XML format.

With SOAP Web Service, you can perform these actions:

- Consume SOAP web services written to provide structured data for further business processing, such as currency conversion, weather reports, and language translation.
- Connect to different existing applications and different platforms, irrespective of any underlying infrastructure requirements.

The SOAP Web Service establishes complete interoperability between clients or applications and the internet, supporting XML-based open standards, such as Web Services Description Language (WSDL), Simple Object Access Protocol (SOAP), and Universal Description Discovery and Integration (UDDI).

**Note:** Windows Authentication is currently not supported for SOAP Web Service package in Automation 360.

---

## Passing values securely

You can securely pass values from the Credential Vault to the web service by specifying the locker, credential, and attribute in the following supported action fields:

- Custom headers
- Operation parameters
- Raw data: You must select a Credential Vault value that contains the entire parameter as the value.

## Proxy support

If your device is configured with a proxy, all outbound requests from this package are routed through the proxy server. See [Connect Bot Agent to a device with a proxy](#) on page 1351.

---

**Note:** For an example task about using the SOAP Web Service action, see [Example of using the SOAP web service action](#) on page 3240.

---

### Related tasks

[Example of building a bot that uses credential variables](#) on page 2348

Securely pass values to a bot using credential variables to automate the process of logging in to a bank website.

### Related reference

[Credentials and credential variables in the Bot editor](#) on page 2344

Use credentials when building bots to pass sensitive information such as passwords and account numbers. Using credentials separates the sensitive information from the bots and Bot Runners, which reduces the risk of data spillage or unauthorized user access.

[SOAP Web Services package updates](#) on page 958

Review the updates in released versions of packages such as new and enhanced features as well as fixes and limitations. The page also lists the release dates of each version, and the compatible Control Room and Bot Agent versions.

## Step package

The `Step` package groups various actions together and runs them in a specific order. You can provide a relevant name for a step to identify the operation performed by the actions included in that step.

## Action in the Step package

The `Step` package includes the following action:

Action	Description
Step	<p>Runs a sequence of actions.</p> <ul style="list-style-type: none"> <li>Creates a container for actions without impacting the bot run.</li> <li>Configures actions within the Step action.</li> <li>Runs the arranged actions in a sequential order.</li> <li>Groups various actions for better management.</li> <li>Optional: In the <b>Title</b> field, specify the title.</li> </ul>

## String package

Use the String package to perform various operations such as comparing two strings, retrieving the string length, or converting a string to uppercase or lowercase.

### Actions in the String package

The String package includes the following actions:

Action	Description
Assign	<a href="#">Assign action</a> on page 3087
Extract text	<a href="#">Using Extract text action of String package</a> on page 3089
Compare	<a href="#">Compare action</a> on page 3092
Evaluate variable	<a href="#">Evaluate variable action</a> on page 3092
Find	<a href="#">Using Find action of String package</a> on page 3093
Length	<a href="#">Length action</a> on page 3094
Lowercase	<a href="#">Lowercase action</a> on page 3094
Generate random string	<a href="#">Generate random string action</a> on page 3094
Replace	<a href="#">Using Replace action</a> on page 3095
Reverse	<a href="#">Reverse action</a> on page 3096
Split	<a href="#">Using Split action</a> on page 3096
Substring	<a href="#">Substring action</a> on page 3099
To boolean	<a href="#">To boolean action</a> on page 3100
To locale number	<a href="#">To locale number action</a> on page 3101
To number	<a href="#">To number action</a> on page 3102

Action	Description
Trim	<a href="#">Trim action</a> on page 3104
Uppercase	<a href="#">Uppercase action</a> on page 3104

#### Related tasks

[Using Extract text action of String package](#) on page 3089

Use the **Extract text** action to extract a range of text using logical operators from the source string.

[Using Find action of String package](#) on page 3093

Use the **Find** action to find a substring within the specified string.

[Using Replace action](#) on page 3095

Use the **Replace** action to find a piece of text from the source string and replace it with another text.

[Using Split action](#) on page 3096

Use the **Split** action to split the specified string into multiple strings and store the output in a list variable.

#### Related reference

[String package updates](#) on page 960

Review the updates in released versions of the String package such as new and enhanced features as well as fixes and limitations. The page also lists the release dates of each version, and the compatible Control Room and Bot Agent versions.

## Assign action

The **Assign** action in the `String` package enables you to assign or concatenate strings.

### Settings

- Optional: In the **Select the source string variable(s)/value** field, specify the variable or values. This field holds up to 65535 alphanumeric, character, and empty values.

---

#### Note:

- To provide a string that includes a dollar sign (\$), you must enter two dollar signs. For example, if you enter `Pay $$5.00`, the output will be `Pay $5.00`.
- The values or variables that you can specify for the String package are predefined. See [Predefined variables](#) on page 2328

- 
- In the **Select the destination string variable** field, specify the variable.

### Example

Create a sample bot and perform the following steps to concatenate two strings:

1. Create a bot.

- a) On the left panel, click **Automation**.  
A list of available bots and forms is displayed.
  - b) Click **Create a bot**.
  - c) Enter the bot name: `String_assign`.
  - d) Click **Create and Edit**.
2. Create the user-defined variables using the **Create variable (+)** icon at the top of the **Variables** menu.
- a) Create a variables of String to hold the values.
  - b) In the Edit variable window, enter the **Name**, select the **Type** and enter the following values:

Name	Type	Value
var1	String	Snow
var2	String	ball

3. To concatenate two strings, from the **Actions** pane, double-click or drag the **String > Assign** action.
- a) In the **Select the source string variable(s)/ value (optional)** field, select `$var1$$var2$`.
  - b) In the **Select the destination string variable** field, click the **Create variable** icon to create a variable.
  - c) On the **Create variable** window, enter `vassign` in the **Name** field.
  - d) Click **Create and select**.
4. To print the values, double-click or drag the **Message box** action. In the **Enter the message to display** field, enter `$vassign$`.
5. Click **Save** and then **Run**.

The bot concatenates two strings and displays the output as **Snowball**.

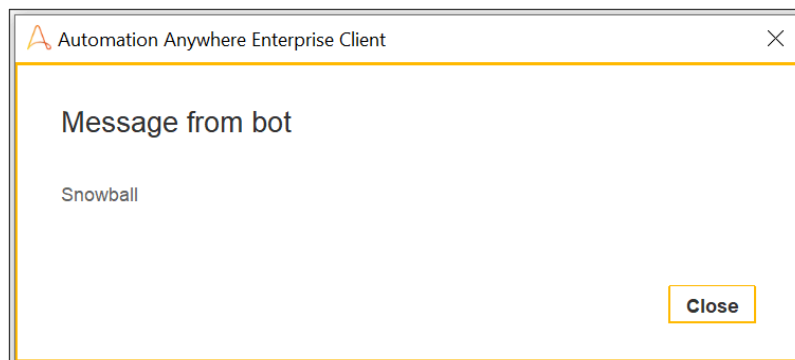



## Using Extract text action of String package

Use the **Extract text** action to extract a range of text using logical operators from the source string.

Review examples of using **Before**, **After**, and **Before and/or After** options in [Examples of using Extract text action](#) on page 3091.

To extract a substring from the specified source string, do the following:

1. In the **Actions** palette, double-click or drag the **Extract text** action from the **String** package.
2. In the **Source string** field, specify the source string.
3. Specify the text to extract by selecting from the following options:

Option	Steps
<b>Before</b>	<p>Extracts the entire text followed by the value that you have provided in the <b>Start after text</b> field.</p> <p><b>a)</b> In the <b>Start after text</b> field, enter a string to use as the starting point.</p> <p><b>b)</b> In the <b>Occurrence</b> field, enter a value to specify the number of occurrences.</p> <p>For example, if the source string is <code>This is a test string which is used to extract specific sub-string</code> and you want to extract the entire text after <code>This</code>. To extract the required text, you must enter <code>This</code> in the <b>Start after text</b> field and <code>1</code> in the <b>Occurrence</b> field. This indicates to the system to extract the text that is available after the first occurrence of <code>This</code> in the source string.</p>

Option	Steps
<b>Before and/or after</b>	<p>Extracts the text between the values provided in the <b>Start after text</b> and the <b>End before text</b> fields.</p> <p><b>a)</b> In the <b>Start after text</b> field, enter a string to use as the starting point.</p> <p><b>b)</b> In the <b>OR</b> or <b>AND</b> field, select one of the options:</p> <ul style="list-style-type: none"> <li>• <b>OR</b>: Select to extract text if either of the values specified in the <b>Start after text</b> or the <b>End before text</b> field are available in the source string.</li> <li>• <b>AND</b>: Select to extract text if both the values specified in the <b>Start after text</b> and the <b>End before text</b> fields are available in the source string.</li> </ul> <p><b>c)</b> In the <b>End before text</b> field, specify a string to use as the endpoint for extracting the text.</p> <p><b>d)</b> In the <b>Occurrence</b> field, enter a value to specify the number of occurrences of the string you have provided in the <b>End before text</b> field.</p> <p>For example, if the source string is <code>This is a test string which is used to extract specific substring and you want to extract the entire text before specific</code>. To extract the required text, you must enter <code>specific</code> in the <b>End before text</b> field and <code>1</code> in the <b>Occurrence</b> field. This indicates to the system to extract the text available before the first occurrence of <code>specific</code> in the source string.</p>
<b>After</b>	<p>Extracts the entire text preceding the value you have provided in the <b>End before text</b> field.</p> <p><b>a)</b> In the <b>End before text</b> field, specify a string to use as the endpoint for extracting the text.</p> <p><b>b)</b> In the <b>Occurrence</b> field, enter a value to specify the number of occurrences of the string you have provided in the <b>End before text</b> field.</p> <p>For example, if the source string is <code>This is a test string which is used to extract specific substring and you want to extract the entire text before specific</code>. To extract the required text, you must enter <code>specific</code> in the <b>End before text</b> field and <code>1</code> in the <b>Occurrence</b> field. This indicates to the system to extract the text available before the first occurrence of <code>specific</code> in the source string.</p>

4. In the **If no match found, return** field, select one of the options:
  - **Source String**: Return the source string.
  - **Empty (null) String**: Return the null string if no match is found.
5. In the **When extracting** field, select one of the following options:

- **Match case:** Matches the case of the text in the source string
- **Do not match case:** Does not match the case of the text in the source string

---

**Note:** By default, the **Match case** option is selected for all the new and existing bots.

---

6. In the **Number of characters to get** field, select one of the options:

- **All:** Extracts all characters from the source string.
- **Only:** Specify the exact number of characters to extract from the source string.
- **Up to:** Specify the maximum number of characters that you want to extract from the source string.

---

**Note:** This option enables you to provide a maximum limit of the characters that you want to extract. However, it is not mandatory that the source string contain the number of characters that you enter in this field.

---

For example, the source string has Date+8 as its value and you want to extract the characters after the string Date. You enter 10 in the **Up to** field, to extract 10 characters from the source string that appears after the string Date. When you run the bot, the output is +8 and it returns all the values after the string Date.

---

**Note:** The value 10 only depicts the maximum number of characters that you want to extract.

---

7. In the **Trim the extracted text (remove blank spaces)** check box, select to remove blank spaces from the extracted text.

For example, you extract an email from a website and then add it to an Excel sheet. To remove any unwanted spaces from this extracted email text, you can use the **Trim the extracted text (remove blank spaces)** option. Alternatively, you can use the [Trim action](#) on page 3104 to remove any space before and after this extracted email text.

8. In the **Remove Enter from the extracted text** check box, select to remove carriage returns from the extracted text.

9. In the **Assign the output to variable** list, specify the variable.

10. Click **Save**.

## Examples of using Extract text action

The **Extract text** action enables you to extract text from a source string. You can extract text that occurs in the range of 1 to 999999 times in a file before, after, or between two strings.

### Before option

This option enables you to extract the entire text followed by the value you have provided in the **Start after text** field. You can also extract the text based on the occurrence of the value you have provided in the field.

For example, a:123a:123b:123c: is the source string, you can specify : in the **Start after text** field and 2 in the **Occurrence** field to extract the string followed by the second occurrence of : in the source string. In this example, the extracted text is 123b:123c:.

## After option

This option enables you to extract the entire text preceding the value you have provided in the **End before text** field. You can also extract the text based on the occurrence of the value you have provided in the field.

---

**Note:** You can extract text that occurs more than 1000 times in a file and up to a maximum of 999999 times.

---

For example, `a:123a:123b:123c:` is the source string, you can specify `:` in the **End before text** field and 3 in the **Occurrence** field to extract the string preceding the third occurrence of `:` in the source string. In this example, the extracted text is `a:123a:123b`.

## Before and/or after option

This option enables you to extract the text between the values you have provided in the **Start after text** and the **End before text** fields. You can also apply the **AND** or **OR** logical operator. You can select the **AND** operator to extract text only when both conditions specified for the **Before** and **After** options are satisfied. Otherwise, you can select the **OR** operator to extract text only when either of the conditions specified for the **Before** or the **After** option is satisfied.

For example, `a:123a:123b:123c:` is the source string, you can specify `:` in the **Start after text** and **End before text** fields and 2 in the **Occurrence** fields to extract the string after the second and before the fourth occurrence of `:` in the source string. In this example, the extracted text is `123b:123c`.

## Compare action

The **Compare** action in the `String` package enables you to compare two strings.

### Settings

- In the **Source string** field, specify the source string.
- In the **Compare to string** field, specify the string that the source has to be compared with.
- In the **When comparing** field, select an option:
  - **Match case:** Matches capitalization.
  - **Do not match case:** Does not match capitalization.
- In the **Assign the output to variable** list, specify the Boolean variable.

## Evaluate variable action

Use the **Evaluate variable** action in the `String` package to compare the user-specified string variable with the string variables in the bot. If a match is found, the action returns the value of the matching variable.

## Settings

- Enter the string variable that you want to find.
- In the **Assign the value to a variable** field, select a string variable to hold the returned value.

## Example

Assume you have a bot where you defined a string variable named `$cityname$`. The value of the variable `$cityname$` is set to `Paris`. You can now build a bot and use the **Evaluate variable** action to compare the variable that you create, with an already existing string variable in the bot. If a match is found, then the action returns the value of the matched variable.

1. Create a variable of type string whose value you want to evaluate and name it `var1`.
2. In the Default value field, enter `$cityname$`.

---

**Note:** `$cityname$` is the string variable that you have used in the bot.

---

3. Enter `$var1$` in the **Variable expression** field.
4. On bot execution, the user specified string variable `$var1$` now searches among the variables defined in the bot for the string variable `$cityname$` and if the match is found then the action returns the output value of the matched variable `$cityname$`, that is, `Paris`.

## Using Find action of String package

Use the **Find** action to find a substring within the specified string.

This action also enables you to perform a search based on a regular expression. A regular expression is a sequence of characters that define a search pattern. For example, to find all email addresses in the source string, specify the following as a regular expression: `\b[A-Z0-9._%~]+@[A-Z0-9.-]+\.[A-Z]{2,4}\b`.

---

**Note:** To search for strings that contain the dollar sign (\$), you must enter the sign twice. Otherwise, the bot interprets the dollar sign as a regular expression character.

---

To find a substring from the specified string, follow these steps:

1. In the **Actions** palette, double-click or drag the **Find** action from the **String** package.
2. In the **Source string** field, specify the source string.
3. In the **Find string** field, specify the substring.
4. In the **When finding** field, select one of the options:
  - **Match case:** Matches the case of the text.
  - **Do not match case:** Does not match the case of the text.
5. In the **The "find string" is** field, select one of the options:
  - **A regular expression:** The substring is a regular expression
  - **Not a regular expression:** The substring is not a regular expression.
6. Optional: In the **Start from** field, specify the starting point.

For example, you want to replace Red in the source string with Blue in a paragraph. Red is in 10 instances in the paragraph and you want to replace only the third occurrence. Enter 3 in the **Start from** field to identify the third occurrence.

---

**Note:** If the specified substring is not found, then the output will return as **0**.

---

7. In the **Assign the output to variable** list, specify the number variable.
8. Click **Save**.

## Length action

The **Length** action in the String package enables you to retrieve the string length.

### Settings

- In the **Source string** field, specify the source string.
- In the **Assign the output to variable** list, specify the number variable.

## Lowercase action

The **Lowercase** action in the String package enables you to convert the source string to lowercase.

### Settings

- In the **Source string** field, specify the source string.
- In the **Assign the output to variable** list, specify the variable.

## Generate random string action

The **Generate random string** action in the String package enables you to generate a string of uppercase and lowercase alphanumeric characters and assign it to a string variable.

### Settings

- In the **String length** field, enter the number of characters in the generated string.

---

**Note:** The maximum number of characters is 300.

---

- In the **Enter the destination variable to assign the random string** field, specify the string variable.

## Using Replace action

Use the **Replace** action to find a piece of text from the source string and replace it with another text.

A regular expression is a sequence of characters that define a search pattern. For example, to find all email addresses in the source string, specify the following as a regular expression: `\b[A-Z0-9._%~]+@[A-Z0-9.-]+\.[A-Z]{2,4}\b`.

---

### Note:

- The **Replace** action might not replace the Carriage Return and Line Feed (CRLF) characters in a string when you use the Enter variable. To ensure that the characters are replaced, instead of the Enter variable, use the Newline variable.
  - When you use the \$ character in your regular expression pattern, the regular expression field might show an error as \$ is considered as the start of a variable specification. Hence, we recommend you use \$\$ instead.
- 

To replace text from the specified string, follow these steps:

1. In the **Actions** palette, double-click or drag the **Replace** action from the **String** package.
  2. In the **Source string** field, specify the source string.
  3. In the **Find string** field, specify the substring.
  4. In the **When finding** field, select one of the options:
    - **Match case**: Matches the case of the text.
    - **Do not match case**: Does not match the case of the text.
  5. In the **The "find string" is** field, select one of the options:
    - **A regular expression**: The substring is a regular expression
    - **Not a regular expression**: The substring is not a regular expression.
  6. Optional: In the **Start from** field, specify the starting position.  
The action then starts from the value you specify in this field. For example, if you specify 5 in the **Start from** field for the source string "Big blue ocean", when the bot runs, the action ignores the four preceding characters ("Big", including the space character) and searches for the substring in "blue ocean".
  7. Optional: In the **Count** field, specify the number of times the found string must be replaced.  
For example, in the source string "Big blue ocean, blue fish, blue sky", you want to replace the first two instances of "blue" with "green". Enter 2 in the **Count** field, 5 in the **Start from** field, and green in the **Replace with** field. When the bot runs, the action produces the output green ocean, green fish, blue sky.
- 

**Note:** By default, the value in the **Count** field is set to -1, which means that all the instances of the found string will be replaced.

---

8. In the **Replace with** field, specify the text to replace the string.
9. In the **Assign the output to variable** list, specify the variable that will hold the new string.
10. Click **Save**.

## Reverse action

The **Reverse** action in the String package enables you to reverse the source string.

### Settings

- In the **Source string** field, specify the source string.
- In the **Assign the output to variable** list, specify the variable.

## Using Split action

Use the **Split** action to split the specified string into multiple strings and store the output in a list variable.

To split a string into multiple strings, perform these steps:

1. In the **Actions** palette, double-click or drag the **Split** action from the **String** package.
2. In the **Source string** field, specify the source string.
3. In the **Delimiter** field, specify the character to split the string.  
For example, comma (,), semicolon (;), pipe (|), slash (/ \), newline character (\n), or space.  
In the delimiter text box, the newline character is not accepted for the Enter key as a line break. In that case, you can either press **F2** and select **Enter - String** from String section or input the `$String:Enter$` variable.
4. In the **Delimiter is** field, select one of the options:
  - **Case sensitive**: The delimiter is case-sensitive.
  - **Not case sensitive**: The delimiter is not case-sensitive.
5. In the **Split into substrings** field, select one of the options:
  - **All possible**: Splits the source string into as many substrings as possible.  
For example, if the original string is a,b,c,d, each character becomes a substring.
  - **Only**: Limits the number of substrings.  
For example, if the original string is a,b,c,d, and you enter 3, the output is three strings: a, b, and c,d.
6. In the **Assign the output to list variable** field, specify the list variable.
7. Click **Save**.

## Example of using Split action

In this example, you will build a bot to read a CSV file, split a specified string into multiple strings.

### Prerequisites

Before you start building the bot, create a file in .CSV format using the data in the following table and save it as **String\_datatable.csv**



---

Name	Location	Joining date
Savio	Bangalore	26-Jun-21
Rene	Bangalore	15-Oct-21

## Procedure

1. Create a bot.
  - a) On the left panel, click **Automation**.  
A list of available bots and forms is displayed.
  - b) Click **Create a bot**.
  - c) Enter the bot name: `String_split`.
  - d) Click **Create and Edit**.
2. Open and read data from the CSV file.
  - a) Double-click or drag the **Excel advanced > Open** action.
  - b) From the **File** option, in the **Desktop file** field, click **Browse** to select your file.
  - c) Select the **Sheet contains a header** checkbox.
  - d) Open the file in **Read-write** mode.
  - e) In the **Create Excel session** field, select **Local session**.
  - f) Double-click or drag the **Excel advanced > Read row** action.
  - g) From the **Cell option** tab, select **From specific cell** and enter C2 in the **Cell address** field.
  - h) From the **Read option** tab, select **Read visible text in cell** option.
  - i) In the **Session name** field, enter the session that you used to open the file.
  - j) In the **Assign value to the variable** field, click the **Create variable** icon to create a variable.
  - k) On the **Create variable** window, enter `list_outputdata` in the **Name** field.
  - l) Click **Create and select**.
  - m) Double-click or drag the **Excel advanced > Close** action to close the .txt file.
  - n) In the **Session name** field, enter the session name that you used in the **Open** action to open the file.
3. To print the values of the specified row, double-click or drag the **Message box** action. In the **Enter the message to display** field, enter `$list_outputdata[0]$`.

When you run the bot, the bot displays the string in row C2 as **26-**

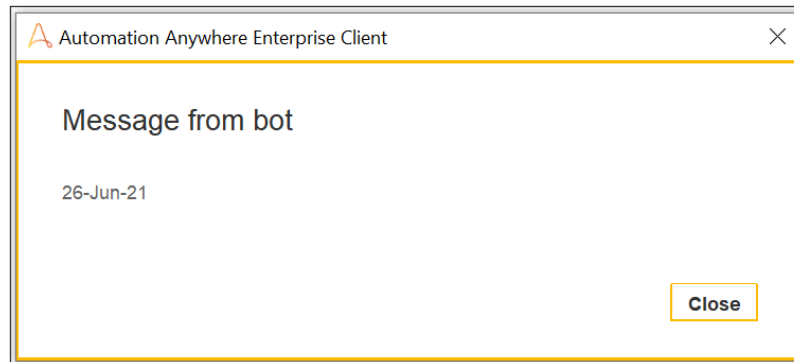

**Jun-21.**

4. To split the specified string into multiple strings, double-click or drag the **String > Split** action.
  - a) In the **Source string** field, enter `$list_outputdata[0]$`
  - b) In the **Delimiter** field, enter `-`.
  - c) From the **Delimiter is** tab, select **Not case sensitive**.
  - d) From the **Split into substrings** tab, select **All possible**
  - e) In the **Assign value to the variable** field, click the **Create variable** icon to create a variable.
  - f) On the **Create variable** window, enter `substrings_split` in the **Name** field.
  - g) Click **Create and select**.
  
5. To print the values, double-click or drag the **Message box** action. In the **Enter the message to display** field, enter the following data:  

```
Date is $substrings_split[0]$  
Month is $substrings_split[1]$  
Year is $substrings_split[2]$
```
6. Click **Save** and then **Run**.

The bot splits the specified string into multiple substrings and displays the output as follows:

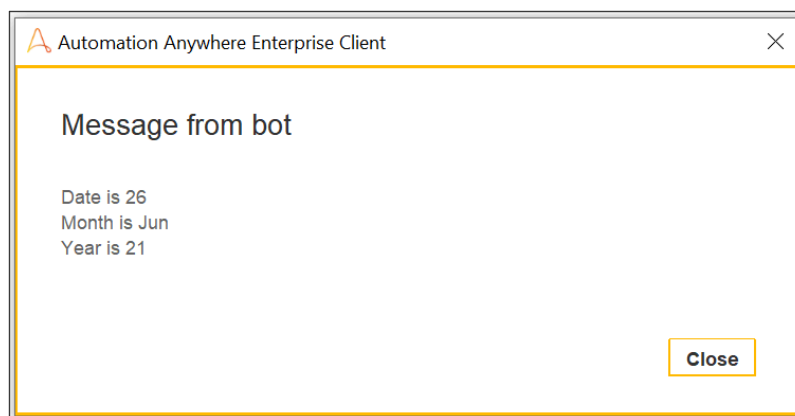

## Substring action

The **Substring** action in the String package enables you to extract a substring from a string.

### Settings

- In the **Source string** field, specify the source string.
- In the **Start from** field, specify the starting point.
- In the **Length** field, specify the length.
- Select the **Return blank if the range is not found** option to have the output to show a blank value when the value in the **Start from** index field is greater than the source string.

---

**Note:** The index count starts from 1.

---

- In the **Assign the output to variable** list, specify the variable.

### Example

Before you start building a bot, create a file in .txt format and save it as `extract_substring.txt` in the `C:\Bot testing` folder. Open the `extract_substring.txt` file and enter the text: `Welcome to the Automation 360 platform` and save it.

Create a sample bot and perform the following steps to extract a substring from a source string:

1. Create a bot.
  - a) On the left panel, click **Automation**.  
A list of available bots and forms is displayed.
  - b) Click **Create a bot**.
  - c) Enter the bot name: `String_assign`.
  - d) Click **Create and Edit**.
2. Open and read data from the .txt file.
  - a) Double-click or drag the **CSV/TXT > Open** action.  

---

**Note:** The session name will be set to default.

---
  - b) In the **File path** field, select the **Desktop file** option and click **Browse** to select your file.
  - c) In the **Delimiter** tab, select the **Comma** check box.
  - d) Double-click or drag the **CSV/TXT > Read** action.
  - e) In the **Assign value to the variable** field, click the **Create variable** icon to create a variable.
  - f) On the **Create variable** window, enter `table_data` in the **Name** field.
  - g) Click **Create and select**.
  - h) Double-click or drag the **CSV/TXT > Close** action to close the .txt file.

- i) In the **Session name** field, enter the session name that you used in the **Open** action to open the file.
3. To extract a substring from the source string, double-click or drag the **String > Substring** action.
    - a) In the **Source string** field, select `$table_data[0][0]`.
    - b) In the **Start from** field, enter 16.
    - c) In the **Length** field, enter 14.
    - d) In the **Assign the output to variable** field, click the **Create variable** icon to create a variable.
    - e) On the **Create variable** window, enter `substring_output` in the **Name** field.
    - f) Click **Create and select**.
  4. To print the values, double-click or drag the **Message box** action. In the **Enter the message to display** field, enter `$substring_output`.
  5. Click **Save** and then **Run**.

The bot extracts the specific substring from the source string and displays the output as **Automation 360**.

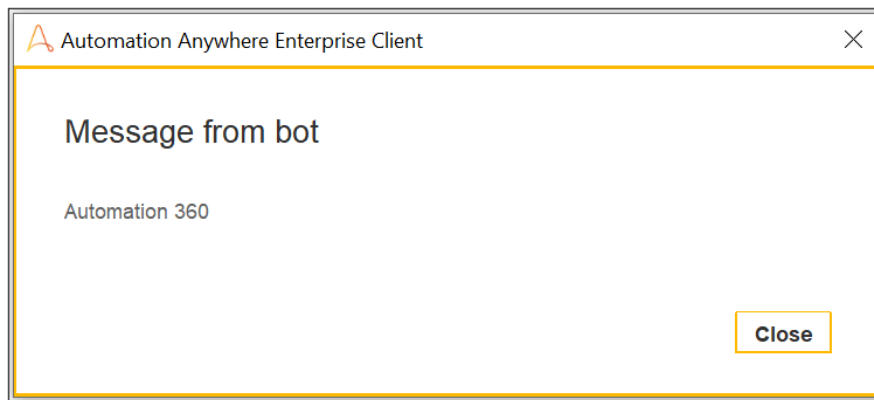

## To boolean action

The **To boolean** action in the String package enables you to convert a string to a Boolean.

### Settings

- In the **Select string variable** variable field, specify the source string variable.
- In the **Select the boolean variable to store the result** field, specify the Boolean variable.

## To locale number action

The **To locale number** action in the String package enables you to convert a string to a locale-formatted number.

### Settings

- In the **Source value** field, specify the source string.
- Select any of the following tab to specify locale:
  - **Specify**: Manually specify the two letter ISO codes for the locale you want to use in the **Locale** field.
  - **Device**: Use the default locale configured for the device.
- In the **Save the outcome to a variable** list, specify the variable.

You can also use the action in an expression. For example, `$prompt-assignment.String:toLocaleNumber("en-US")$`.

### Example

Create a sample bot and perform the following steps to convert a string to a locale-formatted number:

1. Create a bot.
  - a) On the left panel, click **Automation**.  
A list of available bots and forms is displayed.
  - b) Click **Create a bot**.
  - c) Enter the bot name: `String_localenumber`.
  - d) Click **Create and Edit**.
2. To convert a string to a locale-formatted number, from the **Actions** pane, double-click or drag the **String > To locale number** action.
  - a) In the **Source value** field, enter `1,23,345.67`
  - b) Select the **Specify** option and enter `en-US` in the **Locale** field.
  - c) In the **Save the outcome to a variable** field, click the **Create variable** icon to create a variable.
  - d) On the **Create variable** window, enter `Num_output` in the **Name** field.
3. To convert the number to a string, from the **Actions** pane, double-click or drag the **Number > To string** action.
  - a) In the **Enter a number** field, select `$Num_output$` variable.
  - b) In the **Enter number of digits after decimal (number format)** field, enter `2`.
  - c) In the **Assign the output to variable** field, click the **Create variable** icon to create a variable.

- d) On the **Create variable** window, enter `locale_output` in the **Name** field.
  - e) Click **Create and select**.
4. To print the values, double-click or drag the **Message box** action. In the **Enter the message to display** field, enter `$locale_output$`.
  5. Click **Save** and then **Run**.
- The bot now displays the value as **123345.67**

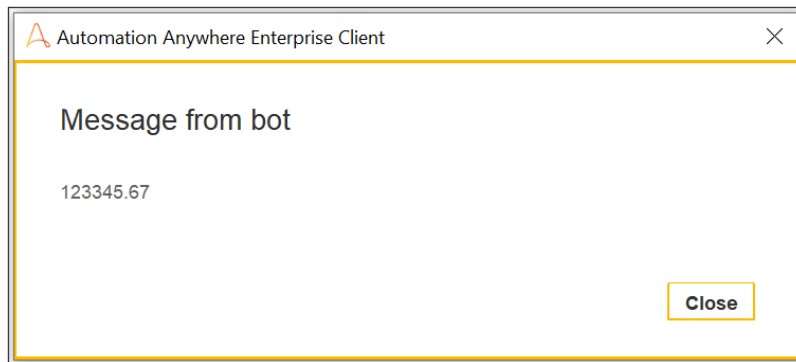

## To number action

The **To number** action in the String package enables you to convert a string to a number.

### Settings

This action supports positive, negative, and decimal numbers.

**Note:** If the string contains commas, remove them by using the **Replace** action to replace each comma with an empty string.

- In the **Enter the string** field, specify the source string.
- In the **Assign the output to variable** field, specify the number variable.

### Example

Create a bot to convert a string to a decimal number.

1. Create a bot.
  - a) On the left panel, click **Automation**.  
A list of available bots and forms is displayed.
  - b) Click **Create a bot**.
  - c) Enter the bot name: `String_to_number`.
  - d) Click **Create and Edit**.

2. To assign the string to a variable, double-click or drag the **String > Assign** action.
  - a) In the **Select the source string variable(s)/value** field, select `5.78`.
  - b) In the **Select the source string variable(s)/ value (optional)** field, click the **Create variable** icon to create a variable.
  - c) On the **Create variable** window, enter `stringtest` in the **Name** field.
  - d) Click **Create and select**.
  
3. To convert string to a number, double-click or drag the **String > To number** action.
  - a) In the **Enter the string** field, select `$string_test$` variable.
  - b) In the **Assign the output to variable** field, click the **Create variable** icon to create a variable.
  - c) On the **Create variable** window, enter `numtest` in the **Name** field.
  - d) Click **Create and select**.
  
4. To print the values, double-click or drag the **Message box** action. In the **Enter the message to display** field, enter `$numtest.Number.toString$`.
5. Click **Save** and then **Run**.

You now observe that the bot truncates the values after the decimal points and displays the output as **5**. Hence, you must again convert this number value to a string value to generate an output that would include the value with the decimal point.
  
6. To convert the number to a string, from the **Actions** pane, double-click or drag the **Number > To string** action.
  - a) In the **Enter a number** field, select `$numtest$` variable.
  - b) In the **Enter number of digits after decimal (number format)** field, enter `3`.
  - c) In the **Assign the output to variable** field, click the **Create variable** icon to create a variable.
  - d) On the **Create variable** window, enter `numtostring_output` in the **Name** field.
  - e) Click **Create and select**.
  
7. To print the values, double-click or drag the **Message box** action. In the **Enter the message to display** field, enter `$numtostring_output$`.
8. Click **Save** and then **Run**.

The bot now displays the value as **5.78**.

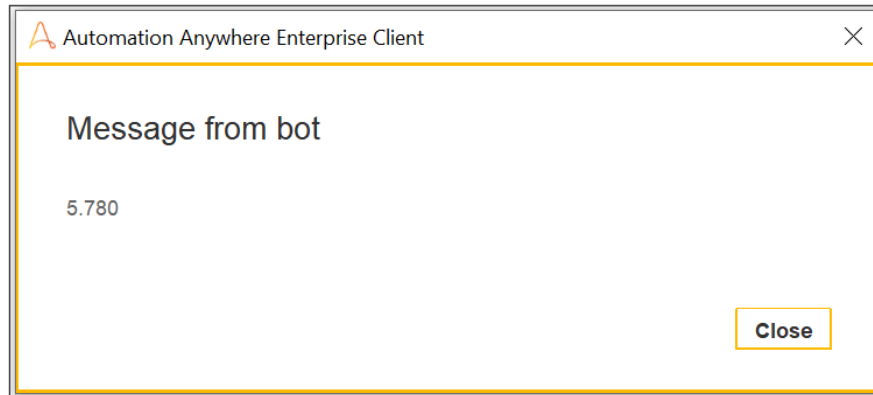

## Trim action

The **Trim** action in the String package enables you to trim blanks, whitespaces, tabs, and line breaks from a string.

### Settings

- In the **Source string** field, specify the source string.
- In **Trim from the beginning** and **Trim from the end**, select options.
- In the **Assign the output to variable** field, specify the variable.

## Uppercase action

The **Uppercase** action in the String package enables you to convert the source string to uppercase.

### Settings

- In the **Source string** field, specify the source string.
- In the **Assign the output to variable** list, specify the variable.

## Import string from text file (Legacy) action

---

**Note:** This action is no longer available for new bots. Instead, use the **Text file > Read Variables** action with enhanced capabilities. Existing bots using the legacy action will not be impacted and will continue to run.

---

See

- [Read variables action](#) on page 3135
- [Support and deprecation policy for packages](#) on page 1079 (for package lifecycle and deprecation policy)



## System package

Use the actions in the `System` package to automate locking, logging off, restarting, and shutting down the computer. Use these actions at the end of a task.

The `System` package includes the following actions:

---

**Note:** If you are on Automation 360 v.22 (Build 10526) or a later version, we recommend that you use the Automation 360 v.22 or a later System package version to run your bots seamlessly.

---

Action	Description
Lock computer	See <a href="#">Lock computer action</a> on page 3106.
Logoff	See <a href="#">Logoff action</a> on page 3106.
Restart	See <a href="#">Restart action</a> on page 3106.
Shutdown	See <a href="#">Shutdown action</a> on page 3106.
Get environment variable	See <a href="#">Get environment variable action</a> on page 3106.

### Related tasks

[Using Log text to file action](#) on page 2782

The **Log text to file** action in the Log To File package enables you to create a log file with data about the events that occur when a Task Bot runs.

### Related reference

[Application package](#) on page 2428

Use the `Open Program/File` action in the `Application` package to launch an application or a file. This action supports `.exe`, `.bat`, script files, or shortcut paths.

[System package updates](#) on page 962

Review the updates in released versions of the System package such as new and enhanced features as well as fixes and limitations. The page also lists the release dates of each version, and the compatible Control Room and Bot Agent versions.

## Lock computer action

The **Lock computer** action enables you to lock the local machine on which the bot is run.

## Logoff action

The **Logoff** action enables you to log off from the current user session of the local machine on which the bot is run.

## Restart action

The **Restart** action enables you to restart the local machine on which the bot is run.

## Shutdown action

The **Shutdown** action enables you to turn off the local machine on which the bot is run .

## Get environment variable action

The **Get environment variable** action enables you to get all the environment variables from the specified local machine and assign it to a variable.

## Settings

- (Optional) In the **Environment variable list** tab, click the drop-down menu and select one of the variables.

The following table lists the variable details:

Variable	Description	Example value
ALLUSERSPROFILE	Returns the path to the directory that contains resources and settings used by all system accounts.  <b>Note:</b> Use ProgramData for devices that run Windows Vista and later OS.	C:\ProgramData
APPDATA	Returns the file path to the application data directory. This directory contains the settings for applications shared across multiple devices.	C:\Users\ \<user> \AppData \Roaming

Variable	Description	Example value
COMPUTERNAME	Returns the device name without the domain.	AA-NY-FRANKSINATRA
CommonProgramFiles	Returns the file path to the Common Files directory.	C:\Program Files\Common Files
CommonProgramFiles(x86)	Returns the file path to the Common Files directory. <b>Note:</b> This is only available for devices that run 64-bit version.	C:\Program Files (x86)\Common Files
CommonProgramW6432	Returns the file path to the Common Files directory. <b>Note:</b> <ul style="list-style-type: none"> <li>This is only available for devices that run 64-bit version.</li> <li>Only use CommonProgramW6432 for devices that run Windows Vista and later OS</li> </ul>	C:\Program Files\Common Files
ComSpec	Returns the file path to the command processor	C:\Windows\system32\cmd.exe
DriverData	Returns the file path to the Driver Data directory.	C:\Windows\System32\Drivers\DriverData
HOMEDRIVE	Returns the home drive of the device.	C:
HOMEPath	Returns the homedir of the device without the system drive.	\Users\ <user&gt;< td=""> </user&gt;<>
LOCALAPPDATA	Returns the file path to the application data directory. This directory contains the settings for applications shared across multiple devices.	C:\Users\ <user&gt;\appdata\local< td=""> </user&gt;\appdata\local<>
LOGONSERVER	Returns the name of the group or domain to which the device is connected	\\SJC SRV BKP
NUMBER_OF_PROCESSORS	Returns the number of processors in the device.	4

Variable	Description	Example value
OneDrive	Returns the path to the OneDrive folder.	C:\Users \<user> \OneDrive
OS	Returns the device operating system name.	Windows_NT
Path	Returns a semicolon-delimited list of directories that contain executable programs.	C:\Windows \system32;C: \Windows;C: \Windows \System32\Wbem;C: \Windows \System32\WindowsPowerShell \v1.0\
PATHEXT	Returns a semicolon-delimited list of file extensions that the system can execute.	.COM;.EXE;.BAT;.CMD;.VBS;.VBE
PROCESSOR_ARCHITECTURE	Returns the process architecture of the device.	AMD64
ProgramData	Returns the path to the directory that contains resources and settings used by all system accounts.  <b>Note:</b> Use ALLUSERSPROFILE for devices that run the Windows XP and earlier OS.	C: \ProgramData
ProgramFiles	Returns the path to the directory that stores installed programs.	C:\Program Files
ProgramFiles(x86)	Returns the path to the directory that stores installed programs.  <b>Note:</b> This is only available for devices that run 64-bit version.	C:\Program Files (x86)
ProgramW6432	Returns the path to the directory that stores installed programs.	C:\Program Files
PSModulePath	Returns file paths to the modules that are installed on the disk.	%ProgramFiles % \WindowsPowerShell \Modules;C: \Windows \system32\WindowsPowerShell \v1.0\Modules
PUBLIC	Returns the Public folder path.	C:\Users\Public
SystemDrive	Returns the device system drive.	C:

Variable	Description	Example value
SystemRoot	Returns the system root folder.	C:\Windows
TMP	Returns the path to the directory that stores temporary files.	C:\Users\ \<user> \AppData\Local \Temp
TEMP	Returns the path to the directory that stores temporary files.	C:\Users\ \<user> \AppData\Local \Temp
USERDNSDOMAIN	Returns the DNS domain of the user.	AAI.AASPL- BRD.COM
USERDOMAIN	Returns the domain of the user.	AAI.AASPL- BRD.COM
USERDOMAIN_ROAMINGPROFILE	Returns the domain of the user profile.	AAI
USERNAME	Returns the logged-in user name.	bob.ross
USERPROFILE	Returns the user profile path.	C:\Users \<user>
windir	Returns the Windows directory path.	C:\Windows

- (Optional) Use the **Variable** tab to add a value for the variable.  
Click **Insert a value** icon if there is no existing variable.
- Click the **Assign the output to an existing variable** drop-down menu and select an existing variable.  
Click the **Create variable** icon for new variable.

## Task Bot package

Use the **Run**, **Pause**, and **Stop** actions in the Task Bot package to manage running one or more child bots from a parent bot or with a third-party software using an API.

Build smaller bots that automate a single task and run them from a parent bot. For example, build a `Login` child bot to enter the username and password into a web form and click submit. The `Login` child bot accepts credentials from the parent bot and returns a success message, and then the parent bot can call the subsequent `CreateInvoice` child bot. The `Login` child bot should also contain error handling logic in case the credentials are incorrect.

This practice of building smaller, self-contained bots enables a user to reuse the bot logic in a greater number of tasks, and makes error handling and troubleshooting easier. This also decreases the amount of time spent building and maintaining bots. As a result, an organization is able to rapidly scale their automation initiatives. The `Login` child bot from this example can be reused in any task that involves providing credentials to a login page on a website.

When you run a Task Bot that calls itself repeatedly until you choose to stop it, the bot runs infinitely and, as a result, encounters an error related to stack memory issues. We recommend that you create a parent and a child bot with different names and then run the child bot from the parent bot.

---

**Note:**

- CSV/text file and Recorder sessions cannot be shared across bots. You can share Excel sessions across bots by using a session variable. See [Example for sharing an Excel session between bots](#) on page 3114.
- When you use a file type variable in the Run Task, ensure you have set the default value in the variable. Without default value, the bot displays an error on execution.

---

In addition, running child bots from a parent bot offers greater control over data in the following ways:

- Users can configure the variables in the child bot to control the direction in which information can be exchanged by selecting from the following options:
  - **Use as input:** The variable holds a value that the child bot accepts from a parent bot or third-party software.
  - **Use as output:** The variable holds a value that the child bot passes to the parent bot or third-party software.
  - **Both:** The value can be passed in both directions.
  - **Neither:** The variable is confined to this bot; it cannot be shared across other bots.

See [Create a variable](#) on page 2336

- Other users can reuse child bots without viewing their contents.

The Task Bot package includes the following actions:

Action	Description
Pause	See <a href="#">Pause action</a> on page 3111.
Run	<ul style="list-style-type: none"> <li>• See <a href="#">Using the Run action</a> on page 3111..</li> <li>• For an example, see <a href="#">Example of using the Run action</a> on page 3238.</li> </ul>
Stop	See <a href="#">Stop action</a> on page 3114.

Related reference

[Task Bot package updates](#) on page 963

Review the updates in released versions of the Task Bot package such as new and enhanced features as well as fixes and limitations. The page also lists the release dates of each version, and the compatible Control Room and Bot Agent versions.

## Pause action

The **Pause** action in the Task Bot package enables you to temporarily pause the running bot.

### Settings

Temporarily pauses the running bot. Use the **Pause** action to modify data or to verify the status of a relevant component.

When the bot reaches the **Pause** action during run time, a **Resume** button appears. You must click **Resume** for the bot to continue to the next action.

## Using the Run action

The **Run** action from the Task Bot package enables you to run one or more child bots. Configure the action to run the child bots repeatedly or with a delay, and to pass and retrieve values.

The action runs the selected task multiple times for a specified number of times or for a number of hours. The task can be repeated until the user chooses to stop it. You can save the output values to a dictionary variable, where each key in the dictionary is the variable name and corresponding value from the child bot. Or, you can map each dictionary key to a variable to store the corresponding value.

---

**Note:** When you create a Task Bot with dependencies, ensure that the both the parent and child bot are in the same workspace (public or private). You cannot call a public bot from a private bot. To do so, you should first either check-out or clone the public bot into the private workspace and then check-in both the bots to the public workspace.

---

1. In the **Actions** palette, double-click or drag the **Run** action from the **Task Bot** package.
2. In the **Task Bot to run** field, select the child bot:

Option	Description
Current Task Bot	Runs the current bot recursively.

Option	Description
Control Room file	<p>Select a bot that you want to run:</p> <ul style="list-style-type: none"> <li>Click the <b>Browse</b> tab if you want to select a bot from your private workspace.</li> </ul> <p>The location of the selected bot in the private repository is also displayed.</p> <ul style="list-style-type: none"> <li>Click the <b>Search</b> tab if you want to search for a bot from the public workspace and your private workspace.</li> </ul> <p>Suggestions about the bots available in the public and private workspaces are displayed when you start typing the name of the bot you want to run. The location of the selected bot in the public and the private workspaces is also displayed.</p>
Variable	<p>Select from the following options:</p> <ul style="list-style-type: none"> <li><b>File:</b> Insert a file variable that contains a bot.</li> <li><b>Control Room path:</b> Enter an expression beginning with <code>Bots</code> that contains a string variable to specify the bot. For example <code>Bots/\$department\$/PTOReport</code>.</li> </ul> <hr/> <p><b>Note:</b></p> <ul style="list-style-type: none"> <li>The file path is case-sensitive.</li> <li>The bot must be in the same workspace as the parent bot.</li> </ul> <hr/>

3. In the **Input values** fields, enter the values or variables to pass to the child bot:

**Note:** You can pass a Window type variable from a parent bot to a child bot.

- a) Select an input variable to activate the text field.
- b) Enter a value of the required data type.  
The icon on the left-side of the text field indicates the data type.

If you are configuring a bot with many input variables, use the **Quick map** option to automatically map variables that share the same name and data type. If the child bot contains variables for which there are no corresponding variables in the parent bot, the **Quick map** option creates new variables and maps them.

4. Optional: Select the repetition.  
See [Repeating a bot](#) on page 3114.
5. Optional: Select the **Delay between repetitions** option and enter the delay time in the **Minutes** and **Seconds** fields.



6. Optional: Select the **Upon error continue with next repetition or action in this bot** option. For alternative error-handling options, use actions from the Error handler package.

[Error handler package](#) on page 2552

7. In the **Save outcome to a variable** field, select either the **Multiple variables** or **Dictionary** option:

Option	Description
Multiple variables	<p>Click <b>Add variable mapping</b> to associate each dictionary key with a variable in the parent bot.</p> <p>Use this option if you do not want to use actions to extract the dictionary values.</p> <p>Use the <b>Multiple Variables</b> option to assign the output of the child bot to multiple variables directly. Using this option, you can set the multiple values returned by the child bot into the dictionary variable of the parent bot. You no longer need to assign the multiple outputs of the child bot to the individual variables of the parent bot using variable assignment commands. You can use the Dictionary package in the parent bot to extract the individual value assigned to the dictionary variable of the parent bot.</p> <p>For example, when you migrate Enterprise 11 bots, many output variables need to be assigned individually after the <b>Run</b> task action, which increases the size of the bot. You can directly set parent bot variables within the <b>Run</b> task action using the multiple variables option.</p>
Dictionary	<p>Insert or create a dictionary variable to hold the output variables and values in key-value pairs.</p> <p>Each key in the dictionary is the variable name and corresponding value from the child bot.</p>

8. Click **Save**.

For an example of using this action:

- [Example of using the Run action](#) on page 3238
- [Example for sharing an Excel session between bots](#) on page 3114

## Repeating a bot

Use the repeat option in the **Run** action of the Task Bot package to enable the repeat setting in a bot. You can use this option to repeat a bot after a run failure or to run routine bots.

### Options for repeating a bot

Do not repeat	Default. The bot runs once.
Repeat N times	Repeats the bot specified number of times.
Repeat for time unit	Repeats the bot for a time period (hh:mm:ss).
<b>Note:</b> Specify up to 99 hours, 59 minutes, or 59 seconds.	
Repeat until stopped by user	Repeats the bot until being stopped manually by clicking the <b>stop</b> button or by pressing the <b>ESC</b> key.
Delay between repetitions	Sets a duration of time to wait before repeating a bot (mm:ss).
Upon error continue with next repetition or action in this bot	The bot is repeated regardless of run failure.
<b>Note:</b> Error handling cannot capture the error when this option is enabled.	

## Stop action

The **Stop** action in the Task Bot package enables you to stop the running bot.

### Settings

For example, use the **Stop** action to terminate the bot if a condition is met, such as if the bot encounters a file larger than 100 MB.

## Example for sharing an Excel session between bots

Build two bots to update the employee salaries in a worksheet. In this example, one bot opens an Excel worksheet and passes the session name as a variable to the second bot, which iterates through the worksheet, calculates each employee's new salary, and updates the value in the worksheet.

Create a worksheet with the following data:

Employee ID	Start date	Salary
200	1/12/2020	50000
233	3/15/2018	75000

---

Employee ID	Start date	Salary
500	6/6/2020	60000
555	7/9/2019	65000

Build the child to iterate through the table of employees and update each salary to reflect the raise.

1. Open a new bot.
  - a) From Automation Anywhere web interface, on the left panel, click **Automation**.  
A list of available bots and forms is displayed.
  - b) Click **Create a bot**.
  - c) Enter the bot name `RaiseSalaries`.
  - d) Enter the folder location `\Bots\TaskBotExample`.  
To change where your bot is stored, click **Choose** and follow the prompts.
  - e) Click **Create and Edit**.
2. Create the following variables:
  - `sessionVariable`: session type; MS Excel subtype; use as input
  - `sCellAddress`: string type; default value of `C2`
  - `sSalary`: string type
  - `nSalary`: number type
3. Use a **Loop** action to iterate through all the rows in the worksheet.
  - a) Double-click or drag the **Loop** action.
  - b) Select the **For each row in worksheet** iterator.
  - c) Select the **Shared session** tab and insert `$sessionVariable$`.
  - d) Select the **Read cell value** option.
  - e) In the **Assign the current value to this variable** field, create a record variable.
4. Retrieve the employee's salary.
  - a) Drag into the Loop container the **Excel Advanced > Get single cell** action.
  - b) Select the **Shared session** tab and insert `$sessionVariable$`.
  - c) Select the **Specific cell** option and insert `$sCellAddress$`.
  - d) Select the **Read cell value** option.
  - e) In the **Store cell contents to** field, insert `$sSalary$`.
5. Convert the salary value to a number data type.
  - a) Drag into the Loop container the **String > To number** action.
  - b) In the **Enter the string** field, insert `$sSalary$`.
  - c) In the **Assign the output to variable** field, insert `$nSalary$`.
6. Calculate the new salary to be five percent greater than the current salary.

- a) Drag into the Loop container the **Number > Assign** action.
  - b) In the **Select source variable** field, enter `$nSalary$*1.05`.
  - c) In the **Select destination variable** field, insert `$nSalary$`.
7. Update the salary in the worksheet.
- a) Drag into the Loop container the **Excel Advanced > Set cell** action.
  - b) Select the **Shared session** tab and insert `$sessionVariable$`.
  - c) Select the **Specific cell** option and insert `$sCellAddress$`.
  - d) In the **Cell value** field enter `$nSalary.Number.toString$`.

---

**Note:** You must convert the value to a string data type before the bot can enter it into the worksheet. Use type casting as an alternative to the **Number > To string** action. [Type conversion](#) on page 2339

---

8. Move the cursor down by a single cell and assign that cell address to `sCellAddress`.
- a) Drag into the Loop container the **Excel Advanced > Go to cell** action.
  - b) Select the **Shared session** tab and insert `$sessionVariable$`.
  - c) Select the **Active cell** and **One cell below** options.
  - d) Drag into the Loop container the **Excel Advanced > Get cell address** action.
  - e) Select the **Shared session** tab and insert `$sessionVariable$`.
  - f) Select the **Active cell** option.
  - g) In the **Save active cell address** field, insert `$sCellAddress$`.

9. Click **Save** and **Close**.

Build the parent bot.

10. Open a new bot.
- a) Click **Create a bot**.
  - b) Enter the bot name `ExcelParentBot`.
  - c) Enter the folder location `\Bots\TaskBotExample`.  
To change where your bot is stored, click **Choose** and follow the prompts.
  - d) Click **Create and Edit**.

11. Create the following variable:

`sessionVariable`: session type; MS Excel subtype

12. Double-click or drag the **Excel Advanced > Open** action.
13. Within the **File > Desktop file** tab, click **Browse** to upload a file:
14. Select the **Sheet contains header** check box.
15. In the **Create Excel session** field, click **Global session** tab and use the **Insert a value** icon to select `sessionVariable`.
16. Select the child bot that you have created.
- a) Double-click or drag the **Task Bot > Run** action.
  - b) In the **Control Room file** tab, click **Choose** to select the `RaiseSalaries` bot.

- c) In the **Input values** section, select the **Global session** option and insert `$sessionVariable$`.

**17. Click Save and Run.**

The Excel worksheet opens and the value of each cell in the third column increases by five percent.

## Terminal Emulator package

The **Terminal Emulator** package contains actions that enable you to connect to and automate tasks on another machine. Use these actions to access and control operations on a remote machine. For example, you can run applications and access files on a different operating system.

The Terminal Emulator enables a machine to connect to and communicate with another machine using a command-line or graphical interface. The Terminal Emulator uses the Telnet or SSH protocol to communicate with other machines.

The Terminal Emulator supports ANSI, TN3270E, TN5250E, and VT100 terminal types.

---

**Important:** If you use different versions of the Terminal Emulator package in a parent bot and a child bot, the capability to share a session across bots is currently not supported. To share a session across parent and child bots, ensure that you use the same version of the package in both the parent and child bots.

---

### Before you start

---

**Important:** Before you establish a connection to a different terminal type, ensure that you have Visual C++ 2019 Redistributable Package installed on your system. If you are on an Automation 360 version earlier than A2019.14 (Build 5322), you must install Visual C++ 2013 Redistributable Package or Visual C++ 2015 Redistributable Package on your system.

---

Perform the following actions within the **Terminal Emulator** package as part of using the set of available actions:

1. Establish a connection with a host machine using the **Connect** action.

You must first establish a connection with a host machine to automate any Terminal Emulator related task. When establishing the connection, specify the details of the host machine and associate it with a session name. Use the session name provided in this action in the other actions so that you do not have to provide details of the host machine in those actions again. See [Using Connect action for Terminal Emulator](#) on page 3119.

---

**Important:** If you use any other action from this package before establishing the connection, you will encounter an error.

---

2. Use the Terminal Emulator actions to automate a task. For example, use the **Get field** action to retrieve the value from a particular field.
3. After you have automated all the Terminal Emulator related tasks, terminate the connection to the host machine using the **Disconnect** action.

## Actions in the Terminal Emulator package

The **Terminal Emulator** package includes the following actions:

Action	Description
Clear terminal	<a href="#">Clear terminal action</a> on page 3118
Connect	<a href="#">Using Connect action for Terminal Emulator</a> on page 3119
Disconnect	<a href="#">Disconnect action</a> on page 3124
Get all fields	<a href="#">Get all fields action</a> on page 3124
Get field	<a href="#">Get field action</a> on page 3125
Get text	<a href="#">Using Get text action for Terminal Emulator</a> on page 3125
Hide terminal	<a href="#">Hide terminal action</a> on page 3126
Search field	<a href="#">Search field action</a> on page 3126
Send key	<a href="#">Using Send key action</a> on page 3126
Send text	<a href="#">Using Send text action</a> on page 3129
Set key mappings	<a href="#">Using Set key mappings</a> on page 3130
Set cursor position	<a href="#">Set cursor position action</a> on page 3131
Set field	<a href="#">Using Set field action</a> on page 3131
Show terminal	<a href="#">Show terminal action</a> on page 3132
Wait	<a href="#">Using Wait action</a> on page 3132

Related reference

[Terminal Emulator package updates](#) on page 964

Review the updates in released versions of the Terminal Emulator package such as new and enhanced features as well as fixes and limitations. The page also lists the release dates of each version, and the compatible Control Room and Bot Agent versions.

## Clear terminal action

The Clear terminal action in the Terminal Emulator package enables you to clear the screen of the terminal.

## Settings

Specify the **Terminal emulator session name** that you used to establish a connection with the terminal using the **Connect** action.

## Using Connect action for Terminal Emulator

Use the **Connect** action to establish a connection with a host machine on which you want to automate a task. You can use this action to establish a connection with the TN3270E, TN5250E, ANSI, VT220, and VT100 terminal types.

This action enables you to specify the details of the host machine and associate it with a session name. Use the session name provided in this action in the other actions, so that you do not have to provide details of the host machine in those actions again.

---

**Important:** If you use any other action from this package before establishing the connection, you will encounter an error.

---

To establish a connection with a host machine, perform the following steps:

1. Double-click or drag the **Connect** action from the **Terminal Emulator** node in the **Actions** palette.
2. Specify a name for the session in the **Terminal emulator session name** field.

---

**Note:** Use the different session name to open multiple terminal windows. If you want to use the same session name, you must first close the session of the first terminal window before using the same session name for another terminal window.

---

3. Specify the **Host name** of the machine you want to connect to:
  - a) Click the **Credential** tab to select an entry from the Credential Vault.
  - b) Click the **Variable** tab to use a variable to specify the host name.
4. Enter a value in the **Port** field to specify the port you want to use to connect to the host.
5. Select one of the following options to specify the terminal type:

Option	Steps
ANSI	<p>Select an option from the <b>Connection type</b> list to specify the type of connection you want to establish:</p> <ul style="list-style-type: none"><li>• <b>Telnet</b></li><li>• <b>SSH2</b></li></ul> <p>For <b>SSH2</b> connection type:</p> <ul style="list-style-type: none"><li>• For <b>User authentication</b>:<ul style="list-style-type: none"><li>• <b>User name</b>: Click the <b>Credential</b> tab to select an entry from the Credential Vault. You can also click the <b>String</b> tab to enter a value manually.</li><li>• For <b>Password</b>: Click the <b>Credential</b> tab to select an entry from the Credential Vault. You can also click the <b>String</b> tab to enter a value manually.</li></ul></li><li>• For <b>Key file authentication</b>: Click one of the following options to specify the location of the file:<ul style="list-style-type: none"><li>• <b>Control Room file</b>: Enables you to select a PDF file that is available in a folder.</li><li>• <b>Desktop profile</b>: Enables you to select a PDF file that is available on your device.</li><li>• <b>Variable</b>: Enables you to specify the file variable that contains the location of the PDF file.</li></ul></li><li>• For <b>User name</b>: Click the <b>Credential</b> tab to select an entry from the Credential Vault. You can also click the <b>String</b> tab to enter a value manually.</li></ul>



Option	Steps
TN3270E	<p><b>a)</b> Select an option from the <b>Host name security</b> list to specify the security you want to use:</p> <ul style="list-style-type: none"> <li>• <b>NONE</b></li> <li>• <b>SSL</b></li> <li>• <b>TLS</b></li> </ul> <p><b>b)</b> Select the <b>Enable TN3270E support</b> check box if you want to choose a connection method.</p> <p>Select an option from the <b>Connection method</b> list:</p> <ul style="list-style-type: none"> <li>• <b>GENERIC</b>: Enables you to specify the <b>Device name</b>.</li> <li>• <b>SPECIFIC</b>: Enables you to specify the <b>Device name</b> and <b>Resource (LU) Name</b>.</li> </ul> <p><b>c)</b> Select an option from the <b>Terminal model</b> list to specify the terminal workstation you want to connect to.</p> <p><b>d)</b> Select the check box to enable extended attributes on the TN3270E terminal.</p> <p><b>e)</b> Select an option from the <b>Code page</b> list to specify the encoding you want to use for the terminal.</p>
TN5250E	<p><b>a)</b> Select an option from the <b>Host name security</b> list to specify the security you want to use:</p> <ul style="list-style-type: none"> <li>• <b>NONE</b></li> <li>• <b>SSL</b></li> <li>• <b>TLS</b></li> </ul> <p><b>b)</b> Select the <b>Enable TN5250E support</b> check box if you want to specify details about the device and resource.</p> <p>Enter a value in the <b>Device name</b> and <b>Resource (LU) Name</b> fields.</p> <p><b>c)</b> Select an option from the <b>Terminal model</b> list to specify the terminal workstation you want to connect to.</p> <p><b>d)</b> Select an option from the <b>Code page</b> list to specify the encoding you want to use for the terminal.</p>

Option	Steps
VT Series <ul style="list-style-type: none"> <li>• VT100</li> <li>• VT220</li> </ul>	<p><b>a)</b> Select an option from the <b>Terminal model</b> list to specify the terminal type you want to connect to.</p> <p><b>b)</b> Select an option from the <b>Encoding</b> list to specify the encoding you want to use for the terminal:</p> <ul style="list-style-type: none"> <li>• ANSI</li> <li>• DBCS</li> <li>• UTF-8</li> </ul> <p>The <b>CodePage</b> field appears when DBCS option is selected. The CodePage supports only Japanese Shift-JIS (932).</p> <p><b>c)</b> Select an option from the <b>Connection type</b> list to specify the type of connection you want to establish:</p> <ul style="list-style-type: none"> <li>• <b>Telnet</b></li> <li>• <b>SSH2</b></li> </ul> <p>For <b>SSH2</b> connection type:</p> <ul style="list-style-type: none"> <li>• For <b>User authentication</b>:           <ul style="list-style-type: none"> <li>• <b>User name</b>: Click the <b>Credential</b> tab to select an entry from the Credential Vault. You can also click the <b>String</b> tab to enter a value manually.</li> <li>• For <b>Password</b>: Click the <b>Credential</b> tab to select an entry from the Credential Vault. You can also click the <b>String</b> tab to enter a value manually.</li> </ul> </li> <li>• For <b>Key file authentication</b>: Click one of the following options to specify the location of the file:           <ul style="list-style-type: none"> <li>• <b>Control Room file</b>: Enables you to select a PDF file that is available in a folder.</li> <li>• <b>Desktop profile</b>: Enables you to select a PDF file that is available on your device.</li> <li>• <b>Variable</b>: Enables you to specify the file variable that contains the location of the PDF file.</li> </ul> </li> <li>• For <b>User name</b>: Click the <b>Credential</b> tab to select an entry from the Credential Vault. You can also click the <b>String</b> tab to enter a value manually.</li> </ul> <p><b>d)</b> To determine the device attribute response that the terminal sends on request from the host, select the <b>Custom DA string</b> check box and enter the DA (Device Attributes) response of type string.</p>

Option	Steps
Linux	<p>Select an option from the <b>Connection type</b> list to specify the type of connection you want to establish:</p> <ul style="list-style-type: none"> <li>• <b>Telnet</b></li> <li>• <b>SSH2</b></li> </ul> <p>For <b>SSH2</b> connection type:</p> <ul style="list-style-type: none"> <li>• For <b>User authentication</b>: <ul style="list-style-type: none"> <li>• <b>User name</b>: Click the <b>Credential</b> tab to select an entry from the Credential Vault. You can also click the <b>String</b> tab to enter a value manually.</li> <li>• For <b>Password</b>: Click the <b>Credential</b> tab to select an entry from the Credential Vault. You can also click the <b>String</b> tab to enter a value manually.</li> </ul> </li> <li>• For <b>Key file authentication</b>: Click one of the following options to specify the location of the file: <ul style="list-style-type: none"> <li>• <b>Control Room file</b>: Enables you to select a PDF file that is available in a folder.</li> <li>• <b>Desktop profile</b>: Enables you to select a PDF file that is available on your device.</li> <li>• <b>Variable</b>: Enables you to specify the file variable that contains the location of the PDF file.</li> </ul> </li> <li>• For <b>User name</b>: Click the <b>Credential</b> tab to select an entry from the Credential Vault. You can also click the <b>String</b> tab to enter a value manually.</li> </ul>

**Note:** When you connect with the SSH2 server using public key authentication, the SSH client uses the private key file associated with the public key that has been authorized on the server.

Depending on the software used to generate SSH2 private keys, you can store SSH2 private keys using any of the file formats:

- Java KeyStore (JKS) format: Used by Java applications to store private keys, certificates, and other cryptographic data. The private key is stored in a file with a `.jks` extension.
- OpenSSH format(default format): Used by the OpenSSH suite of tools, including the `ssh-keygen` utility. The private key is stored in a file with no extension, typically named `id_rsa`, `id_dsa`, or `id_ecdsa` (based on the key type).
- OpenSSL format: Used by the OpenSSL library and other software that uses OpenSSL, such as Apache and NGINX. The private key is stored in a file with a `.pem` or `.key` extension.
- PKCS8 key format: Used as a standard format for securely storing private keys using the PKCS#8 standard. The private key is stored in a file with a `.pem` or `.key` extension.
- PuTTY format: Used by the PuTTY SSH client for Windows. The private key is stored in a file with a `.ppk` extension.

6. Select the **Show terminal window** check box to show the terminal window when the bot runs this action.

7. Select the **Set cursor position to the beginning** check box to edit the screen of the Terminal emulator session manually and set the focus to the first editable field.
8. Select the **Wait for the terminal prompt to appear while connected** check box to wait for the terminal prompt to appear on the screen of the terminal after the connection is established.
  - a) Enter the text you want to display when you connect to the terminal in the **Terminal prompt** field.
  - b) Enter a value in the **Wait time out** field to specify the period in (milliseconds) the system must wait before the connection request is timed out.
9. Select any of the following tabs to create a terminal emulator session:
  - **Local session**: Specify a session name that can be used only in the current bot.
  - **Global session**: Specify a session name that can be used across multiple bots such as parent bots, child bots, and other child bots of the parent bots.
  - **Variable**: Specify a session variable that can be used to share that session with other child bots.

## Disconnect action

The Disconnect action in the Terminal Emulator package enables you to terminate the connection with the terminal.

### Settings

Specify the **Terminal emulator session name** that you used to establish a connection with the terminal using the **Connect** .

## Get all fields action

The Get all fields action in the Terminal Emulator package enables you to retrieve the values of all fields and assigns them to a table variable.

### Settings

- Specify the **Terminal emulator session name** that you used to establish a connection with the terminal using the **Connect** .
- Select a table variable to store the retrieved data from the **Assign the value to an existing table variable** list. The table stores each field as a row, with the values of each field organized in the following columns:
  - Field index
  - Field name
  - Field value
  - Is Editable (yes/no)
  - Is Hidden (yes/no)

**Note:** You can use this action with the TN3270E and TN5250E terminal types.

---

## Get field action

The Get field action in the Terminal Emulator package enables you to retrieve the value of a field based on the index or name of the field and assigns it to a string variable.

### Settings

- Specify the **Terminal emulator session name** that you used to establish a connection with the terminal using the **Connect** .
- Select the **By index** option to retrieve the value of a field based on its index, or select the **By name** option to retrieve the value of a field based on its name.
- Select a string variable to store the retrieved data from the **Assign the value to an existing variable** list.

---

**Note:** You can use this action with the TN3270E and TN5250E terminal types.

---

## Using Get text action for Terminal Emulator

Use the **Get text** action to retrieve text from the terminal and store it in a string variable. This action enables you to retrieve text from the last line, all lines, or a range of lines. You can use this action with the TN3270E, TN5250E, ANSI, and VT100 terminal types.

To retrieve text from the terminal, do the following:

1. Double-click or drag the **Get text** action from the **Terminal Emulator** node in the **Actions** palette.
2. Enter the name of the session that you have used to establish a connection with the terminal using the **Connect** action in the **Terminal emulator session name** field.
3. Select an option from the **Get text** list to specify the lines from which you want to retrieve text:
  - **Last line:** Retrieves text from the last line of the terminal.
  - **All lines:** Retrieves text from all lines of the terminal.

Select from the following options to extract text from a specific area, viewable area, or the entire page displayed on the screen.

- **Viewport:** Retrieves text from the visible area of the Terminal Emulator window.
- **Number of lines from top:** To retrieve text corresponding to a specific number of lines from the top of the screen.
- **Full page capture (with scroll):** Retrieves all the lines on the screen, including the content that needs to be scrolled to access it.

---

**Note:** The **Full page capture (with scroll)** and **Number of lines from the top** options are supported only for **ANSI** and **VT Series** terminals. If you connect with other terminal types, regardless of the option selected, the extracted text displays the results similar to how they are displayed for the **Viewport** option.

---

- **Lines from-to:** Retrieves text from the specified range of lines of the terminal. You must enter values in the **Start row** and **End row** fields to specify the range.

---

**Note:** You can specify a value of 1 through 999.

---

4. Select a string variable from the **Assign the value to an existing variable** list to assign the retrieved text to that variable.
5. In the **Assign value to variable** list, select a string variable.

## Hide terminal action

The Hide terminal action in the Terminal Emulator package enables you to hide the terminal screen.

### Settings

This action enables you to hide the terminal screen when the **Show terminal window** option from the **Connect** action is selected. It is useful when you do not want to display the terminal screen when a bot is performing certain tasks. Specify the **Terminal emulator session name** that you used to establish a connection with the terminal using the **Connect**.

## Search field action

The search field action in the Terminal Emulator package enables you to search for the field based on the text it contains.

### Settings

- From the **Terminal emulator session name** field, choose one of the following options:
  - **Local name** to establish a connection with the terminal using the **Connect** action
  - **Shared session** to share the variable from **Set session variable** or from the parent bot
- Specify the text based on which you want to search the field.
- Select an option from **Select field** to specify whether to retrieve the index or name of the field.
- Assign and save the output to a variable.

---

**Note:** The search text you enter must be a complete match and is not case-sensitive.

---

## Using Send key action

Use the **Send key** action to send a key to the terminal. You can use these keys to perform various operations on the terminal. You can use this action with the TN3270E, TN5250E, ANSI, and VT100 terminal types.

To send a key to the terminal, do the following:

1. Double-click or drag the **Send key** action from the **Terminal Emulator** node in the **Actions** palette.

2. Enter the name of the session that you have used to establish a connection with the terminal using the **Connect** action in the **Terminal emulator session name** field.
3. Select an option from the **Select key to be send** list to specify the key you want to send.
4. Enter a value in the **Delay after send key command** field to specify the period the system must wait (in milliseconds) after the selected key is sent.
5. Select the **Wait for text or prompt to appear** check box if you want the system to wait for the prompt or certain text to appear on the terminal.
  - a) Select the **Prompt** option if you want the system to wait till the prompt appears on the terminal.
  - b) Select the **Text** option if you want the system to wait till the specific text appears on the terminal.  
You must provide the text you want to appear on the terminal in the **Text value to be appear on screen** field.
  - c) Select the **Wait before send key for prompt or text appear** check box if you want the system to wait for the prompt or the specified text to appear on the terminal before sending the selected key.
  - d) Select the **Wait after send key for prompt or text appear** check box if you want the system to wait for the prompt or the specified text to appear on the terminal after sending the selected key.
  - e) Enter a value in the **Time out for prompt or text to appear** field to specify the period (in seconds) the system must wait before the operation times out.
6. In the **Assign value to variable** list, select a string variable.

## How send key works in Send text action

Learn how keys work in the **Send Text** action in the Terminal Emulator.

**Note:** Behavior of the keys that are marked with the asterisk (\*) sign in the following tables is defined by the terminal host. The behavior might vary on different terminals.

The following table shows the behavior of the keys in the terminal types TN3270 and TN5250:

Keys	Behavior
KEY_BACKSPACE	Same behavior as the Backspace key on the keyboard.
KEY_BACKTAB	If the cursor is on the first position of a field, it moves to the previous field. Otherwise, it moves to the start of the current field.
KEY_CLEAR	Clears the entire text on the terminal screen.
KEY_ERASEINPUT	Deletes all the text in the field.
KEY_NEXTFIELD	Moves the cursor to the next field on the terminal screen.
KEY_ENTER	Sends Enter key to the terminal host.
KEY_HOME	Moves the cursor to the first editable field on the screen.

Keys	Behavior
KEY_RESET	The reset key only clears the Keyboard lock, such as releasing the terminal if the terminal screen is not working. The screen text and input field values remain the same.
KEY_LEFT	Moves the cursor to the left by one position.
KEY_RIGHT	Moves the cursor to the right by one position.
KEY_UP	Moves the cursor up by one position.
KEY_DOWN	Moves the cursor down by one position.
KEY_PGLEFT	Nothing happens.
KEY_PGRIGHT	Nothing happens.
KEY_PGUP	Page Up key
KEY_PGDOWN	Page Down key
KEY_TABFORWARD	Performs a tab key action on the terminal screen to move the cursor to the next field.
KEY_PF1 *	Same behavior as F1 key on the keyboard.
KEY_PF2 *	Same behavior as F2 key on the keyboard.
KEY_PF3 *	Same behavior as F3 key on the keyboard.
KEY_PF4 *	Same behavior as F4 key on the keyboard.
KEY_PF5 *	Same behavior as F5 key on the keyboard.
KEY_PF6 *	Same behavior as F6 key on the keyboard.
KEY_PF7 *	Same behavior as F7 key on the keyboard.
KEY_PF8 *	Same behavior as F8 key on the keyboard.
KEY_PF9 *	Same behavior as F9 key on the keyboard.
KEY_PF10 *	Same behavior as F10 key on the keyboard.
KEY_PF11 *	Same behavior as F11 key on the keyboard.
KEY_PF12 *	Same behavior as F12 key on the keyboard
KEY_PF13 *	Same behavior as Shift + F1 keys on the keyboard.
KEY_PF14 *	Same behavior as Shift + F2 keys on the keyboard.
KEY_PF15 *	Same behavior as Shift + F3 keys on the keyboard.
KEY_PF16 *	Same behavior as Shift + F4 keys on the keyboard.
KEY_PF17 *	Same behavior as Shift + F5 keys on the keyboard.
KEY_PF18 *	Same behavior as Shift + F6 keys on the keyboard.
KEY_PF19 *	Same behavior as Shift + F7 keys on the keyboard.
KEY_PF20 *	Same behavior as Shift + F8 keys on the keyboard.
KEY_PF21 *	Same behavior as Shift + F9 keys on the keyboard.



Keys	Behavior
KEY_PF22 *	Same behavior as Shift + F10 keys on the keyboard.
KEY_PF23 *	Same behavior as Shift + F11 keys on the keyboard.
KEY_PF24 *	Same behavior as Shift + F12 keys on the keyboard.

## Using Send text action

Use the **Send text** action to send text to the terminal. This action also enables you to send predefined keys after the text to perform various operations in the terminal. You can use this action with the TN3270E, TN5250E, ANSI, and VT100 terminal types.

You can use the following keyboard shortcuts to send a key on the terminal window using Simulate keystroke action:

**Note:** The keyboard shortcuts are supported in TN3270 and TN5250.

Key entry	Command
Shift + Control + A	Select all
Shift + Control + C	Copy
Shift + Control + X	Cut
Shift + Control + V	Paste

To send a text to the terminal, follow these steps.

1. Double-click or drag the **Send text** action from the **Terminal Emulator** node in the **Actions** palette.
2. Enter the name of the session that you have used to establish a connection with the terminal using the **Connect** action in the **Terminal emulator session name** field.
3. Specify the **Text** you want to send to the terminal:
  - a) Click the **Credential** tab to select an entry from the Credential Vault.
  - b) Click the **Variable** tab to use a variable that contains the text you want to send.
4. Select the **Send a key after sending the above text** check box if you want to send a key after sending the text.
  - a) Select the key you want to send from the list.
  - b) Enter a value in the **Delay after send key command** field to specify the period (in milliseconds) the system must wait after sending the selected key.
5. Select the **Wait for text or prompt to appear** check box if you want the system to wait for the prompt or certain text to appear on the terminal.
  - a) Select the **Prompt** option if you want the system to wait till the prompt appears on the terminal.
  - b) Select the **Text** option if you want the system to wait till the specific text appears on the terminal.

You must provide the text you want to appear on the terminal in the **Text value to be appear on screen** field.

- c) Select the **Wait before send key for prompt or text appear** check box if you want the system to wait for the prompt or the specified text to appear on the terminal before sending the selected key.
- d) Select the **Wait after send key for prompt or text appear** check box if you want the system to wait for the prompt or the specified text to appear on the terminal after sending the selected key.
- e) Enter a value in the **Time out for prompt or text to appear** field to specify the period (in seconds) the system must wait before the operation times out.

6. In the **Assign value to variable** list, select a string variable.

## Using Set key mappings

You can use the **Set key mappings** action to overwrite the default mapping of keys to perform various operations on the terminal.

The set key mapping is instrumental to developers as it enables them to map from key lists, especially when keys behave differently on different terminals. For example, you can map `KEY_PAGEUP` to `{Page Up}`, `{Roll Down}`, or `\x1b[5~` based on the terminal host you connected with.

1. Enter the name of the session or select an existing variable that you have used to establish a connection with the terminal using the **Connect** action in the **Terminal emulator session name** field.
2. Select the **Add key mapping** button to set a key and map it to a custom string or macro. The **Add key mapping** window opens:
  - a) Select the key to map from the drop-down list.
  - b) Add the custom string or macro to send it to the terminal.
  - c) Click **Add**.  
The custom key value is added. The following table provide examples of custom values set for function keys.

Key	Custom string or macro
F1	{F1} or \x1b[11~
F2	\x1b[12~
F3	\x1b[13~
ENTER	{Return}

### Note:

- In the automation, if you have set custom key values and used subsequent actions such as **Send key** or **Send text**, the default values of keys are overridden with the new set of values.

- You can set and use the custom key values in a particular session. If you create a new session and want to use the custom key values, you must set the keys and map them to a custom string or macro.

- 
3. Click **Save**.

## Set cursor position action

The Set cursor position field action in the Terminal Emulator package enables you to set the position of the cursor on the screen of the terminal.

### Settings

- Specify the **Terminal emulator session name** that you used to establish a connection with the terminal using the **Connect** .
- Specify the row number in which to set the cursor in the **Set row** field.
- Specify the column number in which to set the cursor in the **Set column** field.

---

**Note:** You can enter a value of 1 through 999 to specify the row and column number where the cursor is set.

---

## Using Set field action

Use the **Set field** action to set a value in a particular field in the terminal. This action also enables you to send predefined keys after the value to perform various operations in the terminal. You can use this action with the TN3270E, TN5250E, ANSI, and VT100 terminal types.

To set a value for a field in the terminal, do the following:

1. Double-click or drag the **Set field** action from the **Terminal Emulator** node in the **Actions** palette.
2. Enter the name of the session that you have used to establish a connection with the terminal using the **Connect** action in the **Terminal emulator session name** field.
3. Specify the field for which you want to set a value:
  - a) Select the **By index** option to specify the field based on its index.  
The index value starts from zero and ends at 99999. For example, if you want to set the value for the third field, you must specify 2 in this field.
  - b) Select the **By name** option to specify the location of the field.  
For example, if you want to set the value for a field in the fifth column of the third row, you must specify R3C5 in the field.
4. Specify the **Plain text value** you want to set in the specified field:
  - a) Click the **Credential** tab to select an entry from the Credential Vault.
  - b) Click the **Variable** tab to use a variable that contains the text you want to send.
5. Select the **Send enter key after setting field** check box if you want to send the enter key after setting the field.

This option performs the operation similar to pressing the Enter key after setting the value in the field.

6. Select the **Send a key after sending the above text** check box if you want to send a key after sending the text.
  - a) Select the key you want to send from the list.
  - b) Enter a value in the **Delay after send key command** field to specify the period (in milliseconds) the system must wait after sending the selected key.
7. In the **Assign value to variable** list, select a string variable.

## Set session variable action

---

**Note:** This action is no longer available for new bots. Existing bots using this action will not be impacted and will continue to run.

You can use a global session to specify a session name for use across multiple bots.

---

See

- [Sharing sessions across bots](#) on page 2503
- [Support and deprecation policy for packages](#) on page 1079 (for package lifecycle and deprecation policy)

## Show terminal action

The Show terminal action in the Terminal Emulator package enables you to show the terminal screen.

### Settings

This action enables you to show the terminal screen when the **Show terminal window** option from the **Connect** action is not selected. It is useful when you want to display the terminal screen when a bot is performing certain tasks. You must specify Specify the **Terminal emulator session name** that you used to establish a connection with the terminal using the **Connect** .

## Using Wait action

Use the **Wait** action to introduce a delay till specific conditions are met in the terminal. You can use this action to wait before executing the next action till the specific text appears on the screen, the cursor moves to the specified location, and so on. You can use this action with the TN3270E, TN5250E, ANSI, and VT100 terminal types.

To wait till specific conditions are met in the terminal, do the following:

1. Double-click or drag the **Wait** action from the **Terminal Emulator** node in the **Actions** palette.
2. Enter the name of the session that you have used to establish a connection with the terminal using the **Connect** action in the **Terminal emulator session name** field.

3. Select an option from the **Terminal event** list to specify a condition the system should wait till it is met.

The following table provides information about the options available in the list and the input required for each option:

Option	Input required
Wait till text appears	Waits until the text you specified in the <b>Text</b> field matches with the last line of the screen in the terminal.
Wait till text disappears	Waits until the text you specified in the <b>Text</b> field does not match or disappears on the last line of the screen in the terminal.
Wait till cursor moves to position	Waits till the cursor moves to the position you have specified in the <b>Move to row</b> and <b>Move to column</b> fields.  <b>Note:</b> You can enter a value of 1 through 999 to specify the row and column number where the cursor is set.
Wait till cursor moves out of position	Waits till the cursor moves out of the position you have specified in the <b>Move out of row</b> and <b>Move out of column</b> fields.  <b>Note:</b> You can enter a value of 1 through 999 to specify the row and column number where the cursor is set.
Wait till screen gets blank	No input required.
Wait till screen contains text	Waits till the text you have specified in the <b>Text</b> field is available on the screen of the terminal.
Wait till terminal prompt appears	No input required.
Wait till terminal ready state	No input required.

4. Enter a value in the **How long you would like to wait?** field to specify the period (in milliseconds) the system must wait before the operation times out.
5. In the **Assign value to variable** list, select a string variable.

## Share session between Task Bot logic

Use the **Shared Session** option in the Terminal Emulator package to pass the exact state of an application to the concurrently occurring Task Bot logic.

Shared session enables you to reuse actions between Task Bots that run concurrently, for example, connecting to the same application.

To use shared session, create a hierarchy of Task Bot logic that are connected by the **Shared Session** option. As a result, large Task Bot logic are trimmed by removing repetitive commands for connecting and disconnecting.

1. Create a parent bot such as TE\_Share\_Main that connects to an application on the Terminal Emulator.
2. Use the **Set session variable** action in the TE\_Share\_Main to assign the current session to a variable such as \$te\_session\$ of Terminal Emulator session type.
3. Create a child bot such as TE\_BMIS to perform any actions such as **Get text** and **Set field**.
4. Add a Run Task action in the TE\_Share\_Main to call the TE\_BMIS.
5. To pass a session variable from the TE\_Share\_Main to TE\_BMIS, select \$te\_session\$ as an input value in the **Set SessionVariable**.
6. In the TE\_BMIS, use **Shared session** tab and insert \$te\_session\$ as a session variable to obtain data or perform task.
7. In the main task, add an action to disconnect from the application.

## Text file package

Open a text file, read data from that file, and save the data to a string variable by using the **Text file** package. This package supports text files encoded in Shift-JIS, ANSI, UTF-16LE, UTF-16BE, Win 1521, Unicode, and UTF-8 and can extract content up to 64kb from text files.

### Actions in the Text file package

The Text file package includes the following actions:

Action	Description
Get text	See <a href="#">Using Get text action of Text file package</a> on page 3134
Read variables	See <a href="#">Read variables action</a> on page 3135

Related reference

[Text file package updates](#) on page 966

Review the updates in released versions of packages such as new and enhanced features as well as fixes and limitations. The page also lists the release dates of each version, and the compatible Control Room and Bot Agent versions.

## Using Get text action of Text file package

Extract content from a text file and save that content to a string variable by using the **Get text** action.

To extract text from a text file, perform the following steps:

1. In the **Actions** palette, double-click or drag the **Get text** action from the **Text file** package.
2. In the **Source file** field, select an option to specify the location of the text file:
  - **Control Room file** to open a file from the Control Room.

- **Desktop file** to open a file from the device. This field also accepts the file path input as a string variable or global value.
  - **Variable** to open a file by specifying a file variable.
3. In the **Text encoding** field, select an encoding to specify the encoding that is applied on the text file. Data from the text file will be retrieved based on the selected encoding option even if the input file has a different encoding.
- **ANSI**
  - **UTF8**
  - **UTF8 with BOM**
  - **UNICODE**
  - **Win1251**
  - **UTF-16LE**
  - **UTF-16BE**
  - **Shift-JIS**
  - **Detect automatically**: identifies file encoding. This option supports UTF-8 with BOM, ANSI, UTF-16LE, and UTF-16BE file encoding.
4. Select the **Trim leading spaces** and **Trim trailing spaces** check boxes to remove the leading and trailing spaces from the data extracted from the text file.
5. In **Save the outcome to variable** field, select a string variable to hold the output.

## Read variables action

Use the **Read variables** action in the Text file package to read the values of variables from the text file.

The layout of the text file that can be imported must be like one of the following samples:

- Var1=This is sample English text
- Var2 = test
- Var3 = Tst3

## Settings

- In the **Source file** field, click one of the following tabs to specify the location of the text file:
  - **Variable**: To open the source text file using a variable.
  - **Control Room file**: To open the source text file from the Control Room.  
Click **Choose** to **Search**, **Browse** or **Upload** a text file from Control Room.
  - **Desktop file**: To open the source text file from your local device.  
Click **Browse** to upload the text file. This field also accepts the file path input as a string variable or global value.
- Click the **Text encoding** drop-down menu and select one of the following encoding type to apply on the text file:
  - **Detect automatically**: Identifies the file encoding. This option supports UTF-8 with BOM, ANSI, UTF-16LE, and UTF-16BE file encoding.

- **ANSI**
- **UTF-8**
- **UTF-8 with BOM**
- **UTF-16LE**
- **UTF-16BE**
- **Unicode**
- **Shift-JIS**
- **Windows 1251**

Data from the text file is retrieved based on the selected encoding option even if the input file has a different encoding.

- Select the **Trim leading spaces** check box to remove the leading space in the data extracted from the text file.
- Select the **Trim trailing spaces** check box to remove the trailing space in the data extracted from the text file.
- Select the **Convert dictionary keys to lower case before assignment to variables** check box to convert all the keys to lower case.

---

**Note:** When you select this option, ensure that you enter the key in lower case in the **Mapped variables** table.

---

- From the **Save the outcome to variable** field, click one of the following tabs to contain the output:
  - **Multiple variables:** Click **Add variable mapping** to associate each dictionary key with a variable.  
Use this option to avoid using actions to extract the dictionary values.
  - **Dictionary:** Insert or create a dictionary variable to contain the output variables and values in key-value pairs.

## Trigger loop package

The **Trigger loop** package enables you to run a series of actions when a trigger event occurs. You can insert multiple trigger loops within a bot or nest one trigger loop within another trigger loop.

### Actions in the Trigger loop package

Action	Description
<b>Trigger loop</b>	<p>Opens the loop to run a series of actions when a trigger event occurs.</p> <hr/> <p><b>Note:</b> Events within the <b>Trigger loop</b> follow a sequential order and any parallel events that occur during this time are queued.</p> <hr/>



Action	Description
<b>Handle</b>	<p>Specifies the trigger event and runs the actions that are inside the container when that event occurs.</p> <p>Drag the <b>Handle</b> action into the <b>Trigger loop</b> (in <b>Flow</b> view) or below the <b>Trigger loop</b> (in <b>List</b> view).</p>
<b>Break</b>	<p>Terminates the trigger loop for bot to continue with other actions in the trigger event. If there is no <b>Break</b> action after a trigger loop handle, the bot will go back to the start of the trigger loop and wait for the next configured action. So ensure you add the <b>Break</b> action to exit the trigger loop and move on to next action or else the bot will run indefinitely. For example, the <b>Break</b> action in a bot can be used when the user must close or cancel a form.</p> <p>Drag the <b>Break</b> action into the trigger handle container.</p>

### Triggers in the Handle action

Triggers	Description	Options
Email Trigger	Triggers that starts the bot when an email is sent or received.	<a href="#">Using Email Trigger in Trigger loop Handle</a> on page 3138
File Trigger	Triggers on a file event.	<a href="#">Using File Trigger in Trigger loop Handle</a> on page 3142
Folder Trigger	Triggers on a folder event.	<a href="#">Using Folder Trigger in Trigger loop Handle</a> on page 3143
Hot key Trigger	Triggers on a key press event.	<a href="#">Using Hot key Trigger in Trigger loop Handle</a> on page 3143
Form Trigger	<p>Trigger on form element events.</p> <p><a href="#">Using interactive forms</a> on page 3292</p> <hr/> <p><b>Note:</b> If an active form is terminated using the <b>Close</b> button from the task bar, it will not terminate the associated bot containing <b>Trigger loop</b> and <b>Interactive forms</b> packages.</p> <hr/>	<a href="#">Using Form Trigger in Trigger loop Handle</a> on page 3144

Triggers	Description	Options
Object Trigger	<p>Trigger for the bot to start when the Select main event takes place on the trigger interface element. (Users click a button)</p> <hr/> <p><b>Note:</b> Interface triggers for objects are available only for native Windows applications.</p> <hr/>	<a href="#">Using Object Trigger in Trigger loop Handle on page 3144</a>
Microsoft 365 Outlook Email Trigger	Trigger that starts the bot when an email is received by connecting to the Microsoft 365 Outlook server with OAuth2 authentication.	<a href="#">Using Microsoft 365 Outlook trigger in Trigger loop: Handle on page 3145</a>
Process Trigger	Trigger that starts the bot on a process event.	<a href="#">Use Process Trigger in Trigger loop Handle on page 3146</a>
Service Trigger	Trigger that starts the bot when service start, stop, pause, and resume.	<a href="#">Using Service Trigger in Trigger loop Handle on page 3146</a>
ServiceNow New Record Trigger	New record trigger for ServiceNow .	<a href="#">Using ServiceNow New Record Trigger in Trigger loop Handle on page 3147</a>
ServiceNow Updated Record Trigger	Update record trigger for ServiceNow .	<a href="#">Using ServiceNow Updated Record Trigger in Trigger loop Handle on page 3148</a>
Window Trigger	Trigger that starts the bot based on window actions.	<a href="#">Using Window Trigger in Trigger loop Handle on page 3149</a>

#### Related tasks

[Add a form to bot on page 3292](#)

Adding an existing form to a bot enables users to collaborate with bots. Use the necessary action items to create a bot and build a task logic.

## Using Email Trigger in Trigger loop Handle

You can use the email trigger to start the bot when an email is sent or received.

In Automation Workspace, you added the **Trigger loop Handle** to your bot.

1. In the **Trigger loop Handle**, select **Email** in the **Trigger on** field.  
A list of options for the email trigger will appear for you to configure.
2. Choose one of the following server types as the trigger for your incoming emails:

Server type	Steps

Microsoft Outlook

Click **Outlook**.

Microsoft Outlook is set as the email service and the bot is triggered when you receive a new email.

Email server

Click **Email server**.

- a)** Enter the email service **Host** information.

For example, if you are using Office365 as your email service, enter `Outlook.office365.com`.

- b)** Select **IMAP** or **POP3**.

IMAP and POP3 are protocols used to connect to the mail server that enables you to read your emails through an email client. By default **IMAP** is selected.

---

**Note:** The POP3 protocol has a known limitation where any new calendar invite can also trigger the bot.

---

- c)** **Use secure connection (SSL/TLS):**

This option is selected by default. This option enables you to use a secure connection with the mail server.

- d)** Enter the configured port number for your email server in the **Port** field.

- e)** Select one of the following user authentication methods to sign in to the email server:

- **Basic**

- **Credential:** Click **Pick** to select the stored **Username** and **Password**.

- **Variable:** Specify a variable.

- **Insecure string:** Enter the username and password.

- **OAuth 2.0 - Client credentials**

- Specify the unique client and tenant IDs generated when you registered the application in the Microsoft Azure portal.
- Specify the username you want to use to access the mail server.
- Specify the client secret that you generated for your app in the app registration portal.

For **Client ID**, **Tenant ID**, **Username** and **Client Secret**

- **Credential:** Use a value available in the credential

EWS server

Click **EWS server**.

a) From the **Microsoft Exchange Version** drop-down menu, select the version that your organization is using.

- Exchange Server 2013  
The Microsoft Exchange Server 2019 is now supported. Therefore, if your organization is using the Exchange Server 2013, 2016 or 2019 versions of the Microsoft Exchange Server, select **Exchange Server 2013**.
- Exchange2010\_SP2
- Exchange2010\_SP1
- Exchange2010
- Exchange2007\_SP1

For example, if you are using Microsoft Exchange Service Pack 2, select **Exchange2010\_SP2** as your email service.

b) Enter the domain name, for example, `smtp.office365.com`

c) Select one of the following user authentication methods to sign in to the email server:

- **Basic**
  - **Credential:** Click **Pick** to select the stored **Username** and **Password**.
  - **Variable:** Specify a variable.
  - **Insecure string:** Enter the username and password.
- **OAuth 2.0 - Client credentials**
  - Specify the unique client and tenant IDs generated when you registered the application in the Microsoft Azure portal.
  - Specify the username you want to use to access the mail server.
  - Specify the client secret that you generated for your app in the app registration portal.

For **Client ID**, **Tenant ID**, **Username** and **Client Secret** fields, choose from the following:

3. Specify a time in the **Check every** field for all the server types to set the trigger interval.  
The trigger interval for the bot is set to 120 seconds by default. You can also specify the minutes.

---

**Note:** The trigger interval that you have configured using the **Check every** drop-down menu does not depend on the number of emails received during the scheduled interval.

---

4. Specify an email event for the selected server type in the **Select Conditions** fields.
  - **Email from:** Specify the email addresses.
  - **Email subject contains:** Specify that an email contains a condition.
  - **Email without an attachment**
  - **Email with an attachment**
  - **Email in folder:** Specify an email in a folder.

---

**Note:** When you select the **Email subject contains** check box, the email trigger is executed depending on the following subject conditions:

- When the subject line is provided within double quotation marks (""), for example, "ABC spreadsheet", the trigger is executed only when the email subject has an exact match for the string provided within quotation marks.
- When multiple subject lines are separated by semicolons, for example, ABC spreadsheet; ABC project logs, the trigger is executed when the email subject matches any of the subject lines mentioned.

- 
5. Specify your variable in the **Assigned to** field.  
You can use this variable to retrieve various details about the email that triggered the bot, such as sender, recipient, subject, email content, date, action information, email server host, and port data.  
You can select from the following:
    - **Multiple variables**
    - **Record**
  6. Click **Save** to save your configuration.  
You have configured the email trigger for use with the trigger loop handle.

## Using File Trigger in Trigger loop Handle

You can use the file trigger to trigger on file events.

In Automation Workspace, you added the **Trigger loop Handle** to your bot.

1. In the **Trigger loop Handle**, select **File** in the **Trigger on** field.  
A list of options for the file trigger will appear for you to configure.
2. Select your file in the **File** field.
3. Specify the action in the **Start the bot when the file is** field.  
This option allows you to specify when your bot starts based on the modifications to your file.  
You can choose from when the file is **created**, **deleted**, **renamed**, or **modified**.
4. Optional: Select the **Also start if it already exists** to start an existing bot.

5. Optional: In the **Assigned to** field, specify a variable to assign variable to this file.
6. Click **Save** to save your configuration.  
You have configured the file trigger for use with the trigger loop handle.

## Using Folder Trigger in Trigger loop Handle

You can use the folder trigger to trigger on folder events.

In Automation Workspace, you added the **Trigger loop Handle** to your bot.

1. In the **Trigger loop Handle**, select **Folder** in the **Trigger on** field.  
A list of options for the folder trigger will appear for you to configure.
2. Select your folder in the **Folder** field.
3. Specify the action in the **Start the bot when** field.  
This option allows you to specify when your bot starts based on the modifications to your folder.  
You can choose from when the folder is **created**, **renamed**, or **deleted**. In addition, you can also select a file when it is **created**, **changed**, or **renamed**.
4. Optional: Select the **Monitor all folders under the folder path** option to monitor your folder.
5. Optional: Select the **Also start if it already exists** to start an existing bot.

---

**Note:** This additional option will only show for folders.

---

6. Optional: In the **Assigned to** field, specify a variable to assign variable to this folder.
7. Click **Save** to save your configuration.  
You have configured the folder trigger for use with the trigger loop handle.

## Using Hot key Trigger in Trigger loop Handle

You can use the Hot key trigger to trigger on key press events.

In Automation Workspace, you added the **Trigger loop Handle** to your bot.

1. In the **Trigger loop Handle**, select **Hot key** in the **Trigger on** field.  
A list of options for the Hot key trigger will appear for you to configure.
2. Select a modifier and key in the **Hot key** field.  
You can specify hot key with a list of available modifiers and keys that you can select.  
For modifiers

- **Win**
- **Ctrl**
- **Shift**
- **Alt**
- **AltGr**

For hot keys

- **Letters:** This spans from letters A to Z.
- **Numbers:** This spans from numbers 0 to 9.

- **Special Characters:** This is a variety of special characters.
  - **Controls:** This is a variety of keyboard controls from Esc key to volume controls.
  - **Numpad:** This is a variety of numpad keys.
  - **Function Keys:** This spans from F1 to F12 keys.
  - **Arrows:** This is a variety of directional keys.
  - **Multimedia Keys:** This is a variety of functions for the browser and volume.
3. Click **Save** to save your configuration.  
You have configured the hot key trigger for use with the trigger loop handle.

## Using Form Trigger in Trigger loop Handle

You can use the form trigger to trigger on form element events.

In Automation Workspace, you added the **Trigger loop Handle** to your bot.

1. In the **Trigger loop Handle**, select **Form** in the **Trigger on** field.  
A list of options for the form trigger will appear for you to configure.
2. Select a variable in the **Form name** field.  
You can create a new variable as well, where you specify the variable name, its use as in input or output, and upload an existing form.
3. Select a element variable in the **Form element** field.  
The list should be available for you to select when there is an element in your form.
4. Select an action in the **Select action trigger** field.
  - **Lost focus:** Button is clicked.
  - **Got focus:** Input field is clicked.
  - **Lost focus:** User leaves the input field.
  - **Changed value:** Check box or radio button status is changed.
  - **Value selected:** Check box is selected.
  - **Value unselected:** Check box is deselected.
5. Optional: In the **Assigned to** field, specify a variable to assign variable to this form.  
This assigns the value from the specified form element to this variable
6. Click **Save** to save your configuration.  
You have configured the form trigger for use with the trigger loop handle.

## Using Object Trigger in Trigger loop Handle

You can use the object trigger to start the bot when the Select main event takes place on the trigger interface element.

In Automation Workspace, you added the **Trigger loop Handle** to your bot.

1. In the **Trigger loop Handle**, select **Object** in the **Trigger on** field.  
A list of options for the object trigger will appear for you to configure.
2. Specify the window details the **Window detail**.  
There are three options you can choose.



- **Variable:** Select a window variable.

---

**Note:** This is the default option.

---

- **Application:** Select a preset, this can be your **Currently active**, **Desktop**, and **Taskbar**.
- **Browser:** Select a browser tab.

3. Select **Capture object** to start the capture.

4. Select an event type.

5. Click **Save** to save your configuration.

You have configured the object trigger for use with the trigger loop handle.

## Using Microsoft 365 Outlook trigger in Trigger loop: Handle

You can use the email trigger to start a bot when you receive an email after connecting to the Microsoft 365 Outlook server using the OAuth 2.0 authentication.

Ensure that in Automation Workspace, you have used the **Trigger loop** package to add the **Trigger loop** to your bot.

1. In the **Trigger loop**, select **Trigger loop: Handle**.

2. Click the **Trigger on** drop-down menu and select **Microsoft 365 Outlook Trigger > Email**.

3. Click the **Azure Cloud** drop-down menu and select one of the following options:

- **Azure Global:** For the Microsoft 365 Commercial version (login.microsoftonline.com)
- **Azure GCC High:** For the Microsoft 365 Government version (login.microsoftonline.us)

4. Use the **Check every** field to specify or set the trigger interval time.

The trigger interval for the bot is set to **120** minutes by default.

(Optional) Click the **Minutes** drop-down menu to change the value to **Seconds**.

5. Click the **Authentication mode** drop-down menu and select **Client Credentials**.

For more information on setting up OAuth 2.0 to use client credentials, see [Set up OAuth 2.0 using client credentials](#) on page 2857.

6. For the **Client ID**, **Tenant ID**, **Username** and **Client Secret** fields, select one of the following tabs:

- **Credential:** Click **Pick** to select a value from the credential vault.
- **Variable:** Specify a variable.
- **Insecure String:** Enter a value or click the **Insert a value** icon to select an existing variable.

7. (Optional) Use the **Select Conditions** field to select any or all of the following options for email events from the selected server type:

- **Email from:** Enter the email addresses or click the **Insert a value** icon to select an existing variable.
- **Email subject contains:** Enter a condition for the email subject line.

For example, you can enter 'Sales report' as a condition to trigger a bot when you receive any email that contains the subject line as 'Sales report'. You can also click the **Insert a value** icon to select an existing variable.

• **Email attachment:** Select one of the following email attachment options:

- **With attachment**

- **Without attachment**

- **Email in folder:** Enter the filepath of the email folder.

For example, if you want to trigger a bot when you receive an email in Microsoft 365 Outlook folder called 'Sales', enter `inbox/sales`. You can also click the **Insert a value** icon to select an existing variable.

8. Use the **Assigned to (optional)** field to select one of the following tabs:

- **Multiple variables:** Click **Add variable mapping** to associate a key with a variable.
- **Record:** Use the **Assigned to** drop-down menu to assign an existing variable or click the **Create variable** icon to create a variable that you want to assign.

---

**Note:** You can use this variable to retrieve various details about the email that triggered the bot, such as sender, recipient, subject, email content, date, action information, email server host, and port data.

---

9. Click **Save** to save your configuration.

Microsoft 365 Outlook is now configured within the trigger loop handle of a bot.

## Use Process Trigger in Trigger loop Handle

You can use the process trigger to trigger on process events.

In Automation Workspace, you added the **Trigger loop Handle** to your bot.

1. In the **Trigger loop Handle**, select **Process** in the **Trigger on** field.  
A list of options for the process trigger will appear for you to configure.
2. Select your process in the **Process** field.
3. Specify the action in the **Start the bot when the process** field.  
This option allows you to specify when your bot starts based on the modifications to your file.
  - **Starts**
  - **Stops**
4. Optional: In the **Assigned to** field, specify a variable to assign variable to this process.
5. Click **Save** to save your configuration.  
You have configured the process trigger for use with the trigger loop handle.

## Using Service Trigger in Trigger loop Handle

You can use the service trigger to start the bot when service start, stop, pause, or resume.

In Automation Workspace, you added the **Trigger loop Handle** to your bot.

1. In the **Trigger loop Handle**, select **Service** in the **Trigger on** field.  
A list of options for the service trigger will appear for you to configure.
2. Select your bot in the first field.
3. Specify the action in the **Start the bot when the service** field.

This option allows you to specify when your bot starts based on the modifications to your service.

- **Starts**
- **Stops**
- **Resumes**
- **Pauses**
- **Is running**
- **Has stopped**
- **Is paused**

4. Optional: In the **Assigned to** field, specify a variable to assign variable to this service.

5. Click **Save** to save your configuration.

You have configured the service trigger for use with the trigger loop handle.

## Using ServiceNow New Record Trigger in Trigger loop Handle

You can use the ServiceNow new record trigger to monitor a ServiceNow table for new records.

In Automation Workspace, you added the **Trigger loop Handle** to your bot.

1. In the **Trigger loop Handle**, select **ServiceNow > New Record Trigger** in the **Trigger on** field.

A list of options for the processServiceNow new record trigger will appear for you to configure.

2. Optional: Enter the API version in the **API version** field.

3. Specify the credential fields for **Client ID**, **Client secret**, **Username**, and **Password** fields.

- **Credential**: Select a credential in the credential vault.
- **Variable**: Specify a variable.
- **Insecure string**: Enter a string.

4. Enter the **Table name** to monitor for new records.

A query is sent, and ServiceNow returns data for this table. When a new record is returned in the data, then this trigger is invoked.

5. Optional: Select an input where the ServiceNow response is stored in the **Field names** field.

For **Variable**, specify a variable.

For **List**, the following can be selected:

- **Any**: Specify a value.
- **String**: Specify a value.
- **Number**: Specify a value.
- **Datetime**: Select the date, time, and time zone, or choose a **Variable**.
- **Boolean**: Select a **True** or **False** option, or choose a **Variable**.
- **File**: Specify a value for **Variable**, **Control room file**, or **Desktop file**

6. Optional: Specify the filter in the **Filter by records** field.

For **Query**, specify a query.

For **Number-value pair**, specify a dictionary or variable for **Dictionary** or add an entry for **Entry list**.

7. Specify a time in the **Check every** field to set the trigger interval.

The trigger interval for the bot is set to 120 seconds.

8. Specify your variable in the **Assigned to** field.

You can use this variable to retrieve various details about the email that triggered the bot, such as sender, recipient, subject, email content, date, action information, email server host, and port data.

You can select from the following:

- **Multiple variables**
- **Record**

9. Click **Save** to save your configuration.

You have configured the ServiceNow new record trigger for use with the trigger loop handle.

## Using ServiceNow Updated Record Trigger in Trigger loop Handle

You can use the ServiceNow updated record trigger to monitor a ServiceNow table for updated records.

In Automation Workspace, you added the **Trigger loop Handle** to your bot.

1. In the **Trigger loop Handle**, select **ServiceNow > Updated Record Trigger** in the **Trigger on** field.

A list of options for the processServiceNow new record trigger will appear for you to configure.

2. Optional: Enter the API version in the **API version** field.

3. Specify the credential fields for **Client ID**, **Client secret**, **Username**, and **Password** fields.

- **Credential**: Select a credential in the credential vault.
- **Variable**: Specify a variable.
- **Insecure string**: Enter a string.

4. Enter the **Table name** to monitor for new records.

A query is sent, and ServiceNow returns data for this table. When a new record is returned in the data, then this trigger is invoked.

5. Optional: Select an input where the ServiceNow response is stored in the **File names** field.

For **Variable**, specify a variable.

For **List**, the following can be selected:

- **Any**: Specify a value.
- **String**: Specify a value.
- **Number**: Specify a value.
- **Datetime**: Select the date, time, and time zone, or choose a **Variable**.
- **Boolean**: Select a **True** or **False** option, or choose a **Variable**.
- **File**: Specify a value for **Variable**, **Control room file**, or **Desktop file**

6. Optional: Specify the filter in the **Filter by records** field.

For **Sys\_id**, specify the ID

For **Query**, specify a query.

For **Number-value pair**, specify a dictionary or variable for **Dictionary** or add an entry for **Entry list**.

7. Specify a time in the **Check every** field to set the trigger interval.  
The trigger interval for the bot is set to 120 seconds.
8. Specify your variable in the **Assigned to** field.  
You can use this variable to retrieve various details about the email that triggered the bot, such as sender, recipient, subject, email content, date, action information, email server host, and port data.  
You can select from the following:
  - **Multiple variables**
  - **Record**
9. Click **Save** to save your configuration.  
You have configured the ServiceNow new record trigger for use with the trigger loop handle.

## Using Window Trigger in Trigger loop Handle

You can use the window trigger to start the bot base on window events.

In Automation Workspace, you added the **Trigger loop Handle** to your bot.

1. In the **Trigger loop Handle**, select **Window** in the **Trigger on** field.  
A list of options for the window trigger will appear for you to configure.
2. Select your application or variable in the **Window** field.
3. Specify the action in the **Window action that starts the bot** field.  
This option allows you to specify when your bot starts based on the modifications to your window.
  - **Open**
  - **Close**
4. Optional: In the **Assigned to** field, specify a variable to assign variable to this window.
5. Click **Save** to save your configuration.  
You have configured the window trigger for use with the trigger loop handle.

## V11 Task Bot package

The V11 Task Bot package enables you to run an Enterprise 11 bot from Automation 360 in the Enterprise 11 Control Room.

### Actions in the V11 Task Bot package

The package includes the following action:

Action	Description
Run	See <a href="#">Using Run action</a> on page 3150.

Related reference

[V11 Task Bot package updates](#) on page 968

Review the updates in released versions of packagesuch as new and enhanced features as well as fixes and limitations. The page also lists the release dates of each version, and the compatible Control Room and Bot Agent versions.

## Using Run action

Use the **Run** action to run an Enterprise 11 bot from Automation 360 in the Enterprise 11 Control Room.

Ensure that the Enterprise 11 user credential that you want to use to run the Enterprise 11 bot includes the following:

- Access to the Enterprise 11 Bot Runner device on which you want to run the Enterprise 11 bots
- **Run my bots** and **View my scheduled bots** permissions

To use the **Send callback status to A2019** option, ensure the following:

- The IP address of the Automation 360 Bot Runner device on which you want to run the Automation 360 bot is a static IP address
- The IP address is available in the callback URL of the Enterprise 11 Control Room

[Callback URLs for bot deployment](#)

1. Double-click or drag the **Run** action from the **V11 Task Bot** node in the **Actions** palette.
2. Provide the Enterprise 11 Control Room URL in which you want to run the bot.
3. Click the **Credential** tab to use a value from the Credential Vault and the **Variable** to use a credential variable.

Alternatively, click the **Insecure string** tab to manually specify the value you want to use as the **Username** and **Password** to log in the Control Room you have specified.

4. Specify the location of the bot you want to run in the **Task relative path** field.
5. Optional: Specify the device on which you want to run the bot in the **Bot Runner device name** field.

You can specify multiple devices separated by a semicolon. Ensure that the names of the devices you have provided are the same as those on the **My Devices** page of the Enterprise 11 Control Room.

If you do not provide any value in the field, the system runs the bot on any connected devices (device for which the user specified in the Step 3).

6. Select the **Run bot runner session on Control Room** check box to deploy the bot using the remote desktop process.
7. Select the **Wait for task to complete** check box if you want the system to wait for the task to complete before performing the next action in the bot.
  - a) Specify the period you want the system to wait before the bot is timed out in the **Total wait time** field.
  - b) Select the version of the Control Room on which you want to run the bot.

- 11.3.2 or later (includes 11.3.3.x releases):

Click **Advanced settings** to expand and update the polling attributes.

Field	Description
Wait time before start polling the status	Period (in seconds) you want the system to wait before it starts polling the status after the bot is deployed on the device.
Polling interval for non-started execution	Time interval at which you want the system to poll for status for the Enterprise 11 bot you have set to run but has not started execution.
Polling interval for pending execution	Time interval at which you want the system to poll for status for the bot that you have set to run and is pending execution.
Polling interval for paused execution	Time interval at which you want the system to poll for status for the bot that has started execution and is paused.
Polling interval for in-progress execution	Time interval at which you want the system to poll for status for the bot that has started execution and is currently in progress.
Polling interval for unknown execution	Time interval at which you want the system to poll for status for the bot that has started execution and the current status is unknown.

- 11.3.4 or later:
  - Select the **Send callback status to A2019** option to specify a range for the TCP port that you want to use to send the callback status to Automation 360.

Field	Description
From available TCP port	Starting value in the range for the TCP port that you want to use to send the callback status.
To available TCP port	End value in the range for the TCP port that you want to use to send the callback status.

---

**Note:** The IP address of the Automation 360 Bot Runner must be reachable from Enterprise 11 Control Room on the range for the TCP port you have provided.

---

- Select the **Poll status from 11.x Control Room** option. Click **Advanced settings** to update the polling status from the Enterprise 11 Control Room:

Field	Description
Wait time before start polling the status	Period (in seconds) you want the system to wait before it starts polling the status after the bot is deployed on the device.
Polling interval for non-started execution	Time interval at which you want the system to poll for status for the Enterprise 11 bot you have set to run but has not started execution.
Polling interval for pending execution	Time interval at which you want the system to poll for status for the bot that you have set to run and is pending execution.
Polling interval for paused execution	Time interval at which you want the system to poll for status for the bot that has started execution and is paused.
Polling interval for in-progress execution	Time interval at which you want the system to poll for status for the bot that has started execution and is currently in progress.
Polling interval for unknown execution	Time interval at which you want the system to poll for status for the bot that has started execution and the current status is unknown.

8. Select the dictionary variable from the **Input parameters** list that you want to use to pass input parameters for the bot.

The input variables that you want to pass for the bot are contained as keys in the dictionary variable with their corresponding values.

9. Select the dictionary variable that you want to use to store the output from the **Assign the output to** list.

The dictionary variable stores the output parameters of the Enterprise 11 bot as keys.

Additionally, the following keys are added in the dictionary variable by default:

Key	Value
COMMAND	Name of the command that was last executed by the Enterprise 11 bot.
STATUS	Status of the Enterprise 11 bot execution.
START_TIME	Time when execution of the Enterprise 11 bot started.



Key	Value
END_TIME	Time when execution of the Enterprise 11 bot ended.
AUTOMATION_NAME	Name of the automation

10. Click **Save**.

## VBScript package

The VBScript package contains actions that enable VBScript functions in a task.

### Before you start

1. Verify that the device on which you want to run the VBScript has Windows operating system installed.
2. Open a VBScript file, or input the script you want to run using the **Open** action. You must associate the details of the file or script you want to run with a session name. Use this same session name for other VBScript actions.
3. Use the **Run function** action to execute a function within the script or execute the entire script. You must use the VBScript session name you established in the previous step.
4. After you have executed the script, close the VBScript session.

To review the bot launcher logs, navigate to `C:\ProgramData\AutomationAnywhere\BotRunner\Logs\<current month>\Bot_Launcher-<today's date>.log.zip`. Each zipped folder contains a file with data on the code execution, which is useful for debugging.

### Actions in the VBScript package

The VBScript package includes the following actions:

**Note:** The **Open** action must be the first action to use the VBScript in a task.

Action	Description
Close	See <a href="#">Close action in VBScript</a> on page 3154.
Run function	See <a href="#">Run function action in VBScript</a> on page 3154.
Open	See <a href="#">Open action in VBScript</a> on page 3155.

Related tasks

[Example of using the VBScript package in a resilient bot](#) on page 3250

Build a bot that executes a Microsoft Visual Basic script. Use the Try/Catch package to gracefully end the bot if it fails, making it resilient to crashes. A resilient bot allows scheduled and queued bots to continue even if the current bot encounters an error.

Related reference

[VBScript package updates](#) on page 969

Review the updates in released versions of the VBScript package such as new and enhanced features as well as fixes and limitations. The page also lists the release dates of each version, and the compatible Control Room and Bot Agent versions.

## Close action in VBScript

This action enables you to close the session in VBScript.

### Settings

Closes the session.

Specify the same session name from the **Open** action in VBScript.

## Run function action in VBScript

You can run a function within VBScript using the Run function action.

### Settings

Runs a function within the VBScript.

- In the VBScript **session** field, specify a session name. Use the same session name from the **Open** action in VBScript.
- Optional: Specify the function name to run and the arguments to pass to the function.

---

**Note:** You can pass only a list variable as an argument for the function. You can use the list variable to pass multiple arguments of different data types such as Boolean, datetime, number, and string.

- Optional: If the specified function returns a value, specify the variable to store that value in the **Assign the output to variable** field. The shows a descriptive default variable name. If you create several output variables, subsequent variable names are appended with a -1, -2, -3, and so on to avoid duplication.

---

**Note:** In VBScript, stand alone scripts do not return a value.

---

See the following video to understand how to use VBScript package.

## Open action in VBScript

This action enables you to open a VBScript file.

### Settings

Opens a VBScript file.

- In the VBScript **session** field, specify a session name. Use this same session name for other VBScript actions.
- In the VBScript , choose one of the following options:
  - In the **Import existing file** option, select an existing VBScript file.

---

**Note:** If you are uploading a script from a file on your desktop, the file and any dependencies must be in a standalone folder. When you select a file for upload, all files and folders at the same folder level are uploaded.

---

- In the **Manual input** option, enter the VBScript.

## Wait package

Use the actions in the Wait package to add a condition to wait for an application screen to change, or a separate window to open or close before proceeding to the next action.

### Actions in the Wait package

The Wait package includes the following actions:

Action	Description
Wait for condition	See <a href="#">Wait for condition action</a> on page 3156
Wait for screen change	See <a href="#">Using Wait for screen change action</a> on page 3157.
Wait for window	See <a href="#">Using Wait for window action</a> on page 3160.

Related reference

[Wait package updates](#) on page 970

Review the updates in released versions of the Wait package such as new and enhanced features as well as fixes and limitations. The page also lists the release dates of each version, and the compatible Control Room and Bot Agent versions.

## Wait for condition action

Makes the bot wait until a specific condition is true before executing the next action.

### Settings

In the **Wait till** field, specify the condition to meet. For example, the wait condition can be based on whether an application is running, a folder or file exists, a variable matches the specified value, an application window exists, or a machine or server is running.

---

#### Note:

- If a bot encounters an internal error that does not appear on the UI, it does not wait for the amount of time that is specified in this action. The bot does not stop and continues to the next line.
- When you create a bot and use the variable option to search the window title and use the condition **Window exists**, or **Window does not exist** the bot will not search for the changed window title. Also, it will not identify the window title if you have changed the variable. You can use the condition **Window with same title does not exist**, or **Window with same title exist** to verify whether a window with the same title exists or changed.

---

When you use the **Object does not exist** condition to verify whether a specific object exists in a window, and if the object exists, the result of the condition will be false. In this scenario, the bot keeps waiting until the specified condition is true, that is, the bot waits till the object does not exist in a window and then executes the next action.

---

**Note:** The value that you enter in the **Keep trying for (seconds)** field when you select Recorder conditions is not the wait time for the specified condition. This time is a timeout to search an object from the window. For example, if you specify a value of 15 seconds in the field, then the Recorder will take a maximum of 15 seconds to send the result to the **Wait for condition** action, that is whether the object exists in a window.

---

This action offers the same conditions as the If package. See the [If package](#) on page 2724.

### Group conditions

Use the **Add group** option to add multiple Boolean conditions or combine more than one conditions with **And** and **Or** options within a group and when you want the bot to check multiple conditions at a time before executing a set of actions.

You can also add a group within a group.

## Using Wait for screen change action

Use the **Wait for screen change** action to wait for the content of a specific screen or the entire window to change before executing the next action.

For example, a Human Resources (HR) personnel automating leave-management tasks wants to log in to the HR portal. After entering the user credentials, this action enables the automation task to wait until the next screen loads.

1. In the **Actions** palette, double-click or drag the **Wait for screen change** action from the Wait package.
2. In the **Screen change relative to** field, choose **Window** or **Screen**.
3. Select an application window:

Option	Steps
<p>Application</p>	<p>From the drop-down list, select the window title from the open applications.</p> <ul style="list-style-type: none"> <li>The <b>Window title</b> field displays the title of the application window you have selected.</li> </ul> <p>Insert a wildcard character (*) in the <b>Window title</b> field to search for window titles that can change. You can specify one or more wildcards (*) at the start, middle, or end of the value. For example, to perform an operation on any window that has Microsoft in the title, use a wildcard to indicate any string by adding it before or after the value: *Microsoft*. The first searches for the exact window title (Microsoft), and if it does not find a match, it searches for windows with the term Microsoft anywhere in the title.</p> <p>You can use a regular expression (regex) to identify a window title. Select the regular expression condition as either <b>String</b> or a <b>Pattern</b> and then enter the value. By default, the <b>Window title</b> field is case-sensitive.</p> <p>To identify a browser title, you can enable the <b>Case sensitive</b> option to match the letter case, or disable the option to identify a window title where the letter case does not match.</p> <hr/> <p><b>Note:</b> Ensure that the minimum version installed on your system is the version that was released with v.26. If you have a version released with v.25 or earlier, then by default, the window title will be identified only with matching letter case (case-sensitive).</p> <hr/> <p>For example, you can enter the <b>String</b> value as ((\w*)-Notepad for all window title names starting with ((\w*)-Notepad, or use <b>Pattern</b> value as ((\w)\s)*document-Notepad for only those window titles that match this pattern.</p> <hr/> <p><b>Note:</b></p> <ul style="list-style-type: none"> <li>When you use a regular expression of type <b>String</b> with -title as the input value for a window title in any , the might encounter a run time</li> </ul>

input as ^-title, the application with the specific title is open. The asterisk (\*) is just a character, not a wild card

Option	Steps
Browser	Select from a list of supported browser tabs.  <b>Note:</b> This option supports , Chromium-based , and browsers.
Variable	Use a window variable to specify the application window you want to use.

4. Optional: Select the **Resize window** option to specify the window dimensions. This option delivers a more reliable bot. It resizes the window to the dimensions at which the task was recorded, which enhances the ability of the bot to identify the target object.
- If the window is maximized when you record the task, this option is not selected.
  - If the window is not at the maximum size when you record the task, this option is selected, by default, and the width and height fields are automatically filled with the dimensions of the window.

---

**Note:** This option is available only for windows that can be resized. It is not available for the **Desktop** or **Taskbar** options.

---

5. Click **Capture region** to select the area on the specific window. The selected window appears.
6. Drag the mouse to draw a rectangle around the region that you want to capture and right-click when done. The captured area appears in the **Preview** section, followed by the image coordinates **X, Y, Width, and Height**.

---

**Note:** After you capture the specific area, the action waits for the content in the captured area to change before executing the next action.

---

7. In the **How long to wait before comparing screens?** field, specify the wait time (in seconds) to begin comparing the window or screen. When a difference is detected, the comparison stops and the task proceeds to the next action.
8. In the **How long to wait before screen comparing is stopped?** field, specify the wait time (in seconds) for the screen to change. If the screen does not change within the time you specified, the task proceeds with the next action.
9. Select the **Throw an exception if the screen is not changed** option to show an error message and terminate the bot if the screen does not change. If the option is deselected and the screen does not change, the task proceeds with the next action.
10. Click **Save**.

## Using Wait for window action

Use the **Wait for window** action to wait for the specified window to open or close before executing the next action.

For example, a Human Resources (HR) personnel automating leave-management tasks might require the attendance application to open before they enter the user credentials. This action enables the automation task to wait until the application window opens.

1. In the **Actions** palette, double-click or drag the **Wait for window** action from the Wait package.
2. In the **Wait for window** field, select the option you want the automation to wait for:
  - **Wait for window to open**
  - **Wait for window to close**
3. Select an application window:



Option	Steps
<p>Application</p>	<p>From the drop-down list, select the window title from the open applications.</p> <ul style="list-style-type: none"> <li>The <b>Window title</b> field displays the title of the application window you have selected.</li> </ul> <p>Insert a wildcard character (*) in the <b>Window title</b> field to search for window titles that can change. You can specify one or more wildcards (*) at the start, middle, or end of the value. For example, to perform an operation on any window that has Microsoft in the title, use a wildcard to indicate any string by adding it before or after the value: *Microsoft*. The first searches for the exact window title (Microsoft), and if it does not find a match, it searches for windows with the term Microsoft anywhere in the title.</p> <p>You can use a regular expression (regex) to identify a window title. Select the regular expression condition as either <b>String</b> or a <b>Pattern</b> and then enter the value. By default, the <b>Window title</b> field is case-sensitive.</p> <p>To identify a browser title, you can enable the <b>Case sensitive</b> option to match the letter case, or disable the option to identify a window title where the letter case does not match.</p> <hr/> <p><b>Note:</b> Ensure that the minimum version installed on your system is the version that was released with v.26. If you have a version released with v.25 or earlier, then by default, the window title will be identified only with matching letter case (case-sensitive).</p> <hr/> <p>For example, you can enter the <b>String</b> value as ((\w*)-Notepad for all window title names starting with ((\w*)-Notepad, or use <b>Pattern</b> value as ((\w)\s)*document-Notepad for only those window titles that match this pattern.</p> <hr/> <p><b>Note:</b></p> <ul style="list-style-type: none"> <li>When you use a regular expression of type <b>String</b> with -title as the input value for a window title in any , the might encounter a run time</li> </ul>

input as ^-title, the application with the specific title is open. The asterisk (\*) is just a character, not a wild card

Option	Steps
Browser	Select from a list of supported browser tabs.  <b>Note:</b> This option supports , Chromium-based , and browsers.
Variable	Use a window variable to specify the application window you want to use.

4. In the **How long you would like to wait for this condition to be true?** field, specify the wait time (in seconds) for the window to open or close.  
If the window does not open or close within the time you specify, the task proceeds to execute the next set of actions.
5. Select the **Throw an exception if wait for window is unsuccessful** option to show an error message and terminate the bot if the window does not open or close within the specified amount of time.  
If the option is deselected and the window does not open or close within the specified amount of time, the task proceeds with the next action.
6. Click **Save**.

## Workday package

Workday is a leading provider of enterprise cloud applications that helps organizations manage various HR, finance, and business processes, including payroll, and more. The Automation 360 Workday package uses the Workday Web Services (set of SOAP APIs) to read and write data in and out of Workday.

### Note:

The Workday mark and logo are trademarks or registered trademarks of Workday and are used for identification purposes only.

The Workday package has a deep API-level integration with Workday that allows you to build automations and eliminates the need to program. It is aimed at automating Workday processes like reporting, data upload/download, or triggering work flows. To start interacting with Workday, use the authenticate action from the Workday package to authenticate from Automation 360. After you authenticate, you can retrieve reports, launch EIB (Enterprise Interface Builder), and get integration status using various actions in the Automation Anywhere Control Room. The following diagram provides an overview of the actions performed between Automation 360 and Workday:

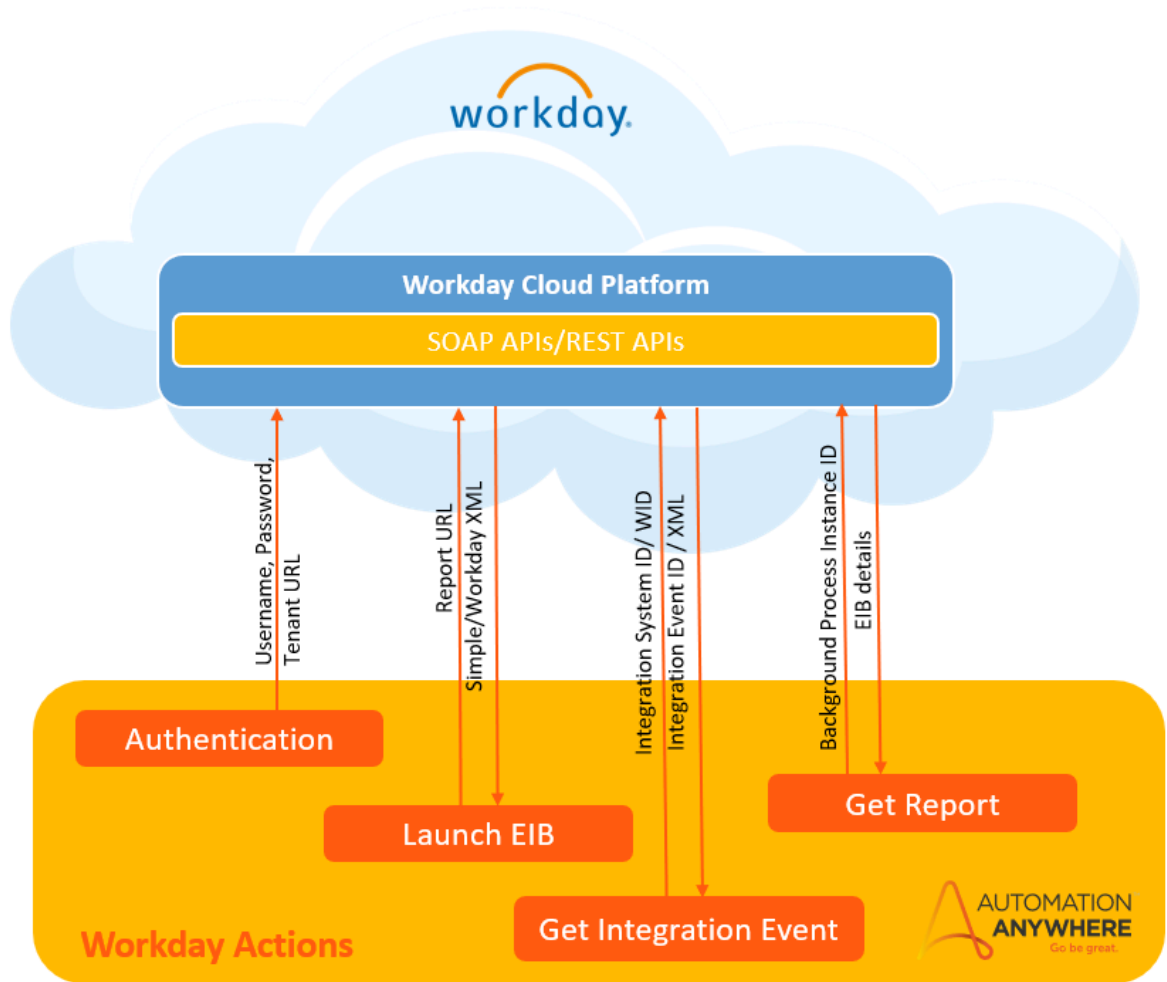

The following video shows how Workday can be used along with ServiceNow to automate a use case where HR creates the open positions in Workday by launching an Enterprise Interface Builder (EIB) from Automation 360:

Related reference

[Workday package updates](#) on page 973

Review the updates in released versions of the Workday package such as new and enhanced features as well as fixes and limitations. The page also lists the release dates of each version, and the compatible Control Room and Bot Agent versions.

## Workday Authentication action

Workday Authentication action is the first command action that you need to call to get authenticated with your Workday instance.

**Note:** The examples and graphics provided on this page are for representation purposes only and may not accurately reflect your specific instance. We do not assume responsibility for their maintenance or accuracy.

- To authenticate to Workday, you need to know your Environment base URL (domain), Tenant ID, Username, and Password.
- Log in to the Workday as an admin. For more information on logging in to a Workday instance, see [Workday Login](#).
- To find the base URL (domain) and tenant of your Workday environment, search for View API Clients. You will be able to derive the base URL from the Workday REST API Endpoint field. The format is `https://{domain}.workday.com/ccx/api/v1/{tenant}`.
  - The base URL is `https://{domain}.workday.com/`. For example, if the Workday REST API Endpoint is `https://wd2-impl-services1.workday.com/ccx/api/v1/yourtenant_abc`, your base URL is `https://wd2-impl-services1.workday.com`

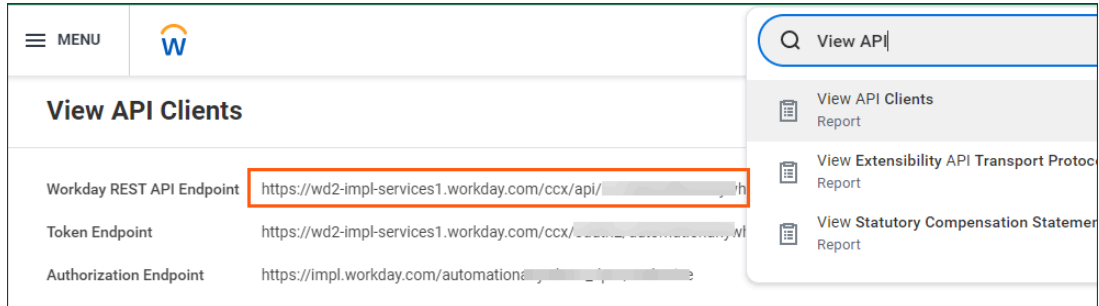

- The tenant is derived from the Workday REST API Endpoint field as well. For example, if the Workday REST API Endpoint is `https://wd2-impl-services1.workday.com/ccx/api/v1/yourtenant_abc`, your tenant is `yourtenant_abc`

- Create a new .
  - Log in to your instance of the .
  - On the left panel, click **Automation**.
  - Click **Create new > Bot**.
  - In the **Create Task Bot** window, enter the name.
  - Accept the default folder location: `\Bots\`  
To change the default storage location, click **Choose** and follow the prompts.
  - Click **Create and edit**.
- From the Actions pane, select **Workday > Authentication** and place it under the **Start** of the bot flow.
  - In the **Environment** field, enter the **base URL** copied from Workday.
  - In the **Tenant** field, paste the **tenant** copied from Workday.
  - Enter the Workday Username. Select one of the following options to specify the **Username**:
    - Credential**: Enables you to use a value available in the Credential Vault that contains information about the Username/Password. For more information on creating a credential, see [Set up lockers and credentials in Credential Vault](#) on page 1862.
    - Variable**: Enables you to use a credential variable that contains information about the Username/Password. For more information on creating a variable, see [Credentials and credential variables in the Bot editor](#) on page 2344.

- **Insecure string:** Enables you to manually enter the Username/Password for the Workday Authentication.
- d) Enter the Workday Password. Select one of the following options to specify the **Password:**
- **Credential:** Enables you to use a value available in the Credential Vault that contains information about the Username/Password. For more information on creating a credential, see [Set up lockers and credentials in Credential Vault](#) on page 1862.
  - **Variable:** Enables you to use a credential variable that contains information about the Username/Password. For more information on creating a variable, see [Credentials and credential variables in the Bot editor](#) on page 2344.
  - **Insecure string:** Enables you to manually enter the Username/Password for the Workday Authentication.
- e) Enter Default as the session name or create a session of type **Workday Session**.

The screenshot displays the Automation Anywhere Bot Editor interface. On the left, the 'Actions' pane shows the 'Workday' category with 'Authentication' selected. The central canvas shows a workflow starting with 'Start', followed by 'Workday: Authentication' (step 1), 'Workday: Get Report' (step 2), and 'Message box' (step 3). The right-hand pane is titled 'Workday: Authentication' and contains the following configuration fields:

- Environment:** `https://wd2-impl-services1.workday.com/` (labeled 'a')
- Tenant:** `auton` (labeled 'b')
- Username:** `Credential` (labeled 'c')
- Password:** `A` (labeled 'd')
- Create Workday session:** `Local session` (labeled 'e')
- Local session name:** `Default` (labeled 'e')

## Workday Launch EIB action

With the Workday Launch EIB(Enterprise Interface Builder) action, you can invoke an inbound or an outbound EIB using the IntegrationSystemID or WorkdayID. An EIB is a tool to get data out of Workday (Outbound EIB) or get data into Workday (Inbound EIB)

**Note:** The examples and graphics provided on this page are for representation purposes only and may not accurately reflect your specific instance. We do not assume responsibility for their maintenance or accuracy.

Ensure that you are authenticated before initiating any Workday action. For more details, see [Workday Authentication action](#). You have the option to launch Inbound or Outbound EIB. Below are the prerequisites for each of these options:

- For Inbound Workday EIBs - Use to load data into your Workday system by downloading EIB template as a file attachment or file transfer from the Control Room. For example, sending an employee record file with the employee's details to Workday creates a new record entry.
  - Log in to Workday as an admin. For more information on logging in to a Workday instance, see [Workday Login](#).
  - Open the EIB you want to launch.
  - To get the Integration System ID or WID of the EIB, navigate to **Actions > Integration IDs > View IDs**.

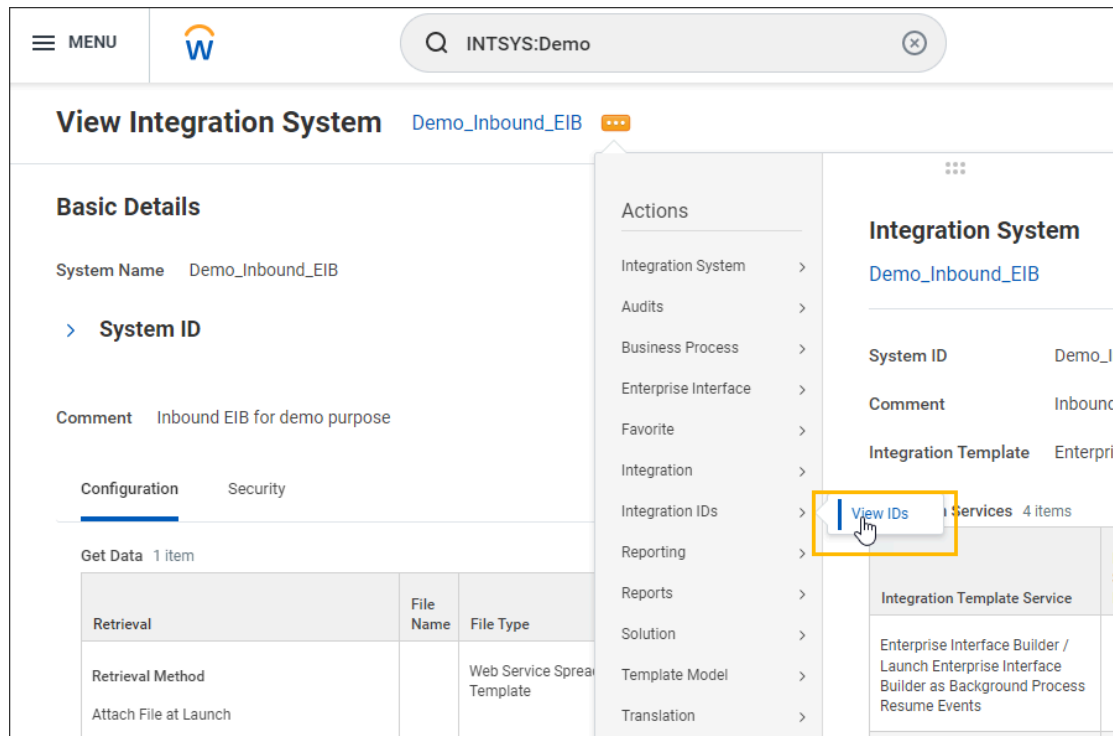

The **Integration IDs** page appears with the Workday ID (WID) and Integration System ID.

- Copy either the Workday ID (WID) or Integration System ID.
1. For Outbound Workday EIBs - Use to export data from custom reports. You can use Outbound EIBs for simpler integrations. For example, when one data source is used (typically a report) and the transformation is simple enough to be done with a single custom transformation (XSLT) or Custom Report Transformation. For example, extracting employee salary information from Workday in order to send it to a 3rd party payroll system.
1. In the Automation Anywhere Control Room, navigate to the **Actions** pane, select **Workday > Launch EIB**, and place it in the canvas.

- a) From the **Type of ID** drop-down select either the Workday ID (WID) or Integration System ID.
  - b) In the **ID** field, paste either the Workday ID (WID) or Integration System ID copied from Workday.
  - c) Select the **Type of integration**. Automation 360 supports launching both **Inbound** and **Outbound** integrations.
  - d) For the **Inbound** integration, you need to provide the integration template. For more information, see [Workday Launch EIB](#). The **Outbound** integration does not require a template.
  - e) Enter Default as the session name, or create a session of type **Workday Session**.
  - f) The Launch EIB action returns the Integration event ID. You can save it as a variable defined in **Integration event ID (optional)**.
  - g) The Launch EIB action also returns Details of the integration. You can save it as a variable defined in **Details (optional)**.
2. Verify that you can run the bot and launch an EIB. The following video will launch an EIB in Workday from Automation Anywhere Control Room. The video shows how the Workday status changes from Processing to Completed which confirms that the EIB has been successfully launched.

---

**Tip:** Use the Integration Event ID in [Workday Get Integration Event](#) action on page 3168 to get the current status of the integration.

---

## Workday Get Integration Event action

You can use the **Get Integration Event** to monitor the progress of an EIB or other integrations in a Workday instance.

**Note:** The examples and graphics provided on this page are for representation purposes only and may not accurately reflect your specific instance. We do not assume responsibility for their maintenance or accuracy.

Ensure that you are authenticated before initiating any Workday action. For more details, see [Workday Authentication action](#). Below are the prerequisites for the **Get Integration event**:

- Log in to the Workday as an admin. For more information on logging in to a Workday instance, see [Workday Login](#).
- Open the EIB that contains the event you want to monitor.
- To review the Background Process Instance ID or WID of an EIB event:
  1. Navigate to **Actions > Integration System > Integration Events**.

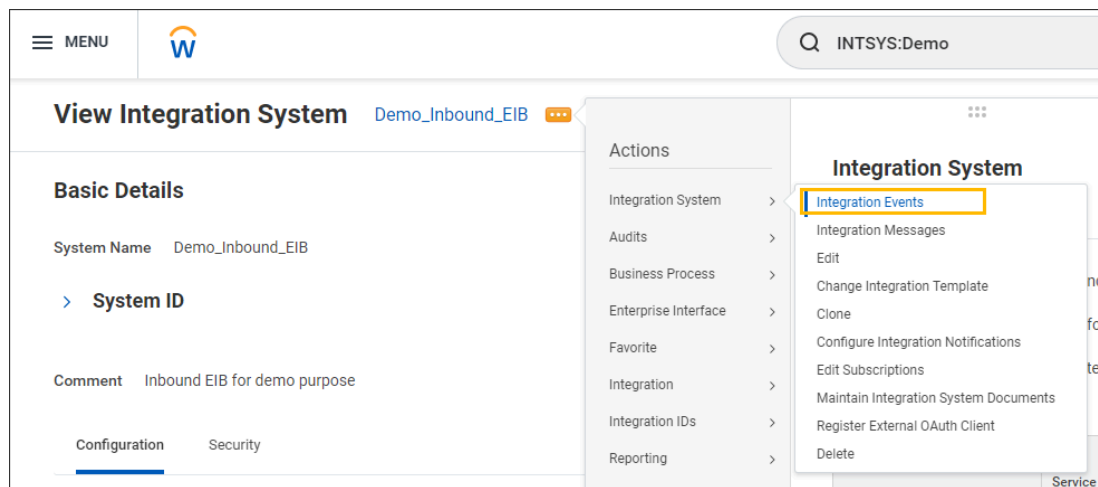

The **Integration Events** screen appears.

2. Click **OK** to show all the integration events. You can also filter the results based on **Integration Event Status**, **by Person**, or by **Sent After/Sent Before** date and time.



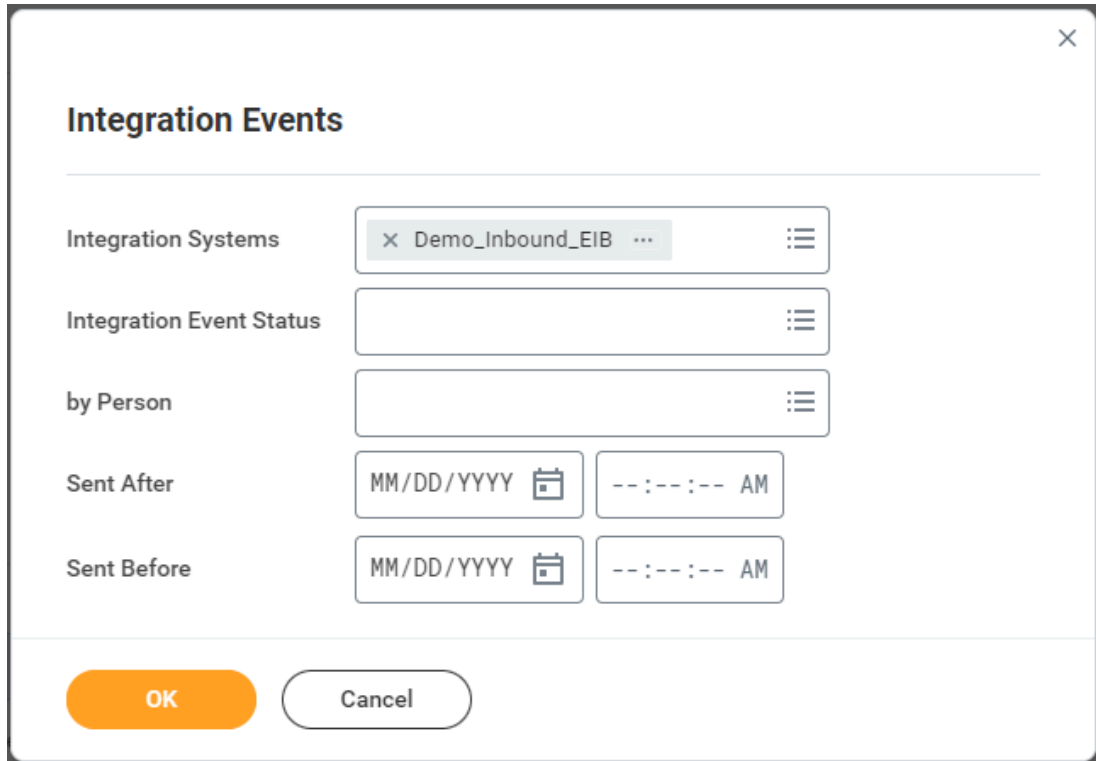

The image shows a dialog box titled "Integration Events" with a close button (X) in the top right corner. The dialog contains several configuration fields:

- Integration Systems:** A dropdown menu with "Demo\_Inbound\_EIB" selected and a menu icon to its right.
- Integration Event Status:** An empty dropdown menu with a menu icon to its right.
- by Person:** An empty dropdown menu with a menu icon to its right.
- Sent After:** Two input fields: the first is a date field with the placeholder "MM/DD/YYYY" and a calendar icon; the second is a time field with the placeholder "--:--:-- AM".
- Sent Before:** Two input fields: the first is a date field with the placeholder "MM/DD/YYYY" and a calendar icon; the second is a time field with the placeholder "--:--:-- AM".

At the bottom of the dialog, there are two buttons: "OK" (orange) and "Cancel" (white with a grey border).

3. Select the EIB event you want to monitor. Navigate to **Actions > Integration IDs > View IDs**.

The screenshot shows the 'Integration Events' page in the Automation Anywhere interface. The page title is 'Integration Events' and it is filtered by 'Integration Systems' to 'Demo\_Inbound\_EIB'. There are 12 items listed. The first row is selected, and a context menu is open over it. The 'View IDs' option is highlighted in the context menu. A modal window titled 'Background Process' is open, showing details for an 'Integration ESB Invocation' event. The modal includes a 'Created Date and Time' field with the value '01/25/2023 04:22 PM', a 'Process' field with the value 'Data Load', a 'Request' field with the value 'Integration ESB Invocation', and a 'Status' field with the value 'Completed'.

Workday Integration Cloud Platform (ESB) Process IDs	Event Type	Integration Event	Integrati
bb55539d3ae1100170848a36794a0000	Integration Event	Demo_Inbound_EIB - 01/25/2023, 1:22:35.265 PM (Completed)	Demo_In
bb55539d3ae1100170870fb2e210000			
bb55539d3ae1100170870fb2e210000			
bb55539d3ae1100170870fb2e210000			
bb55539d3ae1100170870fb2e210000			
bb55539d3ae1100170870fb2e210000			
bb55539d3ae1100170870fb2e210000			

The **Integration IDs** page appears with the Workday ID (WID) and Background Process Instance ID.

1. Copy either the Workday ID (WID) or Background Process Instance ID.
2. In the Automation Anywhere Control Room, navigate to the **Actions** pane, select **Workday > Get Integration Event**, and place it in the canvas.

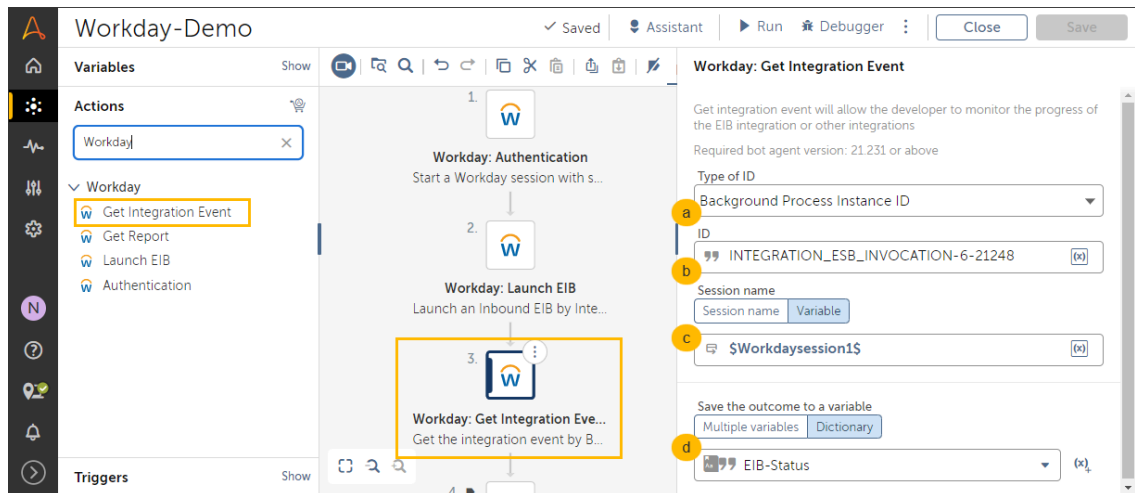

- a) From the **Type of ID** drop-down, select either the Workday ID (WID) or Background Process Instance ID.
- b) In the **ID** field, paste either the Workday ID (WID) or Background Process Instance ID copied from Workday.
- c) Enter Default as the session name, or create a session of type **Workday Session**.
- d) Save the outcome to a variable. For example, you can store all the lines of the report in a Dictionary (EIB-Status).

## Workday get report action

Use the Workday - Get Report action to retrieve a report using the Report URL. Workday Reports-as-a-Service (RaaS) is a feature that makes reports available as web services. While you are creating these reports in Workday, you must configure them as Advanced type reports to be web-service enabled.

**Note:** The examples and graphics provided on this page are for representation purposes only and may not accurately reflect your specific instance. We do not assume responsibility for their maintenance or accuracy.

Ensure that you are authenticated before initiating any Workday action. For more details, see [Workday Authentication action](#). Below are the prerequisites for the **Get Report event**:

- Log in to the Workday as an admin. For more information on logging in to a Workday instance, see [Workday Login](#).
- To find the report URL, click the horizontal three dots and navigate to **Actions > Web Service > View URLs**.

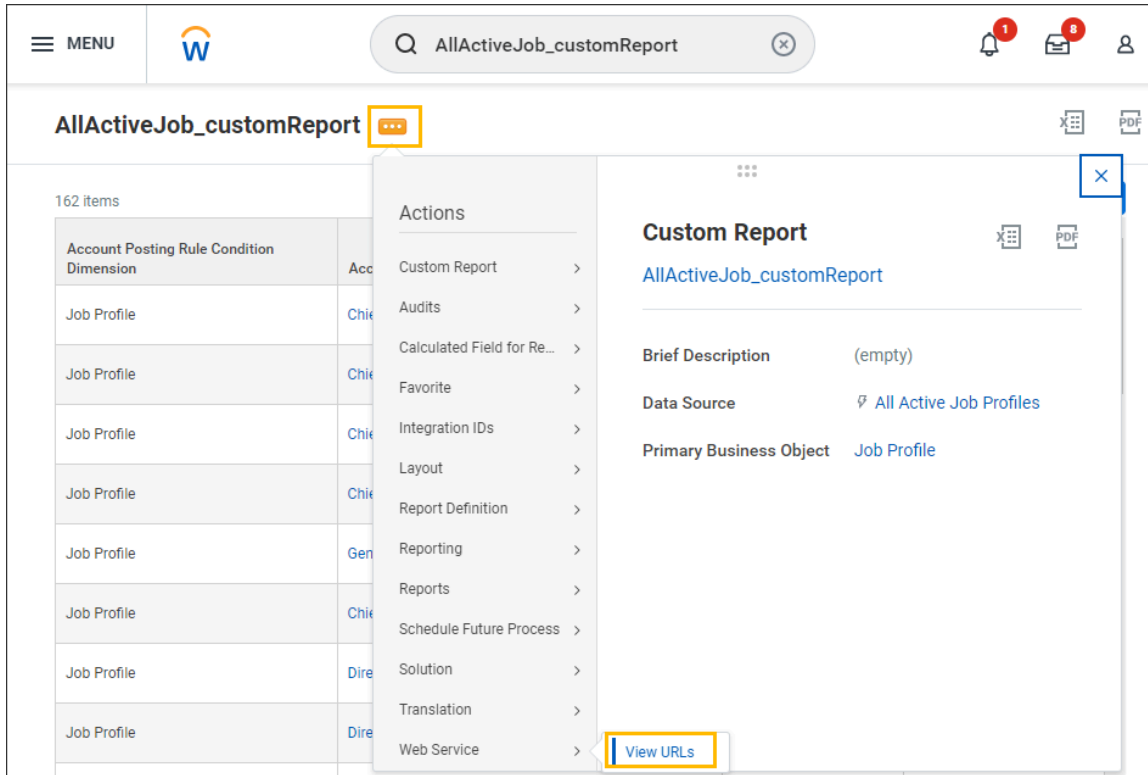

The **View URLs Web Service** page appears.

- Right-click **Workday XML** and select **Copy URL**.

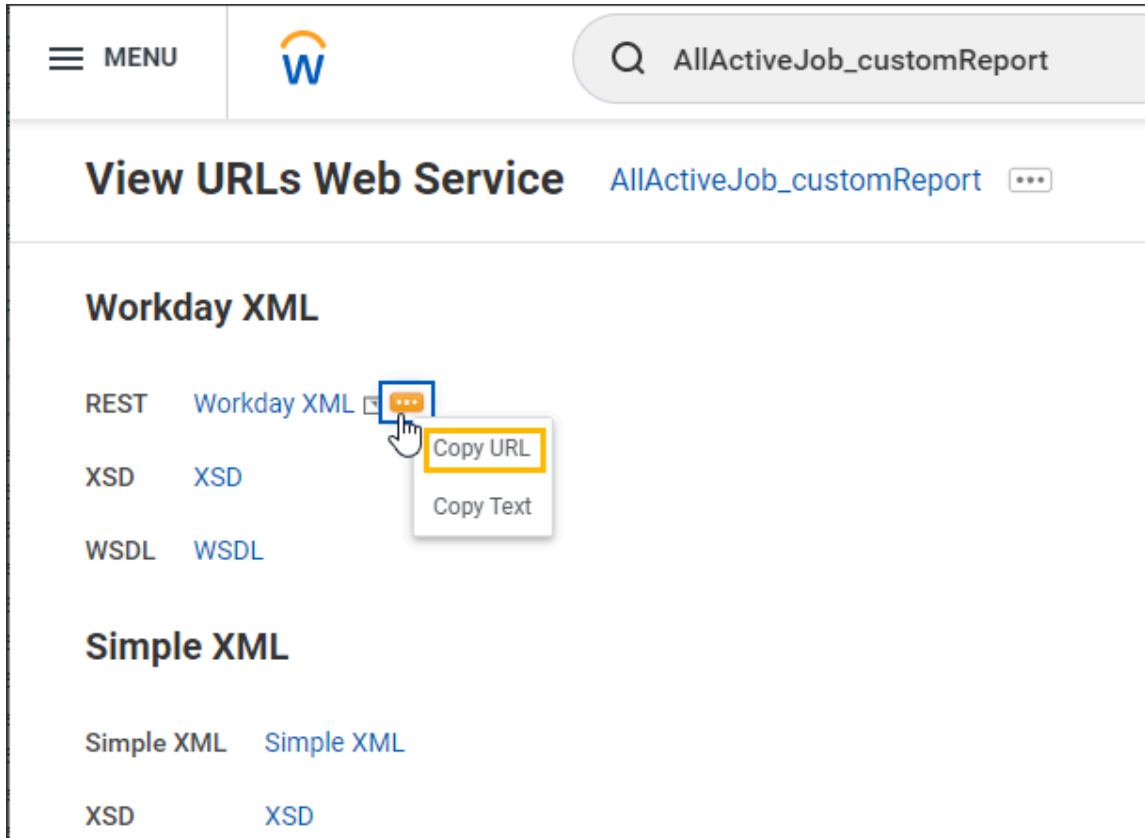

1. In the Automation Anywhere Control Room, navigate to the **Actions** pane, select **Workday > Get Report**, and place it in the canvas.

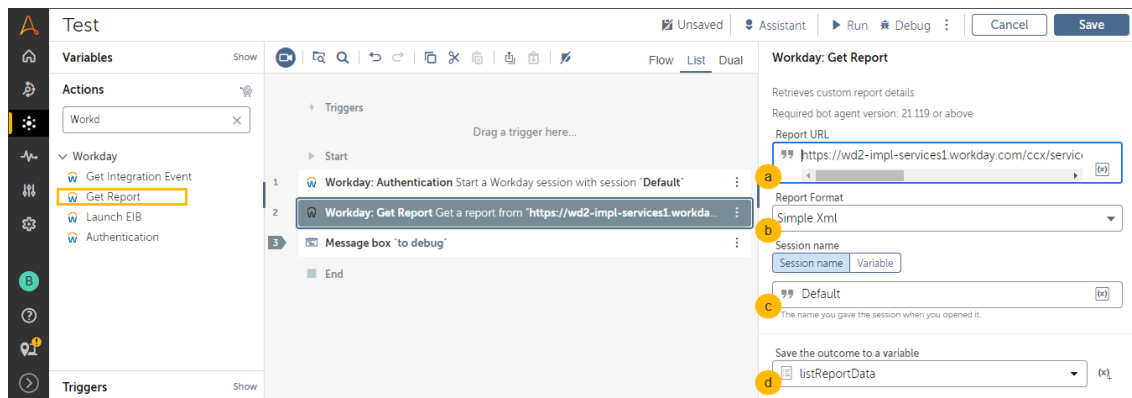

- a) Paste the **Report URL** copied from Workday. The copied report URL is the report you want to get from Workday in Automation 360.
- b) Select the **Report Format**. Automation 360 supports **Simple Xml** and **Workday Xml** formats. **Workday Xml** contains more data elements (for example, WID (Workday ID)) than the **Simple Xml**.
- c) Enter Default as the session name.

- d) Save the outcome to a variable. For example, you can store all the lines of the report in a list (listReportData)
2. To verify that you can run the bot in Debug mode, set a breakpoint action next to **Get Report**. In the previous example, there is a Message box action. Open the listReportData variable to view the results.

**Note:** The output is retrieved as a list of type . To read an individual record (row) in this list, you need to loop through all the dictionary items using the action and read or extract the records (rows) individually. For example, the output of get multiple records is saved in the variable list\_of\_records\_any. If the variable contains five records, then each record is passed to the Loop action to be processed one at a

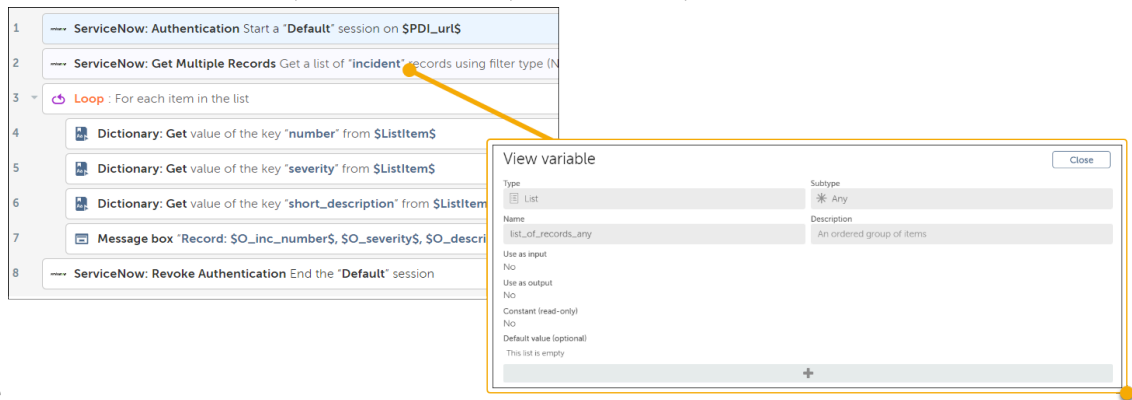

time.

## Window package

Use the Window package to automate tasks relating to the window.

**Window** is a data type available for storing application window titles. It is the only data type that can be used in all the actions of the **Window** package. Create a variable of data type **Window** and select or assign a window title.

**Note:** When you create a Window type variable, note that selecting **Browser** as default value supports only Google Chrome tabs whereas selecting **Application** as default value supports any application window.

Use this variable in any number of actions within the automation task. If the application window title changes, then change the value assigned to the variable. The new application title is reflected in all the actions where the variable is used.

### Actions in the Window package

The Window package includes the following actions:

Action	Description
Activate	See <a href="#">Activate action in Window</a> on page 3175
Assign	See <a href="#">Assign action in Window</a> on page 3176

Action	Description
Close	See <a href="#">Close action in Window</a> on page 3177
Close all	See <a href="#">Close all action in Window</a> on page 3178
Get active window title	See <a href="#">Get active window title action in Window</a> on page 3178
Maximize	See <a href="#">Maximize action in Window</a> on page 3178
Minimize	See <a href="#">Minimize action in Window</a> on page 3179
Resize	See <a href="#">Resize action in Window</a> on page 3180
Restore	See <a href="#">Restore action in Window</a> on page 3181
Set title	See <a href="#">Set title action in Window</a> on page 3182

Related reference

[Window package updates](#) on page 971

Review the updates in released versions of packagesuch as new and enhanced features as well as fixes and limitations. The page also lists the release dates of each version, and the compatible Control Room and Bot Agent versions.

## Activate action in Window

The **Activate** action in the Window package enables you to activate a window.

### Settings

- In the **Window** field, select an option: Choose from the **Application**, **Browser**, or **Variable** tab.
  - Application:** Select from a list of windows, including browser windows, that are currently open on the Bot Creator device.
  - Browser:** Select from a list of supported browser tabs.

---

**Note:** This option supports , Chromium-based , and browsers.

---

- Variable:** Select an existing window variable to specify the title of the application window title.

- In the **Window title** field, specify the title.

Insert a wildcard character (\*) in the **Window title** field to search for window titles that can change. You can specify one or more wildcards (\*) at the start, middle, or end of the value. For example, to perform an operation on any window that has `Microsoft` in the title, use a wildcard to indicate any string by adding it before or after the value: `*Microsoft*`. The first searches for the exact window title (`Microsoft`), and if it does not find a match, it searches for windows with the term `Microsoft` anywhere in the title.

You can use a regular expression (regex) to identify a window title. Select the regular expression condition as either **String** or a **Pattern** and then enter the value. By default, the **Window title** field is case-sensitive.

To identify a browser title, you can enable the **Case sensitive** option to match the letter case, or disable the option to identify a window title where the letter case does not match.

---

**Note:** Ensure that the minimum version installed on your system is the version that was released with v.26. If you have a version released with v.25 or earlier, then by default, the window title will be identified only with matching letter case (case-sensitive).

---

For example, you can enter the **String** value as `(\w*) -Notepad` for all window title names starting with `(\w*) -Notepad`, or use **Pattern** value as `(\w)\s*document-Notepad` for only those window titles that match this pattern.

---

**Note:**

- When you use a regular expression of type **String** with `-title` as the input value for a window title in any , the might encounter a run time error. To prevent the run time error, ensure that when you add the string input as `*-title`, the application with the specific title is open. The asterisk (\*) is just a character, not a wild card character.
- When you use a regular expression of type **Pattern** with `-title` as the input value for a window title in any , the might encounter a run time error because the input value `*-title` is incorrect.

Ensure that you use valid regex patterns.

---

## Assign action in Window

The **Assign** action in the Window package enables you to assign a source window variable's value to a designated window.

### Settings

- In the **Window** field, select an option: Choose from the **Application**, **Browser**, or **Variable** tab.
  - **Application:** Select from a list of windows, including browser windows, that are currently open on the device.
  - **Browser:** Select from a list of supported browser tabs.

---

**Note:** This option supports , Chromium-based , and browsers.

---

- **Variable:** Select an existing window variable to specify the title of the application window title.
- In the **Select the destination window variable/value** field, specify the variable.

---

**Note:** The regular expression (regex) is currently not supported.

---



## Close action in Window

The **Close** action in the Window package enables you to close the application window.

### Settings

- In the **Window** field, select an option: Choose from the **Application**, **Browser**, or **Variable** tab.
  - **Application**: Select from a list of windows, including browser windows, that are currently open on the device.
  - **Browser**: Select from a list of supported browser tabs.

---

**Note:** This option supports , Chromium-based , and browsers.

---

- **Variable**: Select an existing window variable to specify the title of the application window title.

Insert a wildcard character (\*) in the **Window title** field to search for window titles that can change. You can specify one or more wildcards (\*) at the start, middle, or end of the value. For example, to perform an operation on any window that has `Microsoft` in the title, use a wildcard to indicate any string by adding it before or after the value: `*Microsoft*`. The first searches for the exact window title (`Microsoft`), and if it does not find a match, it searches for windows with the term `Microsoft` anywhere in the title.

You can use a regular expression (regex) to identify a window title. Select the regular expression condition as either **String** or a **Pattern** and then enter the value. By default, the **Window title** field is case-sensitive.

To identify a browser title, you can enable the **Case sensitive** option to match the letter case, or disable the option to identify a window title where the letter case does not match.

---

**Note:** Ensure that the minimum version installed on your system is the version that was released with v.26. If you have a version released with v.25 or earlier, then by default, the window title will be identified only with matching letter case (case-sensitive).

---

For example, you can enter the **String** value as `((\w*)-Notepad)` for all window title names starting with `((\w*)-Notepad)`, or use **Pattern** value as `((\w)\s)*document-Notepad` for only those window titles that match this pattern.

---

#### Note:

- When you use a regular expression of type **String** with `-title` as the input value for a window title in any , the might encounter a run time error. To prevent the run time error, ensure that when you add the string input as `*-title`, the application with the specific title is open. The asterisk (\*) is just a character, not a wild card character.
- When you use a regular expression of type **Pattern** with `-title` as the input value for a window title in any , the might encounter a run time error because the input value `*-title` is incorrect.

Ensure that you use valid regex patterns.

---

---

#### Note:

- When multiple Excel windows are opened, the bot closes all the open Microsoft Excel windows even when a specific Excel window name is selected to close.
  - When you select **Currently active** as the window title, to close any active windows, and then run the bot, the **Shut Down Windows** pop-up is no longer activated, even if there are no active windows on the machine.
- 

## Close all action in Window

The **Close all** action in the Window package enables you to close all the windows.

### Settings

In the **Add window** field, you can provide the title of the application windows that you do not want to close.

You can also search the window titles by using (\*) as a wildcard character. Specify one or more (\*) wildcards at the start, middle, or end of the title. For example, to perform an operation on any window that has Microsoft in the title, use a wildcard to indicate any string by adding it before or after the value: \*Microsoft\*. The bot first searches for the exact window title (Microsoft), and if it does not find a match, it searches for windows with the term Microsoft anywhere in the title.

---

**Note:** To keep the Bot editor window open, ensure that you add it in the **Add window** field. For example, enter \*Control Room | Automation Anywhere\* in the window title to keep it open.

---

## Get active window title action in Window

The **Get active window title** action in the Window package enables you to retrieve the title of the active window.

### Settings

In the **Assign the window title to variable** field, specify the variable.

The shows a descriptive default variable name. If you create several output variables, subsequent variable names are appended with a -1, -2, -3, and so on to avoid duplication.

---

**Note:** The regular expression (regex) is currently not supported.

---

## Maximize action in Window

The **Maximize** action in the Window package enables you to maximize a window.

### Settings

- In the **Window** field, select an option: Choose from the **Application**, **Browser**, or **Variable** tab.

- **Application:** Select from a list of windows, including browser windows, that are currently open on the device.
- **Browser:** Select from a list of supported browser tabs.

---

**Note:** This option supports , Chromium-based , and browsers.

---

- **Variable:** Select an existing window variable to specify the title of the application window title.

Insert a wildcard character (\*) in the **Window title** field to search for window titles that can change. You can specify one or more wildcards (\*) at the start, middle, or end of the value. For example, to perform an operation on any window that has `Microsoft` in the title, use a wildcard to indicate any string by adding it before or after the value: `*Microsoft*`. The first searches for the exact window title (`Microsoft`), and if it does not find a match, it searches for windows with the term `Microsoft` anywhere in the title.

You can use a regular expression (regex) to identify a window title. Select the regular expression condition as either **String** or a **Pattern** and then enter the value. By default, the **Window title** field is case-sensitive.

To identify a browser title, you can enable the **Case sensitive** option to match the letter case, or disable the option to identify a window title where the letter case does not match.

---

**Note:** Ensure that the minimum version installed on your system is the version that was released with v.26. If you have a version released with v.25 or earlier, then by default, the window title will be identified only with matching letter case (case-sensitive).

---

For example, you can enter the **String** value as `((\w*)-Notepad` for all window title names starting with `((\w*)-Notepad`, or use **Pattern** value as `((\w)\s)*document-Notepad` for only those window titles that match this pattern.

---

**Note:**

- When you use a regular expression of type **String** with `-title` as the input value for a window title in any , the might encounter a run time error. To prevent the run time error, ensure that when you add the string input as `*-title`, the application with the specific title is open. The asterisk (\*) is just a character, not a wild card character.
- When you use a regular expression of type **Pattern** with `-title` as the input value for a window title in any , the might encounter a run time error because the input value `*-title` is incorrect.

Ensure that you use valid regex patterns.

---

## Minimize action in Window

The **Minimize** action in the Window package enables you to minimize a window.

### Settings

- In the **Window** field, select an option: Choose from the **Application**, **Browser**, or **Variable** tab.

- **Application:** Select from a list of windows, including browser windows, that are currently open on the device.
- **Browser:** Select from a list of supported browser tabs.

---

**Note:** This option supports , Chromium-based , and browsers.

---

- **Variable:** Select an existing window variable to specify the title of the application window title.

Insert a wildcard character (\*) in the **Window title** field to search for window titles that can change. You can specify one or more wildcards (\*) at the start, middle, or end of the value. For example, to perform an operation on any window that has `Microsoft` in the title, use a wildcard to indicate any string by adding it before or after the value: `*Microsoft*`. The first searches for the exact window title (`Microsoft`), and if it does not find a match, it searches for windows with the term `Microsoft` anywhere in the title.

You can use a regular expression (regex) to identify a window title. Select the regular expression condition as either **String** or a **Pattern** and then enter the value. By default, the **Window title** field is case-sensitive.

To identify a browser title, you can enable the **Case sensitive** option to match the letter case, or disable the option to identify a window title where the letter case does not match.

---

**Note:** Ensure that the minimum version installed on your system is the version that was released with v.26. If you have a version released with v.25 or earlier, then by default, the window title will be identified only with matching letter case (case-sensitive).

---

For example, you can enter the **String** value as `((\w*)-Notepad` for all window title names starting with `((\w*)-Notepad`, or use **Pattern** value as `((\w)\s)*document-Notepad` for only those window titles that match this pattern.

---

**Note:**

- When you use a regular expression of type **String** with `-title` as the input value for a window title in any , the might encounter a run time error. To prevent the run time error, ensure that when you add the string input as `*-title`, the application with the specific title is open. The asterisk (\*) is just a character, not a wild card character.
- When you use a regular expression of type **Pattern** with `-title` as the input value for a window title in any , the might encounter a run time error because the input value `*-title` is incorrect.

Ensure that you use valid regex patterns.

---

## Resize action in Window

The **Resize** action in the Window package enables you to resize a window.

### Settings

- In the **Window** field, select an option: Choose from the **Application**, **Browser**, or **Variable** tab.

- **Application:** Select from a list of windows, including browser windows, that are currently open on the device.
- **Browser:** Select from a list of supported browser tabs.

---

**Note:** This option supports , Chromium-based , and browsers.

---

- **Variable:** Select an existing window variable to specify the title of the application window title.
- Insert a wildcard character (\*) in the **Window title** field to search for window titles that can change. You can specify one or more wildcards (\*) at the start, middle, or end of the value. For example, to perform an operation on any window that has `Microsoft` in the title, use a wildcard to indicate any string by adding it before or after the value: `*Microsoft*`. The first searches for the exact window title (`Microsoft`), and if it does not find a match, it searches for windows with the term `Microsoft` anywhere in the title.
- You can use a regular expression (regex) to identify a window title. Select the regular expression condition as either **String** or a **Pattern** and then enter the value. By default, the **Window title** field is case-sensitive.

To identify a browser title, you can enable the **Case sensitive** option to match the letter case, or disable the option to identify a window title where the letter case does not match.

---

**Note:** Ensure that the minimum version installed on your system is the version that was released with v.26. If you have a version released with v.25 or earlier, then by default, the window title will be identified only with matching letter case (case-sensitive).

---

For example, you can enter the **String** value as `( (\w*) -Notepad` for all window title names starting with `( (\w*) -Notepad`, or use **Pattern** value as `( (\w) \s) *document-Notepad` for only those window titles that match this pattern.

---

**Note:**

- When you use a regular expression of type **String** with `-title` as the input value for a window title in any , the might encounter a run time error. To prevent the run time error, ensure that when you add the string input as `*-title`, the application with the specific title is open. The asterisk (\*) is just a character, not a wild card character.
- When you use a regular expression of type **Pattern** with `-title` as the input value for a window title in any , the might encounter a run time error because the input value `*-title` is incorrect.

Ensure that you use valid regex patterns.

- 
- In the **Left**, **Top**, **Width**, and **Height** fields, specify values for resizing the window.

## Restore action in Window

The **Restore** action in the Window package enables you to restore a window.

### Settings

- In the **Window** field, select an option: Choose from the **Application**, **Browser**, or **Variable** tab.

- **Application:** Select from a list of windows, including browser windows, that are currently open on the device.
- **Browser:** Select from a list of supported browser tabs.

---

**Note:** This option supports , Chromium-based , and browsers.

---

- **Variable:** Select an existing window variable to specify the title of the application window title.
- Insert a wildcard character (\*) in the **Window title** field to search for window titles that can change. You can specify one or more wildcards (\*) at the start, middle, or end of the value. For example, to perform an operation on any window that has `Microsoft` in the title, use a wildcard to indicate any string by adding it before or after the value: `*Microsoft*`. The first searches for the exact window title (`Microsoft`), and if it does not find a match, it searches for windows with the term `Microsoft` anywhere in the title.
- You can use a regular expression (regex) to identify a window title. Select the regular expression condition as either **String** or a **Pattern** and then enter the value. By default, the **Window title** field is case-sensitive.

To identify a browser title, you can enable the **Case sensitive** option to match the letter case, or disable the option to identify a window title where the letter case does not match.

---

**Note:** Ensure that the minimum version installed on your system is the version that was released with v.26. If you have a version released with v.25 or earlier, then by default, the window title will be identified only with matching letter case (case-sensitive).

---

For example, you can enter the **String** value as `( (\w*) -Notepad` for all window title names starting with `( (\w*) -Notepad`, or use **Pattern** value as `( (\w) \s) *document-Notepad` for only those window titles that match this pattern.

---

**Note:**

- When you use a regular expression of type **String** with `-title` as the input value for a window title in any , the might encounter a run time error. To prevent the run time error, ensure that when you add the string input as `*-title`, the application with the specific title is open. The asterisk (\*) is just a character, not a wild card character.
- When you use a regular expression of type **Pattern** with `-title` as the input value for a window title in any , the might encounter a run time error because the input value `*-title` is incorrect.

Ensure that you use valid regex patterns.

---

## Set title action in Window

The **Set title** action in the Window package assign a new window title to a window variable.

### Settings

- In the **Window** field, click one of the following tabs:
  - **Browser**

- Click the **Choose a browser tab** drop-down menu to select any of the active browsers on your system. Google Chrome, Chromium-based Microsoft Edge, and Internet Explorer browsers are supported.

(Optional) Click the **Refresh windows** icon to update the list.

- In the **Browser title** field, click one of the following tabs:
  - **String**: Enter a wildcard character (\*) in the window title field to search for window titles that can change. You can specify one or more wildcards (\*) at the start, middle, or end of the value. For example, to perform an operation on any window that has Microsoft in the title, use a wildcard to indicate any string by adding it before or after the value: \*Microsoft\*. The bot first searches for the exact window title (Microsoft), and if it does not find a match, it searches for windows with the term Microsoft anywhere in the title.
  - **Regex**: You can use a regular expression (regex) to identify a window title. Select the regular expression **Type** as either **String** or **Pattern** and then enter the value. By default, the Window title field is case-sensitive.

For example, you can enter the **String** value as `((\w*)-Notepad` for all window title names starting with `((\w*)-Notepad`, or use **Pattern** value as `((\w)\s)*document-Notepad` for only those window titles that match this pattern.

- The **Case sensitive** option is enabled by default and is used to match the letter case. Optionally, you can clear the check box to identify a window title where the letter case does not match.

---

**Note:** Ensure that the minimum Bot Agent version installed on your system is the version that was released with Automation 360Automation 360 v.26. If you have any of the older Bot Agent versions, the window title will be identified only with matching letter case (case-sensitive) by default.

---

- The **Link to the web page** field displays the address of the website you have selected through the browser.
- The **Browser application** field displays the name of the browser you have selected.

- **Application**

Click the **Choose an application window** drop-down menu to select an application that is currently active on your Bot Creator device.

(Optional) Click the **Refresh windows** icon to update the list.

- **Variable**

Select an existing application window or browser tab to specify the title.

- In the **Window title is** field, select one of the following options for new title:
  - **Not a regular expression**: If the sub-string is not a regular expression.
  - **A regular expression**: If the sub-string is a regular expression.
- In the **New window title** field, enter the new title that you want to assign.

(Optional) Click the **Insert a value** icon to select an existing variable for the new title.

## Workload package

The Workload package enables you to insert work items in a queue for workload automation. It also enables data chaining between multiple queues. You can orchestrate multiple bots, and enable optimal device utilization through the queueing mechanism of workload management.

For example, a business process of Employee Salary Processing:

- A payroll queue can process the employee salaries, and a payroll bot can add work items to a finance queue.
- The finance queue in turn can release the funds to employees and a finance bot in turn adds works items in a HR queue to email employees on the salary processing completion.

You must have the Queue **Owner** or **Participant** privileges to view the list of queues in the Workload package.

### Actions in the Workload package

The Workload package includes the following action:

**Note:** If you built a bot using actions from the Workload package from Build 5322 or earlier, the action will be missing when you open the bot with the default package version. You must reinsert the action and repopulate the fields.

Action	Description
Insert work item	Allows you to insert a work item from an existing queue to another queue as part of a bot execution.

Related concepts

[Workload management](#) on page 1996

The workload management module enables users to upload Microsoft Excel and CSV files to the Control Room so that it feeds the records from the files into the bot deployments.

Related tasks

[Attach work item template to bot](#) on page 2315

Attach a work item template to a bot to use the bot in workload automation.

[Use Work Item variables](#) on page 2343

You can use the Work Item variables to pass the Work Item attributes or values to the Task Bot from the Control Room when you run the bot with the option **Run bot with queue**.

### Using Insert work item action

The **Insert work item** action provides you the flexibility to insert a work item to another queue as part of a bot execution.

- You must have the Queue **Owner** or **Participant** privileges to view the list of queues in the Workload package.



- Do not attach the bot with a work item template as the bot fails when it is deployed on a Bot Runner.
- The maximum number of characters you can insert in a work item value is 1000.

Considerations when using the **Insert work item** action:

- Run the bot using one of the following options:
  - Run bot now
  - Schedule bot
  - Run with triggers
- Use the **Insert work item** to manage complex workflows by configuring a bot to add work items from multiple queues.

For example, use a bot to read a list of invoices from a .csv file and add the invoices due for payment to another bot that manages information of payments due on specific dates. The automation can be used in the scenarios where work items are part of a different system (Database, Excel) and the bot reads them and adds them to a queue or where one queue adds work items to another queue as part of data chaining.

1. In the **Automation** page, **Create** a bot or **Edit** an existing bot.
2. In the **Actions** palette, double-click or drag the **Insert Work Item** action from the Workload package.
3. In the **Workload: Insert work item** window, add parameters such as the **Queue** and work item values:
  - a) Click **Browse** to select a queue name from the list of queues to insert as a work item.
  - b) Click **Confirm** to add the queue.
  - c) Start entering work item values in the work item fields.

---

**Note:** These parameters are populated based on the work item template associated with the selected queue.

---

You can also assign a variable value to these parameters by pressing the F2 key and selecting a variable name from the list.

---

**Tip:** Use UTC format (YYYY-mm-dd 00:00:00) for **Date** data type.

---

4. Click **Save**.  
The action is added to the bot.
5. Add more data using the **Insert Work Item** action.  
After the required data is added, **Save** the bot and **Check in** the bot to the **Public** folder for further processing and deployment.

Related concepts

[Create workload queues](#) on page 1997

A queue is one of the main building blocks of Workload Management. A queue holds data known as Work Items for further processing. The system distributes these Work Items to individual unattended Bot Runners in a device pool for processing.

Related tasks

[Attach work item template to bot](#) on page 2315

Attach a work item template to a bot to use the bot in workload automation.

[Use Work Item variables](#) on page 2343

You can use the Work Item variables to pass the Work Item attributes or values to the Task Bot from the Control Room when you run the bot with the option **Run bot with queue**.

[Insert Work Items](#) on page 2004

Add Work Items from a CSV file to the queue after you define the structure.

## XML package

Extensible Markup Language (XML) is a markup language designed to store and transport data. Use the actions in the XML package to automate the processing of XML data generated from web services and cloud computing applications.

An XML document is structured as an ordered and labeled tree. Each node of the tree is an XML element and is written with an opening and closing tag. In the following example, custname and custid are nodes:

```
<customer>
<custname>XYZ Corp</custname>
<custid>A001</custid>
</customer>
```

XPath is a query language that uses path expressions to select nodes or node-sets in an XML document. XPath includes built-in functions for manipulation of string, numeric, Boolean, date and time, and so on.

### Before you start

Perform the following actions within the XML package.

1. Start the XML session using the **Start XML Session** action. Use this session name for all corresponding actions.
2. Use the different actions available in the XML package to automate XML-related tasks.
3. Save the session using the **Save XML Session** action to assign the data to a file or String-type variable.
4. End the session using the **End XML Session** action to complete a task.

### Actions in the XML package

The XML includes the following actions:

Action	Description
Delete node	See <a href="#">Delete node action in XML</a> on page 3187.
End session	See <a href="#">End session action in XML</a> on page 3187.
Execute XPath function	See <a href="#">Execute XPath function action in XML</a> on page 3188.

Action	Description
Get multiple nodes	See <a href="#">Get multiple nodes action in XML</a> on page 3188.
Get single node	See <a href="#">Get single node action in XML</a> on page 3189.
Insert node	See <a href="#">Using Insert node action</a> on page 3190.
Save session data	See <a href="#">Save session data action in XML</a> on page 3191.
Start session	See <a href="#">Start session action in XML</a> on page 3191.
Update node	See <a href="#">Update node action in XML</a> on page 3192.
Validate XML document	See <a href="#">Validate XML document action in XML</a> on page 3192.

Related reference

[XML package updates](#) on page 974

Review the updates in released versions of the XML package such as new and enhanced features as well as fixes and limitations. The page also lists the release dates of each version, and the compatible Control Room and Bot Agent versions.

## Delete node action in XML

The **Delete node** action in the XML package enables you to delete a specific node from XML file.

### Settings

- Enter the **session name** or select an existing variable used in the **Start XML session** action.
- Enter the **XPath expression** for the node to be deleted.
- Enter the **attribute** (optional).

## End session action in XML

The **End session** action in the XML package enables you to close an XML session.

### Settings

Enter the **session name** or select an existing variable used in the **Start XML session** action .

**Note:** The **End session** action clears out session-related data from memory. To save the modified data, use the **Save session data** action.

## Execute XPath function action in XML

The **Execute XPath function** action in the XML package enables you to execute XPath function and store the results in a variable.

### Settings

- Enter the **session name** or select an existing variable used in the **Start XML session** action.
- Enter the **XPath expression** or select an existing variable.
- Assign a **String-type variable** to the output.

For more information on how to use some of the actions (including Execute XPath function), see this example topic [Example for using actions in XML package](#) on page 3193.

## Get multiple nodes action in XML

The **Get multiple nodes** action in the XML package enables you to retrieve the value of multiple nodes.

### Settings

- Enter the **session name** or select an existing variable used in the **Start XML session** action.
- Enter the **XPath expression** to retrieve multiple nodes or select an existing variable.
- In the Get each node field, select if you require the **Text value**, **XPath expression**, or **Specific attribute name of each node**.
  - Text value retrieves the exact value of the specific node element.
  - XPath expression refers to the path of the selected node in an XML document.
  - Specific attribute defines a property or the type of the element in a particular node. For example, lang is an attribute of the Locale element in a Cust\_Details node. The output for lang attribute is displayed as es.

## Example of how to retrieve the value of multiple nodes

You can create an XML file on your desktop. This example uses a sample XML with the following structure:

```
<Customer>
<Cust_Details>
  <custid city="Leon">A001</ custid>
  <custname>XYZ Corp</custname>
  <custzipcode>15639</custzipcode>
  <country>Mexico</country>
  <Locale lang="es"> Spanish</Locale>
</Cust_Details>
</Customer>
```

To retrieve the value of multiple nodes from a customer details:

1. Create and name the bot: XML\_Bot.
2. Start an XML session by using the **XML > Start session** action.
  - a) In the **Session name** field, enter Default.
  - b) In the **Data Source** field, choose **File** and select the **Desktop file** option. Click **Browse** to locate your XML file, for example: D:\userdefined path\xml sample.xml.
3. Double-click or drag the **Get multiple nodes** action to retrieve the value of multiple nodes.
  - a) In the **Session name** field, enter Default.
  - b) In the XPath Expression field enter //Customer/Cust\_Details/custid.
  - c) In the **Get each node** field, select from the following options and print the output in the message box.
    - **Text value**
    - **XPath expression**
    - **Specific attribute name of each node**, If you select this option then enter the attribute city in the text box.
  - d) In the **Assign the output to variable (optional)** field, select TableXMLNodes.
4. Double-click or drag the **Message box** to print the values and enter \$TableXMLNodes [0] [0]\$ in the **Enter the message to display** field.
5. Click **Save** and then click **Run**.

The values retrieved from each node are as follows:

- **Text value:** A001
- **XPath expression:** /Customer/Cust\_Details/custid
- **Specific attribute name of each node:** Leon

## Get single node action in XML

The **Get single node** action in the XML package enables you to retrieve the value of a single node.

### Settings

- Enter the **session name** or select an existing variable used in the **Start XML session** action.
- Enter the **XPath expression**, and **attribute** (optional) to retrieve a node.

Get single node retrieves the first value from the XML document based on the provided XPath expression and the attribute. For example,

```
<Customer>
  <Cust_Details>
    <custid>A001</ custid>
    <custname>XYZ Corp</custname>
    <custzipcode>15639</custzipcode>
    <country>Mexico</country>
```

```
<Locale lang="es"> Spanish</Locale>
</Cust_Details>
</Customer>
```

- XPath expression with attribute: The attribute value of the XPath expression element is displayed. For example, if the XPath expression is entered as `Customer//Cust_Details//Locale` with the attribute as `lang`, the output is displayed as `es`.
  - XPath expression without attribute: The value of the XPath expression element is displayed. For example, if the XPath expression is entered as `Customer//Cust_Details//Locale` without any attribute, `Spanish` is displayed as an output.
- Assign the output to a **String-type variable**.

## Using Insert node action

Use this action to insert a node in an existing XML file and assign it to a value. Optionally, assign a name space and attributes to the node.

---

**Note:** When you use the Insert node action, the attributes are alphabetically sorted and displayed in the XML output.

---

To insert a node, do the following:

1. Enter the session name.  
Use the name of the session that you have used in the **Start XML session** action.
2. Specify an **XPath expression** to indicate where to insert the new node.
3. Enter a node name.
4. Enter a value for the node.
5. If the node name exists, select from the following options:
  - **Insert it anyway**
  - **Skip it**
  - **Overwrite it**
6. Specify the location to insert the node from the following options:
  - **Beginning of the child nodes**
  - **End of the child nodes**
  - **Before specific child note**
  - **After specific child node**

If **Before Specific child node** or **After Specific child node** is selected, specify the child node name before or after which the node must be inserted.

7. Optional: Enter the default name space to be mapped to the node.

---

**Note:** The Insert node action currently does not support namespaces. If you specify a namespace prefix in this field, the prefix is ignored in the result document.

---

8. Enter the attributes using a Dictionary-type variable.  
Create a new variable of type **Dictionary** or use one that already exists.
9. Optional: Enter the attribute name space using a Dictionary-type variable  
Create a new Dictionary-type variable or use one that already exists.

10. Click **Save**.

## Save session data action in XML

The **Save session data** action in the XML package enables you to save the XML session data to a file or variable of type String.

### Settings

Session data is an entity used to save session context information. You can save the session to assign the current state of the XML data to a file or a variable.

- Enter the **session name** or select an existing variable used in the **Start XML session** action.
- To save the session data to a file, select the **Write XML data** option and specify a **file path**.
- Select **Overwrite** to replace the existing file if a file with the same name exists in the location you have specified.
- Select the **Use Prettyprint** check box to format your code with proper indentation as per Prettyprint.

---

**Note:** By default, it uses a 2-space indentation and does not add XML document declaration explicitly.

---

**Use Prettyprint** feature works effectively when:

- The source XML document supports the linearization of a tree structure.
- You select the **Remove text nodes that contain only white space** check box in the **Start session** action.

---

**Note:**

- If the source document is already formatted, you do not have to select the **Use Prettyprint** check box.
- When you migrate bots from Enterprise 11 to Automation 360 that are using the **Save session data** action, the **Use Prettyprint** check box is selected by default.

- 
- Assign the output to a **String-type variable**.

---

**Note:** The session data will be saved if you select the **Write XML data** option.

---

## Start session action in XML

The **Start session** action in the XML package enables you to create a new XML session based on an XML file or specified text.

### Settings

- Start the XML session.

- Enter the **session name** or select an existing variable used in the **Start XML session** action. Use this **session name** for all corresponding actions.
- In the Data Source field, select either **File** or **Text**:
  - File: Select from the **Control Room file**, **Desktop file**, or an existing **Variable** of File type.
  - Text: Specify the text name or select an existing variable.
- Select the **Remove text nodes that contain only white space** check box to remove the blank text nodes when you parse the XML document.

---

**Note:** When you migrate bots from Enterprise 11 to Automation 360 that are using the **Start session** action, the **Remove text nodes that contain only white space** check box is selected by default.

---

- Save the XML session.

## Update node action in XML

The **Update node** action in the XML package enables you to update the value of a node.

---

**Note:** When you use the Update node action, the attributes are alphabetically sorted and displayed in the XML output.

---

### Settings

- Type the **session name** or select an existing variable used in the **Start XML session** action.
- Enter the **XPath expression** for the node to be updated.
- Enter a **New value** for the node.
- Select the **Updates attribute (s)** option to create a new **Dictionary** or to add an existing **Variable** of Dictionary-type.

## Validate XML document action in XML

The tags and document structure are defined when the XML document is created. Use the **Validate XML document** action in the XML package to validate an XML document.

### Settings

- Enter the **session name** or select an existing variable used in the **Start XML session** action.
- Select the validation type from the following options:
  - **XML schema files (.xsd)**
    - **List:** Specify the schema XSD file path you want to validate in the **Value** field. Click **Add** to add multiple XML schema files (.xsd).
    - **Variables:** Create a new variable of type **List** with subtype **String** and enter the XSD file path in the **Default value field (optional)** or use an existing variable.
  - **Internal Document Type Definitions (DTDs)**



- **Well formed**
- Assign the output to a variable using **Assign the output (Valid or Invalid) to variable**

## Example for using actions in XML package

Using the XML package, create a bot that reads and writes data from an XML file to an Excel sheet. The sample XML used in this tutorial has the following structure:

```
<movies>
  <movie genre="" year="">
    <name></name>
    <description></description>
    <director></director>
    <writers>
      <writer type=""></writer>
      <writer type=""></writer>
    </writers>
    <rating>R</rating>
  </movie>
</movies>
```

Before you begin, [download a sample XML file](#).

The tutorial is intended to demonstrate the following actions:

- Use an XPath expression to get a node set with specific value and iterate through the items in the node set, for example, movies with specific rating in this tutorial.
- Use an XPath function to iterate through the child node sets.
- Concatenate variables to build a string.
- Write data to an Excel sheet.

Ensure the following:

- You know how to create bots.
- You are familiar with the Control Room user interface.

1. Create a bot and name it `XMLDataReader`.
2. Add a step to group all tasks for opening an Excel sheet.
  - a) Add the **Step > Step** action after the **Start** flow in the Bot editor.

---

**Note:** To add an action, search for the action in the **Actions** pane and drag it to the bot flow in the Bot editor.

---

- b) In **Title**, enter `Open an Excel Sheet` and save the action.
3. To create and open an Excel sheet, use **Excel advanced > Create workbook**.
    - a) Add the **Excel advanced > Create workbook** action within the **Step** action.
    - b) In **File path**, enter `C:\movies\movies.xlsx`, and save the action. If the `movies` folder does not exist in the specified path, create a `movies` folder in the path.

4. To select the first cell on the Excel sheet, use the **Excel advanced > Go to cell** action.
  - a) Add the **Excel advanced > Go to cell** action after the **Excel advanced: Create workbook** action.
  - b) Click **Specific cell** if it is not already selected, and enter A1.
  - c) Save the action.
  
5. Create another step to group all the tasks for retrieving XML data.
  - a) Add the **Step > Step** action after the first **Step** action.
  - b) In **Title**, enter Get XML Data and save the action.
  
6. Start an XML session.
  - a) Add the **XML > Start session** action within the **Get XML Data** step.
  - b) Under **File**, select **Desktop**, browse and select the sample XML file that you downloaded.
  - c) Save the changes.
  
7. To get all movie nodes with rating R, use the **Get multiple nodes** action.
  - a) Add the **XML > Get multiple nodes** action after the **Start session** action.
  - b) In **XPath Expression**, enter `//movie[rating/text()='R']`, and save the action.  
The selected node set is stored in a system variable and is available to the **For each Node in a XML dataset** iterator now.
  - c) To ensure that the action retrieves the entire node set instead of just the text nodes, click **Xpath expression**.
  
8. Use the **Loop** action to iterate through the selected node set that the **Get multiple nodes** action retrieves.
  - a) Add **Loop > Loop** after the **XML: Get multiple nodes** action.
  - b) Under **Iterator**, select **XML > For each Node in a XML dataset** as the iterator.
  - c) In **Assign the current row to this variable**, click **(x)** and create a variable with the default name, for example, XMLNode. Each item in the node set is now available through the variable.
  - d) Save the action.
  
9. To get the movie name from the iterated node, use the **Get single node** action.
  - a) Add the **XML > Get single node** action within the **Loop: Loop** action.
  - b) In **XPath expression**, enter `$XMLNode$/name`.
  - c) In **Assign the output to variable**, create a variable and name it sMovieName.
  - d) Save the action.
  
10. To write the movie name from the XMLNode variable, use the **Set cell** action.
  - a) Add the **Excel advanced > Set cell** action after the **Get single node** action.
  - b) Click **Active cell**, enter `$sMovieName$` in **Cell value**, and save the action.

11. To select a new cell within the Excel sheet, use the **Go to cell** action.
  - a) Add the **Go to cell** action after the **Set cell** action after the **Excel advanced: Set cell** action.
  - b) Click **Active cell**, select **One cell to the right**, and then save the action.
  
12. To get the director name from the iterated node, use the **Get single node** action.
  - a) Add the **XML > Get single node** action after the **Excel advanced: Go to cell** action.
  - b) In **XPath expression**, enter `$XMLNode$/director`.
  - c) In **Assign the output to variable**, create a variable with the following name: `sDirector`
  - d) Save the action.
  
13. To write the director name from the XMLNode variable, use the **Set cell** action.
  - a) Add the **Excel advanced > Set cell** action after the **XML: Get single node** action.
  - b) Click **Active cell**, enter `$$sDirector$` in **Cell value**, and save the action.
  
14. To select a new cell within the Excel sheet, use the **Go to cell** action.
  - a) Add the **Go to cell** action after the **Excel advanced: Set cell** action.
  - b) Click **Active cell**, select **One cell to the right**, and then save the action.
  
15. Because the `<writers>` node can contain multiple `<writer>` nodes, get each writer name, concatenate the names, and write them to a single cell instead of writing values to multiple cells. To do so, add the **Loop** action within the current **Loop** action.
  - a) To get the number of the `<writer>` nodes within the `<writers>` node, add the **XML > Execute XPath function** after the **Excel advanced: Set cell** action. In **XPath expression**, enter `count($XMLNode$/writers/writer)`. In **Assign the output to variable**, create a variable named `sWriterCount`.

You will use the `<writer>` node count to loop through all the `<writer>` nodes.
  - b) Add the **Loop > Loop** action after the **XML: Execute XPath function** action.

---

**Important:** The second **Loop** action must be added within the main **Loop** action.

---
  - c) Under **Iterator**, select **For n times** as the iterator.
  - d) In **Times**, enter the following: `$$sWriterCount.String:toNumber$`

---

**Note:** `sWriterCount` contains a string value. To convert string to number, you can use the `$$<variable name>.String:toNumber$` format, for example, `$$sWriterCount.String:toNumber$`.

---
  - e) In **Assign the current value to variable (optional)**, create a variable named `Counter`.
  - f) Save the action.
  
16. To concatenate the values from all writer nodes, create a string variable.
  - a) In the **Variables** pane, click the plus icon.

The **Create variable** window opens.

- b) In **Type**, select **String**.
- c) In **Name**, enter `sWriters`.
- d) Click **Create**.

17. To get the value from the iterated `<writer>` node, use the **Get single node** action.

a) Add the **XML > Get single node** action within the second **Loop** action.

b) In **XPath expression**, enter `$XMLNode$/writers/writer[$Counter.Number:toString$]`.

Using the Counter variable, you can access a node at a specific index. Note that because the Counter variable contains a numeric value, the `.Number:toString$` expression is added to the Counter variable to convert it to a string.

- c) In **Assign the output to variable**, create a variable and name it `sWriter`.
- d) Save the action.

18. To assign values from the writer nodes, use the **String > Assign** action.

a) Add **String > Assign** action after the **XML: Get single node** within the second loop.

b) In **Select the source string variable(s)/ value (optional)**, enter `$$sWriters$, $sWriter$`.

c) In **Select the destination string variable**, select `sWriters`.

d) Save the action.

After the inner loop is complete, the `sWriters` variable will contain all the writer names.

19. To write the writer names to a new cell, use the **Excel advanced > Set cell** action within the main loop.

a) Add the **Excel advanced > Set cell** action after the inner **Loop** action within the first **Loop** action.

b) Click **Active cell**.

c) Enter `$$sWriters$` in **Cell value**.

d) Save the action.

The data retrieved from one `<movie>` node is written to a row. To write the data from the next `<movie>` node, you must select the next row in the Excel sheet.

20. To move the cursor to the next row, use the **Excel advanced > Go to cell** action.

a) Add the **Go to cell** action after the **Set cell** action.

b) Click **Active cell**, select **Beginning of the row**, and then save the action.

c) Add the **Go to cell** action again. Click **Active cell**, select **One cell below**, and then save the action.

21. Before the next node in the retrieved <movie> node set is iterated, you must reset the sWriters variable. To reset the sWriters variable, perform the following steps:
  - a) Add the **String > Assign** action after the **Excel advanced: Go to cell** within the main loop.
  - b) Leave **Select the source string variable(s)/ value (optional)** blank.
  - c) In **Select the destination string variable**, select sWriters.
  - d) Save the action.
  
22. Create a new step.
  - a) Add the **Step > Step** action after the second **Step** action.
  - b) In **Title**, enter `Close the file`.
  
23. To close the Excel sheet, use **Excel advanced Close** action.
  - a) Add **Excel advanced > Close** within the **Close the file** step.
  - b) Save the changes.
  
24. Run the bot.

## Get started building bots

Use the following three examples to become familiar with building bots using in the cloud-based Bot editor. These examples demonstrate using actions and the Universal Recorder to automate tasks in applications and browsers.

[Build a Go be Great bot](#) on page 3198

Build a basic bot using a **Message Box** action and a variable. Follow these steps to create your first bot that prints the message, `Go be great!`, the Automation Anywhere version of `Hello World!`

[Build a basic bot that uses a desktop application](#) on page 3199

Build a bot that uses a conditional statement to verify that the calculator is open, then uses the calculator to multiply two numbers. This example uses actions from the Application, If, Simulate keystrokes, Message Box, and Window packages.

[Example of extracting data from a web table](#) on page 3201

Build a bot to open a browser window to the Wikipedia website, extract the data from a table, and write it to a CSV file on your desktop. This example uses actions from the Browser, Data Table, Recorder, and Window packages.

For more examples, see [Examples of building bots](#) on page 3202.

## More resources

- To learn more, search for the Hello Automation 360 Bot: Getting Started with Building Bots course in [Automation Anywhere University: RPA Training and Certification \(A-People login required\)](#).
- You can also visit the [Learn section of the developer portal](#) for more guidance. Find learning journeys and videos for both new and experienced developers on how to build your first bots.

## Build a Go be Great bot

Build a basic bot using a **Message Box** action and a variable. Follow these steps to create your first bot that prints the message, `Go be great!`, the Automation Anywhere version of Hello World!

To build a bot you must already have done the following:

- [Install Bot Agent and register device](#) on page 1347
- [Set user device credentials](#) on page 1353

If you have already completed the steps in [Create your first bot](#) on page 1489, skip to Step 6.

1. Create a new bot:
  - a) On the left panel, click **Automation**.
  - b) Click **Create new > Bot**.
  - c) In the **Create Task Bot** window, enter the bot name.
  - d) Accept the default folder location: `\Bots\`  
To change the default bot storage location, click **Choose** and follow the prompts.
  - e) Click **Create and edit**.
2. Insert a **Message box** action.
  - a) Click **Actions**.
  - b) Search for the Message Box package.  
Click in the **Actions** search box and enter `message`. Click the arrow to expand the Message Box options.
  - c) Double-click or drag the **Message box** action to the Bot editor (open space to the right).
3. In the dialog box on the right, specify the conditions for the **Message box** action.
  - a) In the **Enter the message box window title** field, enter `My first bot!`.
  - b) In the **Enter the message to display** field, enter `Go be great!`.
  - c) Accept the defaults in the **Scrollbar after lines** field and **Close message box after** check box.
4. Click **Save**.  
Your bot is now ready to run.

You can view the time spent to create a bot by navigating to **Automation > Home > My metrics**. The **Active Task Bots** table displays the time taken to create every bot. When a bot is edited, the table shows the total time spent on the bot.

For example, if you spend 10 minutes on creating and saving a bot, the **Active Task Bots** table displays the time spent as 10 minutes. If you spend 5 more minutes on editing the same bot, the **Active Task Bots** table displays the total time spent as 15 minutes.

Similarly, the **Average time spent to create a Task Bot** field on the **My Metrics** page displays the average time spent across all users on all bots.

For example, if user 1 spends 120 minutes on **Bot A**, user 2 spends 2 minutes on **Bot B**, and user 3 spends 4 minutes on **Bot C**, the average time is calculated as  $(120+2+4)/3 = 42$  minutes.

**5. Test your bot.**

Click **Run** at the top right.

The bot displays a Message box with the text `Go be great!`.

In the following steps, you configure a variable and insert it in the Message box.

**6. Create a variable.**

- a) Click **Variables** from the accordion menu on the left panel.
- b) Click **Create variable** (the + sign).
- c) Enter `vHelloWorld` in the name field.
- d) Select the **Use as output** option.
- e) Enter `Say Go be Great! with a variable` in the **Default value** field.
- f) Click **Create**.

**7. Assign the `vHelloWorld` variable to the **Enter the message to display** field.**

- a) Click the **Message box** action in the Bot editor.
- b) In the dialog box, delete the text from the **Enter the message to display** field.
- c) Either press the F2 key or click the **Insert variable** icon.  
The **Insert variable** icon is located on the right-side of the text field.
- d) Select `vHelloWorld` from the drop-down list.
- e) Click **Yes, insert**.

**8. Click **Save**.**

**9. Click **Run**.**

The bot displays a Message box with the text `Say Go be Great! with a variable`.

After you successfully run your bot, go to [Build a basic bot that uses a desktop application](#) on page 3199.

## Build a basic bot that uses a desktop application

Build a bot that uses a conditional statement to verify that the calculator is open, then uses the calculator to multiply two numbers. This example uses actions from the Application, If, Simulate keystrokes, Message Box, and Window packages.

To build a bot you must already have done the following:

- [Install Bot Agent and register device](#) on page 1347
  - [Set user device credentials](#) on page 1353
1. Open a new bot.
    - a) On the left panel, click **Automation**.  
A list of available bots and forms is displayed.
    - b) Click **Create new > Bot**.
    - c) Enter a bot name and click **Create and edit**.
  2. Insert an conditional sequence that verifies that the calculator is open and activates the window.
    - a) Double-click or drag the **If** action.
    - b) Select **Window exists** from the **Condition** drop-down list.
    - c) Select the **Application** tab and click the refresh icon to display all open applications.
    - d) Select **Calculator** from the **Window** drop-down list.  
The Calculator window is saved to the variable `window-1`.
    - e) Drag the **Message box** action into the **If** container.
    - f) In the **Enter the message to display** field, enter `The calculator is running`.
    - g) Drag the **Window > Activate** action into the **If** container below the **Message box** action.
    - h) In the **Window** field, insert the `window-1` variable.
  3. Insert an alternative sequence that opens the calculator.
    - a) Double-click the **If > Else** action.
    - b) Drag the **Message box** action into the **Else** container.
    - c) In the **Enter the message to display** field, enter `The calculator is not running`.
    - d) Drag the **Application > Open program/file** action into the **If** container below the **Message box** action.
    - e) In the **Location of the program/file** field, enter `C:\Windows\System32\calc.exe`.
  4. Insert the **Simulate keystrokes** action to perform the calculation.
    - a) Drag the **Simulate keystrokes** action below the **If** and **Else** containers.
    - b) In the **Window** field, insert the `window-1` variable.
    - c) In the **Keystrokes** field, enter `5*5=`.
    - d) In the **Delay** field, enter 500.
  5. Click **Save** to save the bot.
  6. Run the bot.

When the bot runs, the `The calculator is not running` message appears, then the Calculator window opens, and the calculation is performed.
  7. Run the bot again.

When the bot runs, the `The calculator is running` message appears, then the Calculator window activates, and the calculation is performed.



If the bot does not input all of the numbers into the calculator, try increasing the keystrokes delay.

## Example of extracting data from a web table

Build a bot to open a browser window to the Wikipedia website, extract the data from a table, and write it to a CSV file on your desktop. This example uses actions from the Browser, Data Table, Recorder, and Window packages.

To extract data from a table, do the following steps:

1. Create a new bot:
  - a) On the left panel, click **Automation**.
  - b) Click **Create new > Bot**.
  - c) In the **Create Task Bot** window, enter the bot name.
  - d) Accept the default folder location: `\Bots\`  
To change the default bot storage location, click **Choose** and follow the prompts.
  - e) Click **Create and edit**.

For information about bot naming conventions, see [Create your first bot](#) on page 1489.

2. Open a browser window to the web page from which you will extract the table.
  - a) Double-click or drag the **Browser > Open** action.
  - b) Select your preferred browser.
  - c) In the `Link to open` field, enter `https://en.wikipedia.org/wiki/Table_(information)`.
  - d) Click **Save**.
  - e) Click **Run**.  
The bot opens the window.
3. Specify the table.
  - a) Double-click or drag the **Recorder > Capture** action.
  - b) From the far-right panel, in the **Window** options, select the **Browser** tab and then select the **Table (information) - Wikipedia** window from the drop-down list.  
If the window title does not appear in the list, click **Refresh**.
  - c) Click **Capture object**.  
The **Table (information) - Wikipedia** window activates.
  - d) Hover over the Age table below the Basic description heading.  
An orange box appears, surrounding the table.
  - e) Click the table.  
The **Object Processing** message box appears.
  - f) Return to the Control Room.
  - g) In the Object properties table, verify the Control Type is TABLE.  
If it is not, click **Recapture object**.
  - h) From the Action to take on object drop-down list, select **Get table**.

- i) In the **Save the outcome to a variable** field, create the `Tabledata` variable.

The **Table (information) - Wikipedia** window is saved as the variable `$Browser1$`.

4. Specify the file where to save the data.
    - a) Double-click or drag the **Data Table > Write to file** action.
    - b) From the **Data table name** list, select `Tabledata`.
    - c) In the **Enter file name** field, select your file.  
For example, `C:\Users\\Desktop\WikipediaTable.csv`.
    - d) Select to overwrite the existing file.
  5. Close the **Table (information) - Wikipedia** window.
    - a) Double-click or drag the **Browser > Close** action.
    - b) Select the **Variable** tab and insert `$Browser1$`.
  6. Click **Save**.
  7. Click **Run**.
- The bot creates a CSV file on the desktop with data on seven indexes, their values, and net change.

## Examples of building bots

Use these example tasks to become familiar with the features and learn to build bots in Automation 360.

## Common automation tasks and examples

This document lists common automation tasks and examples for the tasks.

### Spreadsheet operations

Task	Subtasks/approaches	Example
Read data from spreadsheets	If the spreadsheet is large, you can connect to it as a database.	<a href="#">Connect to an Excel spreadsheet as database</a>
	Read individual rows.	<a href="#">Example of transferring data from CSV file to Excel worksheet on page 3216</a>
	Read data from an Excel spreadsheet and store it in a data table variable.	<a href="#">Example of reading data from a spreadsheet on page 3234</a>

Task	Subtasks/approaches	Example
	Read data from spreadsheets and write to a database.	<a href="#">Example of migrating data from Excel to a database on page 3231</a>
Write to spreadsheets	Create a new spreadsheet and write data to it.	<a href="#">Example of reading data from a spreadsheet on page 3234</a>
Merge spreadsheets	Merge two spreadsheets	<a href="#">Run TaskBot to merge Excel sheets on page 3229</a>

## SAP operations

Task	Subtasks/approaches	Examples
Call SAP BAPI functions	Get structure.	<a href="#">Example of using Get structure command from SAP BAPI package on page 3244</a> <a href="#">Example of using Run standard workflow from SAP BAPI package on page 3248</a>
	Write data to SAP using SAP BAPI.	<a href="#">Example of writing data to SAP using SAP BAPI package on page 3246</a>

## Variables, control flow, and logic operations

Task	Subtasks/approaches	Examples
Variables	Pass values between bots.	<a href="#">Example of passing a value between bots on page 3206</a>
	Use file variables.	<a href="#">Example of using a file variable on page 3280</a>
	Use dictionary variables.	<a href="#">Create dictionary type variables on page 3289</a>
Conditions	Use String condition.	<a href="#">Example of using a conditional statement on page 3208</a>

## Custom scripts integration in bots

Tasks	Subtasks/approaches	Example
Use custom Python scripts.	Invoke Python function in bots.	<a href="#">Build a hello world with a Python function</a>
		<a href="#">Example of using Python script to join a list on page 3209</a>
Use custom VBScript.	Invoke a VBScript function.	<a href="#">Example of using the VBScript package in a resilient bot on page 3250</a>

## Example of entering data into a web form from a spreadsheet

Build a bot that reads multiple rows of data from an XLSX sheet and enters it into a web form. Use actions from the Excel advanced, Loop, and Recorder packages to build the bot.

Before you start building the bot, you can create the following data sets on your desktop in .xlsx format as below.

Employee name	Age	Claim amount	Claim date	Claim type
Mike	30	469	22/3/2022	Medical
Sarah	34	766	28/3/2022	Dental
Chris	41	428	13/05/2022	Medical
Samantha	45	1000	09/05/2022	Medical

To read values from an Excel file and input them into a web form, do the following:

1. Create a new bot:
  - a) On the left panel, click **Automation**.
  - b) Click **Create new > Bot**.
  - c) In the **Create Task Bot** window, enter the bot name.
  - d) Accept the default folder location: \Bots\  
To change the default bot storage location, click **Choose** and follow the prompts.
  - e) Click **Create and edit**.
2. Open the Excel file.
  - a) Double-click or drag the **Excel advanced > Open** action.
  - b) Enter a session name.
  - c) Select the Excel file.

- d) Mark the **Sheet contains a header** option.

By marking the **Sheet contains a header** option, you enable the bot to search for the column by the header name during run time.

3. Launch the website.
  - a) Double-click or drag the **Browser > Open** action.
  - b) Enter the website URL which consists the webform to update the data.
4. Retrieve the worksheet values and store them in a Table variable.
  - a) Double-click or drag the **Excel advanced > Get multiple cells** action.
  - b) Enter the same session name you used in the **Excel advanced > Open** action.
  - c) Select **All rows** from the drop-down list.
  - d) Create a Table variable using the icon to the right of the **Assign to variable** drop-down list.
5. Instruct the bot to process the data row by row.
  - a) Double-click or drag the **Loop** action.
  - b) Select the **For each row in table** iterator.
  - c) Select the same Table variable that you used in **Get multiple cells**.
  - d) Create a Record variable using the icon to the right of the **Assign to variable** drop-down list.

The Record variable holds all of the values for one row. With each iteration of the Loop, the bot retrieves the values of the next row and stores them in the Record variable, overwriting the values from the previous row.

6. Map the first column header to the web form textbox.
  - a) Double-click or drag the **Recorder > Capture** action.
  - b) Select the same window you opened with the **Open** action.
  - c) Click **Capture object**.
  - d) Hover over the textbox until a red outline appears.
  - e) Click the textbox.
  - f) Return to the Control Room.
  - g) Verify that the **Control Type** value is TEXTBOX.
  - h) Select **Set text** from the **Action** drop-down list.
  - i) In the **Keystrokes** field, insert the same Record variable that you used in the Loop.
  - j) Select the **By name** option and copy-paste the first column header into the field.
7. Repeat the sub-steps in step 5 to map the other columns, with the following differences:
  - a) Instead of searching for the browser window title, insert the Window variable generated by the Recorder.
  - b) When inserting the Record variable in the **Keystrokes** field, copy-paste the subsequent column header into the "By name" field.

8. Capture the Submit button.
  - a) Double-click or drag the **Recorder > Capture** action.
  - b) Insert the Window variable generated by the Recorder.
  - c) Click **Capture object**.
  - d) Verify that the **Control Type** value is BUTTON.
  - e) Select the **Click** action.
  
9. Click **Save**.

Related reference

[Excel advanced package](#) on page 2565

The Excel advanced package contains actions that enable you to automate many of the repetitive tasks when working with Microsoft Excel spreadsheets.

[Loop package](#) on page 2784

Use the Loop package to run a sequence of actions repeatedly for a specific number of times or until a specific condition is met.

[Recorder package](#) on page 2916

Recorder package captures a series of tasks in a process and then automates them. You can automate your business applications (for example, desktop, Web, SAP, and Java applications) using the Recorder to capture actions performed on application objects such as a text box, button, table, radio button, combo box, and list view.

## Example of passing a value between bots

Learn how to pass a value from one Task Bot to another by using a dictionary variable.

Build a parent Task Bot and a child Task Bot that do the following:

- The parent bot prompts the user to enter a song title and passes it to the child bot.
- The child bot takes the input string and returns a new string to the parent bot.
- The parent bot receives the string that the child bot passes as a dictionary.

1. Build a child bot.
  - a) From the Control Room interface, go to the **Automation** tab.
  - b) Click **Create New > Bot**.
  - c) Enter the name for the bot as `GetSongDetails`.
  - d) Click **Create and Edit**.
  
2. Create a variable named `sMySong`.
  - a) In the **Variables** panel, click the Create variable button.
  - b) In **Type**, select **String** if it is not already selected.
  - c) In **Name**, enter `sMySong`.
  - d) Select the **Use as input** and **Use as output** check boxes.
  - e) Click **Create**.

3. To build a return string, use the **String > Assign** action.
  - a) From the **Actions** panel, find the **String > Assign** action, and add it to the child bot flow.
  - b) In **Select the source string variable(s)/ value**, enter `I love ${sMySong} too!`.  
During runtime, `${sMySong}` in the output string will be replaced with the value that the parent bot passes to the child bot.
  - c) In **Select the destination string variable**, select `sMySong` to store the new string.
  - d) Click **Save**.
  
4. Build the parent bot.
  - a) On the left panel, click **Automation**.  
A list of available bots and forms is displayed.
  - b) Click **Create New > Bot**.
  - c) Enter the name for the bot as `FavoriteSong-Parent`
  - d) Click **Create and Edit**.
  
5. Create a variable named `sMySong`.
6. Use the **Prompt > For value** action to capture a song title.
  - a) From the **Actions** panel, find and add the **Prompt > for value** action to the parent bot flow.
  - b) In the **Prompt window caption** field, enter `Favorite Song`.
  - c) In the **Prompt message** field, enter `Type the title of your favorite song.`
  - d) In the **Assign the value to a variable** field, enter `sMySong`.
  - e) Click **Save**.
  
7. Use the **Task Bot > Run** action to call the child bot:
  - a) From the **Actions** panel, find and add the **Task Bot > Run** action to the parent bot flow.
  - b) In **Task Bot to run**, select **Control Room** and then click **Choose**.
  - c) Click **Browse** and navigate to the folder that contains the child bot and select `GetSongDetails`.
  - d) In **Input values**, select **Set sMySong** and then enter `${sMySong}` in the variable field.
  - e) In **Save the outcome to a variable (option)**, select **Dictionary** and then create a variable named `dOutput`.
  - f) Click **Save**.
  
8. Use the **Message box** action to display the string that the child bot returns.
  - a) From the **Actions** panel, find and add the **Message box > Message box** action to the parent bot flow.
  - b) In **Enter the message box window title**, enter `Automation Anywhere Enterprise Client`.
  - c) In **Enter the message to display**, enter `${dOutput {sMySong}}$`.  
The name of the output variable that the child bot uses is used as the key for retrieving the value from the dictionary variable.

- d) Click **Save**.
9. Test the bot.
- a) Click **Run** to run the bot.  
After bot is deployed, the **Favorite Song** input box opens.
  - b) In the **Favorite Song** input box, enter a song title.
  - c) Click OK.  
A message box should display the string that the child bot returns. If no value returns, then review the procedure to assign the incoming value to a dictionary key and a variable.

Related reference

[Dictionary package](#) on page 2493

The **Dictionary** package contains actions that enable you to do various operations on dictionary-type values.

## Example of using a conditional statement

In this example, you build a bot that prints a message based on whether a cell has a value or is empty. Use the actions from the Excel basic or Excel advanced, If, and Message Box packages.

Before building this bot, save an empty Excel worksheet to the desktop.

Because this bot does not create a new Excel worksheet, you can use either the Excel basic or Excel advanced packages.

---

**Note:** All of the actions must be from the same package.

---

1. Open a new bot.
  - a) On the left panel, click **Automation**.  
A list of available bots and forms is displayed.
  - b) Click **Create new > Bot**.
  - c) Enter a bot name and click **Create and edit**.
2. Use the **Open** action from the Excel basic or the Excel advanced package to open the Excel sheet.
  - a) Double-click or drag the **Open** action.
  - b) Enter a session name.
  - c) Click **Browse** to provide the file path to the empty Excel worksheet on the desktop.
3. Use the **Get single cell** action to assign the value of a cell to a string variable.
  - a) Double-click or drag the **Get single cell** action from the same package that you used for the **Open** action.
  - b) Provide the session name that you used in the **Open** action.
  - c) Select the **Active cell** option.
  - d) In the **Store cell contents to** field, create the variable Output.



4. Use the **If** action to configure the conditional statement.
  - a) Double-click or drag the **If** action.
  - b) Select **String** from the **Condition** drop-down list.
  - c) In the **Source value** field, insert the variable `Output`.
  - d) Select **Equals to** as the **Operator**.
  - e) Leave the **Target value** field empty.
5. Insert a Message box into the **If** container.
  - a) Drag the **Message box** action.
  - b) In the **Enter the message to display** field, enter `Cell is empty`.
6. Use the **Else** and **Message box** actions to configure the alternative sequence of actions.
  - a) Drag the **Else** action next to the **If** action.
  - b) Drag the **Message box** action into the **Else** container.
  - c) In the **Enter the message to display** field, enter `Cell is not empty`.
7. Click **Save**.
8. Run the bot.

As the bot runs, the message box appears with the message `Cell is empty`.
9. Enter a value into the cell located at A1 in the Excel sheet and save the sheet.
10. Run the bot.

As the bot runs, the message box appears with the message `Cell is not empty`.

Related reference

[Excel advanced package](#) on page 2565

The Excel advanced package contains actions that enable you to automate many of the repetitive tasks when working with Microsoft Excel spreadsheets.

[If package](#) on page 2724

Use the actions in the **If** package to control the sequence of execution based on one or more conditions of a task.

[Message box package](#) on page 2796

Use the **Message box** action from the **Message box** package to insert a message box that shows a message when the task runs. For example, you can insert a **Message Box** action to follow a web form so that the action displays the message: `Web Form Filled and Complete`.

## Example of using Python script to join a list

Build a bot that uses a Python function to print the message `Go Be Great!`, the Automation Anywhere version of `Hello World`. In this example, the bot combines a list of string values and prints them to a message box.

To run Python script from Automation 360, you must already have the latest version of Python 3.x installed on your device.

1. Create a new bot:
  - a) On the left panel, click **Automation**.

- b) Click **Create new > Bot**.
      - c) In the **Create Task Bot** window, enter the bot name.
      - d) Accept the default folder location: \Bots\  
To change the default bot storage location, click **Choose** and follow the prompts.
      - e) Click **Create and edit**.
  2. Create a variable to hold the list values:
    - a) Click the **Create variable** icon.
    - b) Enter `lArgument` in the **Name** field.

---

**Recommendation:** Prefix the variable name with a lowercase character to indicate the variable data type.

[Variable naming](#) on page 2332

---

- c) Select the **List** type and **String** subtype.
      - d) In the **Default value** field, enter the following values:
        1. **Value at 0:** Go
        2. **Value at 1:** Be
        3. **Value at 2:** Great
        4. **Value at 3:** !
      - e) Click **Create**.
  3. Provide the script with a **Python Script > Open** action:
    - a) Double-click or drag the **Python Script > Open**.
    - b) Select the **Manual input** option.
    - c) Copy and paste the following text into the **Enter script here** field.

```
def data ( str ):  
    x = " ".join( str )  
    return x
```

4. Use a **Python Script > Execute function** action to tell the bot to run the script:
        - a) Double-click or drag **Python Script > Execute function**.
        - b) Enter `data` in the **Enter name of function to be executed** field.
        - c) Select the **lArgument** variable from the **Arguments to the function** drop-down list.
        - d) Create the variable `sOutput` for the **Assign the output to variable** field.
  5. Insert a **Message box** action to hold the Python function output:
    - a) Double-click or drag the **Message box > Message box** action.
    - b) In the **Enter the message to display** field, select and insert the variable `sOutput`.

- c) Select the **Close message box after** option. Retain the default value of 5 seconds in the field.
6. Close the script execution session with a **Python Script > Close** action:
  - a) Double-click or drag **Python Script > Close**.
  - b) Click **Save**.
7. Click the **Run** icon.

The bot generates a message box with the text Go Be Great!. After 5 seconds, the message box disappears.

To review the bot launcher logs, navigate to C:\ProgramData\AutomationAnywhere\BotRunner\Logs\\Bot\_Launcher-<today's date>.log.zip. Each zipped folder contains a file with data on the code execution, which is useful for debugging.

Related reference

[Python Script package](#) on page 2907

The Python Script package contains actions that enable Python Script functions in a task.

[Message box package](#) on page 2796

Use the **Message box** action from the **Message box** package to insert a message box that shows a message when the task runs. For example, you can insert a **Message Box** action to follow a web form so that the action displays the message: Web Form Filled and Complete.

## Example of using the DLL package

Build a very simple DLL that will generate a message. Create a bot to run the DLL.

This topic shows how to create a DLL package. If you do not have Microsoft Visual Studio, download the free Community version from [Microsoft Visual Studio Community IDE](#).

Create the DLL package.

1. In Microsoft Visual Studio, create a new class library that will generate a file type .dll by using C#.ol style="list-style-type: none;">- a) Navigate to **File > New > Project**.
- b) Search for d11 in the **Search for templates** field.
- c) Select the C# library option.
- d) Configure your project as follows:
  - Project name: DemoDLL
  - Location: [Any]
  - Solution Name: DemoDLL
- e) Click **Create**.
- f) Copy the following code and replace the contents of class1.cs by pasting:

```
using System;
using System.Collections.Generic;
using System.Linq;
using System.Text;
```

```

using System.Threading.Tasks;

namespace DemoDLL
{
    public class CallMe
    {
        public string ImHere()
        {
            String Reply = "You are now inside the DemoDLL,
ImHere function!";
            return Reply;
        }
    }
}

```

- g)** In **Solution Explorer**, right-click **Class1.cs** and rename it to "CallMe.cs".
- h)** Navigate to **File > Save All**.
- i)** Navigate to **Build > Build Solution**.  
The output window confirms that the DLL package was successfully created and displays the path to your new DemoDLL.dll package in the **Output** window. Note the package location, as you will need it later to enter into the bot.

Create a bot to execute the DLL package.

- 2.** Create a bot.
  - a)** On the left panel, click **Automation**.  
A list of available bots and forms is displayed.
  - b)** Click **Create New > Bot**.
  - c)** Provide a name for the bot: MyDLLbot
  - d)** Enter the folder location: Bots\TaskBotExample
  - e)** Click **Create and Edit**.
- 3.** Create a variable: sReturnedString: string type.  
[Create a variable](#) on page 2336
- 4.** Use a **DLL > Open** action to load your DLL package.
  - a)** From the Actions pane, double-click or drag the **DLL > Open** action.
  - b)** In the **DLL:Open, Filepath** field, select file type **Desktop file** and click **Browse** to find your DLL package. Click **Open**.
  - c)** Click **Save**.
- 5.** Use a **DLL > Run function** action to execute your DLL package.
  - a)** Double-click or drag the **DLL > Run function** action to the last line of the bot.
  - b)** Click **Get DLL Details**.
  - c)** Select **Desktop file** type and then click **Browse**. Locate your DLL package and click **Open**.
  - d)** Click **Next**.
  - e)** Expand the DemoDLL namespace and select the **CallMe** function. Select method **ImHere** and click **Apply**.

- f) In the **Assign the value to a variable** field, select `sReturnedString`.
6. Use a **Message box** action to report what was returned from the DLL bot:
  - a) Double-click or drag the **Message box** action to the last line of the bot.
  - b) In the **Enter the message to display** field, type: `From the DLL: "$sReturnedString$"`.
7. Click **Save**.
8. Use the **DLL > Close** action to end the DLL session.
  - a) Double-click or drag the **DLL > Close** action to the last line of the bot.
9. Click **Save**.
10. Click the **List** tab to view your code in text-only mode.  
Your code should look like this:

```
Start
DLL:Open "C:\myFolder\source\repos\DemoDLL\DemoDLL\bin\Debug
\DemoDLL.dll for session "Default"
DLL:Run function "ImHere" and store output in variable
  $sReturnedString$ and session "Default"
MessageBox "From the DLL: "$sReturnedString$".
DLL:Close session "Default"
End
```

11. Run your bot.  
The DLL package returns a message to the bot: **From the DLL: "You are now inside the DemoDLL, ImHere function!"**.

Related reference

[DLL package](#) on page 2498

A dynamic-link library (DLL) file contains a shared library of functions that can be used by Windows programs. The **DLL** package uses a `.dll` file as reference and calls functions from the bot.

## Example of using To string action from Datetime package

Build a bot that compares the current date with the expiration dates of products.

You need sample inventory data with expiration dates. If you do not have any sample data, download [this spreadsheet](#) that contains sample inventory data with expiration dates.

In this example, the bot loops through a list of products in a spreadsheet and compares the expiration date of each product with the current date. If the dates match, the bot marks the product as expired.

1. Create a new bot.
  - a) On the left panel, click **Automation**.
  - b) Click **Create new > Task Bot**.
  - c) In the **Create Task Bot** window, enter a name for the bot.
  - d) Accept the default folder location: `\Bots\`
  - e) To change the default bot storage location, click **Choose** and follow the prompts.

- f) Click **Create and edit**.
2. Dates in the sample data are specified in yyyy-MM-dd format. To compare each date to the current date, you need to obtain the current date using the System:Date variable and convert it to the yyyy-MM-dd format. To do so, use the **Datetime > To string** action and the System:Date variable.
    - a) From the **Actions** panel, find and add **Datetime > To string** action to the Bot editor.
    - b) In **Source date and time variable**, click **Variable**, and enter `System:Date`. You can use the System:Date variable to get the current date.
    - c) In **Select date time format**, click **Custom format**, and enter `yyyy-MM-dd`.
    - d) In **Assign the output to a variable**, click **(x)** and create a string variable named `currentDate`.
    - e) Save the changes.
  3. Open the spreadsheet with the sample inventory data.
    - a) From the **Actions** panel, find and add **Excel basic > Open** action to the Bot editor.
    - b) In **File path**, click **Desktop file** and select the spreadsheet with the sample inventory data.
    - c) Select **Sheet contains a header**.
    - d) Select **Specific sheet name** and enter the sheet name. If you are using the sample spreadsheet downloaded from this page, specify `inventory` as the sheet name.
    - e) In **Create Excel session**, click **Local session** and enter `Default`.
    - f) Save changes.
  4. Select the second row in the current spreadsheet.
    - a) From the **Actions** panel, find and add **Excel basic > Go to cell** action to the Bot editor.
    - b) In **Cell option**, click **Specific cell** and then enter `A2` in **Cell name**.
    - c) In **Session name**, enter `Default`.
    - d) Save changes.
  5. Iterate through the rows in the spreadsheet and get the expiry date for each product.
    - a) From the **Actions** panel, find and add **Loop > Loop** action to the Bot editor.
    - b) In **Iterator**, choose **Excel basic > For each row in worksheet**.
    - c) In **Loop through**, select the **All rows** variable.
    - d) In **Session name**, enter `Default`.
    - e) In **Assign the current row to this variable**, click **Record**, and click **(x)** to create a record variable named `ExcelRow`.
    - f) Save changes.
  6. Compare each expiry date with the current date.
    - a) From the **Actions** panel, find and add **String > compare** action within the Loop action.
    - b) In **Source string**, enter `currentDate`.
    - c) In **Compare to string**, enter `ExcelRow[2]`.

- d) In **Assign the output to variable**, click **(x)** to create a Boolean variable named `datesMatched`.
        - e) Save the changes.
- 7. Verify if the current date matches the expiry date of the current item.
  - a) From the **Actions** panel, find and add **If > If** action with the Loop action.
  - b) In **Condition**, select **Boolean > Boolean condition**.
  - c) In **Boolean variable**, click **True**.
  - d) In **Operator**, select **Equals to(=)**.
  - e) In **Value**, click **Variable** and enter `datesMatched`.
  - f) Save the changes.
- 8. If the dates match, move the cursor to the end of the current row.
  - a) From the **Actions** panel, find and add **Excel basic > Go to cell** action within the If action.
  - b) In **Cell option**, click **Active cell** and then select **End of the row**.
  - c) In **Session name**, enter `Default`.
  - d) Save changes.
- 9. If the dates match, mark the product as expired.
  - a) From the **Actions** panel, find and add **Excel basic > Set cell** action within the if action.
  - b) In **Use**, click **Active cell**.
  - c) In **Value to set**, enter `Yes`.
  - d) In **Session name**, enter `Default`.
  - e) Save the changes.
- 10. Select the first cell in the current row.
  - a) From the **Actions** panel, find and add **Excel basic > Go to cell** action after the If action but within the Loop action.
  - b) In **Cell option**, click **Active cell** and then select **Beginning of the row**.
  - c) In **Session name**, enter `Default`.
  - d) Save changes.
- 11. Select the next row before the next iteration.
  - a) From the **Actions** panel, find and add **Excel basic > Go to cell** action within the Loop action.
  - b) In **Cell option**, click **Active cell** and then select **One cell below**.
  - c) In **Session name**, enter `Default`.
  - d) Save changes.
- 12. Close the current spreadsheet.
  - a) From the **Actions** panel, find and add **Excel basic > Close** action after the Loop action.

- b) Select **Save the changes when closing the file**.
- c) In **Session name**, enter Default.
- d) Save changes.

## Example of transferring data from CSV file to Excel worksheet

Build a bot that reads data from a CSV file and updates the data in an Excel worksheet, using actions from the CSV/TXT, Excel advanced, IF/ELSE, and Loop packages.

Before you start building the bot, create the following data sets on your desktop in the specified file formats:

Data set 1: ProductInventory.xlsx

Item number	Name	Count	Category	Unit price	Taxable
A0001	Milk	15	Grocery	3	N
A0002	Eggs	6	Grocery	4	N
A0003	Flower	3	Garden	10	Y
A0004	Table	1	Home	50	Y
A0005	Towel	4	Home	10	Y
A0006	Dog Food	16	Pet	22	N
A0007	Paint	43	Home	12	Y

Data set 2: NewProductNames.csv

Item number	Name
A0005	Hand Towel
A0002	Chicken Eggs
A0003	Sunflower
A0004	Coffee Table
A0006	Dog Food - Small Dogs
A0007	Paint - Dark Blue
A0001	2% Milk

In this example, you will build a bot to update the product inventory in an Excel worksheet with new product names from a CSV file. The Excel worksheet has old product names and the CSV file has new product names. You will relate the data in the Excel worksheet and the CSV file with



item number and update the Excel worksheet with the new item name corresponding to the item number. Use actions from the CSV/TXT, Excel advanced, IF/ELSE, and Loop packages

1. Create a new bot:
  - a) On the left panel, click **Automation**.
  - b) Click **Create new > Bot**.
  - c) In the **Create Task Bot** window, enter the bot name.
  - d) Accept the default folder location: `\Bots\`  
To change the default bot storage location, click **Choose** and follow the prompts.
  - e) Click **Create and edit**.
  
2. Open the `NewProductNames.csv` file that you just created.
  - a) Double-click or drag the **CSV/TXT > Open** action.
  - b) In the **Session name** field, enter `session 1`.
  - c) Provide the file path to `NewProductNames.csv`.
  - d) Select the **Contains header** option.
  
3. Open the `ProductInventory.xlsx` file that you just created.
  - a) Double-click or drag the **Excel advanced > Open** action.
  - b) In the **Session name** field, enter `session 2`.
  - c) Provide the file path to `ProductInventory.xlsx`.
  - d) Choose to open the file in **Read-write** mode.
  - e) Select the **Contains header** option.
  
4. Use the **Go to cell** action to indicate the first cell in which to update the product names.
  - a) Double-click or drag the **Excel advanced > Go to cell** action.
  - b) In the **Session name** field, enter `session 2`.
  - c) Select the **Specific cell** option and enter `B2`.
  
5. Use a **Loop** action to retrieve the cell values in each row from `ProductInventory.xlsx`.
  - a) Double-click or drag the **Loop** action.
  - b) Select the **Excel Advanced > For each row in worksheet** iterator.
  - c) In the **Session name** field, enter `session 2`.
  - d) In the **Loop through** field, select **All rows**.
  - e) In the **Assign current value to this variable** field, create a `rInventory` variable.
  
6. Use a **Loop** action to retrieve the cell values in each row from `NewProductNames.csv`.
  - a) Drag the **Loop** action into the **For each row in worksheet Loop** container.
  - b) Select the **For each row in CSV/TXT** iterator.
  - c) In the **Session name** field, enter `session 1`.
  - d) In the **Assign current value to this variable** field, create a `rNewProduct` variable.

7. Use an **If** action to compare the item number from `ProductInventory.xlsx` to the item number from `NewProductNames.csv` to ensure they are the same before moving on to the next action.
  - a) Double-click or drag the **If** action into the **For each row in csv/txt Loop** container.
  - b) Select the **String** condition.
  - c) In the **Source value** field, input `rInventory[0]`.
  - d) Select the **Equals to (=)** operator.
  - e) In the **Target value** field, input `rNewProduct[0]`.
  
8. Use the **Set cell** and **Go to cell** actions to update the product name and move to the cell below.
  - a) Double-click or drag the **Excel Advanced > Set cell** action.
  - b) In the **Session name** field, enter `session 2`.
  - c) Select the **Active cell** option.
  - d) In the **Cell value** field, input `rNewProduct{Name}`
  - e) Double-click or drag the **Excel Advanced > Go to cell** action.
  - f) In the **Session name** field, enter `session 2`.
  - g) From the **Active cell** drop-down list, select **One cell below**.
  
9. Insert an alternative to the **If** action: if the item numbers are not the same, the bot continues to the next row in `NewProductNames.csv`.
  - a) Drag the **If > Else** action.
  - b) Drag the **Loop > Continue** action.
  
10. Close the files.
  - a) Double-click or drag the **Excel advanced > Close** action.
  - b) In the **Session name** field, enter `session 2`.
  - c) Select the **Save changes** option.
  - d) Double-click or drag the **CSV/TXT > Close** action.
  - e) In the **Session name** field, enter `session 1`.
  
11. Click **Save**.
12. Run the bot.

The bot updates the `ProductInventory.xlsx` file to look like the following table:

Data set 3: `ProductInventory.xlsx`

Item number	Name	Count	Category	Unit price	Taxable
A0001	2% Milk	15	Grocery	3	N
A0002	Chicken Eggs	6	Grocery	4	N
A0003	Sunflower	3	Garden	10	Y

Item number	Name	Count	Category	Unit price	Taxable
A0004	Coffee Table	1	Home	50	Y
A0005	Hand Towel	4	Home	10	Y
A0006	Dog Food - Small Dogs	16	Pet	22	N
A0007	Paint - Dark Blue	43	Home	12	Y

Related reference

[CSV/TXT package](#) on page 2449

The **CSV/TXT** package contains actions that enable you to open a CSV or text file, read data from that file, and assign the data to a Table variable. This package supports files encoded in ANSI, Unicode, UTF-8, or Windows-1251, and can process up to one million records.

[Excel advanced package](#) on page 2565

The Excel advanced package contains actions that enable you to automate many of the repetitive tasks when working with Microsoft Excel spreadsheets.

[If package](#) on page 2724

Use the actions in the **If** package to control the sequence of execution based on one or more conditions of a task.

[Loop package](#) on page 2784

Use the Loop package to run a sequence of actions repeatedly for a specific number of times or until a specific condition is met.

## Example of using Find file/folder action from Google Drive package

Build a bot that searches Google Drive for a file and creates the file if it is not found in the specified path.

- Set up an OAuth2 application in Google Cloud Platform. For more information, see [Set up OAuth2 in the Google Cloud Platform](#).
- This bot uses the Control Room OAuth connection method. Configure OAuth connection in the Control Room. For more information, see [Configure OAuth2 parameters in the Control Room](#) on page 2865.
- A CSV file with some sample data. If you do not have a CSV file, you can download [this file](#).

Imagine you want to create a Google sheet if it does not exist in Google Drive. You can use the **Google Drive > Find File/Folder** action from the Google Drive package to check if a file already exists in Google Drive. If it does not exist, you can create the file using the Create Workbook action from the Google Sheets package.

This bot checks Google Drive for a Google sheet. If it does not exist in the path specified, the bot creates a Google sheet and copies data from a CSV file to it.

1. Create a new bot.
  - a) On the left panel, click **Automation**.

- b) Click **Create new > Task Bot** .
      - c) In the **Create Task Bot** window, enter a name for the bot.
      - d) Accept the default folder location: \Bots\
      - e) To change the default bot storage location, click **Choose** and follow the prompts.
      - f) Click **Create and edit**.
2. Open the CSV file that contains data you want to copy to a Google Sheet.
  - a) From the **Actions** panel, find and add **CSV/TXT > Open** action to the Bot editor.
  - b) In **Session name**, enter `csvsession`.
  - c) In **File path**, specify the path to the CSV file from which data should be copied.
  - d) If the CSV table has a header, select **Contains header**.
  - e) Select a delimiter as per the delimiter used in the CSV file.
  - f) Save the changes.
3. Read data from CSV and store it in a data table variable.
  - a) From the **Actions** panel, find and add **CSV/TXT > Read** action to the Bot editor.
  - b) In **Session name**, enter `csvsession`.
  - c) In **Assign value to the variable**, click **(x)** and create a variable called TableFromCSV.
  - d) Save the changes.
4. Close the CSV file.
  - a) From the **Actions** panel, find and add **CSV/TXT > Close** action to the Bot editor.
  - b) In **Session name**, enter `csvsession`.
  - c) Save the changes.
5. Connect to Google Drive.
  - a) From the **Actions** panel, find and add **Google Drive > Connect** action to the Bot editor.
  - b) In **Username**, select **Insecure string**, and enter the email ID associated with OAuth connection you have set up.
  - c) In **OAuth2 Authentication Mode**, select **Control Room managed**.
  - d) Click **Pick** and select the connection you have configured in Control Room.
  - e) Save the changes.
6. Connect to Google Sheets.
  - a) From the **Actions** panel, find and add **Google Sheets > Connect** action to the Bot editor.
  - b) In **Username**, select **Insecure string** and enter the email ID associated with OAuth connection you have set up.
  - c) In **Session name**, enter `gsheetsession`.
  - d) In **OAuth2 Authentication Mode**, select **Control Room managed**.
  - e) Click **Pick** and select the connection you have configured in Control Room.

- f) Save the changes.
7. Before you create a new sheet in Google Drive, check if the file you are trying to create already exists. Create the file only if it does not exist in the specified path. To do this , use the Try Catch actions.
- a) From the **Actions** panel, find and add **Error Handler > Try** action to the Bot editor.
  - b) Save the changes.
8. To check if the file already exists, use the Google Drive Find file/folder action.
- a) From the **Actions** panel, find and add **Google Drive > Find file/folder** action within the Try block.
  - b) In **Username**, select **Insecure string** and enter the email ID associated with the OAuth connection.
  - c) In **Find**, click **File**.
  - d) In **Source Folder Path**, enter the source folder. For example, in this sample scenario, the bot looks for the file in the aa-docs/spreadsheets path.
  - e) In **Match type**, select **Exactly matches**.
  - f) In **File/Folder name**, enter `contacts`.
  - g) In **Returns the list of files or folders**, select **Dictionary**.
  - h) Click **(x)** , and create a dictionary variable named FileFolderDictionarywith subtype as **Any**.
  - i) Save changes.
9. If the file does not exist, create the file.
- a) From the **Actions** panel, find and add **Google Sheets > Create workbook** action within the Catch block.
  - b) In **Username**, select **Insecure string** and enter the email ID associated with the OAuth connection.
  - c) In **Session name**, enter `gsheetsession`.
  - d) In **Workbook name**, enter `contacts`.
  - e) In **File path**, click **From my shared location**, and enter the parent folder path. For example, in this sample in scenario, the botsearches for the file in the aa-docs/spreadsheets path.
  - f) Save changes.
10. To open a spreadsheet from Google Drive, you need its file ID or the file path. Since this bot creates the file dynamically, you will not have the file path prior to the bot execution. However, you can get the File ID using the Google Drive Find file/folder actionagain.
- a) From the **Actions** panel, find and add **Google Drive > Find file/folder** action after the Try Catch blocks.
  - b) In **Username**, select **Insecure string** and enter the email ID associated with the OAuth connection.
  - c) In **Find**, click **File**.

- d) In **Source Folder Path**, enter the source folder. For example, the sample bot in this example looks for the file in the aa-docs/spreadsheets path.
- e) In **Match type**, select **Exactly matches**.
- f) In **File/Folder name**, enter contacts.
- g) In **Returns the list of files or folders**, click **Dictionary** and select the **FileFolderDictionary** variable.

The Find file/folder API returns a dictionary with information about matched files. The dictionary contains a key called NumberOfFiles. It provides the count of files that matched. The dictionary also contains keys named File1, File2, and so on, depending on the number of matched files. These keys contain information such as file names and file IDs in JSON format. The following is an example of a dictionary returned by the Find file/folder API call:

```
{NumberOfFiles,1},{File1,  
{"fileName":"contacts","fileId":"171yBUzqH80ZW_KLEp23DwebzkCdDZgnGFWBzB6K9kco"}}
```

You can retrieve the file ID by parsing the JSON string, which is the value associated with the key File1.

- h) Save changes.
11. Parse the JSON string associated with the File1 key.
    - a) From the **Actions** panel, find and add **Json > Start session** action.
    - b) In **Data source**, select **Text** and enter `$FileFolderDictionary{File1}$`
    - c) In **JSON object session**, click **Local session** and enter `jsonsession`.
    - d) Save the changes.
  12. Retrieve file ID from the JSON object.
    - a) From the **Actions** panel, find and add **Json > Get node value**.
    - b) In **JSON node key or path**, enter `fileId`
    - c) In **Session name**, enter `jsonsession`.
    - d) In **Save the outcome to a variable**, click **(x)** and create a variable called `FileId`.
    - e) Save the changes.
  13. End the JSON session.
    - a) From the **Actions** panel, find and add **Json > End session** action.
    - b) In **Session name**, enter `jsonsession`.
    - c) Save the changes.
  14. With the retrieved file ID, open the spreadsheet created in Google Drive.
    - a) From the **Actions** panel, find and add **Google Sheets > Open spreadsheet** action.
    - b) In **Username**, select **Insecure string** and enter the email ID associated with the OAuth connection.
    - c) In **Session name**, enter `gsheetsession`
    - d) In **Open sheet**, click **From Spreadsheet Id**, and enter `$FileId$`.

- e) Save the changes.
15. Write the data table variable to the Google sheet.
    - a) From the **Actions** panel, find and add **Google Sheets > Write from data table** action.
    - b) In **Session name**, enter `gsheetsession`
    - c) In **Sheet options**, click **Specific Sheet** and enter `Sheet1` or the sheet name from your target spreadsheet in **Sheet name**.
    - d) In **Enter data table variable**, select **TableFromCSV**
    - e) In **Start Cell value**, enter `A1`.
    - f) Save the changes.
  16. Disconnect Google Drive and Google Sheets.
    - a) From the **Actions** panel, find and add **Google Drive > Disconnect** action.
    - b) In **Username**, select **Insecure string** and enter the email ID associated with the OAuth connection.
    - c) Save changes.
    - d) From the **Actions** panel, find and add **Google Sheets > Disconnect** action.
    - e) In **Username**, select **Insecure string** and enter the email ID associated with the OAuth connection.
    - f) In **Session name**, enter `gsheetsession`
    - g) Save the changes.
  17. Run the bot.

## Example of using Create Folder action from Google Drive package

Build a bot that creates a folder in Google Drive.

- Set up an OAuth2 application in Google Cloud Platform. For more information, see [Set up OAuth2 in the Google Cloud Platform](#).
- Configure OAuth connection in the Control Room. For more information, see [Configure OAuth2 parameters in the Control Room](#) on page 2865.
- Create a parent folder in Google drive. In the example, the `aa-docs/monthly-reports` is used as the parent folder.

Suppose that ACME Inc stores all its monthly reports on Google Drive. To streamline the process, the company decides to develop a bot that creates a new folder at the beginning of each month and then uploads the reports to the folder.

In this example, the bot performs the following tasks:

- Uses the Datetimepackage to retrieve the current date.
- Uses the Create Folder action from theGoogle Drivepackage to create a folder with the current date as its name.

- Displays the ID of the new folder.
1. Create a new bot.
    - a) On the left panel, click **Automation**.
    - b) Click **Create new > Task Bot**.
    - c) In the **Create Task Bot** window, enter a name for the bot.
    - d) Accept the default folder location: \Bots\
    - e) To change the default bot storage location, click **Choose** and follow the prompts.
    - f) Click **Create and edit**.
  2. The bot creates a folder at the start of every month with the format the <current date>-report as its name. To get the current date, use the **Datetime > To string** action and the System: Date variable.
    - a) From the **Actions** panel, find and add **Datetime > To string** action to the Bot editor.
    - b) In **Source date and time variable**, click **Variable**, and enter \$System:Date\$. You can use the System: Date variable to get the current date.
    - c) In **Select date time format**, click **Custom format**, and enter dd-MM-yyyy.
    - d) In **Assign the output to a variable**, click **(x)** and create a string variable named currentDate.
    - e) Save the changes.
  3. Connect to Google Drive.
    - a) From the **Actions** panel, find and add **Google Drive > Connect** action to the Bot editor.
    - b) In **Username**, select **Insecure string**, and enter the email ID associated with OAuth connection you have set up.
    - c) In **OAuth2 Authentication Mode**, select **Control Room managed**. For more information, see [Use managed OAuth2 authentication in Google](#).
    - d) Click **Pick** and select the connection you have configured in Control Room.
    - e) Save the changes.
  4. Create a folder.
    - a) From the **Actions** panel, find and add **Google Drive > Create Folder** action.
    - b) In **Username**, enter the email ID in **Insecure string**.
    - c) In **Parent folder name**, enter the path to the parent folder where the new folder must be created. For example, aa-docs/monthly-reports.
    - d) In **Folder name**, enter \$currentDate\$-report.
    - e) In **Returns the ID of created folder**, click **(x)** and create a string variable named FolderID.
    - f) Save changes.
  5. Display the folder ID.
    - a) From the **Actions** panel, find and add **Message Box > Message Box** action within the Catch block.
    - b) In **Enter the message to display**, enter \$FolderID\$.



- c) Save the changes.

You can improve this example by using the folder ID to do additional processing. For example, you can use the Upload files action to upload files to the new folder. However, this use case is not covered in this example.

6. Run the bot.

If you are using device pools, you can schedule the bot to run at the start of every month.

## Example of using Go to Cell action from Google Sheets package

Build a bot that loops through the records in a Google Sheet and creates a report based on the records.

- Set up an OAuth2 application in Google Cloud Platform. For more information, see [Set up OAuth2 in the Google Cloud Platform](#).
- Configure OAuth connection in the Control Room. For more information, see [Configure OAuth2 parameters in the Control Room](#) on page 2865.
- Make sure you have a spreadsheet with some sample product inventory data in Google Drive. If you do not have any sample data, you can download [this spreadsheet](#) and copy the data from it to a Google Sheet in your Google Drive. Make a note of its file ID.
- Create another Google Sheet where the bot can copy data from the inventory list. Name the file "restock" and make a note of the file ID.

In the example, the bot loops through an inventory list in a Google Sheet and finds products that need to restocked. After that, the bot updates another Google Sheet with the details of the products that require restocking.

1. Create a new bot.
  - a) On the left panel, click **Automation**.
  - b) Click **Create new > Task Bot**.
  - c) In the **Create Task Bot** window, enter a name for the bot.
  - d) Accept the default folder location: \Bots\
  - e) To change the default bot storage location, click **Choose** and follow the prompts.
  - f) Click **Create and edit**.
2. Connect to Google Sheets.
  - a) From the **Actions** panel, find and add **Google Sheets > Connect** action to the Bot editor.
  - b) In **Username**, select **Insecure string** and enter the email ID associated with OAuth connection you have set up.
  - c) In **Session name**, enter gsheets.
  - d) In **OAuth2 Authentication Mode**, select **Control Room managed**.
  - e) Click **Pick** and select the connection you have configured in Control Room.
  - f) Save the changes.

3. Open the spreadsheet that contains the inventory list.
  - a) From the **Actions** panel, find and add **Google Sheets > Open spreadsheet** action to the Bot editor.
  - b) In **Username**, select **Insecure string** and enter the email ID associated with the OAuth connection.
  - c) In **Session name**, enter `gsheet`.
  - d) In **Open sheet**, click **From Spreadsheet id** and then enter the file ID of the spreadsheet that contains inventory data in Google Drive.
  - e) Select **Sheet contains header**.
  - f) Save changes.
  
4. Copy the inventory data to a Data table variable.
  - a) From the **Actions** panel, find and add **Google Sheets > Get multiple cells** action to the Bot editor.
  - b) In **Session name**, enter `gsheet`.
  - c) In Cell option, click All cells.
  - d) In Assign the output to variable, click **(x)** and create a Data table variable named `InventoryTable`.
  - e) Save the changes.
  
5. Close the current Google Sheet.
  - a) From the **Actions** panel, find and add **Google Sheets > Close** action to the Bot editor.
  - b) In **Session name**, enter `gsheet`.
  
6. Open the Google Sheet where you want to copy information about the items that need to be restocked.
  - a) From the **Actions** panel, find and add **Google Drive > Open spreadsheet** action to the Bot editor.
  - b) In **Username**, select **Insecure string** and enter the email ID associated with the OAuth connection.
  - c) In **Session name**, enter `gsheet`.
  - d) In **Open sheet**, click **From Spreadsheet id** and then enter the file ID of the spreadsheet to which you want to copy the items to be restocked.
  - e) Select **Specific sheet name**.
  - f) Save changes.
  
7. Select the second row in the current spreadsheet.
  - a) From the **Actions** panel, find and add **Google Sheets > Go to cell** action to the Bot editor.
  - b) In **Session name**, enter `gsheet`.
  - c) In **Cell options**, click **Specific cell** and then enter `A2` in **Cell name**.
  - d) Select **Specific sheet name**.

- e) Save changes.
8. Loop through the records in the data table variable.
- a) From the **Actions** panel, find and add **Loop > Loop** action to the Bot editor.
  - b) In **Iterator**, choose **Data table > For each row in table** .
  - c) In **In Table variable**, select the **InventoryTable** variable.
  - d) In **Assign the current row to this variable**, click (x) and create a record variable named TableRow.
  - e) Save changes.
9. The bot selects only the rows where the current stock is below the reorder threshold. To compare the current stock value to the reorder threshold for each item in the inventory, you need two variables.
- a) From the **Actions** panel, find and add **String > To number** action with the Loop action.
  - b) In **Enter the string**, enter \$TableRow[4]\$ to get the reorder threshold value for the current item.
  - c) In **Assign the output to variable**, click (x) and create a Number variable named ReorderThreshold.
  - d) From the **Actions** panel, find and add **String > To number** action with the Loop action.
  - e) In **Enter the string**, enter \$TableRow[3]\$ to get the current stock value for the current item.
  - f) In **Assign the output to variable**, click (x) and create a Number variable named currentStock.
  - g) Save the changes.
10. To check if the current item is below the reorder threshold, use the If action.
- a) From the **Actions** panel, find and add **If > If** action with the Loop action.
  - b) In **Condition**, select **Number > > Number condition** .
  - c) In **Source value**, enter \$currentStock\$.
  - d) In **Operator**, choose **Less Than (<)**.
  - e) In **Target value**, enter \$ReorderThreshold\$.
  - f) Save the changes.
11. Copy the item ID to the restock sheet.
- a) From the **Actions** panel, find and add **Google Sheets > Set cell** action within the if action.
  - b) In **Session name**, enter gsheets.
  - c) In **Cell options**, click **Active cell**.
  - d) In **Cell value**, enter \$TableRow[0]\$.
  - e) Save the changes.
12. Move the cursor to the next column.

- a) From the **Actions** panel, find and add **Google Sheets > Go to cell** action within the If action.
  - b) In **Session name**, enter `gsheet`.
  - c) In **Cell options**, click **One cell to the right**.
  - d) Save changes.
13. Copy the product name to the restock sheet.
- a) From the **Actions** panel, find and add **Google Sheets > Set cell** action within the if action.
  - b) In **Session name**, enter `gsheet`.
  - c) In **Cell options**, click **Active cell**.
  - d) In **Cell value**, enter `TableRow[1]`.
  - e) Save the changes.
14. Move the cursor to the next column.
- a) From the **Actions** panel, find and add **Google Sheets > Go to cell** action within the If action.
  - b) In **Session name**, enter `gsheet`.
  - c) In **Cell options**, click **One cell to the right**.
  - d) Save changes.
15. Calculate the quantity needed for reordering the current item.
- a) From the **Actions** panel, find and add **Number > Decrement** action within the if action.
  - b) In **Enter number**, enter `ReorderThreshold`.
  - c) In **Enter decrement value**, enter `currentStock`.
  - d) In **Assign the output to variable**, click **(x)** and create a Number variable named `quantityToStock`.
  - e) Save the changes.
16. Write the quantity to reorder in the Quantity to Restock column.
- a) From the **Actions** panel, find and add **Google Sheets > Set cell** action within the if action.
  - b) In **Session name**, enter `gsheet`.
  - c) In **Cell options**, click **Active cell**.
  - d) In **Cell value**, enter `quantityToStock.Number.toString`.
  - e) Save the changes.
17. Move the cursor to the start of the current row.
- a) From the **Actions** panel, find and add **Google Sheets > Go to cell** action within the If action.
  - b) In **Session name**, enter `gsheet`.
  - c) In **Cell options**, click **Beginning of the row**.

- d) Save changes.
18. Select the next row before the next iteration.
- From the **Actions** panel, find and add **Google Sheets > Go to cell** action within the If action.
  - In **Session name**, enter `gsheet`.
  - In **Cell options**, click **One cell below**.
  - Save changes.
19. Close the current Google Sheet.
- From the **Actions** panel, find and add **Google Sheets > Close** action after the Loop action.
  - In **Session name**, enter `gsheet`.
20. Disconnect from Google Sheets.
- From the **Actions** panel, find and add **Google Sheets > Disconnect** action after the Loop action.
  - In **Username**, select **Insecure string** and enter the email ID associated with OAuth connection you have set up.
  - In **Session name**, enter `gsheet`.
21. Run the bot.

## Run TaskBot to merge Excel sheets

Download and run sample Task Bot from the Bot Store to merge two spreadsheets.

Complete these requirements for using the example :

- Microsoft Excel must reside on the Bot Runner device
- Automation 360 Build 4088 or later
- Excel Advanced package version 2.0.0-20200422-000103 or later
- Two spreadsheets as input: Both sheets must have common data within column A, such as a product or customer number

You can manually create the spreadsheets with columns similar to the following tables 1 and 2. Sheet 1 has columns to append to sheet 2 where a common value resides in column A. The bot expects the file locations and names to be `c:\bot_test\Spreadsheet1.xlsx` and `c:\bot_test\Spreadsheet2.xlsx`.

Table 1

Item Number	Name	Count	Category	Unit Price	Taxable	Backorder	Perishable	Locale
A0001	Milk	15	Grocery	3	N	Y	Y	US
A0005	Towel	4	Home	10	Y	N	N	US

Item Number	Name	Count	Category	Unit Price	Taxable	Backorder	Perishable	Locale
A0006	Dog Food	16	Pet	22	N	N	N	US
A0007	Paint	43	Home	12	Y	N	N	IN

Table 2

Item Number	Name	Brand	Popular	Unit Price	TTS
A0001	Milk	Wholesome Foods	Y	3	1
A0002	Eggs	Dairy Love	Y	4	1
A0003	Flower	Spring Me Up!	N	10	3
A0004	Table	Woods Are Us	N	50	10
A0005	Towel	Claire Dane	N	10	6
A0006	Dog Food	Purina	Y	22	3
A0007	Paint	Color the World	N	12	2

1. Get the [Merge Excel Sheets Example](#) bot from the Bot Store.  
The bot is automatically loaded to your Automation 360 On-Premises or Cloud environment.  
You will receive an email with instructions for installing the bot in Automation 360 from the Bot Store.
2. Follow the instructions carefully. If you do not have the Bot Developer role assigned, contact your administrator to add the role.
3. If your spreadsheets are not located at `c:\bot_test\Spreadsheet1.xlsx` and `c:\bot_test\Spreadsheet2.xlsx`, update lines 5 and 9 of the bot with your desktop file location.
4. Run the Task Bot.
5. Update the Task Bot with any changes that reflect your use case, and make it your own.  
You can also use the bot as a template for future Excel Advanced Task Bots by copying and saving it with a new name.

Related reference

[Excel advanced package](#) on page 2565

The Excel advanced package contains actions that enable you to automate many of the repetitive tasks when working with Microsoft Excel spreadsheets.

## Example of migrating data from Excel to a database

In this example, you build a bot to transfer values from an Excel spreadsheet to a database using actions from the Database, Excel advanced, and Loop packages.

Before you start building your bot, create the following:

- Create an Excel spreadsheet with the following values and save it (For example: Test\_migration\_db.xlsx)

John	Williams	jwilliams@cmail.com
Sam	Li	sam.li@xyz.org
Carl	Miller	carl@carlmillerllc.com

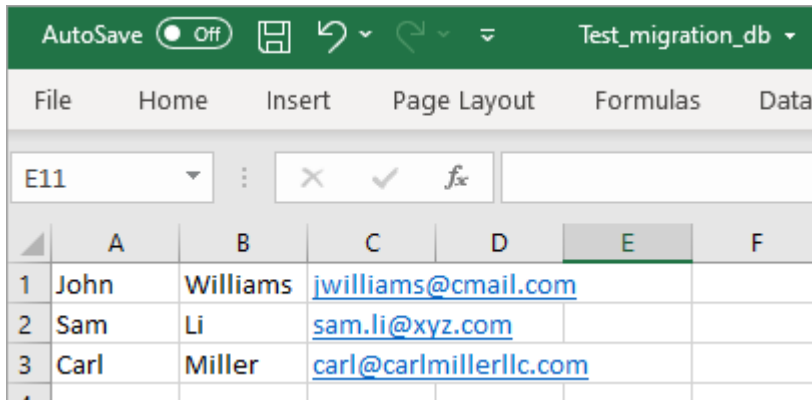

- Create an Access database table named CustomerT with the following columns: (create a database similar to the image below and save it - for example: save it as Test\_Migration\_db.accdb)
  - FirstName
  - LastName
  - Email

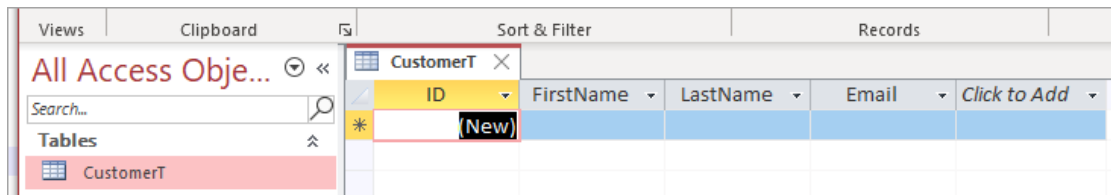

To migrate values from a spreadsheet to a table in a database, perform the following steps:

1. Create a new bot:
  - a) On the left panel, click **Automation**.
  - b) Click **Create new > Bot**.
  - c) In the **Create Task Bot** window, enter the bot name.

- d) Accept the default folder location: \Bot s\  
To change the default bot storage location, click **Choose** and follow the prompts.
  - e) Click **Create and edit**.
2. Open the spreadsheet:
- a) Double-click or drag the **Excel advanced > Open** action .
  - b) Click **Browse** to provide the file path.

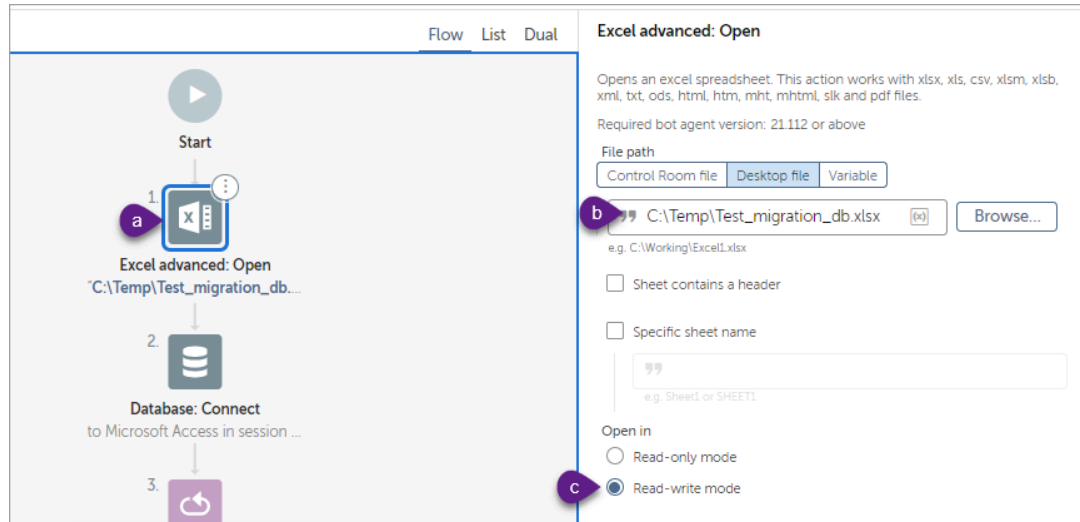

- c) Select the option to open the file in **Read-write**.
3. Connect to the database:
- a) Double-click or drag the **Database > Connect** action.
  - b) Select the **User defined** connection mode.

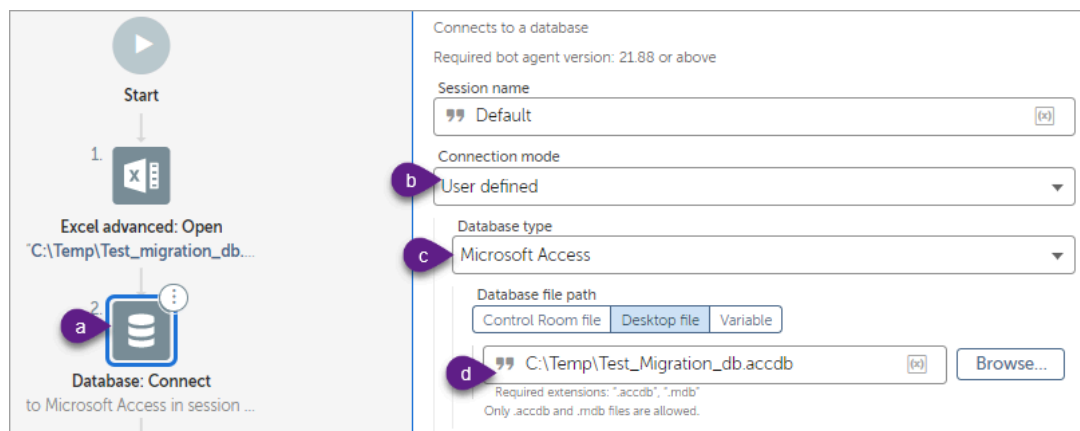

- c) Select the **Microsoft Access** database type.
  - d) Click **Browse** to provide the file path.
4. Insert the Excel values into the database, row by row:
- a) Double-click or drag the **Loop** action.
  - b) Select the **Excel advanced > For each row in worksheet** iterator.



c) Select **All rows** from the **Loop through** drop-down.

The screenshot shows the Automation Anywhere interface. On the left, a workflow is visible with steps: 3. Loop (highlighted with 'a'), 4. Database: Insert/Update/Delete... using the SQL statement 'INSE...', 5. Database: Disconnect from 'Default', and 6. Excel advanced: Close. On the right, the configuration for the Loop action is shown. The 'Loop Type' is set to 'Iterator'. The 'Excel advanced' action is selected. The 'Loop through' dropdown is set to 'All rows' (highlighted with 'c'). The 'Read option' is 'Read visible text in cell'. The 'Session name' is 'Default'. The 'Assign the current value to this variable' dropdown is set to 'rExcelCurrentRow' (highlighted with 'd').

d) In the Assign the current value to this variable, create the record variable rExcelCurrentRow.

e) Drag the **Database > Insert/Update/Delete** action into the Loop container.

f) Enter the following SQL statement:

```

INSERT INTO customert
(
    firstname,
    lastname,
    email
)
VALUES
('$rExcelCurrentRow[0]$',
 '$rExcelCurrentRow[1]$',
 '$rExcelCurrentRow[2]$$$');
    
```

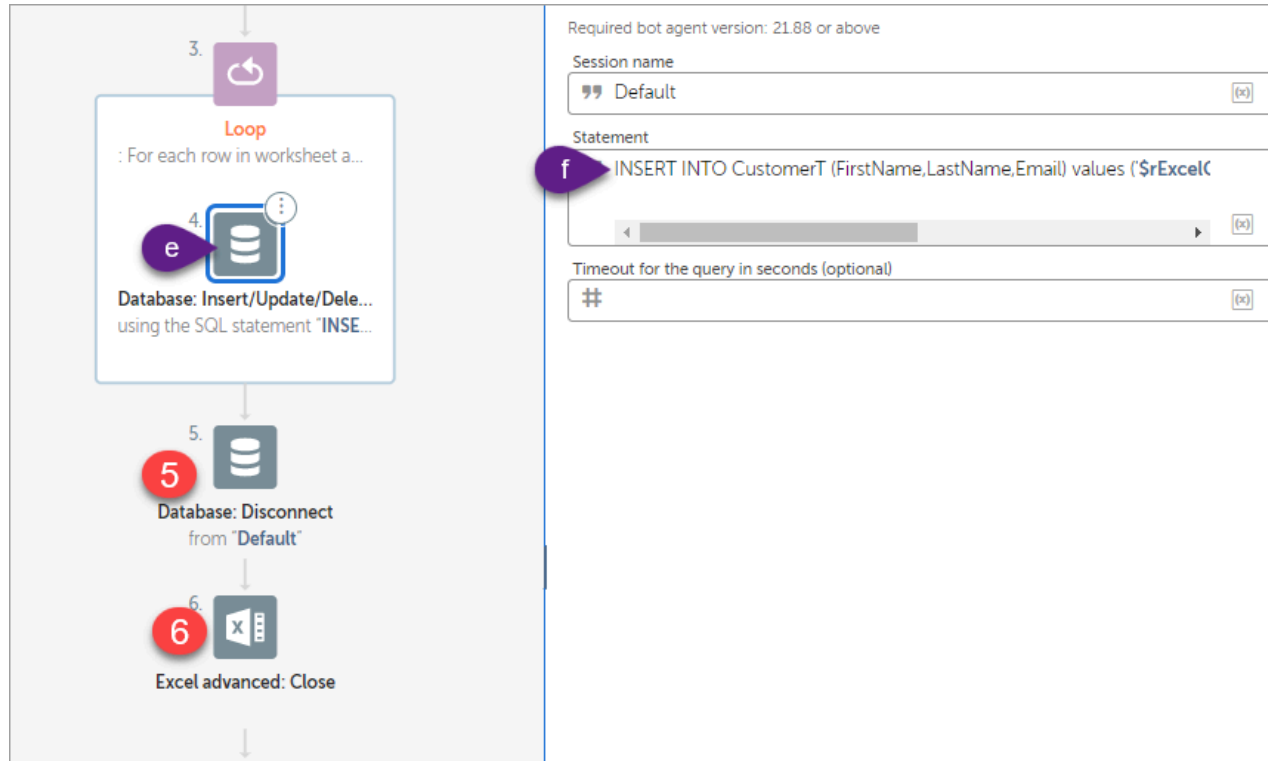

5. Disconnect from the database. Drag the **Database > Disconnect** action below the Loop container.
6. Close the spreadsheet. Double-click or drag **Excel advanced > Close Spreadsheet** action.
7. Click **Save**.

Related reference

[Database package](#) on page 2466

Databases support internal operations of an enterprise by storing a variety of data, such as sales transactions, product catalogs, inventories, and customer profiles. Use the Database package to connect to a database, begin a transaction, and manipulate the stored data by retrieving, inserting, updating, deleting, and exporting it to a CSV file.

[Excel advanced package](#) on page 2565

The Excel advanced package contains actions that enable you to automate many of the repetitive tasks when working with Microsoft Excel spreadsheets.

[Loop package](#) on page 2784

Use the Loop package to run a sequence of actions repeatedly for a specific number of times or until a specific condition is met.

## Example of reading data from a spreadsheet

Build a bot that reads data from one Excel worksheet and writes it to another worksheet.

To use the Excel advanced package, Microsoft Excel must be installed on the device where you run the sample bot.

Suppose an Order Processing team receives order data in a spreadsheet as part of the Order Fulfillment process. The team automates the process of creating a priority shipping list from the spreadsheet and sharing it with the Picking department. The sample bot in this tutorial performs the following tasks:

- Reads spreadsheet data that contains a list of orders using the Excel advanced package.
- Creates a new spreadsheet containing a list of orders that need to be shipped as a priority.

For this tutorial, you can download and use a sample Excel file from [here](#).

1. Create a new bot.
  - a) On the left panel, click **Automation**.
  - b) Click **Create new > Task Bot**.
  - c) In the **Create Task Bot** window, enter `Priority List` in **Name**.
  - d) Click **Create and edit**.
2. To read data from the spreadsheet that contains the list of orders, open the Excel sheet.
  - a) From the **Actions** panel, find and add the **Excel advanced > Open** action to the Bot editor.
  - b) Click **File** and select the sample Excel file you downloaded.
  - c) Select **Sheet contains a header**.
  - d) Select **Specific sheet name** and enter `order_list`.
  - e) In **Create Excel session**, click **Local session**, and enter `orderlist` as the session name.
3. For the list of priority orders, create a new spreadsheet.
  - a) From the **Actions** panel, find and add the **Excel advanced > Create workbook** action to the Bot editor.
  - b) In **File path**, specify a file path for the new file. For example, `C:\\bots\\priority-orders.xlsx`.
  - c) In **Sheet name**, enter `priority orders`.
  - d) In **Create Excel session**, select **Local session** and enter `prioritylist` as the session name.
  - e) Save the changes.
4. Copy the header from the source spreadsheet to the new spreadsheet.
  - a) From the **Actions** panel, find and add the **Excel advanced > Get multiple cells** action to the Bot editor.
  - b) In **Select range of cells to be returned**, select **Specific rows**, and then enter 1 in both the **From row** and **to row** fields.
  - c) In **Session name**, enter `orderlist`.
  - d) To store the copied values to a variable, create and assign a variable named `HeaderData` in **Assign value to the variable**. The values are stored in a data table variable.
  - e) Save the changes.
5. Write the copied header to the new sheet.
  - a) Find and add the **Excel advanced > Write from data table** action to the Bot editor.

- b) In **Enter data table variable**, select **HeaderData**.
  - c) Click **Specific worksheet** and enter `priority orders`.
  - d) In **Specify the first cell**, enter `A1`.
  - e) In **Session name**, enter `prioritylist`.
  - f) Save the changes.
6. Before you write the data to the new spreadsheet, make sure that the A2 cell is selected on the new worksheet. To do so:
- a) From the **Actions** panel, find and add the **Excel advanced** > **Go to cell** action to the Bot editor.
  - b) In **Specific cell**, enter `A2`.
  - c) In **Session name**, enter `prioritylist`.
  - d) Save the changes.
7. Loop through the list of orders in the source spreadsheet.
- a) From the **Actions** panel, find and add the **Loop** action to the Bot editor.
  - b) From **Iterator**, select **For each row in worksheet** for Excel advanced.
  - c) In **Loop through**, select **All rows**.
  - d) In **Session name**, enter `orderlist`.
  - e) In **Assign the current value to this variable**, select **Record**, and then create a variable named `order-record`.
  - f) Save changes.
8. Select the records where ShippingType equals Priority.
- a) a. From the **Actions** panel, find and add the **If** action within the **Loop** action.
  - b) In **Condition**, select **String** condition.
  - c) In **Source value**, enter `$order_record[4]` to select the fifth column in the current record.
  - d) In **Operator**, select **Equal to(=)**.
  - e) In **Target value**, enter `Priority`.
  - f) Save the changes.
9. If a matching record is found, write the record to the new spreadsheet. You can achieve this by using the Set cell action as many times as the number of columns in the source data. However, this example uses the Loop action to achieve the same result.
- a) From the **Actions** panel, find and add the **Loop** action within the **If** action.
  - b) From **Iterator**, select **For each value in record**.
  - c) In **Record variable**, select `order-record`.
  - d) In **Assign the current value to this variable**, select create a variable named **RecordValue**.
  - e) Save changes.
  - f) On the **Variables** panel, create a variable with the following details:

- In **Name**, enter RecordValueCounter
  - In **Type**, select Number.
  - In **Default value**, enter 0.
- g)** From the **Actions** panel, find and add the **Excel advanced > Set cell** action.
- h)** Make sure **Active cell** is selected.
- i)** In **Cell value**, enter `$order-record[$recordValueCounter]$`.
- j)** In **Session name**, enter `prioritylist`.
- k)** To move the cursor to the next cell in the row, find and add the **Excel advanced > Go to cell** action, and then select **One cell to the right** in **Active cell**.
- l)** In **Session name**, enter `prioritylist`.
- m)** To increment the recordValueCounter variable, find and add the **Number > Increment** action. Select **recordValueCounter** in both **Enter number** and **Assign the output value to a variable** fields. In **Enter increment** value, enter 1.
- n)** Save the changes.
- 10.** Reset the recordValueCounter variable to zero.
- a)** Find and add the **Number > Decrement** action after the inner loop but within the **If** action.
- b)** Select **recordValueCounter** in both **Enter number** and **Assign the output value to a variable** fields.
- c)** In **Enter increment value**, enter 7.
- d)** Save the changes.
- 11.** Move the cursor to the next row before the next iteration.
- a)** Find and add the **Excel advanced > Go to cell** action within the first **Loop** action (after the **Decrement** action).
- b)** Click **Active cell** and select **Beginning of the row**.
- c)** In **Session name**, enter `prioritylist`.
- d)** Find and add the **Excel advanced > Go to cell** action.
- e)** Click **Active cell** and select **One cell below**.
- f)** In **Session name**, enter `prioritylist`.
- g)** Save the changes.
- 12.** Run the bot.

## Example of using the Run action

The **Run** action from the Task Bot package enables you to run and pass values to one or more child bots. In this example, you use the **Run** action to pass two values from a parent bot to the child bot; the child bot adds the values and passes the sum back to the parent bot.

This example demonstrates the following:

### Modularization

Modularization separates a Task Bot into several bots, where each bot is built with all the actions necessary to perform one specific function of the greater task.

In this example, you build a single child bot to add the values. You can build several child bots, with each performing a different mathematical operation, and edit the parent bot to call whichever one you want to use.

### Reusability

Reusability enables the user to build a bot once, and then use that bot to automate many processes.

The child bot contains only the actions necessary to add the values and print them to a Message Box. Also, the bot adds two variables instead of hard-coded values. As a result, this bot can be reused for any task that involves an addition operation.

### Data control

Because the child bot accepts and returns values only through the use of variables, it does not hold data. This minimizes the chance of data leakage.

To run a Task Bot from the current task, perform these steps:

Build the child bot.

1. Open a new bot.
  - a) On the left panel, click **Automation**.  
A list of available bots and forms is displayed.
  - b) Click **Create a bot**.
  - c) Enter the bot name `AddChildBot`.
  - d) Enter the folder location `Bots\TaskBotExample`.  
To change where your bot is stored, click **Choose** and follow the prompts.
  - e) Click **Create and Edit**.
2. Create the following variables:
  - `v1`: number type; use as input
  - `v2`: number type; use as input
  - `nSum`: number type
  - `sSum`: string type; use as output

[Create a variable](#) on page 2336

3. Use a **Number > Assign** action to perform the mathematical operation.
  - a) Double-click or drag the **Number > Assign** action.
  - b) In the **Select the source string variable/ value** field, enter the following expression:  $\$v1\$ + \$v2\$$
  - c) Select `nSum` from the **Select destination number variable** list.
4. Use the **Number > To string** action to convert the value so it can be printed to a Message Box.
  - a) Double-click or drag the **Number > To string** action.
  - b) In the **Enter a number** field, enter the following expression: `$nSum$`
  - c) Select `sSum` from the **Assign output to variable** list.

5. Click **Save**.

6. Click **Close**.

Build the parent bot.

7. Open a new bot.
  - a) On the left panel, click **Automation**  
A list of available bots and forms is displayed.
  - b) Click **Create a bot**.
  - c) Enter the bot name `MathBot`.
  - d) Enter the folder location `\Bots\TaskBotExample`.  
To change where your bot is stored, click **Choose** and follow the prompts.
  - e) Click **Create and Edit**.
8. Create a Dictionary variable of Any subtype named `dSums` to accept the values passed from the child bot.  
Use the Any subtype to enable the parent bot to accept String, Number, or Boolean type values.
9. Insert a **Task Bot > Run** action to specify the values for the mathematical operation and the output variable to hold the sum.
  - a) Double-click or drag the **Task Bot > Run** action.
  - b) Click **Browse** to navigate to `Bots\TaskBotExample\AddChildBot`.
  - c) Enter the following values in the **Input values** fields:
    - `v1: 12`
    - `v2: 54`
  - d) Select `dSums` from the **Assign output to variable** list.

---

**Note:** Use a Dictionary variable to hold the output of the **Run** action in order to make the parent bot more versatile. This way a parent bot can handle different child bots regardless of whether they return a single value or several values.

---

10. Use a Message Box to retrieve and print the sum.

The variable `sSum` retrieved from the child bot is a key in the Dictionary variable `dSums`.

---

**Note:** You must know the variable names from the child bot to extract them from the parent bot. The interface does not automatically import the variable names to the parent bot.

---

- a) Double-click or drag the **Message box** action.
- b) Enter `$dSums {sSum}$` in the **Message to display** field.

11. Click **Save**.

12. Click **Run**.

The bot runs and the Message Box appears containing the sum 66.

Related reference

[Task Bot package](#) on page 3109

Use the **Run**, **Pause**, and **Stop** actions in the Task Bot package to manage running one or more child bots from a parent bot or with a third-party software using an API.

[Message box package](#) on page 2796

Use the **Message box** action from the **Message box** package to insert a message box that shows a message when the task runs. For example, you can insert a **Message Box** action to follow a web form so that the action displays the message: `Web Form Filled and Complete`.

## Example of using the SOAP web service action

Use the **SOAP web service** action to pass two numeric values and return the sum from an online calculator application.

To make a SOAP web services call, perform the following steps:

1. Double-click or drag the **SOAP web services** action.
2. Select a connection method:
  - To connect using a URI, enter the URI, for example, `http://www.dneonline.com/calculator.asmx?WSDL`.
  - To connect using a file, select a file from the Control Room or the Desktop, or insert a variable.

3. Optional: Enter the SOAP endpoint in the **Address location** field.

If you specify the address location, the bot uses it during execution; otherwise, the bot uses the address location from the WSDL file.

---

**Note:** If you are creating the SOAP URI manually and not using the **Build SOAP request** option, go to step 6 on page 3241.

---

4. Click **Build SOAP request**.

The **SOAP request** window appears, displaying the services and ports, with details about their operations and parameter.

5. In the **SOAP request** window, expand the service for which you want to view the list of ports. Click the required port to display the list of available operations. Select the required operation and click **Apply** to retrieve the operation details from the SOAP request.



If you use the **Build SOAP request** option, **Services**, **Port**, **Operation**, and **Operation parameters** fields are automatically populated with details based on the operation you selected. Go to step 10 on page 3241.

6. In the **Service** field, enter the service name.

This field identifies the collection of ports supported by the web service. It holds the @service name value for a SOAP web service call, for example, Calculator.

7. Optional: In the **Port** field, enter the endpoint to connect with.

If you do not specify a port, the bot will use the first port mentioned in the WSDL file based on the service selected. However, if that port is not supported by the SOAP web service, bot execution will fail.

This field holds the @binding name value for a SOAP web service call, for example, CalculatorSoap.

8. Select the **SOAP version** of the endpoint that you specified in the **Port** field.

Choose either **1.1** or **1.2**.

---

**Note:** The **SOAP version** can be determined using one of following namespaces specified in the WSDL file:

- SOAP 1.1 namespace: `http://schemas.xmlsoap.org/soap/envelope`
- SOAP 1.2 namespace: `http://www.w3.org/2003/05/soap-envelope`

- 
9. In the **Operation** field, enter the name of the service function for the endpoint that you specified in the **Port** field.

The bot execution fails if either of the following is true:

- The port mentioned in the port field does not have any operations.
- The operation mentioned in the SOAP request for the port is unavailable.

This field holds the @operation name value for a SOAP web service call, for example, Add.

10. Select **Operation parameters** or **Raw data parameters** to provide the parameter details.

---

**Note:** If you have selected **Build SOAP request**, the parameter details table in the **Operation** tab is automatically populated with the parameters of the selected operation. Provide values for these parameters. You can also add, edit, or delete the parameters for a particular operation.

- 
- If you select **Operation parameters**, enter the name and value of each parameter. For example, enter the following values:

- a) `intA` in the first **Name** field
- b) `10` in the first **Value** field
- c) `intB` in the second **Name** field
- d) `20` in the second **Value** field

- If you choose **Raw data parameters**, select **Parameters** or **Credential parameters**.

11. **Parameters:** You can use the credential values from the credential locker without exposing the credentials (username or password) in plain text in the raw data. To do so, you must first map the credential in the credential mapper and use the reference name in the raw data within curly braces.

For example, in the raw data, you provided the password in plain text to authenticate to the server.

```
<aut:AuthHeader>
<aut>Password> abc@123</aut>Password>
</aut:AuthHeader>
```

To use the password from the credential locker, perform the following steps:

**a) Click Add substitution.**

Enter the reference name, for example, `pwd`, in the **Name in XML** field. Select **Credential** to use a value available in the credential vault, **Variable** to use a credential variable, or **Insecure string** to manually specify the value you want to use.

For more information about credential vaults and how to use them, see [Credentials and lockers in the Credential Vault](#) on page 1861.

**b) Click Add**

**c) Specify the reference in the raw data within curly braces, as follows:**

```
<aut:AuthHeader>
<aut>Password>{{pwd}}</aut>Password>
</aut:AuthHeader>
```

The reference name `pwd` specified in raw data will substitute the corresponding value stored in the credential vault.

Ensure that you enter the reference name in the same format as specified in **Add substitution**. For example, if you have entered `password` as reference name in the raw data, when you run the bot, the bot will encounter an error.

- 12. Credential parameters:** If you want to enter raw data parameters as credential. You can choose **Credential** to use a value available in the Credential Vault or select **Variable** to use a credential variable or **Insecure string** to manually specify the value you want to use.
- 13. Select No Authentication or Basic** from the **Authentication Mode** list.
  - If you select **No Authentication**, proceed to the next step.
  - If you select **Basic**, enter your credentials.
- 14. Optional:** Provide a Client certificate by selecting a file from the Control Room or your desktop, or insert a variable.
- 15. Optional:** Provide custom headers.
- 16. Optional:** Provide a file to save the XML output.
- 17. Select Complete response or Selected response** to narrow the scope of the response.
  - If you select **Complete response**, proceed to the next step.
  - If you select **Selected response**, perform the following steps if you are creating the Xpath expression manually and not using the **Build Xpath** option.
    - a) Provide the XPath expression.** For example:

```
/*[local-name()='Envelope' and namespace-uri()='http://schemas.xmlsoap.org/soap/envelope/']/*[local-name()='Body' and namespace-uri()='http://schemas.xmlsoap.org/soap/envelope/']/*[local-name()='AddResponse' and namespace-uri()='http://
```

```
tempuri.org/']/*[local-name()='AddResult' and namespace-uri()='http://tempuri.org/']
```

- b) Select a section of the XML output: **Values**, **Inner XML**, or **Outer XML**.
- c) If you select the option **Values**, choose return content as: **String delimited by** or **List of strings**.

- If you select **String delimited by**, choose a delimiter option: **Pipe**, **Semicolon**, or **Custom**.

If you select **Custom**, enter variables or characters in the **Custom Delimiter** (optional) field.

---

**Note:** The special character dollar sign (\$) as delimiter is not supported.

---

- Select **List of strings** to return the output of the soap response as list of strings.

---

**Note:** You can only specify a list type of variable with data type as strings.

---

**18.** Click **Build Xpath**.

The Output preview window appears.

**19.** Select the appropriate node from the response body. The XML path is automatically created. Click **Apply**.

If you use the **Build Xpath** option, **XPath expression** and **Value** fields are automatically populated with details based on the operation you selected.

**20.** Optional: To set a time-out value when you send a SOAP request and receive a response, in the **Wait for action to complete** field, specify the wait time (in milliseconds).

By default, the wait time is 60000 milliseconds.

**21.** Configure the P12 certificate:

- To get the SSL certification file, select one of the following options: **Control Room file**, **Desktop file**, or **Variable**
- Configure the Keystore properties:
  - **Keystore file (Optional):** To provide the keystore file in .p12 format, select one of the following options: **Control Room file**, **Desktop file**, or **Variable**. The keystore file includes the client's private key and certificate.
  - **Keystore password (Optional):** To provide the password for the keystore file, select one of the following options: **Credential**, **Variable**, or **Insecure string**. The password is used to access the keystore file.

**22.** Select a variable to store the XML output.

For example, prompt-assignment

**23.** Verify the output of the **SOAP web service** action by inserting a **Message box** action with the variable prompt-assignment in the body message.

When you run the bot, the message box should show 30.

Related reference

[SOAP Web Service package](#) on page 3084

Use the **SOAP web service** action from the SOAP Web Service package to access and exchange information between two systems in XML format.

## Example of using Get structure command from SAP BAPI package

Using the SAP BAPI package, build a bot that inputs a structure to get data.

Download the SAP Java connector and DLL from the SAP website.

In this tutorial, you will build a bot that invokes BAPI\_FLIGHT\_GETLIST from the SAP demo Flight Data application. When executed, the bot calls the BAPI function by inputting an airline ID and destination details, gets a list of flights, and writes the response data to a CSV file.

You will use the following import parameters to limit your search:

- AIRLINE: Use the parameter to pass the airline ID.
- DESTINATION\_FROM: Use the parameter to get the structure and pass the city name and airport ID.

The tutorial is intended to demonstrate how to perform the following actions:

- Get the structure of an import parameter.
  - Set the values for the fields in the retrieved structure.
  - Get response data in a table based on the input data.
1. Create a Task Bot named `SAP-BAPI-FlightListReport`.
    - a) Log in to Control Room.
    - b) On the left pane, click **Automation**.
    - c) Click the **Create a bot** icon.
    - d) In the **Name** field, enter `SAP-BAPI-FlightListReport`, and click **Create & Edit**.
  2. To connect the bot to your SAP system, from the **Actions** panel, find **SAP BAPI > Connect** action and add it to the bot.
    - a) In **JCo: SAP Java Connector package**, specify the path to the Java connector `.jar` file.
    - b) In **JCo DLL dependency**, specify the path to the DLL file.
    - c) Choose **Custom Application Server** as **Connection Type**.
    - d) In **Application server host name**, specify the host name of the SAP application server.

---

**Note:** As a best practice, use the bot to specify sensitive information such as host name, user name, and password.

---
    - e) In **System number**, enter the instance number.
    - f) In **SAP instance system ID**, enter the system ID.
    - g) In **Client number**, enter the client number.
    - h) In **Logon language code**, enter **EN** or the language specific to your system.
    - i) In **Router string**, enter the SAP router string.
    - j) In **Username**, enter your SAP user name.

- k) In **Password**, enter your password.
  - l) Run the to test the connection.  
If the specified connection properties are correct, the bot is executed successfully.
3. To create a function, add the **SAP BAPI > Create function** action.
- a) In **Function alias name**, enter `getFlightListByAirline`.
  - b) In **BAPI name**, enter `BAPI_FLIGHT_GETLIST`.
4. To filter the data by an airline name, add the **SAP BAPI > Set field value** action.
- a) In **Function alias name**, enter `getFlightListByAirline`.
  - b) Click the **Function** tab.
  - c) In **Field name**, enter `AIRLINE` as the input parameter name.
  - d) In **Field value**, enter `AZ`.
5. To limit the selection by the airport and the destination city, get the structure of the `DESTINATION_FROM` import parameter first, and then set values for the fields in the retrieved structure. To do this, add the **SAP BAPI > Get structure** action.
- a) In **Function alias name**, enter `getFlightListByAirline`.
  - b) In **Structure name**, enter `DESTINATION_FROM`.
  - c) To assign the retrieved structure to an alias, click the **Alias** tab in **Destination**, and enter `destinationFrom` in **Create structure alias**.  
You can now use the alias to set values for the fields in the retrieved structure.
6. To set a value for the `AIRPORT ID` field in the `DESTINATION_FROM` parameter, add the **SAP BAPI > Set field value** action.
- a) In **Function alias name**, enter `getFlightListByAirline`.
  - b) In **Source**, click the **Structure** tab.
  - c) In **Structure alias**, enter `destinationFrom`.
  - d) In **Field name**, enter `AIRPORTID`.
  - e) In **Field value**, enter `FCO`.
7. To set a value for the `CITY` field in the `DESTINATION_FROM` parameter, add the **SAP BAPI > Set field value** action.
- a) In **Function alias name**, enter `getFlightListByAirline`.
  - b) In **Source**, click the **Structure** tab.
  - c) In **Structure alias**, enter `destinationFrom`.
  - d) In **Field name**, enter `CITY`.
  - e) In **Field value**, enter `ROME`.
8. To execute `BAPI_FLIGHT_GETLIST`, add the **SAP BAPI > Run function** action.
- a) In **Function alias name**, enter `getFlightListByAirline`.
9. To get the filtered data from the `FLIGHT_LIST` table, add the **SAP BAPI > Get table** action.

- a) In **Function alias name**, enter `getFlightListByAirline`.
  - b) In **Table name**, click the `FLIGHT_LIST` tab.
  - c) In **Destination**, click **Variable** to store the retrieved table data in memory.
  - d) In **Save the outcome to a variable**, create a variable named `tblFlightList` by clicking **(x)**.
10. To write the data from the retrieved table to a CSV file, add the **Data Table > Write to file** action.
- a) In **Data table**, select `tblFlightList`.
  - b) In **Enter file name**, specify the path to the CSV file to which you want to write the data.
  - c) Select **Create folders/files if it doesn't exist**.
  - d) Click **Overwrite existing file**.
11. Save and then run the bot.

## Example of writing data to SAP using SAP BAPI package

Using the SAP BAPI package, build a bot that writes data to the SAP database.

Download the SAP Java connector and DLL from the SAP website.

In this tutorial, you will build a bot that invokes `BAPI_FLFCUST_CREATEFROMDATA` from the SAP demo Flight Data application. You will use the `CUSTOMER_DATA` import parameter to pass the customer data to the BAPI. When executed, the bot creates a new customer record in SAP database and displays the customer number returned by the BAPI.

The tutorial demonstrates how to perform the following actions:

- Use the Get structure command to set values for the import parameters.
  - Create a new record in an SAP table.
  - Receive a response from a BAPI.
1. Create a bot named `SAP-BAPI-CreateNewFlightCustomer`.
    - a) Log in to the Control Room.
    - b) On the left pane, click **Automation**.
    - c) Click the **Create a bot** icon.
    - d) In the **Name** field, enter `SAP-BAPI-CreateNewFlightCustomer`, and click **Create & Edit**.
  2. To connect the bot to your SAP system, from the **Actions** panel, find **SAP BAPI > Connect** action and add it to the bot.
    - a) In **JCo: SAP Java Connector package**, specify the path to the Java connector `.jar` file.
    - b) In **JCo DLL dependency**, specify the path to the DLL file.
    - c) Choose **Custom Application Server** as **Connection Type**.
    - d) In **Application server host name**, specify the host name of the SAP application server.

**Note:** As a best practice, use the `*****` to specify sensitive information such as host name, user name, and password.

- e) In **System number**, enter the instance number.
  - f) In **SAP instance system ID**, enter the system ID.
  - g) In **Client number**, enter the client number.
  - h) In **Logon language code**, enter **EN** or the language specific to your system.
  - i) In **Router string**, enter the SAP router string.
  - j) In **Username**, enter your SAP user name.
  - k) In **Password**, enter your password.
  - l) Run the `testConnection` to test the connection.  
If the specified connection properties are correct, the bot is executed successfully.
3. To create a function, add the **SAP BAPI > Create function** action.
- a) In **Function alias name**, enter `createNewFlightCustomer`.
  - b) In **BAPI name**, enter `BAPI_FLCUST_CREATEFROMDATA`.
4. Because the `CUSTOMER_DATA` parameter is of the type structure, get the structure of the import parameter and assign it to an alias. To do this, add the **SAP BAPI > Get structure** action.
- a) In **Function alias name**, enter `createNewFlightCustomer`.
  - b) In **Structure name**, enter `CUSTOMER_DATA`.
  - c) To store the retrieved structure as an alias, click the **Alias** tab in **Destination**.
  - d) In **Create structure alias**, enter `CustomerData`.  
You will use the alias to set values for the import field within the retrieved structure.
5. To set the value for the `CUSTNAME` field, add the **SAP BAPI > Set field value** action.
- a) In **Function alias name**, enter `createNewFlightCustomer`.
  - b) In **Source**, click the **Structure** tab.
  - c) In **Structure alias**, enter `CustomerData`.
  - d) In **Field name**, enter `CUSTNAME`.
  - e) In **Field value**, enter `John Doe`.
6. Repeat Step 5 to add and configure the **Set field value** action for each of the following fields:

Field name	Field value
STREET	testStreet
POSTCODE	101001
CITY	testCity
COUNTR	US
COUNTR	00000000

Field name	Field value
EMAIL	test@example.com
CUSTTYPE	P

7. To execute BAPI\_FLICUST\_CREATEFROMDATA, add the **SAP BAPI > Run function** action.
  - a) In **Function alias name**, enter createNewFlightCustomer.

---

**Note:** If you want BAPI\_FLICUST\_CREATEFROMDATA to write the data to SAP database, you must select the **End sequence** and the **Commit transaction** options. If you select the **End sequence** option, ensure that you select the **Begin sequence** option in the **Create function** action.

The sample bot created with the help of this tutorial is intended to demonstrate how the Create() BAPIs work when the SAP BAPI package is used. It is not intended to modify the database.

- 
- The BAPI assigns and returns a customer number after a new customer record is created.
8. To get the number into a variable, add the **SAP BAPI > Get field value** action.
    - a) In **Function alias name**, enter createNewFlightCustomer.
    - b) In **Source**, click the **Function** tab.
    - c) In **Field name**, enter CUSTOMERNUMBER
    - d) In **Save the outcome to a variable**, create a variable named strCustomerNumber by clicking **(x)** and select the variable.
  9. To display the customer number, add the **Message Box** action.
    - a) In **Enter the message to display**, select the strCustomerNumber variable.
  10. Save and run the bot.

## Example of using Run standard workflow from SAP BAPI package

Using the Run standard workflow action from the SAP BAPI package, build a bot that retrieves data from SAP systems.

Download the SAP Java connector and DLL from the SAP website.

In this tutorial, you will build a bot that uses the Run standard workflow action. The Run standard workflow action provides a user interface that enables you to select BAPIs and configure the parameters for the selected BAPI.

By using this single SAP BAPI package action, you will perform the following actions:

- Select a BAPI (BAPI\_FLIGHT\_CHECKAVAILABILITY) from a list of function modules available in the connected SAP system.
- Set values for the import and export parameters of the selected BAPI.
- Assign retrieved structure or tables to dictionary or table variables.



When executed, the bot gets flight availability data based on the input data, and writes it to a CSV file.

1. Create a bot named `SAP-BAPI-CheckFlightAvailability`.
  - a) Log in to the Control Room.
  - b) On the left pane, click **Automation**.
  - c) Click the **Create a bot** icon.
  - d) In the **Name** field, enter `SAP-BAPI-CheckFlightAvailability`, and click **Create & Edit**.
  
2. To connect the bot to your SAP system, from the **Actions** panel, find **SAP BAPI > Connect** action and add it to the bot.
  - a) In **JCo: SAP Java Connector package**, specify the path to the Java connector `.jar` file.
  - b) In **JCo DLL dependency**, specify the path to the DLL file.
  - c) Choose **Custom Application Server** as **Connection Type**.
  - d) In **Application server host name**, specify the host name of the SAP application server.

---

**Note:** As a best practice, use the `*****` to specify sensitive information such as host name, user name, and password.

---

- e) In **System number**, enter the instance number.
  - f) In **SAP instance system ID**, enter the system ID.
  - g) In **Client number**, enter the client number.
  - h) In **Logon language code**, enter **EN** or the language specific to your system.
  - i) In **Router string**, enter the SAP router string.
  - j) In **Username**, enter your SAP user name.
  - k) In **Password**, enter your password.
  - l) Run the bot to test the connection.  
If the specified connection properties are correct, the bot is executed successfully.
  
3. From the **Actions** panel, find **SAP BAPI > Run standard workflow** action after the **Connect** action.
  
4. Select a BAPI.
  - a) Click the **Select workflow** option.
  - b) In the **Standard BAPI Selector** window, from **Select Standard BAPI**, expand **SAP Modules**.
  - c) Find and expand **Flight with connection data (SAP training)**.
  - d) In **Flight with connection data (SAP training)**, expand **General > Create**, select **BAPI\_FLIGHT\_CHECKAVAILABILITY**, and then click **Select**.
  
5. Specify values for the fields in the import parameter. Do the following in **Import to BAPI**:
  - a) Click the vertical ellipsis option for the **AIRLINEID** field, and select **Edit**.
  - b) In **Value**, enter `DL` and click **Apply**.
  - c) Click the vertical ellipsis option for the **CONNECTIONID** field, and select **Edit**.

- d) In **Value**, enter 1699 and click **Apply**.
- e) Click the vertical ellipsis option for the **FLIGHTDATE** field, and select **Edit**.
- f) In **Value**, enter 20170418 and click **Apply**.  
The Java connector for SAP systems takes the date values in the yyyyymmdd format.

`BAPI_FLIGHT_CHECKAVAILABILITY` returns data in the `AVAILABILITY` export parameter, which is of the type structure.

6. In **Export to BAPI**, perform the following steps:
  - a) Click the ellipsis option for the **AVAILABILITY** field.
  - b) On the **Availability** window, select the **Field name** check box to select all fields within the structure, and then click **Apply**.
7. Store the data that the BAPI exports to a variable.
  - a) In **Save exported structures and scalars**, create a variable by clicking **(x)** and name it `ReturnStructure`.
8. In **Save exported structures and scalars**, create a variable by clicking **(x)** and name it `ReturnStructure`.
9. Save the **Run standard workflow** action.
10. Convert the exported data to a table.
  - a) From the **Actions** panel, find **Dictionary > Get** action, and add it after the **Run standard workflow** action.
  - b) Click inside **Dictionary variable** and select `ReturnStructure`.
  - c) In **Key**, enter `AVAILABILITY`.
  - d) In **Assign the output to variable**, create a variable by clicking **(x)** and name it `Availability`.
11. To write the data from the retrieved table to a CSV file, add the **Data Table > Write to file** action.
  - a) In **Data table**, select `Availability`.
  - b) In **Enter file name**, specify the path to the CSV file, to which you want to write the data.
  - c) Select **Create folders/files if it doesn't exist**.
  - d) Click **Overwrite existing file**.
12. Save and run the bot.

## Example of using the VBScript package in a resilient bot

Build a bot that executes a Microsoft Visual Basic script. Use the Try/Catch package to gracefully end the bot if it fails, making it resilient to crashes. A resilient bot allows scheduled and queued bots to continue even if the current bot encounters an error.

In this bot, you ask the user to provide a number. The bot passes the number to a Microsoft Visual Basic script to multiply by pi and return the value. The bot then reports the result to the user. You can use the **VBScript** action to either import an external script or type it directly into your bot.

In this example, you manually type the script. You also add resiliency to the bot by adding error handling.

1. Create a bot:
  - a) On the left panel, click **Automation**.  
A list of available bots and forms is displayed.
  - b) Click **Create New > Bot**.
  - c) Provide a name for the bot: `MultiplyPi`
  - d) Enter the folder location: `Bots\TaskBotExample`
  - e) Click **Create and Edit**.
  
2. Create a variable: `nPromptAnswer`:
  - Type: **Number**
  - Name: `nPromptAnswer`

[Create a variable](#) on page 2336
  
3. Create a variable: `lNumbersForPi`:
  - Type: **List**
  - Subtype: **Number**
  - Name: `lNumbersForPi`
  
4. Click **Save**.
  
5. Use the **Prompt > For value** action to ask the user for a number.
  - a) Click the **Show** link on the Actions pane.
  - b) Double-click or drag the **Prompt For value** action to add it to the bot.
  - c) In the **Prompt window caption** field, type: `Any Number`
  - d) In the **Prompt message field**, type: `Enter any number to multiply by pi.`
  - e) In the **Assign the value to a variable** field, select **prompt-assignment**.
  
6. Click **Save**.
  
7. Use the **Error handler > Try** action to gracefully end the bot if there was an error, such as the user not entering a number.
  - a) Double-click or drag the **Error handler > Try** action.
  - b) Drag the **Prompt > For value** action under the **Error handler > Try** action.
  
8. Click **Save**.
  
9. Convert the **prompt-assignment** (string) to a number value.
  - a) Double-click or drag the **String > To number** action, adding it as the last line before the **Error handler: Catch** action.
  - b) In the **Enter the string** field, press F2 to open the list of your variables, and select **prompt-assignment**.
  - c) Click **Yes, insert**.
  - d) In the **Assign the output to variable** field, select `nPromptAnswer`.

10. Click **Save**.
11. Copy the number value to the first item in the list of numbers to pass to VBScript.
  - a) Double-click or drag the **List > Add item** action, adding it as the last line before the **Error handler: Catch** action.
  - b) In the **List variable** field, select **INumbersForPi**.
  - c) In the **Item to be added** field, select **nPromptAnswer**.

12. Click **Save**.

13. Use the **VBScript > Open** action to provide your Visual Basic source code.
  - a) Double-click or drag the **VBScript Open** action, adding it as the last line before the **Error handler: Catch** action.
  - b) In the **VBScript** options, select **Manual Input**.
  - c) Copy the following code and paste it into the **Enter script here** field:

```
Dim Arg, var1, var2
Set Arg = WScript.Arguments
Function MultiplyPi (Arg)
    var1 = Arg(0)
    var2 = 3.14159
    MultiplyPi = cdbl(var1)*var2
End Function
```

14. Click **Save**.

15. Use the **VBScript > Run function** action to execute the script.
  - a) Double-click or drag the **VBScript Run function** action, adding it as the last line before the **Error handler: Catch** action.
  - b) In the **Enter the name of the function to be executed (optional)** type `MultiplyPi`.
  - c) In the **Parameters (optional)** field, select **INumbersForPi** variable.
  - d) In the **Assign the output to variable (optional)** field, select **prompt-assignment**.

16. Click **Save**.

17. Use the **VBScript > Close** action to end the session.
  - a) Double-click or drag the **VBScript Close** action, adding it as the last line before the **Error handler: Catch** action.

18. Click **Save**.

19. Print the answer generated in the VBScript on the screen.
  - a) Double-click or drag the **Message box** action, adding it as the last line before the **Error handler: Catch** action.
  - b) In the **Enter the message to display** field, type `Pi times your number is:` , then press F2 to open the list of your variables. Select **prompt-assignment**.
  - c) Click **Yes, insert**.

20. Click **Save**.

21. Notify the user if an error occurred and end the bot gracefully.
  - a) Click the **Error handler: Catch AllErrors** action once so that it is highlighted in your bot.

- b) Double-click or drag the **Message box** action to insert it as the last bot action.
  - c) In the **Enter the message to display** field, type Bot failed. Please be sure to enter only numbers..
22. Click **Save**.
23. Click the **List** tab to view your code as text only.  
Your code should look like this:

```
Start
Error handler: Try
  Prompt: For value during bot execution and assign the value
  $prompt-assignment$
  String: To number Convert string $prompt-assignment$ to a number
  and assign it to number variable $nPromptAnswer$
  List: Add item $nPromptAnswer$ to $lNumbersForPi$
  VBScript: Open VBScript manual script of 7 lines
  VBScript: Run function "MultiplyPi"
  VBScript: Close VBScript "Default"
  Message box "Pi times your number is: $prompt-assignment$"
Error handler: Catch AllErrors
  Message box "Bot failed. Please be sure to enter only numbers."
End
```

24. Run your bot.
25. When the bot runs successfully, a message box displays the calculated number. View the message and click **Close**. You can test the resiliency of your bot by running the bot again and entering a letter instead of a number.

Related reference

[VBScript package](#) on page 3153

The VBScript package contains actions that enable VBScript functions in a task.

## Build a Bot Insight dashboard bot

In this example, you build a bot that retrieves data from a website to create visualizations in Bot Insight.

Configure an empty string variable named sNu11.

[Create a variable](#) on page 2336

1. Create a new bot:
  - a) On the left panel, click **Automation**.
  - b) Click **Create new > Bot**.
  - c) In the **Create Task Bot** window, enter the bot name.
  - d) Accept the default folder location: \Bots\  
To change the default bot storage location, click **Choose** and follow the prompts.
  - e) Click **Create and edit**.
2. Open a browser window to the web page from which you want to extract the table.
  - a) Double-click or drag the **Browser > Launch website** action.

- b) In the URL field, enter `https://www.statista.com/statistics/183483/ranking-of-languages-spoken-at-home-in-the-us-in-2008/`.
- c) Select the Internet Explorer browser.

---

**Note:** Use Microsoft Internet Explorer because it reliably launches the website in a new window, even if another window is already open. Other browsers might launch the website in a new tab if there is an open window.

---

- d) Click **Save**.
  - e) Click **Run**.  
The bot opens the window.
3. Select the table for extraction.
- a) Double-click or drag the **Recorder > Capture** action.
  - b) Click the **Window** tab and select the **Languages spoken in the United States 2018 | Statista** window from the drop-down list.  
If the window title does not appear in the list, click **Refresh**.
  - c) Click **Capture object**.  
The **Languages spoken in the United States 2018 | Statista** window is activated.
  - d) Hover over the table until an orange box that surrounds the entire table appears.
  - e) Click the table.
  - f) Return to the Control Room.
  - g) In the Object properties table, verify the Control Type is TABLE.  
If it is not, click **Recapture object**.
  - h) From the Action drop-down list, select **Get table**.
  - i) In the **Assign output to variable** field, create the `tLanguages` table variable.
4. Specify the file in which to save the data.
- a) Double-click or drag the **Data Table > Write to file** action.
  - b) From the **Data table name** list, select **tLanguages**.
  - c) Provide a file path to create a CSV file.  
For example, `C:\Users\\Desktop\LanguagesTable.csv`.
  - d) Select the **Create folders/files if it doesn't exist** option.
  - e) Select to overwrite the existing file.
5. Specify the file that holds the extracted data.
- a) Double-click or drag the **CSV/TXT > Open** action.
  - b) Provide the file path to the file specified in step 4.
  - c) Select the **Contains header** option to exclude the first row.
6. Iterate though each row of the file.
- a) Double-click or drag the **Loop** action.
  - b) Select the **For each row in CSV/TXT** iterator.

- c) In the **Assign the current row to this variable** field, create the variable `rCurrentRow`.
7. Specify the data to populate the Bot Insight dashboard.
  - a) Double-click or drag the **Analyze > Open** action.
  - b) Double-click or drag the **String > Assign** action.
  - c) Enter `$rCurrentRow[0]` as the source string.  
Press F2 to open the variables menu.
  - d) In the **Select destination string variable** field, create the variable `sLanguage`.
  - e) Double-click or drag the **String > Replace** action.  
The extracted data uses commas to separate digits. You must remove the commas before you can convert the string to a number data type to use in Bot Insight.
  - f) Enter `$rCurrentRow[1]` as the source string.  
Press F2 to open the variables menu.
  - g) Enter `,` in the **Find string** field.
  - h) Select the **Not a regular expression** option.
  - i) In the **Replace with** field, enter `$sNull$`.
  - j) In the **Assign the output row to variable** field, create the variable `sPopulation`.
  - k) Double-click or drag the **String > To number** action.
  - l) Enter the `$sPopulation$` variable.
  - m) In the **Assign the output row to variable** field, create the variable `nPopulation`.
  - n) Double-click or drag the **Analyze > Close** action.
  - o) Select the following variables:
    - **sLanguage**
    - **nPopulation**
8. Click **Save** and then **Run**.
9. Click **Analyze**.  
The Bot Insight window appears.

Learn more about dashboards.

[Bot Insight dashboards](#) on page 3929

Related reference

[Analyze package](#) on page 2412

Use the actions in the **Analyze** package to specify the actions and variables to use in the Bot Insight dashboard and widgets. The **Analyze** package enables you to perform transactional analytics for the data that is logged by the variables when the bot runs.

[Browser package](#) on page 2435

The **Browser** package contains actions that enable you to download files, find broken links, and launch a website. This package supports Google Chrome, Chromium-based Microsoft Edge, and Internet Explorer browsers.

[Recorder package](#) on page 2916

Recorder package captures a series of tasks in a process and then automates them. You can automate your business applications (for example, desktop, Web, SAP, and Java applications) using the Recorder to capture actions performed on application objects such as a text box, button, table, radio button, combo box, and list view.

[Data Table package](#) on page 2452

The Data Table package contains actions that enable you to perform various operations on the values of table variables. Use these actions to join or merge content, search for specific values, insert rows and columns, remove duplicate rows, and write values to a file.

[CSV/TXT package](#) on page 2449

The **CSV/TXT** package contains actions that enable you to open a CSV or text file, read data from that file, and assign the data to a Table variable. This package supports files encoded in ANSI, Unicode, UTF-8, or Windows-1251, and can process up to one million records.

[Loop package](#) on page 2784

Use the Loop package to run a sequence of actions repeatedly for a specific number of times or until a specific condition is met.

## Example of using multiple analyze actions in a task

Build a bot that uses multiple **Open** and **Close** Analyze actions in a task to analyze and compare the sales data for each quarter of XYZ Company, and create visualizations in Bot Insight.

Before you start building the bot, create the following data set on your desktop in the .csv file format.

PRODUCT	COUNT	QUANTIT	SALES_C	QUANTIT	SALES_C	QUANTIT	SALES_C	QUANTIT	SALES_C	QTR4
		ORDERE		ORDERE		ORDERE		ORDERE		
		QTR1		QTR2		QTR3		QTR4		
S18_1367	intage USA	39	4808.31	21	2856	50	5907.5	48	4389.12	
	Cars									
S18_1367	intage Germany	33	3288.78	42	2262.96	30	1746.6	25	2183.25	
	Cars									
S18_1367	intage France	41	2055.74	42	4431.84	34	5375.4	45	2304.45	
	Cars									
S18_1367	intage Australia	48	2354.88	33	3423.75	24	1496.64	32	1742.4	
	Cars									
S18_1367	intage UK	30	5151	36	3081.24	33	4950.33	29	5176.5	
	Cars									
S18_1367	intage India	50	3390	45	1702.8	23	4230.62	44	7554.8	
	Cars									
S18_1367	intage Japan	28	1801.24	22	995.5	47	6034.33	33	5890.5	
	Cars									
S18_1367	intage New Zealand	43	4818.15	29	1716.22	42	3958.5	27	1879.74	
	Cars									
S18_1367	intage Norway	39	4178.85	46	1528.58	34	3455.76	38	2323.7	
	Cars									



PRODUCTCODE	PRODUCTLINE	COUNTRY	QUANTITYORDERED_QTR1	SALES_QTR1	QUANTITYORDERED_QTR2	SALES_QTR2	QUANTITYORDERED_QTR3	SALES_QTR3	QUANTITYORDERED_QTR4	SALES_QTR4
S18_1367	Vintage Cars	Sweden	22	1903.22	-	-	24	1685.28	23	1643.12
S18_1367	Vintage Cars	Spain	50	2490.5	-	-	29	1254.83	38	4299.7
S18_1367	Vintage Cars	Canada	49	1689.03	-	-	36	1194.84	20	2212
S18_1367	Vintage Cars	Austria	26	2253.68	-	-	49	2414.72	26	3206.32

1. Create a bot.
  - a) Log in to the Control Room as a Bot Creator.
  - b) On the left pane, click **Automation**.  
A list of available bots and forms is displayed.
  - c) Click **Create new > Bot**.
  - d) Click **Create and edit**.
  
2. Open the XYZ\_sales\_data.csv file that you created.
  - a) Double-click or drag the **CSV/TXT > Open** action.
  - b) In the **Session name** field, enter `Session 1`.
  - c) Provide the file path to XYZ\_company\_sales\_data.csv.
  - d) Select the **Contains header** option to exclude the first row.
  
3. Create a **Record** variable as Row by using the **Create variable** icon.  
The **Record** variable holds all the values for one row. With each iteration of the loop, the bot retrieves the values of the next row and stores them in the **Record** variable, overwriting the values from the previous row.
  
4. To retrieve the values in the cells from each row in the XYZ\_company\_sales\_data.csv file, use a **Loop** action.
  - a) Select **For each row in CSV/TXT iterator**.
  - b) In the **Session name** field, enter `Session 1`.
  - c) In the **Assign the current row to this variable** field, select the Row variable that you created.
  
5. Create the following variables for four quarters by using the **Create variable** icon at the top of the **Variables** menu.
  - PRODUCTCODE
  - PRODUCTLINE
  - COUNTRY
  - QUANTITYORDERED\_QTR1
  - SALES\_QTR1

- QUANTITYORDERED\_QTR2
- SALES\_QTR2
- QUANTITYORDERED\_QTR3
- SALES\_QTR3
- QUANTITYORDERED\_QTR4
- SALES\_QTR4

6. Specify the data to populate on the Bot Insight business dashboard.

- a) Double-click or drag the **Analyze > Open** action.

---

**Note:** Ensure that you insert the **Analyze Open** and **Close** actions inside the **Loop** action to analyze and capture the data from each row in the Bot Insight dashboard.

---

- b) Double-click or drag the **String > Assign** action.

Press F2 to open the variables menu.

- c) Choose the Row variable from the drop-down list.

- d) Enter PRODUCTCODE and click **Yes, insert**.

- e) In the **Select destination string variable** field, choose the PRODUCTCODE variable.

To assign string variables for PRODUCTLINE and COUNTRY, repeat [Step 6b](#) through [Step 6e](#).

- f) Double-click or drag the **Number > Assign** action.

Press F2 to open the variables menu.

- g) Choose the row variable from the drop-down list.

- h) Enter QUANTITYORDERED\_QTR1 and click **Yes, insert**.

- i) In the **Select destination string variable** field, choose the QUANTITYORDERED\_QTR1 variable.

To assign number variables for SALES\_QTR1, QUANTITYORDERED\_QTR2, SALES\_QTR2, QUANTITYORDERED\_QTR3, SALES\_QTR3, QUANTITYORDERED\_QTR4, and SALES\_QTR4, repeat [Step 6f](#) through [Step 6i](#).

- j) Double-click or drag the **Analyze > Close** action.

- k) Enter the **Transaction** name as `Quarters 1 and 2`.

- l) Select the following transactional variables in the **Close** action:

- PRODUCTCODE
- PRODUCTLINE
- COUNTRY
- QUANTITYORDERED\_QTR1
- SALES\_QTR1
- QUANTITYORDERED\_QTR2
- SALES\_QTR2

- m) Double-click or drag the **Analyze > Open** action.

- n) Double-click or drag the **Analyze > Close** action.

- o) Enter the **Transaction** name as `Quarters 3 and 4`.

- p) Select the following transactional variables in the **Close** action:

- PRODUCTCODE
- PRODUCTLINE
- COUNTRY
- QUANTITYORDERED\_QTR3
- SALES\_QTR3
- QUANTITYORDERED\_QTR4
- SALES\_QTR4

7. Click **Save** and then **Run**.

8. Click **Analyze Task Bot**.

The Bot Insight business dashboard appears.

9. Select the **Preview** option.

The sales data is displayed as follows:

Task Name:XYZ company sales data analysis  
Transaction Name: Quarter 1 and 2 Total Records: 13

sales_qtr2	productcode	sales_qtr1	quantityordered_qtr1	quantityordered_qtr2	productline	country
2252.96	S18_1367	3288.78	33.0	42.0	Vintage Cars	Germany
0.0	S18_1367	1689.03	49.0	0.0	Vintage Cars	Canada
2856.0	S18_1367	4808.31	39.0	21.0	Vintage Cars	USA
4431.84	S18_1367	2055.74	41.0	42.0	Vintage Cars	France
3423.75	S18_1367	2354.88	48.0	33.0	Vintage Cars	Australia
1702.8	S18_1367	3390.0	50.0	45.0	Vintage Cars	India
995.5	S18_1367	1801.24	28.0	22.0	Vintage Cars	Japan
1528.58	S18_1367	4178.85	39.0	46.0	Vintage Cars	Norway
3081.24	S18_1367	5351.0	30.0	36.0	Vintage Cars	UK
1716.22	S18_1367	4818.15	43.0	29.0	Vintage Cars	New Zealand

Transaction Name: Quarter 3 and 4 Total Records: 13

productcode	quantityordered_qtr3	sales_qtr3	sales_qtr4	quantityordered_qtr4	productline	country
S18_1367	47.0	6034.33	5890.5	33.0	Vintage Cars	Japan
S18_1367	24.0	1685.28	1643.12	23.0	Vintage Cars	Sweden
S18_1367	50.0	5907.5	4389.12	48.0	Vintage Cars	USA
S18_1367	24.0	1496.64	1742.4	32.0	Vintage Cars	Australia
S18_1367	34.0	3455.76	2323.7	38.0	Vintage Cars	Norway
S18_1367	23.0	4230.62	7564.8	44.0	Vintage Cars	India
S18_1367	29.0	1254.83	4299.7	38.0	Vintage Cars	Spain
S18_1367	36.0	1194.84	2212.0	20.0	Vintage Cars	Canada
S18_1367	49.0	2414.72	3206.32	26.0	Vintage Cars	Austria
S18_1367	30.0	1746.6	2183.25	25.0	Vintage Cars	Germany

## Example of updating default package version across bots

This example shows how to perform a bulk update of multiple bots in the Control Room repository and use the default version of the Excel advanced and Message Box packages.

To update bots to the default package version, ensure you have the View packages permission and the permission to edit bots .

This example shows how you can update all the bots in a public repository that use the Excel advanced and Message Box packages to their default versions with one action.

1. To update all the bots in the public repository that use Excel advanced and Message Box packages to default version, perform these steps:

- a) Navigate to **Administration > Bot update**.
- b) Click the **Update Bots** drop-down and click **Package Version**.
- c) On the **Update - Package Version > Settings** page, search and select the Excel advanced and Message Box packages.
- d) Click the right arrow (→) to add the Excel advanced and Message Box packages to the selection.
- e) In the selection list, select the Excel advanced and Message Box packages and click **Next**.
- f) From the list of available bots, select the required bots for which you want to update the package version.
- g) Click the right arrow (→) to add your selection, select the bots from the selection list, and click **Next**.
- h) Review the selected bots and dependencies that you selected for the update and click **Update-Package Version**.

The bots are checked out to set the package default versions for the Excel advanced and Message Box packages.

2. On the **Bot update list** page, click the three dots icon next to the required update and click **View update bot details** to view a detailed report.
3. Navigate to **Administration > Audit log**.
4. On the **Audit log** page, search by event type and select the **Update default package** value. You can view information about status, name, start and end time, duration required for the update, the number of completed, failed, skipped, and total items with last modified time, and user details (such as username) who initiated the package update.
  - a) Click the three dots icon next to the required event and click **View event details**.

**Event details:**

- **Status:** Successful
- **Item name:** AAAb
- **Event started by:** doc-packages
- **Time:** 12:49:06IST2023-02-27
- **Object type:** Event
- **Event type:** Update default package
- **Source device:** product-kernel-5cbc499957-1n4s8
- **Source:** Control Room
- **Request ID:** 83cfaceb03d4528fe4785d10f1e02ae6

**Update default package details:**

- **Request name:** Updatebots.doc-packages.23.02.27.12.18.02
- **Bot path:** Bots\AAAb
- **What changed?:** Package version
- **Package name:** MessageBox
- **Old package version:** 2.1.0-20210118-185321
- **Target package version:** 6.14.0-20221221-171419, 3.5.0-20221223-065722
- **Old bot version:** 1
- **New bot version:** 2

- b) Copy the **Request ID** , for example, 83cfaceb03d4528fe4785d10f1e02ae6 from the **Update default package** page.
- c) On the **Audit log** page, search by filter **Request ID** and enter the value 83cfaceb03d4528fe4785d10f1e02ae6.

The **Audit log** page displays all the bots that are either successfully updated or those that failed the update process as shown in the following image:

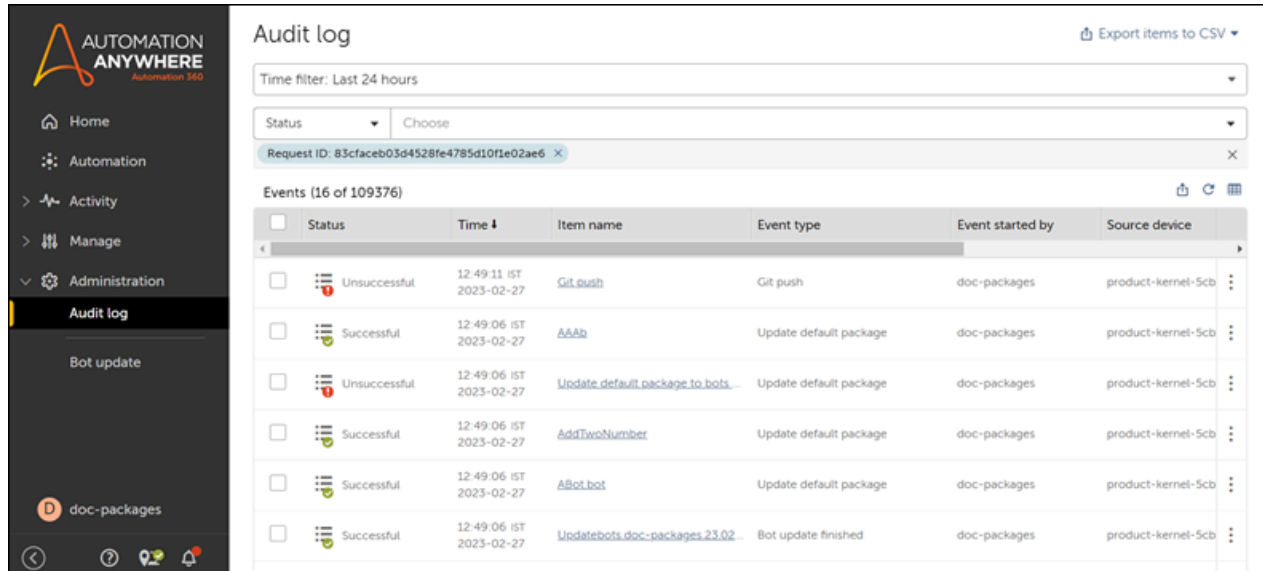

- d) Click any bot, for example, **AddTwoNumber**, to view the [Update default package details](#).

5. Select the required event from the **Audit log** page, for example, **AddTwoNumber**, and click **Export checked items to CSV** to download the audit data to a CSV file.

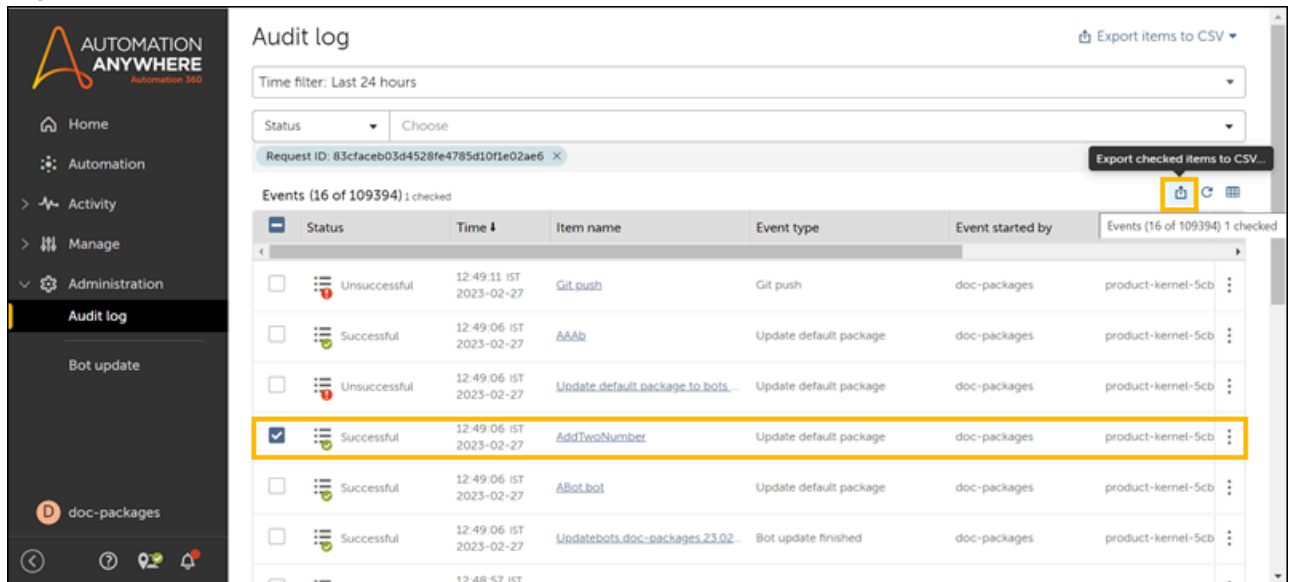

## Example of using remote function call in SAP

This example describes how to build a bot that will create a document in SAP using the remote function call method.

Download the SAP Java connector package and DLL from the SAP website.

1. Open a new bot:
  - a) On the left panel, click **Automation**.
  - b) Click **Create new > Bot**.
  - c) In the **Create Task Bot** window, enter a bot name.
  - d) Click **Create and edit**.
  
2. Establish a connection with the SAP application using the **Connect** action.
  - a) In the **SAP BAPI Session** field, enter `Default`.
  - b) Select the **Desktop** option, then browse and select the SAP Java connector package available on your device.  
Example: `F:\SAP \SAP JCo 3.1.3\Microsoft Windows and Windows Server \64-bit\sapjco3.jar`
  - c) Select the **Desktop** option, then browse and select the SAP Java connector DLL available on your device.  
Example: `F:\SAP \SAP JCo 3.1.3\Microsoft Windows and Windows Server \64-bit\sapjco3.dll`
  - d) Select the **Group/Server** option as the connection type.
  - e) Select **Insecure string** and enter `AWINAAW012.bcone.com` to specify the hostname for the SAP message server.
  - f) Enter `AWINAAW012.bcone.com` in the **Gateway host** field to connect to the server.
  - g) Enter the following values:

Field	Value
Logon group	Public
System number	01
SAP instance system ID	AAI
Client number	800
Logon language code	EN
Router string	/H/115.112.148.66/S/3299

- h) Select **Insecure string** and enter `ISR3` to specify the username you want to use to connect to the SAP server.
  - i) Select **Insecure string** and enter **Automation@123** to specify the password you want to use to connect to the SAP server.
  
3. Use the **Create function** action to create a function for the SAP BAPI function.

- a) Create an alias for an SAP BAPI function and save it with an alias name.
- b) In the **Session name** field, enter `Default`.
- c) In the **Function alias name** field, enter `BAPI_Post`.
- d) In the **BAPI name field**, enter `BAPI_ACC_DOCUMENT_POST`.

---

**Note:** The SAP BAPI function name and other parameters are specific to the customer environment while creating the Automation 360 bot.

---

4. To create `BAPI_ACC_DOCUMENT_POST` in SAP, you must first create a structure and tables. Select **Get structure** to obtain data from a structure using the function alias.
  - a) In the **BAPI function alias** field, enter `BAPI_POST` (the alias you provided for SAP BAPI function using the **Create function** action).
  - b) In the **Structure name** field, enter `DOCUMENTHEADER` (the name of the structure from which you want to get data).
  - c) In the **SAP BAPI session** field, enter `Default` (the session name you used to connect to the SAP application in the **Connect** action).
  - d) Select the **Alias** option to save the data retrieved from the structure and enter `Doc` in the **Create structure alias** field.
5. Select the **Get table** action to get tabular data from a table using the function alias.
  - a) In the **BAPI function alias** field, enter `BAPI_Post` (the alias you provided for the SAP BAPI function using the **Create function** action).
  - b) In the **Table name** field, enter `ACCOUNTGL` (the name of the table from which you want to obtain data).
  - c) In the **SAP BAPI session** field, enter `Default` (the session name you used to connect to the SAP application in the **Connect** action).
  - d) Select the **Alias** option to save the data retrieved from the table and enter `GL` in the **Create table alias** field.
6. Repeat [step 5](#). In step 5(b), enter the value `CURRENCYAMOUNT` in the **Table name field** and in step 5(d) enter the value `Currency` in the **Create table alias** field.
7. Select the **Set field value** action to set data into the empty structure and table created previously.
  - a) In the **BAPI function alias** field, enter `BAPI_Post`.
  - b) From the **Source** field, select **Structure**.
  - c) Enter `DOC` in the **Structure alias** field.
  - d) In the **Field name** field, enter `USERNAME` (the name of the field in which you want to set data).
  - e) In the **Field value** field, enter `sy-uname` (the value that you want to set).
  - f) In the **SAP BAPI session** field, enter `Default`.
8. Repeat [step 7](#) seven times and input the same values as you previously entered in steps 7(a), 7(b), 7(c), and 7(f). Enter the following values for steps 7(d) and 7(e).

Field name	Field value
BUS_ACT	RFBU
HEADER_TXT	TEST BOC BAPI POSTING
COMP_CODE	1000
DOC_DATE	20210127
PSTNG_DATE	20210127
DOC_TYPE	SA
FIS_PERIOD	00

9. Select the **Get structure** action.
  - a) In the **BAPI function alias** field, enter BAPI\_POST.
  - b) In the **Structure name** field, enter DOCUMENTHEADER.
  - c) In the **SAP BAPI session** field, enter Default.
  - d) Select the **Variable** option to store the data retrieved from the structure in a table variable. Create table variable Sap-Bapi-Table.
  
10. Double-click or drag the Data table > **Write to file** action.
  - a) Select the Table variable **Sap-Bapi-Table** that contains the data to write from the Data table name list.
  - b) Specify the location of the file in which to write the data in the **Enter file name** field. For example, D:/user defined/My Desktop/SAP Test/DOCUMENTHEADER.csv.
  - c) Select the **Create folders/files if it doesn't exist** check box.
  - d) Select the **Override existing file** option when writing data in an existing file.
  - e) Select the **new line** option from the **Row delimiter** field.
  - f) Select the **comma** option from the **Column delimiter** field.
  - g) Select the **ANSI** option from the **Encoding list**.
  
11. Double-click or drag the **Set field value** action to set data into table.
  - a) In the **BAPI function alias** field, enter BAPI\_POST.
  - b) From the **Source** field, select **Table**.
  - c) Enter GL in the **Table alias** field.
  - d) In the **Field name** field, enter ITEMNO\_ACC (the name of the field in which you want to set data).
  - e) In the **Field value** field, enter 2 (the value that you want to set).
  - f) In the **SAP BAPI session** field, enter **Default** (the session name you used to connect to the SAP application in the **Connect** action).
  
12. Repeat [step 11](#), seven times to set data into a table.

While setting values in the table, retain the same value as you previously entered in steps 11(a), 11(b), 11(c), and 11(f). Change the following values for steps 11(d) and 11(e):



Field value	Field name
GL_ACCOUNT	0000078310
PSTNG_DATE	20210127
ITEM_TEXT	TEST POSTING DEBIT ITEM
QUANTITY	1000
BASE_UOM	EA
COMP_CODE	1000
DOC_TYPE	SA

13. Select the **Set value** field action.
- In the **BAPI function alias** field, enter BAPI\_POST.
  - From the **Source** field, select **Table**.
  - Enter GL in the **Table alias** field.
  - Select the **Create new row** check box to enter data in the next row.
  - In the **Field name** field, enter ITEMNO\_ACC (the name of the field in which you want to set data).
  - In the **Field value** field, enter 1 (the value that you want to set).
  - In the **SAP BAPI session** field, enter **Default** (the session name you used to connect to the SAP application in the **Connect** action).
14. Select the **Get table** action.
- In the **BAPI function alias** field, enter BAPI\_POST.
  - In the **Table name** field, enter ACCOUNTGL.
  - In the **SAP BAPI session** field, enter Default.
  - Select the **Variable** option to store the data retrieved from the table in a table variable. Create table variable Sap-Bapi-Table.
15. Double-click or drag the Data table > **Write to file** option.
- Select the Table variable **Sap-Bapi-Table** that contains the data to write from the **Data table name** list.
  - Specify the location of the file in which to write the data in the **Enter file name** field. For example, D:/user defined /My Desktop/SAP Test/ACCOUNTGL.csv.
  - Select the **Create folders/files if it doesn't exist** check box.
  - Select the **Override existing file** option when writing data in an existing file.
  - Select the **new line** option from the **Row delimiter** field.
  - Select the **comma** option from the **Column delimiter** field.
  - Select the **ANSI** option from the **Encoding list**.
16. Double-click or drag the **Set field value** action to set data into a table.
- In the **BAPI function alias** field, enter BAPI\_POST.

- b) From the **Source** field, select **Table**.
- c) Enter CURRENCY in the **Table alias** field.
- d) In the **Field name** field, enter ITEMNO\_ACC (the name of the field in which you want to set data).
- e) In the **Field value** field, enter 2 (the value that you want to set).
- f) In the **SAP BAPI session** field, enter Default (the session name you used to connect to the SAP application in the **Connect** action).

17. Repeat [step 16](#), seven times to set data into a table.

While setting values in the table, retain the same value as you previously entered in steps 16(a), 16(b), 16(c), and 16(f). Change the following values for steps 16(d) and 16(e):

Field name	Field value
CURRENCY	USD
AMT_DOCCUR	-2000
ITEMNO_ACC	1
CURRENCY	USD (repeated) line 43
AMT_DOCCUR	2000

- 18. Repeat [step 14](#) and enter CURRENCYAMOUNT in the **Table name** field.
- 19. Repeat [step 15](#) and specify the location of the file, for example D:/user defined /My Desktop/SAP Test/CURRENCYAMOUNT.csv.
- 20. Select the **Run function** action to run the SAP BAPI function.
  - a) In the **BAPI function alias** field, enter BAPI\_POST.
  - b) Select the **End sequence** option to mark the end of a process and the **Commit transaction** option to commit the changes made during the process.
  - c) In the **SAP BAPI session** field, enter Default.
- 21. Select the **Get table** action.
  - a) In the **BAPI function alias** field, enter BAPI\_POST.
  - b) In the **Table name** field, enter RETURN.
  - c) In the **SAP BAPI session** field, enter Default.
  - d) Select the **Variable** option to store the data retrieved from the table in a table variable. Create table variable Sap-Bapi-Table.
- 22. Repeat [step 15](#) and specify the location of the file, for example D:/user defined /My Desktop/SAP Test/Return.csv.
- 23. Select the **Get field value** action to obtain data of a specified field from a function.
  - a) In the **BAPI function alias** field, enter BAPI\_POST.
  - b) Select the **Function** tab from **Source** field.
  - c) In the **Field name** field, enter OBJ\_KEY.
  - d) In the **SAP BAPI session** field, enter Default.

- e) Select Prompt-Assignment in the **Save the output to a variable** field.
24. Double-click or drag the **Message box** action.
    - a) Enter **Automation Anywhere Enterprise Client** in the **Enter the message box window title** field.
    - b) Enter **\$Prompt-Assignment\$**.
    - c) Enter 30 in the **Scroll bar after lines** field to show a scroll bar.
  25. Repeat [step 23](#) and [step 24](#) (In step 23(c), enter the value OBJ\_SYS).
  26. Repeat [step 23](#) and [step 24](#) (In step 23(c), enter the value OBJ\_TYPE).
  27. Click **Save** and **Run**.

## Example of using JSON package actions in a bot

Build a bot that runs a JSON script with multiple records. In this example, we use a JSON file that contains a list of feeds from a blog, and the bot extracts the required information from the JSON file and prints it to a message box.

To run JSON script from Automation 360, you must already have the JSON data stored either as a variable or a file (.json, .txt format) on your desktop. The following screenshot displays the structure of a JSON object as a sample.

```
{
  "feeds": [
    {
      "id": 1090,
      "title": "Amsterdam Beaches",
      "description": "It's true that few people think of the Netherlands when planning a beach holiday. But whether you're just visiting or lucky enough to call this iconic city home, there are plenty of great beaches to enjoy in Amsterdam",
      "location": "Kloveniersburgwal 1, 1012 CW Amsterdam, Netherlands",
      "lng": 0,
      "lat": 0,
      "userId": 3043,
      "name": "Ritu singh",
      "isdeleted": false,
      "profilePicture": "/Images/userimageicon.png",
      "videoUrl": null,
      "images": null,
      "mediatype": 0,
      "imagePaths": null,
      "feedsComment": null,
      "commentCount": 3,
      "multiMedia": [
        {
          "id": 2157,
          "name": "beach of amsterdam.PNG",
          "description": null,
          "url": "feedsmedia/3043/c5522956-4ab5-408e-b540-16a8c90af9b0.PNG",

```

```
        "mediatype": 1,  
        "likeCount": 0,  
        "place": null,  
        "createAt": "0001-01-01T00:00:00"  
      },  
    ],  
    "likeDislike": {  
      "likes": 2,  
      "dislikes": 1,  
      "userAction": 2  
    },  
    "createdAt": "2019-12-26T07:08:38.4659686",  
    "code": 0,  
    "msg": null  
  },  
  ],  
  "totalFeed": 125  
}
```

1. Create a bot.
  - a) On the left panel, click **Automation**.  
A list of available bots and forms is displayed.
  - b) Click **Create New > Bot**.
  - c) Provide a name for the bot: `JsonBot`.
  - d) Click **Create and Edit**.
  
2. Start a JSON session by using the **JSON > Start session** action.
  - a) From the **Actions** pane, double-click or drag the **JSON > Start session** action.
  - b) In the **Data Source** field, choose **File** and select the **Desktop file** file type. Click **Browse** to find your JSON file, for example, `D:\userdefined\My Downloads\Sample Json with 200 Records.json`.
  - c) To create a JSON session, from **Json object session**, select **Local session** and enter **Default** as the session name.
  
3. Create a variable: `SampleString`
  - **Type:** `String`
  - **Name:** `SampleString`
  
4. Retrieve the value of the total number of feeds from the JSON script by using the **JSON > Get node value** action.
  - a) From the **Actions** pane, double-click or drag the **JSON > Get node value** action.
  - b) In the **JSON node key or path** field, enter `totalFeed`.
  - c) In the **Session name** field, enter `Default`.
  - d) In the **Save the outcome to a variable** field, select `SampleString`.
  - e) To print the value of `totalFeed`, double-click or drag the **Message box** action.
  - f) To open the list of your variables, in the **Enter the message to display** field, press `F2`, and then select `SampleString`.

- g) Click **Yes, insert**.

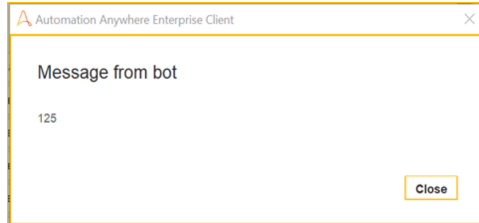

5. To retrieve any specific value from 125 feeds, perform the following steps.
- From the **Actions** pane, double-click or drag the **JSON > Get node value** action.
  - In the **JSON node key or path** field, enter `feeds[52].title`.
  - In the **Session name** field, enter `Default`.
  - In the **Save the outcome to a variable** field, select `SampleString`.
  - To print the value of `feeds[52].title`, double-click or drag the **Message box** action.
  - To open the list of your variables, in the **Enter the message to display** field, press F2, and then select `SampleString`.
  - Click **Yes, insert**.

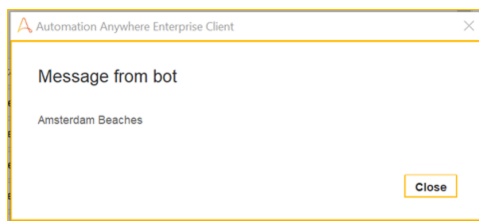

6. Create a variable: `StringList`
- Type:** `List`
  - Subtype:** `String`
  - Name:** `StringList`
7. To retrieve the list of child nodes from a node path, use the **JSON > Get node list** action.
- From the **Actions** pane, double-click or drag the **JSON > Get node list** action.
  - In the **JSON node key or path** field, enter `feeds`.
  - In the **Session name** field, enter `Default`.
  - In the **Save the outcome to a variable** field, select `StringList`.
  - To print all the child nodes under the `feed 51` object, double-click or drag the **Message box** action.
  - To open the list of your variables, in the **Enter the message to display** field, press F2, and then select **`StringList[51]`**.
  - Click **Yes, insert**.

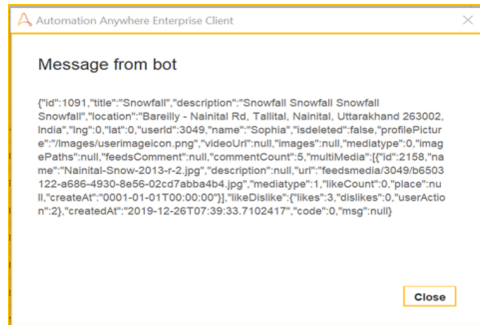

8. To close a JSON session, use **End session**. In the **Session name** field, enter `Default`.
9. Click **Save** and then click **Run**.
10. Start a new JSON session.
  - a) From the **Actions** pane, double-click or drag the **JSON > Start session** action. In the **Data Source** field, select **Text** and enter `StringList [52]`.
  - b) From **Json object session**, select **Local session** and enter `Default 1` as the session name.
11. To retrieve the value from a specific node, use **JSON > Get node value**.
  - a) From the **Actions** pane, double-click or drag the **JSON > Get node value** action.
  - b) In the **JSON node key or path** field, enter `description`.
  - c) In the **Session name** field, enter `Default 1`.
  - d) In the **Save the outcome to a variable** field, select `SampleString`.
  - e) To print the value of the `description` node, double-click or drag the **Message box** action.
  - f) To open the list of your variables, in the **Enter the message to display** field, press F2, and then select `SampleString`.
  - g) Click **Yes, insert**.

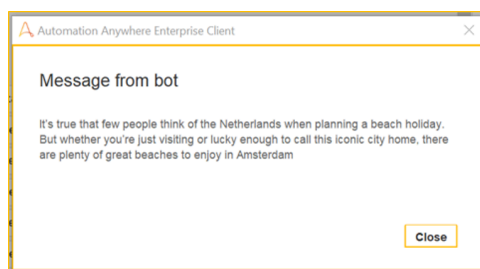

12. To close the JSON session, use **End session**. In the **Session name** field, enter `Default 1`.
13. Click **Save** and the click **Run**.  
You can further perform operations to extract the required information from the JSON feed and use the extracted values in your bot. To extract the name value from feed 50 through 60, perform the following steps.
14. Create a variable: `ListItem`
  - **Type:** `String`
  - **Name:** `ListItem`

15. To process each item in the list, use the **Loop** action.
- Double-click or drag the **Loop** action.
  - Select the **For each item in the list** iterator.
  - In the **List** field, select `StringList`.
  - Choose the **Range** option and for the following fields, enter the values provided:
    - From Index:** 50
    - To index:** 60
  - In the **Assign the current value to variable** field, select `ListItem`.
16. Start a new JSON session.
- From the **Actions** pane, double-click or drag the **JSON > Start session** action.
  - In the **Data Source** field, select **Text** and enter `ListItem`.
  - To create a JSON session, from **Json object session**, select **Local session** and enter `Default 2` as the session name.
17. To retrieve the value from a specific node, use the **JSON > Get node value** action .
- From the **Actions** pane, double-click or drag the **JSON > Get node value** action.
  - In the **JSON node key or path** field, enter `name`.
  - In the **Session name** field, enter `Default 2`.
  - In the **Save the outcome to a variable** field, select `SampleString`.
  - To print the value of the `name` node, double-click or drag the **Message box** action.
  - To open the list of your variables, in the **Enter the message to display** field, press `F2` , and then select `SampleString`.
  - Click **Yes, insert**.
18. Click **Save** and then click **Run**.  
The name values retrieved from the feeds 50 through 60 are as follows:

Feeds (object)	Name
50	Ashish
51	Sophia
52	Ritu
53	Shivam
54	Navya
55	Faiz
56	Martin
57	Shweta
58	Jagjit
59	Mark

Feeds (object)	Name
60	Sophia

## Example using Email actions in a bot

In this example, we use email actions to perform email-related operations using Outlook Client.

Create a bot to perform the following tasks:

- Retrieve the total number of attachments from emails and print the result in the message box.
- Send a response to the sender and all the recipients of an email with the different subject.
- Delete and remove read emails from the Inbox.

**1.** Create a bot.

- a)** On the left panel, click **Automation**.  
A list of available bots and forms is displayed.
- b)** Click **Create New > Bot**.
- c)** Provide a name for the bot: `Email_Operation_Bot`.
- d)** Click **Create and Edit**.

**2.** Use the Connect action to establish a connection with an email server.

- a)** Double-click or drag the **Email > Connect** action.
- b)** Enter `EmailSession` in the **Session name** field.
- c)** Select **Outlook** to establish a connection with Microsoft Outlook.
- d)** Enter `test@automationanywhere.com` in the **Outlook mailbox (optional)** field.

**3.** To process each item in the email, use the **Loop** action.

- a)** Double-click or drag the **Loop** action.
- b)** Select **For each mail in mail box** from the iterator list.
- c)** In the **Session name** field, enter `EmailSession`.
- d)** Select **All** from the **Type of emails to get** field to retrieve emails from the email server.
- e)** In the **From a specific folder (optional)** field, enter `Inbox/Analytics` folder.
- f)** Choose **HTML** option for message format.
- g)** Select **True** from the **Use local timezone** list.
- h)** In the **Assign the current value to variable (optional)** field, create `EmailDetails` as a Dictionary variable.

**4.** Retrieve the total number of attachments from each mail and print.

- a)** double-click or drag the **Message box** action
- b)** In the **Enter the message to display** field, enter: `$EmailDetails{emailSubject}$  
$EmailDetails{emailNoOfAttachments}$`



5. Double-click or drag the **Email > Disconnect** action. In the **Session name** field, enter `EmailSession`.
6. Click **Save** and then **Run**.  
The attachment details are retrieved from the emails as follows:

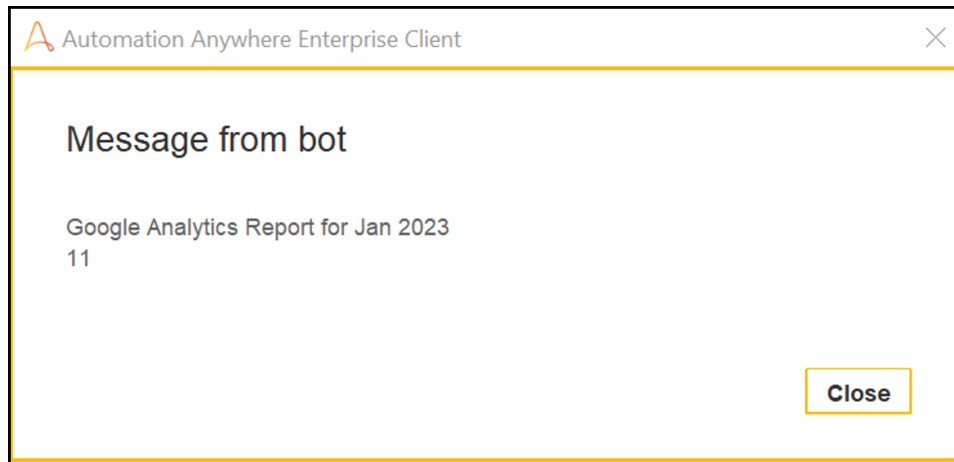

emailSubject	emailNoOfattachments
Google Analytics Report for Dec 2022	12
Google Analytics Report for Nov 2022	11
Google Analytics Report for Oct 2022	9
Google Analytics Report for Aug 2022	10
Google Analytics Report for July 2022	13
Google Analytics Report for May 2022	11
Google Analytics Report for March 2022	5

7. Start a new Email session.
  - a) Double-click or drag the **Email > Connect** action.
  - b) Enter `EmailSession1` in the **Session name** field.
  - c) Select **Outlook** to establish a connection with Microsoft Outlook.
  - d) Enter `test@automationanywhere.com` in the **Outlook mailbox (optional)** field.
8. To process each item in the email, use the **Loop** action.
  - a) Double-click or drag the **Loop** action.
  - b) Select **For each mail in mail box** from the iterator list.
  - c) In the **Session name** field, enter `EmailSession1`.
  - d) Select **All** from the **Type of emails to get** field to retrieve emails from the email server.
  - e) In the **From a specific folder (optional)** field, enter `Inbox/Daily stand up meeting`.
  - f) Choose **HTML** option for message format.
  - g) Select **True** from the **Use local timezone** list.

9. Use the **Reply All** action to send a response to an email.
  - a) Enter the following email IDs. `peter_wilson@example.com`, `john.smith@example.com`, `nancy.mark@example.com`

---

**Note:** Use comma to separate the emails IDs.

---

  - b) In the Subject (optional) field, enter `Documentation deliverables for upcoming releases`.
  - c) Add the file attachment to the email message `release plan.xlsx`.
  - d) Select **Plain text** for the email body.
  - e) In the **Message** field, enter the following message as follows:

```
Hi All,  
See the attached document outlining the release plan.
```
  - f) Select the **Outlook** option from the **Send email via** list.
10. Double-click or drag the **Email > Disconnect** action. In the **Session name** field, enter `EmailSession1`.
11. Click **Save** and then **Run**  
The response will be sent to the sender and all the recipients of an email.
12. Start a new Email session.
  - a) Double-click or drag the **Email > Connect** action.
  - b) Enter `EmailSession2` in the **Session name** field.
  - c) Select **Outlook** to establish a connection with Microsoft Outlook.
  - d) Enter `test@automationanywhere.com` in the **Outlook mailbox (optional)** field.
13. Use the **Delete All** action to delete all the email from the inbox.
  - a) Enter `EmailSession2` in the **Session name** field.
  - b) In the **From a specific folder (optional)** field, enter `Inbox/Backup mails`.
  - c) Select **All** from the **Type of emails to get field** to retrieve emails from the email server.
14. Double-click or drag the **Email > Disconnect** action. In the **Session name** field, enter `EmailSession2`.
15. Click **Save** and then **Run**.  
The emails will be deleted from the specified folder.

## Example using user account actions from Active Directory package

This example shows how to use actions to automate user account management tasks, such as: Create, Delete, Get property, Remove, Rename, and Set property.

1. Create a bot.
  - a) On the left panel, click **Automation**.  
A list of available bots and forms is displayed.

- b) Click **Create New > Bot**.
  - c) Enter a name for the bot: `Active_Directory_User` Operation.
  - d) Click **Create and Edit**.
2. Use the **Connect** action to establish a connection with an Active Directory server.
- a) Double-click or drag the **Active Directory > Connect** action.
  - b) Enter `Default` in the **Session name** field.
  - c) Enter the LDAP URL in the **Parent path** field: `LDAP://ec2-192.168.2.60.us-east-1.compute.amazonaws.com/CN=Users,DC=aaetest,DC=net`
  - d) In the **Login username** and **Login password** fields, enter your user name and password. For example, select **Insecure string** tab and enter the following values:
    - Login username: `ksmith.doe`
    - Login password: `aa_testqwerty@123`
3. Use the **Create group** action to create a new group.
- a) Double-click or drag the **Active Directory > Create group** action.
  - b) Enter `Default` in the **Session name** field.
  - c) Enter `AA_India_Documentation` in the **Group name** field.
  - d) Select the group scope as **Global**.
  - e) Select the group type as **Distribution**.

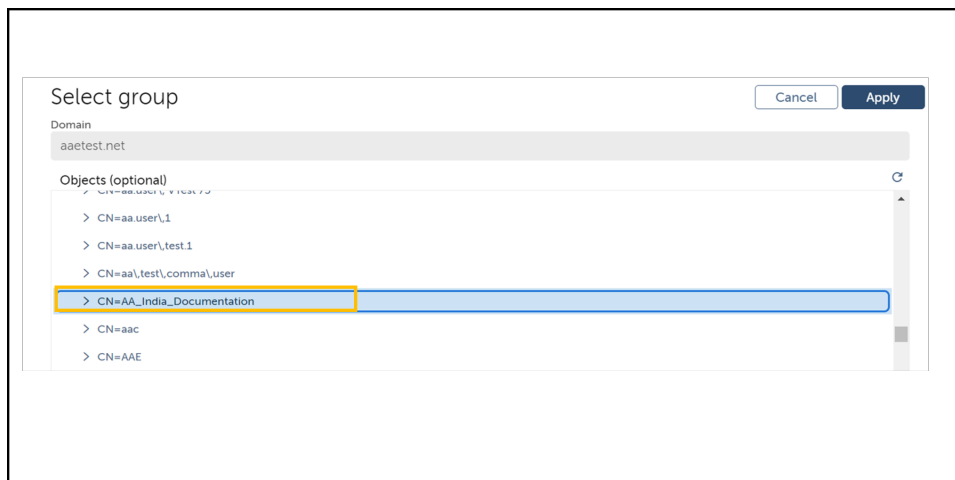

4. Use the **Create user** action to configure and activate a new user.
- a) Double-click or drag the **Create user** action.
  - b) Enter `Default` in the **Session name** field.
  - c) Enter `Maverick John` in the **User name** field.
  - d) Enter `maverick.john` in the **Logon name** field.
  - e) Enter `Maverick` in the **First name** field.

- f) Select the check box **Active user** to activate the user.
5. Use the **Add user to group** action to add an existing user to a user-created group.
- a) Double-click or drag the **Add user to group** action.
  - b) Select the **Add users from server** option. To add an existing user from the server, enter these details : **Host**, **Domain**, **Username**, and **Password** in the **Connect to server** window and then click **Connect**.
  - c) Enter `AA_India_Documentation` in the **Group name** field.
  - d) Enter `Default` in the **Session name** field.

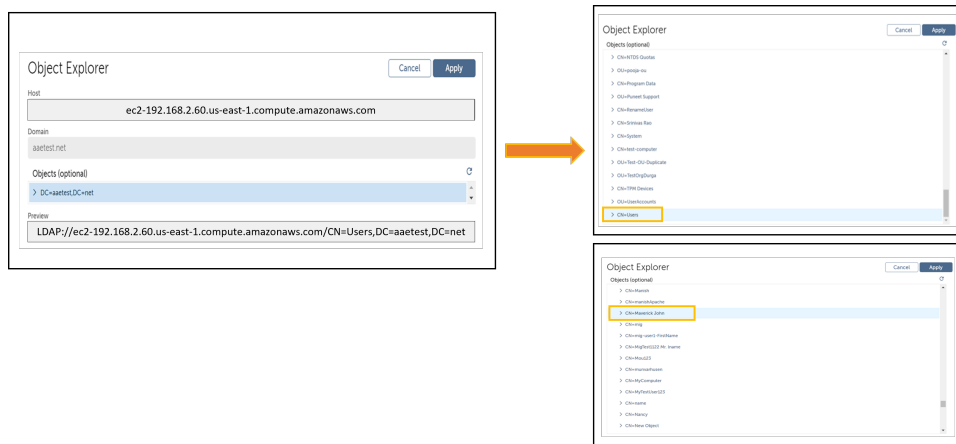

6. Use the **Set user property** action to assign a value to a user property, view the current details, and update it.
- a) Double-click or drag the **Set user property** action.
  - b) Enter `Default` in the **Session name** field.
  - c) Select the **User name** option and enter `Maverick John`.
  - d) Enter `displayName` in the **Property** field.
  - e) Enter `Mark` in the **Value** field.
7. Use the **Get user property** action to retrieve a specific property value for a user and assigns the results to a variable.
- a) Double-click or drag the **Get user property** action.
  - b) Enter `Default` in the **Session name** field.
  - c) Select the **User name** option and enter `Maverick John`.
  - d) Enter `displayName` in the **Property** field.
  - e) Select `SampleString` variable to assign value.

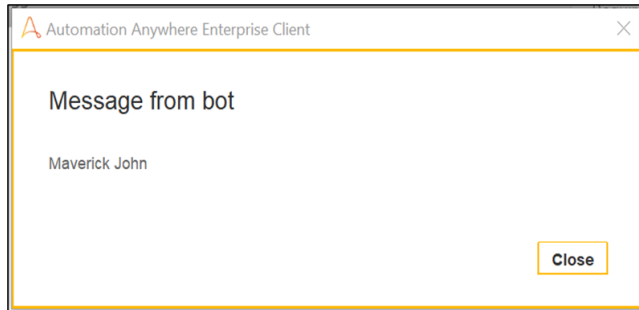

8. Use **Message box** action to print the values.
  - a) Double-click or drag the **Message box** action.
  - b) In the **Enter the message to display** field, select `$SampleString$`.
  
9. Use the **Rename user** action to rename the user logon name or the user account name.
  - a) Double-click or drag the **Rename user** action.
  - b) Enter `Default` in the **Session name** field.
  - c) Select the **User name** option and enter `Maverick John`.
  - d) Enter `Maverick John Ray` in the **New name** field.
  - e) Select the **Rename user name** option to update.
  
10. Use **Update user details** action to update the details of a user.
  - a) Double-click or drag the **Update user details** action.
  - b) Enter `Default` in the **Session name** field.
  - c) Select the **User name** option and enter `Maverick John`.
  - d) Enter `Maverick John Ray` in the **First name** field.
  
11. Use the **Disable user account** action to disable a user account.
  - a) Double-click or drag the **Disable user account** action.
  - b) Enter `Default` in the **Session name** field.
  - c) Select the **User name** option and enter `Maverick John Ray`.
  
12. Use the **Delete user** action to delete an existing user.
  - a) Double-click or drag the **Delete user** action.
  - b) Enter `Default` in the **Session name** field.
  - c) Select the **User name** option and enter `Maverick John Ray`.
  
13. Use the **Disconnect** action to close the connection with the LDAP server. In the **Session name** field, enter `Default`.
14. Click **Save** and then **Run**.

## Example of using Custom column option in Data Table package

In this example, you will build a bot to read a CSV file, assign it to a data table variable, and then modify the table by adding a new column. Use the Custom column option in the Data Table package to insert columns at a specified index.

Before you start building the bot, create a file in .CSV format using the data in the following table and save it as `Data_table_input.csv`.

Name	Company	Availability
Rene	AA	FALSE
Leote	DG	FALSE
Shane	CV	FALSE

1. Create a bot.
  - a) On the left panel, click **Automation**.  
A list of available bots and forms is displayed.
  - b) Click **Create New > Bot**.
  - c) In the **Create Task Bot** window, enter a name for the bot: `Datatable_test`.
  - d) Accept the default folder location: `\Bots\`. To change the default bot storage location, click **Choose** and follow the prompts.
  - e) Click **Create and Edit**.
2. Open and read data from the CSV file.
  - a) Double-click or drag the **CSV/TXT > Open** action.
  - b) In the **Session name** field, enter `Session 1`.
  - c) In the **File path** field, click **Browse** to select your file.

**CSV/TXT: Open**

Opens a CSV/TXT file

Required bot agent version: 20.11 or above

Session name

🗨 Session 1 (x)

File path

Control Room file Desktop file Variable

🗨 C:\Temp\Data table\_input.csv (x) Browse...

Required extensions: ".csv", ".txt", ".tsv"

- d) Select the **Contains header** check box.
- e) In the **Delimiter** tab, select the **Comma** check box.
- f) Double-click or drag the **CSV/TXT > Read** action.

- g) In the **Session name** field, enter `Session 1`.
  - h) In the **Assign value to the variable** field, create a table variable `TableFromCSV` to save the output.
  - i) Double-click or drag the **CSV/TXT > Close** action.
3. Insert a new column of data type `String` to the existing table.
- a) Double-click or drag the **Data Table > Insert column** action.
  - b) In the **Destination table** field, select the variable `TableFromCSV`.
  - c) From the **Insert column at index** field, select **last index**.
  - d) From the **Insert column** option, select **Custom column**.
  - e) In the **Column name** field, enter **Address**.
  - f) In the **Column type** field, select the data type as **String**.
  - g) In the **Default value** field, enter `Bangalore`.
4. Write the new data to the CSV file.
- a) Double-click or drag the **Data Table > Write to file** action.
  - b) In the **Data table name** field, select `TableFromCSV` variable.
  - c) In the **Enter file name** field, select the CSV file that you have saved on your desktop.
  - d) From the **When writing** field, select the **Overwrite existing file** option.
5. Open the CSV file to view the updated data.
- a) Double-click or drag the **Excel advanced > Open** action.
  - b) In the **File** tab, click **Browse** to select your file.
  - c) Select the **Sheet contains a header** check box.
  - d) Select the **Read-write mode** option to enable reading and editing of the file.
  - e) Double-click or drag the **Delay > Delay** action.
  - f) Enter a delay time of 5 seconds.
6. Close the CSV file.
- a) Double-click or drag the **Excel advanced > Close** action.
  - b) Select the **Save changes when closing file** option.
  - c) In the **Session name** field, select the name of the session that you used to open the CSV file.
7. Insert a new column of data type `DateTime` to the existing table.
- a) Double-click or drag the **Data Table > Insert column** action.
  - b) In the **Destination table** field, select the variable `TableFromCSV`.
  - c) From the **Insert column at index** field, select **specific index** and specify the index in the text field.
  - d) From the **Insert column** option, select **Custom column**.

- e) In the **Column name** field, enter **Date of joining**.
8. Open the CSV file to view the updated data.
    - a) Double-click or drag the **Excel advanced > Open** action.
    - b) In the **File** tab, click **Browse** to select your file.
    - c) Select the **Sheet contains a header** check box.
    - d) Select the **Read-write mode** option to enable reading and editing of the file.
    - e) Double-click or drag the **Delay > Delay** action.
    - f) Enter a delay time of 5 seconds.
  9. Close the CSV file.
    - a) Double-click or drag the **Excel advanced > Close** action.
    - b) Select the **Save changes when closing file** option.
    - c) In the **Session name** field, select the name of the session that you used to open the CSV file.

## Example of using a file variable

Learn to use file variables in bots. There can be instances where a bot needs to access a file multiple times based on the task it performs. You can store file references in file variables and use the file variables in bots instead of adding direct file paths.

In this example, the sample bot does the following:

- Uses a file variable to access a CSV file.
- Opens and reads data from the file using the file variable.
- Retrieves and displays the address of an employee as a message.

If you do not already have a sample CSV file with addresses, you can copy the following data to a text file and save it as a CSV file on your computer:

```
Roy, Doe, 120 Jefferson St., Riverside, IT_PROG
Shaun, McGinnis, 220 Hobo Av., Rocky Point, FI_ACCOUNT
John, Mark, 124 Jefferson St., Riverside, SA_HEAD
Sophie, Tyler, 7300 Terrace "At the Plaza" Rd., Wells, IT_PROG
Stephen, Mathew, 22 Theressia St., Troy, IT_PROG
Anne, Ross, 9th St., Lexington, IT_PROG
```

1. Create a bot.
  - a) On the left panel, click **Automation**.  
A list of available bots and forms is displayed.
  - b) Click **Create New > Task Bot**.
  - c) Enter `Employee Data` as the name for the bot.
  - d) Click **Create and Edit**.
2. Create a variable named `varFile`.



- a) Click **Create variable** in the **Variables** panel.
  - b) In **Type**, select **File** as the variable type.
  - c) In **Name**, enter `varFile`.
  - d) Select **Desktop folder or file**.
  - e) In **Specific path**, click **Browse** and select the sample CSV file you have on your computer.
  - f) Click **Create**.
3. To open the CSV file using the file variable, find the **CSV/TXT** package from the **Actions** panel, and add the **Open** action to the Bot editor.
- a) In **File path**, click **Variable** and enter `$varFile$`.
  - b) Ensure that **Comma** is selected as delimiter if you are using the sample data provided in the tutorial. If your CSV file uses another delimiter, specify the delimiter.
  - c) Click **Save**.
4. To read the CSV file, find the **CSV/TXT** package from the **Actions** panel, and add the **Read** action to the Bot editor.
- a) In **Assign value to the variable**, click **(x)** to create a variable named `TableFromCSV`. The values read from the CSV file will be stored in the variable.
  - b) Click **Save**.
5. To display the address from the fourth row as a message, add the **Message Box** action to the Bot editor.
- a) In **Enter message to display**, click **(x)**.
  - b) Select the `TableFromCSV` variable.
  - c) To select the fourth row, enter 3 in **Table row index**.
  - d) To select the third column, click **Index** in **Table column**, and then enter 2. Ensure that the value entered in the **Enter message to display text** field is `$TableFromCSV[3][2]$`.
  - e) Click **Yes, insert**.
  - f) Click **Save**.
6. Run the bot.  
The bot displays the address: 7300 Terrace "At the Plaza" Rd.

## Example of using Salesforce package and record variable

Build a bot that queries Salesforce objects and writes data to a CSV file. The bot also uses a record variable to retrieve data from individual records fetched from Salesforce.

- Set up a connected app in Salesforce if you do not have one already.
- This bot uses the Control Room OAuth connection method. Create a Control Room OAuth connection before you begin to build the bot. For more information, see [Salesforce Authentication action](#) on page 2973.

- Set up sample opportunity and accounts data in Salesforce. If you do not have sample data, you can import the data from the following CSV files into Salesforce:
  - [Opportunities](#)
  - [Contacts](#)

Suppose that the Sales team at Acme Solutions Pvt Ltd decides to automate the process of getting all opportunity records with the prospecting status and then assigning them to sales representatives to follow up. The team builds a bot that performs the following tasks:

- Fetches all opportunities with the Prospecting status from the Opportunity object in Salesforce.
- Fetches the Account name from the Account object using the Account id retrieved from each opportunity record.
- Uses a record to capture data from individual opportunity records.
- Writes the records to a CSV file, which can be further processed to assign sales reps.

The sample bot uses the Salesforce, Record, Loop, and Data Table packages along with record variables to show how to perform the following automation tasks:

- Queries a Salesforce object using the Salesforce Execute SOQL action.
- Get an individual record from a Salesforce object using the Salesforce Get record action.
- Update record variables and reset record variables.
- Insert records into a Data Table variable.
- Write a Data Table to a CSV file.

1. Create a bot.
  - a) On the left panel, click **Automation**. A list of available bots and forms is displayed.
  - b) Click **Create New > Task Bot**.
  - c) In **Name**, enter `Get Sales Opportunities`.
  - d) Click **Create and Edit**.
2. Authenticate with Salesforce. For this tutorial, **Control room OAuth connection** is used as **Authentication type**. The instructions for setting up OAuth connection are beyond the scope of this tutorial. If you are not familiar with setting up OAuth connections, follow the instructions provided on this [page](#) or you can use **OAuth 2 - Client Credentials** as the **Authentication type**, and provide client id, client secret, Salesforce username, and password within the Salesforce Authentication action.
  - a) From the **Actions** panel, find and add **Salesforce > Authentication** action to the Bot editor.
  - b) In **Authentication type**, select **Control room OAuth connection**.
  - c) Click **Pick** and select the OAuth connection you have set up with the following details:
    - **Provider type: Salesforce**
    - **Connection name:** the connection you have set up.
    - **Token type: Shared.**
  - d) In **API version**, enter the version number of the API for the Salesforce connected app. For example, `50.0`.
  - e) Leave the **Session name** as `Default`.

- f) In **Mapped variables**, click **Add variable mapping**, and then map the key `InstanceUrl` to a String variable named `InstanceUrl`.
3. To check for authentication errors before executing other tasks, use the Try Catch actions.
  - a) From the **Actions** panel, find and add **Error handler > Try** action to the Bot editor.
  - b) Click the **Catch** block icon.
  - c) In **Exception**, select **Error handler**.
  - d) In **Assign exception message to**, click **(x)** and create a String variable named `ErrorMessage`.
  - e) Add the **Message box** action within the Catch block.
  - f) In **Enter the message to display**, select the **ErrorMessage** variable and save the changes.
4. Query the Salesforce Opportunity object to fetch opportunities records with the Prospecting status .
  - a) From the **Actions** panel, find and add **Salesforce > Execute SOQL** action within the **Try** block.
  - b) In **SOQL query to execute** enter the following query.

```
SELECT Id, Name, AccountId, Amount, CloseDate, StageName,
NextStep FROM Opportunity WHERE StageName = 'Prospecting'
```
  - c) In **Include deleted records**, click **No**.
  - d) Ensure `Default` is set as the **Session name**.
  - e) In **Save the outcome to a variable**, click **(x)** and create a List variable named `list_records_prospecting`.
  - f) Save the changes.
5. Loop through the list of retrieved opportunities records.
  - a) From the **Actions** panel, find and add **Loop > Loop** action after the Execute SOQL action within the **Try** block.
  - b) In **Iterator**, select **For each item in the list**.
  - c) In **list**, select the `list_records_prospecting` variable.
  - d) In **Assign the current value to variable**, click **(x)** to create variable named `dict_record_opportunity` with type **Any**.

The following is an example of a record that is stored as dictionary. The bot retrieves values only from the Name, Account name, Amount, CloseDate, StageName, and NextStep fields and leaves out the rest.

```
{attributes,com.automationanywhere.botcommand.data.impl.DictionaryValue@5d804b
{Id,0065j00001Q2ISAAA3},{Name,Opportunity #1},
{AccountId,0015j00001BU2hnAAD},{Amount,2000.0},
{CloseDate,2023-10-05},{StageName,Prospecting},{NextStep,Call to
Discuss}
```
  - e) Save the changes.

6. Before retrieving values from each field in a record, create two record variables - one for storing the values from each opportunity record and another for resetting the first record variable at the end of each iteration.
  - a) In **Variables panel**, click **Create variable**.
  - b) In **Type**, select **Record**.
  - c) In **Name**, enter `out_record_prospecting`.
  - d) Click **Create**.
  - e) Repeat steps a to d to create another record variable with the following details:  
**Type:** Record  
**Name:** `record_empty`
  
7. Update the record variable with the Opportunity name from the current record.
  - a) From the **Actions panel**, find and add **Record > Add column** action within the Loop action.
  - b) In **Source record variable**, select `out_record_prospecting`.
  - c) In **Column type**, select **String**, and in **Value**, enter `$dict_record_opportunity{Name}$`.
  - d) Click **specific index**, enter 0.
  - e) In **Destination record variable**, select `out_record_prospecting`.
  - f) Save the changes.
  
8. The opportunities records retrieved from Salesforce contain only the account IDs and not account names. Retrieve the account name using the account ID for each record.
  - a) From the **Actions panel**, find and add **Salesforce > Get record** action within the Loop action.
  - b) In **Object name**, enter Account.
  - c) Select **Record ID** and enter `$dict_record_opportunity{AccountId}$`.
  - d) In **Fields and data**, select **List** and click **Add**.
  - e) In **Type**, select **String**.
  - f) In **Value at 0**, enter Name.
  - g) Make sure `Default` is set as the Salesforce Session name.
  - h) In **Mapped variables**, click **Add variable mapping** to map the key `Name` to a String variable `AccountName`. The `Get record` call retrieves the account name using key `Name` and stores it in the `AccountName` variable.
  - i) Save the changes.
  
9. Add a new column and update the record variable with the account name.
  - a) From the **Actions panel**, find and add **Record > Add column** action within the Loop action.
  - b) In **Source record variable**, select `out_record_prospecting`.
  - c) In **Column type**, select **String**, and in **Value**, enter `$AccountName$`.

- d) Click **specific index**, enter 1.
- e) In **Destination record variable**, select **out\_record\_prospecting**.
- f) Save the changes.

10. Add a new column and update the record variable with amount.

- a) From the **Actions** panel, find and add **Record > Add column** action within the Loop action.
- b) In **Source record variable**, select **out\_record\_prospecting**.
- c) In **Column type**, select **Number**, and in **Value**, enter `$dict_record_opportunity{Amount}$`.
- d) Click **specific index**, enter 2.
- e) In **Destination record variable**, select **out\_record\_prospecting**.
- f) Save the changes.

11. Update the record variable with CloseDate, StageName, and NextStep.

- a) Add the **Add column** action to the Loop action and then enter the following details:

Field	Value
<b>Source record variable</b>	out_record_prospecting
<b>Column type</b>	String
<b>Value</b>	<code>\$dict_record_opportunity{CloseDate}\$</code>
<b>specific index</b>	3

- b) Add the **Add column** action to the Loop action and then enter the following details:

Field	Value
<b>Source record variable</b>	out_record_prospecting
<b>Column type</b>	String
<b>Value</b>	<code>\$dict_record_opportunity{StageName}\$</code>
<b>specific index</b>	4

- c) Add the **Add column** action to the Loop action and then enter the following details:

Field	Value
<b>Source record variable</b>	out_record_prospecting
<b>Column type</b>	String
<b>Value</b>	<code>\$dict_record_opportunity{NextStep}\$</code>
<b>specific index</b>	5

- d) Save the changes.

12. Insert the record into a DataTable variable.
  - a) To keep track of the iterations and use it as a row index number, create a Number variable named counter and set the default value to 0.
  - b) From the **Actions** panel, find and add **Data Table > Insert row** action within the Loop action.
  - c) In **Data table name**, click **(x)** and create a Table variable named table\_records.
  - d) Click **specific index** and enter \$counter\$.
  - e) In **Row record name**, select **out\_record\_prospecting**.
  - f) Save the changes.
  
13. Increment the counter variable by 1.
  - a) From the **Actions** panel, find and add **Number > Increment** action within the Loop action.
  - b) In **Enter number**, enter \$counter\$.
  - c) In **Enter increment value**, enter 1.
  - d) In **Assign the output to variable**, select **counter**.
  - e) Save the changes.
  
14. Reset the out\_record\_prospecting record variable before the next iteration.
  - a) From the **Actions** panel, find and add **Record > Assign** action within the Loop action.
  - b) In **Select the source record variable**, select record\_empty.
  - c) In **Select the source record variable**, click **Record** and select **out\_record\_prospecting**. Since the record\_empty variable does not have any value, the out\_record\_prospecting will be reset.
  - d) Save the changes.
  
15. Write the retrieved opportunity records to a CSV file.
  - a) From the **Actions** panel, find and add **Data Table > Write to file** action outside the Loop action.
  - b) In **Data table name**, select **table\_records**.
  - c) In **Enter file name**, specify the CSV file path. For example, C:\bots\opportunities.csv.
  - d) Select **Create folders/files if it doesn't exist**.
  - e) Click **Overwrite existing file**.
  - f) Save the changes and run the bot.

## Example of using Custom selection option in Log variables to file action

In this example, you will use the Custom selection option to log user-defined variables to an existing log file and then modify the values of the variables and log the appended data into a file.

1. Create a bot.
  - a) On the left panel, click **Automation**.  
A list of available bots and forms is displayed.
  - b) Click **Create New > Task Bot**.
  - c) Enter a name for the bot: `Log user defined variables`
  - d) Click **Create and Edit**.
2. Create the following user-defined variables using the **Create variable (+)** icon at the top of the **Variables** menu.

Data type	Variable name	Variable value
String	Day_1	monday
String	Day_2	Tuesday
String	Day_3	Wednesday
Number	Temperature_Mon	9.3555555555555589
Number	Temperature_Tues	10.822222222222222
Number	Temperature_Wed	17.800000000000004
Datetime	Time_Mon	5/7/2023 01:15 AM
Datetime	Time_Tues	5/8/2023 01:00 AM
Datetime	Time_Wed	5/9/2023 01:00 AM
Boolean	Chances_of_rain_Mon	True
Boolean	Chances_of_rain_Tues	False
Boolean	Chances_of_rain_Wed	True

3. Double-click or drag the **Log to file > Log variables to file** action.
  - a) In the Output file path field, specify the file location. For example, `D:\userdefined path\weather_forecast-data.txt`.
  - b) In the **When logging** field, select **Overwrite existing log file** option.
  - c) In the Variables to log field, select the Custom selection option and select all variables as follows:

Variables to log

By type **Custom selection**

Variables selected below, will be considered. Any variable added later will not be used

- Select all variables
- Chances\_of\_rain\_Mon
- Chances\_of\_rain\_Tues
- Chances\_of\_rain\_Wed
- Day\_1
- Day\_2
- Day\_3
- Temperature\_Mon
- Temperature\_Tues
- Temperature\_Wed
- Time\_Mon
- Time\_Tues

4. Click **Save** and then **Run**.  
The data is logged as follows:

```
Task bot name : \Bots\Log user defined variables
chances_of_rain_mon (Boolean) = true
chances_of_rain_tues (Boolean) = false
chances_of_rain_wed (Boolean) = true
day_1 (String) = monday
day_2 (String) = Tuesday
day_3 (String) = Wednesday
temperature_mon (Number) = 9.35555556
temperature_tues (Number) = 10.82222222
temperature_wed (Number) = 17.8
time_mon (Datetime) = 2023-05-07T01:15:00+05:30[Asia/Calcutta]
time_tues (Datetime) = 2023-05-08T01:00:00+05:30[Asia/Calcutta]
time_wed (Datetime) = 2023-05-09T01:00:00+05:30[Asia/Calcutta]
```

5. Double-click or drag the **String > Uppercase** action.
- a) In the **Source string** field, select Day\_1 to insert the variable.
  - b) In the **Assign the output to variable** field, select the Day\_1 variable from the drop-down.
6. Double-click or drag the **Number > Increment** action.
- a) In the **Enter number** field, select Temperature\_Tues to insert the variable.
  - b) Enter 15 in the **Enter increment value** field.
  - c) In the **Assign the output to variable** field, select Temperature\_Tues variable from the drop-down.
7. Double-click or drag the **Boolean > Invert** action.
- a) From the **Select the boolean variable to be inserted** field, select the True option.
  - b) In the **Assign the output to** field, select the Chances\_of\_rain\_Wed variable from the drop-down.
8. Double-click or drag the **Log to file > Log variables to file** action.



- a) In the Output file path field, specify the file location. For example, D:\userdefined path\weather\_forecast-data.txt.
- b) In the **When logging** field, select **Append to existing log file** option.
- c) Select the **Append timestamp** check box.
- d) In the **Variables to log** field, select the **Custom selection** option and select all variables as previously shown in Step 3c.

9. Click **Save** and then **Run**.

The updated data is logged with the timestamp details in the file as follows.

```
Task bot name : \Bots\Log user defined variables
chances_of_rain_mon (Boolean) = true
chances_of_rain_tues (Boolean) = false
chances_of_rain_wed (Boolean) = true
day_1 (String) = monday
day_2 (String) = Tuesday
day_3 (String) = Wednesday
temperature_mon (Number) = 9.35555556
temperature_tues (Number) = 10.82222222
temperature_wed (Number) = 17.8
time_mon (Datetime) = 2023-05-07T01:15:00+05:30[Asia/Calcutta]
time_tues (Datetime) = 2023-05-08T01:00:00+05:30[Asia/Calcutta]
time_wed (Datetime) = 2023-05-09T01:00:00+05:30[Asia/Calcutta]
-----
Logged date : 30-05-2023 14:37:35
Task bot name : \Bots\Log user defined variables
chances_of_rain_mon (Boolean) = true
chances_of_rain_tues (Boolean) = false
chances_of_rain_wed (Boolean) = false
day_1 (String) = MONDAY
day_2 (String) = Tuesday
day_3 (String) = Wednesday
samplenumber (Number) = 0
samplestring (String) =
temperature_mon (Number) = 9.35555556
temperature_tues (Number) = 25.82222222
temperature_wed (Number) = 17.8
time_mon (Datetime) = 2023-05-07T01:15:00+05:30[Asia/Calcutta]
time_tues (Datetime) = 2023-05-08T01:00:00+05:30[Asia/Calcutta]
time_wed (Datetime) = 2023-05-09T01:00:00+05:30[Asia/Calcutta]
-----
```

## Create dictionary type variables

Use Automation 360 to create dictionary type variables using different dictionary subtypes and key value type parameters.

- Ensure you have access to the Control Room.
  - You must have credentials with **AAE\_Basic** permissions.
  - Your workstation must be a registered device in the Control Room.
1. Log in to the Control Room.
  2. On the left pane, click **Automation**.  
A list of available and forms is displayed.
  3. Click the **Create a bot** icon.
  4. In the **Name** field, enter DictionaryMapping, and click **Create & Edit**.
  5. From the Bot editor, click **Variables** > **Create variable** (+ icon) at the top of the **Variables** menu to create four new custom dictionary variables:

Variable type	Subtype	Variable name	Default value
Dictionary	String	Dictionary1	<b>Key:</b> Company name <b>Value:</b> Acme publication
Dictionary	String	Dictionary2	<b>Key:</b> Company Registration number <b>Value:</b> ASPER21365NML
Dictionary	Number	Dictionary3	<b>Key:</b> Total employees <b>Value:</b> 3000
Dictionary	Any	Dictionary4	<ul style="list-style-type: none"> <li>• <b>Type: String</b> <ul style="list-style-type: none"> <li>• <b>Key:</b> Employee name</li> <li>• <b>Value:</b> Bob Jones</li> </ul> </li> <li>• <b>Type: Datetime</b> <ul style="list-style-type: none"> <li>• <b>Key:</b> Date of Joining</li> <li>• <b>Value:</b> 9/20/2023</li> </ul> </li> <li>• <b>Type: Boolean</b> <ul style="list-style-type: none"> <li>• <b>Key:</b> Employment type- Contractor</li> <li>• <b>Value:</b> True</li> </ul> </li> <li>• <b>Type: Number</b> <ul style="list-style-type: none"> <li>• <b>Key:</b> Phone number</li> <li>• <b>Value:</b> 7777777777</li> </ul> </li> </ul>

6. In the **Actions** pane, find **Message box**. In **Enter the message to display**, enter **F2**, and select the following variables:

- \$Dictionary1{"Company name"}\$
- \$Dictionary2{"Company Registration number"}\$
- \$Dictionary4{"Employment type - Contractor"}\$

- `$Dictionary4{"Employee name"}$`
- `$Dictionary4{"Date of Joining"}$`
- `$Dictionary4{"Phone number"}$`

7. Save and run the **DictionaryMapping** Task Bot.  
The output is displayed as:

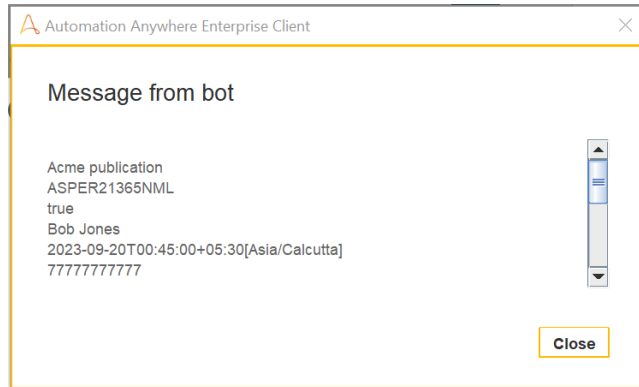

Related concepts

[Package SDK examples](#) on page 3521

This section contains code examples and explanations about how to code some basic bot capabilities.

## Attended and unattended automation

Automation 360 provides attended and unattended automation for users to create bots that can manage routine tasks efficiently. While users focus on critical inputs that require manual overview or approval, bots handle tasks such as gathering information across databases, validating data, or responding to chats.

### Overview

Collaboration between humans and software bots is called attended automation. As attended automation requires user supervision, it is best suited for use with smaller and more fragmented tasks. However, some tasks within a business process do not change a lot over time and might not require extensive user intervention, such as collecting data or retrieving information from multiple databases. When such tasks that require little or no user judgment are configured to trigger other bots, it is called unattended automation. Unattended automation is useful to perform privileged operations, requiring elevated permissions and credentials.

Automation 360 offers a combination of attended and unattended automation for a complete automation solution with the following benefits:

- Automated integration between multiple applications or databases, reducing errors as very little user intervention is necessary.
- Access bots in real-time through an easy to use interface.
- Users can set up or change triggers to start bots based on real-time.

Watch the following video to understand attended automation:

Related concepts

[Using Automation Co-Pilot for Business Users on desktop](#) on page 3360

Use Automation Co-Pilot for Business Users through your desktop to manage routine tasks such as validating data, retrieving approvals, and managing escalations through bots.

Related information

[Using bots to solve problems](#)

## Using interactive forms

Interactive forms enable you to build forms for submitting and regrouping data that is used to send and receive information from various applications within your attended automation process.

Interactive forms provide a list of actions that you can drag into a bot as a task logic. Specific function of each action is displayed when you hover over them. The actions within the interactive forms can be broadly classified into the following types:

Form level actions

Represented by  and used within a task logic to manage the linked form.

Element level actions

Represented by  and used to manage elements of a form.

Watch the following video to understand how to use Interactive forms in Automation 360:

## Add a form to bot

Adding an existing form to a bot enables users to collaborate with bots. Use the necessary action items to create a bot and build a task logic.

This task describes a scenario where you want to design a bot that triggers an existing New User Registration form. A **Hot key** preset trigger starts the bot. An existing form that is linked to the bot is displayed where the user enters the information.

- If the user clicks **Submit**, a User Agreement form is displayed.
- If the user clicks **Cancel**, User registration is canceled message is displayed and the bot is terminated.

1. On the left pane, click **Automation**.  
A list of available and forms is displayed.
2. Click **Create new > Bot**.
3. Enter a name for the bot.  
All the bots are stored in the \Bots folder. Click **Browse** to change the folder.
4. Click **Create & edit**.  
The bot builder pane is displayed that has **Flow** (default view), **List** and **Dual** view. You can drag the required actions from the left pane to create a task.
5. In **Triggers > Hot key**, drag **Hot key trigger** into **Drag a trigger here** in the bot logic.
6. Set **Ctrl** and **L** as the hot key combination.
7. Use the **Search actions** field to find **Interactive forms**.
8. Drag **Display** into the task logic.

You can use the display action to show the form when the bot is triggered. The display action properties appear on the right.

9. Click the create variable icon (  ) to create a variable.  
You have to create a form variable by linking an existing form. This enables you to use the form variable and the associated form across multiple instances.
- 
- Note:** The form variable can be linked only to forms created using the Control Room form builder.
- 
10. On the **Create variable** screen, enter a name for the form variable you are creating.
  11. Click **Browse** and select the New User Registration form.  
This links the New User Registration form to the form variable that you are creating.
  12. Click **Create & select**.  
A new form variable is created. For any existing form variable, use the **Form name** drop-down menu to select it.
  13. Use the **Search actions** field to find **Trigger loop** and drag it to add event monitoring.  
Event monitoring enables you to simultaneously set multiple events within the task logic of a bot.
  14. Drag **Handle** into the **Trigger loop**.  
Handle enables you to run an action by configuring a trigger in the **Trigger loop: Handle** for the bot. You can set a trigger when a event occurs on the selected interface (selected application) or when a user clicks the selected form element.
  15. For this scenario, use the **Trigger on** drop-down menu to select **INTERACTIVE FORMS > Form trigger**.
  16. Click the **Form name** drop-down menu and select the New User Registration form.  
This enables you to set a trigger for the **Submit** option of the New User Registration form.
  17. Click the **Form element** drop-down menu and select **Submit**.  
For the **Button** element of a form, the **Select action trigger** is set to **Clicked** by default. When the user clicks **Submit** on the New User Registration form, it triggers the User Agreement form.
  18. (Optional) Use **Assigned to** to create a variable.  
You can use this variable to fetch various details for the element you have selected in the **Form element** drop-down menu. This return value is either a string or number based on the element type selected. For example, if you have selected the **Date** element, the return value is a string.
  19. Search for **Interactive forms** and drag **Display** into **Trigger loop: Handle**.
  20. Click the **Form name** drop-down menu and select User Agreement form.  
The User Agreement form appears.
  21. Search for **Message** and drag it into **Trigger loop: Handle**, after **Interactive forms**.  
A successful registration message appears when the user clicks **Submit**.
  22. Terminate the trigger by dragging **Break** into the **Trigger loop**.  
Use **Break** to exit the current event loop and for actions where finishing a process is required.
  23. Drag another **Handle** next to the **Trigger loop: Handle**.  
This enables you to set a trigger for the **Cancel** option of the New User Registration form.
  24. Click the **Form element** drop-down menu and select **Cancel**.

25. Search for **Message** and drag it into **Trigger loop: Handle**. Update the **Enter the message to display** field as User registration is canceled.

When the user clicks **Cancel** on the New User Registration form, it triggers a `User registration is canceled` message and terminates the bot.

26. Drag **Trigger Loop > Break** to terminate the loop.

27. Click **Save**.

28. Click **Run with triggers**.

The **Run with triggers** sets the **Hot key** trigger to start the bot, which is Ctrl plus L combination from the keyboard in this scenario.

Related reference

[Interactive forms package](#) on page 2738

The interactive forms package contains actions that handle exceptions encountered by a bot. All the actions performed by users on the interactive forms can be monitored to execute logic using subtasks.

## Automation Co-Pilot

Automation Co-Pilot is part of the Automation Success Platform that enables both business users and automators to accelerate productivity across their enterprise by engaging with and developing AI-powered solutions for customer service, finance, supply chain, and IT helpdesk. Automation Co-Pilot is a generative AI-powered assistant that is engineered for automation.

Business users and automators can quickly deploy and deliver automation and AI across their systems and applications on a unified platform with a human-in-the-loop. You can embed Automation Co-Pilot into your favorite applications.

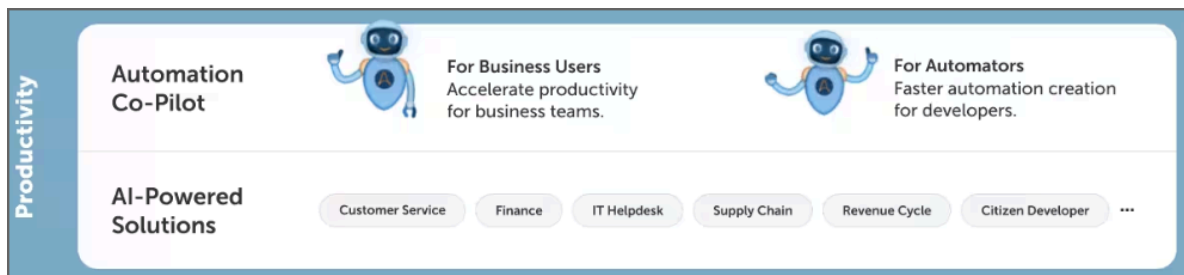

### Benefits of Automation Co-Pilot

Using Automation Co-Pilot, you can:

- Simplify everyday tasks, such as reporting and keeping track of urgent requests.
- Collaborate easily with your team's applications and bots, thereby improving average handle time and resolution rate, which helps improve customer satisfaction.
- Speed up even the most complex requests by automating escalations and approvals.
- Accelerate return-on-investment owing to minimal investment on infrastructure, training, and set-up costs for your enterprise.

## What you can do with Automation Co-Pilot

Automation Co-Pilot enables real-time communication between users and bots. By using Automation Co-Pilot to automate repetitive and time-consuming tasks, you can improve customer experience, increase employee productivity, and cut operational costs for your organization.

The following image describes how Automation Co-Pilot enhances automation:

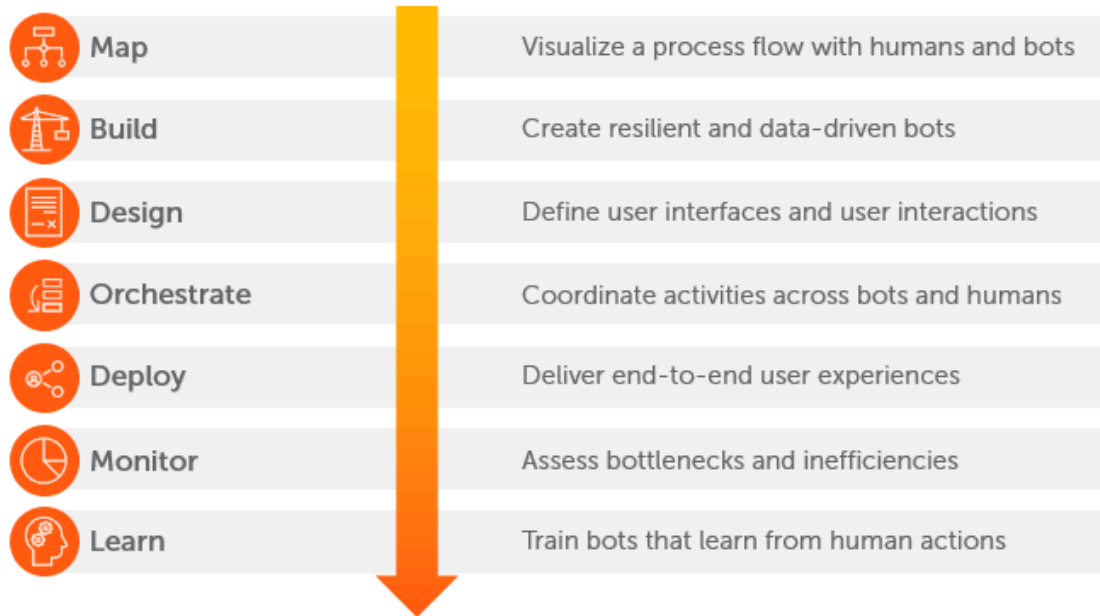

## Automation Co-Pilot for Business Users

Automation Co-Pilot for Business Users provides a simple, front-end interface for users to execute and interact with bots and applications. You can use Automation Co-Pilot for Business Users to create, run, and access end-to-end process automations across enterprises by connecting bots in the front and back offices. For more details, see [Automation Co-Pilot for Business Users](#) on page 3296.

## Automation Co-Pilot for Automators

Automation Co-Pilot for Automators enables you to empower everyone, from professional developers to business users, to use generative AI to transform natural language into automations and dramatically reduce the time, cost, and effort to create automations. For more details, see [Automation Co-Pilot for Automators](#) on page 3418.

## Automation Co-Pilot workflow

Workflow map: Click the following schematic image to view the Automation Co-Pilot workflow in an interactive visual format:



### 1. [Get started with AARI](#)

See also, [Create a team and assign roles to team members](#) on page 3387

## Automation Co-Pilot for Business Users

Automation Co-Pilot for Business Users provides a simple, front-end interface for users to execute and interact with bots and applications.

**Note:** Roles, permissions, and licenses may continue to reference Automation Anywhere Robotic Interface (AARI)] within the product.

### How to use Automation Co-Pilot for Business Users

Business users can use Automation Co-Pilot for Business Users to create, run, and access end-to-end process automations across enterprises by connecting bots in the front and back offices. For more details about the tasks and goals of a business user, see [Understanding the Business user](#) on page 3401.

You can access Automation Co-Pilot for Business Users through the following interfaces where you can connect to business workflows at multiple touchpoints:

- **Web browser:** Access Automation Co-Pilot for Business Users through a URL to manage front and back office functions, gathering input and approval from a single interface. With [Automation Co-Pilot for Business Users on the web interface](#) on page 3372, you can create automations using attended and unattended bots. It provides a unified experience to view and organize your documents and tasks, perform actions, and deliver automations with a process-centric approach.
- **Desktop:** Retrieve and update data with custom forms. You can view and interact with all data from a single screen instead of switching between multiple systems. [Using Automation Co-Pilot for Business Users on desktop](#) on page 3360, you can access and run automations as an attended Bot Runner without logging into the Control Room. Manage routine tasks such as validating data and retrieving approvals with interactive forms, and managing escalations through bots by adding triggers.
- **Embed automations:** [Embed automations in your application using Automation Co-Pilot](#) on page 3298 to deliver automation anywhere you want. Access automated processes and bots from any platform with an embedded interface. You can integrate Embedded Automation with



your web application or deliver it through a browser extension such as: Microsoft Teams, SAP, ServiceNow, Workday, and Genesys.

- Applications: Execute bots from various third-party applications that are integrated with Automation 360 using their built-in connectors such as: Salesforce, Google Workspace, Genesys, MuleSoft, ServiceNow, Workday, or SAP; and through Automation 360 pre-built Integration Platform as a Service (IPaaS)s such Apigee, SnapLogic, and Workato.
  - [RPA Bots for Salesforce](#)
  - [RPA Bots for Google Workspace](#)

The following image shows the process flow differences between Automation Co-Pilot for Business Users on the desktop and on the web:

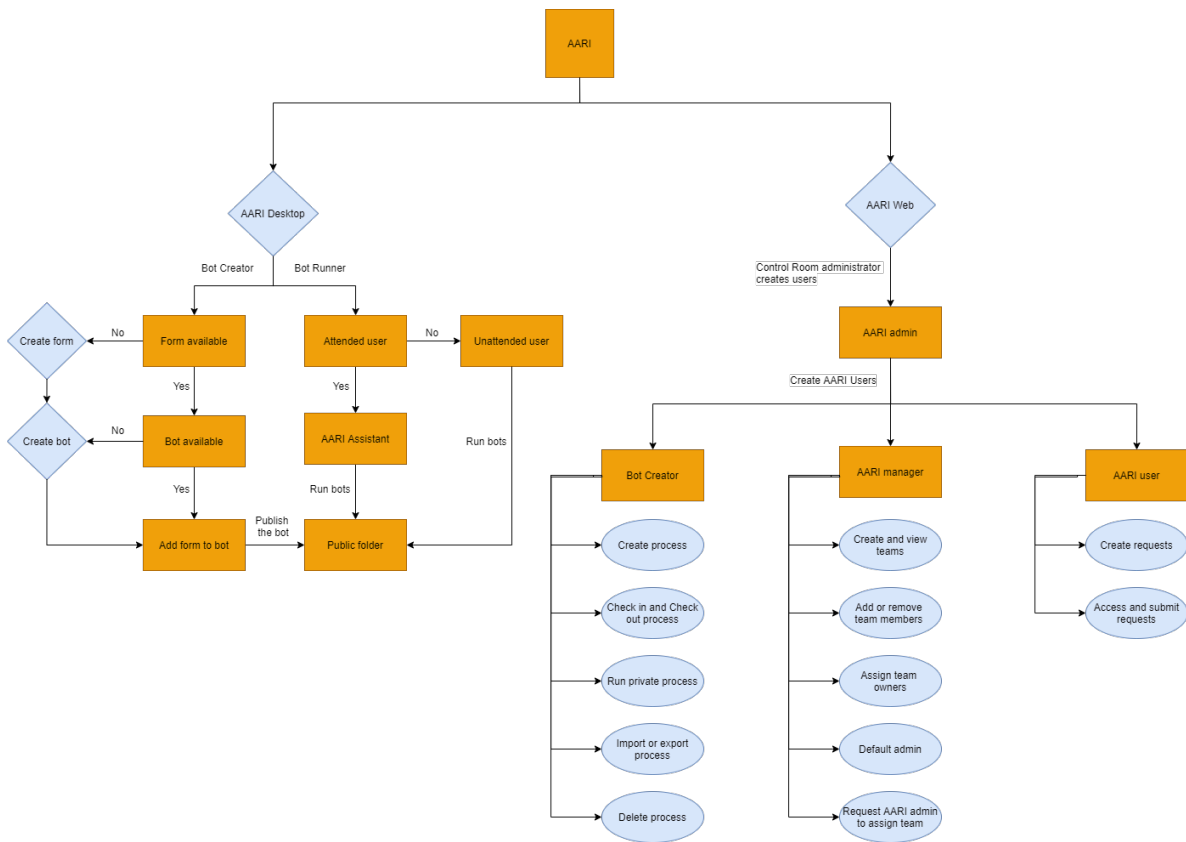

Click the following schematic image to view the Automation Co-Pilot workflow in an interactive



visual format:

1. [Get started with AARI](#)

Related concepts

[Automation Co-Pilot for Business Users on the web interface](#) on page 3372

The Automation Co-Pilot for Business Users on the web interface is an intuitive portal and dedicated workspace for the AARI User to create requests, run tasks, and for an AARI Manager to create manage team roles and deployment.

[Using Automation Co-Pilot for Business Users on desktop](#) on page 3360

Use Automation Co-Pilot for Business Users through your desktop to manage routine tasks such as validating data, retrieving approvals, and managing escalations through bots.

[Data security for generative AI - FAQ](#) on page 1081

We have introduced generative AI (GenAI) infused features to help our customers realize productivity gains by building better and smarter automations. Our customers can realize the power of GenAI with features such as Automation Co-Pilot for Business Users and Document Automation.

## Embed automations in your application using Automation Co-Pilot

Using the Automation Co-Pilot interface, you can embed automations into any web application or cloud environment using an intuitive widget or browser extension.

With embedded automations, you can provide users access to data in essential forms, applications, and business history across platforms. With automation only a click away, users no longer need to keep additional applications open on their workspace. Users can quickly reach out to customers or colleagues, and deliver information to improve the customer experience, or promote business continuity and efficiency, respectively. Whenever users need business data, Automation Co-Pilot ensures that it is readily available.

## Methods to embed automations with Automation Co-Pilot

You can use either of the following two methods to embed automations with Automation Co-Pilot:

- Use an iFrame widget for web apps which support customization: You can add an iFrame widget (composed from an HTML inline frame) to the source code of your web application to enable end-users access to automated processes and bots without leaving their familiar environments. You can configure and access the iFrame widget in supported web browsers.
- Use a Google Chrome extension widget for web apps which do not support customization: You can develop custom bricks that are coded into your browser through an extension and embed our interface as a side panel of the web browser. A Google Chrome extension renders the interface to enable end-users access to automated processes and bots without leaving the web application in the browser. Extensions provide additional adaptability through web page customization. With an OAuth 2.0 connection, existing access to automations in the Automation Workspace is shared with Automation Co-Pilot (extensions) providing a seamless user experience.

The diagram illustrates two methods for embedding Automation Co-Pilot into a web application. On the left, the **iFrame Widget** is shown as a sidebar panel within a web application interface, listing various automation tasks like 'Change payment terms' and 'Set up payment account'. Below it, a box states it is for web apps supporting customization. In the center, a vertical flow of icons and text describes the shared features: 'Embed automation in any web application', 'Attended, unattended and process automations', 'Lightweight and responsive interface', and 'Seamless authentication with OAuth 2.0 or SAML SSO'. On the right, the **Chrome Extension Widget** is shown as a side panel in a Chrome browser, displaying a list of automation tasks with status indicators like 'Pending'. Below it, a box states it is for web apps not supporting customization.

Click the video link for a demonstration of the two available embed methods.

## Comparing automation embed methods

Based on your business needs, you should compare the two Automation Co-Pilot methods of embedding automation and decide which is right for your situation. As you explore using Automation Co-Pilot with the embedded widget or with the Google Chrome extension, both methods might seem similar. Both methods provide your environment with an iFrame widget interface powered by AARI. The iFrame widget hosts automation from AARI on the web and offers the same power of automating with Automation 360.

However, depending on where you want to embed automation, one method might be better than the other. Before you select an embed method (iFrame widget or Google Chrome extension),

review the following prerequisites, technical specifications, and styles of the two methods described in the table:

Table 7: Embed methods comparison

Specification	iFrame widget	Google Chrome extension
Automation 360 version	Automation 360 v.26 or later	Automation 360 v.26 or later
Supported web browser	<ul style="list-style-type: none"> <li>Google Chrome</li> <li>Microsoft Edge</li> <li>Apple Safari</li> </ul> <p>See <a href="#">Browser requirements for Automation Workspace</a> on page 1210.</p>	Google Chrome
AARI licenses and fluency	Yes	Yes
Location of widget	Automation Co-Pilot embedded in web application	Widget appears outside the application as an Automation Anywhere stylized panel
Requirement	Web application supports iFrame widget	OAuth 2.0 Control Room configuration for server validation

## Getting started with an embed method

Using Automation Co-Pilot, the AARI Admin has the key role of organizing access points for business users. The AARI Admin selects configurations from Automation Co-Pilot to the desired application.

- For Automation Co-Pilot using an embedded iFrame widget, the iFrame widget embeds seamlessly into adjacent content of your web application. The AARI Admin must first set up and configure the iFrame widget details and then assign automation to teams by adding specific members of a team and defining the team owners and admins. After setup is completed, business users can deploy automation in their web application using the iFrame widget. For more details, click [Automation Co-Pilot using embedded widget overview](#) on page 3301.
- Automation Co-Pilot using Google Chrome extension has a similar setup process yet differs in how users access the interface. Because the interface is accessed through the Google Chrome browser, a developer must enable web components for the extension.

The AARI Admin then completes the setup and configuration of the iFrame widget. Next, a bot creator develops a web component using a **Page Editor** assisted by a generated iFrame widget embed code. Newly created web components become visible within Automation Co-Pilot using the Google Chrome extension for administrators to assign to teams. Assigned users will then navigate to their web application and access the components, while logged in to their Automation Workspace. For more details, click [Automation Co-Pilot using Chrome extension](#) on page 3326.

## Automation Co-Pilot using embedded widget overview

You can use a widget that embeds automation built on the Automation 360 platform that can be applied natively on any supported web application.

### Capabilities

#### iFrame widget

A widget that is composed from an HTML inline frame, or simply iFrame widget, can be used as a "window" to access another website located in your current web application environment. In addition, the iFrame widget provides reliable and secure methods of quick integrations performance without the need for heavy development work, when involved with custom integrations.

For example, your current web application environment is domain 1, which can access a widget that shows a website from domain 2. These two domains exist in one shared environment, without you navigating to a separate page or window.

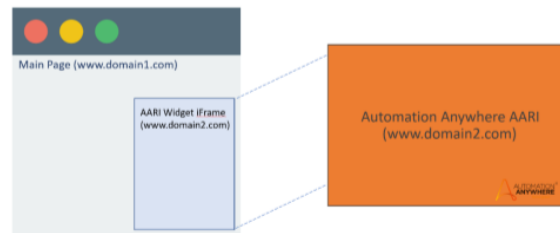

#### iFrame widget experience on supported web applications

The Automation 360 platform can support embedding an iFrame widget on any web application that supports the iFrame technology to access external contents. Many software-as-a-service (SaaS) web applications support the iFrame widget to allow for customization in a secure environment.

Business users can add contextual workflow automations from inside their most used and preferred enterprise applications. This approach means that users need to add only minimal code to their most used web applications, which when applied can produce a rich, friendly, and more secure interactive user experience.

#### Actions that can be performed with iFrame widget

Business users can use iFrame widget to perform the following:

- Invoke local automations on their desktop.

- Invoke multi-step process workflows from Automation Co-Pilot requests.
- Monitor request progress to completion.
- Receive notification of pending tasks.
- Respond directly to pending tasks from iFrame widget.
- View the history of currently running or previously completed automations.

## Requisites

- Ensure that you have the proper role and permissions. [Create users for Automation Co-Pilot](#) on page 3411
  - AARI license.
  - Proper roles for AARI Admin and AARI User.
- Automation 360 v.26 or later.
- Google Chrome, Microsoft Edge Chromium, or Apple Safari web browsers. See [Browser requirements for Automation Workspace](#) on page 1210.
- Automation Co-Pilot web interface.
- Web application that supports iFrame technology.

## Process flow

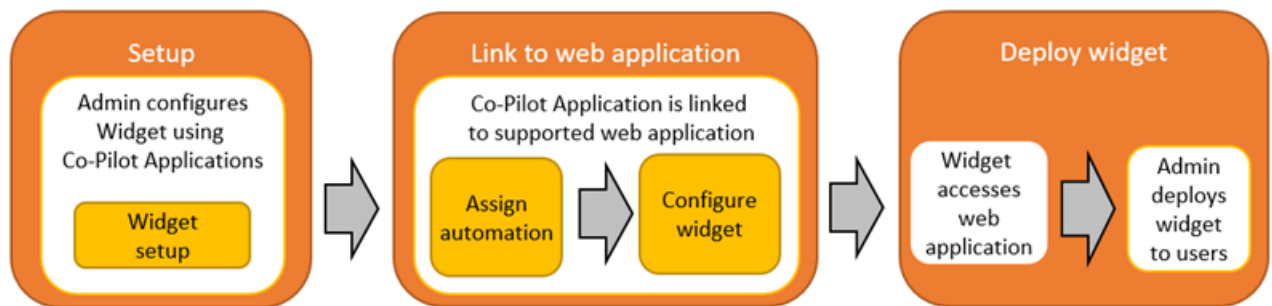

1. Set up your iFrame widget for a web application.
2. Assign automations to a team for them to access data from the iFrame widget.
3. Configure widget settings in a web application to properly access iFrame widget.
4. Deploy the iFrame widget.

Workflow map: Click the following schematic image to view the Automation Co-Pilot using embedded widget workflow in an interactive visual



format:

1. [AARI Integrations](#)

## Setup iFrame widget using Automation Co-Pilot

You can setup your iFrame widget for your supported web applications. This includes embedding a widget and configuring the iFrame widget code.

Ensure you have completed the following:

- Provided a system-created **AAE\_Robotic\_Interface Admin** role for the AARI Admin.
- Have access to the Automation Co-Pilot for Business Users on the web interface.
- Complete any necessary password changes to access the Automation Co-Pilot for Business Users on the web interface.

**Note:** Ensure third party partitioning is disabled in your Google Chrome settings. [Disable third-party storage partitioning](#) on page 3359

Create new connections to applications and configure your iFrame widget details including access to the embed code for you to copy and use in a web application.

**Important:** You can only setup the iFrame widget for web applications that support the iFrame widget. If the web application does not support the iFrame widget, refer to [Embed automations in your application using Automation Co-Pilot](#) on page 3298.

1. Log in to Automation Co-Pilot for Business Users on the web interface.
2. Navigate to **Manage > Applications**.  
The **Applications Setup** page appears for you to setup your connection. If this is your first time accessing this page, you will see the **No applications** label.
3. Click **Add application** to add a new application.
4. Specify a name for the application in the **Name** field.  
You can name it **Applications** or the name of your favorite web application to help you define the web application that you plan to embed the iFrame widget.
5. Optional: Specify a description for your application in the **Description** field.
6. Click **Create & edit**.

Your instance is now created and forwards you to an **Edit application** page where you can make edits.

7. Navigate to the **Widgets** tab in the same page.

You can add iFrame widgets to your application in this tab.

8. Click the plus (+) icon.

The **Add Widget** page prompts you to add a new iFrame widget to your application.

9. Specify a name for the iFrame widget in the **Widget name** field.

10. Specify your tags in the **Filtered automations** field.

You can select existing tags from the drop-down to add to the widget. When you add tags, they display in the embedded **widget** tab on your desktop application, in the **tags** column next to the widgets. Tags allow you to filter out automations and display only a subset of automations from the entire list. This will give you the ability to call and access only the tagged automations in your embedded widget. To add a tag, see: [Configure a process](#) on page 3398.

11. Click **Save**.

You have now successfully defined a new iFrame widget for your application.

You can now generate an iFrame code.

12. Click the three dots (ellipses) next to the name of your iFrame widget.

- **Embed code** option allows you to generate code for the iFrame widget.
- **Edit** option enables you to edit the iFrame widget details.
- **Delete** option will delete the iFrame widget.

13. Click **Embed code** option.

The **Embed code** window appears and prompts you configure the code details.

14. Specify the size of the iFrame widget width and height in the **Widget width** and **Widget height** fields, respectively.

---

**Note:** The default size of the iFrame widget width and height are **100 %**. You can change **%** (default) to **px** for pixels depending on your preference.

---

15. Click **Copy** in the **Embed code** section to copy the code.



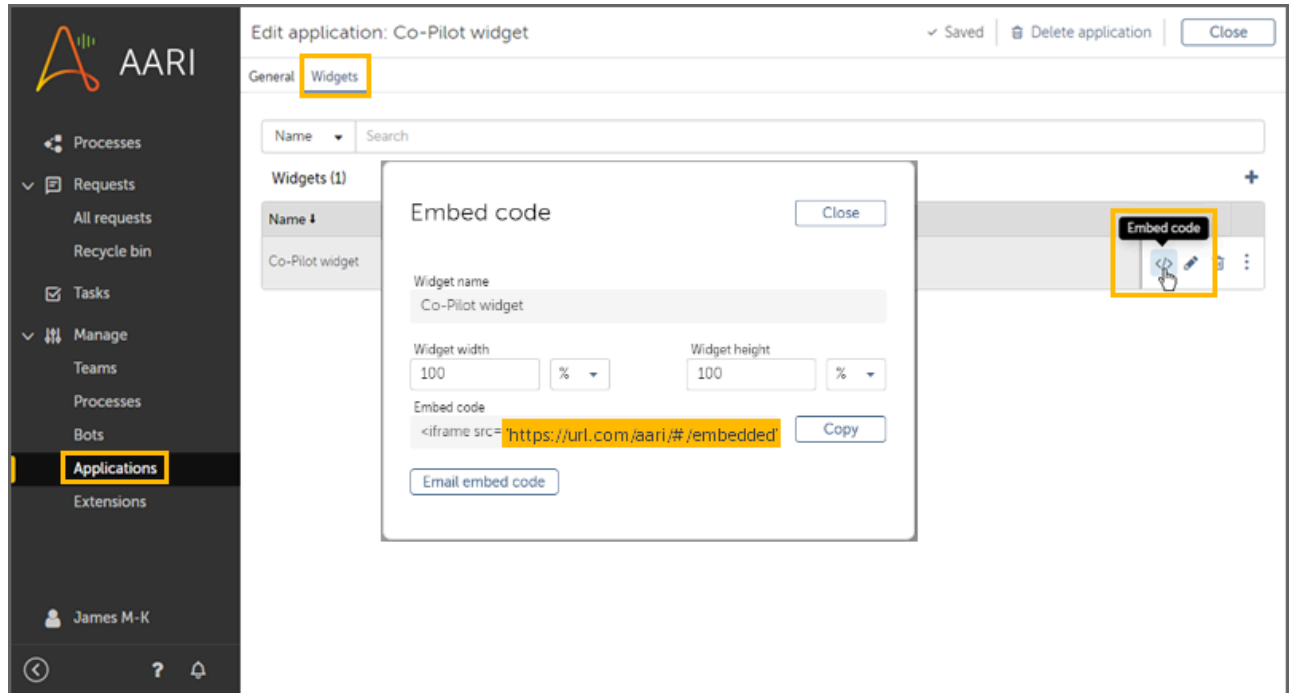

16. Optional: Click **Email embed code** if you would like to open your local mail client to email the embed code to another individual.

You now have access to the iFrame widget code.

17. Click **Close**.

You have now successfully copied your iFrame widget code that can be used in a supported web application.

For your next steps, you can assign automations to your team, see [Assign automations to teams](#) on page 3305.

## Assign automations to teams

You can configure teams to access automations and tasks for it to be accessed via Automation Co-Pilot Desktop Assistant, Automation Co-Pilot for Business Users on the web interface, and the iFrame widget embedded in other business applications.

Ensure you have completed the following:

- Provided a system-created **AAE\_Robotic\_Interface Admin** role for the AARI Admin.
- Have access to Automation Co-Pilot for Business Users on the web interface.

1. Log in to Automation Co-Pilot for Business Users on the web interface.
2. [Assign members to a team](#) on page 3306.
3. [Assign teams to a process](#) on page 3306.
4. [Assign teams to a bot](#) on page 3307.

You have now assigned automations for your team. Members of your team can now automate using the iFrame widget.

For your next steps, you can configure the widget in a web application to access to automations in the iFrame widget, see [Configure an iFrame widget in a web application](#) on page 3307.

### Assign members to a team

You can follow this task to create a new team and assign members to your team.

1. Navigate to **Manage > Teams**.  
The **Team Setup** page appears for you to create new or edit existing teams.
2. Click **Create new team**.  
The **Create a team** window appears with details for you to edit.
3. Specify the name of the team in the **Team Name** field.
4. Specify a description for your integration in the **Description** field.
5. Select the **AARI Manager** option in the **Team admin** field.  
The Automation Co-Pilot manager will be the team admin that manages the user and their access.
6. Click **Create & edit**.  
You will now be forwarded to the **Edit team** page where you can edit the team attributes.
7. Select the **Shared** or **Private** option in the **Request Visibility** section.
  - **Shared** option allows for all requests to be access by all member, owners, and team admins in the team.
  - **Private** option allows for the requests to be to be available to only the member who created the request, owner, and team admin in the team.
8. Navigate to the **Users** tab.
9. Click the plus (+) icon to add a users to your team.
10. Select a user or users to be added.
11. Click **Add & save**.  
You have now added one or more users to your team.
12. Click **Close**.  
You have successfully added users to your team. You can now add automations to the team that allows for members of your team to view and run the automations you assigned.

### Related tasks

[Create a team and assign roles to team members](#) on page 3387

An AARI Manager is a team admin who can create new teams, add members to their team, and assign new team roles. AARI Admin can also configure a team but does not have a team role.

### Assign teams to a process

You can follow this task to assign teams to a process.

1. Navigate to **Manage > Processes**.  
The **Process Setup** page appears for you manage your process.
2. Select your existing process from the list of available processes.  
For example, you select the **Ordered Items** process.  
The **Edit process** page appears with details of your process.
3. Navigate to the **Teams** tab.
4. Click the plus (+) icon to assign the teams to your process.
5. Select your team or teams.
6. Click **Add & save**.
7. You can repeat these steps and add teams to another process of your choice.

**8.** Click **Close**.

You have successfully added teams your process.

You can now assign teams to your bot.

## Related tasks

[Assign a team to a process](#) on page 3389

An AARI Admin can configure processes in the web interface and assign teams to a process for request creation. They access the web interface to view and manage processes in the **Process Setup** page.

## Assign teams to a bot

You can follow this task to assign teams to a process.

**1.** Navigate to **Manage > Bots**.

The **Bot Setup** page appears for you manage your bots.

**2.** Click **Add bot**.

The **Add bot** page appears for you to add available bots.

**3.** Select a bot or bots.

For example, you select the **Enterprise Account** bot.

**4.** Click **Add** to add bot.

The bot that you selected will now be added to the bot list.

**5.** Select the bot that was added.

The **Edit bot** page appears with details of your bot.

**6.** Navigate to the **Teams** tab.**7.** Click the plus (+) icon to assign the teams to your bot.**8.** Select the team that you have created.**9.** Click **Add & save**.**10.** Click **Close**.

You have now successfully added teams your bot.

## Configure an iFrame widget in a web application

You must configure iFrame widget settings in a supported web application to properly enable the iFrame widget.

Ensure you have completed the following:

- Provided a system-created **AAE\_Robotic\_Interface User** role for the AARI User.
- Have access to Automation Co-Pilot for Business Users on the web interface.
- Have access to the web application of your choice that supports the iFrame technology. For this task, it would be the ServiceNow Service Portal and ServiceNow App Engine Studio.

**1.** Log in to the ServiceNow Service Portal.**2.** Navigate to the **Widget Editor** page.

This page has a few options for you to configure your widget, as well as a reference for you to view any recently updated widgets.

**3.** Click the **Create a new widget** option for creating new widgets.

The **Add a Widget** window appears with details for you to specify your widget.

4. Specify the name of the widget in the **Widget Name** field.  
The ID of the widget will be automatically generated when you enter the name.  
For example, you can name your widget **AA Bots** for reference that this is an Automation Anywhere bots widget.
5. Click **Submit**.  
A new window with an HTML template or editor prompts you to enter the iFrame widget details, if applicable.

```
HTML Template
1 <div>
2 <iframe src='https://embed.aaiengineering.com/aari/#/embedded' name="aari-embedded-app" width="370px" height="650px"></iframe>
3 </div>
```

6. Paste your iFrame widget code to the **HTML** template.  
This is the iFrame widget code that you had generated in the Automation Co-Pilot (web).
7. Click **Save** or press **Ctrl + S** to save the current session.  
You have now added the iFrame widget code and saved your session. This is the code to embed your iFrame widget.
8. Access to the main page of the ServiceNow App Engine Studio.
9. Navigate to **All > Service Portal Configuration**
10. Click **Designer**.
11. Select an existing page to edit.  
You are now directed to a designer page.
12. Optional: Rearrange or remove your existing widgets on the page, to give space for the iFrame widget.
13. Drag the widget you had created (ex: **AA Bots**) from the **Widgets** tab and place it on the page.  
You have now successfully added the iFrame widget and should now be visible on the page.

---

**Important:** The iFrame widget is visible but with no styling applied.

---

14. Navigate back to the ServiceNow Service Portal
15. Click **Widget Editor**.
16. Click on your widget (ex: **AA Bots**) from the **Recently Updated** list.  
You are now navigated to the window with an HTML template. The page should also include a CSS template.
17. Specify the widget (ex: **AA Bots**) details in the **CSS** template.  
This can be the border size, style, and color of the widget.

```
CSS - SCSS
1 iframe{
2   border-width: 1px;
3   border-style: solid;
4   border-color: #dee5e7;
5   border-radius: 0.4rem;
6 }
```

18. Navigate back to the designer page.  
The iFrame widget structure has now been updated.

**19.** Refresh the page.

You will notice a small-sized window that appears and is connected to the Automation Co-Pilot (web) interface with a login page.

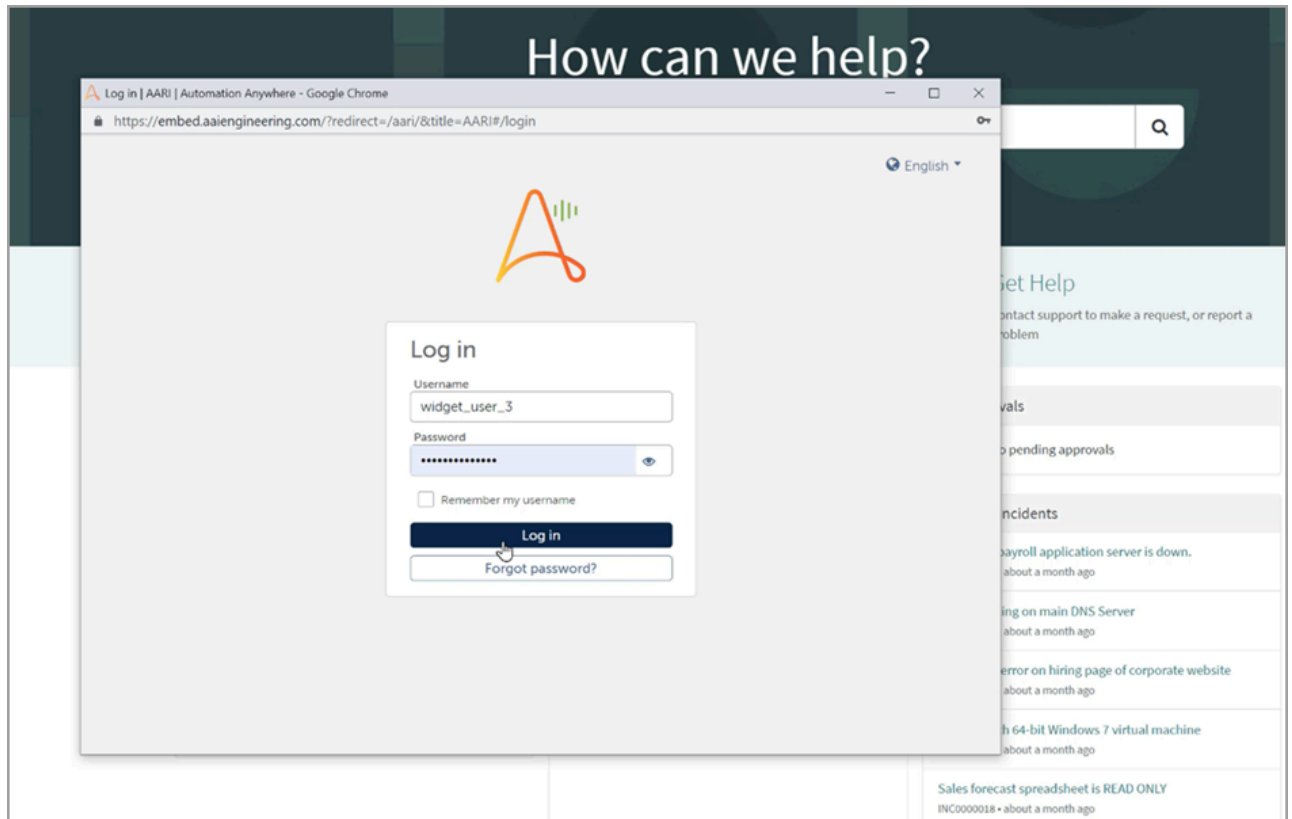
**20.** Log in with your user credentials to the iFrame widget in order to access your Automation Co-Pilot data.

The iFrame widget will refresh and a list of automations and tasks from Automation Co-Pilot is now available. You can interact directly with your data.

**21.** View the iFrame widget.

You have now successfully embedded the iFrame widget with Automation Co-Pilot data to your web application.

For your next steps, you can deploy your automations using the iFrame widget, see [Deploy automations in web application](#) on page 3310.

## Deploy automations in web application

You can now automate your tasks using the iFrame widget.

Ensure you have completed the following:

- Provided a system-created **AAE\_Robotic\_Interface User** role for the AARI User.
- Have access to Automation Co-Pilot for Business Users on the web interface.
- Have access to the web application of your choice that supports the iFrame technology. For this task, it would be the ServiceNow Service Portal.

1. Log in to the ServiceNow Service Portal.
2. Navigate to the page(s) on which you had embedded the iFrame widget.  
This can be the **Designer** portal in the ServiceNow Service Portal where you manage your data and relevant information.
3. Log in with your user credentials to the iFrame widget in order to access your Automation Co-Pilot automations.

---

**Note:** When using Automation Co-Pilot (extensions), users should open their Google Chrome extension to login.

---

This is the user that is assigned to a team.

The iFrame widget will refresh with a list of available automations.

4. Optional: Fill your initial forms using URL parameters.  
You can modify your URL with specific query parameters, to provide more control over your specific data.

**Note:** Embedded Automation supports these parameters: Check Box, Date, Dropdown, Number, Radio Button, Time, Text Area, and Text Box. For more details, see [Construct URL parameters for supported elements](#) on page 3426.

5. Run your automations or complete pending tasks.

You can deploy automations using the iFrame widget in the ServiceNow Service Portal.

**Note:** You can run your bots with the Picture-in-Picture feature. You can enable this feature when you configured your bot in Automation Co-Pilot to run in a virtual window. See [Configure a bot](#) on page 3397.

The screenshot displays the ServiceNow Service Portal interface. At the top, there are three main navigation tabs: 'Request Something' (Browse the catalog for services and items you need), 'Knowledge Base' (Browse and search for articles, rate or submit feedback), and 'Get Help' (Contact support to make a request, or report a problem). Below these, the main content area is divided into several sections. On the left, there is a 'Current Status' section with a green bar indicating 'No system is reporting an issue' and a 'More information...' link. Below that is an 'Announcements' section with the message 'Employee Center is available to you'. Further down is a 'My Assessments and Surveys' section with the message 'No assessments or surveys for you at the moment'. On the right side, there are sections for 'My Approvals' (You have no pending approvals) and 'My Open Incidents' (listing several incidents like 'Employee payroll application server is down', 'Rain is leaking on main DNS Server', etc.). In the center, a modal window titled 'Virtual Machine Request' is open, showing a 'Create new request' form. The form includes the following fields: 'VM Details' section with dropdowns for 'Provider' (Azure), 'vCPU' (8), 'Memory' (8GB), 'Hard Disk' (200GB), 'Operating System' (Windows Server 2019), and 'Expiration' (15 Days); and a 'Business Reason' section with a text area. At the bottom of the modal are 'Cancel' and 'Submit' buttons.

Related reference

[Construct URL parameters for supported elements](#) on page 3426

You can construct URL parameters for the following supported elements: **Date**, **Number**, **Text Box**, and **Time**.

## Automation Co-Pilot for Business Users supported features

There are more ways you can use Automation Co-Pilot.

### Overview

Automation Co-Pilot using embedded widget enabled you to setup your embedded iFrame widget and run your automations, while maintaining the consistent Automation Co-Pilot experience, in your favorite web applications such as ServiceNow, Salesforce, and Genesys.

There are now more opportunities for you to get the most out of the Automation Co-Pilot experience, with additional enhancements and features.

### Automation Co-Pilot in Microsoft Teams

Automation Co-Pilot allows you to bring the Automation Anywhere platform experience of running bots directly to Microsoft Teams. This allows for your business users to automate tasks without leaving their favorite collaboration applications. This can be expanded to even more automation opportunities and improve the existing routine tasks and processes.

#### Enhancements

- Automation Co-Pilot can be accessed by users at anytime from their Teams apps menu in the sidebar tab. The Automation Co-Pilot app can be pinned by users to show up next to their **Activity** and **Calendar** tabs.
- When Automation Co-Pilot is deployed in Teams, this will become a web application that is available for users, as a tab application experience.
- The automation experience will always be in Teams, without needing to navigate to or use multiple applications.
- All details and statuses of your bots, tasks, and automations are in Teams.
- The automation experience in Teams provides access to all Automation Co-Pilot functionalities, such as running your automations, complete tasks from your workflows, and being alerted by proactive notifications on your important events.

#### Benefits

- Anyone who uses Teams can use Automation Co-Pilot.
- For any employee who uses Teams for everyday tasks, they would require access to services, such as human resources, IT, or



even customer support. With a simple bot run:

- You can create a new IT ticket to contact your IT admins quicker, without the need to access Okta or other applications.
- You can contact HR directly and the bot establishes connection to your HR helpdesk.
- You might need to create a support ticket to resolve a customer issue, now you can do that directly in Teams.

See the following video for an overview of Automation Co-Pilot in Microsoft Teams:

For reference of setup process, see [Integrate Automation Co-Pilot with Microsoft Teams](#) on page 3357.

## Smart embedded forms and dynamic data mapping

As a developer, you can design smart forms to embed in a widget of a host web application and run a script to populate data dynamically. This saves you time to avoid repetitive data re-entry while you run your automations.

To learn more, see [Smart embedded forms and dynamic data mapping](#) on page 3315 and [Map data from HTML to form](#) on page 3317.

## Enhanced automation activities

In the embedded widget, you will find that when you run your automations (attended bots), the interface has been improved to show you better automation activities. You must have the **Manage my activity** permission as a prerequisite to use the bot controls.

### Enhancements

- When you run your attended automations, its progress and execution status, as well as controls to pause, start (resume), and stop, are located in a progress page inside the Embedded Automation application.
- You can easily switch between the **Automation** tab to execute additional automations and navigate back to the progress view, to monitor the running automations
- You can view more details of your bots such as the error message, when your bots had failed, to give you a better insight into your bot status.

### Benefits

- This gives you an ease of mind when you run your automations, as all the relevant

controls and details of your bots are located in one place.

- The user interface make it simpler for you to run your automations.

For reference of the user interface enhancements, see [Automation Co-Pilot Desktop Assistant automation activities](#) on page 3362.

## Platform alerts and notifications

Notifications from the Automation Workspace can work in a widget to notify users of specific task completions and bot status.

You will be notified with real-time message alerts based on recent automation events that occurred in Automation Co-Pilot. Notifications are alerts that notifies and updates you based on statuses of your automations. When you view notifications in your embedded widget, you will only see relevant updates for your automations.

### Enhancements

- The **Notifications** tab in your widget will alert you of your automation outcomes such as the successful or failed status of your bots. You no longer need to check each individual bot to view its current status.
- When you are assigned a task, the **New task assigned** message will notify you, and you can click to be redirected to the newly assigned task and confirm your details.
- You can filter your list of notifications with the **Attention needed** toggle to identify high-priority tasks that requires your attention

### Benefits

As you run your automations in your embedded widget, the notification system helps enhance your automation experience as you are updated in real time for any successful or failed bots and newly assigned tasks.

For reference, see [Notifications](#) on page 2194.

## Tags

These tag improvements provide a more accurate search and save you time when searching for available tags. You can select and manage up to 500 tags at a time in the tag selector, when you configure your process. The tag selector can display up to 500 tags at a time. You can fully or partially type keywords that makes up the tag and use the search all function for the tag selector to view the database for the tag.

---

**Note:** A minimum of two characters are required to use the search all function.

---

For reference of adding tags, see [Configure a process](#) on page 3398.

## URL Parameters

These process level URL improvements make it easier for you to pass URL data to your requests:

- You can pass custom data from applications to requests.
- Supported data types include: dates, time, number, text box, check box, radio button, text area, and drop-down.
- Hidden variable types in a form are supported to receive URL data.

See [Construct URL parameters for supported elements](#) on page 3426.

You can use supported languages from Control Room to change the localized language for your embedded widget or web page. You use the XX\_XX format to structure the language format, such as for English (**en\_US**) and French (**fr\_FR**), that you can add to the end of a URL such as **www.sampleaddress.com/en\_US** or **www.sampleaddress.com/fr\_FR**. This language format is based on the JavaScript language tags.

## Smart embedded forms and dynamic data mapping

As a developer, you can design smart forms to embed in a widget of a host web application where you can run a script to populate data dynamically.

This enhanced form builder experience enables you to quickly design smart forms with more concise controls. The smart forms are embedded as a widget (using iFrame widgets) in a web application where you can populate data dynamically and run your automations.

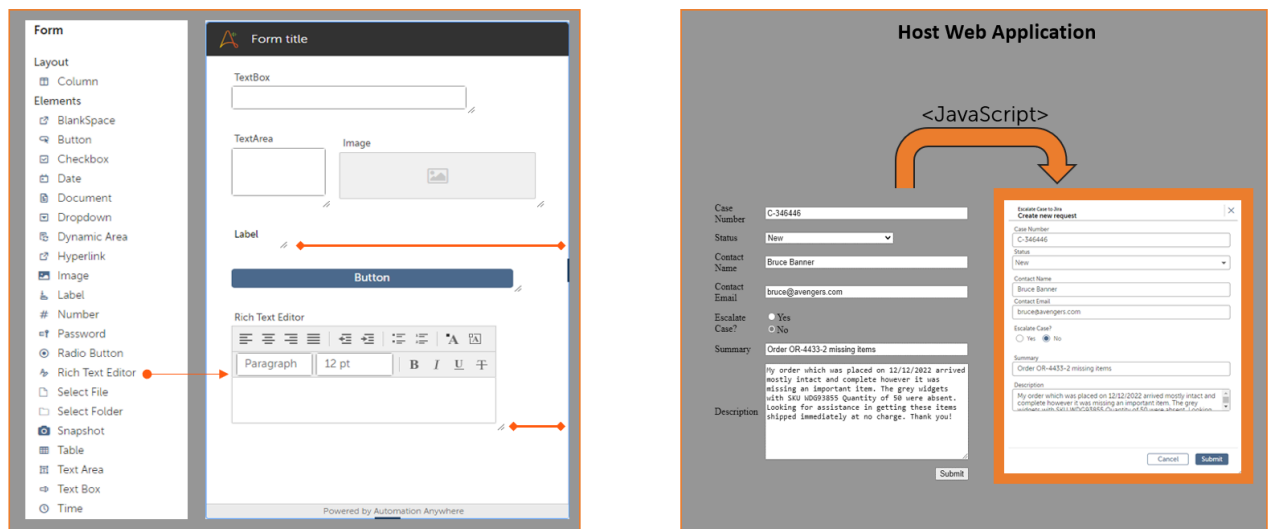

See the following video for an overview of smart forms and dynamic data mapping:

## What a developer can do

Design smart forms with the enhanced form builder:

- Drag form elements directly to the form builder to add new elements.
- Resize individual form elements to a precise length.
- Design forms to use in an embedded widget.

Populate data dynamically in an embedded widget:

- Utilize a Javascript for a host web application to read and use as inputs in processes. [Map host data to Automation Co-Pilot forms](#) on page 3317
- Run a script (postMessage API JavaScript) to populate the data of the process based on the process ID, element ID, and its value.

## Benefits

Smart embedded forms provides the following benefits:

- Dragging and resizing form elements are a seamless and consistent experience.
- Developers can quickly add new elements to their forms.
- Forms created in the form builder is rendered the same way in an embedded widget.
- Form builder supports up to 25 form elements.
- Behaviors of the older forms are maintained.

Dynamic data mapping provides the following benefits:

- Data is populated dynamically to avoid repetitive data re-entry.
- Only specified data are dynamically populated, which provides a secure way to run automations.

Related concepts

[Embed automations in your application using Automation Co-Pilot](#) on page 3298

Using the Automation Co-Pilot interface, you can embed automations into any web application or cloud environment using an intuitive widget or browser extension.

[Automation Co-Pilot using embedded widget overview](#) on page 3301

You can use a widget that embeds automation built on the Automation 360 platform that can be applied natively on any supported web application.

#### Map host data to Automation Co-Pilot forms

Configure your widget settings for a host application to populate data in the initial form of your iFrame widget. Eliminate repetitive data entry and ensure control over data during automation runtime.

As process automation typically starts with initial forms, you can streamline form completion by passing data from the host application (such as contact or account records). By configuring the iFrame widget to consume data from the host application, users can focus on verifying and engaging the customer to enhance the business experience.

For the host application to pass data, develop the iFrame widget with attributes that map values from the host and can be recognized by the iFrame as your designated input fields. This development will allow data to transfer from a page in your host application and command your iFrame widget to call the mapped data to the process automation upon launch. Most applications have a developer space for necessary code to be added to the iFrame widget. You simply need to identify what developments need to be made for your business needs.

#### The iFrame widget in host applications

When leveraging Automation Co-Pilot capabilities, like passing data into forms, it is important to consider the setup and development of web components in your host application, like the iFrame widget. Development parameters vary across applications when integrating new components like the Automation Co-Pilot widget. Familiarize yourself with your host application parameters when developing the iFrame widget to customize the components to your specific requirements.

#### Example synopsis

The following is a generic workflow to demonstrate using sample code to enable the transfer of data from host to Automation Co-Pilot (iFrame widget). Multiple example codes are available that map existing values from the host page to the Automation Co-Pilot process initial form elements.

1. Navigate to the developer environment of the host application.
2. Ensure you have a preview or testing panel available for debugging.
3. Use one of the sample code to model the code you will use for your business requirement.
  - a) [Map data from HTML to form](#) on page 3317
  - b) [Map data from Salesforce to form](#)
  - c) [Map data from ServiceNow to form](#) on page 3320
4. Ensure the parameter `referrerpolicy="origin"` is in your HTML template to avoid cross origin issues.
5. **Save** your widget.

#### Map data from HTML to form

Configure your widget from a host application and populate data in the initial form of your iFrame widget. This ensures that you have control over your data without the need for repetitive data entry.

Ensure you have completed the following:

- Provided a system-created **AAE\_Robotic\_Interface User** role for the AARI User.
- Have access to the Automation Co-Pilot for Business Users on the web interface.
- Have access to the host web application of your choice that supports the iFrame technology.

- You already set up the iFrame widget. For more details, see [Configure an iFrame widget in a web application](#) on page 3307.
- Log in to the host web application.  
This is your target application with the iFrame widget.
  - Navigate to widget settings page or source code of your host web application (where you added the iFrame widget code).  
This page contains the embedded code for your widget source.
  - Enter the host data and send data in the script.

---

**Important:** To map data, you must load a process on the host web application with a process ID, element ID, and values of the element ID which correlate with each another.

---

Example structure of host data:

```
hostData =
{
  process ID
  {
    elementID1: value1
    elementID2: value2
    elementID3: value3
  }
}
sendDataToEmbeddedApp = (processID) =>
{
  iframeElement = document.querySelector();
  iframeElement.contentWindow.postMessage({data:
  hostData[processID]},
  iframeElement.getAttribute());
}
```

---

**Note:** The element ID uses form element data types, such as: Check Box, Number, Radio Button, and Text Box.

---

An additional sample structure:

```
<script>
  const hostData = {
    '34': {
      'Number0': '70',
      'Number1': '71',
      'Number2': '72',
    },
    '30': {
      'TextBox0': 'Abhijeet',
      'TextBox1': 'Mukherjee',
      'TextBox2': 'Important One!!',
    },
  },
}
```

```

'45': {
  'CheckBoxGroup0': 'key:option1,key:CheckBox2',
  'CheckBoxGroup1': 'key:CheckBox1',
  'RadioButtonGroup0': 'Radio2',
  'TextArea0': 'Hello...',
  'Dropdown0': 'Item3'
},
'38': {
  'Number0': '45',
  'RadioButtonGroup0': 'Radio1',
  'CheckBoxGroup0': 'key:CheckBox'
},
'48': {
  'RadioButtonGroup0': 'Radio2',
}
}
const sendDataToEmbeddedApp = (processId) => {
  const iframeElement = document.querySelector('[name="aari-embedded-app"]');
  iframeElement.contentWindow.postMessage({data: hostData[processId]}, iframeElement.getAttribute('src'));
}

```

In this example: 45 is the process ID, Number0 is the element ID, and 45 is the value of the element ID.

4. **Save** your session.

You have now configured the host data, and mapped the data to your processes.

5. Navigate to the iFrame widget.

The iFrame widget should show a list of automations.

Automations	My Tasks
<b>post123-process</b> No activity	▶ 🔊
<b>postMessageTestProcess</b> No activity	▶ 🔊
<b>Various Number</b> No activity	▶ 🔊

6. Click a process to open an initial form with data already mapped and filled in.

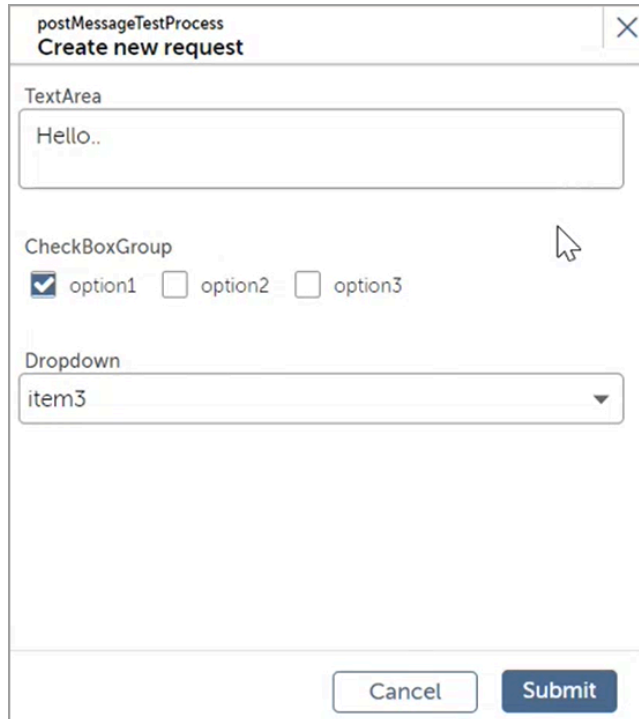
A screenshot of a web form window titled "postMessageTestProcess" with a subtitle "Create new request". The form contains three main sections: a "TextArea" with the text "Hello..", a "CheckBoxGroup" with three options: "option1" (checked), "option2", and "option3", and a "Dropdown" menu with "item3" selected. At the bottom of the form are two buttons: "Cancel" and "Submit".

The initial form shows the mapped data.

7. Click **Submit** to run your automations.

Map data from ServiceNow to form

The following example can be used to model code when developing the iFrame widget to transfer and consume host data in ServiceNow.

## Before you begin

The following example uses ServiceNow as the host application to demonstrate using HTML and JavaScript to enable the transfer of data from host to Automation Co-Pilot (iFrame widget). The referenced code maps existing values from the host page (ServiceNow) to the Automation Co-Pilot process initial form elements. The code in this example is generic and can be used in similar applications to model structure for edits made to the elements of your specific business needs. Development and setup of the iFrame widget is specific to ServiceNow parameters.

Ensure you have completed the following.

- Provided a system-created AAE\_Robotic\_Interface User role for the end user.
- Have access to the Automation Co-Pilot for Business Users on the web interface.
- Have access to the host web application of your choice that supports the iFrame technology.
- You already set up the iFrame widget. For more details, see [Configure an iFrame widget in a web application](#).



## Procedure

1. From ServiceNow, click **Start Building**. This will redirect you to your corresponding developer account. [ServiceNow developer account](#)
2. Navigate through the following: **All > Service Portal > Service Portal Configuration > Service Portal Configuration > Widget Editor > Create a New Widget**.
3. Enable **Create test page** while creating the widget to view the HTML template and client script during development.
4. Click **Enable Preview** and click the **eye** icon to show the preview tab for testing the code changes.
5. Use the following sample to model the code you will use for your business requirement.

---

**Note:** The code in this example is generic and can be used in similar applications as a model. Development and setup of the iFrame widget is specific to ServiceNow parameters. See : [Map data from HTML to form](#) on page 3317.

---

- a) Add the corresponding code to Client script.
  - b) Add the Automation Co-Pilot iFrame element to the HTML template.
  - c) Ensure the parameter `referrerpolicy="origin"` is in your HTML template to avoid cross origin issues.
6. **Save** your widget. The preview will load.
  7. Review the preview and make necessary edits to the HTML template and client script.
  8. **Save** your changes.

## Sample of HTML

```
<div>
<!-- your widget template -->
<label for="fname">First name:</label>
<input type="text" id="fname" name="fname" value="sikha"><br><br>
<label for="lname">Last name:</label>
<input type="text" id="lname" name="lname" value="poyyil"><br><br>

<iframe
src='https://aa-pet-us-17.my.automationanywhere.digital/aari/#/
embedded?tags=%5B%5D'
name="aari-embedded-app"
width="100%"
height="500px"
style="border: none;"
referrerpolicy="origin">
</iframe>
</div>
```

## Sample of Client script

```

api.controller=function() {
  /* widget controller */
  var c = this;
  console.log(c)
  console.log(window)
  var getLatestData = function() {
    return {
      167 : {
        TextBox0: document.getElementById("fname").value,
        TextBox1: document.getElementById("lname").value
      }
    };
  }
  console.log("Data" + JSON.stringify(getLatestData()));
  console.log(event)
  setTimeout(function() {
    window.addEventListener('message', function(event) {
      if(event.data.aariDataRequest === 'aari-data-request') {
        var mappedHostData = getLatestData();
        var id = event.data.processId || event.data.botId;
        console.log("Event data: " + JSON.stringify(event.data));
        console.log("Data passed: " + JSON.stringify(mappedHostData[id]));
        var iframeElement = document.getElementsByName("aari-embedded-
app")[0];
        iframeElement.contentWindow.postMessage({data: mappedHostData[id]
        },
        iframeElement.getAttribute("src"));
      }
    });
  }, 100);
};

```

Map host data using bot inputs

In a host application, you can pass supported input variable data to your attended bots in the iFrame widget.

Ensure that you have completed the following:

- Provided a system-created **AAE\_Robotic\_Interface User** role for the AARI User.
- You have access to Automation Co-Pilot.
- You have already set up your host data in a web application that supports the iFrame technology, such as Salesforce or ServiceNow, see [Map data from HTML to form](#) on page 3317.
- You have created a bot that contains variables with an input type, and checked in. Therefore this bot is available for you to access in the iFrame widget.

---

**Note:** **String**, **Number**, **Boolean**, and **DateTime** variable types are supported to pass data to an attended bot. In addition, there are new IDs for **event.processId** and **event.botId**, where **pID** is for process and **botID** is for bots.

---

Sample of a bot with input variables:

This form uses the Set action from the Interactive Forms package to set input variable values in each form fields. See [Interactive forms package](#) on page 2738.

The screenshot displays the Automation Anywhere interface for a flow named "Account\_Details\_Validation". The interface is divided into a left sidebar with a "Variables" section and an "Actions" section, and a main workspace showing the flow steps. The "Actions" section on the left includes a search bar and a list of categories such as Active Directory, Analyze, Apigee, App integration, Application, Boolean, Bot Migration, Browser, Clipboard, Comment, Credential, CSV/TXT, Data Table, Database, Datetime, Delay, Dictionary, DLL, Document Extraction, Email, Error handler, Excel advanced, Excel basic, File, Folder, Ftp/Sftp, Generative AI, Genesys, Google Calendar, and Google Document AI. The main workspace shows a sequence of 21 steps:

1. Interactive forms: Display \$account\_info\$
2. Interactive forms: Set value to \$account\_name\$ for TextBox0 in \$account\_info\$
3. Interactive forms: Set value to \$type\$ for TextBox1 in \$account\_info\$
4. Interactive forms: Set value to \$industry\$ for TextBox2 in \$account\_info\$
5. Interactive forms: Set value to \$employee\$ for Number0 in \$account\_info\$
6. Interactive forms: Set value to \$phone\$ for Number1 in \$account\_info\$
7. Interactive forms: Set value to \$account\_number\$ for Number2 in \$account\_info\$
8. Interactive forms: Set value to \$created\_at\$ for Time0 in \$account\_info\$
9. Interactive forms: Set value to \$sla\_exp\_date\$ for Date0 in \$account\_info\$
10. Interactive forms: Set value to \$billing\_address\$ for TextArea0 in \$account\_info\$
11. Interactive forms: Set value to \$sic\_code\$ for Password0 in \$account\_info\$
12. Interactive forms: Set value to \$created\_date\$ for Date1 in \$account\_info\$
13. Boolean: To string \$boolVar\$ and assign result to a \$boolean\_var\_String\$
14. Interactive forms: Set value to \$boolean\_var\_String\$ for TextBox3 in \$account\_info\$
15. If boolean \$boolVar\$ Equals to(=) True
19. Message box: 'Validate data on form Boolean value: \$boolean\_var\_String\$'
20. # Number: Assign 0 to \$tableRowIndex\$
21. Trigger loop
  22. Trigger loop: Handle when Button0 in \$account\_info\$ is Clicked
  34. Trigger loop: Handle when Button1 in \$account\_info\$ is Clicked
  44. Trigger loop: Handle when Button2 in \$account\_info\$ is Clicked
  51. Trigger loop: Handle when Button3 in \$account\_info\$ is Clicked

1. Log in to Salesforce (host application).
2. Configure your code in the Salesforce console.  
This code can be found in the code controller option.

```

Copilot Copilot.cmp CopilotController.js
22     Date1: component.get("v.accountRecord")["CreatedDate"],
23     TextArea0: component.get("v.accountRecord")["BillingStreet"],
24     Password0: component.get("v.accountRecord")["Sic"]
25   },
26   102 : {
27     account_name: component.get("v.accountRecord")["Name"],
28     type: component.get("v.accountRecord")["Type"],
29     industry: component.get("v.accountRecord")["Industry"],
30     employee: component.get("v.accountRecord")["NumberOfEmployees"],
31     phone: component.get("v.accountRecord")["Phone"],
32     account_number: component.get("v.accountRecord")["AccountNumber"],
33     Created_at: component.get("v.accountRecord")["CreatedDate"],
34     created_date: component.get("v.accountRecord")["CreatedDate"],
35     billing_address: component.get("v.accountRecord")["BillingStreet"],
36     boolVar: component.get("v.accountRecord")["Active__c"] == 'Yes',
37     sic_code: component.get("v.accountRecord")["Sic"]
38   },
39   101 : {
40     var1: component.get("v.accountRecord")["Name"],
41     var2: component.get("v.accountRecord")["Name"],
42     var3: component.get("v.accountRecord")["Name"],
43     var4: component.get("v.accountRecord")["Name"],
44     var5: component.get("v.accountRecord")["Name"],

```

Sample of a full code that includes host data:

```

({
  handleRecordChanged : function(component, event, helper) {
    console.log("Hi from controller");
    if(event.getParams().changeType === 'LOADED') {
      const userLang = $A.get('$Locale.language');
      console.log('User language setting: ' + userLang);
      console.log("Account record: " + JSON.stringify(component.get("v.accountRecord")));
    } else {
      console.log('Not loaded')
    }

    const mappedHostData = {
      102 : {
        account_name: component.get("v.accountRecord")["Name"],
        type: component.get("v.accountRecord")["Type"],
        industry: component.get("v.accountRecord")["Industry"],
        employee: component.get("v.accountRecord")["NumberOfEmployees"],
        phone: component.get("v.accountRecord")["Phone"],
        account_number: component.get("v.accountRecord")["AccountNumber"],
        Created_at: component.get("v.accountRecord")["CreatedDate"],
        created_date: component.get("v.accountRecord")["CreatedDate"],
        billing_address: component.get("v.accountRecord")["BillingStreet"],
        boolVar: component.get("v.accountRecord")["Active__c"] == 'Yes',
        sic_code: component.get("v.accountRecord")["Sic"]
      },
    };
    console.log("Data" + JSON.stringify(mappedHostData));
    console.log(event)
    setTimeout(function() {
      window.addEventListener('message', function(event) {
        if(event.data.aariDataRequest === 'aari-data-request') {
          const id = event.data.processId || event.data.botId;
          console.log("Event data: " + JSON.stringify(event.data));
          console.log("Data passed: " + JSON.stringify(mappedHostData[id]));
          const iframeElement = component.find("aari-embedded-app").getElement();
          iframeElement.contentWindow.postMessage({data: mappedHostData[id]}, iframeElement.getAttribute("src"));
        }
      });
    }, 100);
  }
})

```

**Note:** This code shows an number (ex: **102**) that matches with the **Bot ID** from the Control Room. You can view the Bot ID when you access your public bots in the **public repository**. The ID will be shown in the URL similar to the following:

<https://.../bots/repository/public/taskbots/102/view>

3. View the bot in the embedded widget.

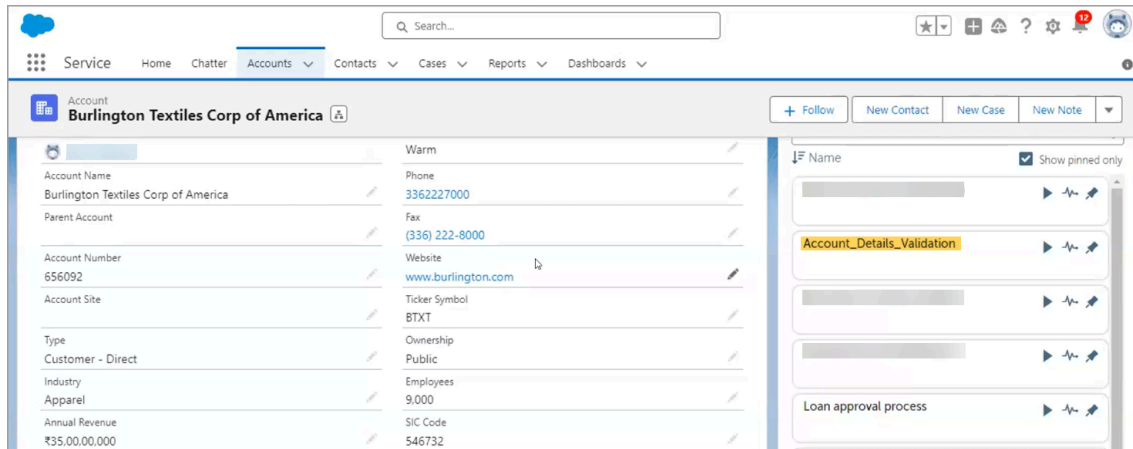

In this case, **Account\_Details\_Validation** bot is available for you to select.

4. Deploy your bot.

The bot will begin the automation process.

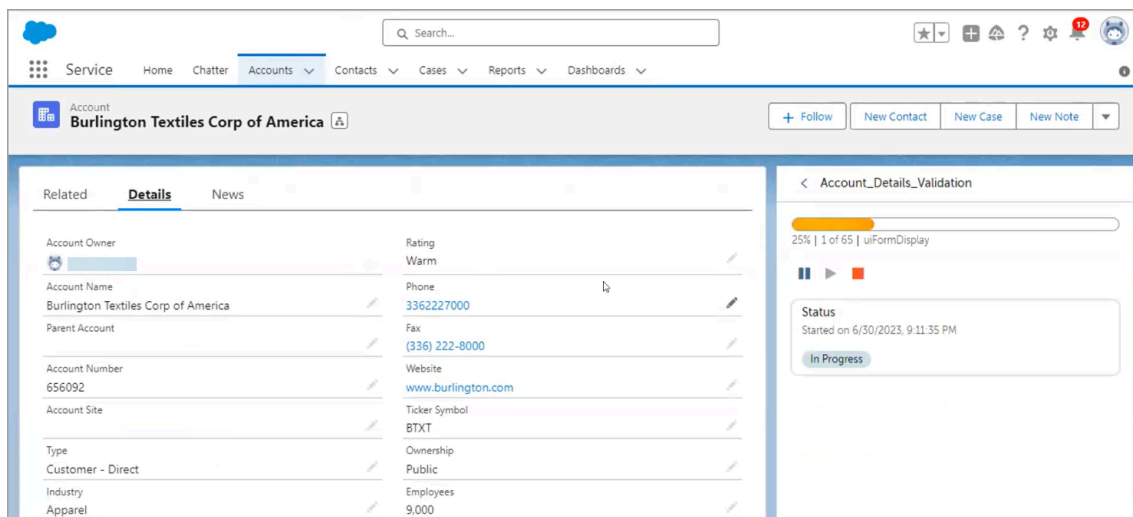

Simultaneously, the data fields in the form will populate based on the input variables.

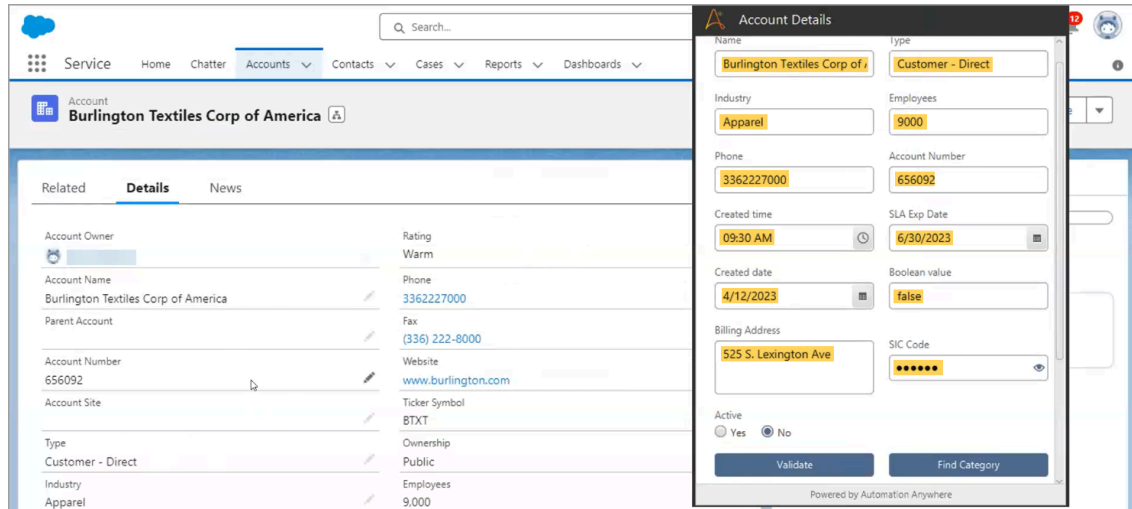

5. Close the automation session.  
You have successfully ran a bot with input variables.

## Automation Co-Pilot using Chrome extension

Use Automation Co-Pilot using Chrome extension to embed an interface for the Automation Anywhere platform in your Google Chrome browser.

### Benefits and capabilities of Automation Co-Pilot (extensions)

Broader access to automations brought to your familiar environment

With Automation Co-Pilot using Chrome extension, you can develop custom actions and workflows. The OAuth 2.0 connection offers a seamless connection from the Automation Anywhere Control Room to your web browser. This connection extends automated features into your preferred environment through embedded web components. Develop these components in any web scenario through the use of Automation Co-Pilot using Chrome extension. Users with these components can launch automated processes and bots directly from existing environments, where most time is spent. With this access, business data can be retrieved and processed without ever changing applications.

Secure connection with admin control for organizing team and user workloads

Automation Co-Pilot using Chrome extension is fully integrated with Automation Anywhere for security and authorization of content. This means that the administrator has complete control over which content is made public through Automation Co-Pilot by assigning Automation Co-Pilot using Chrome extension

content to teams. Content assigned to a team will become visible to the members of the team when the target pages are opened. With this control and organization, administrators can develop specialized components for specific team functions by empowering users with streamlined automation.

Requisites:

- OAuth 2.0 Automation Workspace configuration: using secure credentials, configure a security token to validate your identity as a licensed user. Servers will recognize this token and approve your access, eliminating the need to log in multiple times to your accounts. [Use AuthConfig App to enable OAuth2 services](#) on page 1846
- Automation 360 v.26 or later
- Google Chrome browser
- Automation Co-Pilot licenses: Automation Co-Pilot using Chrome extension uses teams and members to securely authorize and deploy content to the right users.
- Automation Co-Pilot fluency: administrators should be familiar with the environment in order to identify key elements used to map custom content to teams.

Additional considerations:

- Roles: Ensure that you have the proper role and permissions for your activity. [Users and team roles for Automation Co-Pilot](#) on page 3408
- Ensure that your browser is not blocking Automation Co-Pilot using Chrome extension access and windows.

## Process flow

The end-to-end workflow is illustrated in the following diagram.

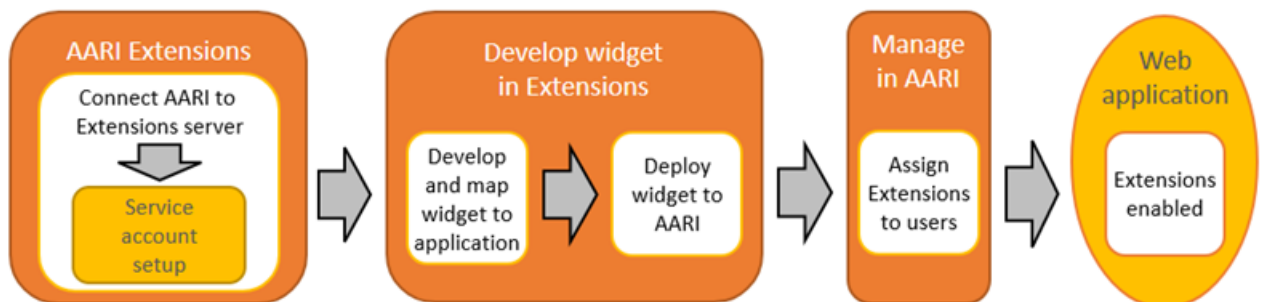

1. To begin accessing features, set up and connect your Control Room to Automation Co-Pilot using Chrome extension. [Set up and connect Automation Co-Pilot using Chrome extension](#) on page 3328
2. Develop and embed content in your preferred application for Automation Co-Pilot using Chrome extension. [Develop a widget for Automation Co-Pilot using Chrome extension](#) on page 3332
3. Administer your developed content to teams for users to access through Automation Co-Pilot using Chrome extension. [Provisioning Automation Co-Pilot using Chrome extension to users](#) on page 3339

4. Get started using the embedded content through Automation Co-Pilot using Chrome extension. [Deploy automations in web application](#) on page 3310

### Set up and connect Automation Co-Pilot using Chrome extension

Set up and connect to Automation Co-Pilot using Chrome extension.

- Ensure that you meet all the prerequisites. [Automation Co-Pilot using Chrome extension](#) on page 3326
- Have your Service Account Token accessible to enter in setup. [Create a service account for Automation Co-Pilot using Chrome extension](#) on page 3330

**Note:** This token is an API key generated in the Control Room, from **Settings**.

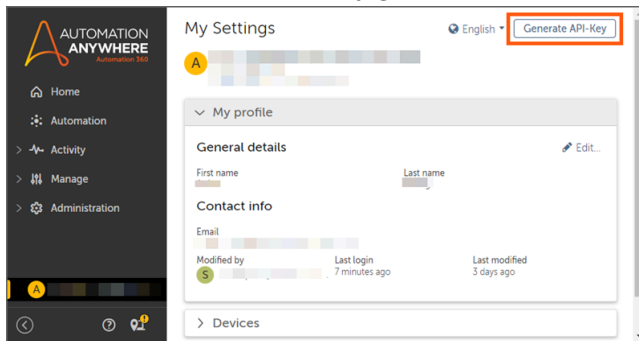

Automation Co-Pilot using Chrome extension requires setup and connection of your system. Perform the following steps to complete the setup illustrated in the following diagram.

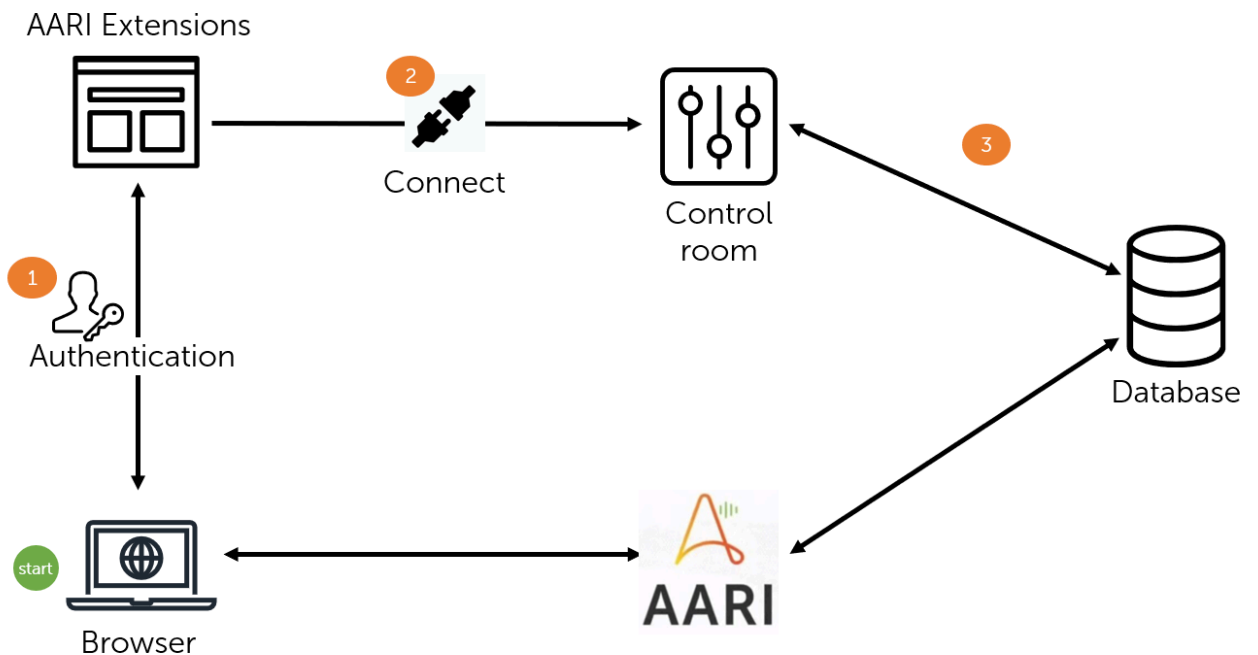

The following video shows the setup process.

1. To open the extensions setup in a new tab with context about the AAI tenant click **Connect Accounts**.



**Note:** Your Control Room URL and Partner ID will be automatically filled as part of the setup.

2. Select your Google or Microsoft account to begin the process of deploying and connecting Automation Co-Pilot using Chrome extension to your Control Room.
3. Enter a **Name** for the new Automation Co-Pilot using Chrome extension Tenant that will be connected to your Control Room, for example, Production.
4. In the Control Room settings:
  - a) Enter the Username of the Service Account that you created previously.
  - b) Enter the **Service Account API Key** to use for server-to-server communication.
5. Select **Connect**.  
You are now connected to Automation Co-Pilot using Chrome extension, and you can assign developed content.

[Develop a widget for Automation Co-Pilot using Chrome extension](#) on page 3332

Firewall configuration and trusted URLs for Chrome extension

Ensure your network firewall configuration allows the sites and services required for the HTTPS network connections of the Automation Co-Pilot Chrome extension.

## Automation Co-Pilot URLs list

Because Automation Co-Pilot service hosting uses dynamic IP addresses, we recommend you add the following complete URL instead of an IP address for PixieBrix services to your safe recipients or trusted sites list. In order for PixieBrix to function properly, the following origins must be allowlisted.

**Note:** We recommend Administrators review the timeout settings and select a larger value than the current maximum of 60 minutes for a session timeout under: **Control Room > Administration > Settings > Security > Time-out Session Settings**. Up to a 24 hour maximum should be considered as this 24 hour setting aligns with many modern applications including Salesforce.

**Important:** During setup of the Automation Co-Pilot Chrome extension, ensure you have added the AuthConfig app URL to the allowed list - outbound from the Control Room (https/SSL port).  
[Authentication App](#) | [Automation Anywhere](#)

Service	Description	URL	Communication
Outbound from browser			
Host	Required for all users.	https://*.pixiebrix.com	Outbound
PixieBrix package registry	Required for all users.	https://app.pixiebrix.com	Outbound
Documentation portal	Recommended for Mod developers and admins.	https://docs.pixiebrix.com	Outbound

Service	Description	URL	Communication
Website and templates	Recommended for Mod developers.	<a href="https://www.pixiebrix.com">https://www.pixiebrix.com</a>	Outbound
Error telemetry endpoint	Required for all users.	<a href="https://api.rollbar.com">https://api.rollbar.com</a>	Outbound
Inbound to Automation Anywhere Control Room through the SSL Port			
Load-balanced pair of IP addresses so if one fails, traffic automatically routes through the second IP with health checks and automated failover.	Recommended for all users.	<ul style="list-style-type: none"> <li><a href="https://54.205.35.75:9294">54.205.35.75:9294</a></li> <li><a href="https://3.222.129.4:9294">3.222.129.4:9294</a></li> </ul>	Inbound
Incoming Email Domain	Recommended for all users.	<a href="https://pixiebrix.com">pixiebrix.com</a>	Inbound
Incoming System Email IP Address	System emails are sent from the following IP address (updated July 1, 2023).	149.72.154.34	Inbound

**Note:** The default https/SSL port is typically 443, but can be customized based on your organization's firewall settings.

Further details regarding set up of the Automation Co-Pilot Chrome extension can be found in partner documentation with PixieBrix. [AARI Extensions Enterprise IT Setup Guide](#)

For details regarding Automation Anywhere network and firewall protocols, see [Ports, protocols, and firewall requirements](#).

Create a service account for Automation Co-Pilot using Chrome extension  
Create the service account and assign permissions to customize the Automation Co-Pilot using Chrome extension experience in your embedded widget.

Use your AARI Admin account (AAE\_Robotic Interface Admin) to create a new user with the proper role and permissions to configure the Automation Co-Pilot using Chrome extension experience.

Overview

1. **Role:** Create a new role, with specific permission, to operate in Automation Co-Pilot as the service account. The permission you assign will structure the Automation Co-Pilot using Chrome extension experience.
2. **User:** After you set up the role, create a new user and assign the role to administer permissions.
3. **Key:** Generate the API-Key of the user account that Automation Co-Pilot using Chrome extension will identify as the service account. During setup of Automation Co-Pilot using Chrome extension, enter the API-Key.
4. **Connect:** Name the account to complete the Automation Co-Pilot using Chrome extension connection.

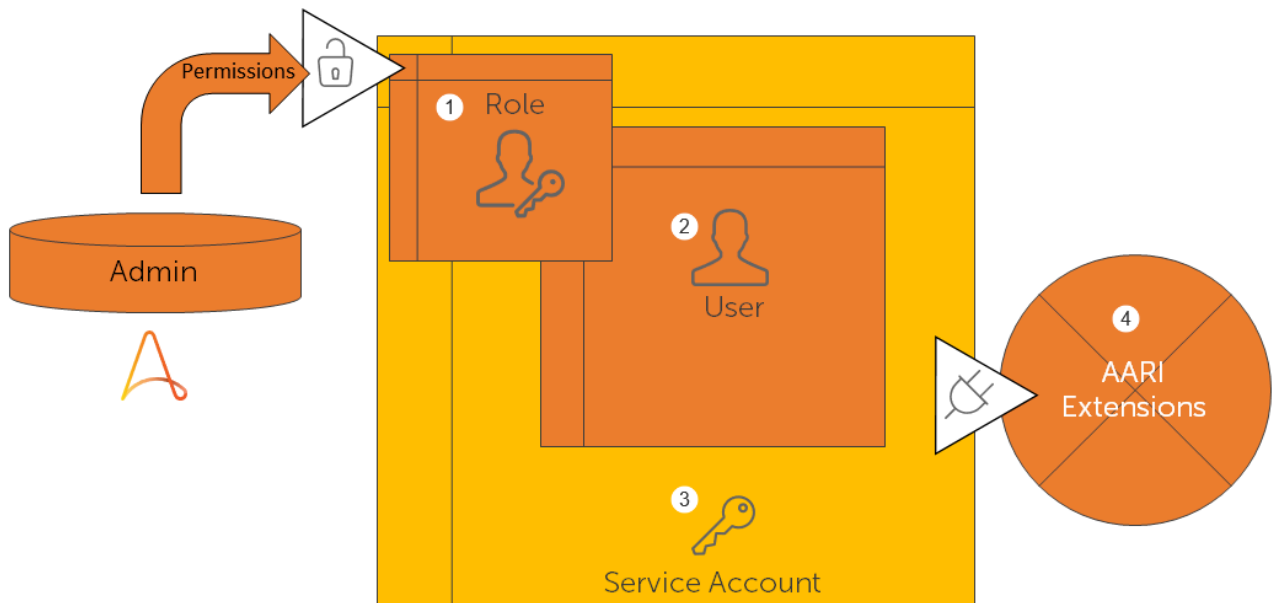

To grant permissions to the role:

1. Log in to your Control Room as an Admin user.
2. Navigate to **Administration** > **Roles** in the left-hand menu.
3. Click **Create Role** at the top right of the page.
4. Enter the name for your new role and select the following permissions on the Features page. These permissions enable the Automation Co-Pilot using Chrome extension server to query information to verify user access and save meta data to Automation Co-Pilot.
  - View users
  - View roles
  - View users and roles basic information
  - View licenses
  - Generate API-Key
  - Extension API for service account
5. **Save** your new role.

To create a new user for your service account and assign the role:

6. Navigate to **Administration** > **Users** in the left-hand menu.

7. Click **Create User** located at the top right toolbar to define a new service account user.
8. Enter information in the required fields and select the role you previously created and assign it to this user.
9. Select **Allow** for Allow Multiple Sessions on the user creation page.
10. Click **Save**.

To generate the API key:

11. Log in to the Control Room with the user you previously created.
12. Click your user name in the left-hand menu and then click **My Settings** in the profile card that displays.
13. Select **Generate API key** at the top right of the My Settings page.

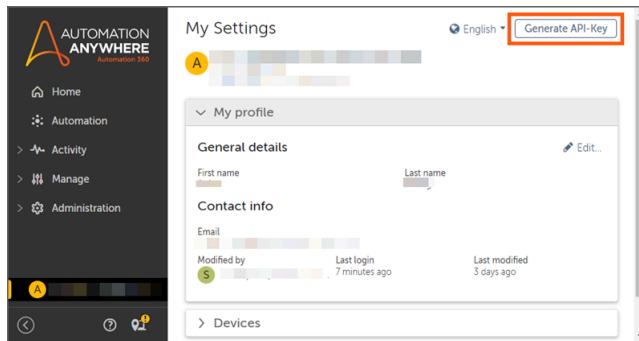

14. Save the API key to use when connecting Automation Co-Pilot using Chrome extension.

[Set up and connect Automation Co-Pilot using Chrome extension](#) on page 3328

## Develop a widget for Automation Co-Pilot using Chrome extension

Develop the iFrame widget in Automation Co-Pilot using Chrome extension to deploy in your web application.

- You must be logged in to the Control Room with **AAE\_Basic** permissions.
- Ensure that Automation Co-Pilot using Chrome extension is installed in your browser by completing setup. [Set up and connect Automation Co-Pilot using Chrome extension](#) on page 3328
- Set up the widget in Automation Co-Pilot that will map automations into Automation Co-Pilot using Chrome extension. [Setup iFrame widget using Automation Co-Pilot](#) on page 3303
- Have the widget **embed code** accessible to enter into Automation Co-Pilot using Chrome extension. You need only the URL in quotes after `src=`.

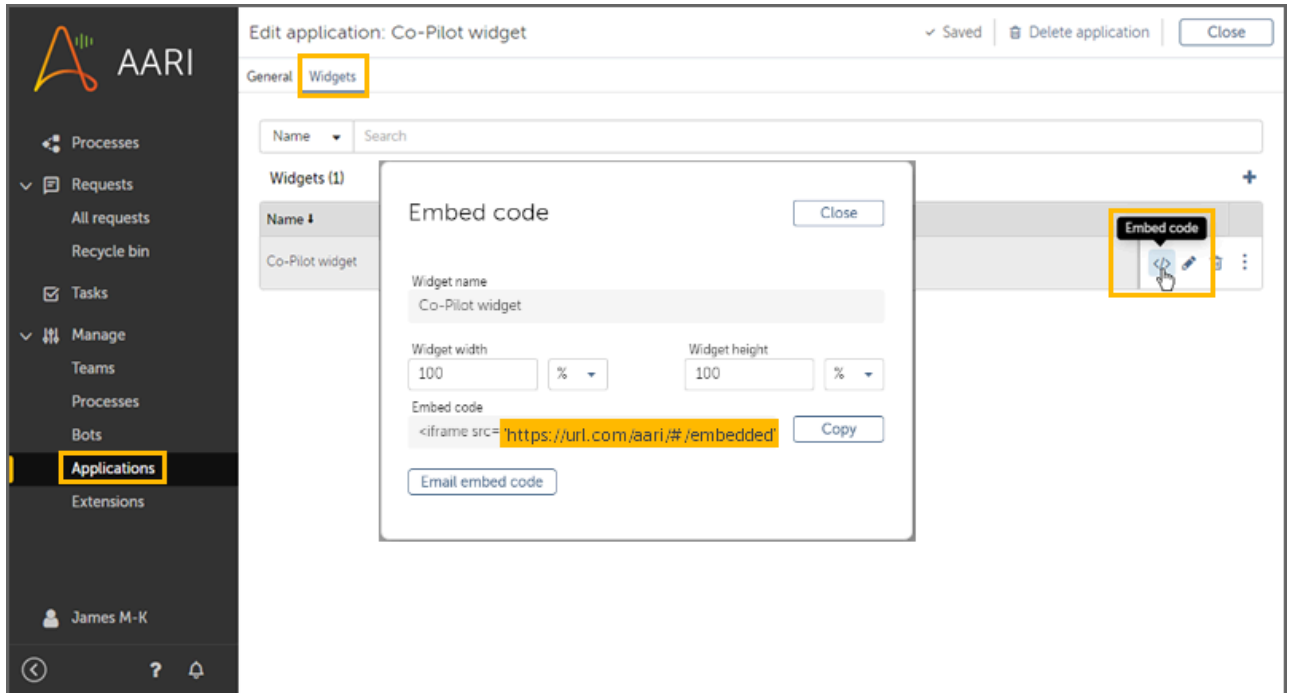

With Automation Co-Pilot using Chrome extension, your Chrome browser will act as the vessel to embed the widget. Using the following steps, develop an iFrame widget for your web application and deploy the widget to Automation Co-Pilot to map your complete embedded automation experience. While you can develop many web components, the following steps streamline a simple process to bring automations directly into your web application.

The PixieBrix Page Editor environment is used to map and configure automations from Automation Co-Pilot to your web application and select the component for embedding the widget. This environment uses your OAuth connection to access saved processes and automations from your Control Room and map them to the selected component. For complete details on developing in the Editor, see the following link: [Guide to PixieBrix Page Editor](#)

The following video demonstrates the process of developing the widget in Automation Co-Pilot using Chrome extension.

1. To begin, navigate to the web application where the iFrame widget will be embedded.
2. Select the **Render Panel** action and delete it by clicking the trash icon on the top of the pane.
3. To open the page editor, from the desired web application, right-click and select **Inspect**.

The following table and image details the development environment.

	Panel	Description
1	Extensions List	Create and select an extension for development.
2	Extension Overview	Add, view, and edit the components of the extension.
3	Configurations panel	Map and configure how components interact with the web page.
4	Data panel	Test and debug your extension.

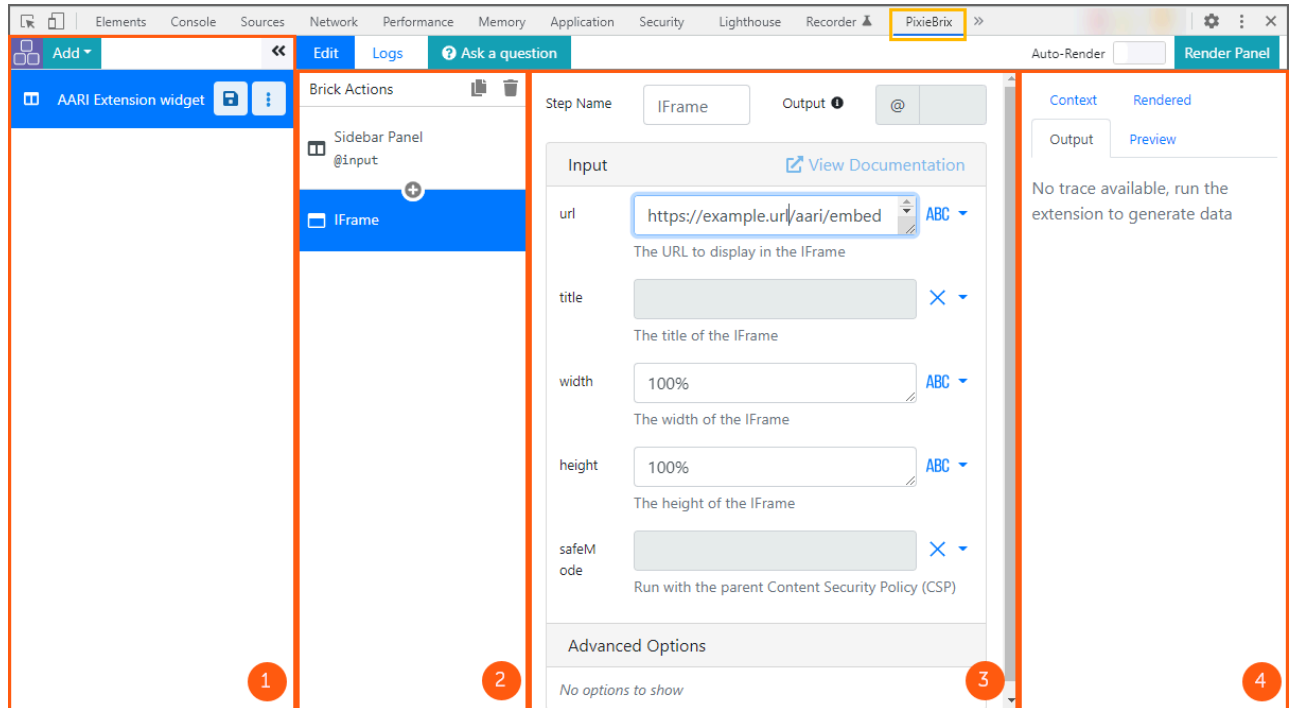

4. From Extensions List, click **Add** and select **Sidebar panel**.
5. From the Overview panel, click the **plus icon** to open the component menu.
6. Select the **iFrame** component and click **Add brick**.
7. In the Configuration panel, complete the necessary fields.
  - a) Enter the **Name** of the widget. This name will appear in Automation Co-Pilot when you begin provisioning to users.
  - b) Enter the widget **URL** to access your Control Room.

This is the URL taken from the **embed code** found in Automation Co-Pilot using embedded widget. You need only the URL in quotes after `src=`.

8. **Save** your Extension.
9. Test and debug your extension by using the data panel.

The final output is detailed in the data panel and alerts you to any action that might be mapped or configured incorrectly.

---

**Important:** If an alert for invalid connection or invalid credential appears, check that you have set up and connected Automation Co-Pilot correctly to Automation Co-Pilot using Chrome extension.

---

10. After successful verification, click the vertical ellipses in the Extensions List panel to add your extension to a blueprint.

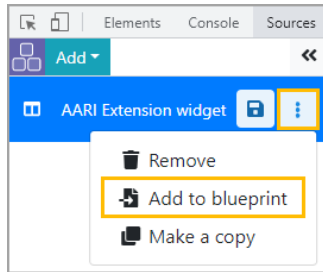

11. Select **create new blueprint**.
12. Select **move** or **copy** into the new blueprint.
13. Enter your **unique id**.
14. Enter the **name** to identify the extension in the next step.
15. Enter the **version** for developers to identify the progressive customizations made over the life of the extension.
16. Enter a **description**.
17. Click **Create** to save your changes.

After developing the extensions for your team, deploy the blueprint to Automation Co-Pilot using Chrome extension. [Deploy an extension version to Automation Co-Pilot using Chrome extension on page 3335](#)

## Deploy an extension version to Automation Co-Pilot using Chrome extension

Select and deploy the version of a verified extension for Teams to access in Automation Co-Pilot using Chrome extension.

Select and deploy an extension version (called a mod) for teams to access in Automation Co-Pilot using Chrome extension. Mods package all customizations and return them to the web application as a single version. This provides developers access to make improvements on one version while users simultaneously run a verified version.

Use the management console in the Automation Co-Pilot using Chrome extension to deploy a mod and control the version of developed artifacts.

Automation Co-Pilot using Chrome extension offers a management console for development artifacts to provide version control. Select the version of an extension by choosing a mod from the console. Mods package all customizations and return them to the web application as a single version. This allows developers access to make improvements, while users run a verified version.

This task describes how to deploy a mod from the Automation Co-Pilot using Chrome extension management console to populate your widget and make it accessible.

### Prerequisites

- Use a Google Chrome browser with a profile setup with Automation Co-Pilot using Chrome extension.
- Ensure you have access to two Automation Co-Pilot users, one with the Automation Co-Pilot admin profile for set up and one with the Automation Co-Pilot user profile for testing.

1. You can either:
  - Open a new browser window on your machine and log in to Automation Co-Pilot using Chrome extension as an AARI Admin; or

- Open a new browser window on a different machine to easier manage active sessions.

**Tip:** Use Chrome Profiles to manage multiple user profiles on the same machine. For each user profile created, the user must log into Automation Co-Pilot and install the Chrome extension into that Chrome profile. Then, each user must log in to the Chrome extension using their respective Automation Co-Pilot credentials. This management method:

- Organizes profiles for Administrator, Developer, and end users for testing.
- Optimizes managing multiple sessions when tasks are completed on the same device.

To learn more about Chrome Profiles, see [Google Chrome help](#)

2. Open the Console page by selecting **Chrome > Extensions > PixieBrix**.

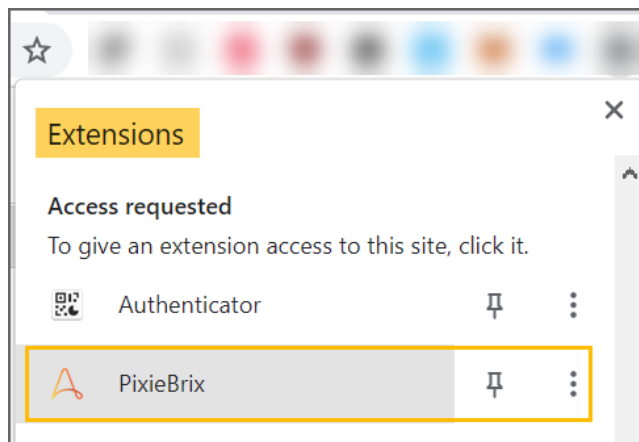

3. Click the **Options** button in the slide out panel that appears.

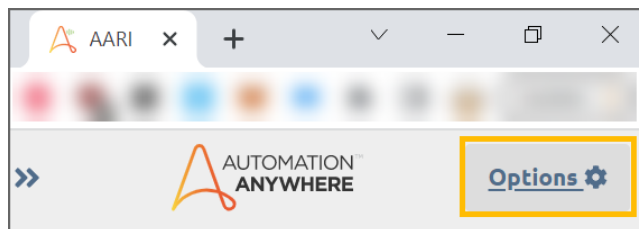

4. If prompted to log in enter your Control Room URL and log in using the AARI Admin account.

**Note:** To switch to a different user in the existing session, click **Open Admin Console** at the top right of the page. In the new tab, click the **username** and select **Logout**.

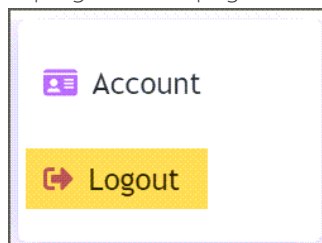

5. When logged in as the AARI Admin, click **Open Admin Console** at the top right of the page.
6. Select **Deployments** from the left navigation menu.



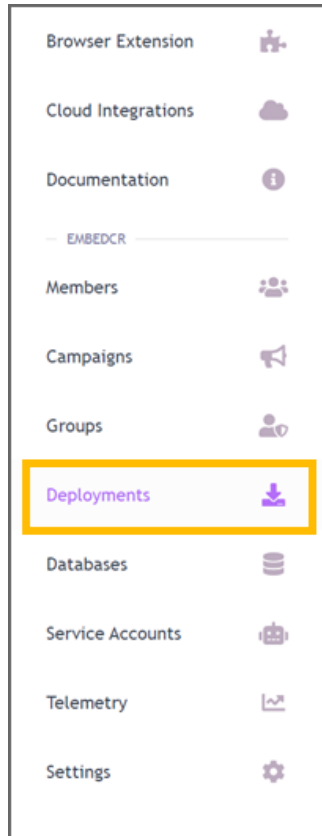

7. Click **+ Create Deployment** at the top right of the Deployments page.
8. Enter the name of your deployment.
9. Select the mod of the extension you previously created using the Develop an widget for Automation Co-Pilot using Chrome extension procedure. [Develop a widget for Automation Co-Pilot using Chrome extension](#) on page 3332

A 'Create Deployment' dialog box. It has a 'Name' input field. The 'Blueprint' dropdown is set to 'embed'. A list of 'Blueprint Version' options is shown, with '@embedcr/demo\_workday\_sidebar - 1.0.0' selected and highlighted with a yellow border. Below the list, there are 'Integration' and 'Blueprint has n' sections. At the bottom, there are 'Cancel' and 'Create Deployment' buttons, with the latter highlighted with a yellow border.

10. Click **Create Deployment** to save your settings to Automation Co-Pilot.

11. In a new tab or window, navigate to Automation Co-Pilot and log in as an AARI Admin.
12. Open the Extensions page by selecting **Manage > Extensions** from the left-hand navigation menu.
13. Click **+ Add Extension** on the top right of the page.



Your newly deployed extension displays in the table.

14. Select the check box next to your deployed extension and then click **Add & Save**.

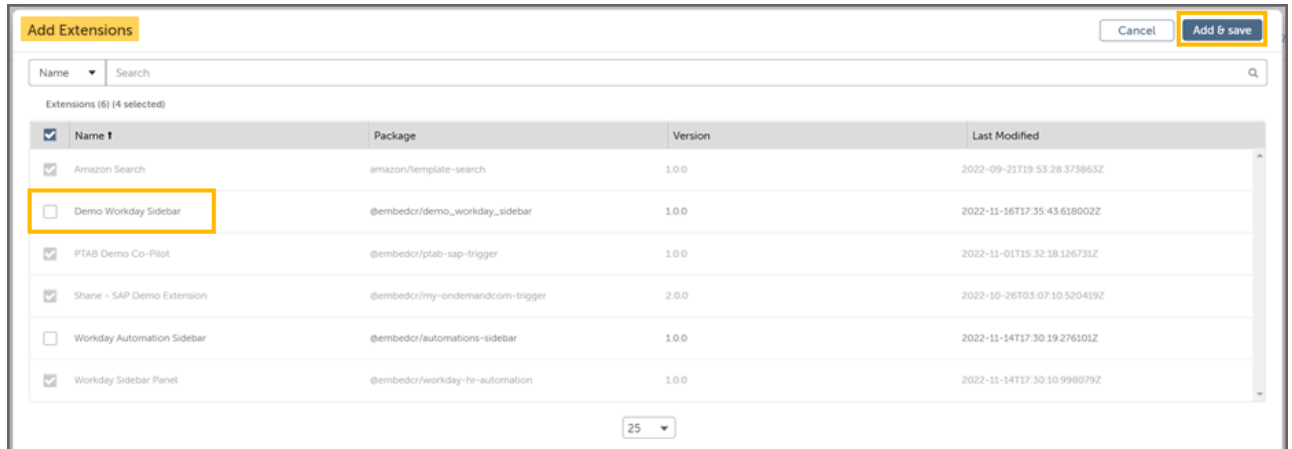

You return to the Extension Setup page.

15. From the Extension Setup page, select the deployment you added. Automation Co-Pilot navigates to the Properties page.
16. To assign one or more teams, select the **Teams** tab at the top of the page.
17. Click the **+** button on the bottom right to open the Teams dialog.

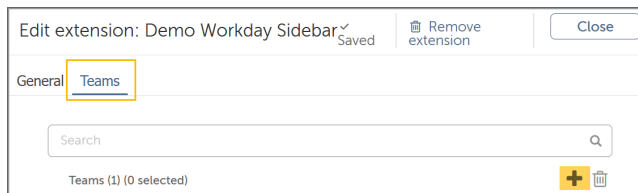

18. Select the Teams for which to assign the extension.



19. Click **Add & Save** to activate and deploy teams customization.

Test the customization.

**Note:** If using Chrome Profiles, switch to a user profile dedicated to an AARI User profile that belongs to this respective Team. Otherwise, follow the steps to log the user out of the Chrome

extension and then log in with a user that already has an AARI user license assigned and has been added to this respective Team.

---

As the user, navigate to your configured application, (similar to how Workday was configured in the previous task). After you access the page configured on the Trigger, the Sidebar panel should automatically display with the list of available automations for the user.

## Provisioning Automation Co-Pilot using Chrome extension to users

Organize and assign developed extensions to users for business roles and functions.

Ensure that you have completed development of the Automation Co-Pilot using Chrome extension content. [Develop a widget for Automation Co-Pilot using Chrome extension](#) on page 3332

After developing an extension, make sure to **refresh** Automation Co-Pilot to load recently developed content.

1. In Automation Co-Pilot using Chrome extension, click **Add Extension**.
2. Select the extension.  
Recognize the extension by the **Name** you entered in development.
3. Click **Add and Save**
4. To edit properties, select the newly added extension on the **Extension Setup** page .
5. Click the **Teams** tab.
6. Select **Teams** to assign them the extension.
7. To commit your changes, click **Add and Save**.  
The ellipsis on the far right of each team offers an option to send the extension link to users.  
Users will now be able to access the widget from their web applications.

Check out what users can do with the extension. [Deploy automations in web application](#) on page 3310

## Use Automation Co-Pilot as embedded widget in Genesys

Invoke Automation Co-Pilot as an interaction widget inside Genesys Cloud. The agent uses the widget to correct a pricing error without leaving Genesys.

Automation Co-Pilot

Business users can directly access authorized automation from within their favorite business applications, without having to open a new interface or learn a new app. Automation Co-Pilot delivers automation everywhere you want, through a widget, either integrated with your web application or delivered through a browser extension. To make the widget accessible, create and configure the widget in your preferred application. Then populate the widget by assigning pre-built automation to teams or roles in Automation Co-Pilot. Assigned users can access Automation Co-Pilot to complete daily tasks.

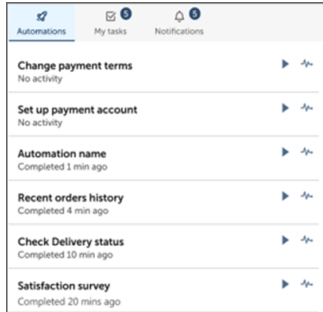

### Setup

1. Complete the setup process flow [Automation Co-Pilot using embedded widget overview](#) on page 3301
2. Assign automation [Assign automations to teams](#) on page 3305
3. Automation assigned should include the following.
  - Attended bot (that can be deployed on the local device) [Attended and unattended automation](#) on page 3291
  - Automation Co-Pilot Process invocation (with two human step forms) [Deploy processes](#) on page 3375
  - Unattended bot (triggered via Automation Co-Pilot process with no human inputs) [Create a process automation in Process Composer](#) on page 3454

**Tip:** Usable sample code

You can download the following sample code to test this example in your own environment.  
[GitHub: Embedded Use Case 1](#)

### Example Summary

In this example, a contact center agent receives a call about an order with an incorrect charge. The agent, operating in Genesys, responds using the embedded widget by launching automated processes and bots, and handles the order correction without leaving Genesys. Deployed automation touch Salesforce and Zoho Sales Order Management to correct the error in respective systems. Assigned automation are detailed in the following image.

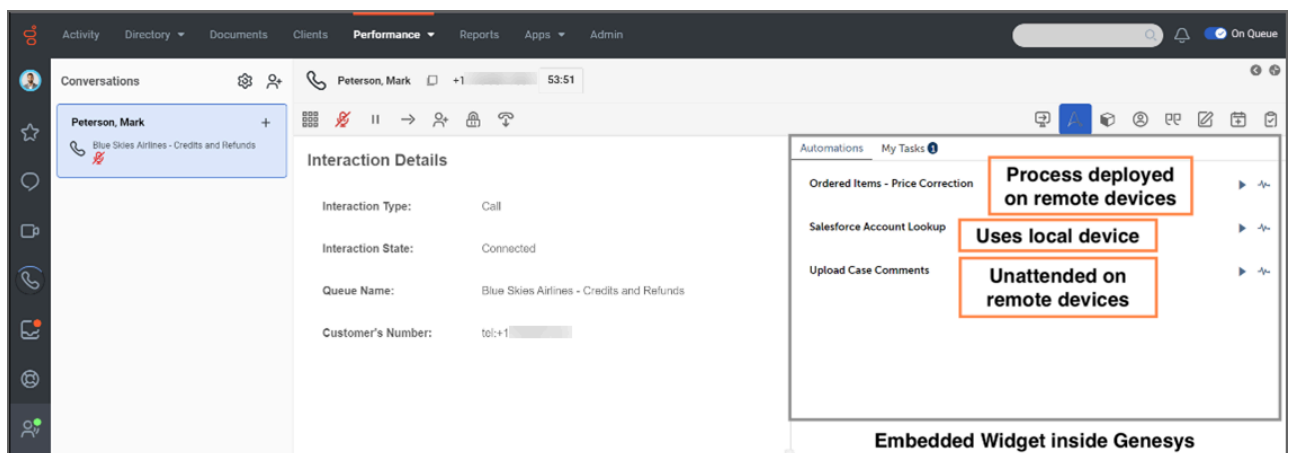

This example describes steps the agent takes to correct a pricing error while in Genesys, by using the Embedded Automation widget.

1. Deploy the **Salesforce Account Lookup** bot and enter the phone number to pull up the account record.

The screenshot displays the Genesys interface with a bot window open. The bot window shows the following details:

**Results**

Account Number: AC0065321

Name: Mark Peterson

Address: 633 River Oaks Parkway

City: San Jose State: 633 River Oaks Parkway

Country: USA Postal Code/ZIP: USA

Recent Order History

Date	SFDC Order Number	ZOHO Reference
2022-08-01	00000100	SO-00001

Close

Bot running... Salesforce Account Lookup 96% Active: Line 52 of 54 Action: TriggerLoop.commands.loop

Copy the **SFDC Order Number** to enter in the next step.

2. Launch the **Order Items Price Correction** process from within the widget and enter the order number you have retrieved.  
A Bot retrieves order details from Zoho and renders the **Display Order Details** in a form, including products and prices paid.

7-10 Order Number Input  
Display Order Details

Widget User 2

Order Date  
2022-08-02

Ship Date  
2022-08-03

Sales Rep  
Jill Brown

Sales Channel  
Direct Sales

**Shipping details:**

First Name  
Mark

Last Name  
Peterson

Address 1  
633 River Oaks Parkway

Address 2

City  
San Jose

State  
California

Country  
U.S.A

Phone  
555-985-4412

Email

Cancel Submit

Task Sequence

3. Correct the price on the item in question.

**Shipping details:**

First Name  
Sam

Last Name  
Roberts

Address 1  
541 5th Avenue

Address 2

City  
New York

State  
New York

Country

Phone  
555-321-0211

Email  
samroberts@ew.com

**Order details:**

SKU	Name	Quantity	Price	Discount
GC1060	GenWatt Diesel 1000kW	1.0	100000.00	0.0
IN7020	Installation: Portable	1.0	3500.00	0.0

Optional Additional Discount (Compensatory)  
 Apply 3% discount on order

Cancel Submit

Task Sequence

4. Optionally, select the 3% discount for courtesy.
5. Click **Submit**.  
The bot calculates the amount to be reimbursed.
6. The bot creates a billing update for refund in Zoho.
7. A reference number is generated, and the system indicates it will take 5-7 business days for refund to appear on card.

After the case is resolved, upload case notes from all cases handled through the day into a compliance application for audit.

	A	B
1	<b>Case Number</b>	<b>Comment</b>
2	00001002	Guided customer to refer to KB Aricle AB3434HH for directions on installation
3	00001016	Customer inquiring about maintenance guidelines, specifically what to maintain and at what interval. Guidance provided as per generator documentation.
4	00001024	Escalated issue to engineering as issue is mechanical and requires expert assistance from SME
5		

Enter the **file location**, for the automation to sends notes to the appropriate contacts.

## Use Automation Co-Pilot as Chrome extension in Workday

Automation Co-Pilot makes automation accessible for end users operating inside Workday. For example, a Human Resource admin enters an employee address and can order business assets to ship without leaving Workday.

Automation Co-Pilot

Business users can directly access authorized automation from within their favorite business applications without having to open a new interface, or learn a new app. You can invoke the widget in Workday. To make the widget accessible:

1. Create and configure the widget in your preferred application.
2. Assign any pre-built automation in Automation Co-Pilot required for teams to complete their daily tasks.

The widget (shown in the following image) populates assigned automation for specific roles.

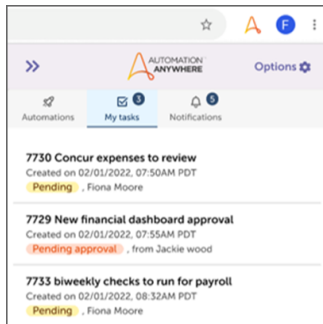

Setup

1. Complete the following setup process.
    - a) [Set up and connect Automation Co-Pilot using Chrome extension](#) on page 3328
    - b) [Setup iFrame widget using Automation Co-Pilot](#) on page 3303
    - c) [Develop a widget for Automation Co-Pilot using Chrome extension](#) on page 3332

---

**Note:** For this example, configure the widget to trigger as a Page Load event.

---

  - d) [Provisioning Automation Co-Pilot using Chrome extension to users](#) on page 3339
2. Two types of automation are assigned in this example and include the following details:
  - Attended bot (that you can deploy on the local device). See [Attended and unattended automation](#) on page 3291.
  - Automation Co-Pilot Process invocation (with two human step forms). See [Deploy processes](#) on page 3375

**Tip:** Sample code

You can download sample code to test this example in your own environment. See [GitHub: Embedded Use Case 2](#)

Example Summary

An HR Admin logs into the Workday application and views the new widget sidebar on the home page that has been deployed by the RPA Center of Excellence (CoE). The sidebar opens has been designed to open automatically when the user accesses the Workday application and the page has completed loading.

The HR Admin can use Embedded Automation to access and update an employee address, and then order hardware assets to deliver to that employee.



The deployed automations used in this example touch Workday and Zoho Sales Order Management (used to complete the transaction):

- An attended bot (**Employee Work Address Update**) built for an HR Admin to quickly locate and update home office address details of employees, using interactive forms and local desktop automation.
- An Automation Co-Pilot process invocation (**Device Order for Employee**) built for an HR Admin to order hardware assets (such as laptops and keyboards) for employees directly in Workday.

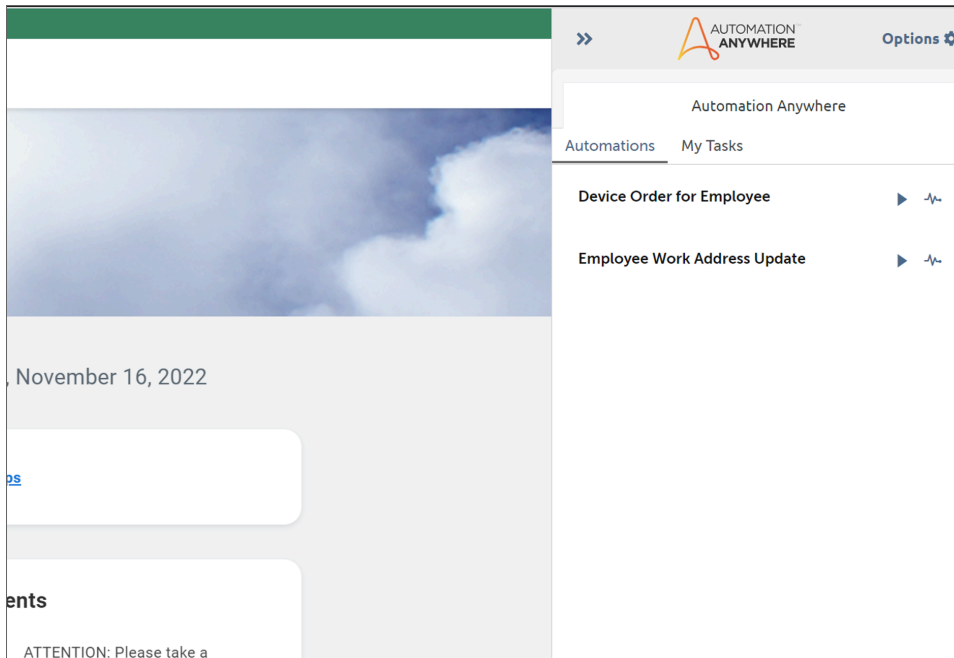

1. Start the **Employee Work Address Update** automation used to enter the Employee ID of the person you want to update.

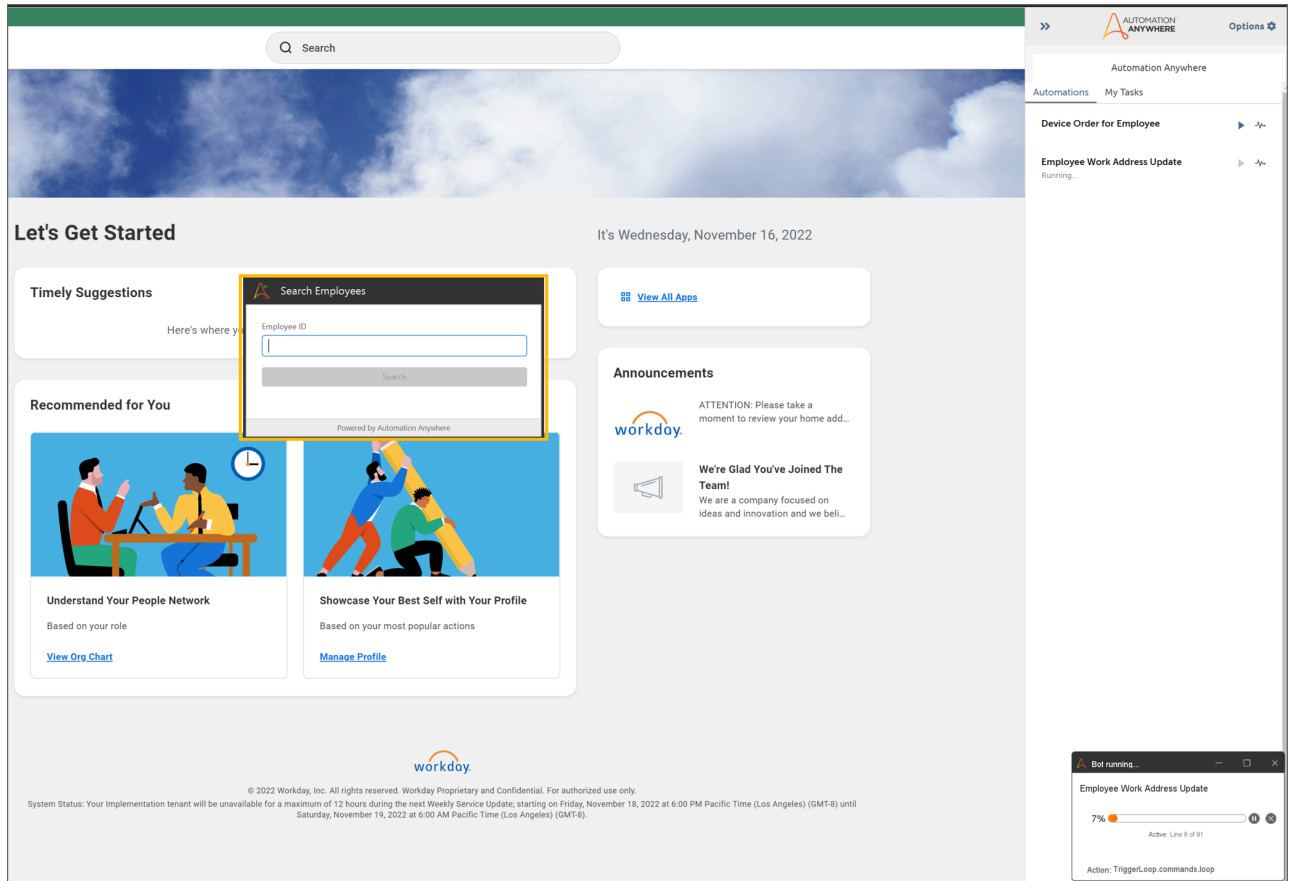

2. Enter the **Employee ID** to search Workday for the employee.

**Employee Details**

**Employee Data**

Employee ID: 21507      User ID: tstaff

**Person Data**

Position: System Administrator      Hire Date: 2020-03-11

First Name: Tim      Last Name: Staff

Email Address: timstaff@getnada.com

Address: 545 Tremont Street

City: Boston      State/Province: MA

ZIP: 02116      Country: USA

**Position Data**

Pay Type: Salaried

Management Level: 8\_Individual\_Contributor

Base Pay: 100000

Bonus Plan Amount: 0      Bonus Plan Percentage: 0

Total Compensation: 100000

Update Work Address

3. Enter the employee's address details using the provided form to update the employee data.

This example shows a simple address update. However, you can update other employee details based on the available APIs in your Workday instance, or by using the Automation Anywhere Universal Recorder.

#### 4. Click **Save Changes**.

The screenshot displays the 'Employee Details' form in Workday. The form is divided into several sections:

- Employee Data:** Employee ID (21507), User ID (tstaff).
- Person Data:** Position (System Administrator), Hire Date (2020-03-11), First Name (Tim), Last Name (Staff), Email Address (timstaff@getnada.com), Address (715 SW MORRISON ST), City (PORTLAND), State/Province (OR), ZIP (97205), Country (USA). A blue button labeled 'Update Work Address' is located below the address fields.
- Position Data:** Pay Type (Salaried), Management Level (8\_Individual\_Contributor), Base Pay (100000), Bonus Plan Amount (0), Bonus Plan Percentage (0), Total Compensation (100000). A blue button labeled 'Save Changes' is highlighted with a yellow border at the bottom of this section.

At the bottom of the form, there is a 'Cancel' button and a footer that reads 'Powered by Automation Anywhere'.

The automation updates the employee data in Workday.

The second automation (Device Order for Employee) simplifies daily tasks of the HR Admin. This adds an automated process for device ordering that is embedded directly in the Workday application using the same sidebar. Typically, this task would require navigating procurement applications to locate and order devices, and while navigating the Workday application to capture shipping address details of the employee.

By bringing the ordering process into the primary application where daily tasks are performed, the task is simplified. Similar to the previous task, when the HR admin logs into Workday, the sidebar appears with the list of available automations their CoE has deployed.

#### 5. Locate the **New Device Order for Employee** automation displayed in the sidebar and click **Start**.

A new instance is created.

#### 6. Enter the **Employee ID** for a new order.

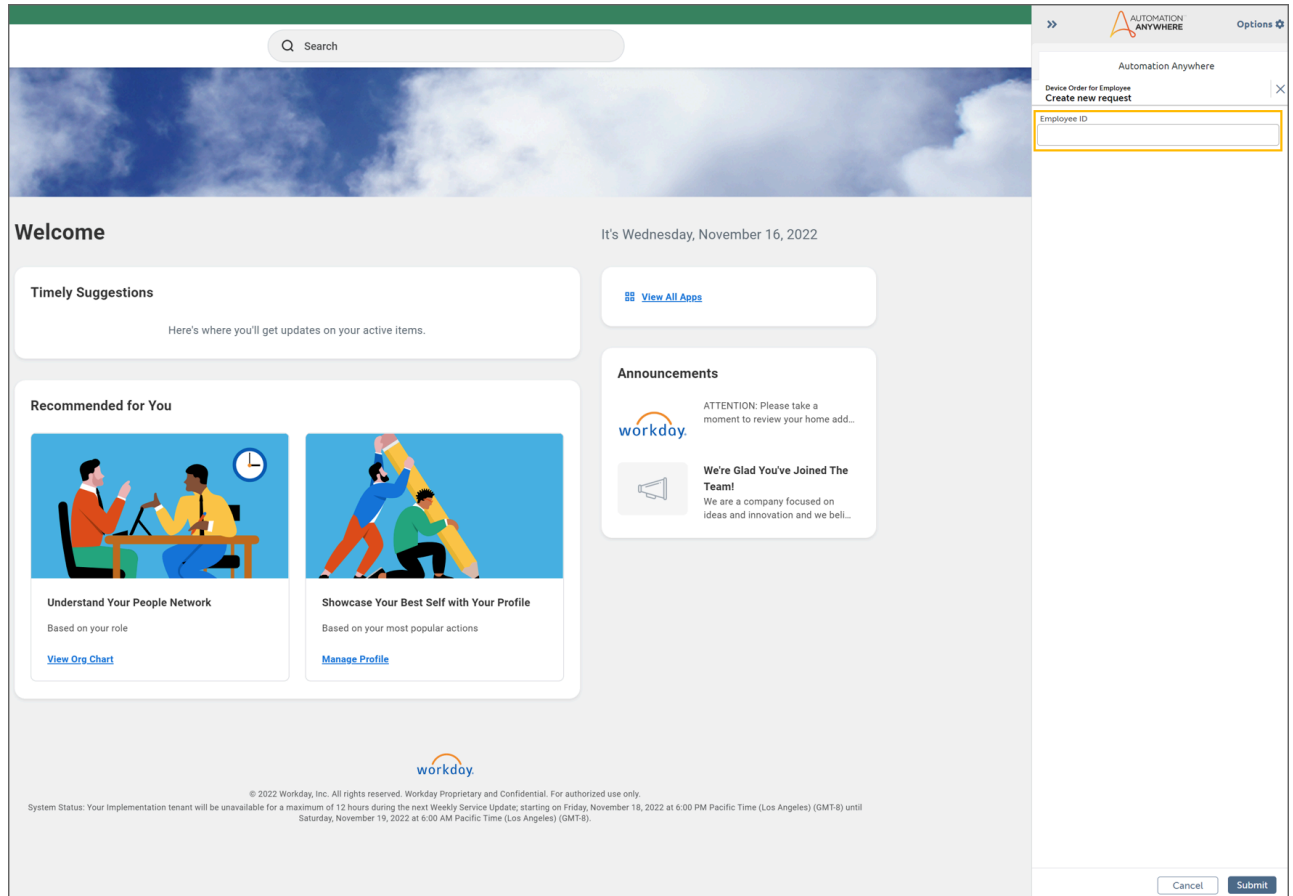

After submitting a valid Employee ID, the automation locates and returns the employee details within Workday.

7. Confirm the employee details and select the hardware items to order.

The screenshot displays the 'Automation Anywhere' interface for a 'Device Selection' task. At the top, the user is identified as 'Charlie Harrison'. Below this, the 'Employee Data' section contains two input fields: 'Employee ID' with the value '21507' and 'ZIP' with the value '97205'. The 'Available Assets to Order' section lists three items, each with a checkbox, a price field, and a quantity field:

- Jabra Evolve 65 UC Headset: Price \$199.99, Quantity 0
- Microsoft Ergonomic Desktop Keyboard: Price \$121.99, Quantity 0
- Microsoft Bluetooth® Ergonomic Mouse: Price \$69.99, Quantity 0

At the bottom of the form, there are 'Submit' and 'Cancel' buttons on the left, and a 'Task Sequence' button on the right.

8. After the automation has created a new order in the company's order management system (Zoho Order Management), the automation returns the Sales Order number (SO-00012) for reference.

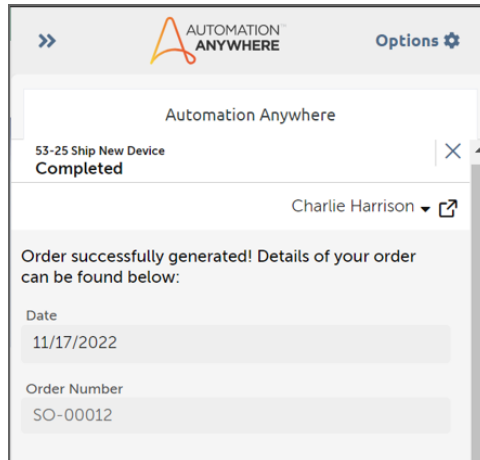

## Access Automation Co-Pilot in SAP and ServiceNow

Automation Co-Pilot makes a shared automation accessible for end users in SAP (via Chrome extension) and ServiceNow (via embedded widget). An employee submits an order request and a manager approves the request.

### Automation Co-Pilot

Business users can directly access authorized automations from their favorite business applications without having to open a new interface, or learn a new app. You can invoke Automation Co-Pilot as a widget in ServiceNow and as a sidebar in SAP. To make the widget accessible:

1. Create and configure the widget in your preferred application.
2. Assign any pre-built automations in Automation Co-Pilot required for teams to complete their daily tasks.

The widget populates assigned automations for specific roles.

The diagram illustrates three ways to integrate Automation Anywhere into a web application:

- iFrame Widget for web apps supporting customization:** Shown as a sidebar with a list of automation tasks such as "Change payment terms", "Set up payment account", "Automation name", "Recent orders history", "Check Delivery status", "Satisfaction survey", and "Look up competitor pricing".
- Embed automation in any web application:** This method supports "Attended, unattended and process automations" and features a "Lightweight and responsive interface". It requires "Seamless authentication with OAuth 2.0 or SAML SSO".
- Chrome Extension Widget for web apps not supporting customization:** Shown as a Chrome extension interface with a top navigation bar and a list of tasks including "7730 Concur expenses to review", "7729 New financial dashboard approval", and "7733 biweekly checks to run for payroll".

## Example Summary

A company employee (Jane) submits a request to order replacement hardware. Jane (operating in ServiceNow) uses the embedded widget to launch an automated bot to process the order, and submit for approval to a Cost Center Manager (Gerald). Gerald (operating in SAP) uses the embedded widget to launch automations that approve and complete the hardware shipment order.

The widget is visible in ServiceNow as a custom ServiceNow component that is placed into the Employee Service Portal page. The widget is invoked as a sidebar through the web browser. For users operating in SAP S/4HANA, the sidebar appears on a page load trigger.

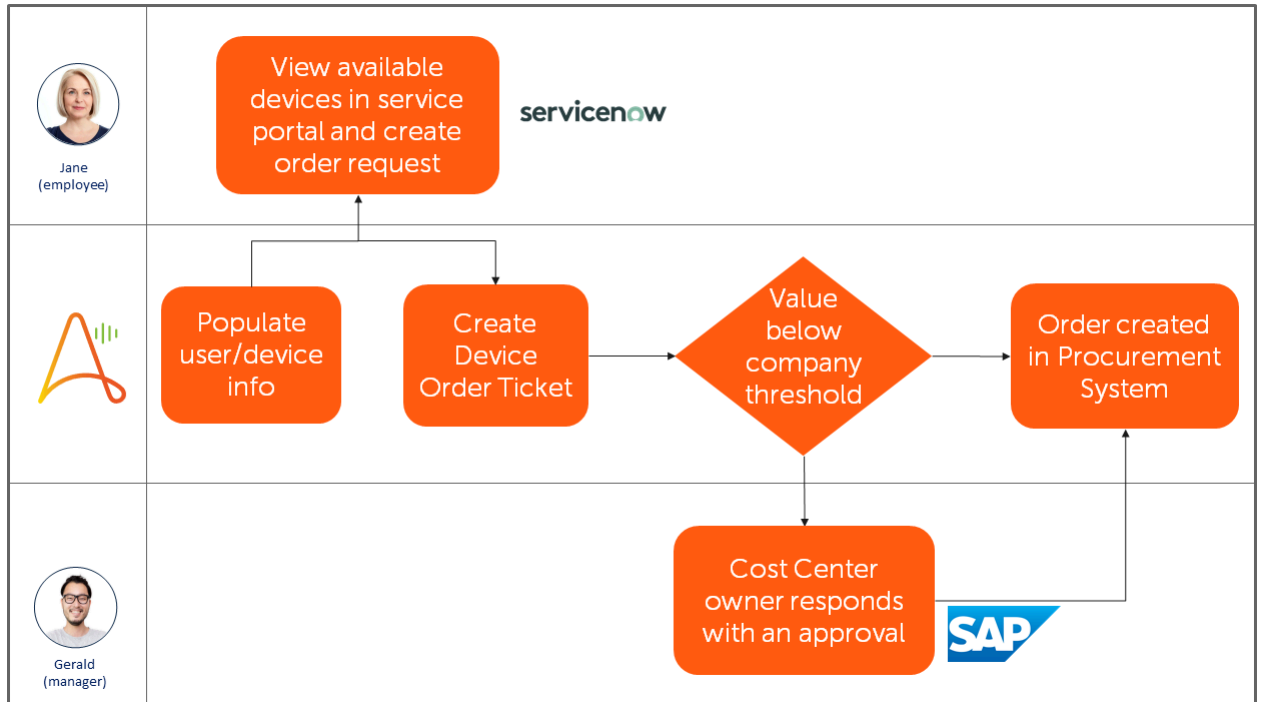

## Setup

1. Complete the setup process flow for ServiceNow. See [Automation Co-Pilot using embedded widget overview](#) on page 3301.
2. Complete the setup process flow for SAP . [Automation Co-Pilot using Chrome extension](#) on page 3326.
3. Assign automations. See [Assign automations to teams](#) on page 3305.
4. The embedded widget can contain combinations of three types of automations:
  - Automation Co-Pilot Process invocation (with two human step forms). See [Deploy processes](#) on page 3375.
  - Attended bot (that can be deployed on the local device). See [Attended and unattended automation](#) on page 3291.
  - Unattended bot (triggered through Automation Co-Pilot process without human input). See [Create a process automation in Process Composer](#) on page 3454.

**Tip:** Sample code

You can download the following sample code to test this example in your own environment. See [GitHub: ServiceNow](#) .

## Procedure

This embedded widget example includes the AARI Process automation type.



The **Hardware Replacement Request** Automation Co-Pilot process allows an employee access to the business ServiceNow Service Portal for IT requests. An employee can use the embedded widget to automate requests. Jane's order request includes replacement hardware such as: keyboards, mice, or laptops.

When Jane opens ServiceNow, they can see the automated process for **Hardware Replacement Request** within the widget.

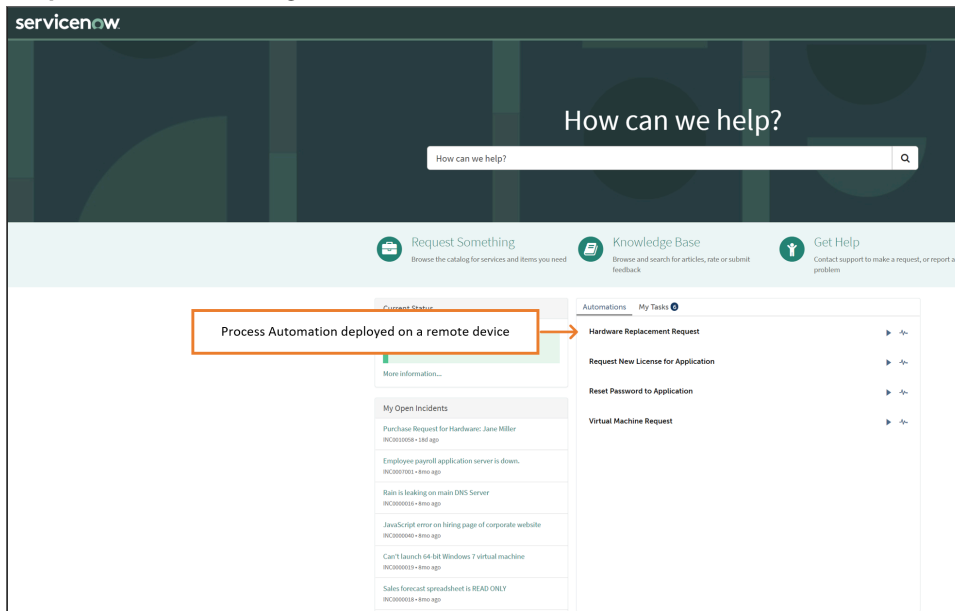

1. Jane initiates the **Hardware Replacement Request** and is taken to an input page in the widget where they enter the information required to execute the automation.
2. Jane can select the request for self, or as another employee, and click **Submit**.

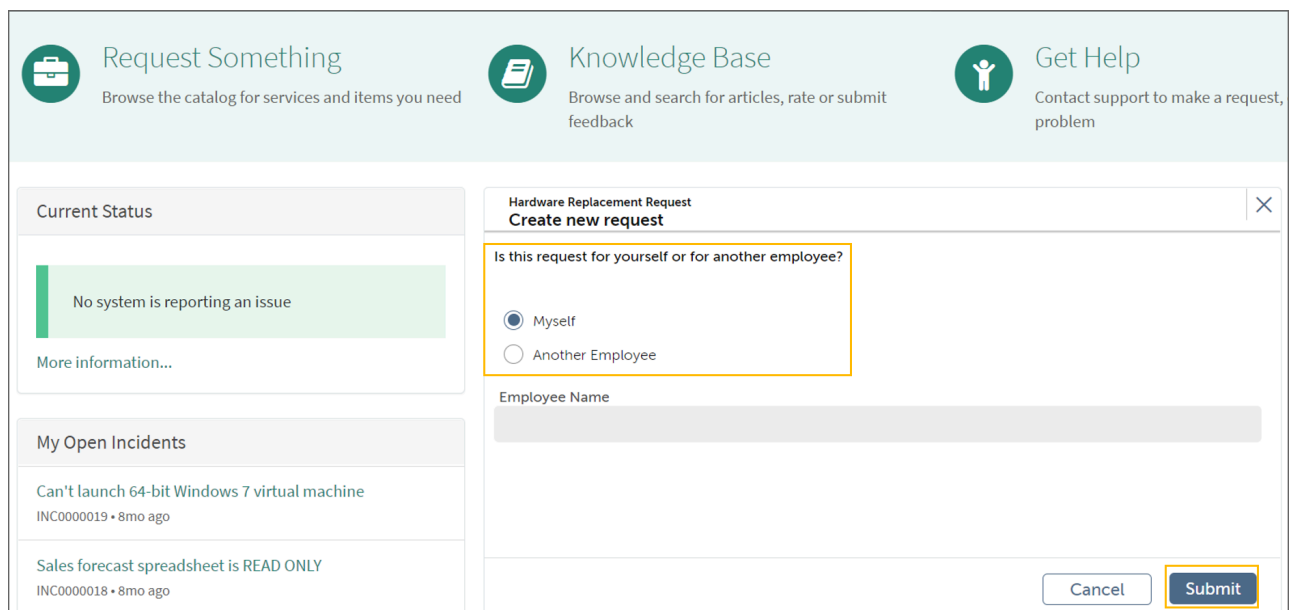

3. After submitting her request, the next automation connects Jane to the business HR system where Jane gathers employee details, such as shipping address. The system connects to the procurement system to retrieve the available items to order.

**Note:** This example includes these steps in the automation to reduce reliance on additional systems.

12-46 Employee Hardware Request  
Display Order Form

Jane Miller

State/Province  
Lancaster

Country  
Ohio

ZIP/Postal Code  
43130

Product	Price	Quantity
Microsoft Bluetooth Ergonomic Mouse	69.99	0
Microsoft Arc Mouse (Black)	118.99	0

Submit Cancel

Task Sequence

- This business rule was created in this automation example to check the total order value:  
If the total order value exceeds the company threshold of \$3000, then an approval is required from the cost center owner. This generates a request to Gerald.
- Gerald focuses on different tasks in the cost management application (SAP). The list of automations in the sidebar is focused on orders, inventory, and other sales related processes. When the widget generates Jane's request for Gerald, a toast message displays in the inbox for the new task in the widget.

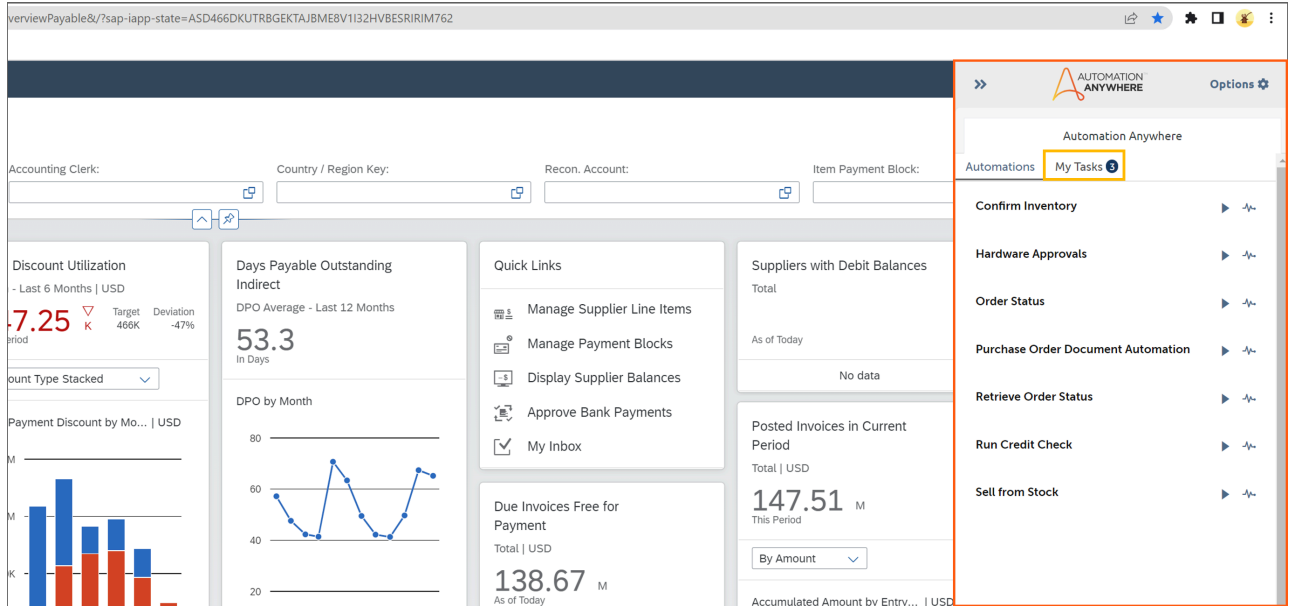

Gerald selects **My Tasks** to view the request and continue with the Automation Co-Pilot approval process.

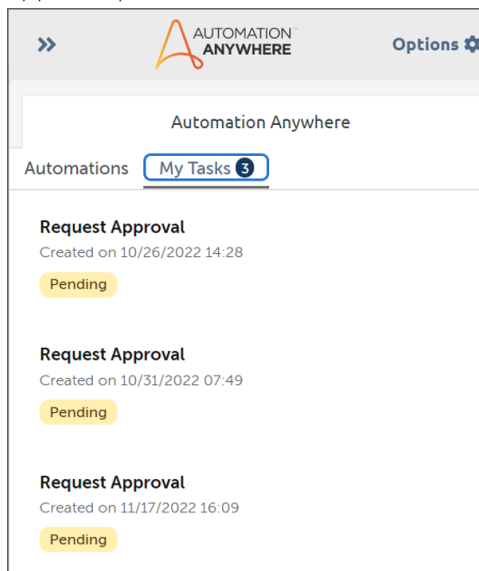

- Gerald approves the request and adds any comments, remaining in the SAP environment.

**Automation Anywhere**

38-29 Request Approval Approval

Gerald Brown

**Request Details**

Date  
2022-11-17T00:00-08:00[America/Los\_Angeles]

Employee First Name  
Jane

Employee Last Name  
Miller

Devices Requested:  
Qty 1 of Apple MacBook - Intel Core i9 - 64GB Memory - 8TB SSD @ \$4799

Total Value  
\$4799

Requestor Comments  
Require new laptop as old one no longer charges

**Approval Decision**

Approve  
 Deny

Approver Comments

- Jane can see the details and status of each step in the overall process in the workspace widget. She can see that all successful steps have completed, and an IT ticket has been created and closed to track the request.

**Current Status**

No system is reporting an issue

More information...

**My Open Incidents**

Purchase Request for Hardware: Jane Miller  
INC0010062 • just now

Purchase Request for Hardware: Jane Miller  
INC0010061 • 2m ago

Purchase Request for Hardware: Jane Miller  
INC0010060 • 10m ago

Purchase Request for Hardware: Jane Miller  
INC0010058 • 18d ago

Employee payroll application server is down.  
INC0007001 • 8mo ago

Rain is leaking on main DNS Server  
INC0000016 • 8mo ago

**Task Sequence**

Run Business Rules  
Nov 17, 2022 16:18  
Completed BOT

Create ServiceNow Ticket  
Nov 17, 2022 16:19  
Completed BOT

Cost Center Approval Needed  
Nov 17, 2022 16:19  
Completed

Procurement: Create Order  
Nov 17, 2022 16:19  
Completed BOT

Update Order Details: Close Ticket in ServiceNow  
Nov 17, 2022 16:19  
Completed BOT

Request closed  
Nov 17, 2022 16:19  
Completed Jane Miller

## Integrate Automation Co-Pilot with Microsoft Teams

Set up the Automation Anywhere app to access Automation Co-Pilot in the Microsoft Teams platform.

### Integrating Automation Co-Pilot in Microsoft Teams

Use the Automation Co-Pilot experience with Microsoft Teams (desktop or web app) directly from your workspace and access authorized automations from within Microsoft Teams without having to open a new interface or learn a new app.

#### Task summary

1. Download all files and edit the manifest.json file using your own URL for the Automation Workspace.
2. Create one zip file for all of the files.
3. Using the zip file, upload the Automation Anywhere app to your organization's app catalog in Microsoft Teams to make it available to end users for download.

---

**Note:** The Automation Anywhere app is not supported on mobile devices.

---

#### Prerequisites

- Create a copy of the URL for your organization's Control Room from the **Embed code** field in Automation Co-Pilot using embedded widget. You will replace the example in the manifest.json file with your URL. See, [Setup iFrame widget using Automation Co-Pilot](#) on page 3303.

---

**Note:** You must use the following parameter in your URL to force the use of the Teams SDK and auth code.

- If the embed code was generated with Tags, then add

```
&App=Teams
```

to the end of the URL.

- If the embed code was generated without Tags, then add

```
?App=Teams
```

to the end of the URL.

---

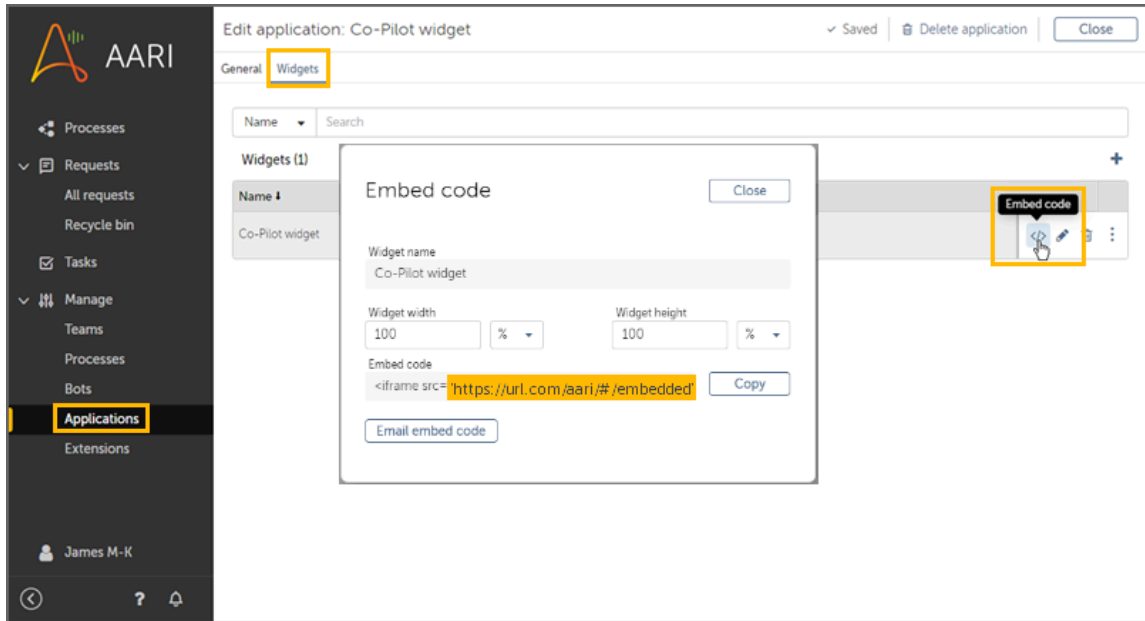

- Download all files from the [MS-Teams-Integration/Automation Anywhere/](#) GitHub folder to use in this setup process.
- Use admin roles and permissions to access your Microsoft Teams platform during the setup process.

1. Edit the manifest.json file by replacing all instances of `your-a360-domain` with the URL of your Control Room.

```

16  "description": {
17    "short": "AARI",
18    "full": "Use the AARI web interface from within MS Teams"
19  },
20  "icons": {
21    "outline": "outline.png",
22    "color": "color.png"
23  },
24  "accentColor": "#FFFFFF",
25  "staticTabs": [
26    {
27      "entityId": "ecad9d6d-55c8-4bd9-820c-aal1580b9e41",
28      "name": "AARI",
29      "contentUrl": "https://your-a360-domain/aari/#/embedded",
30      "scopes": [ "personal" ]
31    },
32    {
33      "entityId": "about",
34      "scopes": [
35        "personal"
36      ]
37    }
38  ]
39  "validDomains": [
40    "your-a360-domain" ]

```

2. Create a zip file containing the contents of the **Automation Anywhere** folder and label it for uploading to Microsoft Teams.
3. Using the admin role and permissions in Microsoft Teams, upload the zip file.
  - a) From the **Apps** tab, click **Manage your apps** in the lower left corner.
  - b) Click **Upload an app**.

- c) **Note:** You must have admin privileges to upload directly. Users without admin privileges should work with their IT department to upload the package with proper authorization.

Select **Upload an app to your org's app catalog** to use the app immediately without review. Optionally, you can select **Submit an app to your org** to submit the app for review by your IT admin.

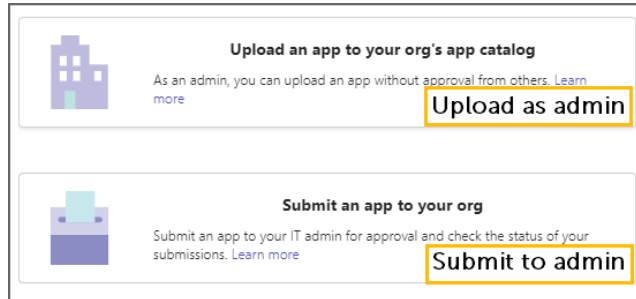

- d) Select the zip file you created in step 2.

4. Click **Add**.
5. When the App loads, you will be prompted to log in to the Automation Anywhere Control Room. Click **Log in** to continue.  
The login window closes and the Automation Co-Pilot interface is displayed.

The end user installs the Automation Anywhere app:

1. In Microsoft Teams, click the ellipsis button in the left sidebar and search for the Automation Anywhere app.
2. When prompted, log in to the Automation Anywhere Control Room and the Automation Co-Pilot interface is displayed.

## Disable third-party storage partitioning

Automation Co-Pilot users should disable third-party storage partitioning (such as Google Chrome or Microsoft Edge) to enable communication to the embedded iFrame.

You disable third-party storage partitioning to prevent users from experiencing the following situation: a user logs in successfully and a window displays for Automation Co-Pilot. The Log In window does not close and the Automation Co-Pilot window displays a spinner.

As of M113, third-party storage partitioning is enabled by default for some users. However, you can disable storage partitioning by setting a feature flag.

- If this policy is set to AllowPartitioning or unset, third-party storage partitioning might be enabled.
- If this policy is set to BlockPartitioning, you cannot enable third-party storage partitioning. This policy can cause disruption with the communication of data between the iFrame and Automation Co-Pilot.

## Disable third-party storage partitioning

To disable third-party storage partitioning:

1. Navigate to the appropriate browser partitioning location:
  - For Google Chrome, navigate to: `chrome://flags/#third-party-storage-partitioning`. For more details, see [Storage partitioning](#).
  - For Microsoft Edge, navigate to: `edge://flags/#third-party-storage-partitioning`. For more details, see [Microsoft Edge Developer documentation](#).
2. Select **Disabled** from the drop-down.

## Using Automation Co-Pilot for Business Users on desktop

Use Automation Co-Pilot for Business Users through your desktop to manage routine tasks such as validating data, retrieving approvals, and managing escalations through bots.

---

**Note:** Roles, permissions, and licenses may continue to reference Automation Anywhere Robotic Interface (AARI)] within the product.

---

The following workflow describes how to use Automation Co-Pilot to automate and manage your tasks:

1. Create a user:
  - The Control Room administrator creates a user with a Bot Creator license.  
[Create a user](#) on page 1739 | [Automation 360 licenses](#) on page 1407
  - The user logs in to the Control Room to start building bots.  
[Install Bot Agent and register device](#) on page 1347 | [Get started building bots](#) on page 3197
2. Create forms using the Interactive forms package:
  - Interactive forms enable you to design forms for submitting and regrouping data from various applications.  
[Create a form](#)
  - Link the form to a newly created bot or an existing bot using the Bot editor interface.  
[Add a form to bot](#) on page 3292
3. Add triggers to the bot:

Trigger loop enables you to add triggers that can run a task automatically when certain predefined events occur.

[Adding a trigger to run a bot](#) on page 2286



## Automation Co-Pilot Desktop Assistant

Attended Bot Runner users can use the Automation Co-Pilot Desktop Assistant application to access bots without logging into Control Room.

---

**Note:** Roles, permissions, and licenses may continue to reference Automation Anywhere Robotic Interface (AARI)] within the product.

---

Control Room administrator adds Active Directory (AD) users by selecting AD domain, providing environment details, and assigning a role and device license. Administrator can further deploy the Control Room RBAC by specifying role-based privileges and permissions at the bots and Bot Runner level.

Control Room RBAC on Bot Runner users facilitate a complete isolation based on pre-defined criteria such as users across various business units or departments. This also includes the privileges that is applied at a folder level to completely and seamlessly isolate bots of one department from the other.

In a typical scenario, triggering some specific bots to complete important tasks can be one of the daily routines for attended Bot Runner users. Entire process of signing into Control Room can be time consuming. Automation Co-Pilot Desktop Assistant reduces this effort considerably. When Bot Agent is installed on a device, an application shortcut on the desktop for Automation Co-Pilot Desktop Assistant is also created along with a **Start** menu icon.

Users with attended Bot Runner license can launch this application, use their AD credentials to sign in and review the list of available bots, and run the specific bot.

---

**Important:** Automation Co-Pilot Desktop Assistant application is not available for the Citizen Developer license.

---

## Sign in to Automation Co-Pilot Desktop Assistant

Use the Automation Co-Pilot Desktop Assistant application to directly run bots without signing into Control Room.

- Automation Co-Pilot service must be running in Control Room to use Automation Co-Pilot Desktop Assistant .
- This application is designed for users with either an attended license, an AARI license, or both. Attended Bot Runners can use their license to run bots, while users with an AARI license can run processes. Users with both licenses can run both bots and processes.

1. Click the **AARI** icon to open Automation Co-Pilot Desktop Assistant .
2. Use Automation 360 credentials to sign into the application.

All the bots that you have access to are listed.

3. Optional: Use the **Search** bar at the top to find a bot.
4. Optional: Click **Show pinned only** check box to list your pinned bots.  
Ensure you pin (similar to favorites) the most used bots for a quick access.
5. Click **Launch** to run the bot.

After the bot run is successful, a **Completed** message is displayed. You cannot launch another bot until this activity completes.

## Automation Co-Pilot Desktop Assistant automation activities

As an attended user who runs attended bots, you can perform several automation activities using Automation Co-Pilot Desktop Assistant .

### Automations page overview

In Automation Co-Pilot Desktop Assistant , you can view a list of available bots for you to run in the **Automations** page.

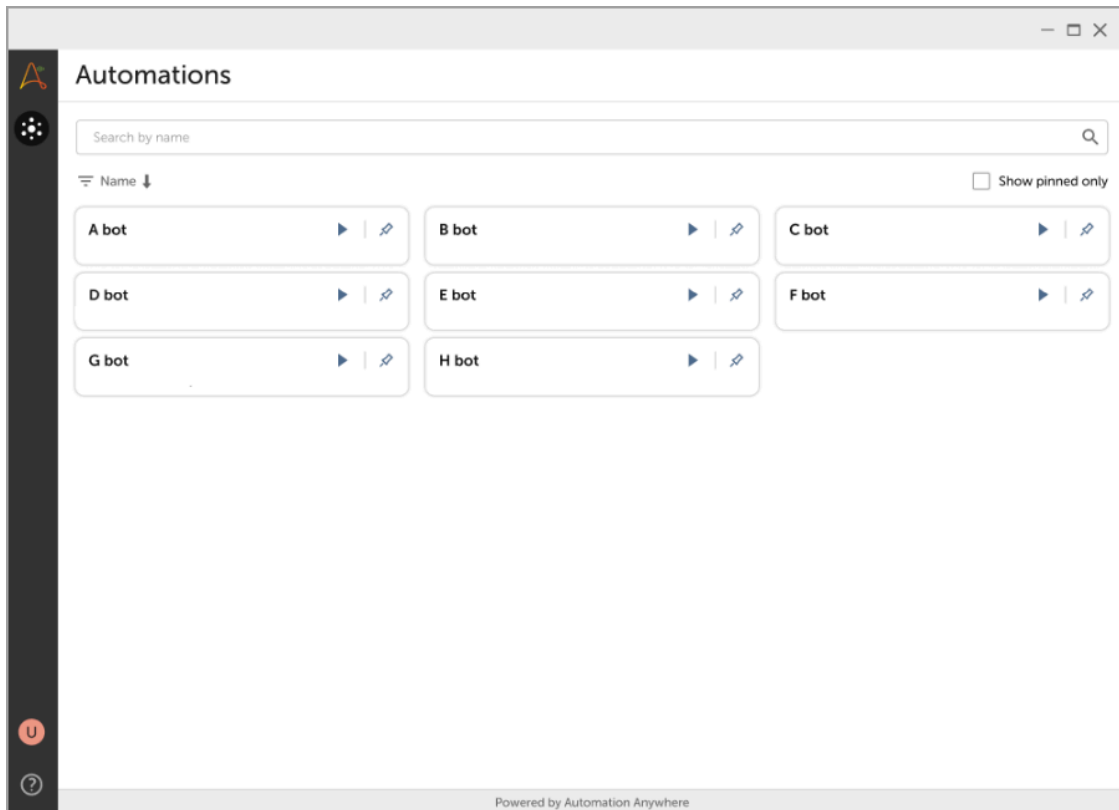

You can re-size the page to fit your screen and have its contents automatically adjust.

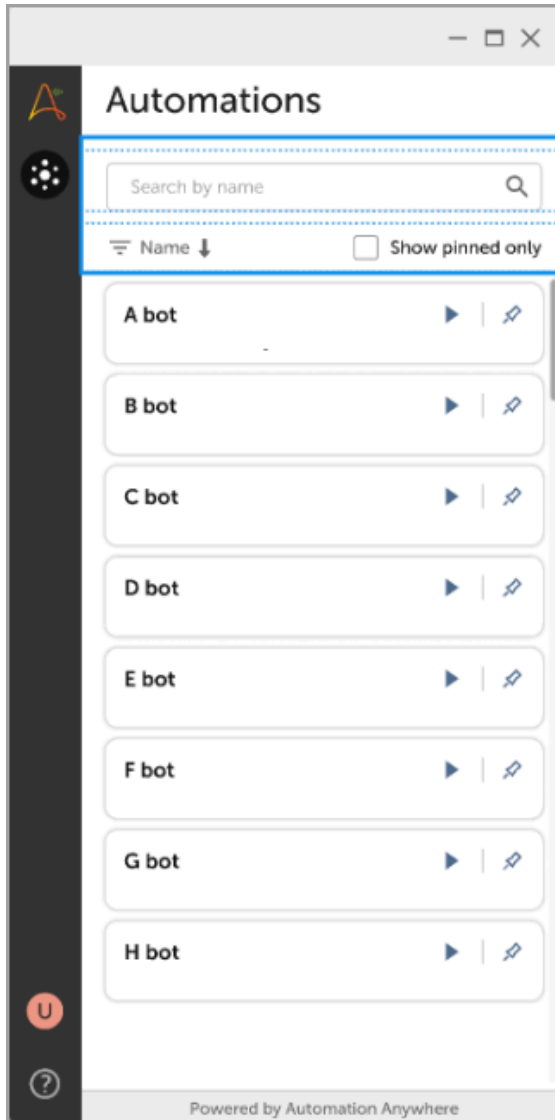

From the **Automations** page, you can also pin, sort, or search for bots.

## Key features

Continue pending automation

You can continue any pending automation that you started from different Automation Co-Pilot Desktop Assistant instances. If you start an automation from one instance and then reconnect to continue the automation on another instance, the automation will process.

This provides a consistent automation experience no matter which instance you use to access Automation Co-Pilot Desktop Assistant.

Consistent state

Automation Co-Pilot Desktop Assistant will remain in a consistent state regardless of how

View and run any available bots

many Automation Co-Pilot Desktop Assistant instances you use. The state will be updated to the latest state across all Automation Co-Pilot Desktop Assistant instances.

To view and run any available bots, simply click **Start** to start the automation.

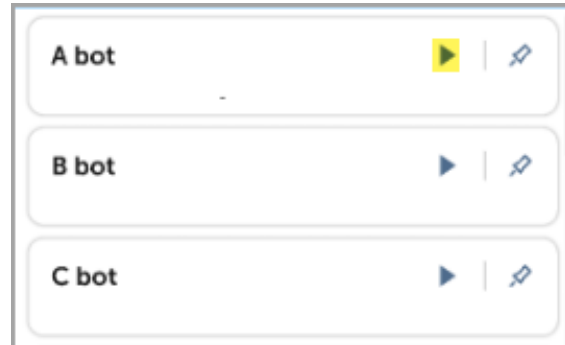

View status or control bot progress in one page

After you run a bot, you can view its progress in real time.

The progress details of a bot run contains information such as:

- The name of the bot.
- The action that is currently being performed.
- The line number that is being executed.
- The total number of lines in the bot.
- Status of the bot run (% completed).

The progress details are displayed only when a bot is run on a local device by a user with Attended Bot Runner license.

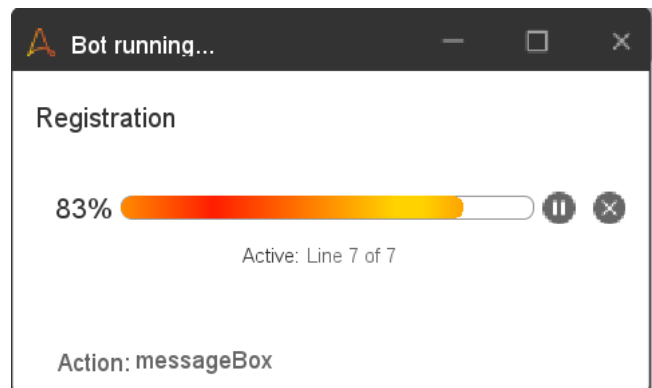

You can also pause, start (resume), or stop the bot progress.

By presenting the status and bot controls on one unified page, this ensures consistency for each bot run.

---

**Note:** To use the bot controls, you must have the **Managed my activity** permission. Otherwise, you can view the controls only.

---

View detailed status

You can view the details of a bot status . For example, you can use the details to troubleshoot the automation if an error occurs.

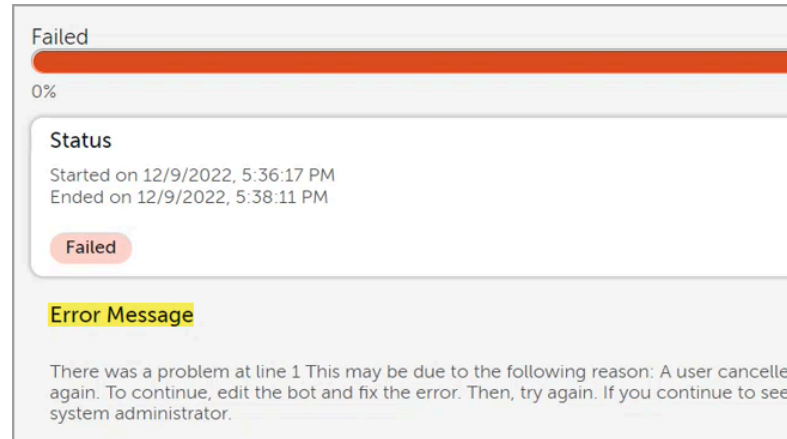

## Queue automations

You can queue attended bots and manage multiple bot deployments.

## Queue page

In Automation Co-Pilot Desktop Assistant, the **Queue** page allows for you, an attended user, to view and manage your attended bots that are in multiple deployments. This helps keep track when you are deploying more than one bot at the same time.

The goal of this page is to help you manage on your pending queues at a quick glance.

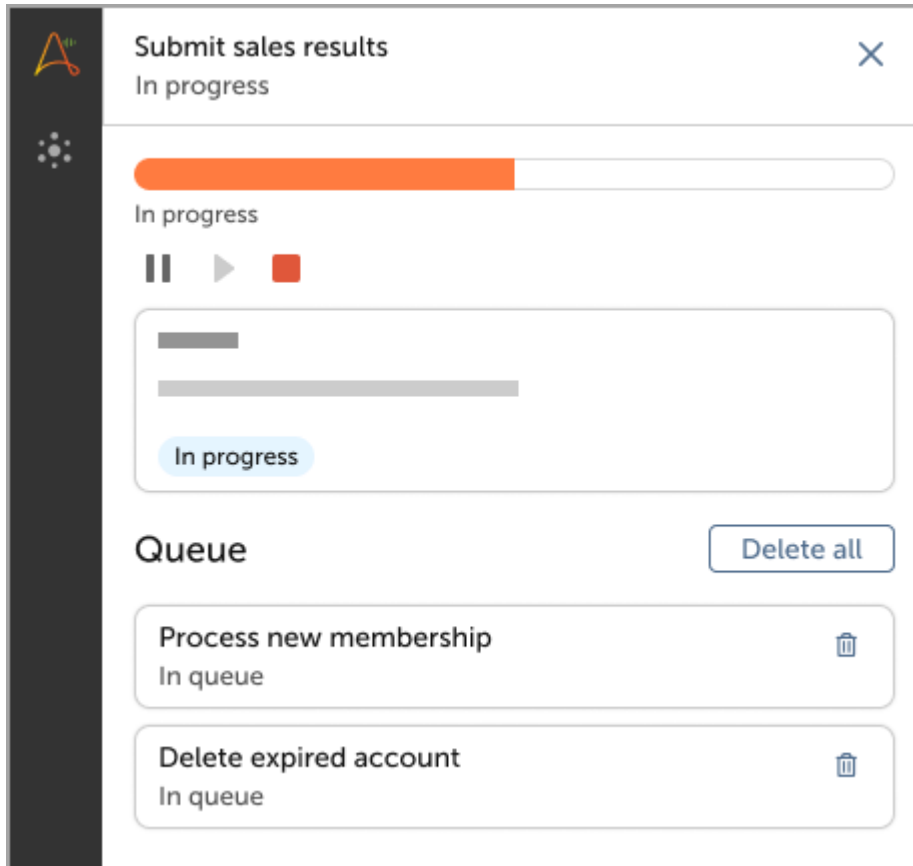

## Benefits

Deploy more than one bot instance	You are able to deploy multiple bot instance and not limit yourself to just one bot deployment.
Identify when triggers are initiated	When you add triggers to your bots, the bots will automatically be placed in the queue.
Grants user direct control over queues	When your bots are in a queue, you have the ability to start and stop your queue at any time. You can also delete all bots from queue list using the <b>Delete all</b> function, or delete individual bots.
Continue queues where you left off	When you move devices or you accidentally disconnect your device while the queue has not been cleared up. You can always continue your deployment or progress when you log back.
Search for specific queues	You can search for specific queues using keywords and quickly identify queues that are on your list.

## Add Automation Co-Pilot URLs to trusted list

To ensure secure access to Automation Co-Pilot services, add URLs specific to the service to your safe recipients or trusted list.

### Automation Co-Pilot URLs list

Because Automation Co-Pilot service hosting uses dynamic IP addresses, we recommend you add the following complete URL instead of an IP address for Automation Anywhere services to your safe recipients or trusted sites list.

Service	Description	URL	Device
Telemetry	Allows performance and usage information to be gathered anonymously in order to improve product quality.	<ul style="list-style-type: none"> <li>cdn.pendo.io</li> <li>app.pendo.io/</li> <li>data.pendo.io/</li> <li>https://pendo-static-5673999629942784.storage.googleapis.com/</li> <li>https://pendo-io-static.storage.googleapis.com/</li> </ul>	Bot Creator and AARI User devices
Documentation	Allows documentation content to be displayed to the creator while building automations.	<ul style="list-style-type: none"> <li>https://iph.zoominsoftware.io/</li> <li>https://automationanywhere-be-dev.zoominsoftware.io/</li> <li>https://automationanywhere-staging.zoominsoftware.io</li> <li>https://docs.automationanywhere.com/</li> <li>https://automationanywhere-be-prod.automationanywhere.com</li> <li>https://*.youtube.com/</li> <li>https://*.wistia.net/</li> <li>https://*.wistia.com</li> </ul>	Bot Creator devices

Service	Description	URL	Device
Storage	Allows files to be stored and exchanged between AARI User and automations.	<ul style="list-style-type: none"> <li>https://*.amazonaws.com/</li> <li>https://*.googleapis.com/</li> </ul>	Bot Creator and AARI User devices
Assets	Allows assets like fonts and icons to be correctly displayed in the user interfaces.	<ul style="list-style-type: none"> <li>https://fonts.googleapis.com/</li> <li>https://fonts.gstatic.com/</li> </ul>	Bot Creator and AARI User devices

## Using virtual window for picture in picture

You can set up and configure attended bots to run in a virtual window [picture in picture (PIP) mode] in Automation Co-Pilot.

### What is virtual window?

Virtual window is a feature in Automation Co-Pilot where you can configure your bots to run in a virtual window. This feature uses the Microsoft child sessions feature to render a second window (picture-in-picture mode) on your desktop. When you use this feature with Automation Co-Pilot, you can view a small window of your automations on your desktop, enabling you to interact or reference it as you work on other important tasks.

---

**Note:** Child sessions is a feature built by Microsoft to enable the picture-in-picture mode in Windows. Automation Co-Pilot uses the virtual window option to access this Microsoft child sessions feature. The automation experience remains the same and is maintained by Automation Co-Pilot for Business Users. To learn more about Microsoft child sessions, see [Microsoft Child Sessions](#).

---

### Why is virtual window important?

An AARI Admin can select virtual window to configure their bots and assign their teams to use. Team members can simply run their bots and the virtual window will automatically start the automation process. As an AARI Admin, you can automate while maintaining control and the ability to multitask without having to remain on a bot page or application, and waiting for the automation progress to complete.

While you automate with virtual window, your computing devices (such as your mouse and keyboard) remains available to use without blockers.



## Virtual window scenario

A small but busy customer success team at a large service company wants to address and automate hundreds of support tickets that are submitted each day.

With the proper configuration, Jake (an AARI Admin for the customer success team) can configure bots for each customer agent of his team to automate tasks and manage their multitasking duties to resolve other issues.

Jake is an AARI Admin

- He is an admin of a team and can manage bots and team assignments for members of his team.
- He plays the vital role of bots and teams configuration in Automation Co-Pilot for Business Users.
- He can select the virtual window option when configures bots for his team.

When Zoe (an AARI User and customer success agent) automates a customer request, would typically need to verify a lot of time-consuming customer information on one automation page. However, if Zoe could automate using a virtual window in Automation Co-Pilot, she would be able to multitask while the bot runs in her desktop background.

Zoe is an AARI User.

- She is a member of a team.
- She can run bots in a virtual window to automate her tasks.
- Her goal is to run bots and ensure her tasks are completed.

Zoe would be able to automate these daily operations:

- Customer requests
- Refund policy
- Updating customer information.

For details on each user roles and function, see [Users and team roles for Automation Co-Pilot](#) on page 3408.

For details on teams and functions, see [Team management](#) on page 3377.

## How to use virtual window

The following video provides a sample walk through of configuring bots and running in a virtual window, showing two personas (AARI User and AARI Admin) and their key tasks.

For a detailed procedure, follow these steps:

1. [Create a bot for a virtual window](#) on page 3370.
2. [Configure a bot to use virtual window](#) on page 3370.
3. [Run your bot with virtual window](#) on page 3370.

---

**Important:** In some cases when you deploy your bot using virtual window, the user credential window will prompt you to log in every time. As a workaround, you must log in to the user credential window and authenticate only one time, then log out or restart your

system. When you log in again and run your bot, the window does not prompt again. This is a known behavior for the Microsoft child sessions feature.

---

Triggers is not supported

The virtual window does not support triggers and does not work if bots contain triggers.

Solution to server manager error

When you encounter a server manager error when you run bots in virtual window, see [Solution for server manager error](#) on page 3371.

## Create a bot for a virtual window

In this example for picture in picture, Zoe is an AARI User with access to the Automation 360 Control Room for creation and check in of bots.

- Zoe has the Bot Creator license to create bots in the Control Room.
- Zoe has the Bot Creator license to check in bots in the Control Room.
- Zoe has access to the Control Room.

Zoe is a single persona that completes this task in cooperation with other personas to demonstrate the full procedure of the using the virtual window (see link at bottom of page).

1. Log in to the Control Room.
2. Create a bot.

Zoe can create any bot without triggers. She, like any developer, can run the bot without checking in.

To access this bot, Zoe and her customer success team will need to be assigned to this bot. As an AARI Admin, Jake can view and manage the bot that Zoe checked in, in Automation Co-Pilot for Business Users.

## Configure a bot to use virtual window

As the AARI Admin, Jake can configure bots for his team. Since Zoe has checked in a bot, Jake will be able to configure this bot to enable the virtual window option in Automation Co-Pilot.

- Jake has the system-created **AAE\_Robotic\_Interface Admin** role for the AARI Admin.
- Jake has access to Automation Co-Pilot for Business Users.

1. Log in to Automation Co-Pilot.
2. [Configure a bot](#) on page 3397.

Jake can configure the bot that Zoe has checked in and set the option to run a bot in a virtual window. Additionally, Jake can assign Zoe and her team to this bot for them to access it in Automation Co-Pilot.

After Jake has configured the bot and assigned it to Zoe, Zoe can then deploy this bot .

## Run your bot with virtual window

Zoe can run her assigned bots which have been configured to use virtual window. She can use Automation Co-Pilot Desktop Assistant to run these bots from her desktop.

Zoe has access to Automation Co-Pilot Desktop Assistant.

1. Log in to Automation Co-Pilot Desktop Assistant.
2. Run the configured bot.  
Zoe selects the bot that Jake had configured. When Zoe deploys the bot, a virtual window appears on her desktop.
3. Optional: Click the edit icon to edit the virtual window.  
By selecting the **edit** icon, Zoe can interact in real-time with her bot deployment through the virtual window.

### Solution for server manager error

You might encounter a server manager error when you launch bots using the virtual window. This topic will help troubleshoot if you counter that problem.

You have successfully created a bot to deploy with virtual window. See [Using virtual window for picture in picture](#) on page 3368.

**Note:** Child sessions (picture-in-picture mode) is a Microsoft Windows feature. Virtual window is an Automation Co-Pilot feature that uses Microsoft child sessions.

When you deploy a bot with virtual window, you might encounter an error message that relates to the server manager. This does not occur for every instance but when it does occur, you can follow these steps to resolve this issue.

Example of the error message:

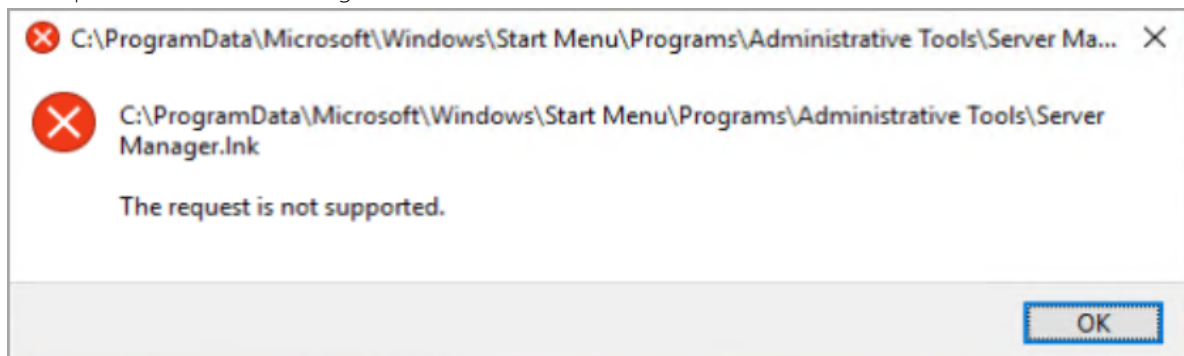

1. Modify the settings for the individual server as follows:
  - a) Open the server manager.
  - b) Navigate to **Sever Manager > Properties**.  
This page allows you to modify the setting at the individual server level.
  - c) Select the **Do not start Server Manager automatically at logon** setting.
2. Modify the settings at the central level by using group policy as follows:
  - a) Log in to domain controller.
  - b) Launch Group Policy Management console.  
You can start the Group Policy Management console when you navigate to **Server Manager > Tools > Group Policy Management**.

**Note:** If the Group Policy Management is not visible, then you can add this as a feature in **Server Manager > Add Roles and Features**.

- c) Create GPO in domain where all server machines belong.
- d) Navigate to **Computer Configuration > Policies > Administrative Templates > System > Server Manager** in the Group Policy Management editor.
- e) Right click the **Do not display Server Manager automatically at logon** setting.
- f) Click **Edit**.
- g) Select **Enabled** to enable the setting.
- h) Click **OK** to close the Group Policy Management console.

When the policy is applied, the server manager will not launch when you run your bot with virtual window.

---

**Note:** The policy will be applied based on the Group Policy refresh interval for your device. If the policy is not applied then run the **gpupdate /force** command.

---

## Automation Co-Pilot for Business Users on the web interface

The Automation Co-Pilot for Business Users on the web interface is an intuitive portal and dedicated workspace for the AARI User to create requests, run tasks, and for an AARI Manager to create manage team roles and deployment.

---

**Note:** Roles, permissions, and licenses might continue to reference Automation Anywhere Robotic Interface (AARI)] within the product.

---

Automation Co-Pilot for Business Users on the web interface provides an engaging experience with attended and unattended bots. It gives you a one-stop place to view and organize your documents and tasks, perform actions, and hand over the work to bots. In addition, it provides a process-centric approach to deliver automation.

### Capabilities

Automation Co-Pilot for Business Users on the web interface helps you in the following ways:

- Start automation from an easy-to-use process catalog.
- Automate long-running workflows across multiple users and bots.
- Handle bot exceptions.
- Train users and reduce errors with guided automation.
- Multitask with humans and bots.
- Monitor and audit attended automation.

Automation Co-Pilot for Business Users on the web helps multiple users to collaborate with bots without disruption and without accessing your personally identifiable information (PII) data and confidential systems.

The following image illustrates the front-office automation capability:

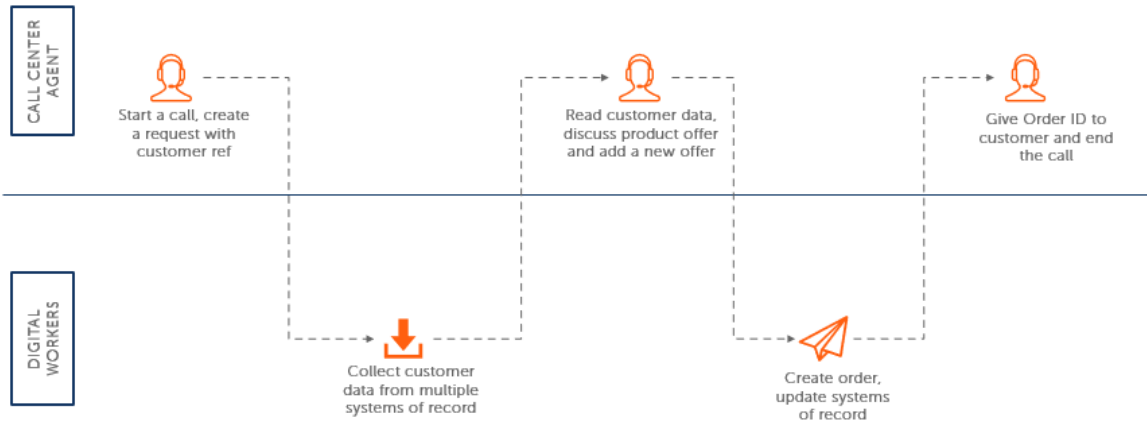

## Components

Automation Co-Pilot for Business Users on the web interface includes the following components:

Bots	The bots automate specific, repetitive, rule-based tasks.
Form	The form enables humans to invoke and interact with the bots through the customizable web interface.
Process	The process connects the bots and the forms together. The process contains the logic for triggering the bots and the forms and coordinating the flow of data between them.
Request	The request is an instance of a process. If the process defines a template of how bots and forms interact, a request is a specific instance of that template.
Task	Tasks are the steps that must be performed within a process. Processes can have two types of tasks: <ul style="list-style-type: none"> <li>• Bot task: A task that is performed by a bot.</li> <li>• Human task: A task that is performed by a human; a human task is a form.</li> </ul>

Review the following image to gain a better understanding of the relationship between these components.

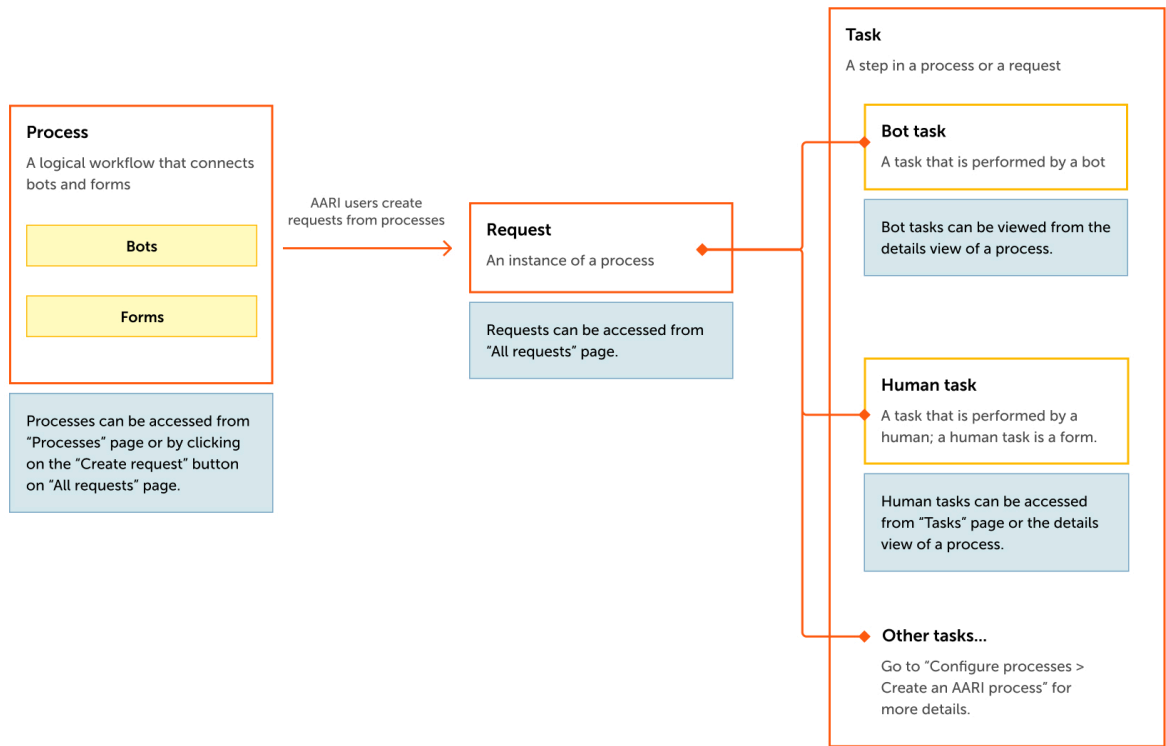

## Architecture

The following images illustrate the architecture of Automation Co-Pilot for Business Users on the web interface:

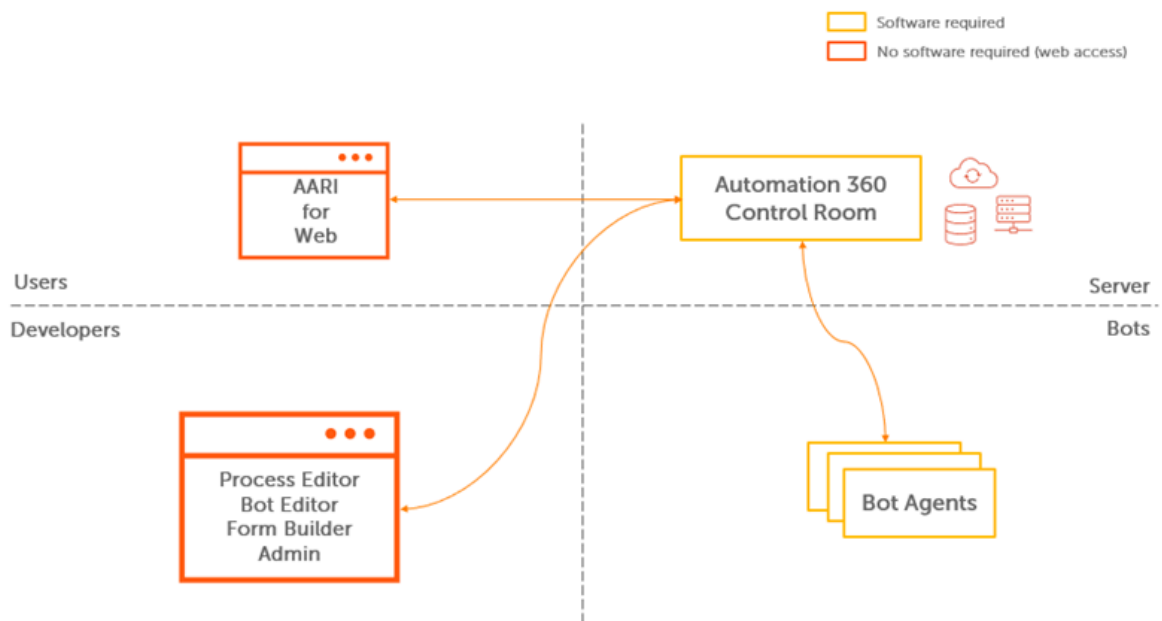

Storage parameters for process automation are detailed in the following topic. [Cloud storage usage](#) on page 3481

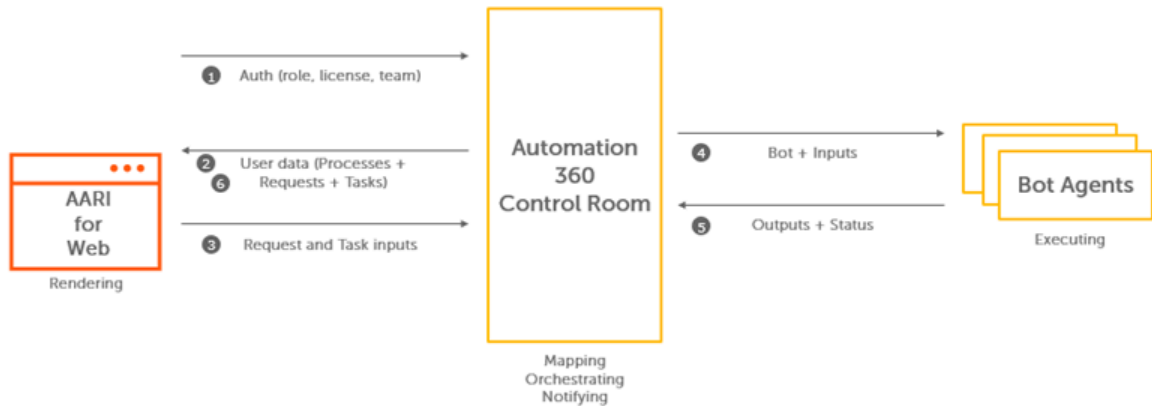

## Setting up

The following workflow lists how to use Automation Co-Pilot for Business Users on the web interface to automate and manage your tasks:

1. [Configure processes](#)
2. [Deploy processes](#)

---

**Note:** To view the Automation Co-Pilot for Business Users on the web interface tasks in an interactive visual format, see [Get started with AARI](#).

---

## Deploy processes

Automation Co-Pilot for Business Users on the web interface provides a dedicated workspace to organize processes, create requests, and run and view tasks. An AARI Manager can create new teams and manage team roles and deployment of tasks.

You can access Automation Co-Pilot from the Automation 360 home page by clicking the **Explore AARI** link which provides a shortcut

to Automation Co-Pilot for Business Users on the web interface.

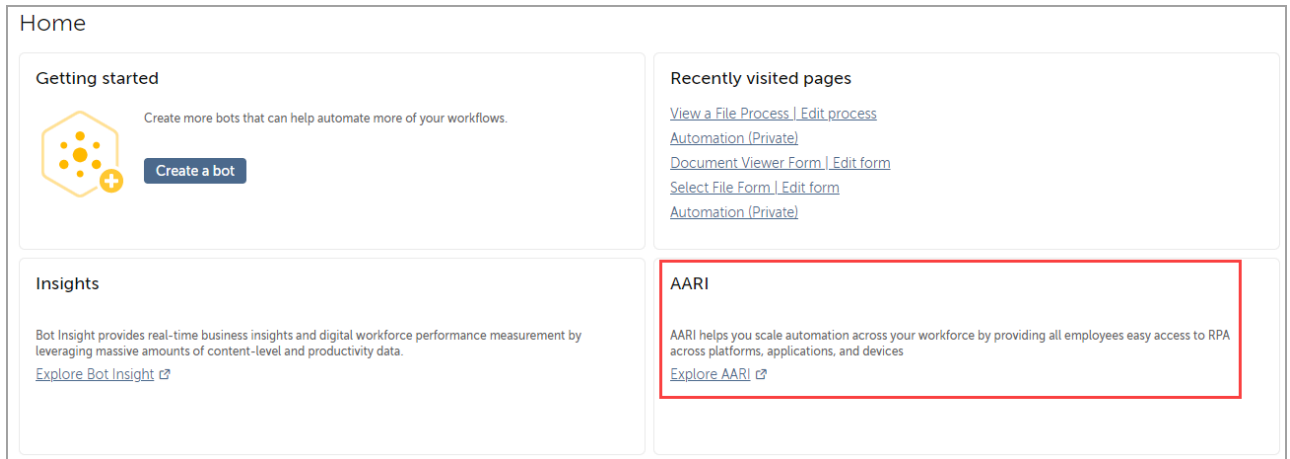

The checked-in processes are available in Automation Co-Pilot for Business Users on the web interface and can be assigned to the teams so that the team members can create requests and complete tasks.

The three main components involved in deploying a process are as follows:

- [Team management](#) on page 3377
- [Manage a process in Automation Co-Pilot](#) on page 3378
- [Request management](#) on page 3379

## Deployment workflow

The following workflow describes the steps involved in deploying a process:

1. [Create a team and assign roles to team members](#) on page 3387.
2. [Assign a team to a process](#) on page 3389.
3. [Create a request and complete a task](#) on page 3384.

## Other tasks

Depending on the requirement, you can also perform the following tasks:

- As an AARI Manager, you can either assign or unassign tasks to your team members.  
[Assign or unassign a task](#) on page 3390.
- To clear the memory space, as an AARI User, AARI Manager, or AARI Admin, you can delete the requests that are no longer required.  
[Delete a request](#) on page 3385.
- To make process selection easier at the time of request creation, as an AARI User or AARI Manager, you can view, pin, or search for your assigned processes.  
[View and search for a process](#) on page 3391.
- As an AARI User, to quickly search for a specific request created, you can filter and search for that request.



[Filter and search for a request](#) on page 3391.

- As an AARI User, when you have many tasks created from multiple requests, you can filter and search for a specific task.

[Filter and search for a task](#) on page 3393.

- You can edit your process in the **Process** page of the web interface.

[Configure a process](#) on page 3398

- As an AARI Admin, you can edit bots to set parameters, enable virtual window, and assign teams to bots.

[Configure a bot](#) on page 3397

Related concepts

[Users and team roles for Automation Co-Pilot](#) on page 3408

Users with specific roles and permissions can use different features in Automation Co-Pilot to automate business processes as per requirement.

[Reference ID properties](#) on page 3380

The reference ID is a unique key reference that help you identify your related processes and requests. The reference ID is also different for teams, process, and bots.

## Team management

Team management is an essential function of Automation Co-Pilot for Business Users on the web interface. The basis of request and process assignment is dependent on the team setup.

### Overview

The team configurable in Automation Co-Pilot helps business managers to define the following aspects:

- How a request can be created
- How a request is visible to the other users
- Who can read, update, or delete requests

### Team structure

A team contains users with specific team roles—**Admin**, **Owner**, and **Member**. The admin has the ability to modify their team. By default, the AARI Manager is the **Admin** of their team. They can create new teams, manage existing teams, assign team roles to their team. As an admin, an AARI Manager can add other admins to their teams. A team can have more than one admin but must have at least one admin. To access a process and create new requests, the AARI Manager must request the AARI Admin to assign the AARI Manager team to a process.

An AARI Admin can also simultaneously add multiple users with similar roles (custom role) to the team. The custom role in the Control Room is aligned with a team in Automation Co-Pilot, and the behavior of the enhanced team setup is as follows:

- The users added with the custom role are assigned a **Member** role within the team. This role cannot be changed to **Owner** or **Admin**.

- You cannot view these users added with the custom role in the **Users** tab of the **Manage > Team** page.
- If a user is added through the custom role and also added manually to the team, their role in the team will be the same as the role assigned to them manually. For example, if the user is a **Member**, they will continue to have the **Member** role whereas if the user is an **Owner**, they will be assigned the **Owner** role in the team.
- If the user is no longer part of a custom role, the user will also not be a part of the team.

For example, create a custom role (aari\_role\_finance) in the Control Room and add the required users (aari\_user1, aari\_user2, aari\_mgr1) to this role. You can now add this custom role, aari\_role\_finance, to a team in Automation Co-Pilot, and the users associated with this role are automatically added to the team. The team role of the users (aari\_user1, aari\_user2, aari\_mgr1) is **Member**. The team role of these users cannot be changed from **Member** to either **Admin** or **Owner**. If aari\_user2 is added as a part of aari\_role\_finance and also added manually through the **Users** tab and the role is **Owner**, then the team role of this user is retained as **Owner**.

## Team types

Each team is configured to a team type (shared or private) and depending on that type, requests that can be viewed and accessed by members of that team might change.

- **Shared**: All the requests can be viewed by admins, owners, and members of that team.
- **Private**: Requests can be viewed only by the users creating those requests and the owner and admin of the team.

The team roles are based on the Control Room role assigned to the user. Each team role has a subset of permissions and actions that can be performed by that role. These sets of permissions vary between the shared and private team types.

Related concepts

[Users and team roles for Automation Co-Pilot](#) on page 3408

Users with specific roles and permissions can use different features in Automation Co-Pilot to automate business processes as per requirement.

## Manage a process in Automation Co-Pilot

A process contains bot and human tasks. An AARI Admin can manage and assign processes to teams to deploy processes or automate tasks.

The AARI Admin performs global process management tasks. Such tasks include, but are not limited to:

- View the checked-in processes from the Control Room.
- Assign teams to a process for request creation.
- View and resolve pending requests and tasks.

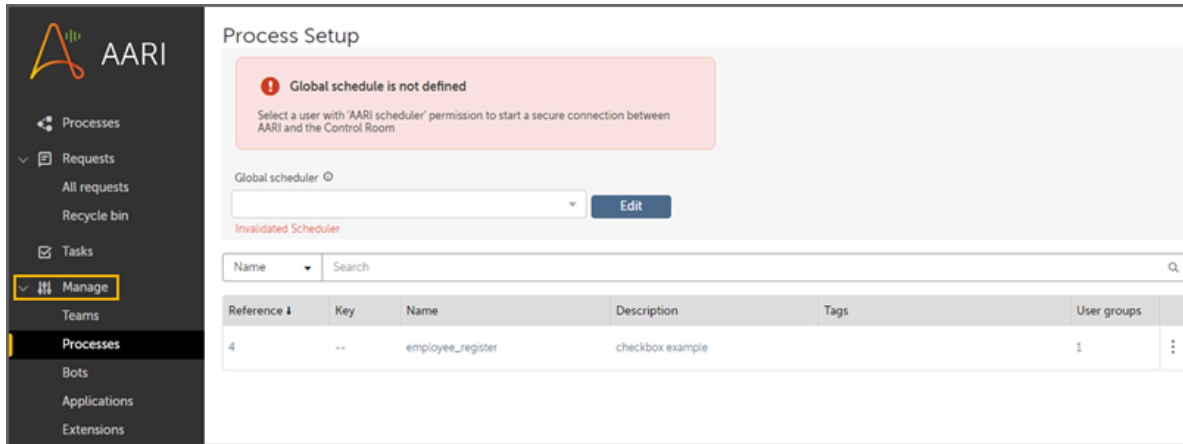

You can view your requests on the **Processes** page. For easy access to a specific process, you can sort the processes by name in ascending or descending order and toggle the pinning of a process. The responsive view of the **Processes** page adjusts the display to your screen size. To guide with your team assignment, you can also reference the team from which a request is created by referring to the team name added in the process tile on the **Processes** page.

Select a process to begin editing and select who and how the process can be run. Find initial settings on the General tab. Enable users to run the process by adding role and team types on the **User group** tab.

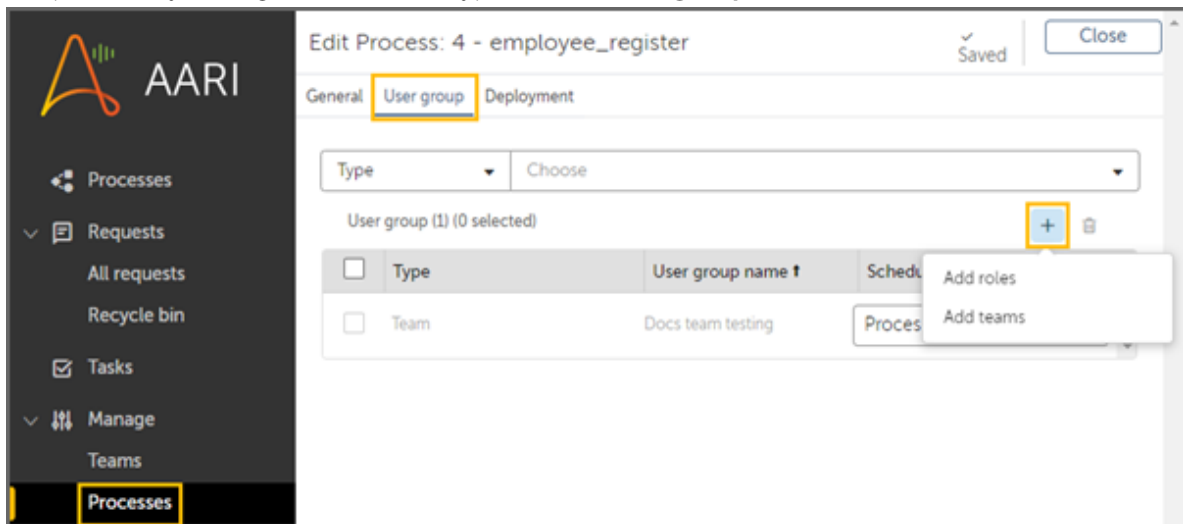

## Request management

A request must be created to automate processes to complete assigned tasks. Members of a team create requests and complete the corresponding tasks.

Requests must always be created within a team. This ensures that the teams assigned to the same process cannot see each other data. By default, an AARI User, selected as an owner or member of their team, can create requests because their role has the **AARI license**, which enables them to access Automation Co-Pilot and create requests.

The structure of request creation is as follows:

- An AARI User (team owner or member) can access and view all the processes that are assigned to a team on the **Processes** page.

- The AARI User must provide all the required information in an **initial form**.
- The bots and human tasks run in the **request view** page, which contains high-level details of the tasks.
- The task information is displayed in the **Requests** page, for the AARI User to verify.
- The AARI User can view their requests on the **Requests** page. They can manage or sort their existing requests by using a filter.
- A request can be created by either a user or a bot on the **Edit Process** page. If the request is created by a user, the process is displayed on the **Processes** page. If the request is created through a bot, the user cannot create a request or view the process.

## Reference ID properties

The reference ID is a unique key reference that help you identify your related processes and requests. The reference ID is also different for teams, process, and bots.

### Overview

The main objective of the reference ID is to help the user quickly identify all associated processes and the number of requests created from a process.

#### Requests

A reference ID is created from a **Process key**, a unique text input, that a user can enter when they edit their process. When the user configures their process key, it creates a prefix that corresponds to their process.

#### Key enhancements:

- The **Reference** column in the **Requests** page shows the numbers of reference ID (e.g. **2-42, 98-10, MAIN-5**).
- The **Process key** and number of request iterations helps the user identify the sequential consistency among the number of requests for a given process (e.g. A **Finance** process with the **FIN** process key and number of new requests shows **FIN-1, FIN-2, FIN-3, FIN-10**).

#### URL enhancements:

- The **Requests** URL is now changed to `entity/ref/:ref` from `entity/:id`.
- You can access requests directly when you enter the **reference ID** (ex: `/aari/#/requests/all#/requests/ref/2-34`).
- If the user opens any request using **Request ID**, the URL now redirects using **Reference**. For example, consider the **Request ID** as 896 and **Reference** as 2-34 for a request. If the user views the request using the **Request ID** (`/aari/#/requests/all#/requests/896`), the URL will redirect using the **Reference** (`/aari/#/requests/all#/requests/2-34`).

#### Scenario - Create a process key to view reference ID

1. You edit a **Beta** process to create a **Process key** called **ALPHA**.
2. You create multiple requests from **Beta** process.
3. For each requests created from the **Beta** process, the **ALPHA** process key will iterate one time.
4. You access the **Requests** page and view the **Reference** column.

5. The **Reference** column shows **ALPHA-1, ALPHA-2, ALPHA-3**, this is the **reference ID**.
6. You can now view the **reference ID** for all related processes.

Bot/Process/Team

For **Bot, Process, and Team**, the function is different compared to **Request**. The **request ID** from a previous environment is now replaced by the **reference ID**, this is to improve the single tenant experience by making a logical sequence to a referential number.

URL enhancements:

- The **Edit Process** page now shows an updated URL (ex: `/aari/#/manage/process/ref/96`) where the user can directly access a process when they enter the **reference ID**.
- The **Edit Team** page now shows an updated URL (ex: `/aari/#/manage/team/ref/123`) where the user can directly access a team when they enter the **reference ID**.

## Update changes in Automation Co-Pilot for Business Users from Automation 360 v.21 or later versions

From version Automation 360 v.21 or later, there is a change in how the teams work in Automation Co-Pilot for Business Users on the web interface. Advanced team management now helps business managers define how a request can be created. They can also specify who can view or delete requests.

To ensure that there is no discontinuity in the existing behavior for users who had any access to a process or created requests from a process (regardless of existing team assignment), the following conditions should be maintained:

- The user access to create a request for a specific process is retained.
- The user access to view the requests from a process regardless of the team they were part of is also retained.

### How existing teams are changed

To maintain the current access to processes and the current teams, the existing teams remain with the following:

- Existing process assigned to them.
- Same members assigned to the team.
- The team type is configured to shared. This ensures that all the members of the team can view the migrated processes and requests.
- Members of the team have one of the following team roles:
  - AARI Manager or AARI Admin has the admin role
  - AARI User has the member role

To maintain the current access to requests, new teams are created for each process and the new team has the following:

- Existing processes assigned to the team are named "Teams Migrated for Process X" where X is the process ID. This helps reference the migrated processes. Teams are created for existing processes with this name.
- Users who had access to the process previously are assigned to this team regardless of their existing team assignment, and the team is assigned to the process.
- The team type is configured to shared.
- Members of the team have one of the following team roles:
  - AARI Admin
  - AARI Manager
  - AARI User

Previously, the AARI Manager could create requests without assigning the processes to teams. After the update, they must create teams and ask the AARI Admin to assign their team to a process in order to create new requests.

---

**Important:** After the migration process and the creation of the migrated team, in the request creation, there will be two processes (one for each team) for you to select. The two processes will have different behaviors for the request visibility.

---

## Example

The following scenario helps illustrate how the update works.

Consider a process named **Loan Closing** with process ID **47**. Georges has an AARI Admin role in the Control Room.

Before Update

Two teams HR and IT have access to the **Loan Closing** process and the team structure is as mentioned in the table below.

HR		IT	
User Name	Control Room Role	User Name	Control Room Role
Bob	AARI Manager	Grace	AARI Manager
Carol	AARI User	Steve	AARI User
Debby	AARI User	Debby	AARI User

The behavior before the update is as given below:

- Users from the HR team can see requests created in the IT team and vice versa.
- Bob and Grace can assign the processes that have been previously assigned to them by Georges to the HR and IT team respectively.
- Bob can manage the HR team and similarly, Grace can manage the IT team such as add members, assign processes, rename the team, so on.

After update

The two initial teams (HR and IT) still remain and additionally one new team (named **Team Migrated** for Process **47**) is created during the update. The team structure of all the three teams are mentioned in the table below:

HR			IT			Team Migrated for Process 47		
User Name	Team Role	Control Room Role	User Name	Team Role	Control Room Role	User Name	Team Role	Control Room Role
Bob	Admin	AARI Manager	Grace	Admin	AARI Manager	Bob	Admin	Automation Co-Pilot manager
Carol	Member	AARI User	Steve	Member	AARI User	Carol	Member	Automation Co-Pilot user
Debby	Member	AARI User	Debby	Member	AARI User	Debby	Member	Automation Co-Pilot user
					AARI User	Grace	Admin	Automation Co-Pilot manager
						Steve	Member	Automation Co-Pilot user

The behavior of the teams after the update is as given below:

- Members from the HR team cannot see the requests created in the IT team and vice versa anymore.
- As Debby is a part of both HR and IT team, this user can create requests in both the teams. Two different process cards are displayed to the user during request creation.
- Old requests created inside the HR and IT teams are treated like they were created inside the common team named Team Migrated for Process 47 which has only the Loan Closing process (47) assigned to it.
- Members from both HR and IT teams are all part of Team Migrated for Process 47 and so they can access the old requests. Deleting the team Team Migrated for Process 47 deletes the requests associated with it, so old requests access is removed and cannot be restored.
- Members from HR or IT team can create requests inside the team Migrated for Process 47 and those requests are visible to all the members of the HR and IT team.
- Bob and Grace can manage the HR and IT team respectively as well as jointly manage the Team Migrated for Process 47. This means they can add members to the team, rename the team, remove members from the team, so on.
- Bob and Grace can now only view the processes assigned to their teams by Georges.

**Important:** During the update, issues with team admin assignment might occur intermittently, whereby either the creator of the team is incorrectly assigned the member role instead of the team admin role or other team members are assigned the team admin role instead of the member role. After the update, the AARI Admin must always verify the team admin assignment.

The following example explains the team admin assignment issue:

Before update: Bob creates the HR team and has the AARI Manager role, with Carol, Debby, Grace, and Steve as team members and having AARI User roles.

After update: Bob is assigned the team admin role along with Carol. Debby, Grace, and Steve are assigned the team member roles. In this case, Carol is incorrectly assigned the admin role instead of the member role. The AARI Admin must verify the team admin assignment and change Carol's role to team member.

---

## Create a request and complete a task

An AARI User can create a new request from processes that is their team is assigned to, enter required information in an initial form, and complete tasks.

Ensure you have completed the following:

- Provided a system-created **AAE\_Robotic\_Interface User** role for the AARI User.
- Assigned the AARI license.
- Have access to Automation Co-Pilot.

**1.** Log in to Automation Co-Pilot as an AARI User.

As an AARI User, you are now assigned to a team with an owner or member team role, created by the AARI Manager or AARI Admin.

**2.** Navigate to the **Processes** page.

This page shows all available processes that your team was assigned to by the AARI Admin.

**3.** Select an assigned process.

The initial form appears and shows the required fields for you to complete. These fields are from supported interactive form elements.

---

**Important:** Processes now includes team names associated to the process that the team is assigned to. The **Team Migrated For Process** team name indicates that the process is available to team members who had previous access to that process, regardless of team assignment, before the Automation 360 upgrade.

---

**4.** Complete the required information to the initial form.

You can also fill your initial forms via the URL parameters that is for your **Date**, **Number**, **Text Box**, and **Time** elements.

**5.** Optional: To view the request in a different tab, select the **Open request in New Tab** option.

**6.** Click **Submit** to confirm the information and progress.

Optionally, you can click **Cancel** to discard your changes.

**7.** View the request view page.

Your process is now running, and you might be prompted to complete pending tasks in the request tabs.

**8.** Complete the required task information in the request tab.

As the bot completes its task, it might prompt you to take over and complete the remaining steps.

**9.** View your request status.

Your request is now completed.

**10.** Navigate to **Requests > All requests** to view all requests created in the team.



11. Optional: Click **Create request** button to create a new request from the **Request** page.

## Delete a request

An AARI User, AARI Manager, or AARI Admin can delete requests that are no longer required. Deleting requests helps clear the memory space. You can also recover a deleted request if necessary.

Ensure you have completed the following:

- Assigned a system-created **AAE\_Robotic\_Interface User** role for the AARI User.
  - OR **AAE\_Robotic\_Interface Manager** for the AARI Manager.
  - OR **AAE\_Robotic\_Interface Admin** role for the AARI Admin.
- For the AARI User, AARI Manager, or AARI Admin:
  - You are assigned the AARI license.
  - You have access to Automation Co-Pilot.

Only requests that are in **Cancelled**, **Failed**, or **Completed** status can be deleted.

Open requests can be deleted if they are part of a public process by changing the process settings.

The screenshot shows the AARI interface with the 'Edit Process' settings for '4 - employee\_register'. The 'Request creation' section has 'by user' checked and 'by bot' unchecked. The 'Request retention' section shows 'Number of days before a completed request is moved from Request List to Recycle Bin' set to 'Disabled' and 'Number of days before request is deleted from Recycle Bin' set to 'Custom' with a value of '30'. A yellow highlight is on the checkbox 'Allow Open Requests to be moved to the Recycle Bin'.

- An AARI Admin can delete any request.

**Note:** The AARI Admin is the only user who can permanently delete requests.

- The AARI Manager can delete requests of the team for which they are the owner.
- The AARI User can delete only the requests they have created.

**Important:** Files that are associated with a process are deleted when the request is deleted or are automatically deleted after 90 days.

1. Log in to Automation Co-Pilot.
2. Navigate to the **Request** tab.
3. From the list of requests, select the request or requests you want to delete and click the delete icon.  
A confirmation message appears to confirm the deletion.
4. Click **Yes, delete** to delete the selected requests.
5. Optional: To recover a deleted request or requests, perform these steps:

- a) Navigate to the **Recycle Bin** tab.
- b) Select the requests you want to recover and click the recover icon.  
A confirmation message appears to confirm recovery of the request.
- c) Click **Yes, recover**.  
The requests are recovered and appear in the **Requests** tab.

## Create a team and assign roles to team members

An AARI Manager is a team admin who can create new teams, add members to their team, and assign new team roles. AARI Admin can also configure a team but does not have a team role.

Ensure you have completed the following:

- Provided a system-created **AAE\_Robotic\_Interface Manager** role for the AARI Manager.

---

**Note:** In addition, the AARI Manager requires the AARI license.

---

- Provided a system-created **AAE\_Robotic\_Interface Admin** role for the AARI Admin.
  - Have access to Automation Co-Pilot.
1. Log in to Automation Co-Pilot as an AARI Manager or AARI Admin.
  2. Navigate to **Manage > Team**.  
The **Team** page enables you to view all of your teams and provides the option to create a new team.
  3. Click **Create new team**.  
A **Create new team** window prompts to enter the team details.
  4. Enter a team name in the **Team Name** field.
  5. Optional: Enter a description in the **Description** field.
  6. Select a user from the drop-down in the **Team admin** field.
  7. In the **Request Visibility** field in the **General** tab, select **Shared** or **Private**.  
If you select the **Shared** option, then all the requests that are created are accessible to members of the team. If you select the **Private** option, then a request will be available only to the member who created that request and the owners and admins of the team.
  8. Add members to the team by choosing one of the following options:

Option	Steps
Users	<p><b>a)</b> Click the <b>+</b> (plus) icon. The <b>Add members</b> window appears. Use it to search for members to add.</p> <p><b>b)</b> Search by using name, email, username, or role in the search bar.</p> <p><b>c)</b> Select the member from the displayed list.</p> <p><b>d)</b> Click <b>Add &amp; save</b>. Members are now successfully added to the team.</p> <hr/> <p><b>e)</b> <b>Optional:</b> To remove a team member, select the member and click the <b>trash</b> icon.</p> <hr/> <p><b>f)</b> Navigate to <b>Roles</b> next to each member name. Each member's team role is set to <b>Member</b>, by default.</p> <p><b>g)</b> Click <b>Member</b> to change the team role when applicable.</p> <p><b>h)</b> Select <b>Member, Owner, or Admin</b> to designate the team role.</p> <hr/> <p><b>Important:</b> A team must have at least one <b>Admin</b> as a member. Only the Automation Co-Pilot manager can be assigned the <b>Admin</b> team role because the roles are based on the Control Room roles assigned to the user. A team, however, can have more than one admin.</p> <hr/>
Roles	<p><b>a)</b> Click the <b>+</b> (plus) icon. The <b>Add roles</b> window appears. Use it to search for roles to add.</p> <p><b>b)</b> Search for a role in the search bar.</p> <p><b>c)</b> Select the role from the displayed list.</p> <p><b>d)</b> Click <b>Add &amp; save</b>. Roles are now successfully added to the team.</p> <hr/> <p><b>e)</b> <b>Optional:</b> To remove a role, select the role and click the <b>trash</b> icon.</p> <hr/>

9. Optional: Click the **Processes** or **Bots** tabs respectively to view the assigned processes or bots.
10. Click **Close**.
11. Optional: To edit an existing team, click the team's name in **Team** column within **Team Setup** page.  
The AARI Manager or AARI Admin can edit a team to update their team setup or click **Delete** to erase the team entirely.

See, [Users and team roles for Automation Co-Pilot](#) on page 3408

## Assign a team to a process

An AARI Admin can configure processes in the web interface and assign teams to a process for request creation. They access the web interface to view and manage processes in the **Process Setup** page.

Ensure you have completed the following:

- Provided a system-created **AAE\_Robotic\_Interface Admin** role for the AARI Admin.
- Have access to Automation Co-Pilot.

As an Automation Co-Pilot admin, their key function is to assign teams to a process.

1. Log in to Automation Co-Pilot as an AARI Admin.
2. Navigate to **Manage > Process setup**  
The **Process Setup** page enables the AARI Admin to view all of the check-in processes from the Control Room and assign teams to a process.
3. Click on a process.  
An **Edit Process** window appears and shows related information about the process such as the process name, description, tags, and teams.
4. Edit the **Process name** field if necessary.
5. Optional: Enter a description in the **Description** field.
6. If no tags exist, input any tag name in the **Tags** field to attribute tags to the process.  
Follow steps 7 and 8 to add existing tags, or you can skip to step 9.
7. Search for a tag description in the search bar.
8. Click **Add** as a new tag.  
A new tag will be added.
9. Select the scheduler user from the drop-down menu in the **Scheduler** field.

---

**Note:** The **Global scheduler** option is selected by default if a scheduler is not set for any process.

---

10. Select the **by user** (default) or **by bot** options in the **Request creation** field.
- 

**Important:** If the **by user** option is selected, then processes are visible in the **Processes** page for all AARI Users (owners or members of team). If the **by bot** option is selected, then the request is created by a bot or another process using the **Process Task** in the **Process Composer**. A team must be selected in the **Default team to take the bot created request** field, for requests to be created by that team.

---

11. Click the **+** (plus) icon to add teams to the process.  
The **Add teams** window appears to search for teams to add.
12. Search for a team in the search bar.
13. Click on their name to confirm the team.
14. Click **Add**.  
Team are now successfully added to the process.
15. Optional: To remove a team, click the **trash** icon next to the team name.
16. Click **Save**.

## Bot setup for Bot Runner users

The AARI Admin can manage and assign bots to a team of attended Bot Runner users, for them to view bots in the Automation Co-Pilot Desktop Assistant.

The main purpose of this feature is to improve the bot assignment for attended Bot Runner users, to enable them to access only the bots that are assigned to their team by an AARI Admin.

This helps control which users can view or use a bot. However, if an attended Bot Runner user is not part of any team, they will be able to view and access all bots in Automation Co-Pilot Desktop Assistant.

For the AARI Admin to assign a team of attended Bot Runner users to a bot, they must have view permissions on folders containing the bot.

- The AARI Admin can access the **Bot Setup** page in the web interface to view all bots and assign them to a team. They can also assign multiple teams to a bot or remove teams from bots entirely.
- When new bots are added to this page, the bots can be assigned to a team of attended Bot Runner users.
- The attended Bot Runner users can view their assigned bots in Automation Co-Pilot Desktop Assistant.
- The attended Bot Runner user must have a role with access to the public folder where the bot resides.

## Assign or unassign a task

The AARI Manager and AARI User can assign specific tasks to their team. They can also unassign tasks.

Ensure you have completed the following:

- Provided a system-created **AAE\_Robotic\_Interface Manager** role for the AARI Manager.
- Provided a system-created **AAE\_Robotic\_Interface User** role for the AARI User.
- Have access to Automation Co-Pilot.

AARI Manager can assign tasks to all members who have access to a process. AARI User can assign tasks to other users in the same team. Both can unassign tasks.

1. Log in to the Automation Co-Pilot as an AARI Manager.
2. Navigate to the **Tasks** tab.
3. Select a task from the list.
4. Navigate to
  - **Unassigned**  
Tasks are unassigned by default.
  - **Assign to me**  
This option assigns the task to the current user.
5. Select the user.  
The task is now assigned.
6. Optional: Select **Unassigned**.

The task is now unassigned.

## View and search for a process

AARI User can view, pin, or search their assigned processes.

Ensure you have completed the following:

- Provided a system-created **AAE\_Robotic\_Interface User** role for the AARI User.
- You are assigned the AARI license.
- You have access to Automation Co-Pilot.

1. Log in to Automation Co-Pilot as an AARI User.
2. Click **Create request** from the home page and choose from these options:

Option	Steps
View a process	View your assigned process in the <b>Select a process</b> window.  <b>Important:</b> A list of processes is available in the <b>All</b> tab by default and are assigned to your team by the manager.
View a pinned process	<ol style="list-style-type: none"> <li>a) Click the <b>pin</b> icon.</li> <li>b) Navigate to the <b>Pinned</b> tab.</li> <li>c) View your pinned process.</li> </ol>
Search for a process	<ol style="list-style-type: none"> <li>a) Click <b>Create request</b> from the home page.</li> <li>b) Navigate to the search bar.</li> <li>c) Enter your keyword.  The search bar dynamically searches your processes for common keywords. You can also search for tags.</li> <li>d) View the searched process.</li> </ol>

## Filter and search for a request

When an AARI User has created many requests, they can quickly search for a specific request in the **Requests** page.

Ensure you have completed the following:

- Provided a system-created **AAE\_Robotic\_Interface User** role for the AARI User.
- You are assigned the AARI license.
- You have access to Automation Co-Pilot.

Follow these steps to quickly search or filter your requests:

1. Log in to the web interface as an AARI User.

You are now in your home page, where you can view your requests.

2. Navigate to the **Requests** page and choose from these options:

Option	Steps
Sort	<p><b>a)</b> Click on a column.</p> <p>You can choose from: <b>Status, Reference, Process, Team, Request title Created , Updated or Tags.</b></p> <p>The column is sorted to ascending order by default.</p> <p><b>b)</b> Optional: Click the same column again.</p> <p>The column is now sorted to descending order.</p> <p><b>c)</b> View your sorted requests.</p>
Search	<p><b>a)</b> Click <b>Status</b> (set by default).</p> <p>You can search by <b>Request title, Reference, Process, Tags, Data Privacy Tags</b> (Automation Co-Pilot Admin only), and <b>Team</b> .</p> <p><b>b)</b> Search for your request.</p> <p>The search bar dynamically searches for common keywords.</p> <ul style="list-style-type: none"> <li>• Enter the title in the <b>Request title</b> field.</li> <li>• Enter the reference key in the <b>Reference</b> field.</li> <li>• Enter a process name in the <b>Process</b> field.</li> <li>• Enter a tag name in the <b>Tags</b> field.</li> <li>• Enter a team name in the <b>Team</b> field.</li> <li>• Optional: Enter the query in the <b>Data Privacy tag</b> field.</li> </ul> <hr/> <p><b>Note:</b> This option is available only for the Automation Co-Pilot admin. The admin can update the field and manage any information about data privacy.</p> <hr/> <p><b>c)</b> Optional: Click <b>x</b> to clear searched keywords.</p> <p><b>d)</b> View the searched requests.</p>



Option	Steps
Filter	<p><b>a)</b> Click <b>Status</b> (set by default). You can filter by selecting from the drop-down menu.</p> <p><b>b)</b> Select from the drop-down menu. You can choose from <b>Completed, Failed, Cancelled,</b> and <b>Open</b>.</p> <p><b>c)</b> Optional: Click <b>x</b> to clear filtered keywords.</p> <p><b>d)</b> View your filtered requests.</p>
Date	<p><b>a)</b> Select <b>Created date</b> or <b>Updated date</b> field. The date range window appears.</p> <p><b>b)</b> Select the current date or specify any dates in the <b>From</b> and <b>To</b> fields.</p> <p><b>c)</b> Click <b>Submit</b>.</p> <p><b>d)</b> View your requests by the creation or modified dates.</p>

## Filter and search for a task

When an AARI User has created many tasks, they can quickly search for a specific task in the **Tasks** page.

Ensure you have completed the following:

- Provided a system-created **AAE\_Robotic\_Interface User** role for the AARI User .
- Assigned the AARI license.
- Have access to Automation Co-Pilot.

Follow these steps to quickly search or filter your tasks:

- 1.** Log in to Automation Co-Pilot as an AARI User.  
You are now in your home page, where you can view your tasks.
- 2.** Navigate to the **Tasks** page and choose from these options:

Option	Steps
Sort	<p><b>a)</b> Click on a column.</p> <p>You can choose from: <b>Status, Task Name, Assignee, Team, Request title, Reference, Task Created , Task Updated</b> .</p> <p>The column is sorted to ascending order by default.</p> <p><b>b)</b> Optional: Click the same column again.</p> <p>The column is now sorted to descending order by default.</p> <p><b>c)</b> View your sorted tasks.</p>
Search	<p><b>a)</b> Click <b>Status</b> (set by default).</p> <p>You can search by <b>Task Name, Request title, Reference, Data Privacy Tags</b> (AARI Admin only), <b>Assignee</b> , and <b>Team</b> .</p> <p><b>b)</b> Search for your task.</p> <p>The search bar dynamically searches for common keywords.</p> <ul style="list-style-type: none"> <li>• Enter a task name in the <b>Task Name</b> field</li> <li>• Enter the title in the <b>Request title</b> field.</li> <li>• Enter the reference key in the <b>Reference</b> field.</li> <li>• Enter an assignee name in the <b>Assignee</b> field.</li> <li>• Enter the team name in the <b>Team</b> field.</li> <li>• Optional: Enter the query in the <b>Data Privacy tag</b> field.</li> </ul> <hr/> <p><b>Note:</b> This option is available only for the AARI Admin. The admin can update the field and manage any information about data privacy.</p> <hr/> <p><b>c)</b> Optional: Click <b>x</b> to clear searched keywords.</p> <p><b>d)</b> View the searched tasks.</p>

Option	Steps
Date	<ul style="list-style-type: none"><li>a) Select <b>Created date</b> or <b>Updated date</b> field. The date range window appears.</li><li>b) Select the current date or specify any dates in the <b>From</b> and <b>To</b> fields.</li><li>c) Click <b>Submit</b>.</li><li>d) View your tasks by the creation or modified dates.</li></ul>
Preset filters in Table view	<ul style="list-style-type: none"><li>a) Navigate to the <b>Table view</b> tab (set by default)</li><li>b) Click <b>My Completed tasks</b>, <b>My Pending tasks</b>, or <b>Unassigned tasks</b>.</li><li>c) View your filtered tasks.</li></ul>
Filter in Table view	<ul style="list-style-type: none"><li>a) Click <b>Status</b> (set by default) or <b>Type</b>.</li><li>b) Select from the drop-down menu. For <b>Status</b>, you can choose from <b>Pending</b> , <b>Cancelled</b>, and <b>Completed</b>. For <b>Type</b>, you can choose from <b>Form</b> and <b>Validation</b>.</li><li>c) View your filtered tasks.</li></ul>

Option	Steps
Filter in Detail view	<p><b>a)</b> Navigate to the <b>Detail view</b> tab.</p> <p><b>b)</b> Click <b>Filter</b>.</p> <p><b>c)</b> In the dedicated filter window that appears, configure your contents from these filter options:</p> <ul style="list-style-type: none"> <li>• Choose a preset filter from <b>My Completed tasks</b>, <b>My Pending tasks</b>, and <b>Unassigned tasks</b>.</li> <li>• Select a date in the <b>Created date</b> or <b>Updated date</b> fields.  You can select the current date or specify any dates in the <b>From</b> and <b>To</b> fields.</li> <li>• Select a status in the <b>Status</b> option.  You can choose <b>Pending</b> , <b>Cancelled</b>, and <b>Completed</b>.</li> <li>• Enter a task name in the <b>Task Name</b> field.</li> <li>• Enter a name in the <b>Request title</b> field.</li> <li>• Enter a name in the <b>Created by</b> field.</li> <li>• Enter the reference key in the <b>Reference</b> field.</li> <li>• Select a type in the <b>Type</b> option.  You can choose <b>Form</b> and <b>Validation</b>.</li> <li>• Enter a name in the <b>Assignee</b> field.</li> <li>• Optional: Enter the query in the <b>Data Privacy tag</b> field.</li> </ul> <hr/> <p><b>Note:</b> This option is available only for the AARI Admin. They can update the field and manage any information about data privacy.</p> <hr/> <p><b>d)</b> In the task list, you can filter your task with more sort options:</p> <ol style="list-style-type: none"> <li><b>1.</b> Click <b>Task Created</b> (set by default).</li> <li><b>2.</b> Select in the <b>Sort By</b> field from <b>Status</b>, <b>Task Name</b>, <b>Reference</b>, <b>Title</b>, and <b>Task Created</b> options.</li> <li><b>3.</b> Select in the <b>Order</b> field from <b>Ascending</b> (set by default) and <b>Descending</b> orders.</li> </ol> <p><b>e)</b> Optional: Click <b>x</b> to clear any custom filter keywords or tags.</p> <p><b>f)</b> View your filtered tasks.</p>

## Configure a bot

This task shows you how to edit a bot to set parameters as well as to manage team members.

1. Log in to Automation Co-Pilot.
2. Navigate to **Manage > Bot**.
3. Click on an available bot.  
This opens the **Edit Bot** page in the **General** tab.
4. Specify a name in the **Bot display name** field.
5. Reference the file name in the **Bot file name** field

---

**Note:** The field is grayed out and cannot be modified as this field is to help you reference the name of this bot file.

---

6. Reference the URI in the **Uri** field

---

**Note:** The field is grayed out and cannot be modified as this field is to help you reference the URI of this bot.

---

7. Optional: Enter a description for your bot.
8. Optional: Select the **Run this bot in virtual window** check box.

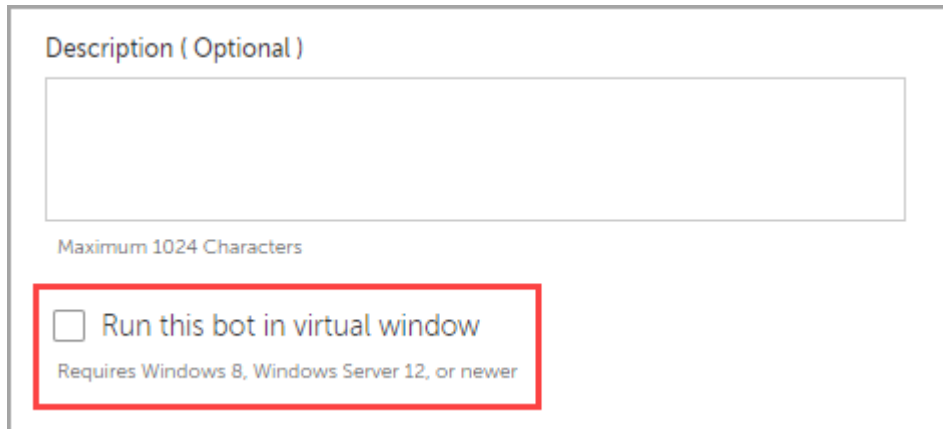

The screenshot shows a configuration form for a bot. It features a text input field labeled "Description (Optional)" with a maximum character limit of 1024. Below this field is a checkbox labeled "Run this bot in virtual window" with a red border around it. Underneath the checkbox, there is a note: "Requires Windows 8, Windows Server 12, or newer".

This option enables the Microsoft Windows child sessions [Picture-in-Picture (PIP)] feature. This feature enables attended users to run bots in Automation Co-Pilot Desktop Assistant on a virtual desktop window, while they continue to work on other applications. For more information on Automation Co-Pilot Desktop Assistant, see [Automation Co-Pilot Desktop Assistant](#) on page 3361.

Attended users can also use the PIP feature to run attended bots from the iFrame widget in their web applications, see [Embed automations in your application using Automation Co-Pilot](#) on page 3298.

---

**Important:** Microsoft Windows 8, Microsoft Windows Server 12, or any of the later versions are required for virtual window. Here are some of the existing limitations of using the PIP feature:

- Another instance of your current browser cannot be used on Windows Desktop and the virtual window at the same time.

For example, if you are using an instance of Google Chrome on your Windows Desktop, the same cannot be used in the virtual window. In order to use Google Chrome in the virtual window, ensure you close this browser on your Desktop.

- When a virtual window is initiated, you might be logged out of your connected Global Protect software. However, the Task Bot will continue to run in the virtual window.
- Applications that allow single log in are restricted to the corresponding main or virtual windows.
- After a bot starts, it runs in the virtual window and is completely independent of the main instance.

- 
9. Optional: Select **Delete bot** to delete this bot.

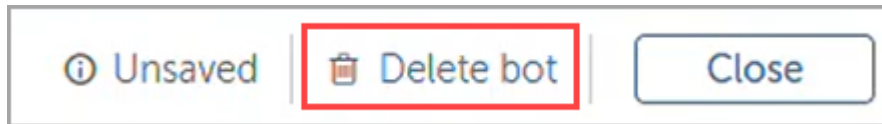

---

**Important:** This option will permanently delete your bot.

---

10. Click on the **Teams** tab.  
This page allows you to manage your team members.
11. Click the **Add (+)** button.  
This **Add Teams** page appears.
12. Select an available team.
13. Click **Add & save** to confirm your choice.  
A team has now been assigned to this bot.
14. Optional: Select a team and click **Delete** (recycle) button to remove a team.
15. Optional: Select the search bar and filter by **Team**, **Description**, and **Request visibility** from **Private** or **Shared**.
16. Click **Close**.  
Your settings are saved automatically.

## Configure a process

This task shows you how to edit a process to create a process key, set a default team, as well as enable the option to delete a process.

1. Log in to Automation Co-Pilot.
2. Navigate to **Manage > Process**.
3. Click on an available process.  
This opens the **Edit Process** page in the **General** tab.
4. Specify a name in the **Process name** field.
5. Specify the description in the **Description** field.
6. Enter a customer key (if applicable) in the **Process key** field.

**Important:** The process key must be one to five characters long and in alphabetical order. The process key can only be defined once, and after when the process key is defined, it cannot be modified later by the user.

7. Add tags to your process in the **Tags** field.  
Tags allow you to filter out automations and display only a subset of automations from the entire list. This will let you call and access only the tagged automations in your embedded widget.
8. In the **Tags** field:
  - a) Click the **Tags** field.
  - b) Specify your tags with unique keywords, such as **Cases** or **Reports**.
  - c) Select the **Add as new option** from the drop-down to add a new tag.  
The keyword will automatically generate a new tag if it does not exist. The search result is displayed in real time.

**Edit Process: 34 - Order Status**

General Teams Deployment

Process name

Order Status

Maximum 255 Characters

Description ( Optional )

Maximum 1024 Characters

Process key ⓘ

Enter 1-5 alphabetical characters. Once saved, the Process Key cannot be changed.

Tags

Cases

No result found. [Add as new tag 5/500](#)

- d) Select an existing tag from the drop-down.

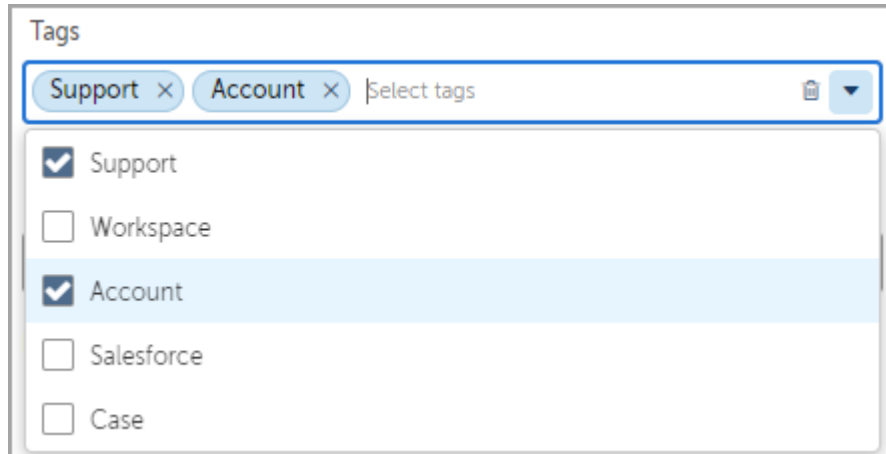

- e) Select the trash bin icon to delete your tags in the field.
- f) If your tags are not listed, you can use the **Search All** option to search for the related keywords.

---

**Note:** Only the AARI Admin can view and create tags.

---

**9.** Specify the team in the **Default team** field.

By default the first team that is added to the process is automatically set as the default team. You can change the team by selecting from the drop-down menu.

**Important:** A default team cannot be deleted from a process. For the admin to remove a default team (e.g. Team 1), they would need to set another team (e.g. Team 2) as the default team, then remove the original team (e.g. Team 1) from the process.

Ex: You can select **Recruitment Director** in the drop-down menu.

**10.** Choose between the **by user** and **by bot** in the **Request creation** field.

**11.** In the **Request retention** field:

- Select **Disabled**, **Immediate**, or **Custom** from the first drop-down menu to specify whether the completed request is moved from the **Request** page to the **Recycle bin**.

For example, you can select **Disabled** to prevent your requests from being moved to the **Recycle bin** or select **Immediate** for all current completed requests to be moved without delay.

**Note:** When you select the **Immediate** option, it can take a maximum time of one hour before the request is moved to the **Recycle bin**.

- Select **Immediate** or **Custom** from the second drop-down menu to specify the number of days when the requests is permanently deleted in the **Recycle bin**.

Ex: You can select the **Custom** option and specify **30** to represents thirty days when the request is deleted in the **Recycle bin**.

- Select the check box option to allow open request to be moved to the **Recycle bin**.

**12.** Click **Close**.

Your settings are saved automatically.



## Understanding the Business user

A business user is typically a non-technical employee who learns to build intelligent automation software bots to handle their workflows. Automation 360 provides business users with accessible, no/low-code, automation tools they can use on their own, every day.

### Overview

Business users help organizations improve business KPIs by automating manual processes across multiple use cases and transforming institutional knowledge into automations. AARI enables these business users to automate and streamline processes with no-code drag-and-drop RPA. With AARI, organizations can:

- Eliminate application switching: Search through multiple systems to find the required information and present all data on a single screen
- Eliminate data and departmental silos: Connect across back and front office systems and users with no/low-code automation
- Scale automation to new use cases Process owners can automate on their own and design how employees should interact with the AARI workflow.

Source: [Automation Anywhere Corporate site \(Business user solution\)](#)

Using AARI, a business user leverages automation built by bot developers (bots, forms, processes) and interact with applications (for example, web, Microsoft Excel, SFDC) that transfer data between group of users and bots, providing an automation service catalog and acting as a request management tool.

Business users can be:

- AARI Admin: act like a Process Owner from business side
- AARI Manager: act like a Team Owner from business side
- AARI User: act like an simple operator from business side

### Tasks and goals of a business user

Tasks	Goals
Daily <ul style="list-style-type: none"> <li>• Select processes and create cases</li> <li>• Follow steps (fill out forms) and escalate issues</li> <li>• Process the assigned documents/tasks</li> </ul>	<ul style="list-style-type: none"> <li>• Efficiently complete daily work by handling large quantity of repetitive tasks</li> <li>• Simplify the daily workflow</li> </ul> Quickly access tools to complete work
Special assignment <ul style="list-style-type: none"> <li>• Record, edit, and submit a workflow process</li> </ul>	

## AARI workflows

- AARI Admin
  1. Task 1
  2. Task 2
  3. Task 3
- AARI Manager
  1. Task 1
  2. Task 2
  3. Task 3
- AARI user
  1. Task 1
  2. Task 2
  3. Task 3

## Approvals in Automation Co-Pilot

The approvals task is a designated process flow that routes notifications and process data to specific users that can quickly address complex and urgent hand-offs.

The approval task offers many advantages.

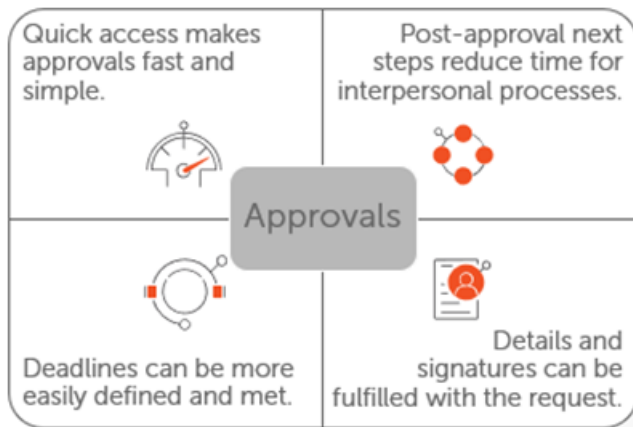

Automation Co-Pilot offers a feature that makes approving tasks simple and direct. The need for approvals applies to many business tasks and with the approval task users can submit and receive approvals, while staying notified of progress, without breaking concentration from streamlined work flow. Likewise, decision making becomes simplified when managers can quickly review the information of a task requested for approval, and they can directly respond with attachments and comments. This human interaction now has a designated space within Automation Co-Pilot and the Process Composer for configuring and automating across applications and roles.

Find the approval task in Process Composer.

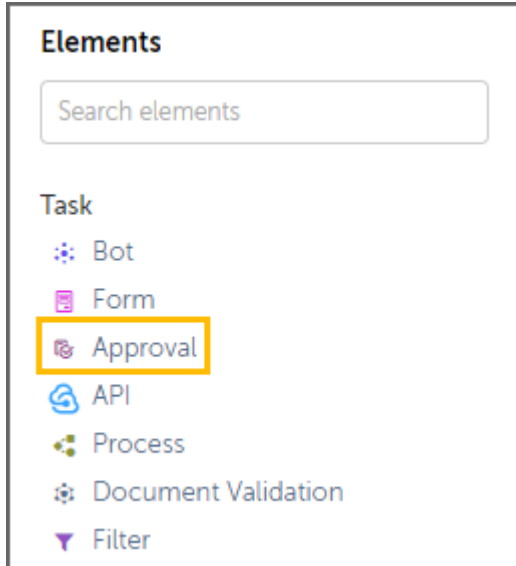



The approval task is a process element that can be added and configured in the Process Composer. This enables functionality in Automation Co-Pilot for business users and decision makers to share information within the automation, improving response time that can otherwise take longer to resolve due to the complex nature of cross-functional decision making.

By running an approval task each team member can leverage their unique role and responsibilities in a single streamlined automated task. This means the experience for approving contributors is tailored to the function of their role, while business users continue their familiar automated experience with the added benefit of immediate updates and details when requests are approved. Consider the relationships for the following personas.

Table 8: Relationships of personas and the approval task

Persona	Experience
	<p>Plan</p> <p>Assign users to roles/teams. Decide on resources used and permissions users have during automation.</p> <ul style="list-style-type: none"> <li>• Configure the resources such as device and runAs in a comprehensive way.</li> <li>• Assign a process to a Role within Control Room.</li> <li>• Assign global values to group variables used inside a process per a role/team basis.</li> </ul>

Persona	Experience
 <p data-bbox="483 457 717 506">Pro Developer</p> <p data-bbox="558 520 643 548">Marcus</p>	<p data-bbox="883 247 967 275">Create</p> <p data-bbox="883 296 1390 359">Create the automated process and configure who receives approval requests.</p> <ul data-bbox="883 373 1398 632" style="list-style-type: none"> <li data-bbox="883 373 1398 436">• Assign group variables to a Human Task inside a process.</li> <li data-bbox="883 443 1398 537">• Select the role or team where a request needs to be created when using the Process package in a bot.</li> <li data-bbox="883 543 1398 632">• Select the role/team where a request needs to be created when using the Process Task.</li> </ul> <p data-bbox="883 667 1406 730"><a href="#">Add Approval Task to a process automation on page 3463</a></p>
 <p data-bbox="483 951 717 999">Business user</p> <p data-bbox="578 1010 623 1037">Bria</p>	<p data-bbox="883 753 984 781">Request</p> <p data-bbox="883 802 1395 896">Runs the task when engaging customers and requests approvals from relevant team members.</p> <p data-bbox="883 911 1382 974"><a href="#">Using and sorting the Tasks view on page 3405</a></p>
 <p data-bbox="483 1291 717 1339">Team manager</p> <p data-bbox="558 1350 643 1377">Tomas</p>	<p data-bbox="883 1073 984 1100">Approve</p> <p data-bbox="883 1121 1354 1148">Approves requests from business users.</p>

## Workflow

The following steps describe the basic workflow to configure an approval task.

1. Create your teams for business tasks. [Create a team and assign roles to team members](#) on page 3387
2. Optionally, add the relevant team to a single Global Value, of variable type user group. [Create a global value](#) on page 2351
3. In Process Composer, configure the approval task in your process using the pre-built user group. [Add Approval Task to a process automation](#) on page 3463
4. Save your changes to the process.

5. Run the approval task in Automation Co-Pilot.

## Using and sorting the Tasks view

Use the task view to filter by status and contributors and find an approval task or reference ID for quick response in Automation Co-Pilot.

The **Tasks view** offers quick reference of the status and contributors for tasks run in Automation Co-Pilot, including the individual reference ID of the process. At a glance, you can check the responses of an approval task, relevant dates and times, and who is contributing or assigned to a task. Click any of the column headers to sort tasks in ascending or descending order based on the data type of the column.

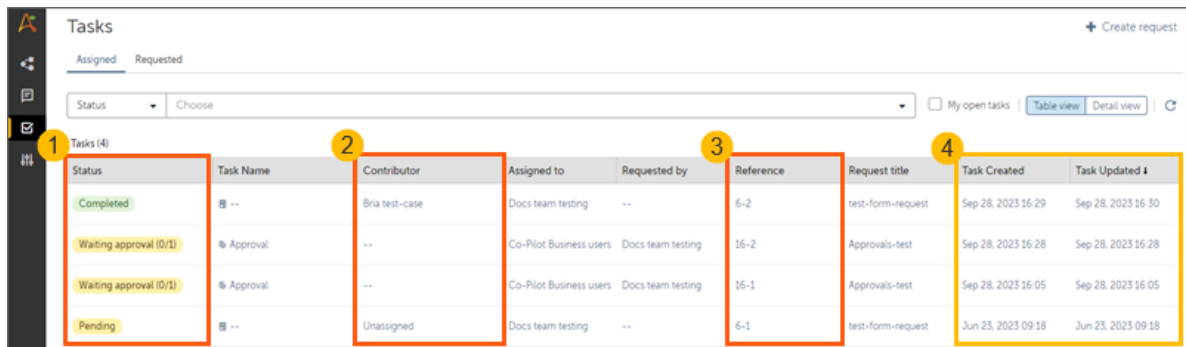

Column	Data	Details
1	Status	View what status the task is in to gauge your response.
2	Contributor	View the user that contributed to the task for further details or follow up.
3	Reference	View the reference ID for identifying specific requests.
4	Create, Updated	View dates and times of tasks

To quickly view your tasks that are open, simply select **My open tasks** and find the task you want to continue working

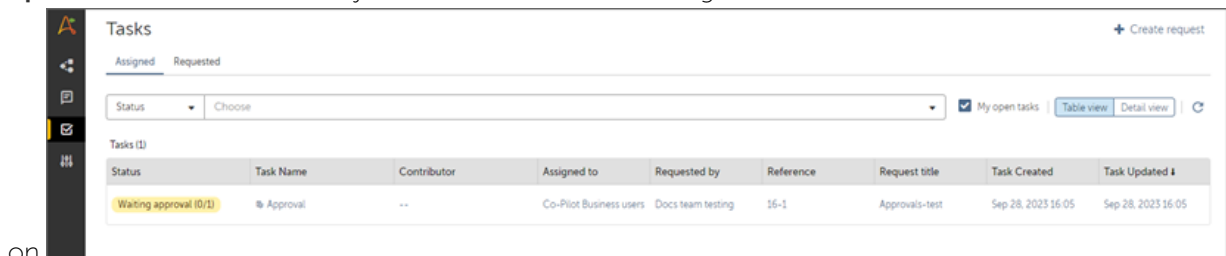

Further details on status and notifications can be found in the following topic. [Automation Co-Pilot status and notifications](#) on page 3406

## Automation Co-Pilot status and notifications

With process event notifications enabled, users are alerted to changes in tasks and requests.

Ensure notifications for process events are turned on to receive the following alerts. [Getting started with Notifications](#) on page 2196

While in Automation Co-Pilot, notifications prompt users to respond to priority events and streamline time-sensitive tasks. These notifications are consumed by Automation Co-Pilot for ease of use. Notifications include a link to the relevant task and display information on the latest event of that task.

The following are examples of the status a task can have in Automation Co-

In-progress task status		In-progress task status	
<b>Pending</b>	<b>Pending</b> Task is pending response by the user (me).	<b>Completed</b>	<b>Completed</b> Task is successfully completed.
<b>In progress</b>	<b>In progress</b> Bot/API task is on going.	<b>Failed</b>	<b>Failed</b> Task is not successfully completed due to Bot/Process error.
<b>Queued</b>	<b>Queued</b> Task is queued up for Bot execution.	<b>Cancelled</b>	<b>Cancelled</b> Task is cancelled by user.
<b>Waiting approval (0/2)</b>	<b>Waiting approval</b> Approval Task is pending response.	<b>Expired</b>	<b>Expired</b> Task is expired due to response timeout.
		<b>Approved</b>	<b>Approved</b> Approval task is approved.
		<b>Declined</b>	<b>Declined</b> Approval task is declined.

Pilot.

The notifications panel groups the alerts by severity. The following are some examples of events and their corresponding severity.

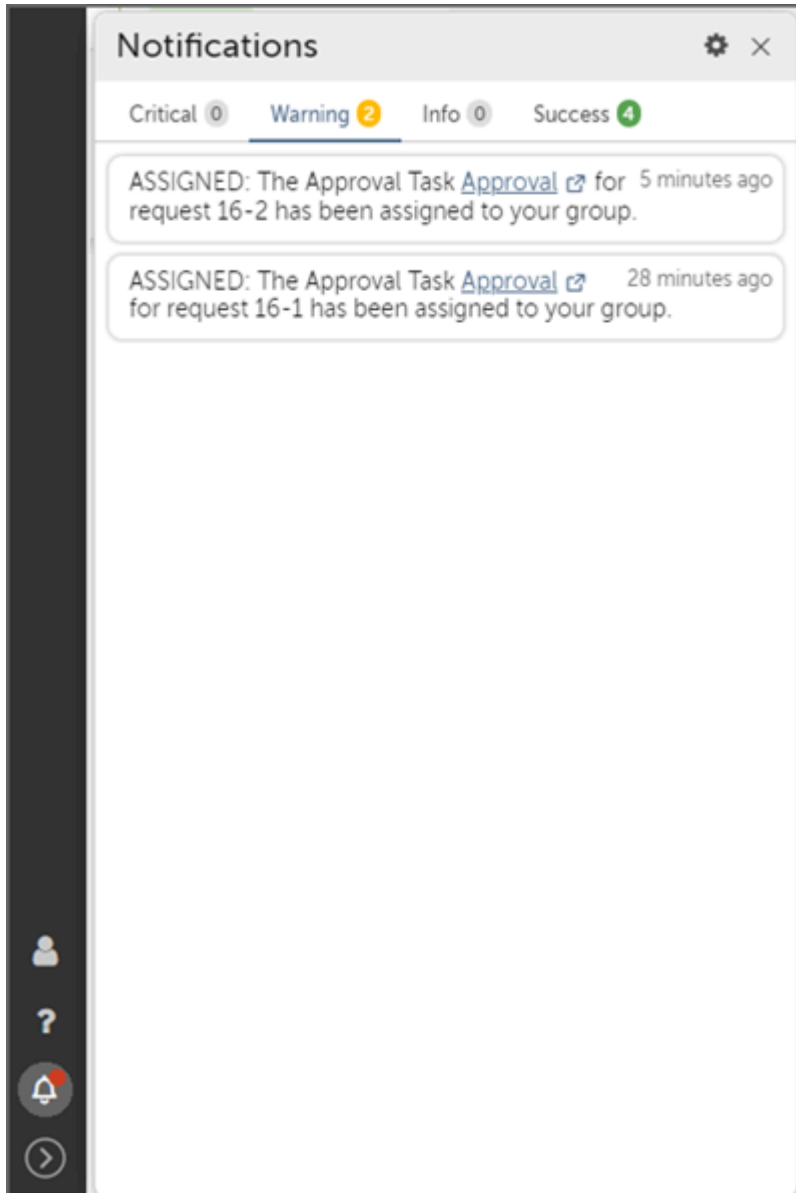

Event	Severity
Queued	Info
Waiting approval	Info
Completed	Success
Assigned	Warning
Failed	Critical

## Users and team roles for Automation Co-Pilot

Users with specific roles and permissions can use different features in Automation Co-Pilot to automate business processes as per requirement.

**Note:** Roles, permissions, and licenses might continue to reference Automation Anywhere Robotic Interface (AARI) within the product.

### Users and their roles

The admin should assign each user with respective roles, permissions and AARI license for Automation Co-Pilot and the product features to run smoothly across devices and business organization. Primary roles involved in this set up are as follows:

- The Control Room Admin creates users and assigns Automation Co-Pilot roles (AARI Admin, AARI Manager, and AARI User) with the AARI licenses.  
[Create users for Automation Co-Pilot](#) on page 3411
- The AARI Admin creates scheduler users and allocate any Control Room resources required to run processes.  
[Configure scheduler user for Automation Co-Pilot](#) on page 3413

There are two main types of users that run Automation Co-Pilot. They can be broadly categorized into developers that build bots and process automations using the Process Composer, and end users that run automations using Automation Co-Pilot.

The following table illustrates the relationship between users, system-created roles, and permissions for accessing Automation Co-Pilot.

Persona	Role	Permissions
 <p>Automation Admin Jake</p>	<b>AAE_Admin</b>	Operates in the Control Room to: <ul style="list-style-type: none"> <li>• Create and manage users.</li> <li>• Assign AARI license to users.</li> <li>• Create and assign roles to users.</li> </ul>
	<b>AAE_Robotic Interface Admin</b>	Operates in Automation Co-Pilot to: <ul style="list-style-type: none"> <li>• Configure scheduler user and allocate Control Room resources (device pool and unattended Bot Runners) to a process in the configuration setup stage.</li> <li>• Perform the following global team and process management tasks in the process deployment stage:               <ul style="list-style-type: none"> <li>• Create, view, and modify all teams.</li> <li>• Assign teams to processes.</li> </ul> </li> </ul>



Persona	Role	Permissions
 <p>Pro Developer</p> <p>Marcus</p>	<b>AAE_Basic</b>	<p>Operates in the Process Composer and Automation Co-Pilot to:</p> <ul style="list-style-type: none"> <li>• Create a process.</li> <li>• Check in a process.</li> <li>• Check out a process.</li> <li>• Run a private process.</li> <li>• Delete a process.</li> <li>• Import a process.</li> <li>• Export a process.</li> </ul>
 <p>Team manager</p> <p>Tomas</p>	<b>AAE_Robotic Interface Manager</b>	<p>Operates in Automation Co-Pilot to:</p> <ul style="list-style-type: none"> <li>• Create and view teams.</li> </ul> <hr/> <p><b>Note:</b> Requires the AARI license.</p> <hr/> <ul style="list-style-type: none"> <li>• Add members to or remove members from the teams.</li> <li>• Assign owners to the teams.</li> <li>• Function as default admin for the teams they create.</li> <li>• Request AARI admin to assign their team to processes.</li> </ul>
 <p>Business user</p> <p>Bria</p>	<b>AAE_Robotic Interface User</b>	<p>Operates in Automation Co-Pilot to:</p> <ul style="list-style-type: none"> <li>• Create and access requests.</li> <li>• Submit and access tasks.</li> </ul>

## Manage roles and teams for Automation Co-Pilot

A variety of permissions are available to grant access to user-created roles and administer Automation Co-Pilot privileges to meet policies for security and organization.

Ensure that you have the **View and manage MY teams** and **View and manage ALL teams** permission (AAE\_Admin) to create and edit respective teams. See, [Create a role](#) on page 1748

## Teams in Automation Co-Pilot

Automation Co-Pilot enforces role-based access control (RBAC). User-created roles can be customized for unique business needs and deliver specific privileges to focus product features on assigned roles.

Unlike system-created roles, administrators can create a role and customize permissions needed for a specific type of user. When creating a role, the following table offers details of the product behavior associated with permissions.

In addition to granting privileges, roles can be used as a group type in Automation Co-Pilot. Consider creating a role to be used as a valid input for a group (to include all users with the role) when assigning teams, tasks, or a process to users. All components of the product recognize the group and behave accordingly.

## Team members and permissions

The following table lists the users, and their roles and permissions in a team.

**Note:** These roles require the AARI license.

Team role	Control Room role	Team type	Permissions
<b>Note:</b> The <b>AAE_Robotic Interface Manager</b> role sets the AARI Manager to automatically have an <b>Admin</b> team role. A license is required.	<b>AAE_Robotic Interface Manager</b>	<b>Shared</b>	<ul style="list-style-type: none"> <li>• Create</li> <li>• View all</li> <li>• Delete all</li> <li>• Assign all</li> <li>• Modify team</li> </ul>
		<b>Private</b>	<ul style="list-style-type: none"> <li>• Create</li> <li>• View all</li> <li>• Delete all</li> <li>• Assign all</li> <li>• Modify team</li> </ul>
Owner	<b>AAE_Robotic Interface User</b>	<b>Shared</b>	<ul style="list-style-type: none"> <li>• Create</li> <li>• View all</li> <li>• Delete all</li> <li>• Assign all</li> </ul>
		<b>Private</b>	<ul style="list-style-type: none"> <li>• Create</li> <li>• View all</li> <li>• Delete all</li> <li>• Assign all</li> </ul>

Team role	Control Room role	Team type	Permissions
Member	<b>AAE_Robotic Interface User</b>	<b>Shared</b>	<ul style="list-style-type: none"> <li>• Create</li> <li>• View all</li> <li>• Delete</li> <li>• Assign all</li> </ul>
		<b>Private</b>	<ul style="list-style-type: none"> <li>• Create</li> <li>• View</li> <li>• Delete</li> <li>• Auto-assign</li> </ul>

## Example

Consider two teams, Finance and HR, and their team roles as listed in the following table:

Finance (private)		HR (shared)	
User	Role	User	Role
User A	Owner	User X	Member
User B	Member	User Y	Member
User C	Member	User Z	Owner

For any process, keep in mind the following:

- User A can view and delete all the requests created inside the team Finance.
- Users B and C can view and delete only their requests inside the team Finance.
- Users X, Y, and Z can view all the requests but can delete only their request inside the team HR.
- User Z can view and delete all the requests created inside the team HR.

See also, [Create a team and assign roles to team members](#) on page 3387

## Create users for Automation Co-Pilot

A Control Room Admin can create users and assign the required system roles for AARI Admin, AARI Manager, and AARI User to use Automation Co-Pilot for business processes.

Ensure that you have purchased the AARI license for your business users.

**Note:** These roles are only applicable for Automation Co-Pilot.

1. From your local machine, log in to your Control Room as administrator.
2. Navigate to **Administration > Users**.
3. Click the **Create user** icon located at the top-right of the **Users** table. The **Create user** page is displayed.

4. In the **General Details** section, enter the following user details:

Enable User	Select this check box to enable the user to log in immediately.
Username	Enter a unique user name.
Description	Optional: Enter a description for the user.
First name	Optional: Enter the first name of the user.
Last name	Optional: Enter the last name of the user.
Password	Enter and confirm a password for the user. Ensure the password adheres to company password policies.
Email	Enter and confirm the email address for the user. If SMTP is enabled, the user is sent an email to this address to confirm the account. Click the URL in the email to log in to the Control Room and set up your credentials. All important Control Room notifications will be sent to this email address.

5. In the **Select Roles** section, you can select any number of roles from the **Available roles** column:

Available role	Select this role
AARI Admin	<b>AAE_Robotic Interface Admin</b>
AARI Manager	<b>AAE_Robotic Interface Manager</b>
AARI User	<b>AAE_Robotic Interface User</b>
User-created	Custom role

6. Click the right arrow to move the role to the **Selected** column.

7. In the **Allocate a device license** section, select the following for the role:

Role	Action
Admin	Retain the default <b>None</b> . The user with the administrator role has access to the Control Room and Automation Co-Pilot.
Manager	Retain the default <b>None</b> for administrative tasks only. Optionally, assign the Automation Co-Pilot user license for this user to create a request, submit tasks, and create and view teams. The user with the manager role has access to Automation Co-Pilot.

Role	Action
User	<p>Assign the AARI license.</p> <p>Optionally, assign the attended Bot Runner license to run local bots or use the desktop interface.</p> <p>The user has access to Automation Co-Pilot.</p>

8. In the AARI licenses section, select the **AARI User** check box.
9. Click **Create user**.  
The new user is displayed in the User table. If SMTP is enabled, an email will be sent to the new user inviting them to log in.

## Configure scheduler user for Automation Co-Pilot

To help deploy automation, you can configure a dedicated user as a scheduler user. A scheduler user can be a **global scheduler** or a **per-process scheduler** that allocates the Control Room resources (devices and unattended Bot Runners) for Automation Co-Pilot.

Key concepts:

- Scheduler user has one scheduler role.
- Scheduler role has 1:many **Run as Users** defined
- Scheduler role is the consumer of 1:many **Device Pool**.

Sequence of deployment

The bot deployment process is determined based on two factors:

- How the scheduler user (**per-process scheduler** or **global scheduler** user) is attached to the team or role assigned to the process.
- Whether device pools have been previously defined.

The following process flow illustrates the priority and effect of a scheduler user and defined device pool on bot deployment.

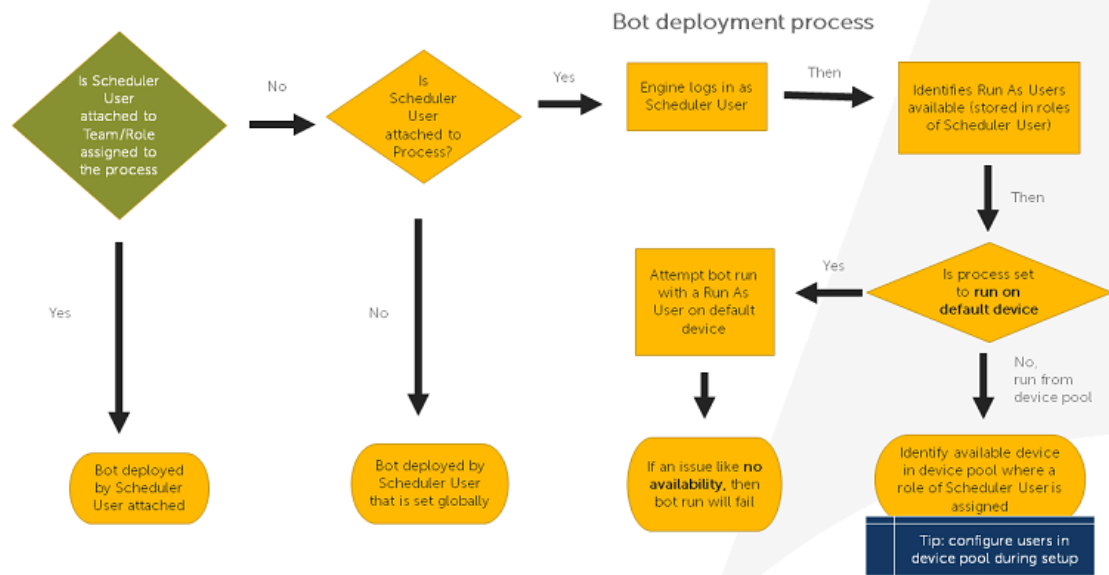

### Update cycles for scheduling

When a scheduler user or device pool is modified, it can take up to ten minutes for the system to use updated configurations in process orchestration. To work around this cycle, users can manually overwrite the cache with new edits to manually update scheduler user configurations.

1. In the CRControl Room, go to **Manage > Process**.
2. From your selected process, click **Edit > Save**.

**Note:** Without this update, users can wait up to ten minutes before running automation with the modified user.

### Establishing a scheduler user

Requires both the following procedures.

- In the Control Room, the AARI Admin must create a designated custom role with a user assigned to that role.

**Note:** The role that you assign to the scheduler user cannot be shared with any other user (such as Bot Runner or an Admin user).

- In Automation Co-Pilot configure the bot or process to be run by the scheduler user.

Complete these steps before attempting to deploy automation using the scheduler user in Automation Co-Pilot.

1. The AARI Admin should create and customize a scheduler role, configured with the **AARI scheduler** permission set, and create a user that is assigned with the scheduler role. Users with this role will be displayed during configurations for scheduling. See, [Create a scheduler user with a role in the Control Room](#).

**Note:** The role that you assign to the scheduler user cannot be shared with any other user (such as Bot Runner or an Admin user).

---

2. If the scheduler user is attached to a process, you can add the scheduler user to a device pool. For more details, click [About device pools](#) on page 1881 and [Create device pools in the Control Room](#).
- 

**Note:** The AARI Admin is the device pool owner and can select a custom role (**AARI-pool-scheduler**) in **Device Pool Consumers**.

---

3. After you have configured a scheduler user and a device pool in the Control Room, you can [assign a scheduler user to a process in the web interface](#) in Automation Co-Pilot.

## Create a scheduler user

Configure a user-created role to run bots as a scheduler user in Automation Co-Pilot.

You must be an AARI Admin to perform this task.

With a scheduler user, bots and processes can be deployed at set times to complete routine tasks.

1. Log in to Control Room as an AARI Admin.
  2. Navigate to **Administration > Roles**.
  3. Create a custom role.  
**AARI-pool-scheduler**  
[Create a role](#) on page 1748.
    - a) Set the permissions to **View my bots, View packages, Run my bots, and AARI Scheduler**.
    - b) In the **Bots** tab, select the folders that contain the bots to be run by the scheduler user, that you want to give access to with run and view permissions. Set the required bot permissions for the role at the folder level.
    - c) Select the unattended users in the **Run As** section.
    - d) Save your changes.
  4. Create a user.  
**AARI-scheduler-user**
- 

**Note:** This user does not require any license.

---

5. Assign the custom role you created to this user.  
**AARI-pool-scheduler**

## Assign a scheduler user to a process

You can configure a scheduler user (team scheduler, per-process scheduler, or global scheduler) to allocate the Control Room resources (devices and unattended Bot Runners) to Automation Co-Pilot. This scheduler user is a dedicated user who helps in process deployment.

Ensure that you have created the scheduler user and the device pool.

1. Log in to Automation Co-Pilot as an AARI Admin.

Alternatively, you can navigate to Automation Co-Pilot through the Control Room by clicking the **settings page** link in the **Manage > Device pools** screen. This will automatically navigate you to the Automation Co-Pilot screen, with you logged in as an AARI Admin.

2. Select a scheduler user by choosing one of the following options:

The process uses the device pool and unattended Bot Runners configured with this user for each bot deployment.

By default, **Global scheduler** is selected if you have not set a **Scheduler** for any process.

By default:

- a) **Team** scheduler user is selected.
- b) **Process** scheduler user is selected if **Team** scheduler user is not defined.
- c) **Global scheduler** user is selected if the **Team** and **Process** scheduler users are not defined

Scheduler Type	Steps
<b>Team</b>	<ul style="list-style-type: none"> <li>a) Navigate to <b>Manage &gt; Process</b>.</li> <li>b) Select the process to configure the scheduler user. The <b>Edit Process</b> page will open.</li> <li>c) Navigate to the <b>Team</b> tab.</li> <li>d) Select a scheduler user from the drop-down menu in the <b>Scheduler</b> field. The <b>Process scheduler</b> is selected by default.</li> <li>e) Click <b>Save</b>.</li> </ul>
<b>Scheduler</b> (per-process scheduler)	<ul style="list-style-type: none"> <li>a) Navigate to <b>Manage &gt; Process</b>.</li> <li>b) Select the process to configure the scheduler user. The <b>Edit Process</b> page will open.</li> <li>c) Navigate to the <b>Deployment</b> tab.</li> <li>d) Select a scheduler user from the drop-down menu in the <b>Process scheduler</b> field. The <b>Global scheduler</b> is selected by default.</li> <li>e) Select the <b>Deployment</b> type.</li> <li>f) Click <b>Close</b>. The setting saves automatically.</li> </ul>



Scheduler Type	Steps
<b>Global scheduler</b>	<p><b>a)</b> Navigate to <b>Manage &gt; Process</b>.</p> <p><b>b)</b> Select the process to configure the scheduler user. The <b>Edit Process</b> page will open.</p> <p><b>c)</b> Navigate to the <b>Deployment</b> tab.</p> <p><b>d)</b> Select the <b>Global scheduler</b> user from the drop-down menu in the <b>Process scheduler</b> field. The <b>Global scheduler</b> is selected by default.</p> <p><b>e)</b> Select the <b>Deployment</b> type.</p> <p><b>f)</b> Click <b>Close</b>. The setting saves automatically.</p>

**Important:** If scheduler users had their role removed or do not have sufficient permissions to access a file:

- a)** The Control Room Admin will see an audit log of the change.
- b)** The AARI Admin will see an error message for an invalid scheduler then must reassign a new scheduler user.
- c)** The AARI User will see an error message for the process.

## Configure deployment type for bots

You can configure the deployment type for your bot tasks. This determines how the bots in the process will be deployed. You can also define the mapping between run-as user and the device.

This mapping will help take care of constraints if any in your organizational set up such as credential constraints requiring one to one mapping between devices and run-as user.

- 1.** Navigate to **Manage > Process**.
- 2.** Select the process.
- 3.** Select the **Deployment** tab.
- 4.** In the **Deployment type** field, select one of the following options:
  - **Prefer default device** - The bot deploys on the default device of the unattended Bot Runner user. If default device is unavailable, the bot deploys on the available device in the device pool. All the unattended Bot Runner users in the scheduler user should either have the same device credentials (user name and password) or the different user name and password credentials that are set in all the devices. If the password is different for each device credential, the user name also differs.

- **Run on pool of device** - The bot deploys on the available device in the device pool. It overrides the default device of the user.
- **Run only on default device** - The bot deploys only on the default device of the user. In this option, the unattended Bot Runner user should own the default device. If the device is jointly owned by the unattended Bot Runner user along with another licensed user, the device is not used as the unattended Bot Runner user is considered to have no default device. If the scheduler user has multiple unattended Bot Runner users and one of those users do not have a default device, the bot deployment fails.

5. Click **Close**.

## Automation Co-Pilot for Automators

Automation Co-Pilot for Automators is a suite of on-demand, generative AI-powered intelligent automation capabilities that allows both citizen and professional developers to build enterprise-grade automations faster and better, thereby making it easier for our customers to scale automation programs and accelerate their Return on automation (ROA).

---

**Note:** Generative AI models can produce errors and/or misrepresent the information they generate. It is advisable to verify the accuracy, reliability, and completeness of the content generated by the AI model.

---

**Important:** This feature will be available with the Cloud rollout for Automation 360 v.31 release.

---

### Overview

Automation Co-Pilot for Automators is built directly into the Automation Success Platform and is available on-demand to both citizen and professional developers to build their automations using the power of generative AI (GenAI).

Automation Co-Pilot for Automators is a comprehensive orchestration framework utilizing multiple GPT models specialized in automation creation. These models serve as agents, capturing pertinent information about ongoing automations and the customer environment. The framework delegates tasks based on the requirements of the customer request, generating personalized automations. To enhance reliability, the models are dynamically grounded with automation tasks, reducing the risk of errors. Additionally, a built-in validation layer ensures adherence to best practices. The system incorporates learning from human feedback to autonomously enhance the quality and completeness of automations over time.

Automation Co-Pilot for Automators has the following capabilities:

Build with natural language:

Describe your automation goals using Build with natural language to transform your ideas into optimized, compliant, and personalized automations accelerating the ROI realization and scaling the automation program. Build automations in the Bot editor and Process Composer.

Suggest next actions:

Suggest next actions, a generative AI-based feature, helps accelerate automation development in an organization to achieve a higher level of productivity and build automations easily. Get real-time suggestions on next steps for your automations in the Bot editor.

## Benefits

Scale automation development: Expand your automation programs by helping Professional Developers and Citizen Developers accelerate automation development and empower business users to build automations with no-code to meet daily business requirements.

Safeguard with governance: Build compliant automation fast with built-in user access controls and compliance checks to ensure you get the right automations that meets your enterprise's governance requirements.

## Licensing requirements

To activate and use Automation Co-Pilot for Automators, you need:

1. A valid license.
2. Bot Creator user with:
  - Role: **AAE\_Basic** and **AAE\_Bot Developer**.
  - Device License: Bot Creator or Citizen Developer.

---

**Important:** For information on how we approach data security, see: [Data security for generative AI - FAQ](#) on page 1081.

---

## About Process Composer

Process Composer is an environment that leverages multiple products across the Automation 360 platform to deliver an Intelligent Automation experience.

Professional and Citizen Developers can use the Process Composer's low-code features to collaborate and build end-to-end process automations. Process Composer displays correct data to the appropriate users and exchanges that data across multiple teams. Using a single, drag-and-drop visual interface, developers can quickly build long-running process automations that combine bots, forms, document processing, integrations, and API Tasks.

## Benefits of Process Composer

Professional and Citizen Developers can:

- Optimize complex workflows: Simplify business operations across departments by automating multi-user, multi-step tasks and approvals.
- Empower employee experience: By transforming end-to-end processes, combine robotic tasks with connecting APIs and can insert humans-in-the-loop where needed.
- Boost operational productivity for the organization: Time between tasks decreases, service level agreements (SLAs) are enforced, and teams are promptly alerted within their application of choice.

## Process Composer components and elements

Process Composer is comprised of three components:

- Process discovery component: You use Process Composer to discover processes, and then learn (reference) from them. An asset generated from [Process Discovery](#) can be a process workflow that gets translated into a process automation in Process Composer.
- Process automation design component: You create and design process automations which link bots and forms together. Additionally, the process automation contains the logic that triggers the bots and forms, and coordinates the flow of data between them. A process automation contains the following elements:
  - Request: A specific instance of a process automation that defines a template of how bots and forms interact.
  - Initial data: Fed into the process typically entered by a user and consumed through a [form](#) as the first step.
  - Sequence of steps in a process automation: Which can contain any of the following process automation elements:
    - Form Task: Completed by users which enable them to invoke and interact with the bots through the customizable web interface.
    - Bot Task: Previously built in the Bot builder and available to select in Process Composer. The bots automate specific, repetitive, and rule-based tasks.
    - API Task: Task that connects to a specified API and retrieves data for the process automation to consume. When invoked from a process automation, API Tasks provide a faster response than a Bot Task when called in the same process automation.
    - Approval Task: Task that alerts a responder to approve shared data.
    - Document Validation: Task that requires document approval.
    - Input, output, and meta variables: Includes shared data in the process automation.
  - Logic conditions: Such as the `If/Else` pair or `Else if` to include internal and conditional branching of the process automation.
  - End states: Closes each request (specific instance of a process automation) with a status such as: completed, failed, or canceled.
- Process automation management component: After you have created a process automation, you can check it in to deploy and make available to other users in the web interface. Additionally, you can import, export, run, delete, and check out process automations.

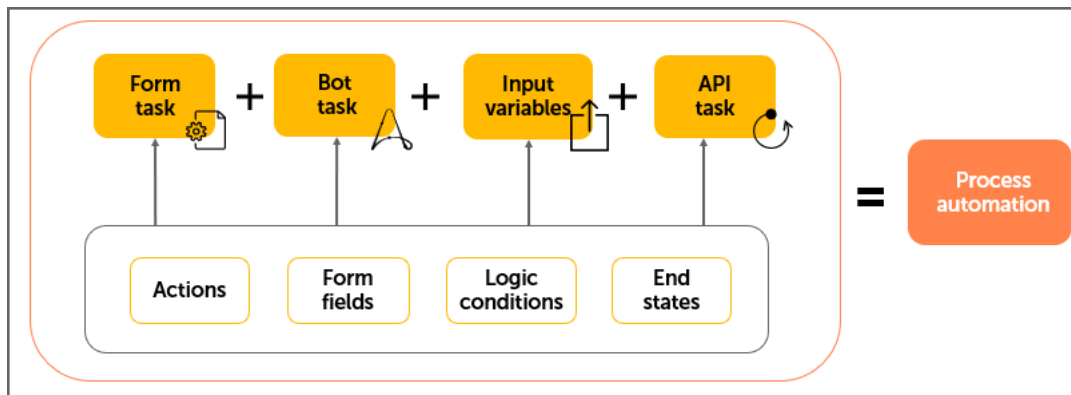

Related concepts

[Users and team roles for Automation Co-Pilot](#) on page 3408

Users with specific roles and permissions can use different features in Automation Co-Pilot to automate business processes as per requirement.

## Process Composer roles and permissions

As an Admin, you can create custom Process Composer roles in the Control Room and set very granular user permissions to fit within any specific organizational security policies. You are not required to use the default system-defined roles provided by applications.

You can define users with specific roles and permissions to use different features in Process Composer and Automation Co-Pilot to automate business processes as per your organization's requirements. For specific roles and permissions related to Automation Co-Pilot, click [Users and team roles for Automation Co-Pilot](#) on page 3408.

Users can be broadly characterized into the following categories:

- Users who access the Automation 360 Control Room to build automation processes in the Process Composer.
- End-users who run automation processes using Automation Co-Pilot for Business Users from the Cloud or desktop.
- The Admin or team manager persona who is responsible for configuring Automation Co-Pilot for Business Users.

As a Control Room Admin, you can create users and assign them the following Process Composer roles and permissions related to tasks, requests, and processes:

Table 9: Process Composer roles and permissions

Role Type	Available Permissions
AAE_Robotic Interface User	User has the ability to: <ul style="list-style-type: none"> <li>• Reassign my group tasks</li> <li>• Delete my requests</li> </ul>
AAE_Robotic Interface Manager	User has the ability to: <ul style="list-style-type: none"> <li>• Reassign my group tasks</li> <li>• Delete my requests               <ul style="list-style-type: none"> <li>• Delete my group requests</li> </ul> </li> </ul>

Role Type	Available Permissions
AAE_Robotic Interface Admin	<p>User has the ability to:</p> <ul style="list-style-type: none"> <li>View and manage all processes</li> <li>View all requests from public processes <ul style="list-style-type: none"> <li>View all requests from public and private processes</li> </ul> </li> <li>Delete my requests <ul style="list-style-type: none"> <li>Delete my group requests</li> <li>Delete all requests</li> </ul> </li> <li>View all tasks from public processes <ul style="list-style-type: none"> <li>View all tasks from public and private processes</li> </ul> </li> <li>Reassign my group tasks <ul style="list-style-type: none"> <li>Reassign all tasks</li> </ul> </li> </ul>

For details on how to create users and configure permissions to access features, see the following:

- [Create a user](#) on page 1739
- [Create a role](#) on page 1748

## Supported behaviors for tasks and elements in Process Composer

Process Composer tasks, logic conditions, and end points support copy, paste, and cut behaviors from the Bot editor. This also includes the ability to double-click and replace items on the canvas.

### Supported behaviors

**Note:** The functionality of these behaviors are the same for both Process Composer and Bot editor with the exception of some specific task types.

Copy	Use <b>CTRL + C</b> to copy data from the task.
Paste	Use <b>CTRL + V</b> to paste copied data in your task.
Cut	Use <b>CTRL + X</b> to copy and remove data from your task.
Double-click to add	Double-click a task to add data to it.

## Copy behavior

When you copy a task or element in the canvas, these behaviors will occur:

Task types	Behavior
<ul style="list-style-type: none"> <li>• Bot Task</li> <li>• Form Task</li> <li>• Filter Task</li> <li>• Document Validation Task</li> <li>• If</li> <li>• Else if</li> <li>• End process</li> <li>• Go to</li> </ul>	Properties are retained in the clipboard.
Else	Task is not retained in the clipboard.

## Paste behavior

When you paste a task or element in the canvas, these behaviors will occur:

Task types	Node selected	Behavior
<ul style="list-style-type: none"> <li>• Bot Task</li> <li>• Form Task</li> <li>• Filter Task</li> <li>• Document Validation Task</li> <li>• If/Else pair</li> </ul>	None	Task is attached to the last node located before the end point ( <b>End process</b> or <b>Go to</b> ).
<ul style="list-style-type: none"> <li>• Bot Task</li> <li>• Form Task</li> <li>• Filter Task</li> <li>• Document Validation Task</li> <li>• If/Else pair</li> </ul>	<ul style="list-style-type: none"> <li>• End process</li> <li>• Go to</li> </ul>	Task is attached to the last node placed before the end point ( <b>End process</b> or <b>Go to</b> ).
<ul style="list-style-type: none"> <li>• Bot Task</li> <li>• Form Task</li> <li>• Filter Task</li> <li>• Document Validation Task</li> <li>• If/Else pair</li> </ul>	<ul style="list-style-type: none"> <li>• Bot Task</li> <li>• Form Task</li> <li>• Filter Task</li> <li>• Document Validation</li> <li>• If</li> <li>• Else if</li> <li>• Else</li> </ul>	Task is attached to the node.

Task types	Node selected	Behavior
<ul style="list-style-type: none"> <li>End process</li> <li>Go to</li> </ul>	<ul style="list-style-type: none"> <li>Bot Task</li> <li>Form Task</li> <li>Filter Task</li> <li>Document Validation</li> <li>If</li> <li>Else if</li> <li>Else</li> <li>None</li> </ul>	Paste is not allowed or disabled.
<ul style="list-style-type: none"> <li>End process</li> <li>Go to</li> </ul>	<ul style="list-style-type: none"> <li>End process</li> <li>Go to</li> </ul>	Task replaces the selected node.
Else if	<ul style="list-style-type: none"> <li>If</li> <li>Else if</li> </ul>	Task is added as a new <b>Else if</b> node in the same line as the <b>If</b> or <b>Else if</b> , and located in the last position before the <b>Else</b> .
Else if	<ul style="list-style-type: none"> <li>Bot Task</li> <li>Form Task</li> <li>Filter Task</li> <li>Document Validation</li> <li>End Process</li> <li>None</li> </ul>	Task is not added to the canvas because this action is invalid.

## Cut behavior

When you cut (remove) a task or element in the canvas, these behaviors will occur:

Task types	Behavior
<ul style="list-style-type: none"> <li>Bot Task</li> <li>Form Task</li> <li>Filter Task</li> <li>Document Validation Task</li> </ul>	Task is removed from the canvas by deletion but the clipboard retains the task with all the properties .
<ul style="list-style-type: none"> <li>If</li> <li>Else if</li> </ul>	Task is removed from the canvas by deletion but the clipboard retains the task with all the properties. All child nodes are deleted from the canvas.
Else	Task is not removed or retained in the clipboard.



Task types	Behavior
<ul style="list-style-type: none"> <li>End process</li> <li>Go to</li> </ul>	Task is removed from the canvas by deletion but the clipboard contains the task with all the properties.

### Double-click to add behaviors

When you double-click a task or element in the canvas to add data to it, these behaviors will occur:

Task types	Node selected	Behavior
<ul style="list-style-type: none"> <li>Bot Task</li> <li>Form Task</li> <li>Filter Task</li> <li>Document Validation Task</li> <li>If/Else pair</li> </ul>	None	Task is attached to the last node located before the end point ( <b>End process</b> or <b>Go to</b> ) of the main branch (farthest left).
<ul style="list-style-type: none"> <li>Bot Task</li> <li>Form Task</li> <li>Filter Task</li> <li>Document Validation Task</li> <li>If/Else pair</li> </ul>	<ul style="list-style-type: none"> <li>End process</li> <li>Go to</li> </ul>	Task is attached to the last node located before the end point ( <b>End process</b> or <b>Go to</b> ).
<ul style="list-style-type: none"> <li>Bot Task</li> <li>Form Task</li> <li>Filter Task</li> <li>Document Validation Task</li> <li>If/Else pair</li> </ul>	<ul style="list-style-type: none"> <li>Bot Task</li> <li>Form Task</li> <li>Filter Task</li> <li>Document Validation</li> <li>If</li> <li>Else if</li> <li>Else</li> </ul>	Task is attached to the selected node.
<ul style="list-style-type: none"> <li>End process</li> <li>Go to</li> </ul>	<ul style="list-style-type: none"> <li>Bot Task</li> <li>Form Task</li> <li>Filter Task</li> <li>Document Validation</li> <li>If</li> <li>Else if</li> <li>Else</li> <li>None</li> </ul>	Double-click is not allowed or disabled.

Task types	Node selected	Behavior
<ul style="list-style-type: none"> <li>End process</li> <li>Go to</li> </ul>	<ul style="list-style-type: none"> <li>End process</li> <li>Go to</li> </ul>	Task replaces the selected node.
Else if	If	Task is added as a new <b>Else if</b> node in the same line as the <b>If</b> or <b>Else if</b> and in the last position before the <b>Else</b> .
Else if	<ul style="list-style-type: none"> <li>Bot Task</li> <li>Form Task</li> <li>Filter Task</li> <li>Document Validation</li> <li>Else if</li> <li>End Process</li> <li>Go to</li> <li>None</li> </ul>	Task is not added to the canvas because this action is invalid.

## Construct URL parameters for supported elements

You can construct URL parameters for the following supported elements: **Date**, **Number**, **Text Box**, and **Time**.

### Supported elements to construct URL parameters

You can call a specific process using its ID and pass parameters through the URL to populate the initial forms based on the form field ID. This population method is also supported for initial forms in the iFrame widget for Automation Co-Pilot for Business Users using the embedded widget.

---

**Note:** The URL value will always overwrite the default value of the form fields.

---

Data format: The following data format is accepted for certain elements:

- The **Text Box**, **Text Area**, and **Rich Text Editor** elements accept the **String** type data.
- The **Number** element accepts the **Double** type data.
- The **Date** and **Time** elements accept the **RFC 8601** date (local time) type data (for example, 2021-06-10T00:00:00.000).
- The **Radio Button** and **Dropdown** elements accept the **String** type data.
- The **Check Box** element accepts the **String** type data.

Parameter Mapping: The following parameter mappings differ for certain elements:

- For the **Text Box**, **Text Area**, and **Rich Text Editor** elements, the **Element ID** shows the value after the element ID becomes the default element or input value. For example:
  - TextBox1=MyValue
  - TextArea2=MyLooooooooooongValue
  - RichTextEditor3=AnUnformattedString

- For the **Number** element, the **Element ID** shows the value after the element ID becomes the default element or input value. For example: `Number2=123.99`.
- For the **Date** and **Time** elements, the **Element ID** shows the value after the element ID becomes the default element or input value. For example:
  - `Date1=2021-06-10T00:00:00.000`
  - `Time0=2021-06-10T23:59:17.000`
- For the **Radio Button** and **Dropdown** elements, the **Element ID** shows the value after the element ID becomes the default element or input value. For example:
  - `RadioButtonGroup3=TheDefaultOption`
  - `Dropdown0=TheDefaultOption`
- For the **Check Box** element, the **Element ID** shows the value after the element ID becomes the default element or input value. For example: `CheckBoxGroup1_1=TheOption2`.

Delimiter: You can use the **&** symbol as a delimiter between parameters.

## Password element behavior

You can use the **Password** element to add password fields to your forms to process in the web interface.

### Element behavior

To use in the web interface, the **Password** element has the following specific behaviors:

- The value of the password field is encrypted when a user submits a form (initial form or as part of a **Form Task**).
- When another user accesses the same form after submission (read-only view of initial form or **Form Task**), they cannot view the password field because it is encrypted.
- Since the password field values are encrypted, you cannot use them in the **If/Else** condition of a process automation.
- Only the encrypted password field values are stored in the database; the decrypted values are not stored.
- When you pass the encrypted password field value through a credential variable input to a bot inside the process automation, the encrypted password field value is decrypted by the bot during deployment by using an instantaneous key from the credential vault. No other configuration is required.

When you create a form and use this password element, the element is similar to the **Text Box** element except that your text inputs in these fields are now masked.

The **Password** element contains these key form properties:

- **Element ID**
  - This field can be edited or overwritten by the user who created the form.
  - The field takes a unique default value (for example, the default value could be **password1**).

---

**Note:** The Bot Creator can reference this field for internal use.

---

- **Element label**

- This field can be edited or overwritten by the user who created the form.
- You can set a default label (for example, **Password**).
- You have the option to make password fields required or read only.

## Conditional actions, rules, and elements

Using rules, you can add conditional actions, such as **If**, **And/Or**, and **Then** to various elements in a form.

For the **Checkbox** and **Radio Button** elements, the rules are triggered only if the corresponding presets are selected. For example, if a form has two mutually exclusive options, such as **Yes** and **No**, the rules associated with these options are triggered only if you select one of the two options.



**Attention:** Rules are not supported for the following elements:

- Dynamic Area
- Hyperlink
- Image
- Select file
- Select folder
- Snapshot
- Table

---

**Note:** The change label action in the form rules now applies to the **Button** element. This form rules will automatically apply to the button where you set the rules. The rules editor is now applicable to the **Table** element. The rules editor and conditions applies for each individual columns while any actions you set are applied for each row in the row level.

---

Consider a scenario where you are creating a user sign in/registration form. You can add a rule to one of the form elements to enable an option to sign in as an existing user or register a first time user.

1. On the left pane, click **Automation**.  
A list of available and forms is displayed.
2. Click **Create new > Form**.
3. In the **Create form** page, enter a name for the new form.  
Forms are saved in the `\Bots\` folder by default. (Optional) Click **Choose** to change the default folder.
4. Click **Create & edit**.
5. Drag the following elements into the form:
  - **Dropdown:** In the **Element label** field, enter 'Select user type' and in the **Add dropdown content** field, add 'Existing user' and 'New user'.
  - **Text Box:** Add two elements and name them 'User name' and 'Register'.
  - **Password:** Add one element.
  - **Button:** Add two elements and name them 'Save' and 'Cancel'.
6. On the right pane, click **Form rules > Add rule**.  
You can use this option to add rules to the form elements. In this scenario, add two rules.

**7.** For **Rule1**, update the following fields:

Rule 1 is applied when an existing user tries to sign in. If the user clicks **Select user type > Existing user**, the **Register** text box is made unavailable. Use the **If** menu to set the following conditions:

- a) **Select user type** as the element condition in the first drop-down menu
- b) **Choice is** in the second drop-down menu
- c) **Existing user** in the third drop-down menu

---

**Note:** The **If** conditions are supported on the following elements:

- **Dropdown**
- **Checkbox**
- **Radio Button**
- **Date**
- **Time**
- **Hyperlink**

---

Use the **Then** menu to set the corresponding actions:

- a) The **Register** text box in the first drop-down menu

All the available elements in the form on which the rules are supported are listed in this field. For the **Dropdown** element in the **Then** menu, you can use the **Assign** option to append or overwrite values at bot runtime.

- b) **Disable** in the second drop-down menu

**8.**

On **Rule1**, click the vertical ellipsis (⋮) for the following options:

- **Add rule below:** Add a new rule below **Rule1**.
- **Duplicate rule:** Add a duplicate of **Rule1**.
- **Delete rule:** Delete **Rule1**.

If you added more than one rule, the following additional options are enabled to toggle the rules:

- **Move up**
- **Move down**
- **Move to top**
- **Move to bottom**

**9.** For **Rule2**, update the following fields:

Rule 2 is applied for a first-time user. If a user clicks **Select user type > New user**, the **User name** and **Password** text boxes are made unavailable. Use the **If** menu to set the following conditions:

- a) **Select user type** as the element condition in the first drop-down menu
- b) **Choice is** in the second drop-down menu
- c) **New user** in the third drop-down menu

Use the **Then** menu to set the corresponding actions:

- a) The **User name** text box in the first drop-down menu
- b) **Disable** in the second drop-down menu
- c) The **Password** text box in the third drop-down menu
- d) **Disable** in the fourth drop-down menu

10. Optional: If you want to interchange the sequence of these two rules, drag **Rule1** below **Rule2** or **Rule2** above **Rule1**.

You can also click the ellipsis (...) next to **Add rules** to select one of the following options:

- **Collapse all**: Collapses the rules. Is enabled only if you have expanded any of the available rules.
- **Expand all**: Expands the rules.

11. Click **Save**.

The new registration form is created and is ready to be linked to a bot.

## Example: Use Checkbox element in a form dynamically

You can use the **Checkbox** element in the form to select multiple options in a form during bot runtime.

You must:

- Have a Bot Creator license.
- Be assigned a custom role with create folder permission.

In this example, you create a process to register new employee details in the company database. The initial form contains basic information such as:

- Name
- ID
- Date of birth
- gender
- location

Additionally, the initial form has only two options (San Jose and Tokyo) for the location field. You will make the location field dynamic during the request creation to be able to add a new location (India) for those employees whose ID falls within the 100 to 200 range.

1. Log in to the Control Room as a Bot Creator user.
2. Create the initial form.  
[Create a form](#) on page 3438.
  - a) On the left plane, select **Automation**.
  - b) Select **Create new > Form**.
  - c) Enter the form name as `employee_register_initial_form`.
  - d) Enter the folder location as `Bots\Employee Registration`.  
To change where your form is stored, select **Choose** and follow the prompts.
  - e) Select **Create & edit**.

- f) Add the following **Elements** and corresponding **Element label** in the form.

Element	Element label
<b>TextBox</b>	Full Name
<b>Number</b>	ID
<b>Date</b>	Date of Joining
<b>Dropdown</b>	Gender

For the **Dropdown** element, enter **Male, Female** in the **Enter list items separated by commas** field.

- g) Select **Save**.
- h) Select **Close**.
3. Create a second form.
- In the same folder location, select **Create new > Form**.
  - Enter the form name as `employee_location`.
  - Select **Create & edit**.
  - Drag the **Checkbox** element into the form.
  - Enter the name in the **Element label** field as `Employee location`.
  - Click the **plus** icon in the **Checkbox content** field and add the locations `San Jose` and `Tokyo`.
  - Select **Save**.
  - Select **Close**.
4. Create a new bot.
- In the same folder location, select **Create new > Bot**.
  - Enter the bot name as `dynamic_checkbox`.
  - Select **Create & edit**.
5. Create the following variables:
- `emp_id`: Number type; use as input
  - `emp_location`: List type, String subtype; use as output; click the **plus** and add two values `San Jose` and `Tokyo`
  - `emp_dyn_location`: String type, add the default value `India`
- The default values are `San Jose` and `Tokyo` however if the employee ID falls between 100 and 200, then location `India` is selected.
6. Use the **If** action to configure the conditional statement.
- Double-click or drag the **If** action.
  - Select **Number** from the **Condition** drop-down list.
  - In the **Source value** field, insert the variable `$emp_id$`.

- d) Select **Greater Than (>)** as the **Operator**.
  - e) Enter 100 in the **Target value** field.
  - f) Click **Add condition** and select **And**.
  - g) Select **Number** from the **Condition** drop-down list.
  - h) In the **Source value** field, insert the variable \$emp\_id\$.
  - i) Select **Less Than (<)** as the **Operator**.
  - j) Enter 200 in the **Target value** field.
  - k) Click **Save**.
7. Add the **List** package into the **If** container to insert the new location as per the defined condition.
- a) Drag the **List > Add item** action.
  - b) In the **List variable** field, select the variable in which to add the list item emp\_location.
  - c) In the **Item to be added** field, select the variable that contains the value to add emp\_dyn\_location.
  - d) Select **Save**.
  - e) Select **Close**.
8. Create a new process automation.
- a) In the same folder location, select **Create new > Process**. See [Create a process automation in Process Composer](#) on page 3454.
  - b) Enter the process automation name as employee\_register.
  - c) Select **Create & edit**.
  - d) Select **Start** to add an initial form to the process automation.
  - e) In the **Select initial data form** field, browse and select the initial form: employee\_register\_initial\_form.
  - f) Provide **Request title** as Employee Registration.
  - g) Drag the **Bot Task** into the Process Composer from the **Task** field.
  - h) In the **Bot Task** panel and **Element name** field, enter a name Location.
  - i) Enter the **Task name** as Generate location.
  - j) In the **Select Task Bot** field, browse and select the bot you created dynamic\_checkbox.
  - k) In the **Input values** field, select the input variable emp\_id.
  - l) Drag the **Form Task** into the Process Composer from the **Task** field.
  - m) In the **Form Task** panel and **Element name** field, enter a name location\_form.
  - n) Enter the **Task name** Employee location form.
  - o) In the **Select form** field, browse and select the form you created employee\_location.
  - p) Select **Add button**.
  - q) Specify OK for the **Button label** and Primary for the **Button style**.



- r) Select the **Feed data into form** check box as `Employee Location[CheckBoxGroup0]`.  
Set the two variables from the bot as output variables.
  - s) In the **List of options** field, select the output variable `$Location.output[emp_location]$`.
  - t) In the **Default value** field, select the output variable `$Location.output[emp_dyn_location]$`.
  - u) Select **Save**.
  - v) Select **Close**.
9. Deploy the process automation.
- a) Select **Run** to create a request for the process automation.
  - b) Enter the values for the initial form.
  - c) Select **Submit**.

The process automation deploys and if the employee ID falls between the values 100 to 200, then Employee location field will have a new option of India making this option dynamic. If the employee ID is not between the values 100 to 200, the Employee location field will have only two options, San Jose and Tokyo.

## Supported variable types in Process Composer

The core part of any process automation in Process Composer is how data moves (flows) between each task. To run properly, tasks require variables.

### Variable types

These variable types are supported in a process automation in Process Composer:

Input	Use this variable type to return values that went "in" a task.
Output	Use this variable type to return values that came "out" of a task.
Meta	Use this variable type to return high-level details about the request of a task.

---

**Note:** You can use hidden variables to conceal data. For details on how to configure hidden variables, see [Create hidden variables in a form](#) on page 3436.

---

## Variable entities

The following entities can hold variables:

Global	Global values span across the tenant and all variable types, and use this form: <code>`\${variableName}`</code> .
Request	Requests hold meta-type variables only and use this form: <code>`\${&lt;meta variable name&gt;}`</code> . This meta-type variable value is from the request.
Task	Tasks can hold three types of variables (input, output, meta) and use these forms: <ul style="list-style-type: none"> <li><code>`\${&lt;task&gt;.&lt;input output&gt;[&lt;variable name&gt;]}`</code>: This input or output variable value is read from the task.</li> <li><code>`\${&lt;task&gt;.&lt;meta variable name&gt;}`</code>: This meta-type variable value is read from the task.</li> </ul>

## Date time variables

Name	Entity	Description
createdOn	Request, Task	Shows the date when the request or task was created. Example: <code>`\${createdOn}`</code> or <code>`\${Approval_Task.createdOn}`</code>
updatedOn	Request, Task	Shows the date when the request or task was last updated. Example: <code>`\${updatedOn}`</code> or <code>`\${Approval_Task.updatedOn}`</code>

## Dictionary variables

Name	Entity	Description
assignedTo	Task	Shows information about the user who is assigned to the task. Dictionary key: {id}, {username}, {email} Example: <code>`\${Approval_Task.assignedTo}`</code>

Name	Entity	Description
createdBy	Request	Shows information about the user who created the request. Dictionary key: {id}, {username}, {email} Example: \$createdBy\$

## Number variables

Name	Entity	Description
executionCount	Task	Shows the number of times the task was run. Example: \$Name_Bot.executionCount\$
id	Request, Task	Shows the numerical ID of a request or task. Example: \$id\$ or \$Approval_Task.id\$
assignedTo{id}	Task	Shows the numerical ID of the user who is assigned to the task. Example: \$Approval_Task.assignedTo{id}\$
createdBy{id}	Request	Shows the numerical ID of the user who created the request. Example: %createdBy{id}\$

## String variables

Name	Entity	Description
status	Task	Shows the label of the button clicked (action) for a form task or the bot return code for a bot task (equal to <b>failed</b> when the bot fails). Example: %Approval_Task.status\$ or \$Name_Bot.status\$
title	Request, Task	Shows the title of the request or task. Example: %title\$ or %Approval_Task.title\$
type	Request	Shows the task type (equal to <b>BOT</b> for bot tasks and <b>FORM</b> for form tasks). Example: %Task.type\$

Name	Entity	Description
assignedTo{username}	Task	Shows the username of the user who is assigned to the task. Example: \$Approval_Task.assignedTo{username}\$
createdBy{username}	Request	Shows the username of the user who created the request. Example: \$createdBy{username}\$
assignedTo{email}	Task	Shows the email of the user who is assigned to the task. Example: \$Approval_Task.assignedTo{email}\$
createdBy{email}	Request	Shows the email of the user who created the request. Example: \$createdBy{email}\$

### User-defined variable

Name	Entity	Description
Any	Task	Stores Boolean, Data table, Date time, File, Number, Record, String, or Window data types. Use this variable type when you are uncertain of the action data type.

### Create hidden variables in a form

You can create hidden elements in a form to access hidden variables in a process automation in Process Composer.

Hidden variables are supported in rules, all variable types, and If/Else conditions. To create a new hidden element (variable), select the **Properties - Form**. You define hidden elements (variables) in a form by selecting **Create a reference for hidden elements**. Enter data for the new hidden variable.

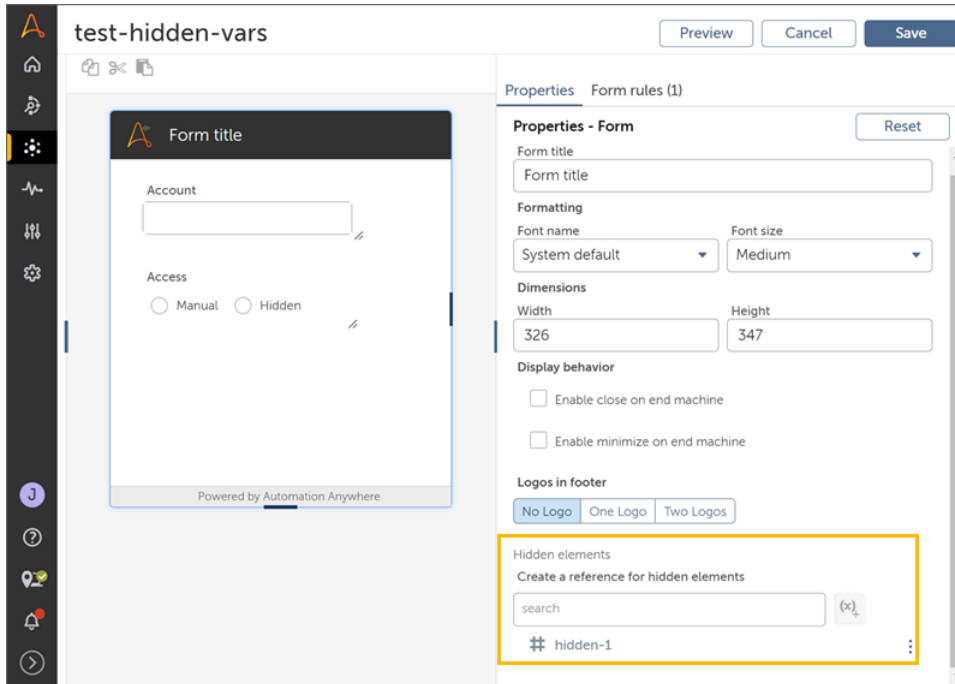

After you create the reference, you can access the hidden variables using the variable picker in the Process Composer.

**Note:** For URL inputs, use the label ID of the hidden variable name as the key for the URL input.

To enable task bots to use hidden variables, create an input variable when building the bot and assign the hidden element as the input for the variable in Process Composer.

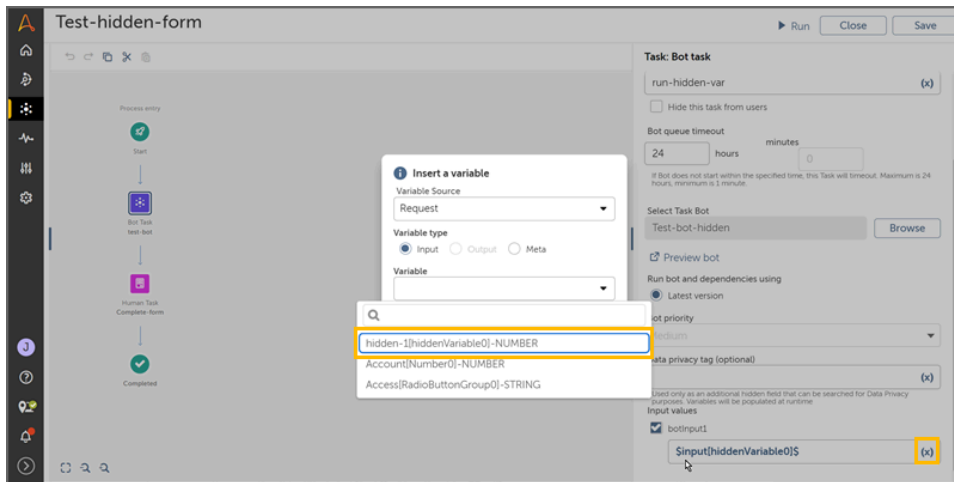

## Create a form

As a Bot Creator, you can create a form to provide interaction between humans and bots. You enter required data using any of the supported form elements that can be rendered in the web interface. Additionally, you can add or remove form actions when creating a process.

---

**Note:** As a user, you can interact with the form only when it is assigned to you. If the form is unassigned, it is not enabled and is read-only. To edit the form, you can assign the form to yourself or to any team member who has access to the process. After editing the form, the assignee can submit the form or use any other action options. After the form is submitted or an action option is used, the request view displays the next step or task.

---

- You must have a Bot Creator license.
- You must be assigned a custom role with the create folder permission.

Forms in Automation Co-Pilot can be displayed in two scenarios:

- Case creation: This is the initial form that is displayed when you want to create a new case and enter the required business data.
- Form step: This form is displayed to show information and prompt for additional inputs.

1. On the left pane, click **Automation**.  
A list of available and forms is displayed.
2. Click **Create new > Form**.
3. In the **Create form** page, enter a name for the new form.  
Forms are saved in the \Bots\ folder by default. Click **Browse** to change the default folder.
4. Click **Create & edit**.  
The form builder page appears with a single row **Column** layout.
5. Drag any of the supported elements (for example: Checkbox, Document, Table, and so on) into the form from the **Elements** panel on the left.
6. If you want to delete a row, click the vertical ellipsis in the form layout and click **Delete row**.
7. Confirm the delete action in the confirmation message.
8. Use the **Properties** panel on the right to update or change the form properties.
9. Click **Save**.
10. Click **Close**.

[Create a process automation in Process Composer](#) on page 3454

Related tasks

[Example: Use Select File to upload or download a file for web](#) on page 3473

This example describes how to use the **Select File** element to upload or download files that are passed in the initial forms in the web interface.

## Using the Button element

Use the **Button** element in the form builder to validate or cancel a form during bot runtime.

1. On the left pane, click **Automation**.  
A list of available and forms is displayed.

2. Click an existing form or click **Create new > Form**.  
The form builder page appears.
3. Drag **Button** into the form.
4. Enter the name of the element in the **Button-text** field.
5. Optional: Enter the hint text and tooltip.
6. Use the **Button types** drop-down menu to set the type of the button element.  
For example, consider you have two buttons, Save and Cancel. Use **Primary** for Save and **Secondary** for Cancel. Or, if you want the button element to appear as a link during bot runtime, select **Subtle**.
7. Optional: Use the following **Advance behavior** option:
  - **Disallow button click when this form is first loaded**: Enable this option to disable the button element when the form is displayed for the first time during bot runtime.
  - **Validate all form fields when this button is clicked**: Enable this option to validate all available fields of the form when a user clicks this button element during bot runtime.
8. Optional: Click one of the following options:
  - **Reset**: Clears all the element customization and sets the default.
  - **Delete**: Deletes the selected element.
9. Click **Save**.

## Using the Checkbox element

Use the **Checkbox** element in the form builder to enable users to select multiple options in a form during bot runtime.

When working with check box outputs, the process builder should apply the following format when mapping keys to options.

A check box output will be a dictionary variable(var) that pairs key:value

Key is the option ID.

Value is a boolean (false = not selected).

The option ID is set by the system as:

**CheckBoxGroupX\_Y**

CheckBoxGroupX is defined by the check box group ID (see in Form Builder).

Y is the order of the option.

Example: `CheckBoxGroup0_0` The first option of the `CheckBoxGroup0` element.

This check box output variable can be set to direct the flow of bots in the process

Ex. `key1:true` then bot1, `key1:false` then bot2

1. On the left pane, click **Automation**.  
A list of available and forms is displayed.
2. Click an existing form or click **Create new > Form**.  
The form builder page appears.
3. Drag **Checkbox** into the form.
4. Enter the name of the element in the **Element label** field.
5. Optional: Enter the hint text and tooltip for the check box element.

6. Use the **Checkbox content** fields to add multiple check boxes and enter a name for each one of them.  
For example, if you are creating a sales chart form, use this field to add three check boxes and enter `Product 1`, `Product 2`, and `Product 3`.
7. Optional: Enable any of the following **Advance behavior** options:
  - Select the **Make field required** check box to ensure users select this element during bot runtime.
  - Select the **Make field uneditable** check box to make the element a read-only option.
  - If you have multiple check boxes in the form and want a default selection during bot runtime, select the **Make default selections** check box, and select the necessary option.
8. Use the **Formatting** field to set the vertical or horizontal layout of the check boxes.
9. Optional: Click one of the following options:
  - **Reset**: Clears all the element customization and sets the default.
  - **Delete**: Deletes the selected element.
10. Click **Save**.

## Using the Date element

Use the **Date** element in the form builder if the user must schedule a date in the form during bot runtime.

1. On the left pane, click **Automation**.  
A list of available and forms is displayed.
2. Click an existing form or click **Create new > Form**.  
The form builder page appears.
3. Drag **Date** into the form.
4. Enter the name of the element in the **Element label** field.
5. Select a default date using the **Default value** field.
6. Optional: Select the **Use the local system date when form is loaded** check box to set your system date as the default value.
7. Select one of the following formatting options:
  - **Use locale date format setting**: The date is displayed in the format set on the user's machine.
  - **Manual input**: Select the date format to be displayed from the drop-down menu.
8. Enter the hint text and tooltip for the formatting option.
9. Optional: Enable any of the following **Advance behavior** options:
  - Select the **Make field required** check box to ensure users select this element during bot runtime.
  - Select the **Make field uneditable** check box to make the element a read-only option.
10. Optional: Click one of the following options:
  - **Reset**: Clears all the element customization and sets the default.
  - **Delete**: Deletes the selected element.



11. Click **Save**.

## Using the Document element

Use the **Document** element in the form builder to render a document that you want to preview with a form.

---

**Note:** Only one **Document** element can be used in a form. Files supported are PDF and image file types (JPG, PNG, etc.).

---

1. On the left pane, click **Automation**.  
A list of available and forms is displayed.
2. Click an existing form or click **Create new > Form**.  
The form builder page appears.
3. Drag **Document** into the form.
4. Enter the correct URL or the document location address in the **Default file** field.
5. Use the **Formatting** drop-down menu to set the position of the document element in the form.
6. Optional: Enter a specific width for the element in the **Dimensions** field.
7. Optional: Click one of the following options:
  - **Reset:** Clears all the element customization and sets the default.
  - **Delete:** Deletes the selected element.
8. Click **Save**.

## Using the Dropdown element

Use the **Dropdown** element in the form builder to provide multiple options in the form during bot runtime.

1. On the left pane, click **Automation**.  
A list of available and forms is displayed.
2. Click an existing form or click **Create new > Form**.  
The form builder page appears.
3. Drag **Dropdown** into the form.
4. Enter the name of the element in the **Element label** field.
5. Optional: Enter the hint text and tooltip for the check box element.
6. Use the **Add dropdown content** field to enter the items that must appear in the drop-down menu during bot runtime.
7. Optional: Enable any of the following **Advance behavior** options:
  - Select the **Make field required** check box to ensure users select this element during bot runtime.
  - Select the **Make field uneditable** check box to make the element a read-only option.
  - If you have multiple items in the drop-down element and want a default selection during bot runtime, select the **Select default list item** check box, and select the necessary option.

8. Optional: Click one of the following options:
  - **Reset**: Clears all the element customization and sets the default.
  - **Delete**: Deletes the selected element.
9. Click **Save**.

## Using the Dropdown Multi-Select element

You can use the Dropdown Multi-Select element to add a dropdown menu in your form for multiple selection.

1. Drag the Dropdown Multi-Select element to your form.  
The properties view will appear to allow for you to configure your element.
2. Specify the name of the label in the **Element label** field.  
By default this is named to **Multi select dropdown**.
3. Optional: Specify the hint in the **Hint below field**.  
The maximum limit is 30 characters.
4. Optional: Specify the hint in the **Tool tip**.  
The maximum limit is 200 characters.
5. Specify a list of items that you want to include for the dropdown menu in the **Add dropdown content** section.  
You can specify as much as you need, as long as the items ends with a comma.

---

**Note:** Duplicates will be automatically deleted.

---

6. Select any of the following in the **Advanced behavior** section.
  - **Make field required**
  - **Make field uneditable**
  - **Select default list item**
7. Click **Save** to save your configuration.
8. Optional: Click **Reset** to clear all fields.
9. Optional: Click **Delete** to remove this element from the form.

## Using the Dynamic Area element

Use the **Dynamic Area** element in the form builder to display content that is not part of the form itself during bot runtime.

1. On the left pane, click **Automation**.  
A list of available and forms is displayed.
2. Click an existing form or click **Create new > Form**.  
The form builder page appears.
3. Drag **Dynamic Area** into the form.
4. Enter the name of the element in the **Element label** field.

5. Use the **Placeholder text** field to enter the text that must appear if this element is empty during bot runtime.
6. Enter a specific height of the element in the **Height** field.  
The default dimension value is set to 120 and enables a scroll bar if the additional content exceeds this value.
7. Optional: Click one of the following options:
  - **Reset**: Clears all the element customization and sets the default.
  - **Delete**: Deletes the selected element.
8. Click **Save**.  
The **Dynamic Area** action is available during bot runtime to render this field.  
See [Interactive forms package](#) on page 2738.

## Using the Hyperlink element

Use the **Hyperlink** element in the form builder if you want to assign a URL during bot runtime.

1. On the left pane, click **Automation**.  
A list of available and forms is displayed.
2. Click an existing form or click **Create new > Form**.  
The form builder page appears.
3. Drag **Hyperlink** into the form.
4. Enter the text to be displayed for the URL in the **Display text** field.
5. Enter the link in the **URL** field.
6. Use the **Open in browser** drop-down menu to select a browser to open the URL.  
If you select Google Chrome, the URL opens in Google Chrome during bot runtime.
7. Optional: Enter the hint text and tooltip for the check box element.
8. Click **Save**.

## Using the Image element

Use the **Image** element in the form builder to enable users to attach an image file to the form. For example, you can use this element to add a company logo to the form during bot runtime.

1. On the left pane, click **Automation**.  
A list of available and forms is displayed.
2. Click an existing form or click **Create new > Form**.  
The form builder page appears.
3. Drag **Image** element into the form.
4. Enter the id in the **Element ID** field.
5. Enter the name of the element in the **Element label** field.
6. Optional: Enter a value in the **Height** field to adjust the height.
7. Optional: Add a help text.
  - Enter a text in **Hint below field**.

- Enter a text in the **Tool tip** field.
8. Use the **Desktop or network path to retrieve image** field to specify the image filepath
  9. Upload an image in the **Select image file to upload** field.

**Note:** In Automation 360 v.26, where you must specify a local image for the **Image** element (**Desktop or network path to retrieve image** field), you must use the browse feature in the image property to upload the image.

The screenshot shows the 'Properties - Image' configuration window. It has two tabs: 'Properties' (selected) and 'Form rules (0)'. Below the tabs are 'Reset' and 'Delete' buttons. The 'Element settings' section contains 'Element ID' (Image0) and 'Element label' (Image). The 'Formatting' section contains 'Height' (64). The 'Help text option' section contains 'Hint below field' (30 characters max) and 'Tool tip' (200 characters max). A red box highlights the 'Select image file to upload' field with a 'Select File' button. Below this field is a note: 'This is useful for showing default images when working with web-forms'.

10. Click **Save**.

## Using the Label element

Use the **Label** element in the form builder to add a read-only field in the form at bot run time.

1. On the left pane, click **Automation**.  
A list of available and forms is displayed.
2. Click an existing form or click **Create new > Form**.

The form builder page appears.

3. Drag **Label** into the form.
4. Enter the name of the element in the **Element label** field.
5. In the formatting section, select your formatting options:
  - **Font size:** Set the size of the font.
  - **Emphasis:** Set the font emphasis such as bold, italics, and so on.
  - **Font color:** Set the display colour of the font.
  - **Text alignment:** Set the text alignment within the element.

The screenshot shows the 'Properties' panel for a 'Label' element. The panel is titled 'Properties - Label' and includes 'Reset' and 'Delete' buttons. It is divided into several sections: 'Element settings' with an 'Element ID' field containing 'Label0'; 'Element content' with a text area containing 'Label'; 'Formatting' (highlighted with a yellow border) containing four dropdown menus: 'Font size' (12), 'Emphasis' (None), 'Font color' (Black), and 'Text alignment' (Left); and 'Help text option' with a 'Tool tip' field and a '200 characters max' limit.

6. Optional: Enter a tooltip that appears when the user points to the element.
7. Click **Save**.

## Using the Number element

Use the **Number** element in the form builder if the form must have a field that allows the user to enter only numeric values during bot runtime.

1. On the left pane, click **Automation**.

A list of available and forms is displayed.

2. Click an existing form or click **Create new > Form**.  
The form builder page appears.
3. Drag **Number** into the form.
4. Enter the name of the element in the **Element label** field.
5. Set the default value for the element.
6. Enter the minimum and maximum number of characters that users can enter in this field during bot runtime.
7. Optional: Enter the hint text and tooltip for the check box element.
8. Optional: Enable any of the following **Advance behavior** options:
  - Select the **Make field required** check box to ensure users select this element during bot runtime.
  - Select the **Make field uneditable** check box to make the element a read-only option.
9. Use the **Formatting** options to enable users to enter negative values, trailing zeroes, and comma during bot runtime.
10. Use the **Decimals** drop-down menu to set the number of decimal places.
11. Use the **Special characters** field to enter the prefix and suffix labels for the element.
12. Optional: Click one of the following options:
  - **Reset**: Clears all the element customization and sets the default.
  - **Delete**: Deletes the selected element.
13. Click **Save**.

## Using the Password element

Use the **Password** element in the form builder if the form must have a confidential or masked field. This element uses the masking feature by default and Credential Vault encryption to transfer data during bot runtime.

1. On the left pane, click **Automation**.  
A list of available and forms is displayed.
2. Click an existing form or click **Create new > Form**.  
The form builder page appears.
3. Drag **Password** to the form.
4. Enter the name of the element in the **Element label** field.
5. Use the **Formatting** field for additional options:
  - **Standard**
    - Set the character limit for password using the **Min** and **Max** fields.
    - Enable additional security options for the password.
  - **Custom**
    - Click the **Add regular expression** option and enter a custom password in the **Regular expression** field.

- Optional: Enter the same custom password in the **Test Content** field, and click **Test regular expression** to verify it works correctly.
6. Optional: Enter the hint text and tooltip.
  7. Optional: Enable any of the following **Advance behavior** options:
    - Select the **Make field required** check box to ensure users select this element during bot runtime.
    - Select the **Make field uneditable** check box to make the element a read-only option.
  8. Optional: Click one of the following options:
    - **Reset**: Clears all the element customization and sets the default.
    - **Delete**: Deletes the selected element.
  9. Click **Save**.
- 

**Note:** Use the view icon  in the **Password** field to hide or reveal the password during runtime.

---

## Using the Radio Button element

Use the **Radio Button** element in the form builder if you want to enable users to select only one of the available options from a field during bot runtime.

1. On the left pane, click **Automation**.  
A list of available and forms is displayed.
2. Click an existing form or click **Create new > Form**.  
The form builder page appears.
3. Drag **Radio Button** into the form.
4. Enter the name of the element in the **Element label** field.
5. Optional: Enter the hint text and tooltip for the check box element.
6. Enter the names of the radio buttons that will be displayed during bot runtime.  
For example, if you are creating a client information form, use this field to add two radio buttons and enter `Male` and `Female`.
7. Enable any of the following **Advance behavior** options:
  - Select the **Make field required** check box to ensure users select this element during bot runtime.
  - Select the **Make field uneditable** check box to make the element a read-only option.
  - If you have multiple radio buttons in the form and want a default selection during bot runtime, select the **Make default selections** check box, and select the necessary option.
8. Use the **Formatting** field to set the vertical or horizontal layout of the radio buttons.
9. Optional: Click one of the following options:
  - **Reset**: Clears all the element customization and sets the default.
  - **Delete**: Deletes the selected element.

10. Click **Save**.

## Using the Rich Text Editor element

Use the **Rich Text Editor** element in the form builder to insert a text editor in the form that provides various options to edit the content during bot runtime.

1. On the left pane, click **Automation**.  
A list of available and forms is displayed.
2. Click an existing form or click **Create new > Form**.  
The form builder page appears.
3. Drag **Rich Text Editor** into the form.
4. Enter the name of the element in the **Element label** field.
5. Set the default value for the element that must appear in the element during bot runtime.
6. Enter the minimum and maximum number of characters that users can enter in this field during bot runtime.
7. Optional: Enter the height for the input area of the field and tooltip for the element.
8. Optional: Enable any of the following **Advance behavior** options:
  - Select the **Make field required** check box to ensure users select this element during bot runtime.
  - Select the **Make field uneditable** check box to make the element a read-only option.
9. Optional: Click one of the following options:
  - **Reset**: Clears all the element customization and sets the default.
  - **Delete**: Deletes the selected element.
10. Click **Save**.

## Using the Select File element

Use the **Select File** element in the form builder to enable users to attach a file to the form. For example, if the registration form requires a new user to attach a photograph, you can use this element in the form.

1. On the left pane, click **Automation**.  
A list of available and forms is displayed.
2. Click an existing form or click **Create new > Form**.  
The form builder page appears.
3. Drag **Select File** into the form.
4. Enter the name of the element in the **Element label** field.
5. Use the **Select the format type** field to set one of the following options for upload file format:
  - **Supported Type**: If you select this option, in the **Enter file formats separated by commas** field, ensure that you enter the file types that the user can upload when the bot runs. For example, if you want to allow only `.png` and `.jpeg` file types, enter them in the **Enter file formats separated by commas** field.



- **Unsupported Type:** If you select this option, in the **Enter file formats separated by commas** field, ensure that you enter the file types that will not be supported during upload when the bot runs. For example, if you want to restrict users from uploading `.txt` and `.ppt` file types, enter them in the **Enter file formats separated by commas** field.
6. Optional: Select **Enable file download** if you want the users to be able to download the file. An interactive icon displays for downloading the file in the preserved format. The file name displays as a hyperlink to download the file in TEMP format.
  7. Optional: Enter the hint text and tooltip for the element.
  8. Optional: Choose one of the following **Advance behavior** options:
    - Select the **Make field required** check box to ensure users must select this element during bot runtime.
    - Select the **Make field uneditable** check box to set the element as a read-only option.
  9. Optional: Choose one of the following options:
    - **Reset:** Clears all the element customization and sets the default.
    - **Delete:** Deletes the selected element.
  10. Click **Save**.

When you click **Preview** during bot runtime, the system default application is used to display the selected file.

For example, if Microsoft Excel is set as the default application and you use **Select file** to upload a `.xls` spreadsheet, the selected document is displayed in Microsoft Excel when you click **Preview** during bot runtime.

Users can click **Browse** to select a file or drag a file into the **Select File** element during bot runtime.

## Using the Select Folder element

Use the **Select Folder** element in the form builder to enable users to upload a folder that contains a specified file type during bot runtime.

1. On the left pane, click **Automation**.

A list of available and forms is displayed.
2. Click an existing form or click **Create new > Form**.

The form builder page appears.
3. Drag **Select Folder** into the form.
4. Enter the name of the element in the **Element label** field.
5. Optional: Select the **Show list of supported files in the folder** check box.

If you select this option, the supported file types are displayed below the **Select folder** form element during bot runtime.
6. Enter the supported file types for this element during bot runtime.

For example, if you want to allow users to only upload folders that contain documents or text files, enter `doc` and `txt`.
7. Optional: Enter the hint text and tooltip for the element.
8. Optional: Choose one of the following **Advance behavior** options:

- Select the **Make field required** check box to ensure users must select this element during bot runtime.
- Select the **Make field uneditable** check box to set the element as a read-only option.

**9.** Click **Save**.

Users can click **Browse** to select a folder or drag one into the **Select Folder** element during bot runtime.

## Using the Snapshot element

Use the **Snapshot** element in the form builder to provide the users a screen capture option on the form during bot runtime. The file is saved in the `.jpg` format.

- 1.** On the left pane, click **Automation**.  
A list of available and forms is displayed.
- 2.** Click an existing form or click **Create new > Form**.  
The form builder page appears.
- 3.** Drag **Snapshot** into the form.
- 4.** Enter the name of the element in the **Element label** field.
- 5.** Optional: Enter the hint text and tooltip for the check box element.
- 6.** Optional: Choose one of the following **Advance behavior** options:
  - Select the **Make field required** check box to ensure users must select this element during bot runtime.
  - Select the **Make field uneditable** check box to set the element as a read-only option.
- 7.** Enter a filepath in the **Desktop path to save snapshot** field where the snapshot file must be saved during bot runtime.  
Optionally, you can either allow the user to create a folder if the filepath is not available or change the destination folder of the snapshot file.
- 8.** Enter the suffix text for the snapshot file.  
For example, if this element is used to capture sales information, enter `Sales`. The snapshot file is then saved with the text `Sales` added at the end.
- 9.** Optional: Choose one of the following options:
  - **Reset**: Clears all the element customization and sets the default.
  - **Delete**: Deletes the selected element.
- 10.** Click **Save**.  
When you click **Preview** during bot runtime, the system default application is used to display the snapshot file.  
For example, if Microsoft Photos is set as the default application to open `.jpg` files, the snapshot file is displayed in Microsoft Photos when you click **Preview**.

## Using the Table element

Use the **Table** element in the form builder to insert a customizable table in the form that can be used to populate data during bot runtime.

1. On the left pane, click **Automation**.  
A list of available and forms is displayed.
2. Click an existing form or click **Create new > Form**.  
The form builder page appears.
3. Drag **Table** to the form.
4. Enter the name of the element in the **Element label** field.
5. Optional: Enter hint text for the element in the **Hint below field**.  
For example, enter `View outpatients details` if the table is used to capture a list of outpatients.
6. Optional: Specify your tooltip in **Toop tip** field.  
When you add a tooltip and hover, your specified text is displayed.
7. Use the **Rows before scrolling** field to enter the minimum number of rows the table element must have before a scroll bar is added during bot runtime.
8. Optional: Select the **Enable row selection (Column 0)**.  
This will add a check box column in the first column of the table. This also provides a better user experience when multiple rows are needed to be highlighted or picked by the user (instead of asking the user to select from a drop-down).

---

**Note:** The column is a boolean type where true = row selected. This provides a true/false boolean whether a row is selected or not, thus giving a form or bot to access this data. Further details at bottom of page.

---

9. Add or remove the total number of columns.
10. Click **Column settings** for additional options.
11. In the **Column settings** page, click the **Form element type** drop-down menu to set the element type.  
For example, if you select **Dropdown**, use the **Add dropdown content** field to enter the items that must appear in the drop-down menu during bot runtime.
12. Optional: Click **Make columns width equal**.
13. Optional: Select any of the following **Advance behavior** options to enable them:
  - **Make table uneditable:** Enables a read-only view during bot runtime.
  - **Include table actions:** Enables users to add, remove or edit table rows during bot runtime.  
  
If you use the table actions to delete all the rows from a table and then add a new row, the columns and rows of the table appear misaligned. Drag and resize any column to reset the alignment.
  - **Enable column filtering:** Enables users to search and filter the content for all the available columns during bot runtime. This enhances the search for content that is referenced by the column values.
14. Click **Save**.

## Row selection

The row selection setting of the table element performs the expected behavior during bot execution. If row selection is enabled, the first column for the table is always expected to be boolean (selected or unselected). The following example demonstrates the difference in table data (four column table: Col0 = TextBox, Col1= Date, Col3 = Number, Col4 = TextArea).

Table 10: Row selection setting in the table element

Setting	Datatable in the bot will have the following datatype
Disabled	Col0 = String, Col1 = DateTime, Col3 = Number, Col4 = String
Enabled	Col0= Boolean, Col1 = String, Col2 = DateTime, Col4 = Number, Col5 = String

## Using the Text Area element

Use the **Text Area** element in the form builder to insert a text field in the form for users to enter alphanumeric characters during bot runtime.

1. On the left pane, click **Automation**.  
A list of available and forms is displayed.
2. Click an existing form or click **Create new > Form**.  
The form builder page appears.
3. Drag **Text Area** into the form.
4. Enter the name of the element in the **Element label** field.
5. Use the **Default value** field to enter the default text to be displayed in the element.
6. Optionally, enter the parameters for minimum and maximum number of characters you want to allow in this field during bot runtime (ex. 1 to 100).
7. Enter the height for the input area of the field.
8. Optional: Enter the hint text and tooltip for the check box element.
9. Optional: Enable any of the following **Advance behavior** options:
  - Select the **Make field required** check box to ensure users select this element during bot runtime.
  - Select the **Make field uneditable** check box to make the element a read-only option.
10. Optional: Click one of the following options:
  - **Reset**: Clears all the element customization and sets the default.
  - **Delete**: Deletes the selected element.
11. Click **Save**.

## Using the Text Box element

Use the **Text Box** element in the form builder to insert a text box in the form.

1. On the left pane, click **Automation**.  
A list of available and forms is displayed.
2. Click an existing form or click **Create new > Form**.  
The form builder page appears.
3. Drag **Text Box** into the form.
4. Enter the name of the element in the **Element label** field.
5. Enter the default text that must appear in the element.  
For example, if this field is used in a registration form, enter `First name`, which is displayed during bot runtime.
6. Use the **Formatting** field for additional options:
  - **Standard**  
Set the character limit using the **Min** and **Max** fields.
  - **Custom**
    - Click the **Add regular expression** option and enter a custom text in the **Regular expression** field.
    - Optional: Enter the same custom text in the **Test Content** field, and click **Test regular expression** to verify it works correctly.
7. Optional: Enter the hint text and tooltip for the element.
8. Enable any of the following **Advance behavior** options:
  - Select the **Make field required** check box to ensure users select this element during bot runtime.
  - Select the **Make field uneditable** check box to make the element a read-only option.
  - Select the **Mask data** check box if you want the field to be masked by special characters when the user enters data during bot runtime.
9. Optional: Click one of the following options:
  - **Reset**: Clears all the element customization and sets the default.
  - **Delete**: Deletes the selected element.
10. Click **Save**.

## Using the Time element

Use the **Time** element in the form builder to set the time in the form during bot runtime.

1. On the left pane, click **Automation**.  
A list of available and forms is displayed.
2. Click an existing form or click **Create new > Form**.  
The form builder page appears.
3. Drag **Time** into the form.

4. Enter the name of the element in the **Element label** field.
5. Select a default time using the **Default value** field.
6. Optional: Select the **Use the local system time when form is first displayed** check box to set your system time as the default value.
7. Use one of the following formatting options:
  - Set the time to **12 Hours** or **24 Hours** format.
  - Enter the hint text and tooltip.
8. Optional: Enable any of the following **Advance behavior** options:
  - Select the **Make field required** check box to ensure users select this element during bot runtime.
  - Select the **Make field uneditable** check box to make the element a read-only option.
9. Optional: Click one of the following options:
  - **Reset**: Clears all the element customization and sets the default.
  - **Delete**: Deletes the selected element.
10. Click **Save**.

## Create a process automation in Process Composer

As a Bot Creator, you create and design process automations which consist of human and botbot tasks listed as elements in the Process Composer.

- You must have a Bot Creator license.
- You must be assigned a custom role with the create folder permission.

---

**Note:** Each task, logic condition, and end point supports the copy, paste, and cut elements from the Bot editor. Additionally, you can double-click to add and replace items on the canvas. See [Supported behaviors for tasks and elements in Process Composer](#) on page 3422.

---

1. Create a process automation:
  - a) From your local machine, log in to your Control Room as a Bot Creator.
  - b) From the left pane, click **Automation**, and then click **Create new > Process**.
  - c) In the **Create process** page, enter a name for the new process automation. By default, process automations are saved in the \Bots\ folder. Click **Browse** to change the default folder.
  - d) Click **Create & edit**.
  - e) Click the process automation name to rename it.
2. To add initial form and data to the process automation, click **Start**.
3. From the **Start** panel:
  - a) Browse and **Input variables** or **Select initial data form**.
  - b) Select the File upload storage.

**AARI Storage** is default for process automation and **Document Workspace Storage** is default for document automation.

- c) In the **Request title** field, enter text or insert a variable as an input variable. A dynamic title is created for this request that will display in the web interface and serve as a reference.

**Note:** You can use a Reference ID such as `ref ID = $RefId$`. Reference ID is a **Meta** variable type.

- d) In the **Task name** field, enter the name of the task.  
You can use a Reference ID such as `task ref ID = $RefId$`.
- e) In the **Data privacy tag** field (same as a PII [Personally Identifiable Information] tag), enter a text or variable to generate hidden custom output.
- f) Click **Apply**.
4. [Add Bot Task to a process automation](#) on page 3456.  
The Bot Task runs a bot with inputs and outputs.
  5. [Add Form Task to a process automation](#) on page 3458.  
The Form Task displays a form that requires interactions by a user.
  6. You can add these optional elements to the process automation:
    - [Add API Task to a process automation](#) - Use the API Task to enable API calls for inputs and outputs.
    - [Add input variables to a process automation](#) on page 3460 - Use input variables to start a process without having to build a form as the point of entry for a process automation.
    - [Add Filter Task to a process automation](#) on page 3462 - Use the Filter Task to filter a variable based on your specific criteria.
    - [Add Process Task to a process automation](#) on page 3462 - Use the Process Task to run a process automation.
    - [Add Document Validation to a process automation](#) on page 3469 - Use the Document Validation Task to display a validator for a document that requires validations.
    - [Add Approval Task to a process automation](#) on page 3463 - Use the Approval Task to share requests with decision makers before the process is completed.

7. You can add logical conditions to include internal and conditional branching of the process automation. Drag the condition from the **Elements** panel. You can select an **If/Else** pair or **Else if**.
8. From the **Condition** panel, you can add these optional fields:
  - a) Add a description in the **Description** field.
  - b) Add a message in the **Display message** field. As a result, the display message you enter is shown in the request view page in the web interface.
  - c) Click **Add Condition** to add a condition.  
You can select a condition from these available types: **Boolean**, **Datetime**, **Number**, or **String**.
  - d) Click **Apply**.
9. [Add End Point to a process automation](#) on page 3470.  
You can add End Point to end a process automation with a selected status (such as: completed, failed, or canceled) or add Go to to navigate to other tasks in the process automation.  
You have now configured your process automation!
10. To preview your bot or forms information in the Process Composer (**Edit process** page) in both your public and private workspace:
  - a) Click the vertical ellipsis next to the **Bot Task** or the **Form Task**.
  - b) Select either the **Preview bot** or **Preview form** option.  
In the public workspace, these options display the **Bot name preview** or **Form name preview** page where you can quickly view a bot or form.  
In the private workspace, these options display the **Edit Task Bot** or **Edit form** page where you can make changes to your Bot Task or form.

#### Related tasks

[Create your first bot](#) on page 1489

Perform the following steps to create your first bot that prints the message, Go be great!, the Automation Anywhere version of Hello World!

[Create a form](#) on page 3438

As a Bot Creator, you can create a form to provide interaction between humans and bots. You enter required data using any of the supported form elements that can be rendered in the web interface. Additionally, you can add or remove form actions when creating a process.

#### Related reference

[About the Automation Co-Pilot process in Document Automation](#) on page 3646

Document Automation uses Automation Co-Pilot for Business Users technology to manage the end-to-end document extraction process. When you create a learning instance in Document Automation, the system also creates an Automation Co-Pilot process. Review the following guide to understand the logic.

## Add Bot Task to a process automation

As a Bot Creator, you can create a Bot Task to execute inside a process automation.

1. Add a **Bot Task** to the process automation by dragging the element from the **Element** panel.



2. From the **Bot Task** panel:
  - a) Enter a name in the **Element name** field.
  - b) Enter the task name in the **Task name** field.

The task display name appears in the web interface as a reference. You can use a Reference ID such as `ref ID = $RefId$`.
  - c) Optional: Select the **Hide this task after completion** check box.

After task completion, the user does not see the **Bot Task** in the web interface.

To display the hidden task, select the **View hidden tasks** check box in the tasks view page of the web interface.
  - d) Browse and select the Task Bot in the **Select Task Bot** field.
  - e) In the **Run bot and dependencies using** section, select a label version.

You can select **Latest version** (default) or **Production label**.

The bot deploys the version that you select.
  - f) In the **Bot priority** section, you can review your bot priority level.

---

**Note:** The bot priority level is a read-only label that shows **Low**, **Medium**, or **High** depending on the priority level that was set for the bot.

---

**Important:** If the priority of a task bot was changed, you need to browse for the task bot again to reflect the correct priority status for an existing Process Composer process automation.

---

- g) Optional: In the **Data privacy tag** field, enter a text or variable to generate hidden custom output.

Select the **Input values** check box and specify a variable.

The variable input expected by the bot is mapped with the variable that will be populated when creating the request.

  1. Select a task in the **Process task** field.
  2. Select a type in the **Variable type** field. You can select **Input**, **Output**, or **Meta**. When you select the Use as input check box, the process automation passes data into the input variables, and when you select the Use as output check box, the process automation retrieves data from the output variables after the bot execution. See [Supported variable types in Process Composer](#) on page 3433.
  3. Specify your variable in the **Variable** field.

---

**Note:** Reference ID is a **Meta** variable type.

---

- 4. Click **Apply**.

3. Click **Save**.

You have now configured the Bot Task in your process automation.

## Add Form Task to a process automation

You can add a Form Task to configure the settings of a process automation.

Forms used in process automation are containers for human input during run time of attended automation. When added to the process flow, these containers are available to receive and send data that other elements can use over the course of the end to end process flow. Users wanting forms for unattended automation, where data is collected and consumed by bots without human input, should use interactive forms. [Interactive forms package](#) on page 2738

1. Add the **Form Task** to the process automation by dragging the element from the **Element** panel.
2. From the **Form Task** panel, perform these steps:
  - a) Enter a name in the **Element name** field.
  - b) Enter the task name in the **Task name** field.

The task display name is displayed in the web interface as a reference. You can use a Reference ID such as `ref ID = $RefId$`.
  - c) Select the **Hide this task after completion** check box.

After task completion, the **Form Task** is not displayed to the user in the web interface.

To display the hidden task, select the **View hidden tasks** check box in the tasks view page of the web interface.
  - d) Select the **Make the form read-only** check box.

The **Form Task** does not require any input and moves automatically to the next task.
  - e) Select the **Assign this task to the user who created this request** check box.

The task is automatically assigned to the user creating this request in the web interface.
  - f) Select the **Auto-assign this task to** check box. You can select the following options from the drop-down:
    - **The user who created the request:** The task is automatically assigned to the user creating the request in the web interface.
    - **The user who opens this task:** The task is automatically assigned to the user who opens the task in the web interface.
  - g) In the **Task expiration time** field, select the time option.

You can select the following options: **No expiration** (default), **1 hour**, **1 day**, **1 week**, **2 week**, **30 days**, and **Custom**.

---

**Note:** If you choose the **Custom** option, you must specify the time by the number of days, hours, and minutes. The maximum is **45 days**, and the minimum is **1 minute**. Days range from 0 to 45 days, and hours range from 0 to 23 hours. For minutes, if the hours and days are set to **0**, minute range is 1 to 59 minutes. However, if the hours and days are not set to **0**, then the minute range is 0 to 59 minutes.

---
  - h) In the **Select form** field, browse and select the second form created.

This form displays the result.
  - i) In the **Data privacy tag** field, enter a text or variable to generate hidden custom output.
  - j) In the **Add form button** field, specify your button details.
    - Specify a name in the **Button label** field.

- Select a style in the **Button style** field.  
You can choose between **Primary**, **Secondary**, or **Cancel**.
- Click **Add button** to add any additional buttons.

For example, these buttons display in the fixed footer of the form during the form task:

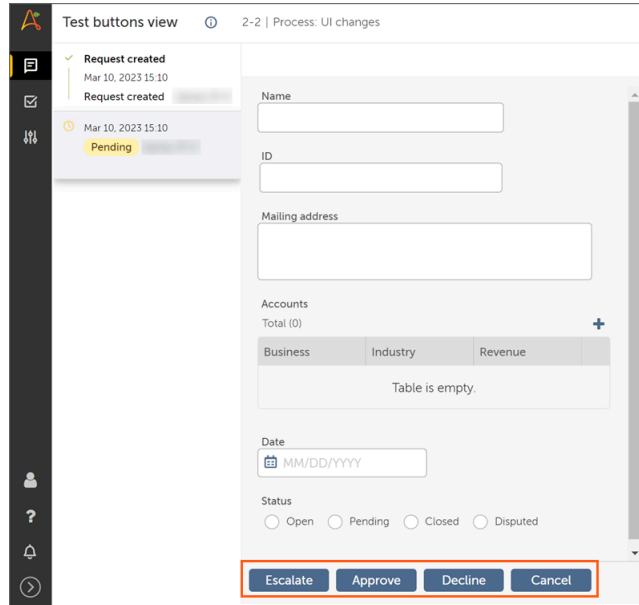

- k) Select the check box in the **Feed data into form** field.
1. Select a task in the **Process task** field.
  2. Select a type in the **Variable type** field.  
You can choose **Input**, **Output**, or **Meta**.
  3. Specify your variable in the **Variable** field.

**Note:** Reference ID is a **Meta** variable type.

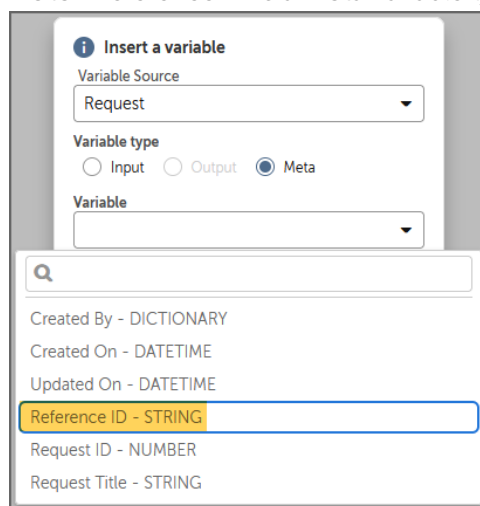

**4. Click **Apply**.****3. Click **Save**.**

You have now configured the Form Task in your Process Composer process automation.

## Add input variables to a process automation

As a Pro developer, you can use input variables to start a new process automation without using a form.

Using input variables, you can start a process automation without having to build a form as the point of entry for a process. You define input variables directly within the process automation itself which is particularly useful if your process automation requires complex variable types such as a dictionary, table, or a list. For example, without any human intervention, you can easily and efficiently:

- Schedule a process automation to run overnight.
- Trigger a process automation by email.
- Launch a process automation from another system such as Salesforce or SAP.

Additionally, you can use input variables with the Create Request API and Create Request command package.

## Create and add input variables to a new process automation

To create and add input variables to a new process automation:

1. From the panel on the left, click Show at the bottom to open the Variables panel.
2. From the Variables panel, click the plus (+) icon. The Create Variable dialog displays for you to create a new input variable.

---

**Note:** You cannot select an existing variable as an input variable; you must create a new one.

---

3. Enter the name of the new variable in the Name field.
4. Select your variable type from the Type drop-down. Click [Supported variable types in Process Composer](#) on page 3433 for more details.
5. Optional: Enter the variable description in the Description field.
6. Click Use as input.
7. Based on the variable type you selected, you might need to enter additional information to define the input variable.
8. Click Create. The input variable that you created displays in the Variables panel under the Input variables section. You can expand or collapse the lists of input and output variables.

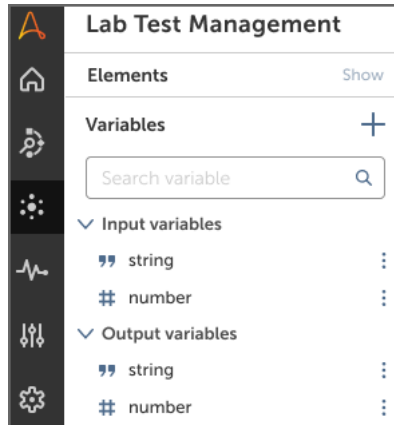

Repeat steps 2 through 8 to create any additional input variables for your process automation.

## Start a new process automation using input variables

After you have created the input variables, you can start a new process automation using the initial data provided by the input variables:

**Note:** You cannot add input variables when you start a process automation using initial data from a form. To create input variables, you must click Input variables as the Initial data selection.

1. From the Start panel on the right, click Input variables.
2. Click Run to run the process automation.

**Note:** If you start a process automation using initial data from an existing form and then change the form, all existing input variables will be overridden. This might cause validation errors due to invalid variables.

## Edit or delete input variables

To edit or delete input variables after you create them:

1. From the Variables panel, click the action menu (vertical ellipsis) next to the variable you want to edit or delete.
2. Click Edit variable or Delete variable.
  - If you edit the variable, you can change the Description or Default value fields only. Click Apply to save the changes.
  - If you delete the variable, it is automatically removed from the Input variables list.
3. You can rerun or close the process automation with the updated variables.

**Note:** If you have attached a form, input variables are auto-generated based on the form fields. You cannot delete these variables, however you can edit the variable description only.

## Add Filter Task to a process automation

You can add a Filter Task to apply a filter to a process automation variable in Process Composer.

1. Add the **Filter Task** option to the process automation by dragging the element from the **Task** panel. The filter task applies a filter to the process automation variable.

For example, you have a table as an output of a form, and your output has an **Approved** column that contains **Yes** or **No** data in the rows, the filter task will be able to retrieve only rows with **Yes** as an output of the filter task.

2. From the **Filter Task** panel:

- a) Enter a name in the **Element name** field.

- b) Enter the task name in the **Task display name** field.  
The task display name displays in the web interface as a reference.

- c) Optional: Select the **Hide this task** check box.  
After task completion, the user does not see the **Filter Task** in the web interface.

To display the hidden task, select the **View hidden tasks** check box in the tasks view page of the web interface.

- d) Enter a variable in the **Variable to be filtered** field.

- e) In the **Filtered type** field, select an option.

For example, for a dictionary variable, the **Check each key/value pair in the dictionary** or **Check entire dictionary** options are available for you to select.

- f) In the **Filter criterion** field, select a condition.

After you select a condition, specify the **Source variable**, **Operator**, and **Target value** fields.

3. Click **Save**.

You have now configured the Filter Task in your Process Composer process automation.

## Add Process Task to a process automation

You can add a Process Task to configure the settings for a process automation.

1. Add the **Process Task** option to the process automation by dragging the element from the **Task** panel.

2. From the **Process Task** panel:

- a) Enter a name in the **Element name** field.

- b) Enter the task name in the **Task name** field.  
The task display name appears in the web interface as a reference.

- c) Optional: Select the **Hide this task from users** check box.  
After task completion, the user does not see the **Process Task** in the web interface.

To display the hidden task, select the **View hidden tasks** check box in the tasks view page of the web interface.

- d) Select either the **Public folder** or **Private folder** and browse and select the process.

- e) Select the user group to which you want to assign the request:

- **Role:** Click **Choose** to search for the role you want to assign and then click **Select**.
- **Team:** Click **Choose** to search for the team you want to assign and then click **Select**.
- **Variable:** Click the small **(x)** to the right of the text box to select a **Variable Source** and **Variable** from that source. The Variable option is only valid for Global Variables of type User Group. Global values enable users to reuse identical values between bots instead of creating new variables for each bot. As a process builder, you can select a user group variable within the process to populate the required user group input fields of a Task (such as: Form, Process, or Approval). For more details, click [Global values](#) on page 2350 and click [Create a global value](#) on page 2351 to learn how to create a global value for a user group. Click **Add**.

---

**Note:** If user group that you specify does not have access to the process, the request will be assigned to the default user group during runtime.

---

f) In the **Data privacy tag** field, enter a text or variable to generate hidden custom output.

3. Click **Save**.

You have now configured the Process Task in your Process Composer process automation.

## Add Approval Task to a process automation

You can configure an approval task to share requests with decision makers before the process automation is completed.

The need for approvals applies to many business tasks, like time-off and purchasing requests. The approval task can be used by developers to automate a process where users can submit and receive approvals, while staying notified of progress, without breaking concentration from streamlined work flow.

The developer will need a pre-built form for the approval task that can receive data from the process. This is labeled the **Approval content form** and is used to pass data to the responder approving the task.

1. From the Control Room, open an existing process automation or create a new process automation to launch the Process Composer.
2. Add the **Approval** task to the end of your process automation.

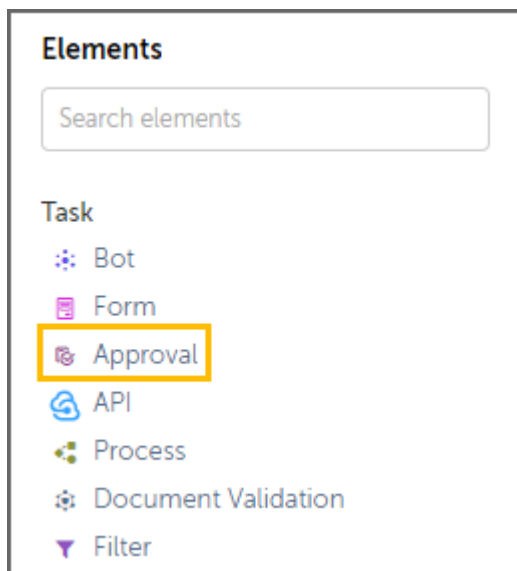

3. Select the **Approval** task element in your flow to open the configurations panel and enter the **Element name**.
4. Enter the **Task name**.
5. Select the users for the Task requester and assignment.



**Task requester and assignment**

Default Custom

**Task requester** Send

Task requester(s) will be able to see this task and its status from their "Requested" task list.

Request creator

The assigned group of the request  
Assigned group is the user group responsible for a request. It is specified either by admin during process setup (default group) or by users or bots when initiating a request.

Specify user group

Role Team Variable

Docs team testing X Choose

**Assign this task to** Receive

Request creator

The assigned group of the request  
Assigned group is the user group responsible for a request. It is specified either by admin during process setup (default group) or by users or bots when initiating a request.

Specify user group

Role Team Variable

Co-Pilot Business users X Choose

**Note:** The **task requester** represents the user group (role, team, individual user) that sends the task for response. **Assign** the task to the user group that receives the request and responds. See, [Route users to an approval task](#) on page 3466.

**Default** will send approval requests to default users set by the admin. When you select **Custom**, you can enable these options to the **Specify user group** for the approval.

- **Role:** Select a pre-built Custom role to add users that have the selected role assigned. [Create a role](#) on page 1748
- **Team:** Select the pre-built Team to add users in the selected Team. [Assign members to a team](#) on page 3306
- **Variable:** Select a pre-built Global value to add users from that user group to the configuration. [Create a global value](#) on page 2351

6. Enter the **Number of approvals** you want required for this task to complete.
7. Select your pre-built **Approval content form**.
8. Select the **Action buttons** for the responder to approve and decline the task.
9. Select each box and enter the inputs to **Feed data into form**.
10. **Save** the process automation.

## Route users to an approval task

For appropriate users to run, approve, and contribute to an approval task, it is important to use the labels recognized by the Process Composer.

In the **Process Composer > Approval task**, configurations for users are recognized as assigned, requested, and contributors of the task during run time for multiple-user collaboration.

**Task requester and assignment**

Default Custom

**Task requester** Send

Task requester(s) will be able to see this task and its status from their "Requested" task list.

Request creator

The assigned group of the request  
Assigned group is the user group responsible for a request. It is specified either by admin during process setup (default group) or by users or bots when initiating a request.

Specify user group

Role Team Variable

Docs team testing X Choose

**Assign this task to** Receive

Request creator

The assigned group of the request  
Assigned group is the user group responsible for a request. It is specified either by admin during process setup (default group) or by users or bots when initiating a request.

Specify user group

Role Team Variable

Co-Pilot Business users X Choose

The following table of information can be used to configure and assist decisions when routing the approval to roles and teams. The User column displays the label recognized in the process configuration. The Details column describes the parameters for that configuration.

User	Details
Request Creator	<p>When the request is created using the interface (AARI Web or Automation Co-Pilot) the user who created the request.</p> <ul style="list-style-type: none"> <li>Request Creator is required to be part of the Assigned Group.</li> </ul> <p>When request is created by other means (API, Create Request command, CoE approval use case, etc.)</p> <ul style="list-style-type: none"> <li>Request Creator is not required to be part of the Assigned Group and only needs the execute permission.</li> </ul>
Request Assigned Group	<p>The role or team where the request is created.</p> <p>= createdByTeam</p> <p>Example: Request POC-2 from Process (POC) created under Team 202.</p> <ul style="list-style-type: none"> <li>Team 202 is the Request Assigned Group.</li> <li>This group has read access to the request created in their workspace.</li> </ul>
Task Assigner	<p>The role or team that needs to respond to the task (Received).</p> <p>Example: Form Task from a request is assigned to Role 301.</p> <ul style="list-style-type: none"> <li>Role 301 is the Task Assigner.</li> <li>Users from Role 301 can see the task in the Assigned tab.</li> </ul>
Task Requester	<p>The role, team or user (request creator) that requests the task to response (Sent).</p> <p>Example: Form Task from a request is requested by Team 403.</p> <ul style="list-style-type: none"> <li>Team 403 is the Task Requestor.</li> <li>Users from Team 403 can see the task in the Requested tab.</li> </ul>

User	Details
Contributor	<p>Users who contributed (or are contributing) to the Task.</p> <ul style="list-style-type: none"> <li>Form and Document Validation Task (Contributor is populated before submit) <ul style="list-style-type: none"> <li>When status is <code>Pending</code>, Contributor is the user assigned or locked to the task. <div style="background-color: #f0f0f0; padding: 2px; margin: 5px 0;"><code>=assigneeID</code></div> </li> <li>or <div style="background-color: #f0f0f0; padding: 2px; margin: 5px 0;"><code>lockedBy</code></div> </li> <li>When is <code>Completed</code>, Contributor is the user who submitted the task <div style="background-color: #f0f0f0; padding: 2px; margin: 5px 0;"><code>=submittedBy</code></div> </li> </ul> </li> <li>Approval Task (Contributor is populated after submit) <ul style="list-style-type: none"> <li>When status is <code>Waiting Approval (0/2)</code>, Contributor is empty</li> <li>When status is <code>Waiting Approval (1/2)</code>, Contributor is the userID of user that approved the task.</li> <li>When status is <code>Approved</code>, Contributor is the array of all users who approved the request. <div style="background-color: #f0f0f0; padding: 2px; margin: 5px 0;"><code>=approvedBy</code></div> </li> <li>When status is <code>Declined</code>, Contributor is the user who declined the request. <div style="background-color: #f0f0f0; padding: 2px; margin: 5px 0;"><code>=declinedBy</code></div> </li> </ul> </li> </ul>

## Visibility and actions of an Approval task

Task sequence:

- Any user who is part of the Responder Group can see the task as it progresses through the sequence.
- Tasks, other than the current Approval Task, are not visible to the Responder Group.

Possible actions for the task:

- Comments history
  - Displays a history of the Approval or Reject comments
- Approve
  - Submits the task with an **Approve** status
  - Adds a comment when submitting an approval
- Reject
  - Submits the task with a **Reject** status
  - Adds a comment when submitting a rejection notice

In cases where users want to notify someone of a specific task, the task reference ID can be found in the URL of an active task.

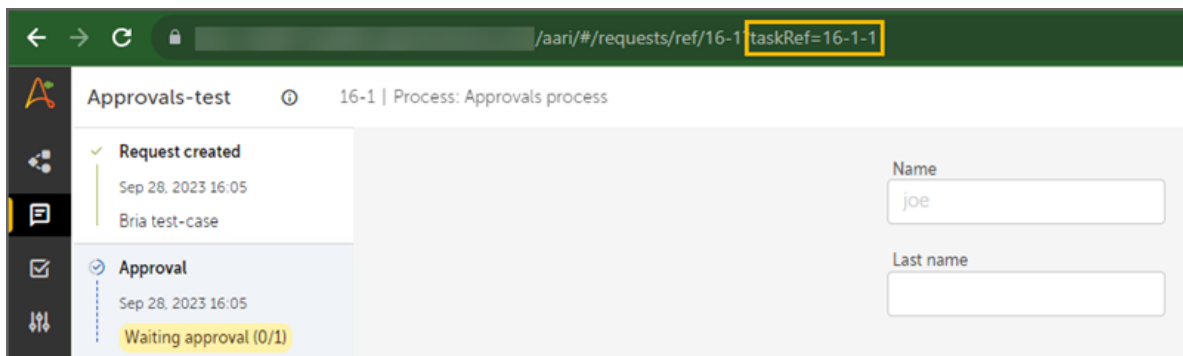

## Add Document Validation to a process automation

You can add a Document Validation Task to configure the settings of a process automation.

1. Add the **Document Validation Task** option to the process automation by dragging the element from the **Task** panel.
2. From the **Document Validation Task** panel:
  - a) Enter a name in the **Element name** field.
  - b) Enter the task name in the **Task name** field.  
The task name appears in the web interface as a reference.
  - c) Optional: Select the **Hide this task from users** check box.  
After task completion, the user does not see the **Document Validation Task** in the web interface.  
To display the hidden task, select the **View hidden tasks** check box in the tasks view page of the web interface.
  - d) Optional: Select the **Auto-assign this task to** check box. You can select the following options from the drop-down:
    - **The user who created the request:** The task is automatically assigned to the user creating the request in the web interface.
    - **The user who opens this task:** The task is automatically assigned to the user who opens the task in the web interface.

- e) Specify the ID in the **Document ID** field.
  - f) Optional: In the **Data privacy tag** field, enter a text or variable to generate hidden custom output.  
Select the **Input values** check box and specify a variable.
    - 1. Select a task in the **Process task** field.
    - 2. Select a type in the **Variable type** field.  
You can select **Input**, **Output**, or **Meta**.
    - 3. Specify your variable in the **Variable** field.
3. Click **Save**.  
You have now configured the Document Validation Task in your Process Composer process automation.

## Add End Point to a process automation

You can add End Point to close your Process Composer process automation or add Go to to navigate to other tasks in the process automation.

You can add the **End point** by dragging the **End process** or **Go to** from the **End point** panel to your process automation.

- From the **End point: End process** panel:
  - a) Select the type in the **End process status** field.  
You can select between **Completed**, **Failed**, or **Cancelled**.
  - b) Optional: Specify a name in the **Update request title** field.
  - c) Optional: Add a message in the **Display message** field.  
The display message you enter is shown in the last step of your task in the request view.
  - d) Click **Apply**.
  - e) Click **Save** to save the process automation.
- From the **End point: Go to** panel:
  - a) In the **Select target task** option, specify the task by choosing **Bot Task** or **Form Task**.
  - b) Select the **Override the task assignment setting** check box and from the drop-down, and then select either **Unassign the task** or **Assign the task to the user who created the request**.  
Depending on your choice, the task is unassigned or the user creating the request can automatically view the task assigned to them in the web interface.
  - c) Click **Save** to save the process automation.

## Example: Upload and view PDF file

This example describes how to use forms to upload and view a PDF file.

You must have the following:

- A Bot Creator license assigned with a custom role that has the create folder permission.
- Access to the Automation Workspace.
- A system-created **AAE\_Robotic\_Interface User** role with the AARI user license for the AARI User.
- Access to the web interface.

Create two forms and a process automation.

1. Log in to the Automation Workspace as a Bot Creator.
2. Create your first form. See [Create a form with the Select File element](#) on page 3471.
3. Create your second form. See [Create a form with the Document element](#) on page 3472.
4. Create a process automation with data from the two forms. See [Create a process automation to view files](#) on page 3472.
5. Run your process automation. Click **Run** in Process Composer.
6. The initial form opens in a separate tab for you to interact. Click **browse** to select a file.
7. Navigate to the file path in your local machine and select a PDF file.

---

**Important:** File size is limited to 50 MB.

---

8. Click **Open** to open the PDF file in your form.
9. Click **Submit**.
10. Click **Done** to confirm the file upload.

The PDF file is successfully uploaded.

## Create a form with the Select File element

You can create a form by using the **Select File** element to select files.

1. Continuing with this example, create the first of two new forms and name it **Select File Form**.
2. Drag and drop the **Select File** element into your form designer from the **Elements** column. The **Properties - Select File** dialog displays with relevant fields.
3. Enter **Upload a file** as the label in the **Element label** field.
4. Specify **PDF** as the file format in the **Enter supported file formats separated by commas** field.
5. Click **Save** to save your form session.
6. Click **Close** to close the current form dialog.
7. Click [Create a form with the Document element](#) on page 3472 to continue the example.

## Create a form with the Document element

You can create a form using the **Document** element to select files.

1. Continuing with the example, create the second of two forms and name it **Document Viewer Form**.
2. Drag and drop the **Document** element into your form designer from the **Elements** column. The **Properties - Form** dialog displays with relevant fields.
3. Optional: Modify your document dimensions or keep the system default settings.
4. Click **Save** to save your form session.
5. Click **Close** to close the current form dialog.
6. To continue the example, click [Create a process automation to view files](#) on page 3472.

## Create a process automation to view files

Create a new process automation to the files.

1. Create a new process automation and name it **View a File Process**. Use Process Composer to design the new process automation.
2. Click the **Start** node (green icon) to add the first node as the entry to your process automation. The **Start** dialog displays with relevant fields.
3. Click the **Browse** option in the **Select initial data** field to search for a form.
4. Click the **Browse** tab in the **Find a form** dialog.
5. Select the **Select File Form** form that you previously created as the first form.
6. Click **Choose** to confirm.
7. Enter **Select File** as the title in **Request title** field. Leave the rest of the entries as is.
8. Click **Save**.
9. Drag and drop the **Form Task** from the **Task** column to your process automation. The **Task: Form Task** dialog displays.
10. Enter **File** as the element name in the **Element name** field.
11. Click the **Browse** option in the **Select form** field to search for a form.
12. Click the **Browse** tab in the **Find a form** dialog.
13. Select the **Document Viewer Form** form that you had previously created as the second form.
14. Click **Choose** to confirm.
15. Specify your button details in the **Add form button** field.  
You can specify **Upload** as the **Button label** and keep the **Primary** setting as the **Button style**.
16. Select the **Document[Document0]** option in the **Feed data into form** field. This displays as a check mark your selected option.
17. Click **Insert a variable** in the blank field.
  - a) Select **Request** as your variable source.
  - b) Select **Input** as your variable type.
  - c) Select **Upload a file[File0]-File** as your variable type. This option should automatically be defined for you to select.
  - d) Click **Add** to add and confirm your variable.



18. Click **Save** to save your session.

## Example: Use Select File to upload or download a file for web

This example describes how to use the **Select File** element to upload or download files that are passed in the initial forms in the web interface.

Before you can upload or download a file using Select File, you must have the following:

- A Bot Creator license with a custom role assigned that has the create folder permission.
- Access to the Automation Workspace.
- A system-created **AAE\_Robotic\_Interface User** role with the AARI user license for the AARI User.
- Access to the web interface.

### File storage service architecture and considerations

The following image describes the architecture of the file storage service:

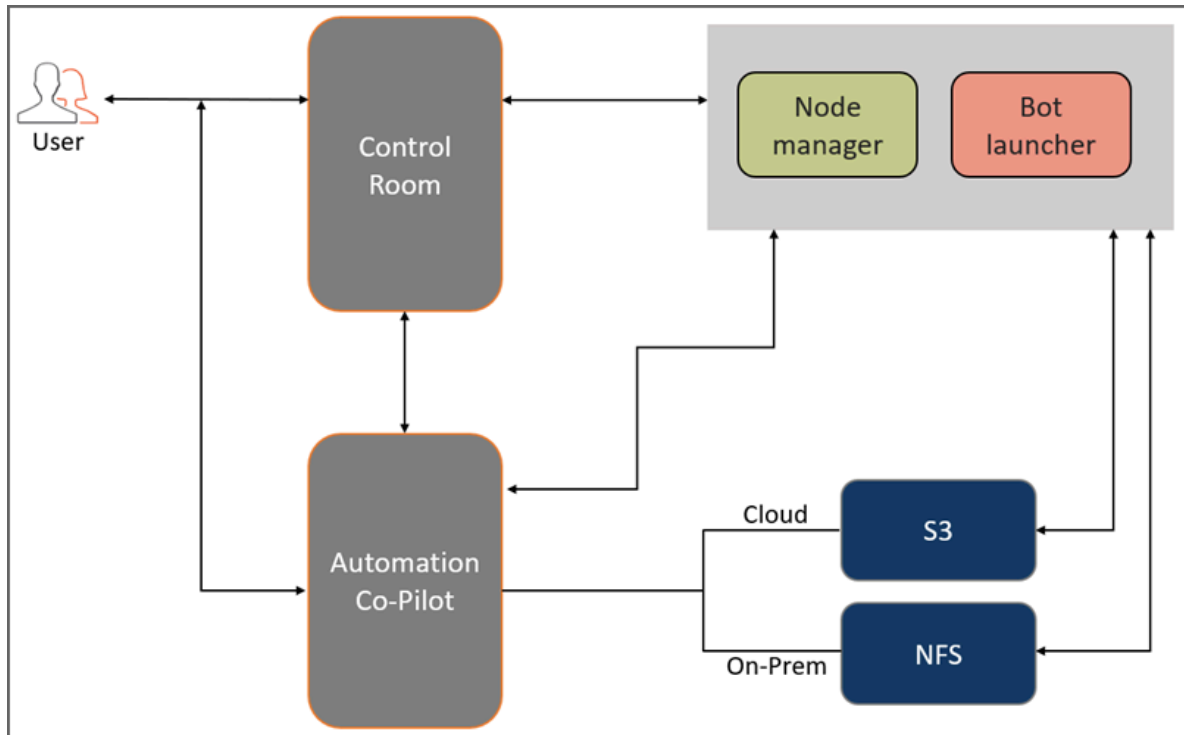

Before you use file storage, review the following storage elements:

Table 11: File storage service, quotas, and life cycle

Storage element	Description
Cloud file storage service	<ul style="list-style-type: none"> <li>• Uses NFS of the Control Room server. Files are in this location: C:\ProgramData\AutomationAnywhere\Server Files\storageservice</li> <li>• Files are categorized by user, consumer (AARI or IQBOT), and dates</li> </ul>
On-Premise file storage service	<ul style="list-style-type: none"> <li>• Uses Amazon S3 services</li> <li>• Storage is migrating to Google Cloud Platform</li> </ul>
Quotas	<p>For all editions (Community, Enterprise Cloud, and Enterprise On-Premise), the following quotas apply to storage:</p> <ul style="list-style-type: none"> <li>• Max File Size = 50 MB</li> <li>• Max Storage Size <ul style="list-style-type: none"> <li>• Base = 250 MB</li> <li>• Additional capacity per licensed AARI User = 1 GB</li> <li>• The Community edition is capped at 250 MB, and a company with 100 active users is capped at 100 GB + 250 MB.</li> </ul> </li> </ul>
File life cycle	<p>A file in storage is deleted when:</p> <ul style="list-style-type: none"> <li>• The request where the file was uploaded is deleted. However, when the request is inside the Recycle Bin, the file remains in storage.</li> <li>• Ninety days have passed since the file was uploaded in storage (regardless of the status of the request).</li> </ul>

To upload or download a file using **Select File**, complete the following:

1. Log in to the Automation Workspace as a Bot Creator.
2. Create a form where the file can be accessed. See [Create a form to view documents](#) on page 3475.
3. Create a bot that can call and store the input file. See [Create a bot with Get Storage file action](#) on page 3476.
4. Create a process that allows users to run the bot and access the file. See [Create a process automation to select a file input](#) on page 3478.

5. Run the process and access the file. See [View uploaded file](#) on page 3481.

## Create a form to view documents

Create a form to upload files and view documents.

1. Create the first of two new forms and name it **File Form**. The new form dialog displays for you to design your form.
2. Drag and drop the **Select File** element into your form designer from the **Elements** column. The **Properties - Select File** dialog displays with relevant fields.

The screenshot shows the Automation Anywhere form designer interface. On the left, the 'Elements' column contains various form components, with 'Select File' highlighted and numbered '2'. The central canvas displays a form titled 'File form' with a blue dashed box containing the text 'Drop file here or browse'. On the right, the 'Properties - Select File' dialog is open, showing fields for 'Element ID' (File0), 'Element label' (Select a file (PDF), numbered '3'), 'Select file format type' (Supported Type selected), and 'Enter file formats separated by commas' (PDF, numbered '4'). The dialog also includes options for 'Enable file download' (checked) and 'Advance behavior' (Make field required and Make field uneditable).

3. Enter **Select a file (PDF)** as the label in the **Element label** field.
4. Specify **PDF** as the supported file format in the **Enter supported file formats separated by commas** field.
5. Click **Save** and close the current dialog.

6. Create the second form and name it **View Document Form**.

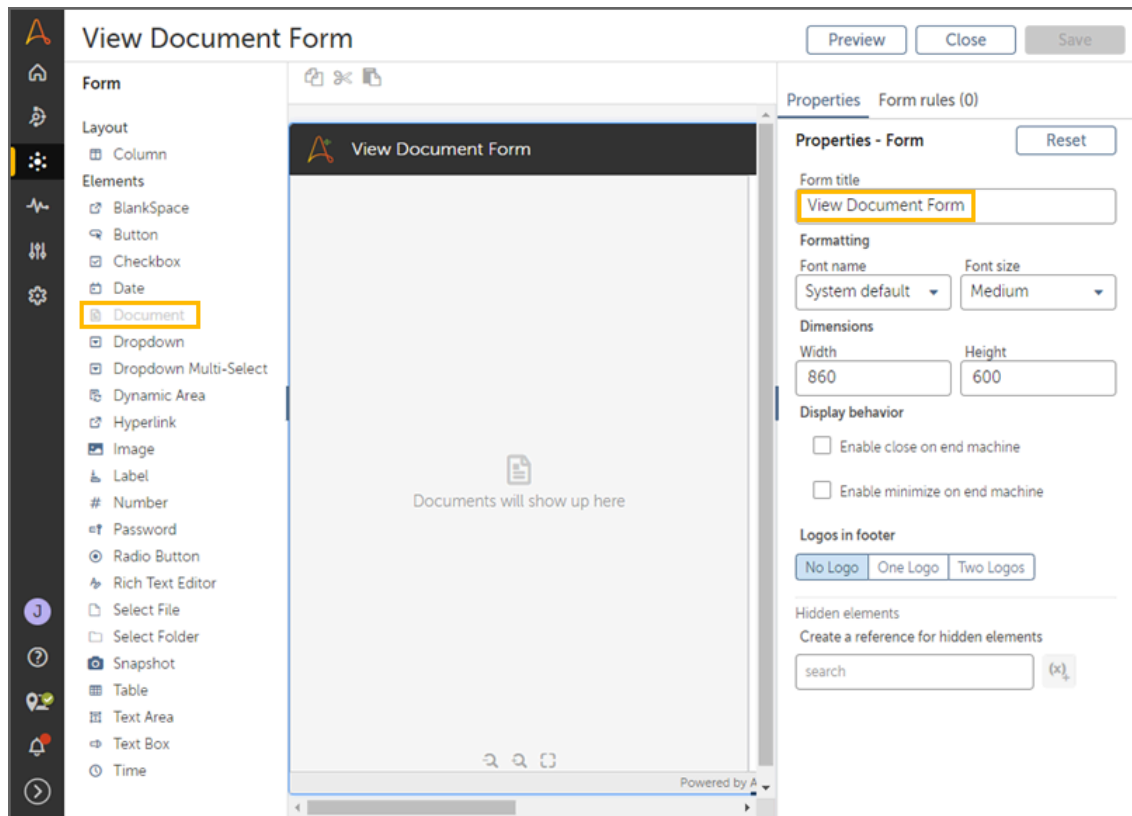

7. Drag and drop the **Document** element into your form designer from the **Elements** column. Optionally, you can use the **Image** element instead of the **Document** element to add an image to your form.

**Note:** The **Document** and **Image** elements provide the same functionality but use different file formats. The file size should not exceed 150 kb (similar to a logo image) and the supported file types are: PNG, JPG, JPEG, and GIF.

8. Optional: You can specify the window formatting and dimensions in the **Properties - Document** window.

9. Click **Save** and close the current window.

You have now successfully created a form with the **Select File** and **Document** elements.

To continue this example and create a bot, see [Create a bot with Get Storage file action](#) on page 3476.

## Create a bot with Get Storage file action

This procedure describes how to build a bot using the **Get Storage file** action in Process Composer.

1. Create a new bot and name it **Bot File**. The new botwindow displays for you to create a bot.
2. Select the plus (+) icon in the **Variables** field. The **Create variable** window displays.

3. Select **File** in the drop-down menu in the **Type**

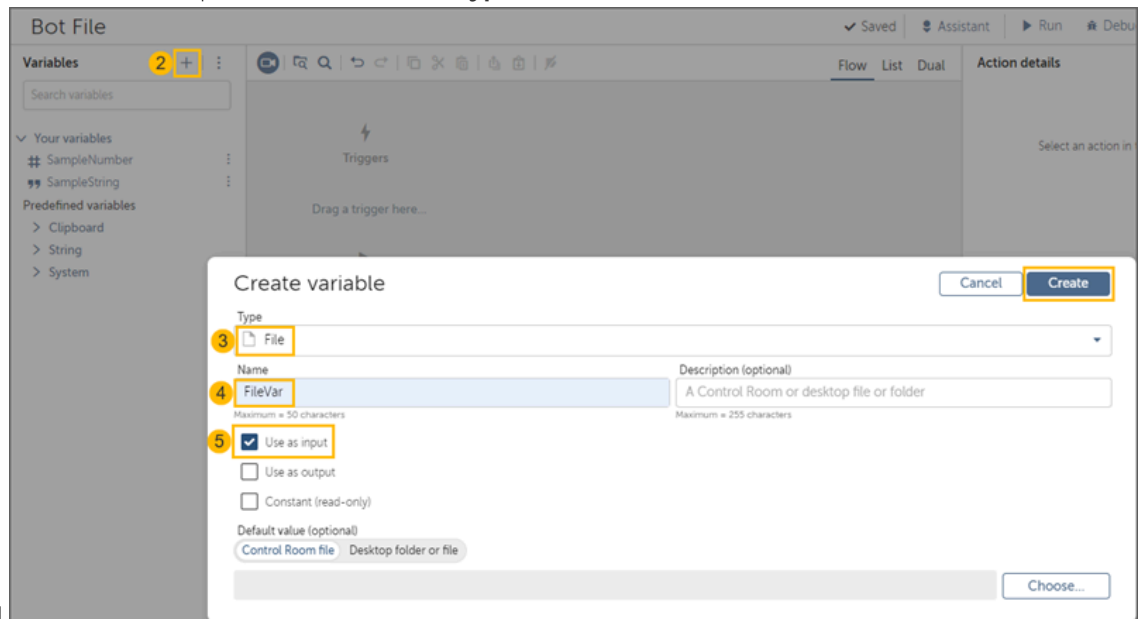

field.

4. Enter **FileVar** as the variable name in the **Name** field.
5. Select **Use as input** only.
6. Click **Create**.
7. Drag the **Get Storage file** action from the **Process Composer** package. The **Process Composer: Get Storage file** window displays.

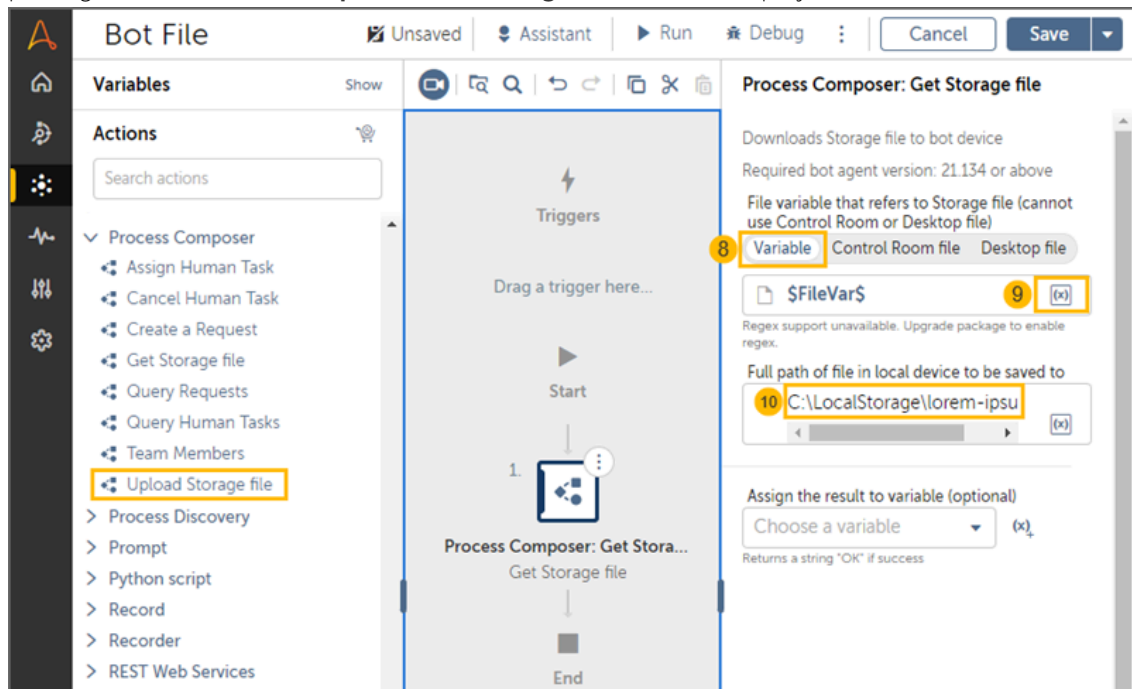

8. Select **Variable**.
9. Select the **FileVar** that you had previously created.
10. Specify the path in the **Full path of file in local device to be saved to** field.

**Important:** The full path of the file includes the name of the file, for example: C:\aari\output\filename.pdf.

**11.** Click **Save**.

You have successfully created a bot with the **Get Storage file** action.

To continue the example and create a process, see [Create a process automation to select a file input](#) on page 3478.

## Create a process automation to select a file input

This procedure describes how to create a process automation to select a file input.

This process automation uses the elements that you previously created from the following topics:

- [Create a form to view documents](#) on page 3475
- [Create a bot with Get Storage file action](#) on page 3476

1. Create a new process automation and name it **Process To Download File** in Process Composer.
2. Click **Process entry**. The **Start** window

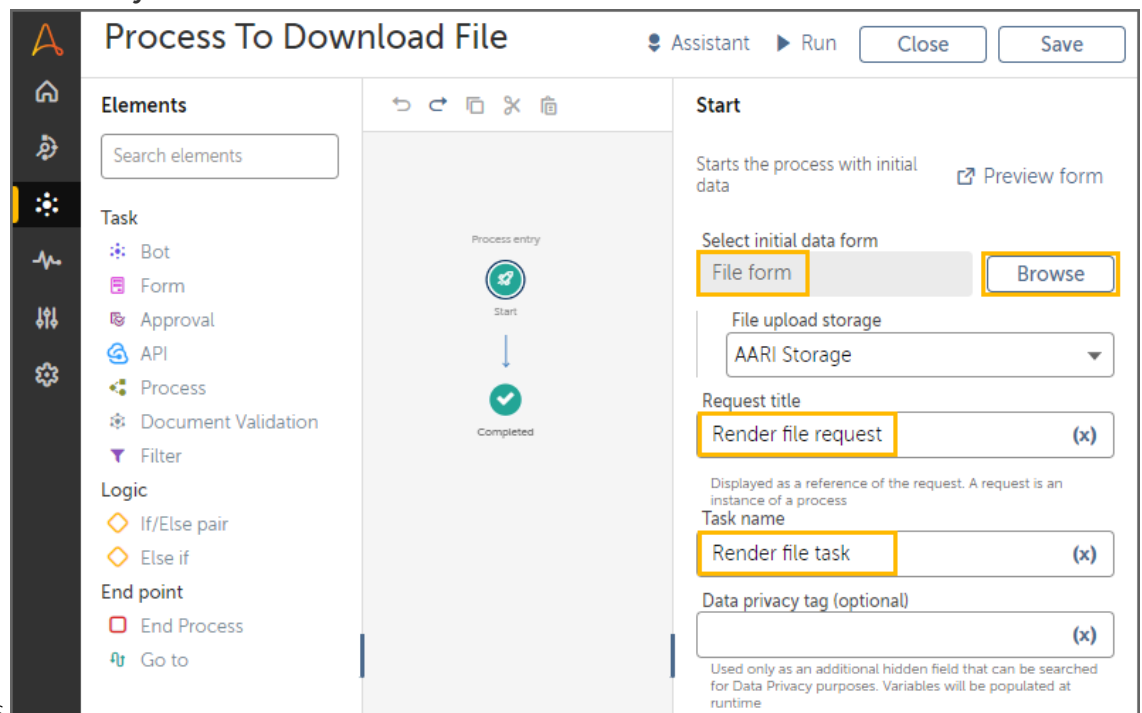

displays.

3. Click **Browse** in the **Select initial data form** field.
4. Set the initial form as **File Form** that you had created.
5. Enter the request title and task name.
6. Click **Save** and close the current window.

7. Drag and drop the **Bot Task** into your process automation from the **Elements** panel. The **Task: Bot Task** window displays.

The screenshot displays the 'Task: Bot' configuration window. The 'Element name' is set to 'Get-file' and the 'Task name' is 'Get-file-task'. The 'Bot queue timeout' is set to 24 hours and 0 minutes. The 'Select bot' field is set to 'Bot File', with a 'Browse' button highlighted. The 'Run bot and dependencies using' option is set to 'Latest version'. The 'Bot priority' is set to 'Medium'. The 'Data privacy tag (optional)' field is empty. The 'Input values' section has 'FileVar' checked, with 'Download' and 'Upload' buttons below it.

8. Enter your element and task name in the **Element name** and **Task name** fields.
9. Click **Browse** in the **Select bot** field and set this as the **Bot File** that you previously created.
10. Set your input value as **Download**.
11. Select the **FileVar** that you had previously created, and set the variable as the document you uploaded as the variable.
12. Click **Save** and close the current window.
13. Drag and drop the **Form Task** into your process automation from the **Element** panel. The **Task: Form Task** window displays. Enter

your element and task name in the **Element name** and **Task name**

The screenshot shows the 'Process To Download File' configuration window. On the left, the 'Elements' panel lists various task types like Bot, Form, Approval, API, Process, Document Validation, Filter, Logic (If/Else pair, Else if), and End point (End Process, Go to). The central area displays a flowchart starting with 'Start', followed by a 'Bot Task Get-file', then a 'Form Task Human-task-form', and ending at 'Completed'. The right-hand 'Task: Form' configuration panel includes several settings: checkboxes for 'Hide this task after completion' and 'Make the form read-only'; a 'Task requester and assignment' section with 'Default' selected; a 'Task contributor' dropdown set to 'The user who opens this task' (callout 13); a 'Select form' section with 'View Document Form' selected and a 'Browse' button (callout 14); a 'Task expiration time' dropdown set to 'No expiration'; a 'Data privacy tag (optional)' field with a clear button (x); an 'Add form button' section with a table for 'Button label' and 'Button style' (callout 16) containing 'OK' and 'Primary'; an 'Add button' button (callout 15); and a 'Feed data into form' section with 'Document[Document0]' selected and the variable '\$Get-file.input[FileVar]\$' entered (callout 17).

fields.

14. In the **Select Form** field, select the **View Document Form** that you previously created.
15. Click the **Add button** option.
16. Specify your button labels and style using the **Button label** and **Button style** fields.
17. Select **Document** in the **Feed data into form** field. Alternatively, you can select **Image** if you had used the **Image** element instead.
18. Enter the file variable to feed into the form.
19. Click **Save** and close the current window.

You have successfully created a process automation to view files.

To continue to upload a file, see [View uploaded file](#) on page 3481.



## View uploaded file

Run your process automation and upload a file to view it.

The following video shows a sample process automaton:

1. Click **Run** to run your process automation from Process Composer.

The initial form window for the **Process To Download File** process automation displays with the **Select a file (PDF)** option for you to upload a file.

2. Click **browse** to select a PDF file in the initial form. You have uploaded your file to the initial form.

---

**Important:** File size is limited to 50 MB.

---

3. Click **Submit**. The request view page displays and the tasks are running. One of the process automation steps will display a preview of the file that was uploaded.
4. Click **Done** to confirm. The PDF file is downloaded to the local machine at the file path you set.
5. Navigate to folder on your local machine (for example: `C:\aari\output`) where you had specified the file path. The downloaded file should now display in the folder location.
6. Click the PDF file to view your file. You have successfully uploaded and viewed the file.

## Cloud storage usage

This topic describes the cloud storage usage details based on the file size that you upload.

### Cloud storage usage details

You can use the **Select File** element to upload files that are stored on the cloud. However to store these files on the cloud, the files must meet the following specific requirements:

Cloud storage quota

The files uploaded by users are based on the maximum file and storage sizes. The cloud storage quota consists of the following:

- The file size for when a user uploads a file using the **Select File** element cannot be greater than 50 MB.

---

**Important:** The file limit is attached to a **Select File** element only; not to a request. Additionally, you can upload only one file for each **Select File** element. However, there is no limit to the number of **Select File** elements that you can add to a form.

---

- The cloud storage can store a maximum of 250 MB of data per tenant.

---

**Note:** This is set by default. The storage limit is per tenant and not per user.

---

- The storage for each tenant is extended to an additional 1 GB for every AARI user license that is allocated in the tenant.

**Important:** These storage restrictions are applied only to the process automation when used in Automation Co-Pilot use cases. However, there are no storage capacity restrictions for Automation Co-Pilot Desktop Assistant storage and use cases.

---

### Retention Policy

The retention policy for files that are uploaded to the cloud storage is as follows:

File will be deleted 90 days after the time of the file upload.

When a request is deleted, the request and the associated file are permanently deleted and not just sent to the recycle bin.

---

**Note:** This is supported for requests which have only one associated file, not multiple files.

---

## Working with process automations in Process Composer

Depending on the business requirements, a Bot Creator can perform other tasks with using a process automation in Process Composer.

After a process automation has been created in Process Composer, a Bot Creator can perform the following tasks:

- Test and [Run a process automation](#) on page 3484: Before you check in a process automation, you can test the process automation by running it in a private or public workspace using the Run option in the Process Composer. The bots in the process automation running in a private workspace execute from the default device of the Bot Creator. When a Bot Creator executes the process automation, they can create a request, enter data in the initial form, and then run their request from the private workspace.
  - Requests created from the process automation executed in a private workspace can be viewed only by the Bot Creator user who created the request.
  - Requests created from the process automation executed in a public workspace can be viewed by the Automation Co-Pilot Admin. Managers and users can view the requests only if they have access to the process automation.
- [Check in a process automation](#) on page 3483: To make a process automation available to other users, you can check in a process automation from a private workspace to a public workspace.
- [Check out a process automation](#) on page 3483: If there is a change in a business requirement, you can check out the process automation from a public workspace to your own private workspace and make changes to the process automation.
- Access a process automation from one Control Room to another by either importing or exporting the process automation:
  - For example, if you developed a process automation and tested it in the staging area and it is now ready for production, you can [Export a process automation](#) on page 3489 from the staging area.
  - Similarly, you can import the exported process automation into the production area. See [Import a process automation](#) on page 3486.

- [Delete a process automation](#) on page 3490: If a business requirement becomes redundant, you can delete the process automation.
- After creating a process automation, you can create an output variable to [Display child process automation output](#) on page 3490 in the parent process automation. The end process can then call the output variable.

## Check in a process automation

Bot Creators can check in a process automation from the private workspace to the public workspace to make it available for other users.

- You must have a Bot Creator license.
- You must be assigned a custom role with the following permissions:
  - Required: Check-in and check-out permission
  - Optional: Create folder permission
  - Optional: View packages permission
- To check in a process automation with dependent folders and files, ensure you have the following:

- Create folder permission.

If you are checking in a process automation from your private workspace and if the folder containing the process automation does not yet exist in the public workspace, then you must have the create folder permission to successfully check in the process automation.

- Check-in permission on the dependency folder.

---

**Important:** If a bot is checked out, edited, and then checked in again, the changes to the bot are reflected immediately. Whereas, if you follow the same procedure for forms, the changes to forms are only reflected when the entire process automation is checked in again.

---

1. Log in to the Control Room as a Bot Creator user.
2. On the left pane, click **Automation**.  
A list of available and forms is displayed.
3. Select the process automation you want to check in, open the actions menu (vertical ellipsis), and click **Check in process**.
4. In the **Check in Process** dialog, add your comment and click **Check in**.  
The process automation displays in the same folder structure in the public workspace.

## Check out a process automation

Bot Creators can check out a process automation from the public workspace to create an editable copy of the process automation.

- Ensure you have the Bot Creator license to check out a process automation to your private workspace.
- To check out a process automation with dependent folders and files, you must have the following:

- Create folder permission
  - Check-out permission on the dependency folder
1. Log in to the Control Room as a Bot Creator user.
  2. In the public workspace, click **Automation**.  
The **Automation** page is displayed with the list of folders or files containing the process automations.
  3. Select the process automation, open the actions menu (vertical ellipsis), and click **Check out process**.  
The process automation appears in the same folder structure in the private workspace.

## Run a process automation

In the Control Room, as a Bot Creator, you can run a process automation from the **Process Composer** in the private workspace.

Best practices:

- When the process automation is executed in the private workspace, the Bot Creator can create a request and enter data in the initial form.

In the private workspace, the bots are executed on the default device of the Bot Creator.

- Requests created from the private workspace can be viewed only by the user creating the request.

The AARI Admin cannot view the process automations executed from the private workspace in the process management page.

- When process automation 1 (parent) calls process automation 2 (child), two requests are generated:
  - Request started by the parent process automation to the child process automation shows the status as pending.
  - Second request started by the child process automation requires the user to complete the first request to proceed.

User must first complete the 2nd request (child process automation) so the callback goes to process automation 1 (parent). The user can then continue with process automation 1 to complete the task.

1. Log in to the Control Room as a Bot Creator user.
2. On the left pane, click **Automation**.  
A list of available and forms is displayed.
3. Click the process automation name.
4. When the process automation opens in the **Process Composer**, click **Run**.  
A dialog opens prompting you with the initial form.

## Move a process automation between folders

After a process automation has been created in Process Composer, a Bot Creator or Citizen Developer user can move the new process automation from one folder to another within a private workspace.

You can move new process automations only. You cannot move any process automations that have the following statuses:

- Cloned
- Checked in
- Checked out
- Edited

**Note:** You cannot move a process automation in a public workspace.

To move a new process automation from one folder to another folder within a private workspace:

1. Log in to the Control Room as a Bot Creator or Citizen Developer user.
2. On the left pane, click **Automation**.  
A list of available bots and process automations displays.

**Note:** You can move process automations only; you cannot move bots.

3. Select the new process automation that you want to move to a different folder.
4. From the right of the selected process automation, open the actions menu (vertical ellipsis) and click the **Move process** icon.



5. From the Find a Folder dialog, select the folder you want to move the process to. If you are unsure, you can click Search or Browse to help locate the folder you want.

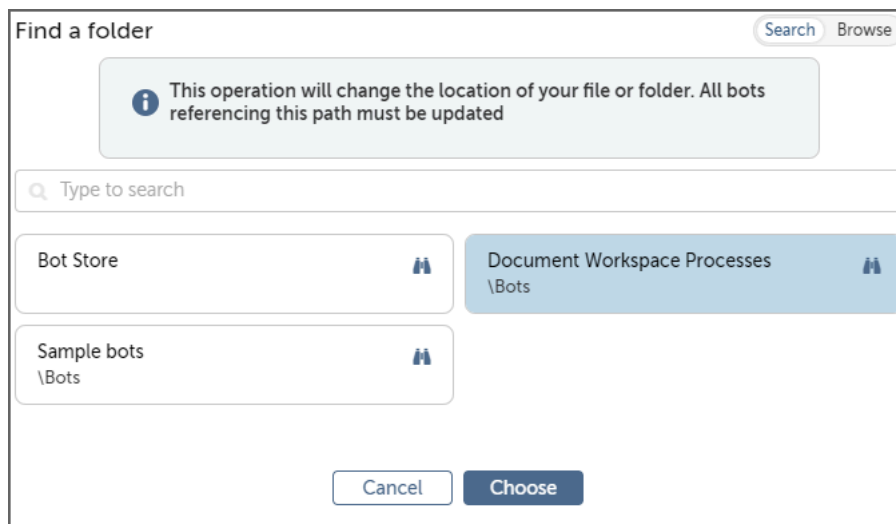

6. Click **Choose** to move the process automation to the new folder path. The process automation displays in its new folder under the files and folders list. As a result, this event is logged in the Control Room for Automation 360 as a Move file audit entry which shows the old and new path of the process automation. For log details, see [Audit events list](#) on page 2144.

## Import a process automation

As a Bot Creator, you can import a process automation from one Control Room to another.

- To import process automations, ensure that you have the following permissions:
  - Import process permission
  - Create folder permission (if required)
  - Check-in permission
  - Manage package permission
- The process automation directory path is case-sensitive. As a result, ensure that the export and import paths use the same case in the Control Room to avoid any process automation execution failure.

In this task, the required process automation is already exported and an email is received with a link to the zip file containing the package to import.

Any previously exported process automation is located in the public repository. It must be imported and checked in so that it can be deployed from the new Control Room.

The imported process automation will be available in the public repository.

1. On the left pane, click **Automation**.  
A list of available and forms is displayed.
2. Click **Import bot**, browse, and then select the process automation to import.

---

**Note:** This option applies to both bots and processes.

---

3. Select the option to import a process automation into the private or public workspace.
4. Set the option for importing the process automation based on whether a previous version of the process automation resides in the destination location.  
During the import, if a file already exists, you can skip the process during import or overwrite the existing process and file.
5. Click the **Import bot** icon.
6. Click **Check in**.  
On completion, the imported process automation is placed in the public repository and is ready to deploy from the new Control Room.

## Import process automation dependencies

When you import a process automation, you might encounter some issues where the import might not work as intended. This topic describes scenarios on how to successfully import a process automation.

### Import process automation scenarios

For these scenarios, a **Parent** process automation has dependencies with a **Child** process automation and a **Test** form, and needs to import from **Environment A** to **Environment B**. The goal is to successfully import from **Environment A** to **Environment B**.

Scenario parameters

- **Parent** process automation uses the **Child** process automation and both use the **Test** form in **Environment A**.
- The export **Child-only** zip file contains the **Child** process automation and the **Test** form.

---

**Note:** You have to manually export the proper files.

---

- The export **Parent-only** zip file contains the **Parent** process automation and the **Test** form.
- The export **Parent-and-Child** zip file contains the **Parent** process automation, the **Child** process automation, and the **Test** form.

Scenario A (Best case)

1. **Environment B** has no files.
2. Import **Child-only** zip file into **Environment B**. The files of **Child** process automation and **Test** form will now exist in the repository.  
Automation Co-Pilot receives a bulk import event of **Child** process automation and **Test** form files, and a new process automation called **Child Process** is successfully created.
3. Import **Parent-only** zip file into **Environment B**. The files of **Parent** process automation and **Test** form will now exist in the repository.  
Automation Co-Pilot receives a bulk import event of **Parent** process automation and **Test** form files. Because **Child Process** exists in Automation Co-Pilot, the **Parent Process** is successfully created.
4. Your import is successful because the **Child Process** and **Parent Process** are created in Automation Co-Pilot.

In this scenario, the import from **Environment A** to **Environment B** was successful because the **Child-only** zip file was imported before the **Parent-only** zip file, therefore the **Child Process** and **Parent Process** were successfully created in Automation Co-Pilot.

This is the best case scenario for a successful import.

Scenario B (Conditional case)

1. **Environment B** has no files.
2. Import **Parent-only** zip file into **Environment B**. The files of **Parent** process automation and **Test** form will now exist in the repository.

Automation Co-Pilot receives a bulk import event of **Parent** process automation and **Test** form files. Because **Child Process** does not exist, this failed to create a **Parent Process**.

3. Import **Child-only** zip file into **Environment B**. The files of **Child** process automation and **Test** form will now exist in the repository.

Automation Co-Pilot receives a bulk import event of **Child** process automation and **Test** form files. A new process called **Child Process** is successfully created.

4. Import **Parent-only** zip file again with **Overwrite existing files into** option selected to **Environment B**. The files of **Parent** process automation and **Test** form will be overwritten in the repository.

Automation Co-Pilot receives a bulk import event of **Parent** process automation and **Test** form files. Because **Child Process** now exists in Automation Co-Pilot, **Parent Process** is now successfully created.

---

**Important:** If the **Overwrite existing files into** is not selected, then no bulk import event is generated because files of **Parent** process automation and **Test** form already exist in repository. Therefore, **Parent Process** cannot be created in Automation Co-Pilot.

---

5. Your import is successful because the **Child Process** and **Parent Process** are created in Automation Co-Pilot.

In this scenario, the import from **Environment A** to **Environment B** can fail if the **Parent-only** zip file was imported before the **Child-only** zip file. Since the **Parent Process** can only be created if the required dependencies from the **Child Process** exist, and the **Child Process** did not exist in the repository, then the **Parent Process** could not be created.

As a workaround to successfully create the **Parent Process**, you can import the **Parent-only** zip file again by selecting the **Overwrite existing files into** option to overwrite the existing repository (only after the **Child Process** was created). This workaround succeeds conditionally only if you selected the **Overwrite existing files into** option. If you did not select this option, then the **Parent Process** cannot be created.

To avoid this issue, you should use Scenario A for a successful import experience.

Scenario C (Worst case)

1. **Environment B** has no files.
2. Import **Parent-and-Child** zip file into **Environment B**. The files that contain the **Parent** process automation, **Child** process automation, and **Test** form will now exist in the repository.

Automation Co-Pilot receives a bulk import event of the **Parent** process automation, **Child** process automation, and **Test** form files. However, because the **Parent** process automation and **Child** process automation relations are not known from the bulk import event, the **Parent** process automation might be processed first. Since the **Child Process** does not exist, then this failed to create a **Parent Process**.

3. Your import failed because the **Child Process** and **Parent Process** were not created in Automation Co-Pilot.

In this scenario, the import from **Environment A** to **Environment B** failed because the **Parent-and-Child** zip file was imported. The bulk import event does not understand the relation between the **Parent** process automation and the **Child** process automation, and might process the **Parent** process automation before the **Child** process automation. As a result, the **Parent Process** cannot



be created because the **Child Process** does not exist; therefore, no new process automation is created in Automation Co-Pilot.

To avoid this issue, you should use Scenario A for a successful import experience.

## Export a process automation

As a Bot Creator, you can export a process automation from one Control Room to another.

- Only process automations within the public workspace can be exported. To export a process automation, check the process automation into the public workspace.
- Ensure that you have the correct role and permissions to export the process automation, including the **View package** permission.
- To receive the link to the exported package through email, enable SMTP. See [Email server settings](#) on page 2528.
- To export the process automation from one Control Room to another, both Control Rooms must be the same version.

The Control Room maintains a maximum of 10 GB of historical export files in the download directory. To maintain this threshold, files are deleted on a first-in/first-out basis.

1. On the left pane, click **Automation**.  
A list of available and forms is displayed.
2. Click the **Export bot**, browse the public directory, and then select the process automation to export.

---

**Note:** This option applies to both bots and process automations.

---

The selected process automation and the required dependencies are displayed.

3. Click **Next**.  
The process automation and its dependencies are ready for export and displayed in the **Review Dependencies** window.
4. Click **Next**.  
All related packages are displayed.
5. Select the necessary packages associated with the process automation to export.  
You can select **Exclude process packages** to remove all packages from the export.
6. Click **Export bots and files**.  
If you have configured SMTP, an email is sent containing a link to the zip file of the exported package.  
If you have not configured SMTP, perform the following steps to access the link to the zip file of the exported package:
  - a) Navigate to **Activity > Historical**.
  - b) Search and view the historical activity of the exported package.
  - c) Click **Download exported zip file**.  
A link to download the zip file is displayed.
7. Use the link to download the zip file and save it to a location for importing it to another Control Room.

Import the process automation to another Control Room.

## Delete a process automation

As an AARI Admin or a user with **Delete from Public** permission, you can delete a process automation from the public workspace.

When deleting a process automation, consider the following:

- You can delete process automations that have open requests.

After a process automation is deleted, you cannot access the process automation even if the requests still exist. The scheduled bots can still be executed, but the forms cannot be submitted. If you republish the same process automation, the old requests can be restored and team permissions can be created again.

- You cannot delete checked-out process automations.

**1.** Log in to the Control Room as an AARI Admin or a Bot Creator user.

**2.** On the left pane, click **Automation**.  
A list of available and forms is displayed.

**3.** Select the process automation you want to delete, open the actions menu (vertical ellipsis), and click **Delete process**.

You must first delete the process automation before you can delete the bots or forms within the process automation.

**4.** Select **Yes, delete** to confirm.

When the process automation is deleted from the public workspace, it is removed from the process management page in the web interface. Additionally, if the process automation is already assigned to any AARI User or team, access is removed after the process automation is deleted from the public workspace.

## Display child process automation output

Bot Creators can create an output variable to display the output of a child process automation in the parent process automation.

After a Bot Creator has created a process automation in Process Composer, they can create an output variable that can be used in the end process.

- To create an output variable:
  - a)** Navigate to the **Output variables** section.
  - b)** Click **Show**.
  - c)** Click the plus (+) icon.  
The **Create variable** dialog displays.
  - d)** Enter the name of the variable in the **Name** field (for example, **output**).
  - e)** Select your variable type in the **Type** field (for example, **String**).
  - f)** Optional: Enter the variable information in the **Description** field.
  - g)** Optional: Enter a default variable in the **Default value** field.

You need to insert a variable:

- a) Select a source in the **Variable source** field (for example, **botTask**).
  - b) Select **Output** as a **Variable type** option.
  - c) Select a variable in the **Variable** field (for example, **output**).
  - d) Click **Yes, insert** to confirm your changes.
- h) Click **Create**.
- You have now created a new output variable! This output variable is now included in the **User-defined** variables in the **Output variables** section.
- To edit or delete an existing output variable:
    - a) Navigate to the **Output variables** section.
    - b) Select the three dots icon next the user-defined output variable (for example, **output**).
    - c) Optional: Select the **Delete variable** to delete the current variable.
    - d) Select the **Edit variable** to edit the current variable.  
The **Edit variable** window prompts you to add any new changes to your current variable.
    - e) Click **Apply** to save your changes.

## Process Composer and Co-Pilot for Business Users

As a Bot Creator user, you can create a process automation in Process Composer and then run the process automation in Automation Co-Pilot as an automated task.

[Automation Co-Pilot for Business Users](#) on page 3296 is a user-interface that enables real-time communication between users and bots. Using Automation Co-Pilot for Business Users, you can automate repetitive and time-consuming tasks, navigate controls, and input data when interacting with a customer.

As a Bot Creator user, you can configure a process automation in the **Process Composer** in the **Control Room**. Using the **Process Composer** drag-and-drop interface, users can create process automations and configure when a bot should be executed. It also displays correct data to users and exchanges that data across multiple teams.

The following video shows how to create a process automation in **Process Composer** and then launch it in **Automation Co-Pilot for Business Users** as an automated task:

To learn how an insurance company used **Automation Co-Pilot for Business Users** and **Process Composer** to generate a policy quote for a new homeowner, see [Scenario: Generating insurance quote with Automation Co-Pilot and Process Composer](#) on page 3617.

## API Task

API Task is an API-based cloud automation solution that harnesses the power of APIs to facilitate seamless data exchange between disparate systems and applications at an unprecedented speed.

API Task's real-time data exchange capabilities enable it to adapt to dynamic environments and respond promptly. Use API Tasks to create automations using packages that are supported on

Automation 360 Cloud. For instance, API Tasks work with our packages that do not intervene with the file system such as Salesforce, ServiceNow, Workday, REST, and SOAP to automate workflows and processes. You cannot use an API Task to automate a desktop operation.

**Note:** API Tasks are like Task Bots, but they do not use the local Bot Runner devices, but instead run entirely in the Cloud managed by Automation Anywhere.

You can create an API Task in the API editor just like Task Bots. This API Task can then be invoked in either a form or a process depending on your specific requirements.

### Invoking API Task in form

Invoking an API Task in a form provides you with an immediate response after the initial run, ensuring that your processes receive immediate attention. During the initial run, the API Task or API Tasks within the Process are deployed in the cloud, enabling subsequent requests to be processed without any delay. To ensure optimal performance and scalability, API Tasks are intelligently pre-warmed on a dynamic number of cloud devices, to adapt to your concurrency needs. The diagram below describes the workflow to follow while invoking an API Task within a form.

**Note:** Pre-warming is a process in which the admin or a team manager adds the API Tasks to the cloud and the API Tasks are pre-deployed in cloud devices. The cloud devices are managed on the Automation 360 infrastructure.

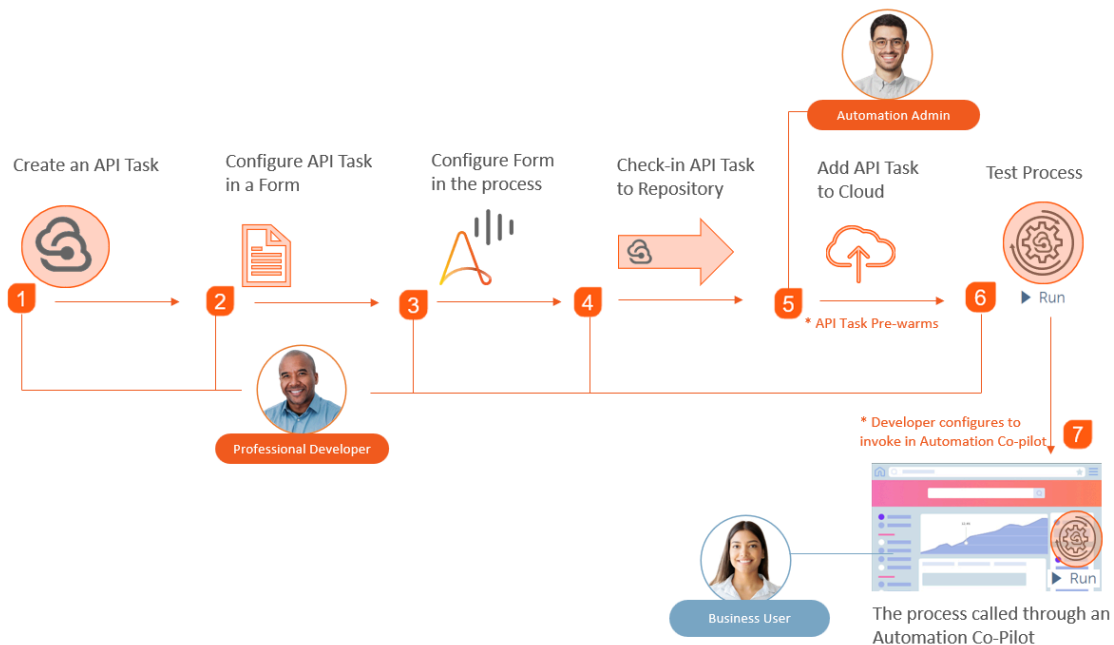

### Real-Time Response: Empowering Users with Instantaneous Results

- Ideal for Forms: When users expect immediate response.
- Key Features:
  - Pre-configured cloud device allocations for seamless execution.
  - Strict concurrency limits for optimal performance.

- 1-minute execution cap for rapid completion.

Item	Description
1	<a href="#">Create an API Task (API Task in form)</a> on page 3494
2	<a href="#">Configure an API Task in a form</a> on page 3499
3	<a href="#">Configure a form with API Task in a process</a> on page 3500
4	<a href="#">Check in API Tasks to Repository</a> on page 3501
5	<a href="#">Add API Task to Cloud</a> on page 3502
6	<a href="#">Test Process (API Task in form)</a> on page 3503
7	Invoke the API Task through an Automation Co-Pilot, see <a href="#">Automation Co-Pilot for Business Users</a> on page 3296

### Invoking API Task in process

Invoking an API Task in a process provides the flexibility to execute API Tasks in the background, allowing your processes to continue without interruption. This approach is particularly useful for tasks that can take longer to complete, as it ensures that your overall workflow remains efficient. The diagram below describes the workflow to follow to build a process that invokes an API

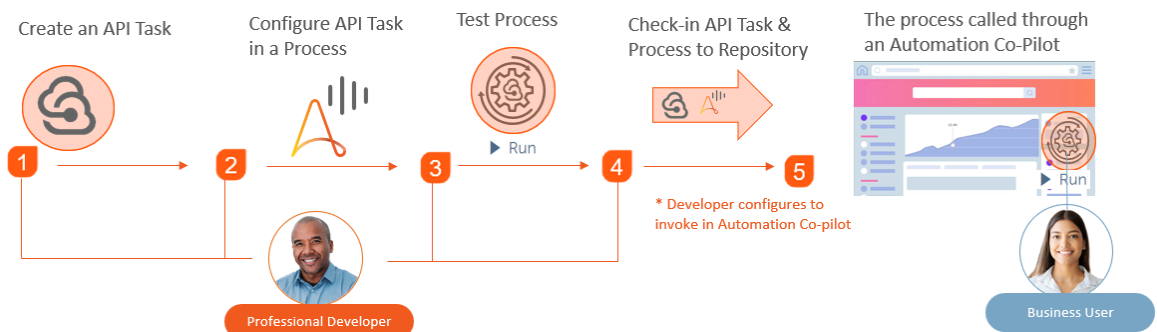

Task.

On-Demand Execution: Effortless automation within processes

- Ideal for Processes: When tasks can run asynchronously, aligning with longer workflows.
- Key Features:
  - Intelligent queuing for excess requests, ensuring execution as devices become available.
  - Concurrency limits for resource optimization.

- Extended 15-minute execution window for more complex tasks.

Item	Description
1	<a href="#">Create an API Task (API Task in Process)</a> on page 3504
2	<a href="#">Configure API Task in process</a> on page 3506
3	<a href="#">Test Process (API Task in process)</a> on page 3507
4	<a href="#">Check in API Tasks to Repository</a> on page 3501
5	Invoke the API Task through an Automation Co-Pilot, see <a href="#">Automation Co-Pilot for Business Users</a> on page 3296

Unlike Attended or Unattended deployments, API Tasks leverage cloud-based bots (API Tasks) for deployment, eliminating the need for physical devices. This headless approach offers scalability and flexibility, enabling you to automate your processes from anywhere, at any time. The below table shows and compares the various deployments.

Attended Deployment	Unattended Deployment	Headless Deployment (API Task)
Requires a physical device to execute tasks, suitable for tasks that require human interaction.	Requires a physical device to execute tasks, suitable for tasks that can be completed independently.	Cloud-based deployment eliminates the need for physical devices, offering scalability and flexibility.

## Invoking API Task in form

### Create an API Task (API Task in form)

Create an API Task with the packages available in the Control Room in the API Task editor. You can create an API Task with actions from packages that are supported on Automation 360 Cloud.

You must have a Bot Creator license.

This topic describes how to create an API Task by using an API that takes a ZIP code in the USA as input and returns the place and state name as output. You can create an API Task with the actions that are specific to your use case.

1. Log in to your instance of the Automation Anywhere Control Room as a Bot creator.
2. Create a new API Task:
  - a) From the left pane, click **Automation**.
  - b) Click **Create new > API Task**.

- c) In the **Create API Task** window, enter the API Task name.
  - d) Accept the default folder location: \Bots\.  
To change where your API Task is stored, click **Choose** and follow the prompts.
  - e) Click **Create & edit**.
3. Create a ZipCode variable as an input that will be used in the ZIP code URL.
  4. Use the **Get method** action to retrieve the place and state of a ZIP code.

**Note:** Pre-built packages are available for most common enterprise applications. For a list of supported packages, see [Table 1](#).

- a) Double-click or drag the **REST Web Services > Get method** action.

- b) Enter the following URI. \$ZipCode\$ in the URI is the input variable created in [Step 3](#).

```
https://api.zippopotam.us/us/$ZipCode$
```

- c) In the **Authentication Mode** drop-down list, select **No Authentication** because this endpoint does not require authentication.

**Note:** Typically, endpoints require authentication to ensure that only authorized applications can access the data. Select an appropriate authentication mechanism to allow access to the endpoint you want to access.

- d) Create the variable `jsonResponse` in the **Assign the output to a variable** field. For more information on creating a variable, see [Create a variable](#) on page 2336.

**Note:**

- The complete API JSON response is assigned to this dictionary variable: `jsonResponse`.
- The following variable types are not supported for API Tasks: File, Window, and Form.

5. From the Actions pane, drag the **Dictionary > Get** action and drop it into the canvas below the **REST Web Services** action.
- In the **Dictionary variable** field, select `jsonResponse`.
  - In the **Key** field, enter `Body`.
  - In the **Assign the output to variable** drop-down list, select **SampleString**. From the entire `jsonResponse`, store only the `Body` value to a variable (**SampleString**)

The screenshot shows the configuration of the 'Dictionary: Get' action. The action is placed below the 'REST Web Services: Get method...' action. The configuration fields are:

- Dictionary variable:** `jsonResponse` (labeled 'a')
- Key:** `Body` (labeled 'b')
- Assign the output to variable:** `SampleString` (labeled 'c')

You now have the entire `Body`. The next task is to extract the required fields from the body. The following shows a sample JSON `Body`:

```
{
  "post code": "90210",
  "country": "United States",
  "country abbreviation": "US",
  "places": [
    {
      "place name": "Beverly Hills",
      "longitude": "-118.4065",
      "state": "California",
      "state abbreviation": "CA",
      "latitude": "34.0901"
    }
  ]
}
```



6. Extract the place name from the JSON.
  - a) From the Actions pane, drag the **String > Extract text** action and drop it into the canvas below the **Dictionary > Get** action.
  - b) Specify from where to start or end the extraction of the string.
  - c) Create a variable Place and assign the output to this variable.

The screenshot displays the Automation Anywhere interface. On the left, a workflow canvas shows a sequence of actions: 1. Dictionary: Get (value of the key "Body" from \$...), 2. String: Extract text (Source string \$\$SampleString\$...), 3. String: Extract text (Source string \$\$SampleString\$...), 4. String: Extract text (Source string \$\$SampleString\$...), 5. Comment "test", and finally End. The third action is highlighted with a yellow box. On the right, the configuration panel for the 'String: Extract text' action is shown. It includes a title bar, a description, and a required bot agent version. The configuration fields are: Source string (optional) set to '\$\$SampleString\$'; Get characters set to 'Before and/or after'; Start after text (optional) set to '"place name": '; Occurrence set to '# 1'; End before text (optional) set to '"'; Occurrence set to '# 1'; Match case selected; Trim the extracted text (remove blank spaces) checked; Remove Enter from the extracted text checked; and Assign the output to variable set to 'Place'. The 'Start after text', 'End before text', and 'Assign the output to variable' fields are highlighted with yellow boxes.

7. Extract the state from the JSON.
  - a) From the Actions pane, drag the **String** > **Extract text** action and drop it into the canvas below the previous **String** > **Extract text** action.
  - b) Specify from where to start or end the extraction of the string.

c) Create a variable **State** and assign the output to this variable.

**8.** Click **Save**.

To test the API Task, click the **Debugger**. While debugging, the local device is used to execute the API Task. The API Task created in this sample retrieves the **Place** and **State** for any ZIP code inputs.

## Configure an API Task in a form

Create and configure a form to invoke the API Task and map the API Task variables to the required fields in the form.

- You must have a Bot Creator license.
- You must first create an API Task to invoke it in the form.

This topic describes how to invoke an API Task in a form. In this example, you will create a ZIP code form that invokes an API Task to retrieve the `place` and `state` details based on the ZIP code input provided. The form created is executed through a process. You can create a form with the fields that are specific to your use case.

**1.** Navigate to an existing form or create a new form where you want to invoke an API Task. For more details, see [Create a form](#) on page 3438.

Name this form as **API Task - ZIP Code Form**.

**2.** Design a Form: Use the form elements to construct an interactive form based on your use case. In this example, the form is designed for mapping the ZIP code variables from the API Task.

**a)** From the **Elements** column, drag the **Text Box** element and drop it into your form designer.

The **Properties** tab appears with the relevant fields on the right side of the screen.

**b)** Enter an **Element label**. For example: **Zip code**.

**c)** Drag the **Button** element and drop it the designer below the **Zip code** text box. Enter a name for this button in the **Button-text (required)** field as **Submit**.

**d)** Additionally, drag two more **Text Box** elements and name them **Place** and **State**.

**3.** Add the **Form rules**. Form rules provide the conditions required for each element in the form. You can set form rules using the **if and then** conditions and specify the actions that will be executed when the conditions are met. In this example, the form rules are configured so that when a **Zip code** is entered and **Submit** button is pressed, the **place** and **state** element box will retrieve the values from the API Task variables. During execution, the API Task will not perform as expected if the form rule conditions are not satisfied.

**a)** Click the **Form rules** tab.

**b)** If desired, enter a name for the rule. (For example, **API Task call**).

- c) Enter an **If** condition to validate if the button is

powered.

- d) To define the **Then** clause, select **Form actions** and then from the drop-down, select **Get value from API call**.
- e) You can map variables associated to the API Task to a form using the **Add variable mapping** option.

**Note:** If you edit a published API Task and add additional variables after you have checked the task in, the variables will not display in the form. You must check-in the API Task after adding the variables.

- f) Click **Browse** to select a specific API Task to perform a specified operation. In this example, an API Task (API Task - Zip Code ) is selected to retrieve the Place and State of any Zipcode.

## Configure a form with API Task in a process

You can add a form that invokes an API Task in a process automation.

- You must have a Bot Creator license.
- You must have created and configured a form with an API Task embedded before adding it into a process. For more details, see [Configure an API Task in a form](#) on page 3499.

Efficiently Integrate API Tasks into Processes for Streamlined Data Retrieval:

This example demonstrates how to leverage the API Task - ZIP code, previously configured within a form ([Configure an API Task in a form](#) on page 3499), within a process automation workflow. For a detailed guide on incorporating forms into your processes, see [Add Form Task to a process automation](#) on page 3458. Notably, invoking an API Task offers significantly lower latency compared to calling a Task Bot. This method allows for flexible creation of process automations that integrate forms with corresponding API Tasks tailored to your specific needs.

1. Create a new process.
  - a) Access the Control Room on your local machine, logging in as a Bot Creator.
  - b) Navigate to the left pane and select **Automation**.
  - c) Click **Create new > Process**.
  - d) On the **Create process** page, provide a descriptive name for the new process, such as ZIP code process.  
Processes are saved in the `\Bots\` folder. Click **Browse** to change the default folder. You can place the process in the same folder as the associated API Task and form for better organization.
  - e) Click **Create & edit** button to proceed.
2. Define Process Start with Initial Form and API Task
  - a) Click **Start (Process entry)** to add an initial form with an embedded API Task. The **Start** configuration options appear on the right side of the screen.
  - b) Click **Browse to Select initial data form**. For this example, select the API Task - ZIP code form that you previously created in [Configure an API Task in a form](#) on page 3499.
  - c) In the **Request title** field, enter any text. For example: ZIP code details request.
3. Click **Save**.

## Check in API Tasks to Repository

To make an API Task available, check in the API Task from the private workspace to the public workspace. Perform this operation after adding the API Task to a form and process.

Ensure the following prerequisites are met for you to check-in an API Task.

---

**Note:** A bot developer can test a process without checking in the API Tasks.

---

- Bot Creator license to check in an API Task to the public workspace.
- A custom role with the following permissions:
  - Required: Check in permission at the folder level and at the corresponding parent folder level in the public workspace.
  - Optional: Create folder permission.
  - Optional: View packages permission.
- To check in an API Task with dependent folders and files, ensure you have the following:
  - Create folder permission.

If you are checking in an API Task from your private workspace and if the folder in which the API Task is present does not yet exist in the public workspace, you must have create folder permission to successfully check in the API Task.

- Check in permission on the dependency folder.
  - Ensure that your private and public workspaces have the same folder structure so that when you check in an API Task from your private workspace, it will appear in the same folder structure as in the public workspace.
1. Log in to the Control Room as a Bot Creator user.
  2. On the left pane, click **Automation**.  
A list of available and forms is displayed.
  3. Choose to check in either one API Task, or multiple API Tasks simultaneously.
    - Select the API Task that you want to check in, click the actions menu (vertical ellipsis), and click **Check in** API Task.
    - Select the API Task that you want to check in and click **Check in checked items**.
- 
- Note:** You can check in up to 10 items at a time.
- 
4. In the **Check in** window, add your comment and click **Advanced options**. Select the dependencies you want to check in and click **Check in**.  
The API Task appears in the same folder structure as in the public workspace and directly referenced dependencies are automatically checked in.

## Add API Task to Cloud

After an API Task is checked in, you must add the API Task to cloud for you to make it available for testing or using it within an Automation Co-Pilot.

- You must have admin privileges to add an API Task to the cloud.
- To facilitate communication between Control Room and cloud devices, a Control Room admin needs to perform the following actions to Generate a registration key to use for bulk bot agent installation:
  - Navigate to **Administration > Settings > Bot agent bulk install**.
  - click **Edit**, the **Generate a new key** option is selected by default.
  - Click **Save changes** to generate a registration key.

To enable API Tasks in cloud, do the following:

1. Navigate to **Administration > Settings > Cloud device management**.
2. In the **Concurrency management**, increase or decrease the API Tasks concurrency limit.  
Control Room gives you complete control over concurrency with flexible limits that adjust based on your license tier. By default, you have one dedicated session for each API Task in forms and processes, ensuring smooth performance and efficient resource utilization.
3. In the **API Tasks in Forms**, move your mouse over the plus sign and click **Add API Task allocation**.
4. In the **Find an API Task**, click **Browse** and locate the API Task you want to add to the cloud. For example, API Task - ZIP code.

---

**Tip:** A default run-as-user (apitaskrunner) is automatically assigned to each API Tasks added to the **Cloud device management**. To change the default user, click the actions menu (three

vertical ellipsis) located to the right of each allocated device session and click **Assign run-as user** and select a user.

To learn about **Cloud device management** (Concurrency management and Adding API Task to form), see [Cloud device management \(API Task\)](#) on page 1856.

## Test Process (API Task in form)

Once you have configured a form with an API Task you will be able to test the process.

This topic describes about testing the process after it has been configured with API Tasks.

1. Make sure you have configured a form as described in [Configure a form with API Task in a process](#) on page 3500. For example, API Task - ZIP code.
2. Click **Run** to run the process. In our example, the running process invokes the form containing an API Task and then invokes an API Task directly in the process. A form appears. Enter a Zip Code and click **Submit** to retrieve the Place and

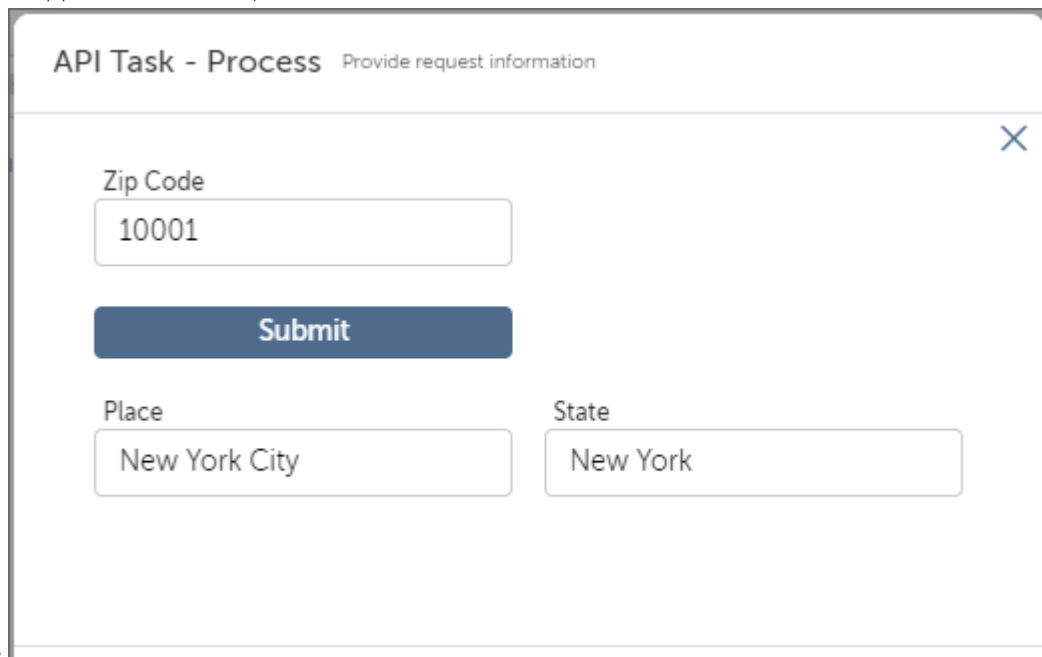

The screenshot shows a web form titled "API Task - Process" with the subtitle "Provide request information". The form has a close button (X) in the top right corner. It contains the following fields and buttons:

- Zip Code**: A text input field containing the value "10001".
- Submit**: A dark blue button with white text.
- Place**: A text input field containing the value "New York City".
- State**: A text input field containing the value "New York".

State.

The Place and State are retrieved.

Thus, API Tasks, embedded within forms, unlock real-time automation for seamless user experiences and immediate response.

## Invoking API Task in process

### Create an API Task (API Task in Process)

Create the essential API Tasks for your automation, utilizing the readily available packages within the API Task editor.

You must have a Bot Creator license.

This topic describes the first step of crafting the API and Bot Tasks that will orchestrate the automation process. In this example, let us consider a sending a "Hello World" message using an API Task to Microsoft Teams.

1. Log in to your instance of the Automation Anywhere Control Room as a Bot creator.
2. Create a new API Task:
  - a) From the left pane, click **Automation**.
  - b) Click **Create new > API Task**.
  - c) In the **Create API Task** window, enter the API Task name.
  - d) Accept the default folder location: `\Bots\`.  
To change where your API Task is stored, click **Choose** and follow the prompts.
  - e) Click **Create & edit**.

In this example, an API Task is created that calls an API to send a "Hello World" message on Teams.

3. Use the **Post method** action to send a message in Teams.

---

**Note:** Pre-built packages are available for most common enterprise applications. For a list of supported packages, see [Table 1](#).

---



- a) Double-click or drag the **REST Web Services > Post method**

action.

- b) You can use the Graph API to send a chat message on Teams. For more information, see <https://learn.microsoft.com/en-us/graph/api/chat-post-messages>.
- c) In the **Authentication Mode** drop-down list, select **No Authentication** and click **Add header** to input the bearer token. In this example, the bearer token is stored in a variable (in\_graph\_bearertoken).

**Note:** Typically, endpoints require authentication to ensure that only authorized applications can access the data. Select an appropriate authentication mechanism to allow access to the endpoint you want to access.

- d) Under **Content type**, make sure **JSON (application/json)** is selected and enter the following JSON in **Custom parameters**.

```
{
  "body": {
    "content": "Hello World"
  }
}
```

- e) Assign the output of the API to a variable (o\_teams).

## Configure API Task in process

You can directly configure API Tasks within a process automation.

An admin needs prerequisites:

- You must have admin privileges to add an API Task to the cloud.
- To facilitate communication between Control Room and cloud devices, a Control Room admin needs to perform the following actions to Generate a registration key to use for bulk bot agent installation:
  - Navigate to **Administration > Settings > Bot agent bulk install**.
  - click **Edit**, the **Generate a new key** option is selected by default.
  - Click **Save changes** to generate a registration key.

A bot creator prerequisites:

- You must have a Bot Creator license.
- If you have configured a form with API Tasks, then make sure to [Configure an API Task in a form](#) on page 3499.

This example delves into sending a Microsoft Teams chat message via API Tasks within your process:

1. Create a new process.
  - a) Access the Control Room on your local machine, logging in as a Bot Creator.
  - b) Navigate to the left pane and select **Automation**.
  - c) Click **Create new > Process**.
  - d) On the **Create process** page, provide a descriptive name for the new process. Processes are saved in the `\Bots\` folder. Click **Browse** to change the default folder. You can place the process in the same folder as the associated API Task and form for better organization.
  - e) Click **Create & edit** button to proceed.

2. Define a process with an API Task
  - a) Drag and drop the **API** element.
  - b) In the **Element name** field, enter a name. For example: SendMessage.
  - c) Enter a Task display name.
  - d) Click **Browse** to locate and select an API Task. Select the API Task created in [Create an API Task \(API Task in Process\)](#) on page 3504.

The example invokes an API Task that sends a message to Microsoft Teams.

## Test Process (API Task in process)

This topic will walk you through testing a process that has been configured with API Tasks.

- You have successfully configured API Tasks within your process as outlined in the [Configure API Task in process](#) on page 3506.
- You have a basic understanding of testing the process.

This is an essential step to ensure that your process is working as expected and properly communicating with external applications.

1. Locate the process ([Configure API Task in process](#) on page 3506) you want to test and click **Run** to run the process. This will start the process execution.
2. Observe API Task Execution: The API Task sends a chat message - "Hello World" to the specified channel.

## Check in API Tasks to Repository

To make an API Task available, check in the API Task from the private workspace to the public workspace. Perform this operation after adding the API Task to a form and process.

Ensure the following prerequisites are met for you to check-in an API Task.

---

**Note:** A bot developer can test a process without checking in the API Tasks.

---

- Bot Creator license to check in an API Task to the public workspace.
- A custom role with the following permissions:
  - Required: Check in permission at the folder level and at the corresponding parent folder level in the public workspace.
  - Optional: Create folder permission.
  - Optional: View packages permission.
- To check in an API Task with dependent folders and files, ensure you have the following:
  - Create folder permission.

If you are checking in an API Task from your private workspace and if the folder in which the API Task is present does not yet exist in the public workspace, you must have create folder permission to successfully check in the API Task.
  - Check in permission on the dependency folder.
- Ensure that your private and public workspaces have the same folder structure so that when you check in an API Task from your private workspace, it will appear in the same folder structure as in the public workspace.

1. Log in to the Control Room as a Bot Creator user.
2. On the left pane, click **Automation**.

A list of available and forms is displayed.
3. Choose to check in either one API Task, or multiple API Tasks simultaneously.
  - Select the API Task that you want to check in, click the actions menu (vertical ellipsis), and click **Check in** API Task.
  - Select the API Task that you want to check in and click **Check in checked items**.

---

**Note:** You can check in up to 10 items at a time.

---

4. In the **Check in** window, add your comment and click **Advanced options**. Select the dependencies you want to check in and click **Check in**.

The API Task appears in the same folder structure as in the public workspace and directly referenced dependencies are automatically checked in.

## Preprocessing error messages

If you encounter any preprocessing errors, review the cause and perform the required action to resolve the error.

If you build a bot that has more than 2,000 lines of code, and if the bot uses descendant actions such as **Loop** > **Continue** or **Break** actions, pre-processing errors can occur. To prevent pre-

processing errors, we recommend that you break the larger bot into smaller bots, and run the **Task Bot > Run** action from any other bot.

**Note:**

- From Automation 360 v.23, if an error occurs when you run a bot, a preprocessing or runtime error is shown. Note that preprocessing of child bots does not occur in sequence because these bots are referred in the parent bot and are sometimes in complex nested workflows. Therefore, the errors might be displayed in any sequence for these child bots. The parent bot cannot proceed further until all the errors in the child bots are resolved.
- The following scenarios are applicable only to Automation 360 v.21 or earlier releases. For v.22, Only the Catch action scenario is applicable, so review the probable cause.

Cause	Action required
A mismatch occurred and we did not find the expected variable data type.	Use an inline expression or a separate action to convert to the correct variable data type. <a href="#">Variables overview</a> on page 2326
A "\$" is being read as a variable but no such variable exists.	Use "\$\$" to escape the dollar sign and try again.
The bot is calling another bot, but we did not find the child bot at the specified location.	Check the path and try again.
We found a Catch action that is not contained by a Try action.	Ensure that each Catch action is contained by a Try action.
We found a Try action that does not contain a Catch action. Each Try action requires at least one Catch action inside it.	Ensure that each Try action contains a Catch action.

## Build advanced bots and packages

Learn how to build action packages and advanced bots that include custom features such as scripting, and API calls. Find recommendations on bot and action package design and reusability.

### More resources

On the [Developer portal](#), find additional how-to tutorials on building advanced bots and packages.

## Package SDK

Package SDK enables you in creating and uploading action packages to your Control Room.

The Automation Anywhere Package Development Kit provides detailed instructions for users to independently develop custom actions and upload the packages in their Control Room. The custom action are build in an IDE and are compiled to generate Java Archive (JAR) files. The JAR

files are then uploaded to the Control Room which becomes available as actions under the **Action Panel**.

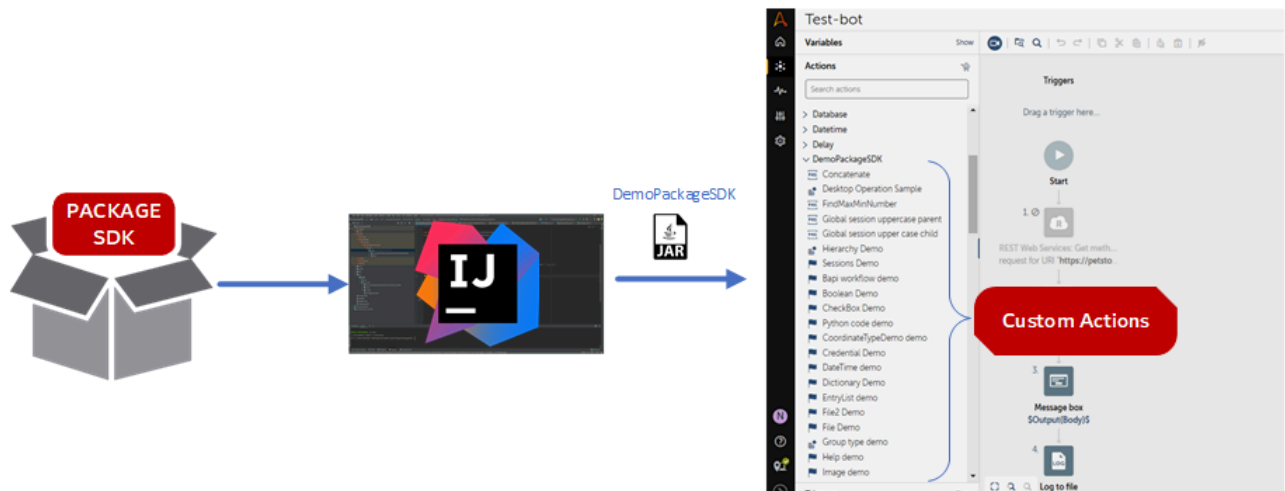

The Package SDK section includes sample codes and supporting files for Java developers to create and validate custom actions.

[Package SDK v.30 release](#) on page 80

SDK download link: [A360-package-sdk-2.9.0.zip](#)  
Docs download link: [A360-package-sdk-2.9.0-javadoc.zip](#)

[Package SDK v.29 release](#) on page 121

SDK download link: [A360-package-sdk-2.8.0.zip](#)

[April 2023, Release \(Automation 360 v.28\)](#)

SDK: [A360-package-sdk-2.7.0.zip](#) Docs: [A360-package-sdk-2.7.0-javadoc.zip](#)

[November 2022, Release \(Automation 360 v.27\)](#) [A360-package-sdk-2.6.1.zip](#)

For detailed release notes for the SDK Packages, see [Previous Package SDK Release Notes](#) on page 975.

Click a title to read details about each task in the process.

[Set up the Java project](#) on page 3511

Set up an integrated development environment (IDE) for Java, including Automation Anywhere custom annotations to develop an action package that you can upload to your Control Room.

[Standard coding practices and guidelines for developing packages](#) on page 3512

This topic covers standard coding practices and guidelines that help to ensure the development of high quality packages.

[Develop a sample package](#) on page 3514

Develop your own package and upload it to an Control Room to provide custom actions for bots.

[Package SDK examples](#) on page 3521

This section contains code examples and explanations about how to code some basic bot capabilities.

[Annotations](#) on page 3563

This section provides reference information about the annotations used to create Automation Anywhere packages.

[Build and test a demo package and bot](#) on page 3569

This practical how to section demonstrates that creating, changing, and managing packages allow you to customize actions and efficiently manage packages for all Control Room users.

[Build and test a custom package](#) on page 3575

Use IntelliJ to build a custom package and use Automation 360 actions to test the package.

Related reference

[Previous Package SDK Release Notes](#) on page 975

Review the new, changed, fixed, and deprecated features, and security fixes, known issues, and limitations for the previous Automation 360 (formerly Enterprise A2019) Package SDK.

## Set up the Java project

Set up an integrated development environment (IDE) for Java, including Automation Anywhere custom annotations to develop an action package that you can upload to your Control Room.

A working knowledge of Java and Gradle is required in order to successfully build an action package. You require the following software and file:

- Java Developer Kit (JDK) 11
- Java IDE
  - [Eclipse](#)
  - [Community edition of IntelliJ](#)
- Gradle plug-in v.7.\*.\* in the IDE
- Automation Anywhere Bot Agent installed and connected to your Control Room **Download and extract a zip file**

Download and extract the zip file for the release you want:

[Package SDK v.30 release](#) on page 80

SDK download link: [A360-package-sdk-2.9.0.zip](#) Docs download link: [A360-package-sdk-2.9.0-javadoc.zip](#)

[Package SDK v.29 release](#) on page 121

SDK download link: [A360-package-sdk-2.8.0.zip](#)

[April 2023, Release \(Automation 360 v.28\)](#)

SDK: [A360-package-sdk-2.7.0.zip](#) Docs: [A360-package-sdk-2.7.0-javadoc.zip](#)

[November 2022, Release \(Automation 360 v.27\)](#)

[A360-package-sdk-2.6.1.zip](#)

Configure the build files, compile the JAR file, add the package to your Control Room, and then build a bot to test your package. [Build and test a demo package and bot](#) on page 3569.

Related concepts

[Standard coding practices and guidelines for developing packages](#) on page 3512

This topic covers standard coding practices and guidelines that help to ensure the development of high quality packages.

[Package SDK examples](#) on page 3521

This section contains code examples and explanations about how to code some basic bot capabilities.

[Annotations](#) on page 3563

This section provides reference information about the annotations used to create Automation Anywhere packages.

[Build and test a demo package and bot](#) on page 3569

This practical how to section demonstrates that creating, changing, and managing packages allow you to customize actions and efficiently manage packages for all Control Room users.

Related tasks

[Develop a sample package](#) on page 3514

Develop your own package and upload it to an Control Room to provide custom actions for bots.

## Standard coding practices and guidelines for developing packages

This topic covers standard coding practices and guidelines that help to ensure the development of high quality packages.

Testing

Ensure high quality code. Write sufficient unit tests and integration tests for your package.

Icons

Set proper icon for your package.

Setting the version manually

The SDK package build version gets updated automatically every time a build happens. However, you can set it manually in the command project of a common **build.gradle** file.

- Update the **build.gradle** file before a build.
- Enter up to four digits numbers, separated by a period, as shown below:

```
...
ext {
    version '2.0.8'
}
dependencies {...}
```

Dependencies

Embed all the dependencies in your package JAR. Load the dependencies at run time by extracting them to a temporary location. Be sure to clean the temporary location after the dependencies are loaded.

Dependent JAR files

Add dependent JAR files under dependencies in the **build.gradle** file as implementation so that the dependant JAR files are packaged.



```

. . .
dependencies {
    compileOnly name: 'command-
    annotations'
    compileOnly name: 'bot-runtime'
    compileOnly name: 'bot-api'
    implementation name: 'i18n-api'
    implementation
name: 'mydependentjavafile.jar'
    apt name: 'command-processor'
    compileOnly group:
    'org.apache.logging.log4j',
    name: 'log4j-core', version:
    "$loggerVersion"
    testImplementation
    "org.testng:testng:
    $testNgVersion"
    testImplementation name: 'bot-
    runtime'
    testImplementation name: 'bot-
    api'
}
. . .

```

Add new actions to the exiting package

When adding new actions to an existing package, make sure to do clean before packaging. It is always a good practice to do clean build - gradlew.bat clean build shadowJar.

Error messages

Provide meaningful error messages.

- Do throw meaningful error messages. For example, in local language using i18n APIs with `BotCommandException`, throw a new exception  
`BotCommandException(MESSAGES.getString("Run.E`
- Do not throw generic error messages, such as `ex.message`.

Basic validation

Use the validation annotation rules, such as `@NotEmpty` included with this development kit. Do not add basic validations for your code. See [Validation annotations](#) on page 3567.

Loops

Avoid long running loops in your code. Long running loops can cause high CPU usage, leading to errors such as, "Bot is unresponsive."

Add logging

Use the default **log4J** logger provided in the bot run time framework. Do not add your own logger. See the sample code for details.

Logging levels

- ERROR/FATAL: Severe error event that the user is affected and there is no workaround.
- WARN : Unexpected error occurred but the system has recovered from it.

- INFO: Informational messages about state change, for example, an accepted request.
- DEBUG: Detailed diagnostic information that will be required to debug when something goes wrong.
- TRACE: All information is captured about an application behavior.

If you are not sure of the log level, set it to **TRACE**.

#### Loading resources

All resources should be loaded using current thread context class loader, as shown in the following example:

```
Thread.currentThread().getContextClassLoader().g
```

#### Related concepts

[Package SDK examples](#) on page 3521

This section contains code examples and explanations about how to code some basic bot capabilities.

[Annotations](#) on page 3563

This section provides reference information about the annotations used to create Automation Anywhere packages.

#### Related tasks

[Set up the Java project](#) on page 3511

Set up an integrated development environment (IDE) for Java, including Automation Anywhere custom annotations to develop an action package that you can upload to your Control Room.

[Develop a sample package](#) on page 3514

Develop your own package and upload it to an Control Room to provide custom actions for bots.

## Develop a sample package

Develop your own package and upload it to an Control Room to provide custom actions for bots.

Download and extract the contents from the latest Automation 360 Package SDK release. The newest package contains the necessary sample source code to build your package.

You need to have a project created in a Java IDE. For details about setting up a project, read [Set up the Java project](#) on page 3511.

The following high-level tasks provide the basic workflow for creating a package.

1. Create a java class.

This class is the action you plan to publish in your package.

---

**Important:** It is required that the class supports the default constructor.

---

2. Add required business logic to the class.

The following are the supported return types:

- **Void:** Use this return type if your action does not return any value.

- **Value:** Use this return type if your action returns any type of value.
3. Annotate the class with **BotCommand** and **CommandPkg** Annotations to make the class eligible to be converted to an action.
  4. Annotate the variable that accepts values with **Idx** and **Pkg**.
  5. Annotate the entry method with the **Execute** annotation.
  6. From the action prompt, run `gradlew.bat clean build shadowJar`.  
The JAR file created from the build is located in **build/lib**.

From the Control Room on the **Manage > Package** page, click the **Add package** icon to upload the JAR file.

---

**Tip:** To upload a package to a Control Room, you need **Upload package** permission. Review how to add a package to a Control Room: [Add packages to the Control Room](#) on page 1908.

---

Related concepts

[Standard coding practices and guidelines for developing packages](#) on page 3512

This topic covers standard coding practices and guidelines that help to ensure the development of high quality packages.

[Package SDK examples](#) on page 3521

This section contains code examples and explanations about how to code some basic bot capabilities.

[Annotations](#) on page 3563

This section provides reference information about the annotations used to create Automation Anywhere packages.

Related tasks

[Set up the Java project](#) on page 3511

Set up an integrated development environment (IDE) for Java, including Automation Anywhere custom annotations to develop an action package that you can upload to your Control Room.

## Using the package SDK

These example topics provide a basic understanding of how to use the Package SDK with Automation 360. Each SDK package includes a collection of configurable files that you can use to build a custom package, and then use the package to create Task Bots.

Use the following steps to create, configure, and build an IntelliJ project to compile a new package, and then create a bot to test the package you created.

1. Download, extract, and review the Package SDK files:
  - Download the latest Automation Anywhere A2019 Package SDK.  
[Enterprise Automation360 Package Development Kit Release Notes](#)
  - Go to your `Downloads` folder, right-click your downloaded Package SDK, and select **Extract All**.
  - Review all the files included in the package. You can drop any java file in your IntelliJ project to view or edit the content.
2. Install the latest Automation 360 version:
  - a) After the installation, log in to the Control Room with an admin privilege and create a new user with permissions to upload a package and create bots.

[Create a user](#) on page 1739

- b) Connect your local device to the Control Room. If required, download and install the latest Bot Agent.

[Install Bot Agent and register device](#) on page 1347

3. Install Java SE Development Kit 11 or IntelliJ IDE Community Edition and Gradle plug-in.
  - Java SE Development Kit 11 (<https://www.oracle.com/java/technologies/javase/jdk11-archive-downloads.html>)
  - Java IDE (<https://www.jetbrains.com/idea/download/#section=windows>)
4. Configure the sample build files in the IntelliJ project.  
[Configuring build files](#) on page 3516
5. Create a new directory, package, and class.  
[Creating new Java class](#) on page 3517
6. Use the compiled JAR file as a package and upload it to your Control Room in Automation 360.  
[Upload custom package to your Control Room](#) on page 3519
7. Create a Task Bot to test the new package.  
[Create a bot to test the new package](#) on page 3520
8. Optional: Verify the results, and if required, add additional actions to your bot flow, and configure parameters and values.
9. View additional resources.  
To learn more, search for the Package SDK: How to examples.

[Configuring build files](#) on page 3516

## Configuring build files

Use IntelliJ to configure and compile a JAR file, and then upload it as a package to your Control Room in Automation 360.

A basic understanding of JDK and Java IntelliJ is required in order to build an action package. Ensure you have the following software and files:

- Java SE Development Kit 11 (<https://www.oracle.com/java/technologies/javase/jdk11-archive-downloads.html>)
  - Java IDE (<https://www.jetbrains.com/idea/download/#section=windows>)
  - Automation Anywhere A2019 SDK. Download and extract the zip file for the release you require: [Enterprise A2019 Package Development Kit Release Notes](#)
1. Unzip the contents of the SDK package to your `IdeaProjects` directory and rename the folder from `<latest package sdk zip file>` to `A2019FileDetails`.
  2. In IntelliJ IDEA, go to **File > Open** and open the project located at `C:\Users\<User>\IdeaProjects\A2019FileDetails`.
  3. Open the `settings.gradle` file in the project root, and set the `rootProject.name = 'A2019FileDetails'`
  4. Update the `package.template` file located at **src > main > resources > package.template**.
  5. Change the package name from `A2019DemoPackage` to `A2019FileDetails`.

6. Update the package name in **locales json**: go to **src > main > resources > locales > en\_US.json**.
  - a) Open the `en_US.json` file and update the required `label` field. Update the optional description.
  - b) Delete all other remaining lines in the `en_US.json` file.
7. Open the `build.gradle` in the project root. After the dependencies section, remove other dependencies, if they are not required.
8. Save all files.

[Creating new Java class](#) on page 3517

## Creating new Java class

Use IntelliJ to create a new java class and a new directory, and configure other build files.

Complete the steps in the following task: [Configuring build files](#) on page 3516.

1. Create a new **Java Class**, right-click the `com.automationanywhere.botcommand` package, and select **New > Java Class**. Enter the name for the new class `GetFileDetails`.
  - a) Copy `@BotCommand` from the `Concatenate.java` and paste it into the new `GetFileDetails.java` file.

```
import static
    com.automationanywhere.commandsdk.model.DataType.STRING;
//BotCommand makes a class eligible for being considered as an
action.

@BotCommand
//CommandPks adds required information to be dispalable on GUI.
@CommandPkg(
    //Unique name inside a package and label to display.
    name = "concatenate", label = "[Concatenate.label]",
    node_label = "[Concatenate.node_label]", description =
    "[Concatenate.description]", icon = "pkg.svg",

    //Return type information. return_type ensures only the right
kind of variable is provided on the UI.
    return_label = "[Concatenate.return_label]", return_type =
    STRING, return_required = true)
public class Concatenate {

    //Messages read from full qualified property file name and
provide i18n capability.
    private static final Messages MESSAGES = MessagesFactory

    .getMessages("com.automationanywhere.botcommand.samples.messages");

    //Identify the entry point for the action. Returns a
Value<String> because the return type is String.
    @Execute
    public Value<String> action(
        //Idx 1 would be displayed first, with a text box for entering
the value.
        @Idx(index = "1", type = TEXT)
        //UI labels.
        @Pkg(label = "[Concatenate.firstString.label]"))
```

```

//Ensure that a validation error is thrown when the value is
null.
@NotEmpty
String firstString,

@Idx(index = "2", type = TEXT)
@Pkg(label = "[[Concatenate.secondString.label]]")
@NotEmpty
String secondString) {

//Internal validation, to disallow empty strings. No null check
needed as we have NotEmpty on firstString.
if ("".equals(firstString.trim()))
    throw new
BotCommandException(MESSAGES.getString("emptyInputString",
"firstString"));

if ("".equals(secondString.trim()))
    throw new
BotCommandException(MESSAGES.getString("emptyInputString",
"secondString"));

//Business logic
String result = firstString + secondString;

//Return StringValue.
return new StringValue(result);

```

- b) Update the @CommandPkg parameters such as: name, label, node\_label, description, and icon.
  - c) Update the return\_label and the return\_type.
  - d) Add the NumberValue action, internal validation, business logic, and the return value.
  - e) Delete the Concatenated. java file and samples.commands. basic directory, and the sample.commands directory.
2. Configure the en\_US.json file: go to **src > main > resources > locales > en\_US.json** and add the following fields after the label and description values, and delete other parameters from the file.

```

{
  "label": "File Details",
  "description": "Returns basic file details",
  "GetFileDetails.label": "File Size",
  "GetFileDetails.description": "Return the size of the selected file
in bytes",
  "GetFileDetails.node_label": "File Size in Bytes",
  "GetFileDetails.return_label": "File Size",
  "GetFileDetails.return_description": "Return in bytes",
  "GetFileDetails.filePath.label": "Select a File for analysis"
}

```

3. Delete packages: go to **src > main > java > com.automationanywhere.botcommand**, and delete the samples.commands and delete the samples packages.
4. Import new icons from Github and update the CommandPkg annotation.
  - a) Download any icons you want to use in your bot flow and save them as .svg files.

- b) Copy your image files into the **src > main > resources > icons** folder.
5. Create a new directory: go to **src**, right- click, and select **New > Directory**.
  - a) In the **Name** field, enter `test\java`. Alternatively, select the `test\java`, and enter the name `TestFileSize`.
  - b) Configure test annotations in the `TestFileSize` java class.
  - c) Create a `@test` public class, create a `GetFileDetails` object, and invoke the action.
  - d) Optional: Run the `TestGetFileDetails` in IntelliJ to test it.
6. Configure the `TestFileSize` file, and open `TestFileSize` and copy and paste the following code:

```

{
    @Test
    public void TestGetFileDetails() {
        String filePath = "src\\main\\resources\\icons\\sample.svg";
        //Create GetFileDetails Object
        GetFileDetails getFileDetails = new GetFileDetails();
        //invoke action
        NumberValue output = getFileDetails.action(filePath);
        Assert.assertEquals(output.getAsDouble(), 5027.0);
    }
}

```

7. Save the project: **File > Save All**.
8. Click **Reload All Gradle Projects**, and then click **Execute Gradle Task**, and verify that the **A2019FileDetails** project is selected.
9. In the **Run Anything** window, enter `gradle clean build shadowJar`. After it runs, the following message is displayed: `BUILD SUCCESSFUL in 8s <number of seconds>`

[Upload custom package to your Control Room](#) on page 3519

## Upload custom package to your Control Room

Use the compiled JAR file and upload it as a package to your Control Room in Automation 360.

- Complete the steps in the following task: [Creating new Java class](#) on page 3517.
  - Ensure you have the following:
    - Access to the Control Room.
    - Credentials with **AAE\_Basic** permission or a custom role with the capability to upload packages to the Control Room.
1. From Windows Explorer, go to `C:\Users\<Username>\IdeaProjects\A2019-FileDetails\build\libs` and locate `A360-package-sdk-2.9.0.zip`.
  2. Log in to your Control Room as a user with permissions to add a new package.
  3. Click **Manage > Packages**.
  4. In the **Packages** page, move your mouse over the plus sign and click **Add package**.
  5. In the **Add package** page, click **Browse** and locate the Package SDK jar you want to upload. For example: `A360-package-sdk-2.9.0.zip` file.

By default, the file is located at: C:\Users\

6. Select the A360-package-sdk-2.9.0.zip file and click **Open**.
7. Click **Upload Package**.

When you upload a custom package to the Control Room, a notification is also sent to the Control Room users to notify about package updates. This notification is sent to the users who have the **View package** permission. For more information, see [Platform events](#) on page 2209 event notification.

[Create a bot to test the new package](#) on page 3520

## Create a bot to test the new package

Use the actions in Automation 360 to create a bot and test the new package you have added to your Control Room.

Ensure you have the following to build the bot:

- Access to the Control Room.
  - Credentials with **AAE\_Basic** permission or a custom role to create bots.
  - Your workstation is a registered device in the Control Room.
  - Your package A2019FileDetails-2.0.9.jar is available in the Control Room.
1. Log in to the Control Room.
  2. On the left pane, click **Automation**.  
A list of available and forms is displayed.
  3. Click the **Create a bot** icon.
  4. In the **Name** field, enter `TestingFileSize` or any other name you want.
  5. Click **Create & Edit**.
  6. In the Actions pane, find **File Details** and drag **File Size** into the bot flow.
    - a) In the **Select a File for analysis** field, select **Desktop file**, click **Browse**, and select any file from your desktop.
    - b) Click **Create variable** to create a new number variable.
    - c) In **Create Variable**, enter `nFileSize` and click **Create & Select**.
    - d) Click **Apply**.
  7. In the Actions pane, find the **Number** package and drag the **To String** command.
    - a) In the **Enter a number** field, enter **F2**, and select **nFileSize**.
    - b) In the **Assign the output to variable** field, select **prompt-assignment - String** from the drop-down list.
    - c) Click **Apply**.
  8. From the Actions pane, drag **Message box**.
  9. In the **Enter the message to display** field, click **F2** and select the **prompt-assignment variable**.
  10. Click **Apply** and **Save**.
  11. Click **Run**.



The bot displays the `<The value of the file size>`, which is a successful build.

If you were not able to run your bot, go back and modify your configuration steps in your Control Room.

## Package SDK examples

This section contains code examples and explanations about how to code some basic bot capabilities.

<a href="#">Return a value from an action</a> on page 3522	Set the following properties on <code>CommandPkg</code> to store the action output in a variable.
<a href="#">Expose property attributes of action</a> on page 3524	The property values of an action can be exposed by setting the following properties on <b>CommandPkg</b> .
<a href="#">Organize and group actions when developing packages</a> on page 3525	Review the provided examples on how to add and group actions during the package SDK development process.
<a href="#">Input types - UI elements</a> on page 3526	The user interface (UI) elements are the input controls used to receive inputs in an action while building a bot.
<a href="#">Create custom variables using Package SDK</a> on page 3528	When using Automation 360, you can create custom variables using the SDK package.
<a href="#">Create a condition using Package SDK</a> on page 3534	When using Automation 360, you can create a condition with the SDK package.
<a href="#">Add a condition in a custom package for If condition</a> on page 3536	Add conditions in a custom package.
<a href="#">Create an iterator using Package SDK</a> on page 3537	In Automation 360, you can create an iterator with the SDK package. An iterator is used to loop through multiple objects of similar type and is used with the Loop package. It consists of two methods, <code>next</code> and <code>hasNext</code> , which return the actual object and a boolean value.
<a href="#">Create a custom trigger (Example 2)</a> on page 3545	The example shows how to create a trigger in Automation 360 that allows you to create tasks that will be executed at specified intervals.
<a href="#">Create a custom trigger (Example 3)</a> on page 3549	The example shows how to create an event-based trigger ( <code>SimpleMessageListenerContainer</code> ) using the Package SDK.
<a href="#">Add debug logs of custom packages to bot_launcher.log file</a> on page 3551	You can add logs using <code>log4j</code> . The dependency is already added in the package SDK sample <code>build.gradle</code> file.
<a href="#">Handle sessions in a custom package</a> on page 3553	You can extract a session using a session name from the <code>SessionsMap</code> . In the same package, you can use sessions to pass information between actions, but not to other packages.

[Configure shared session using Package SDK on page 3556](#)

Package SDK provides configuration for the SDK users to create and use shared sessions. Sessions are seamlessly shared between different bots to share resources between them. This means that if a session has been created, the other Task Bots can read and update the session and vice versa.

[Create a bot to test the custom package on page 3583](#)

A shared session enables you to reuse actions between Task Bots that run concurrently, for example, using the same Excel file to pass values.

## Actions

Any action class supports only one method as an entry point. Annotate all parameters of the entry point method with `Idx`. There are three types of actions:

- `CommandAction` (default choice)
- `Iterator`
- `Condition`

---

**Important:** If you do not provide a public setter to member variables with `Inject`, compilation errors occur.

---

Related concepts

[Standard coding practices and guidelines for developing packages on page 3512](#)

This topic covers standard coding practices and guidelines that help to ensure the development of high quality packages.

[Annotations on page 3563](#)

This section provides reference information about the annotations used to create Automation Anywhere packages.

Related tasks

[Set up the Java project on page 3511](#)

Set up an integrated development environment (IDE) for Java, including Automation Anywhere custom annotations to develop an action package that you can upload to your Control Room.

[Develop a sample package on page 3514](#)

Develop your own package and upload it to an Control Room to provide custom actions for bots.

## Return a value from an action

Set the following properties on `CommandPkg` to store the action output in a variable.

### Action return values

- **return\_type**  
Defines the return type of the action. It usually matches the entry method return type.
- **return\_required**  
When the value is set to `true` the return value is required.
- **return\_label**

A description of the UI label for the variable value.

### Example: Convert a sourceString to uppercase and assign the result to returnTo

```
//BotCommand makes a class eligible for being considered as an action.
@BotCommand

//CommandPks adds required information to be displayable on the UI.
@CommandPkg(
    //Unique name inside a package and label to display.
    name = "uppercase", label = "[[Uppercase.label]]",
    node_label = "[[Uppercase.node_label]]", description =
    "[[Uppercase.description]]", icon = "pkg.svg",

    //Return type information. return_type ensures only the right kind of
    variable is provided on the UI.
    return_label = "[[Uppercase.return_label]]", return_type =
    STRING, return_required = true)
public class Uppercase {

    //Messages read from a fully qualified property file name and provides
    i18n capability.
    private static final Messages MESSAGES = MessagesFactory
        .getMessages("com.automationanywhere.botcommand.samples.messages");

    //Identify the entry point for the action. Returns a Value <String>
    because the return type is String.
    @Execute
    public Value<String> action(
        //Idx 1 would be displayed first, with a text box for entering the
        value.
        @Idx(index = "1", type = TEXT)
        //UI labels.
        @Pkg(label = "[[Uppercase.sourceString.label]]")
        //Ensure that a validation error is thrown when the value is null.
        @NotEmpty
        String sourceString,
```

Related concepts

[Package SDK examples](#) on page 3521

This section contains code examples and explanations about how to code some basic bot capabilities.

## Expose property attributes of action

The property values of an action can be exposed by setting the following properties on **CommandPkg**.

### Action property values

	Property Attributes	Description
1	name	The name of the property, unique at action level, in auto-complete box this name would appear.
2	description	A description of the property.
3	type	The data type on which property operates, only if the type matches, the property will be appear in the auto-complete box.
4	return_type	The return data type of the property. If this type does not match the field type where it is used, there will be a validation error.

```
@BotCommand
@CommandPkg(label = "Uppercase", name = "uppercase",
  description="Converts the string to upper case",
  icon = "uppercase.svg", node_label="Convert {{sourceString}} to upper
  case| and assign the result to {{returnTo}}",
  return_type=DataType.STRING, return_required = true,
  return_label="Assign the output to variable") public class UpperCase {

  @Execute
  public Value<String> convert(
    @Idx(index = "1", type=TEXT)
    @Pkg(label="Source string")
    @NotEmpty
    String sourceString){
    return new StringValue(sourceString.toUpperCase());
  }
}
```

**Tip:** The character | acts as a separator node label. The content before and after the | character appears only when there is an input for the variables declared in each part. For example, in the above sample, when the {{sourceString}} variable has a value, the content before the | appears, and when {{returnTo}} has a value, the content after the | appears.

For example, the above class in the UI will look like:

**Message box**

Displays a message box

Required bot agent version: 20.11 or above

Enter the message box window title

Converts the string to upper case

String:uppercase - String

Enter the message to display

1 \$Test123{Body}.u| \$ (x)

Scrollbar after lines

# 30 (x)

Close message box after

Seconds

#

Related concepts

[Package SDK examples](#) on page 3521

This section contains code examples and explanations about how to code some basic bot capabilities.

## Organize and group actions when developing packages

Review the provided examples on how to add and group actions during the package SDK development process.

**Example: Add** actions

```
@BotCommand
//CommandPks adds required information to be dispalable on the UI.
@CommandPkg(
  //Unique name inside a package and a label to display.
  name = "concatenate", label = "[[Concatenate.label]]",
  node_label = "[[Concatenate.node_label]]", description =
  "[[Concatenate.description]]", icon = "pkg.svg",

  //Return type information. return_type ensures only the right kind of
  variable is provided on the UI.
  return_label = "[[Concatenate.return_label]]", return_type = STRING,
  return_required = true)
```

**Example: Group** actions

Use the `group_label` to `ConcatenateGroup` which it is displayed in the UI also as **ConcatenateGroup**. When the `group_label` is not used, you will get all the actions in the respective package.

```
@BotCommand

//CommandPks adds required information to be dispalable on the UI.
@CommandPkg(
    //Provide a unique name inside a package and a label to display.
    group_label = "ConcatenateGroup", name = "concatenateWithGroup",
    label = "concatenateWithGroup",
    node_label = "[[Concatenate.node_label]]", description =
    "[[Concatenate.description]]", icon = "pkg.svg",

    //Return type information. return_type ensures only the right kind of
    variable is provided on the UI.
    return_label = "[[Concatenate.return_label]]", return_type = STRING,
    return_required = true)
public class ConcatenateWithGroup {
```

## Input types - UI elements

The user interface (UI) elements are the input controls used to receive inputs in an action while building a bot.

The following examples show the supported input types. Use the UI elements to create user interface (UI) designs to build the Control Room interfaces. For instance, if you need an input as text then, use `TEXT`, if you need a radio button, select `RADIO`, and so on. This topic is based on the `SampleUI` sample available within the Package SDK in the following location: `<PackageSDK>\src\main\java\com\automationanywhere\botcommand\samples\commands\ui\SampleUI.java`.

1. Make sure you have imported the following packages to ensure all the functionalities works as described in the sample.

```
import com.automationanywhere.commandsdk.annotations.Idx;
import com.automationanywhere.commandsdk.annotations.Pkg;
import com.automationanywhere.commandsdk.annotations.rules.CodeType;
import
    com.automationanywhere.commandsdk.annotations.rules.VariableType;
```

2. Add the `@BotCommand` annotation to make a class as an Action in the Control Room. For more information on annotations, see [Annotations](#) on page 3563.

```
@BotCommand
```

3. Add the `@CommandPkg` annotation to define all the UI related components - labels, description, and name.

```
@CommandPkg(label = "UI Demo", description = "Demonstrates the
    provided UI elements", name = "uiDemo")
```

4. Create a class and define the fields as described below.
  - a) Annotate the method with `@Execute` to execute the method during compilation.
  - b) In this sample, `@Idx` and `@Pkg` are used as a member of the class, so you should use `set` and `get` methods to define them.

1. @Idx - Defines the index of an action.
2. @Pkg - Defines all the parameters and member variables shown in the interface. Must be accompanied by the @Idx, if not this annotation is ignored.
3. @Inject - To receive value from the UI using the member class, @Inject is required at field levels.

```

@BotCommand
@CommandPkg(label = "UI Demo", description = "Demonstrates
the provided UI elements", name = "uiDemo")
public class SampleUI {
    @Idx(index = "1", type = TEXT)
    @Pkg(label = "Text type")
    @Inject
    String text;

    @Execute
    public String getText() {
        return text;
    }
    public void setText(String text) {
        this.text = text;
    }
}

```

5. Drag the action into canvas and you will be able to input a string in the text field. You will see an input box similar to this image.

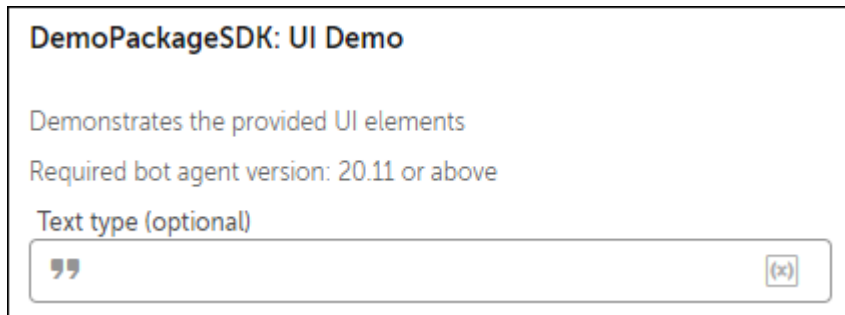

The screenshot shows a window titled "DemoPackageSDK: UI Demo". Inside the window, there is a description "Demonstrates the provided UI elements" and a requirement "Required bot agent version: 20.11 or above". Below this, there is a section labeled "Text type (optional)" which contains a text input field with a placeholder "''" and a clear button (X) on the right.

### UI element - Number field

Use the Number type to create an UI element that will accept a number. Using the below sample you will be able to create a field that will accept only numbers.

```

@BotCommand
@CommandPkg(label = "UI Demo", description = "Demonstrates the provided
UI elements", name = "uiDemo")
public class SampleUI {
    @Idx(index = "2", type = NUMBER)
    @Pkg(label = "Number type")
    @Inject
    String num;

    @Execute
    public String getNum() {

```

```

        return num;
    }
    public void setNum(String num) {
        this.num = num;
    }
}

```

### Other UI elements

It is possible to create other UI components like: Boolean, Radiobutton, Number, Variable, Code, Dictionary, List, Date/Time, and so on. To get a complete list of UI elements supported, see <PackageSDK>\src\main\java\com\automationanywhere\botcommand\samples\commands\ui\SampleUI.java.

### UI validations supported

The following UI validations are also supported:

- @NotEmpty means that the UI field needs an input at the bot design time.
- @LocalFile refers to a local file from a user machine.
- @NumberIntegers refers to a number value that you can provide, such as, a float or a double input kind.

## Create custom variables using Package SDK

When using Automation 360, you can create custom variables using the SDK package.

### Using custom variables

Use Automation 360 to create a custom variable. This is a system variable and is used as other bot variables, except it is read-only and the value is calculated instead of being assigned.

### Required annotations

For creating a variable, the following annotations are required:

Annotation	Usage
BotCommand	Use the BotCommand annotation with the <code>variable</code> as <code>commandType</code> . This ensures that the plain old Java object (POJO) is suitable for creating an Automation 360 variable.
CommandPkg	These values are used when creating a package. Provide a name, label, and description to the annotation.
Idx	Annotate all the parameters and member variables that are required and help with the validation check. Alternatively they might be displayed in the interface for the input. Provide the index ( <code>Idx</code> ) and the type.



Annotation	Usage
Pkg	Annotate all the parameters and member variables that will be shown in the interface. This annotation will be ignored if it is not accompanied by the Idx.
VariableExecute	The method that has to be called for returning the variable value. This method does not accept any input parameters. Sessions and GlobalSessionContext are available through setter injection.

## Use case example

The following use case shows how to return the current time for the system default zone.

1. Create the POJO class with the business logic:

```
public class Now {
    public DateTimeValue now() {
        Instant instant = Instant.now();
        ZonedDateTime now = instant.atZone(ZoneId.systemDefault());
        return new DateTimeValue(now);
    }
}
```

2. Annotate the POJO class to enable it for the Automation 360 variable and to create the package:

```
@BotCommand(commandType = BotCommand.CommandType.Variable)
@CommandPkg(description = "The current datetime at system
default zone.", name = "Now", label = "", variable_return_type =
DataType.DATETIME)
public class Now {
    public DateTimeValue now() {
        Instant instant = Instant.now();
        ZonedDateTime now = instant.atZone(ZoneId.systemDefault());
        return new DateTimeValue(now);
    }
}
```

3. Annotate the now method to denote it to be the execute method.

```
@VariableExecute
public DateTimeValue now() {
    Instant instant = Instant.now();
    ZonedDateTime now = instant.atZone(ZoneId.systemDefault());
    return new DateTimeValue(now);
}
```

Every variable must have one test `VariableExecute` method.

Related concepts

[Package SDK examples](#) on page 3521

This section contains code examples and explanations about how to code some basic bot capabilities.

## Using EntryList

EntryList enables you to accept any number of parameters through the bot designer. The parameter structure is defined in the Automation 360 actions.

### Example: EntryList

The following example shows how to create a parameter with the name of `village` pair.

```
@BotCommand
@CommandPkg(label = "EntryList example", description = "EntryList
example", icon = "sample.svg", name = "entryListExample")
public class EntryListExample {
// UI display for ENTRYLIST 1.1, the linking is done based on the
ENTRYLIST title.
// This should be added as a child of the ENTRYLIST, however it should
not be part of options.
// The EntryList does not need a setter or Inject as the value is
provided inside the ENTRYLIST.
@Idx(index = "1.3", type = TEXT, name = "NAME")
@Pkg(label = "Name", default_value_type = DataType.STRING)
@NotEmpty
private String name;
//Linked to 1.2 through title.
@Idx(index = "1.4", type = TEXT, name = "VILLAGE")
@Pkg(label = "village", default_value_type = STRING)
private String city;
@Execute
public void setParameter(
// Add the entryList, the values are accepted as a list of values.
// Provide the column header for the tabular display of accepted
entries.
// In Pkg, provide a unique title.
// Provide Idx for each option separately, this is needed to
// have the correct UI type when the entry form is presented.
// Add only columns to options, you cannot add their definitions.
@Idx(index = "1", type = ENTRYLIST, options = {
@Idx.Option(index = "1.1", pkg = @Pkg(title = "NAME", label =
"Name")),
@Idx.Option(index = "1.2", pkg = @Pkg(title = "VILLAGE", label =
"village")),
})
//Label that is displayed in the UI
@Pkg(label = "Provide name value entries")
//Header of the entry form
@EntryListLabel(value = "Provide entry")
//Button label which displays the entry form
@EntryListAddButtonLabel(value = "Add entry")
//Unique rule for the column, this value is the column TITLE.
```

```

@EntryListEntryUnique(value = "NAME")
//Message to dispaly in the table when no entries are present.
@EntryListEmptyLabel(value = "No parameters added")
    List<Value> entryList) {

}

```

Here is another example of the EntryList, define the values of the EntryList usage.

```

//Entry list//
@Idx(index = "1", type = ENTRYLIST, options = {
    @Idx.Option(index = "1.1", pkg = @Pkg(title = HEADER_ENABLED,
    label = "[[HEADER1]]")),
    @Idx.Option(index = "1.2", pkg = @Pkg(title = HEADER_NAME, label
    = "[[HEADER1]]")),
    @Idx.Option(index = "1.3", pkg = @Pkg(title = HEADER_VALUE, label
    = "[[HEARER3]]"))
})
@Pkg(label = "customHeaderslabel")
@EntryListLabel(value = "customHeaderlabel")
@EntryListAddButtonLabel(value = "add.header")
@EntryListEmptyLabel(value = "no.header")
@Inject
List<Value> customHeaders;

```

Related concepts

[Package SDK examples](#) on page 3521

This section contains code examples and explanations about how to code some basic bot capabilities.

## Using regular expression

Use regular expressions (regex) to create string patterns that help match, locate, or manage text in Java. Together, the literals and special characters define a logical pattern. Use the pattern to compare strings of text to check if the strings match the defined pattern.

---

**Note:** Regular expression (regex) does not recognize `\b` as a Backspace command. Use `\\b` to use Backspace instead.

---

### Example: MatchesRegex

Use `MatchesRegex` to test the string pattern.

In the following example, the input pattern starts from the English alphabet, uppercase and lowercase, (A-Z/a-z) and ends with a numeric value.

```

@Idx(index = "1", type = TEXT)
@Pkg(label = "Field label", description = "Field description")
@MatchesRegex("[A-Za-z]\w*")
@NotEmpty
String cell

```

If the pattern does not match, the following message is displayed: `Must match pattern.`

Related concepts

[Package SDK examples](#) on page 3521

This section contains code examples and explanations about how to code some basic bot capabilities.

## FILE2 (Regex) attribute

Regular expressions (RegEx) are patterns of string defined to search for a file in a specified path. Use the FILE2 attribute when using regular expressions (regex) to create string patterns.

For instance: If you want to search a folder path for a file (For example `Hello.txt`) which contains a certain string. You will use FILE2 attribute type to enter the following regex pattern: `He11` or `e11` which will find the file that matches the search criteria. This topic is based on the File2TypeDemo sample available within the Package SDK in the following location `<PackageSDK>\src\main\java\com\automationanywhere\botcommand\samples\commands\basic\types\File2TypeDemo.java`.

## Using the FILE2

1. Make sure you have imported the following packages to ensure all the functionalities works as described in the sample.

```
import com.automationanywhere.commandsdk.annotations.*;
import com.automationanywhere.commandsdk.model.AttributeType;
import org.apache.logging.log4j.LogManager;
import org.apache.logging.log4j.Logger;
```

2. Add the @BotCommand annotation to make a class as an Action in the Control Room. For more information on annotations, see [Annotations](#) on page 3563.

```
@BotCommand
```

3. Add the @CommandPkg annotation to define all the UI related components - labels, description, icon, return type, and name.

```
@CommandPkg(label = "[File2TypeDemo.label]", description =
  "[File2TypeDemo.description]", icon = "sample.svg", name =
  "file2TypeDemo")
```

4. Create a method (For example: regexFile) within your class and define the fields as described below.

- a) Annotate the method with @Execute to execute the method during compilation.
- b) In the below sample, @Idx, @Pkg, and @NotEmpty are defined as a parameters of the method. If they are used as a member of the class, then you should use set and get methods to define them.

1. @Idx - Defines the index of an action. (@Idx(index = "1", type = AttributeType.FILE2))
2. @Pkg - Defines all the parameters and member variables shown in the interface (@Pkg(label = "[File2TypeDemo.localFile.label]")). Must be accompanied by the @Idx, if not this annotation is ignored.

3. `@NotEmpty` - Defines that this parameter cannot be empty (`@NotEmpty @LocalFile FileValue fileValue`).

```
@BotCommand
@CommandPkg(label = "[[File2TypeDemo.label]]",
description = "[[File2TypeDemo.description]]", icon =
"sample.svg", name = "file2TypeDemo")
public class File2TypeDemo {
private static Logger logger =
LogManager.getLogger(File2TypeDemo.class);

@Execute
public void regexFile(
@Idx(index = "1", type = AttributeType.FILE2)
@Pkg(label = "[[File2TypeDemo.localFile.label]]")
@NotEmpty @LocalFile FileValue fileValue)
```

5. Build and upload the custom package to the Control Room. For more information on uploading the package, see [Using the package SDK](#) on page 3515.
6. Create a bot.
7. Drag the action into canvas and you will be able to input the regex to find a file. You will see an input box similar to this image.

### DemoPackageSDK: File2 Demo

Sample action showing how to use regex with file name

Required bot agent version: 20.11 or above

Please enter a local file

Specific path **Regex**

Folder path

File name

Type	Value
Pattern ▾	<input type="text" value="ell"/> <input type="button" value="(x)"/>

**Print the Regex - Folder name and the File location**

Use the [Logger](#) interface obtained from Log4j package to provide information of the objects being manipulated. In the below sample you will be able to log the folder name and the local file location by using the debug method.

```
@BotCommand
@CommandPkg(label = "[[File2TypeDemo.label]]",
  description = "[[File2TypeDemo.description]]", icon = "sample.svg",
  name = "file2TypeDemo")
public class File2TypeDemo {
  private static Logger logger =
  LogManager.getLogger(File2TypeDemo.class);

  @Execute
  public void regexFile(
    @Idx(index = "1", type = AttributeType.FILE2) @Pkg(label =
    "[[File2TypeDemo.localFile.label]]") @NotEmpty @LocalFile FileValue
    fileValue) {
    if (fileValue.isRegex()) {

      RegexFile regexFile = fileValue.getRegex();
      logger.debug("folder name {}", regexFile.getFolder());
      logger.debug("local file location {}",
      regexFile.getFileNamePattern().toString());
    } else {
      logger.debug("Regex option is not selected");
    }
  }
}
```

## Create a condition using Package SDK

When using Automation 360, you can create a condition with the SDK package.

## Using a condition

If and Loop are branching constructs in Automation 360. They are used to run a sequence of actions when a condition is set to `true`. A condition is used along with the If and Loop packages. A condition takes a set of inputs and returns a Boolean value.

## Required annotations

For creating a condition, the following annotations are required:

Annotation	Usage
BotCommand	Use the BotCommand annotation with the condition as <code>commandType</code> . This ensures that the plain old Java object (POJO) is suitable for the creation of an Automation 360 condition.
CommandPkg	These values are used when creating a package. Provide a name, label, and description to the annotation.

Annotation	Usage
<code>Idx</code>	Annotate all the parameters and member variables that are required and help with the validation check, or they might be displayed in the interface for the input. Provide the index ( <code>Idx</code> ) and the type.
<code>Pkg</code>	Annotate all the parameters and member variables that will be shown in the interface. This annotation will be ignored if it is not accompanied by the <code>Idx</code> .
<code>ConditionTest</code>	The method that has to be called for testing the condition. It must return a Boolean value. If the method accepts parameters, then annotate them with <code>Idx</code> .

### Use case example

The following use case verifies whether the given number is greater than the other number.

1. Create the POJO class with the business logic:

```
public class IsGreater {
    public Boolean checkGreater(Double first, Double checkAgainst) {
        return first > checkAgainst;
    }
}
```

2. Annotate the POJO class to enable it for the Automation 360 condition and to create the package:

```
@BotCommand(commandType = Condition)
@CommandPkg(label = "Is greater condition", name = "IsGreater",
    description = "Checks if the given number is greater than the
    other.", node_label = "{{first}} > {{checkAgainst}} ")
public class IsGreater {
    public Boolean checkGreater(Double first, Double checkAgainst) {
        return first > checkAgainst;
    }
}
```

3. Annotate the `checkGreater` method to indicate that this method should be used as a comparison method.

```
@ConditionTest
public Boolean checkGreater(Double first, Double checkAgainst) {
    return first > checkAgainst;
}
```

Every condition must have exactly one test condition method.

4. Annotate the parameters of the `checkGreater` method with `Idx` and `Pkg`.

Add `@NotEmpty` to ensure the value is not null.

```
@ConditionTest
public Boolean checkGreater(
    @Idx(index = "1", type = AttributeType.NUMBER) @Pkg(label = "Number
to check") @NotEmpty Double first,

    @Idx(index = "2", type = AttributeType.NUMBER) @Pkg(label = "Number
to compare against") @NotEmpty Double checkAgainst) {

    return first > checkAgainst;
}
```

The attribute type number returns a Double.

Related concepts

[Package SDK examples](#) on page 3521

This section contains code examples and explanations about how to code some basic bot capabilities.

## Add a condition in a custom package for `If` condition

Add conditions in a custom package.

### Create condition values in an Action

- To create a condition, set `commandType` property of `BotCommand` annotation with value as `Condition`.
- To define the entry method of the condition, use the annotation `ConditionTest`.

```
@BotCommand(commandType = Condition)
@CommandPkg(label = "File exists", name = "fileExists",
    description = "Checks if the file exists.",
    node_label = "file exists at {{sourceFilePath}}", icon = "")
public class Exist extends AbstractCondition {
    @ConditionTest
    public boolean test(@Idx(index = "1", type = FILE) @LocalFile
@Pkg(label = "File path") @NotEmpty String sourceFilePath,
        @Idx(index = "2", type = NUMBER) @Pkg(label =
"How long you would like to wait for this condition
to be true?(Seconds)",
            default_value = "0", default_value_type
= DataType.NUMBER)
            @GreaterThanOrEqualTo("0")
@LessThanOrEqualTo("99999") @NotEmpty @NumberInteger Double waitTimeout)
    {
        // Add the logic to check for the condition
    }
}
```

The following example verifies if the provided boolean value is false.



Set `commandType` to `Condition`.

```
@BotCommand(commandType = Condition)
@CommandPkg(label = "False condition example", name =
  "conditionalTypeExample",
  description = "Checks if the boolean value is false.")
public class ConditionalTypeExample {

  @ConditionTest
  public Boolean validate(
    @Idx(index = "1", type = AttributeType.BOOLEAN)
    @VariableType(BOOLEAN)
    @Pkg(label = "Boolean variable", default_value_type =
  BOOLEAN) @NotEmpty Boolean variable
  ) {
    return variable == null ? false : !variable ;
  }
}
```

Related concepts

[Package SDK examples](#) on page 3521

This section contains code examples and explanations about how to code some basic bot capabilities.

## Create an iterator using Package SDK

In Automation 360, you can create an iterator with the SDK package. An iterator is used to loop through multiple objects of similar type and is used with the Loop package. It consists of two methods, `next` and `hasNext`, which return the actual object and a boolean value.

### Required annotations

When iterator is used, the `next` method returns the next available value. If no more values are available, an exception is shown. The `hasNext` method checks for other values and returns `false` if no more values are available. In Automation 360, when the loop is executed, `hasNext ()` is called first, and `next ()` is called only if `hasNext ()` returned a `true` value.

For creating an iterator, the following annotations are required.

Annotation	Usage
<code>BotCommand</code>	Use the <code>BotCommand</code> annotation with an <code>iterator</code> as the <code>commandType</code> . This ensures that the plain old Java object (POJO) is eligible for creating an Automation 360 iterator.
<code>CommandPkg</code>	When creating a package, provide a name, label, and description to the annotation.
<code>Idx</code>	Annotate all parameters and member variables that are required and help with the validation check, or they can be displayed in the interface for the input. Provide the <code>Idx</code> and the type.
<code>Pkg</code>	Annotate all parameters and member variables that will be displayed in the interface. This annotation will be ignored if it is not accompanied by the <code>Idx</code> .

Annotation	Usage
HasNext	<p>The method that has to be called for testing if the iteration has more elements (returns <code>true</code> if <code>next ()</code> returns an element rather than throwing an exception). It must return a Boolean value.</p> <p>If the method accepts parameters, then they must be annotated with the <code>Idx</code>. The <code>hasNext</code> method verifies it and returns <code>false</code> if no more values are available. In Automation 360, when Loop is executed, <code>hasNext ()</code> is called first. <code>next ()</code> is called only if <code>hasNext ()</code> returns a <code>true</code> value.</p>
Next	The method returns the next available value in the iteration. The return type is a value. If no more value is available, an exception is shown.

### Use case example

The example use case loops through number of times, for example, `for (int i=0; I<n; i++)` Java construct. It accepts the value of `n` from the Bot Creator when the bot is created.

1. Make sure you have imported the following packages to ensure all the functionalities works as described in the sample.

```
import com.automationanywhere.botcommand.data.Value;
import com.automationanywhere.botcommand.data.impl.NumberValue;
import com.automationanywhere.commandsdk.annotations.BotCommand;
import com.automationanywhere.commandsdk.annotations.CommandPkg;
import com.automationanywhere.commandsdk.annotations.HasNext;
import com.automationanywhere.commandsdk.annotations.Idx;
import com.automationanywhere.commandsdk.annotations.Inject;
import com.automationanywhere.commandsdk.annotations.Next;
import com.automationanywhere.commandsdk.annotations.Pkg;
import
    com.automationanywhere.commandsdk.annotations.BotCommand.CommandType;
import
    com.automationanywhere.commandsdk.annotations.rules.GreaterThanEqualTo;
import com.automationanywhere.commandsdk.annotations.rules.NotEmpty;
import
    com.automationanywhere.commandsdk.annotations.rules.NumberInteger;
import com.automationanywhere.commandsdk.model.AttributeType;
import com.automationanywhere.commandsdk.model.DataType;
```

2. Create the POJO class with the business logic.

Ensure that the POJO has a method and returns a boolean value. This will act as the comparison method.

```
@BotCommand(commandType=CommandType.Iterator)
@CommandPkg(return_label = "Return the value in variable",
    node_label = ": {{times}} times",
    label = "Iterator demo", description = "Iterate number of times",
    name = "iteratorTypeDemo", return_type = DataType.NUMBER)
public class IteratorTypeDemo {
    @Idx(index = "1", type = AttributeType.NUMBER)
    @Pkg(label = "times", default_value = "10", default_value_type =
        DataType.NUMBER)
    @GreaterThanEqualTo("0")
    @NumberInteger
    @NotEmpty
```

```

    @Inject
    private Double times = 10d;

    private Double counter = 0d;

    @HasNext
    public boolean hasNext() {
        return counter < times;
    }

    @Next
    public Value<Double> next() throws Exception{
        if (counter >= times)
            throw new Exception("Counter '" + counter + "' is exceed the times
            limit '" + times + "'");

        counter++;
        NumberValue result = new NumberValue();
        result.set(counter);
        return result;
    }

    public void setTimes(Double times) {
        this.times = times;
    }
}

```

3. Annotate the POJO class to enable it for the Automation 360 iterator and to create a package.

```

@BotCommand(commandType = CommandType.Iterator)
@CommandPkg(return_label = "Return the value in variable",
node_label = ": {{times}} times",
label = "Iterator demo", description = "Iterate number of times",
name = "iteratorTypeDemo", return_type = DataType.NUMBER)
public class IteratorTypeDemo {

    private Double times = 10 d;
    private Double counter = 0 d;

    public boolean hasNext() {
        return counter < times;
    }
}

```

4. Annotate the hasNext () and next () method appropriately.

```

@HasNext
public boolean hasNext() {
    return counter < times;
}

@Next
public Value < Double > next() throws Exception {
    if (counter >= times)
        throw new Exception("Counter '" + counter + "' is exceed the times
        limit '" + times + "'");

    counter++;
    NumberValue result = new NumberValue();
    result.set(counter);
    return result;
}

```

```
}

```

The methods are named in easy-to-use way and are in parallel with the Java iterator interface. There is no restriction from the SDK side when naming methods.

In an iterator, do not use parameter methods, but use `setter injection`.

##### 5. Annotate the variables with `Idx` and `Pkg`.

Add `@NotEmpty` to ensure the value is not null, and add `@GreaterThanEqualTo` to ensure the value is always greater than 0.

```
@Idx(index = "1", type = AttributeType.NUMBER)
@Pkg(label = "times", default_value = "10", default_value_type =
    DataType.NUMBER)
@GreaterThanEqualTo("0")
@NotEmpty
@Inject
private Double times = 10 d;
```

The attribute type number returns a `Double`.

Related concepts

[Package SDK examples](#) on page 3521

This section contains code examples and explanations about how to code some basic bot capabilities.

## Create a custom trigger (Example 1)

Package SDK provides tools to build your custom trigger that automate actions based on predefined conditions.

In this section, you will learn how to create an interval trigger using Automation Anywhere's Package SDK. A sample class called `TriggerDemo` is used to explain its functionality step by step. By the end, you will have a solid understanding of how to build your own custom triggers using Package SDK:

1. Dependencies and Package: The code sample utilizes various imports and is organized within the package `com.automationanywhere.botcommand.samples.trigger`.
2. Annotations: The code utilizes several annotations provided by Package SDK to define and configure the trigger. These annotations include:
  - a) `@BotCommand`: Specifies that this class represents a trigger. You specify this using the line `@BotCommand(commandType = BotCommand.CommandType.Trigger)`. When you specify that it is a command type `Trigger`, then it will be visible in the Trigger section within the Bot editor.
  - b) `@CommandPkg`: Provides metadata about the trigger, such as label, description, icon, and return type. The return type is always set to `RECORD` as shown in the following sample.
  - c) `@TriggerId`: Indicates the unique identifier assigned to each trigger instance.
  - d) `@TriggerConsumer`: Specifies the consumer function to be invoked when the trigger condition is met.
  - e) `@StartListen`: Marks the method responsible for starting the trigger.

---

**Tip:** `@StartListen` is used to execute a trigger and is analogous to `@Execute` in the case of a bot.

---

- f) `@StopAllTriggers`: Identifies the method used to cancel all triggers.
  - g) `@StopListen`: Identifies the method responsible for canceling a specific trigger.
3. **Trigger Execution**: The trigger execution logic is implemented in the `startTrigger` method using the `@StartListen` annotation. In this example, a `TimerTask` is scheduled to run at regular intervals defined by the user. When the scheduled time is reached, the `run` method of the `TimerTask` is executed, triggering the `consumer.accept`. The consumer accepts the `RecordValue` returned by the `getRecordValue` method.

---

**Tip:** `RecordValue` is also available to use within your bot logic.

---

4. **`getRecordValue` Method**: The `getRecordValue` method creates a `RecordValue` object and populates it with a list of schemas and values. In this example, the schema `triggerType` is added with the corresponding value `Interval Trigger`.
5. **`StopListen` and `StopAllTriggers` Methods**: These methods are annotated with `@StopListen` and `@StopAllTriggers`, respectively. They are responsible for canceling the trigger task(s) and removing them from the task map.
6. **Additional Helper Methods**: The code also includes getter and setter methods for the `triggerUid` and `consumer` variables.

```
package com.automationanywhere.botcommand.samples.trigger;

import java.sql.Connection;
import java.sql.ResultSet;
import java.sql.SQLException;
import java.sql.Statement;
import java.util.*;
import java.util.concurrent.ConcurrentHashMap;
import java.util.function.Consumer;

import javax.sql.DataSource;

import com.automationanywhere.botcommand.data.Value;
import com.automationanywhere.botcommand.data.impl.RecordValue;
import com.automationanywhere.botcommand.data.impl.StringValue;
import com.automationanywhere.botcommand.data.model.Schema;
import com.automationanywhere.botcommand.data.model.record.Record;
import
    com.automationanywhere.botcommand.samples.exceptions.DemoException;
import com.automationanywhere.commandsdk.annotations.*;
import org.apache.commons.dbcp2.BasicDataSource;

import org.apache.logging.log4j.LogManager;
import org.apache.logging.log4j.Logger;

import com.automationanywhere.botcommand.exception.BotCommandException;
import com.automationanywhere.commandsdk.annotations.rules.GreaterThan;
import com.automationanywhere.commandsdk.annotations.rules.NotEmpty;
import
    com.automationanywhere.commandsdk.annotations.rules.NumberInteger;
import com.automationanywhere.commandsdk.model.AttributeType;
import com.automationanywhere.commandsdk.model.DataType;
import com.automationanywhere.core.security.SecureString;

import static com.automationanywhere.commandsdk.model.DataType.RECORD;
```

```

/**
 * This example is an extension of the timer based trigger {@link
 * TriggerDemo} and demonstrates the
 * pull mechanism.
 * Trigger will check the DB at regular interval and if the records
 * returned by
 * user provided SQL is more than 0 then it will get triggered.
 * NOTE 1: This class is for illustrative purpose only not safe for use
 * in production.
 * NOTE 2: Please add the valid DB driver in build gradle to run this
 * example.
 *
 */
@BotCommand(commandType = BotCommand.CommandType.Trigger)
@CommandPkg(label = "JDBC Query Trigger", description = "JDBC Query
  Trigger", icon = "jdbc.svg", name = "jdbcQueryTrigger",
  return_type = RECORD, return_name = "TriggerData", return_description
  = "Available keys: triggerType")
public class DBStatus {

    private static Logger logger = LogManager.getLogger(DBStatus.class);

    // Map storing multiple tasks
    private static final Map<String, TimerTask> taskMap = new
    ConcurrentHashMap<>();
    private static final Timer TIMER = new Timer(true);

    @TriggerId
    private String triggerUid;
    @TriggerConsumer
    private Consumer consumer;

    /*
     * Starts the trigger.
     */
    @StartListen
    public void startTrigger(
        @Idx(index="1", type = AttributeType.TEXT)
        @Pkg(label = "Please provide the database driver class")
        @NotEmpty
        String driverClassName,

        @Idx(index="2", type = AttributeType.TEXT)
        @Pkg(label = "Please provide the Jdbc connection string")
        @NotEmpty
        String jdbcUrl,

        @Idx(index="3", type = AttributeType.TEXT)
        @Pkg(label = "Please provide the user Name")
        @NotEmpty
        String userName,

        @Idx(index="4", type = AttributeType.CREDENTIAL)
        @Pkg(label = "Please provide the password")
        @NotEmpty
        SecureString password,

        @Idx(index="5", type = AttributeType.TEXT)
        @Pkg(label = "Please provide the SQL to check the records")

```

```

@NotEmpty
String sqlQuery,

@Idx(index = "6", type = AttributeType.NUMBER)
@Pkg(label = "Please provide the interval to query in seconds",
default_value = "300", default_value_type = DataType.NUMBER)
@GreaterThan("0")
@NumberInteger
@NotEmpty
Double interval) {

DataSource dataSource = getDataSource(driverClassName, jdbcUrl,
userName, password);

TimerTask timerTask = new TimerTask() {

@Override
public void run() {
logger.debug("checking DB");
try {
if (checkRecordsExist(dataSource.getConnection(), sqlQuery)) {
consumer.accept(getRecordValue());
return;
}
} catch (SQLException e) {
logger.warn(e.getMessage(), e);
logger.warn("Trigger is still running.");
}
logger.debug("no records found");

}
};

taskMap.put(this.triggerUid, timerTask);
TIMER.schedule(timerTask, interval.longValue(),
interval.longValue());
}

private RecordValue getRecordValue() {
List<Schema> schemas = new LinkedList<>();
List<Value> values = new LinkedList<>();
schemas.add(new Schema("triggerType"));
values.add(new StringValue("DBStatus"));

RecordValue recordValue = new RecordValue();
recordValue.set(new Record(schemas, values));
return recordValue;
}
/*
 * Cancel all the task and clear the map.
 */
@stopAllTriggers
public void stopAllTriggers() {
taskMap.forEach((k, v) -> {
if (v.cancel()) {
taskMap.remove(k);
}
});
}
}
/*

```

```
* Cancel the task and remove from map
*
* @param triggerUid
*/
@StopListen
public void stopListen(String triggerUid) {
    if (taskMap.get(triggerUid).cancel()) {
        taskMap.remove(triggerUid);
    }
}

    public static DataSource getDataSource(String driverClassName,
String url, String userName, SecureString password) {
    BasicDataSource ds = new BasicDataSource();
    ds.setDriverClassName(driverClassName);
    ds.setUrl(url);
    ds.setUsername(userName);
    ds.setPassword(password.getInsecureString());
    return ds;
}

    public static boolean checkRecordsExist(Connection con, String
query)
        throws SQLException {
        Statement stmt = null;
        try {
            stmt = con.createStatement();
            ResultSet rs = stmt.executeQuery(query);
            rs.last();
            if(rs.getRow() > 0)
                return true;
        } catch (SQLException e ) {
            throw new DemoException("Problem running statemnt", e);
        } finally {
            if (stmt != null) { stmt.close(); }
        }
        return false;
    }

public String getTriggerUid() {
    return triggerUid;
}

public void setTriggerUid(String triggerUid) {
    this.triggerUid = triggerUid;
}

public Consumer getConsumer() {
    return consumer;
}

public void setConsumer(Consumer consumer) {
    this.consumer = consumer;
}
}
```



In the above code sample describes the various methods and annotations used to create and manage the trigger. By understanding the code and its functionality, you are now equipped to create your own interval triggers using Package SDK. Experiment with different intervals and trigger actions to automate your business processes effectively.

The above article is a just a sample, and you need to refine and customize it further based on your specific requirements and target audience.

## Create a custom trigger (Example 2)

The example shows how to create a trigger in Automation 360 that allows you to create tasks that will be executed at specified intervals.

A trigger launches a bot when certain conditions are met and waits until conditions have changed or stopped. When the conditions of the trigger are matched, the run method is called to signal the trigger.

## Required annotations

For creating a trigger, the following annotations are required:

Annotation	Usage
<code>BotCommand</code>	Use the <code>BotCommand</code> annotation with the trigger as <code>commandType</code> . This ensures that the plain old Java object (POJO) is suitable for creating the trigger with Automation 360.
<code>CommandPkg</code>	These values are used when creating a package. Provide a name, label, and description to the annotation.
<code>TriggerId</code>	A trigger ID, which is required for stopping the trigger.
<code>TriggerConsumer</code>	Specifies the consumer function to be invoked when the trigger condition is met.
<code>StartListen</code>	Starts the trigger listener.
<code>StopAllTriggers</code>	Identifies the method used to cancel all triggers.
<code>StopListen</code>	Identifies the method responsible for canceling a specific trigger..

## Use case - Timer Trigger

The following use case shows how to create a timer trigger that triggers a bot at regular intervals. The `Demo Trigger` command sample explained here is a trigger command that allows you to create and manage triggers based on user-specified intervals. This trigger can be used to execute tasks at regular intervals.

## Command Information

```
@BotCommand(commandType = BotCommand.CommandType.Trigger)
@CommandPkg(label = "Demo Trigger", description = "Demo Trigger", icon
= "email.svg", name = "demoTrigger",
    return_type = RECORD, return_name = "TriggerData",
    return_description = "Available keys: triggerType")
```

- Command Type: Trigger
- Label: Demo Trigger
- Description: Demo Trigger
- Icon: email.svg
- Name: demoTrigger
- Return Type: RECORD
- Return Name: TriggerData
- Return Description: Available keys: triggerType

## Class Structure

The `TriggerDemo` class is a singleton class that manages the trigger tasks. It stores the tasks in a map using the `triggerId` as the key. Once the trigger condition is met, the `run` method of the associated `Runnable` is called to signal the trigger.

## Class Variables

- `taskMap`: A static `ConcurrentHashMap` that stores multiple trigger tasks.
- `TIMER`: A static `Timer` used for scheduling the trigger tasks.
- `triggerUid`: Annotated with `@TriggerId`, it represents the unique identifier for the trigger.
- `consumer`: Annotated with `@TriggerConsumer`, it is the consumer that will accept the trigger data.

## Methods

- `startTrigger`: Annotated with `@StartListen`, this method starts the trigger. It takes an interval parameter (in seconds) to specify the trigger activation interval. It creates a new `TimerTask` that calls the `run` method of the associated `Runnable` when executed. The `TimerTask` is added to the `taskMap` with the `triggerUid` as the key, and it is scheduled to run at the specified interval.
- `getRecordValue`: A private method that creates and returns a `RecordValue` containing the trigger data. The trigger data includes a schema with a single key "triggerType" and its corresponding value "Interval Trigger".
- `stopAllTriggers`: Annotated with `@StopAllTriggers`, this method cancels all trigger tasks and clears the `taskMap`.
- `stopListen`: Annotated with `@StopListen`, this method cancels a specific trigger task identified by the `triggerUid` parameter and removes it from the `taskMap`.
- Setter methods: `setTriggerUid` and `setConsumer` are setter methods for the `triggerUid` and `consumer` variables, respectively.

```
/*
 * Copyright (c) 2023 Automation Anywhere.
 * All rights reserved.
 *
 * This software is the proprietary information of Automation Anywhere.
```

```
* You shall use it only in accordance with the terms of the license
agreement
* you entered into with Automation Anywhere.
*/

/**
 *
 */
package com.automationanywhere.botcommand.samples.trigger;

import java.util.*;
import java.util.concurrent.ConcurrentHashMap;
import java.util.function.Consumer;

import com.automationanywhere.botcommand.data.Value;
import com.automationanywhere.botcommand.data.impl.RecordValue;
import com.automationanywhere.botcommand.data.impl.StringValue;
import com.automationanywhere.botcommand.data.model.Schema;
import com.automationanywhere.botcommand.data.model.record.Record;
import com.automationanywhere.commandsdk.annotations.*;
import com.automationanywhere.commandsdk.annotations.rules.GreaterThan;
import com.automationanywhere.commandsdk.annotations.rules.NotEmpty;
import
    com.automationanywhere.commandsdk.annotations.rules.NumberInteger;
import com.automationanywhere.commandsdk.model.AttributeType;
import com.automationanywhere.commandsdk.model.DataType;

import static com.automationanywhere.commandsdk.model.DataType.RECORD;

/**
 * There will be a singleton instance of this class. Whenever a new
 * trigger is
 * created it comes with a triggerId. In this sample we create multiple
 * tasks
 * and store them in a map with these triggerId as the key. Once the
 * condition
 * of trigger matches we call the run method of the runnable to signal
 * the
 * trigger.
 * In the following example we will create a trigger which triggers are
 * user
 * specified intervals.
 *
 */
@BotCommand(commandType = BotCommand.CommandType.Trigger)
@CommandPkg(label = "Demo Trigger", description = "Demo Trigger", icon
    = "email.svg", name = "demoTrigger",
    return_type = RECORD, return_name = "TriggerData", return_description
    = "Available keys: triggerType")
public class TriggerDemo {

    // Map storing multiple tasks
    private static final Map<String, TimerTask> taskMap = new
    ConcurrentHashMap<>();
    private static final Timer TIMER = new Timer(true);

    @TriggerId
    private String triggerUid;
    @TriggerConsumer
    private Consumer consumer;
```

```
/*
 * Starts the trigger.
 */
@StartListen
public void startTrigger(@Idx(index = "1", type =
AttributeType.NUMBER)
@Pkg(label = "Please provide the interval to trigger in seconds",
default_value = "120", default_value_type = DataType.NUMBER)
@GreaterThan("0")
@NumberInteger
@NotEmpty
Double interval) {
    TimerTask timerTask = new TimerTask() {

        @Override
        public void run() {
            consumer.accept(getRecordValue());
        }
    };

    taskMap.put(this.triggerUid, timerTask);
    TIMER.schedule(timerTask, interval.longValue());
}

private RecordValue getRecordValue() {
    List<Schema> schemas = new LinkedList<>();
    List<Value> values = new LinkedList<>();
    schemas.add(new Schema("triggerType"));
    values.add(new StringValue("Interval Trigger"));

    RecordValue recordValue = new RecordValue();
    recordValue.set(new Record(schemas, values));
    return recordValue;
}

/*
 * Cancel all the task and clear the map.
 */
@stopAllTriggers
public void stopAllTriggers() {
    taskMap.forEach((k, v) -> {
        if (v.cancel()) {
            taskMap.remove(k);
        }
    });
}

/*
 * Cancel the task and remove from map
 *
 * @param triggerUid
 */
@stopListen
public void stopListen(String triggerUid) {
    if (taskMap.get(triggerUid).cancel()) {
        taskMap.remove(triggerUid);
    }
}

public void setTriggerUid(String triggerUid) {
    this.triggerUid = triggerUid;
}
```

```

}

public void setConsumer(Consumer consumer) {
    this.consumer = consumer;
}

}

```

### Example

Here's an example of using the Demo Trigger

```
demoTrigger.startTrigger(60.0);
```

This will start a trigger that runs every 60 seconds and calls the associated consumer with the trigger data.

To stop the trigger, you can use the following methods:

- `demoTrigger.stopAllTriggers()`: This method will stop all active triggers.
- `demoTrigger.stopListen(triggerUid)`: This method will stop a specific trigger identified by the `triggerUid`.

---

**Note:** The `triggerUid` is a unique identifier for each trigger and is assigned automatically when a trigger is created.

---

Related concepts

[Package SDK examples](#) on page 3521

This section contains code examples and explanations about how to code some basic bot capabilities.

## Create a custom trigger (Example 3)

The example shows how to create an event-based trigger (`SimpleMessageListenerContainer`) using the Package SDK.

### Event-based triggers - Push mechanism

The trigger waits for an event to occur, for example, a message listener to start listening.

- An event details are stored in the memory and a message listener waits for a message.
- When the event occurs, it runs the `consumer.accept(<RecordValue Instance>)` method and triggers an associated bot..

The following example shows how to create a simple `ActiveMQ` message listener (`SimpleMessageListenerContainer`) to demonstrate the trigger push mechanism.

```

@BotCommand(commandType = BotCommand.CommandType.Trigger)
@CommandPkg(label = "JMS Trigger", description = "JMS Trigger", icon =
    "jms.svg", name = "jmsTrigger",
    return_type = RECORD, return_name = "TriggerData", return_description
    = "Available keys: triggerType")
public class JMSQueue implements SessionAwareMessageListener {

    // Map storing multiple MessageListenerContainer

```

```
private static final Map<String, MessageListenerContainer> taskMap =
new ConcurrentHashMap<>();

@TriggerId
private String triggerUid;
@TriggerConsumer
private Consumer consumer;

//This method is called by MessageListenerContainer when a message
arrives.
// At this point, the trigger get enabled
@Override
public void onMessage(javax.jms.Message message, Session session)
throws JMSEException {
    consumer.accept(getRecordValue());
}

private RecordValue getRecordValue() {
    List<Schema> schemas = new LinkedList<>();
    List<Value> values = new LinkedList<>();
    schemas.add(new Schema("triggerType"));
    values.add(new StringValue("JMSQueue"));

    RecordValue recordValue = new RecordValue();
    recordValue.set(new Record(schemas, values));
    return recordValue;
}
/*
 * Starts the trigger.
 *
 * Use this method to setup the trigger, such as, setup the
MessageListenerContainer and start it.
 */
@StartListen
public void startTrigger(@Idx(index = "1", type = AttributeType.TEXT)
@Pkg(label = "Provide the broker URL")
@NotEmpty
String brokerURL, @Idx(index = "2", type = AttributeType.TEXT)
@Pkg(label = "Provide the queue name")
@NotEmpty
String queueName) {

    if (taskMap.get(triggerUid) == null) {
        synchronized (this) {
            if (taskMap.get(triggerUid) == null) {
                SimpleMessageListenerContainer messageListenerContainer = new
SimpleMessageListenerContainer();
                messageListenerContainer.setConnectionFactory(new
PooledConnectionFactory(brokerURL));
                messageListenerContainer.setDestinationName(queueName);
                messageListenerContainer.setMessageListener(this);
                messageListenerContainer.start();
                taskMap.put(triggerUid, messageListenerContainer);
            }
        }
    }
}
}
```

```

/*
 * Cancel all the tasks and clear the map.
 */
@stopAllTriggers
public void stopAllTriggers() {
    taskMap.forEach((k, v) -> {
        v.stop();
        taskMap.remove(k);
    });
}

/*
 * Cancel the tasks and remove from the map
 *
 * @param triggerUid
 */
@stopListen
public void stopListen(String triggerUid) {
    taskMap.get(triggerUid).stop();
    taskMap.remove(triggerUid);
}

public String getTriggerUid() {
    return triggerUid;
}

public void setTriggerUid(String triggerUid) {
    this.triggerUid = triggerUid;
}

public Consumer getConsumer() {
    return consumer;
}

public void setConsumer(Consumer consumer) {
    this.consumer = consumer;
}
}

```

Related concepts

[Package SDK examples](#) on page 3521

This section contains code examples and explanations about how to code some basic bot capabilities.

## Add debug logs of custom packages to bot\_launcher.log file

You can add logs using `log4j`. The dependency is already added in the package SDK sample `build.gradle` file. Review the logging info using `RadioTypeDemo.java` file.

### Example 1: Logger info - Get region value using `RadioTypeDemo` class

1. Review the code example where the logger is added in the code, open the `RadioTypeDemo.java` file located at `<your latest package-sdk-2.0.9>\src\main\java\com\automationanywhere\botcommand\samples\commands\basic\types`

```

@BotCommand
@CommandPkg(label = "[[RadioTypeDemo.label]]",

```

```

description = "[[RadioTypeDemo.description]]", icon = "sample.svg",
name = "radioTypeDemo")
public class RadioTypeDemo {

    private static Logger logger =
    LogManager.getLogger(RadioTypeDemo.class);

    @Execute
    public void getRegionValue(@Idx(index = "1", type =
    AttributeType.RADIO, options = {
        @Idx.Option(index = "1.1", pkg = @Pkg(label =
        "[[RadioTypeDemo.region.1.1.label]]", value = "us_east")),
        @Idx.Option(index = "1.2", pkg = @Pkg(label =
        "[[RadioTypeDemo.region.1.2.label]]", value = "us_west")),
        @Idx.Option(index = "1.3", pkg = @Pkg(label =
        "[[RadioTypeDemo.region.1.3.label]]", value = "us_central"))
    })
    @Pkg(label = "[[RadioTypeDemo.region.label]]")
    @NotEmpty
    String region) {
        logger.info("Selected region is {}", region);
    }
}

```

2. Build a simple bot from the Automation 360 Demo package and select a radio group: **Radio Demo**.
3. Select an appropriate region, such as, US East.
4. Save and run the bot.
5. Access the folder where the logs were generated, the default log location: C:\ProgramData\AutomationAnywhere\BotRunner\Logs\Bot\_Launcher.log.  
If the logs get roll back from the Bot\_Launcher.log file, then logs will create a folder based on the month when they were created, for example, 2021-May. Inside this folder, the logs will continue to generate.
6. Open the Bot\_Launcher.log file and review the log info for the **RadioTypeDemo** and **selected region is us\_east**.

### Example 2: Assigning a value to clipboard

The following example accepts a user input or a variable and assigns it to clipboard.

```

@BotCommand
@CommandPkg(label = "Copy to", icon="assigntoclipboard.svg" ,name =
"assignToClipboard", description
= "Accepts user input or a variable and assigns it to Clipboard",
node_label="{{value}}")
public class AssignToClipboard {

    private static Logger logger =
    LogManager.getLogger(AssignToClipboard.class);

    @Execute
    public static void assign(@Idx(index = "1", type = TEXT) @Pkg(label =
    "Value") @NotEmpty String
        value) {

        logger.trace("Assigning '{}' value to clipboard.", value);
    }
}

```



```
}

```

Related concepts

[Package SDK examples](#) on page 3521

This section contains code examples and explanations about how to code some basic bot capabilities.

## Handle sessions in a custom package

You can extract a session using a session name from the SessionsMap. In the same package, you can use sessions to pass information between actions, but not to other packages.

## Configure the following attributes

- Apply an annotation to the class field and add a corresponding public setter.
- Retrieve the SessionsMap using the Sessions attribute.
- Set the variable type as Map<String, Object>.
- Set the attributeType: TEXT or SESSION. If type = TEXT, it is a regular session; if type = SESSION, it is a sharedSession.

Start a new session

```
@BotCommand
@CommandPkg(label = "Start session", name = "startSession", description
= "Start new session",
icon = "pkg.svg", node_label = "start session {{sessionName}}|") public
class Start {

    @Sessions
    private Map<String, Object> sessions;

    @Execute
    public void start(@Idx(index = "1", type = TEXT) @Pkg(label =
"Session name",
    default_value_type = STRING, default_value = "Default") @NotEmpty
String sessionName) {

        // Check for existing session
        if (sessions.containsKey(sessionName))
            throw new
BotCommandException(MESSAGES.getString("xml.SessionNameInUse",
sessionName));

        // Do some operation

        // Create new session
        sessions.put(sessionName, new Session(operation));
    }
    public void setSessions(Map<String, Object> sessions) {
        this.sessions = sessions;
    }
}
```

```
}

```

End a session

```
@BotCommand
@CommandPkg(label = "End session", name = "endSession", description =
  "End session", icon =
  "pkg.svg", node_label = "End session {{sessionName}}|")
public class EndSession {
    @Sessions
    private Map<String, Object> sessions;
    @Execute
    public void end(
        @Idx(index = "1", type = TEXT) @Pkg(label = "Session name",
        default_value_type = STRING,
        default_value = "Default") @NotEmpty String sessionName) {

        sessions.remove(sessionName);
    }
    public void setSessions(Map<String, Object> sessions) {
        this.sessions = sessions;
    }
}

```

Add a session

In the below example, string objects are used (although in real actions, you can use complex objects).

```
@BotCommand
@CommandPkg(label = "[[SessionDemo.label]]", description =
  "[[SessionDemo.description]]", icon = "sample.svg", name =
  "sessionDemo")
public class SessionDemo {

    // Sessions are provided as a Map. Actions can add or remove entries
    // in this
    // Map.
    // The choice to reuse/overwrite/delete/add any Object in this Map
    // belongs to
    // the actions, and the framework makes no assumption regarding it.
    @Sessions
    private Map<String, Object> sessionMap;

    @Execute
    public void execute(@Idx(index = "1", type = TEXT)
    @Pkg(label = "[[SessionDemo.name.label]]")
    @NotEmpty
    String name) {
        if (!sessionMap.containsKey(name))
            sessionMap.put(name, "Some Value");
    }
}

```

```

}

// Ensure that a public setter exists.
public void setSessionMap(Map<String, Object> sessionMap) {
    this.sessionMap = sessionMap;
}
}

```

Set a session variable

The below example shows how to develop an action (for example, Set session variable). In the action, the session details are retrieved and stored as a session variable so that the information can be used within a specific package.

```

@BotCommand
@CommandPkg(label = "[[SessionDemo2.label]]", description =
    "[[SessionDemo2.description]]", icon = "sample.svg", name =
    "SessionDemo2",
return_type = DataType.STRING)
public class SessionDemo2 {

    // Sessions are provided as a Map. Actions can add or remove entries
    in this
    // Map.
    // The choice to reuse/overwrite/delete/add any Object in this Map
    belongs to
    // the actions, and the framework makes no assumption regarding it.
    @Sessions
    private Map<String, Object> sessionMap;

    @Execute
    public Value<?> execute(@Idx(index = "1", type = TEXT)
    @Pkg(label = "[[SessionDemo2.name.label]]")
    @NotEmpty
    String name) {
        if (sessionMap.containsKey(name)) {
            return new StringValue(sessionMap.get(name));
        }
        return new StringValue("session does not exist");
    }
    // Ensure that a public setter exists.
    public void setSessionMap(Map<String, Object> sessionMap) {
        this.sessionMap = sessionMap;
    }
}

```

Related concepts

[Package SDK examples](#) on page 3521

This section contains code examples and explanations about how to code some basic bot capabilities.

## Configure shared session using Package SDK

Package SDK provides configuration for the SDK users to create and use shared sessions. Sessions are seamlessly shared between different bots to share resources between them. This means that if a session has been created, the other Task Bots can read and update the session and vice versa.

## Share session between parent and child

The following section describes creating a shared session. The parent GlobalSessionDemoUpperCaseParent returns a Session value to the global session and is used by the child bot GlobalSessionDemoUpperCaseChild.

---

**Note:** Place the three classes below in the following location: <PackageSDK>\src\main\java\com\automationanywhere\botcommand\samples\commands\basic

---

1. Create the following POJO class DemoForSession that implements CloseableSessionObject.

```
package
com.automationanywhere.botcommand.samples.commands.basic.GlobalSessionSampleProj

import
com.automationanywhere.toolchain.runtime.session.CloseableSessionObject;

import java.io.IOException;

public class DemoForSession implements CloseableSessionObject
{
    public void setClose(boolean close) {
        this.close = close;
    }

    boolean close=false;
    public String getDemo() {
        return demo;
    }

    public void setDemo(String demo) {
        this.demo = demo;
    }
    public DemoForSession(String demo){
        this.demo=demo;
    }
    String demo;

    @Override
    public boolean isClosed() {
        return close;
    }

    @Override
    public void close() throws IOException {

    }
}
```

2. Add the `@BotCommand` annotation to make a class as an Action in the Control Room. For more information on annotations, see [Annotations](#) on page 3563.

```
@BotCommand
```

3. Add the `@CommandPkg` annotation to define all the UI related components - labels, description, icon, return\_type, and name. The elements return\_label, return\_settings, return\_type, and return\_required belonging to the `@CommandPkg` ensures that the SESSION is returned by the parent bot.

```
@CommandPkg (
    //Unique name inside a package and label to display.
    name = "GlobalSession", label = "Global session uppercase parent",
    node_label = "Shared session parent node label", description =
    "Shared session parent description", icon = "pkg.svg",

    //Return type information. return_type ensures only the right kind
    of variable is provided on the UI.
    return_label = "Return the parent session",
    return_settings = {ReturnSettingsType.SESSION_TARGET},
    return_type = SESSION,
    return_required = true)
```

4. Create the `GlobalSessionDemoUpperCaseParent` object. The `GlobalSessionDemoUpperCaseParent` gets a lower case string input from the action's input, converts it to an upper case string and store the result in the `SessionValue`.
  - Annotate the method with `@Execute` to execute the method during compilation.

```
package
    com.automationanywhere.botcommand.samples.commands.basic.GlobalSessionSamplePr

import com.automationanywhere.botcommand.data.impl.SessionValue;
import com.automationanywhere.commandsdk.annotations.*;
import
    com.automationanywhere.commandsdk.annotations.rules.NotEmpty;
import com.automationanywhere.commandsdk.model.ReturnSettingsType;
import org.apache.logging.log4j.LogManager;
import org.apache.logging.log4j.Logger;

import java.util.Map;

import static
    com.automationanywhere.commandsdk.model.AttributeType.TEXT;
import static
    com.automationanywhere.commandsdk.model.DataType.SESSION;

//BotCommand makes a class eligible for being considered as an
action.
@BotCommand

//CommandPks adds required information to be disalable on GUI.
@CommandPkg (
    //Unique name inside a package and label to display.
    name = "GlobalSession", label = "Global session uppercase
parent",
    node_label = "Shared session parent node label", description =
    "Shared session parent description", icon = "pkg.svg",
```

```

//Return type information. return_type ensures only the right
kind of variable is provided on the UI.
return_label = "Return the parent session",
return_settings = {ReturnSettingsType.SESSION_TARGET},
return_type = SESSION,
return_required = true)
public class GlobalSessionDemoForStringUpperCaseParent {
private static Logger logger =
LogManager.getLogger(GlobalSessionDemoForStringUpperCaseParent.class);

//Identify the entry point for the action. Returns a SessionValue
because the return_type is SESSION.
@Execute
public SessionValue action(
//Idx 1 would be displayed first, with a text box for entering
the value.
@Idx(index = "1", type = TEXT)
//UI labels.
@Pkg(label = "Enter string in lower case")
//Ensure that a validation error is thrown when the value is
null.
@NotEmpty
String firstString) {
String result = firstString.toUpperCase();
DemoForSession demoForSession= new DemoForSession(result);
return SessionValue
.builder()
.withSessionObject(demoForSession)
.build();
}
}

```

5. Create the GlobalSessionDemoUpperCaseChild object. The GlobalSessionDemoUpperCaseChild gets a lower case string input from the action's input, converts it to upper case and concatenates it with the SessionValue received from the parent bot.

```

package
com.automationanywhere.botcommand.samples.commands.basic.GlobalSessionSampleProject;

import com.automationanywhere.botcommand.data.Value;
import com.automationanywhere.botcommand.data.impl.StringValue;
import
com.automationanywhere.botcommand.samples.commands.basic.Uppercase;
import com.automationanywhere.commandsdk.annotations.*;
import com.automationanywhere.commandsdk.annotations.rules.NotEmpty;
import
com.automationanywhere.commandsdk.annotations.rules.SessionObject;
import com.automationanywhere.commandsdk.model.AttributeType;
import com.automationanywhere.commandsdk.model.DataType;
import org.apache.logging.log4j.LogManager;
import org.apache.logging.log4j.Logger;

import static
com.automationanywhere.commandsdk.model.AttributeType.TEXT;
import static
com.automationanywhere.commandsdk.model.DataType.STRING;

```

```

//BotCommand makes a class eligible for being considered as an
action.
@BotCommand

//CommandPks adds required information to be dispalable on GUI.
@CommandPkg(
    //Unique name inside a package and label to display.
    name = "GlobalSessionChild", label = "Global session upper case
child",
    node_label = "Global session child node label",
    description = "Global session child description", icon =
"pkg.svg",

    //Return type information. return_type ensures only the right kind
of variable is provided on the UI.
    return_label = "Return the concatenated string to", return_type =
STRING, return_required = true)
public class GlobalSessionDemoUpperCaseChild {
    private static Logger logger =
    LogManager.getLogger(Uppercase.class);

    @Execute
    public Value<String> action(
        //Idx 1 would be displayed first, with a text box for entering
the value.
        @Idx(index = "1", type = TEXT)
        //UI labels.
        @Pkg(label = "Enter a sting in lower case to concatenate")
        //Ensure that a validation error is thrown when the value is
null.
        @NotEmpty
        String sourceString,
        @Idx(index = "2", type = AttributeType.SESSION)
        @Pkg(label = "sharedSession", description = "sharedSession",
        default_value = "Default", default_value_type =
DataType.SESSION)
        //Using the sessionObject annotation here as its a consumer class
        @SessionObject
        DemoForSession session) {

        //Business logic
        String result = sourceString.toUpperCase();
        logger.info("session: {}", session);
        return new StringValue(result+session.getDemo().toUpperCase());
    }
}

```

6. Build and upload the custom package to the Control Room. For more information on uploading the package, see [Using the package SDK](#) on page 3515.
7. Create a bot by using the Global session uppercase parent action.
  - a) Enter a lower case string (For example: parentbot string)
  - b) Enter a name for the session. The parent bot returns the value to the Global session (For example: Global)

8. Create a Task Bots by using the **Global session upper case child** action. You will be able to input a lower case string and also get the string from the shared parent session. Concatenate the parent and child strings.
9. Use a **Message box** to show the output.

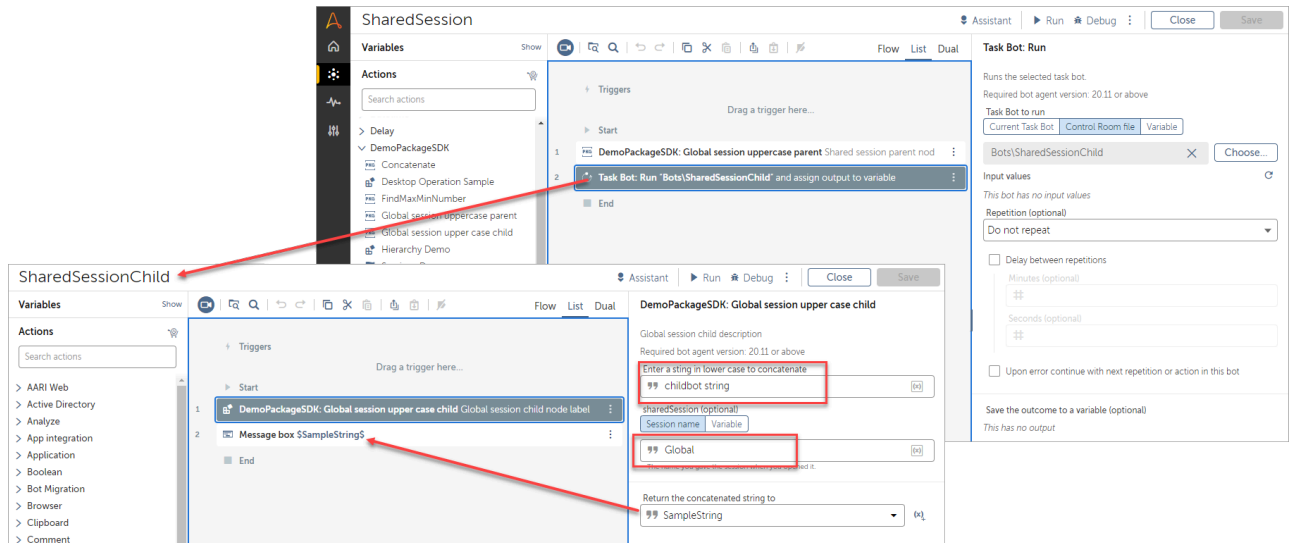

10. Now call the **Global session upper case child** into the parent.

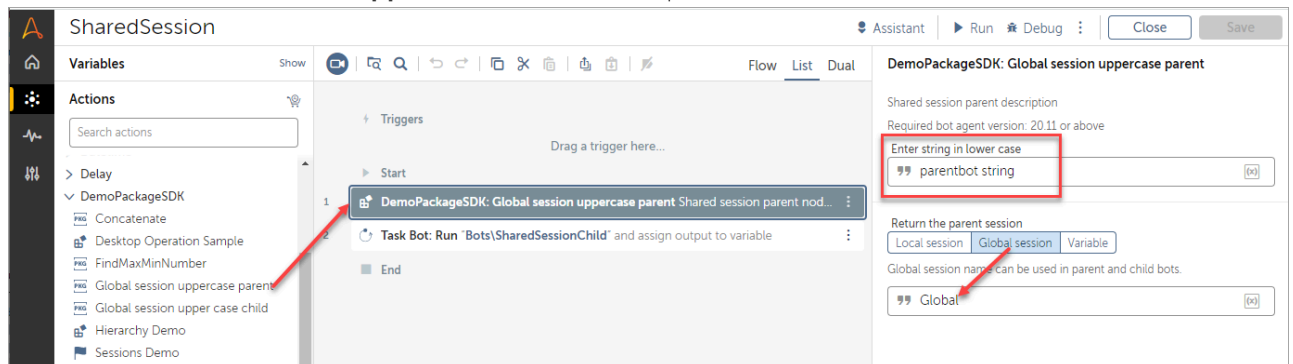

11. Run the parent bot and you will see the message box showing the value from the Child bot which it derived using the Shared global session.

## Build bots to share session details using Package SDK

A shared session enables you to reuse actions between Task Bots that run concurrently, for example, using the same Excel file to pass values.

Ensure you have the following to build a Task Bot:

- Access to the Control Room
- Credentials with **AAE\_Basic** permissions
- A development license, which enables you to create and run Task Bots
- Your workstation is a registered device in the Control Room
- An Excel file that you want to use in the shared session actions

1. Log in to the Control Room.
2. Create three Task Bots that will share the shared session actions.



3. Create a new childSession2 variable of **Type > Session** and **Session type > MS Excel session**, select **Use as input**, and then click **Apply**.
4. On the left pane, click **Automation**.  
A list of available and forms is displayed.
5. Click the **Create a bot** icon.
6. Create a new bot called childBot2.
  - a) In the **Name** field, enter childBot2.
  - b) In the Actions pane, find **Excel Advanced**, and drag **Get current worksheet name** to the Bot editor.
  - c) In **Session name > Shared session**, enter **F2 > childSession2**, and in **Assign the output to variable**, select **prompt-assignment**.
  
7. Create a new parentSession variable of **Type > Session** and **Session type > MS Excel session**, and then click **Apply**.
8. Create a new bot called parentSession, and click **Create & Edit**.
9. In the Actions pane, find **Excel Advanced**, and drag **Open** to the Bot editor.
  - a) In **File path**, select **Desktop file**, click **Browse**, and navigate to the Excel file that you want to use.
  - b) In **Session name**, retain **Default**.
  - c) Click **Save**.
  
10. Create a new childSession1 variable of **Type > Session** and **Session type > MS Excel session**, select **Use as input**, and then click **Apply**.
11. Create a new bot called childBot1.
  - a) In the **Name** field, enter childBot1.
  - b) In the Actions pane, find **Excel Advanced**, and drag **Get single cell** to the Bot editor.
  - c) Select **Active cell** in **Session name**, and select **Local name**, enter **F2**, and then in **Store cell content to**, select **prompt-assignment**.
  
12. In the Actions pane, find **Excel Advanced**, and drag **Set session variable** to the Bot editor.
  - a) In **Session name**, retain **Default**.
  - b) In **Save session to a variable**, select **parentSession**.
  
13. From the Actions pane, find **Task Bot**, and drag **Run** to the Bot editor.
  - a) In **Task Bot to run**, select **Control Room file**, click **Choose**, and then **Browse**, and select **childBot1**.
  - b) In **Input values**, select **Set childSession1**, enter **F2**, and select **parentSession**.
  
14. In the Actions pane, find **Excel Advanced**, and drag **Close**, select **Session name** as **Local name**, and retain **Default**.
15. In the Actions pane, find **Message box**. In **Enter the message to display**, enter **F2**, and then select **prompt-assignment**.
16. From the Actions pane, select **Task Bot**, and drag **Run** to the Bot editor.
  - a) In **Task Bot to run**, select **Control Room file**, click **Choose**, and then **Browse**, and then select **childBot2**.

b) In **Input values**, select **Set childSession2**, enter **F2**, and select **childSession1**.

17. In the Actions pane, find **Message box**. In **Enter the message to display**, enter **F2**, and select **prompt-assignment**.

18. Save all three bots and run the **parentSession** Task Bot.

The following three messages are displayed:

Single cell value from parent bot:1

Current worksheet name of excel opened in parent bot: Sheet1 <name of the sheet>

Your bot has run successfully!

Related concepts

[Package SDK examples](#) on page 3521

This section contains code examples and explanations about how to code some basic bot capabilities.

## Create a custom bot command exceptions

You can use the `BotCommandException` class to create a custom Bot Command Exceptions for error reporting. You can throw and catch them in your methods. With custom exceptions, you can specify detailed error messages and have more custom error handling in your catch blocks.

### Example: Define a custom `BotCommandException`

This example defines a custom exception called `DemoException`. This class extends `BotCommandException` and implements several constructors by invoking the equivalent amount of constructors in the super-class. You only need to implement the constructors that you want to use, and you can ignore the rest of the constructors in the super-class (Java classes do not inherit constructors, so you must re-implement them).

```
package com.automationanywhere.botcommand.samples.exceptions;

import com.automationanywhere.botcommand.data.Value;
import com.automationanywhere.botcommand.exception.BotCommandException;

import java.util.Optional;

public class DemoException extends BotCommandException {
    public DemoException(String message, Throwable cause) {
        super(message, cause);
    }

    public DemoException(String message) {
        super(message);
    }

    public DemoException(Throwable cause) {
        super(cause);
    }

    public DemoException(String message, Throwable cause,
        Optional<Value> outputVariables) {
```

```

        super(message, cause, outputVariables);
    }
}

```

Many constructors of the `BotCommandException` class accept a `java.lang.Throwable` object as an argument. You can implement similar constructors and pass `Throwable` objects (usually other exception objects) to your custom exceptions when you want your custom exception to include the exception that caused it.

The following example shows how to use the exception that you defined in the previous example.

```

public static boolean checkRecordsExist(Connection con, String
query)
    throws SQLException {

    Statement stmt = null;
    try {
        stmt = con.createStatement();
        ResultSet rs = stmt.executeQuery(query);
        rs.last();
        if(rs.getRow() > 0)
            return true;
    } catch (SQLException e) {
        throw new DemoException("Problem running statement", e);
    } finally {
        if (stmt != null) { stmt.close(); }
    }

    return false;
}

```

If an exception is found, then this would catch the exception and through an error statement as defined in the example.

## Annotations

This section provides reference information about the annotations used to create Automation Anywhere packages.

- [Creation and function annotations](#) on page 3564  
List of the available creation and function annotations.
- [Validation annotations](#) on page 3567  
Validates annotated strings and values used in the Java code.
- [Configure and use credential allow password annotation](#) on page 3568  
Use the provided **CredentialTypeDemo.java** package SDK file and configure the **CredentialAllowPassword** annotation for the password field in Automation 360 locker actions.

Related concepts

[Standard coding practices and guidelines for developing packages](#) on page 3512

This topic covers standard coding practices and guidelines that help to ensure the development of high quality packages.

[Package SDK examples](#) on page 3521

This section contains code examples and explanations about how to code some basic bot capabilities.

Related tasks

[Set up the Java project](#) on page 3511

Set up an integrated development environment (IDE) for Java, including Automation Anywhere custom annotations to develop an action package that you can upload to your Control Room.

[Develop a sample package](#) on page 3514

Develop your own package and upload it to an Control Room to provide custom actions for bots.

## Creation and function annotations

List of the available creation and function annotations.

### Annotation: BotCommand

Makes the type eligible to be treated as an action. You can define three types of actions **commandType** property.

- CommandAction
- Condition
- Iterator

#### Examples:

- `@BotCommand(commandType = BotCommand.CommandType.Iterator)`
- `@BotCommand(commandType = Condition)`
- `@BotCommand(commandType = Variable)`
- `@BotCommand(commandType = Trigger)`

### Annotation: CommandPkg

Makes the type eligible for creation of action **package.json**. This annotation must be used with **BotCommand** to take effect. **Pkg** participates in the activity only when this annotation is present.

#### Example:

```
@CommandPkg(label = "Create", name = "createFile",
description = "Creates a file", node_label = "{{filePath}}",
icon = "file.svg")
```

### Annotation: ConditionTest

Participates in the **Condition** execution. This annotation can only be used when the **BotCommand** has **commandType** set as **Condition**. Only one method needs to be annotated when **BotCommand** annotation is present on the type. Failure to do so will result in the compilation error.

## Annotation: Execute

Participates in the execution of **BotCommand**. Exactly one method needs to be annotated when **BotCommand** annotation is present on the type. Failure to do so will result in the compilation error.

### Example:

```
@Execute public void create( @Idx(index = "1", type = FILE) @LocalFile
    @Pkg(label =
    "File", description = "e.g. C:\\MyDoc\\MyFile.doc") @NotEmpty String
    filePath,
    @Idx(index = "2", type = CHECKBOX) @Pkg(label = "Overwrite an existing
    file")
    @NotEmpty Boolean isOverwrite) { createFile(filePath, isOverwrite); }
```

## Annotation: GlobalSessionContext

Can only be applied to member variables and fetches the GlobalSessionContext through a setter.

### Example:

```
@com.automationanywhere.commandsdk.annotations.GlobalSessionContext
private GlobalSessionContext globalSessionContext;

public void setSessionMap(Map < String, Object > sessionMap) {
    this.sessionMap = sessionMap;
}
public void
setGlobalSessionContext (com.automationanywhere.bot.service.GlobalSessionContext
globalSessionContext) {
    this.globalSessionContext = globalSessionContext;
}
```

## Annotation: HasNext

Participates in the execution of **Iterator**. This annotation can only be used when the **BotCommand** has commandType set as **Iterator**. Requires the **Next** annotation to be present. One method needs to be annotated when **BotCommand** annotation is present on the type. Failure to do so will result in the compilation error.

## Annotation: Index

Makes the annotated element part of hierarchy utilized for the code and resource generation. Without this annotation no **BotCommand** related element annotations would be processed.

## Annotation: Idx.Option

An option represents the elements that would play in the hierarchy, but lend the values to the parents.

### Examples:

- RADIO

```
@Idx(index = "1", type = RADIO, options = {
    @Idx.Option(index = "1.1", pkg = @Pkg(node_label
    = "[[Delay.delayType.1.1.node_label]]", label =
    "[[Delay.delayType.1.1.label]]", value = REGULAR)),
    @Idx.Option(index = "1.2", pkg = @Pkg(node_label
    = "[[Delay.delayType.1.2.node_label]]", label =
    "[[Delay.delayType.1.2.label]]", value = RANDOM))
})
@Pkg(label = "[[Delay.delayType.label]]", default_value = "REGULAR",
    default_value_type = DataType.STRING)
@Inject
private String delayType;
```

- SELECT

```
@Idx(index = "2", type = SELECT, options = {
    @Idx.Option(index = "2.1", pkg = @Pkg(label =
    "[[LaunchWebsite.browser.2.1.label]]", value = "DEFAULT")),
    @Idx.Option(index = "2.2", pkg = @Pkg(label =
    "[[LaunchWebsite.browser.2.2.label]]", value =
    "INTERNET_EXPLORER")),
    @Idx.Option(index = "2.3", pkg = @Pkg(label =
    "[[LaunchWebsite.browser.2.3.label]]", value = "FIREFOX")),
    @Idx.Option(index = "2.4", pkg = @Pkg(label =
    "[[LaunchWebsite.browser.2.4.label]]", value = "CHROME"))
}) @Pkg(label = "[[LaunchWebsite.browser.label]]", default_value
    = "DEFAULT", default_value_type = DataType.STRING)
@NotEmptyString(browser)
```

## Annotation: Inject

Makes an element eligible for injection into the annotated type object. The injection is setter-based so a corresponding setter in the type is **mandatory**. The injected values would form the **BotCommand** parameter map using the name provided in **Idx**.

## Annotation: Next

Participates in the **Iterator** execution. This annotation can only be used when the **BotCommand** has `commandType` set as **Iterator**. Requires the `HasNext` annotation to be present. One method needs to be annotated when **BotCommand** annotation is present on the type. Failure to do so will result in compilation error.

## Annotation: Pkg

Makes an element to participate in the `package.json` creation. This annotation is ignored when **Idx** is not present.

Related concepts

[Annotations](#) on page 3563

This section provides reference information about the annotations used to create Automation Anywhere packages.

## Validation annotations

Validates annotated strings and values used in the Java code.

Annotation	Description
<b>CodeType</b>	The MIME-type of the code to format.
<b>CredentialOnly</b>	Can only accept a credential value, no string allowed.
<b>Equals</b>	Validates that the given string is equal to the annotated string variable.
<b>FileExtension</b>	Validates the annotated string value that ends with the supported extension type.
<b>GreaterThan</b>	Validates that the annotated number variable value is always greater than the given numeric value.
<b>GreaterThanEqualTo</b>	Validates that the annotated number variable value is always greater than or equal to the given numeric value.
<b>LessThan</b>	Validates that the annotated number variable value is always less than the given numeric value.
<b>LessThanEqualTo</b>	Validates that the annotated number variable value is always less than or equal to the given numeric value.
<b>LocalFile</b>	Can only accept local paths and no file expression.
<b>MatchesRegex</b>	Validates that the annotated string value matches the given regular expression.

Annotation	Description
<b>NotEmpty</b>	Validates and throws an exception when the annotated variable value is null.  <pre>@Execute public Value&lt;Double&gt;length (@Idx (index="1", type=TEXT) @Pkg (label="Source string") @NotEmpty String sourceString) {}</pre>
<b>NotEquals</b>	Validates that the given string is not be equal to the annotated string variable.
<b>NotMatchesRegex</b>	Validates that the annotated string value does not match the given regular expression.
<b>NumberInteger</b>	Ensures the UI accepts only integers and not double for the annotated variable value.
<b>RepositoryFile</b>	Can only accept repository paths and no file expression.
<b>VariableNotPackage</b>	Cannot choose a variable from this package.
<b>VariablePackage</b>	Can only choose a variable from this package.
<b>VariableSubType</b>	The variable subtype must match.
<b>VariableType</b>	The variable type must match.
<b>VariableUserDefined</b>	Can only choose a user-defined variable.

Related concepts

[Annotations](#) on page 3563

This section provides reference information about the annotations used to create Automation Anywhere packages.

## Configure and use credential allow password annotation

Use the provided **CredentialTypeDemo.java** package SDK file and configure the **CredentialAllowPassword** annotation for the password field in Automation 360 locker actions.

### Example: Review the CredentialTypeDemo.java

Use the following **CredentialTypeDemo.java** file located at: <latest package-sdk>2.0.9\src\main\java\com\automationanywhere\botcommand\samples\commands\basic\types as an example on how to configure the credential attribute.

```
@BotCommand
@CommandPkg (label = "[[CredentialTypeDemo.label]]",
description = "[[CredentialTypeDemo.description]]", icon =
"sample.svg", name = "credentialTypeDemo")
public class CredentialTypeDemo {
```



```
private static Logger logger =
LogManager.getLogger(CredentialTypeDemo.class);

/**
 * To accept credentials the {@link AttributeType} in index should be
 * {@link AttributeType.CREDENTIAL CREDENTIAL}. A {@link SecureString}
 is
 * provided for any credentials type.
 */
@Execute
public void printCredentials(@Idx(index = "1", type =
AttributeType.CREDENTIAL)
@Pkg(label = "[[CredentialTypeDemo.credentials.label]]")
SecureString credentials) {
// SecureString provides multiple way to access the data inside.
// Let's try to get the user name and print it in logs.

// To get the username as String
String userName = credentials.getInsecureString();
logger.trace("User name from getInsecureString : {}", userName);
```

### Example: Configure the credential attributes @Execute

Configure the index, type, label, optional description, and the credentialAllowPasswordAttribute. When creating a new or updating an existing package, use the **CredentialAllowPassword** annotation to allow the credential picker to pick a credential attribute marked as a password field.

```
@Execute
public void printCredentials(@Idx(index = "2", type =
AttributeType.CREDENTIAL)
@Pkg(label =
"[[CredentialTypeDemo.credentialsAllowPasswordAttribute.label]]")
@CredentialAllowPassword
SecureString credentialAllowPasswordAttribute) {
```

### Configure the attributes in the Control Room

In the **Attribute name** field, enter **password** and an optional **description**, in **Input** field, select **Standard**, and enter the **value**. In the **Security** field, select **Use attribute only on Password or Masked fields**.

### Use the credential attribute in Control Room

- In the **Pick a credential** field, select **credential**. In the **Attribute** field, select **username**. In the **Provide the credential for the user (optional)** field, select **Credential**, and then **Pick**.
- In the **Attribute** field, select **password**. In the **Provide the credential for the password (optional)** field, select **Credential**, and then **Pick**.

## Build and test a demo package and bot

This practical how to section demonstrates that creating, changing, and managing packages allow you to customize actions and efficiently manage packages for all Control Room users.

Here is a list of all the necessary tasks to create a package, add the package to your Control Room, and verify your work in a bot. Complete the listed tasks in order.

**Tip:** Click the title of each step to go the detailed task.

Step 1 <a href="#">Update related workflow and build files on page 3570</a>	Follow the detailed steps for updating workflow and build files for this project using your integrated development environment (IDE).
Step 2 Choose your favorite IDE	You can compile a package from the IDE of your choice. Here are two possible ways you can compile a package: <ul style="list-style-type: none"> <li><a href="#">Compile a demo JAR file from the Eclipse UI on page 3571</a> Use Eclipse to compile a demo JAR file that you can add as a package to your Control Room.</li> <li><a href="#">Compile a demo JAR file from the command line on page 3571</a> Compile the demo Java code provided with this software development kit.</li> </ul>
Step 3 <a href="#">Add your demo package to the Control Room on page 3572</a>	Users with <b>Upload package</b> permission can add packages to the Control Room for use by all Bot Creators.
Step 4 <a href="#">Create a demo bot with the demo package on page 3573</a>	Create a bot using the demo package to verify the actions that were created.
Step 5 <a href="#">Change the Java file used to create the package JAR file on page 3574</a>	Modify and compile the Java code used to create a package to fix issues and create new functionality.
Step 6 <a href="#">Upload new demo package on page 3574</a>	Package management allows you to upload package updates. The new package has the same name, but a different version number.
Step 7 <a href="#">Update the demo bot with the updated package on page 3575</a>	Update bots to use specific package versions.

## Update related workflow and build files

Follow the detailed steps for updating workflow and build files for this project using your integrated development environment (IDE).

Complete all the steps for project setup detailed in [Set up the Java project on page 3511](#).

This task shows you how to update the appropriate build and workflow files.

1. Open the project "A2019DemoPackage" that you created in [Set up the Java project on page 3511](#).  
You can find the project file in the directory where you extract the zip files to, for example `c:\A2019DemoPackage`.
2. From inside the project, Open the **settings.gradle** file.
3. Replace the project name with `A2019DemoPackageFirstnameLastname`.  
If your name is John Developer it would look like this, `A2019DemoPackageJohnDeveloper`.
4. Open **src > main > resources > package.template**.

5. Update the **name**, **label**, and **description** values.

Original package.template	Updated package.template
<pre>{   "name":   "A2019DemoPackage",   "label":   "A2019DemoPackage",   "description":   "Provides actions for A2019DemoPackage operations.",   "group": "",   "artifactName": "",   "packageVersion": "",   "codeVersion": "",   "commands": [] }</pre>	<pre>{   "name":   "A2019DemoPackageFirstnameLastname",   "label":   "A2019DemoPackageFirstnameLastname",   "description":   "A2019DemoPackageFirstnameLastname",   "group": "",   "artifactName": "",   "packageVersion": "",   "codeVersion": "",   "commands": [] }</pre>

6. Save the changes.

After you have setup the build files, you need to compile the demo Java code, [Compile a demo JAR file from the command line](#) on page 3571.

## Compile a demo JAR file from the Eclipse UI

Use Eclipse to compile a demo JAR file that you can add as a package to your Control Room.

Before starting this task complete the steps in [Update related workflow and build files](#) on page 3570.

Build a package file using a Gradle project in the Eclipse IDE.

1. Import the A2019DemoPackage as a Gradle project, **File > Import > Gradle > Existing Gradle Project** and click **Finish**.
2. From the **Gradle Tasks** tab, go to **<your project> > build** and run the following tasks in order.
  - a) **<your project> > build > clean**
  - b) **<your project> > build > build**
3. From the **Gradle Tasks** tab, go to **<your project.> shadow** and run the **shadowJar** task.

Your compiled package file is located in file:\ \A2019DemoPackage\build\libs\. The package file has named after your project name (<your project>-1.0.0.jar).

To add your custom package to your Control Room follow the instructions in [Add packages to the Control Room](#) on page 1908.

Related concepts

[Build and test a demo package and bot](#) on page 3569

This practical how to section demonstrates that creating, changing, and managing packages allow you to customize actions and efficiently manage packages for all Control Room users.

## Compile a demo JAR file from the command line

Compile the demo Java code provided with this software development kit.

Before starting this task complete the steps in [Update related workflow and build files](#) on page 3570.

1. Open a terminal window and go to where the **gradlew.bat** file is located.  
**...\A2019DemoPackage > gradlew.bat**
2. In the terminal window, type `gradlew.bat clean build shadowJar`, and press Enter. Here is an example of what you see:

```
> . . .\A2019DemoPackage>gradlew.bat clean build shadowJar

> Task :compileJava
Note: Starting hierarchy discovery for
'com.automationanywhere.botcommand.demo.Concatenate'
Note: Starting non-hierarchical element discovery for
'com.automationanywhere.botcommand.demo.Concatenate'
Note: Starting hierarchy discovery for
'com.automationanywhere.botcommand.demo.Uppercase'
Note: Starting non-hierarchical element discovery for
'com.automationanywhere.botcommand.demo.Uppercase'
Note: Starting Command Java generator...
Note: Starting Json generator...
Note: Generating command json for Concatenate
Note: Generating command json for Uppercase

> Task :commandCodeGen
mergeJsonFiles: updatePackage: group com.automationanywhere ,
  artifactName A2019DemoPackageFirstnameLastname ,
  packageVersion 1.0.0-20190816-101906
```

The compiled file is located in `file:\ \A2019DemoPackage\build\libs\`.

To add your custom package to your Control Room follow the instructions in [Add packages to the Control Room](#) on page 1908.

Related concepts

[Build and test a demo package and bot](#) on page 3569

This practical how to section demonstrates that creating, changing, and managing packages allow you to customize actions and efficiently manage packages for all Control Room users.

## Add your demo package to the Control Room

Users with **Upload package** permission can add packages to the Control Room for use by all Bot Creators.

Before you can upload a package, you need valid user login credentials with **Upload package** permission for the Control Room you are adding the package to.

To add a package from a source other than Bot Store, follow these steps:

1. Navigate to **Manage > Packages**.
2. Click **Add package**.
3. Click **Browse**.
4. Locate and select the package to add to the Control Room.  
Packages are Java Archive (JAR) files that contain actions used to create bots.
5. Click **Upload package**.
6. On the **Packages > Confirm package** page, choose any of the following options:

- **Accept, enable and set as default:** Uploads and enables the selected package, and sets it to the default package for the Control Room.
- **Accept and enable:** Uploads and enables the package, but the package is not set as the default package. Bot Creators have to specifically select non-default packages to use them for creating bots.
- **Accept but disable:** Uploads and disables the new package.

Choosing **Reject** stops the upload process.

To add a package from Bot Store, see the following video:

7. After installation, click **Administration > Packages** to verify that the package is added.  
When you add or update a package in the Control Room, a notification is also sent through the **Notifications** icon. This notification is sent to the Control Room users who have the **View package** permission. For more information, see [Capabilities supporting notifications](#) on page 2208.

After successfully uploading your demo package, create a bot to test the actions you just created. For detailed step about how to create a bot, read [Create a demo bot with the demo package](#) on page 3573

## Create a demo bot with the demo package

Create a bot using the demo package to verify the actions that were created.

Here are the minimum prerequisites for building this demo bot:

- Access to a Control Room
- User credentials with **AAE\_Basic** permission
- Your local host (workstation) is a registered device in the Control Room
- Ensure that the demo package `A2019DemoPackageFirstnameLastname` is available in the Control Room

This task uses the following actions and components:

- Uppercase (demo package)
  - [Message box](#)
  - [Variables overview](#) on page 2326
1. On the left pane, click **Automation**.  
A list of available and forms is displayed.
  2. Click the **My Task Bot** icon.
  3. Type `MyDemoBot1` in the **Name** field.
  4. Click **Create & Edit**.
  5. Expand **A2019DemoPackageFirstnameLastname** and double **Uppercase**.
  6. Type `hello world, go be great!` in all lower case letters.
  7. Create the variable `vMyDemoVar1`.
  8. Click **Apply**.
  9. Add a **Message box** and insert the variable **vMyDemoVar1** in the **Enter the message to display** field.
  10. Click **Apply** and **Save**.
  11. Click the **Run** icon.

A message box with "HELLO WORLD, GO BE GREAT!" in all upper case letters is displayed. The custom action **Uppercase** converted all the letters from lower case letters to upper case letters.

The task, [Change the Java file used to create the package JAR file](#) on page 3574, gives instruction on how to modify the **Uppercase** action to convert all upper case letters to lower case letters.

## Change the Java file used to create the package JAR file

Modify and compile the Java code used to create a package to fix issues and create new functionality.

1. Open the project "A2019DemoPackage."
2. From inside the project, open **src/main/java/com.automationanywhere.botcommand.samples.commands/basic/Uppercase**.
3. Change the function from upper case to lower case.

Original function	Updated function
<pre>String result = "ALL".equals(caseType) ?  sourceString.toUpperCase() : (sourceString .substring(0, 1).toUpperCase() + sourceString .substring(1));</pre>	<pre>String result = "ALL".equals(caseType) ?  sourceString.toLowerCase() : (sourceString .substring(0, 1).toUpperCase() + sourceString .substring(1));</pre>

4. Save the changes and re-compile the package.

You can now upload the changed package to the Control Room. [Upload new demo package](#) on page 3574

Related tasks

[Upload new demo package](#) on page 3574

Package management allows you to upload package updates. The new package has the same name, but a different version number.

## Upload new demo package

Package management allows you to upload package updates. The new package has the same name, but a different version number.

You need **AAE\_Basic** permissions to create and edit bots.

1. From the **Manage > Packages** page, click the **Add package** icon.
2. **Browse** to the location of the package to add.  
Packages are Java Archive (JAR) files that contain actions used to create bots.
3. Select the package to add, and click **Upload package**.
4. On the **Packages > Confirm package** page, click **Accept, enable and set as default**.

You can select specific packages to be used from within a bot. Read detailed steps about managing packages for specific bots in [Update the demo bot with the updated package](#) on page 3575 task.

## Update the demo bot with the updated package

Update bots to use specific package versions.

- Access to the bot created in the task [Create a demo bot with the demo package](#) on page 3573.
  - **AAE\_Basic** permission.
1. On the left pane, click **Automation**.  
A list of available and forms is displayed.
  2. Double-click **MyDemoBot1**, the demo bot you created in an earlier task.
  3. Click the **vertical eclipses** in the upper right corner and click **Packages**.
  4. Expand the row for the package **A2019DemoPackageFirstnameLastname**.
  5. From the drop-down list of package versions, select the **Default** version.  
Because you added the updated package as the default version, you are selecting the new version of the package you created.
  6. Click **Change Version** and **Save**.
  7. On the left pane, click **Automation**.  
A list of available and forms is displayed.
  8. Double-click **MyDemoBot1**.
  9. Click **A2019DemoPackageFirstnameLastname** and type `HELLO WORLD, GO BE GREAT!` in the **Source string** field.
  10. Click **Apply** and **Save**.
  11. Click the **Run** icon.  
The message box displayed by the bot displays "hello world, go be great!" This verifies that the action from the updated package is being used.

## Build and test a custom package

Use IntelliJ to build a custom package and use Automation 360 actions to test the package.

Complete the following tasks to create a custom package, upload the package to your Control Room, and build a bot to test it. After you update the IntelliJ files, create directories, and create and update java classes, you can build the custom package.

1. [Build a custom package in IntelliJ](#) on page 3576  
Use IntelliJ to import the Automation Anywhere SDK, create a new package, and compile a JAR file that you can upload to your Control Room.
2. [Add custom package to your Control Room](#) on page 3582  
Use the compiled JAR file and upload it to the Control Room.
3. [Create a bot to test the custom package](#) on page 3583  
Use Automation 360 actions to create a bot to test the custom package.

**Note:** The customer support team does not provide guidance for the code written by customers.

**Note:** [Create custom packages](#)

## Build a custom package in IntelliJ

Use Java IntelliJ to create and compile a JAR file that you can upload as a package to your Control Room in Automation 360.

A basic understanding of JDK and Java IntelliJ is required in order to build an action package. Ensure you have installed the following software and files:

- [Java SE Development Kit 11 Downloads](#)
- Java IDE [Community edition of IntelliJ](#)

1. Download the latest release of the Automation Anywhere Package SDK. For the latest release of the Package SDK, see - [Previous Package SDK Release Notes](#) on page 975.
2. Unzip the contents of the SDK package to any of your local directory.
3. Rename the folder from `A360-package-sdk-<version number>` to `MetricToImperial`.
4. In IntelliJ IDEA, go to **File > Open** and open the project at `C:\<SavedLocation>\MetricToImperial`.

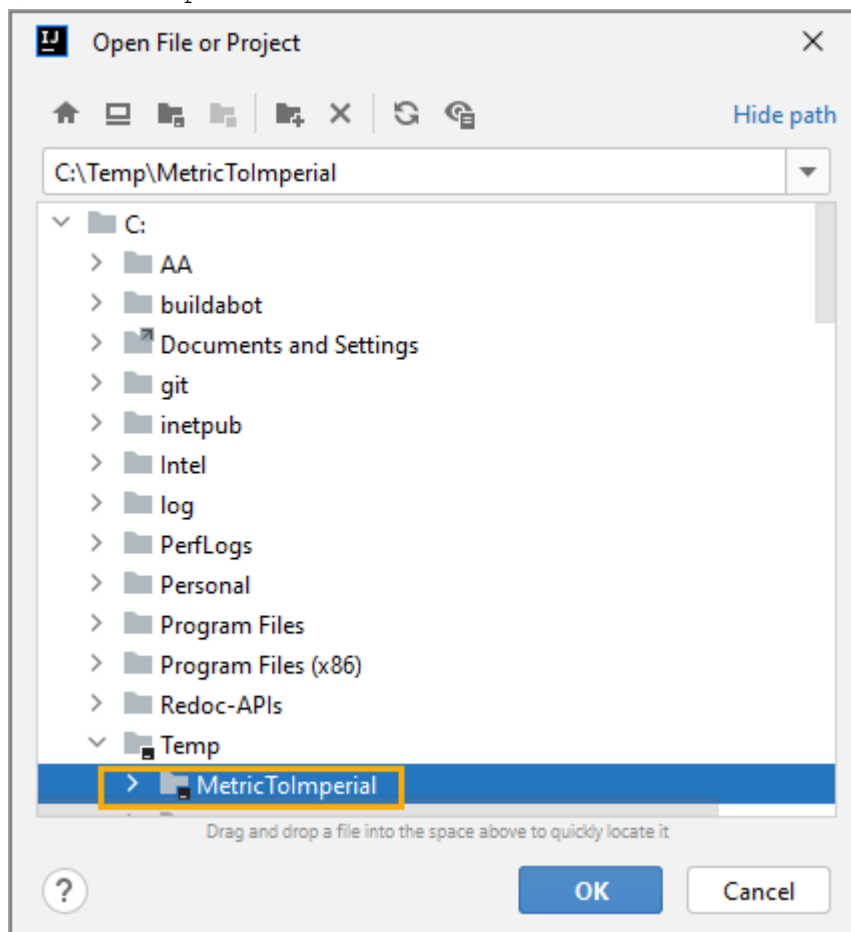

5. Open the `settings.gradle` file in the project root. Set the `rootProject.name = 'MetricToImperial'`



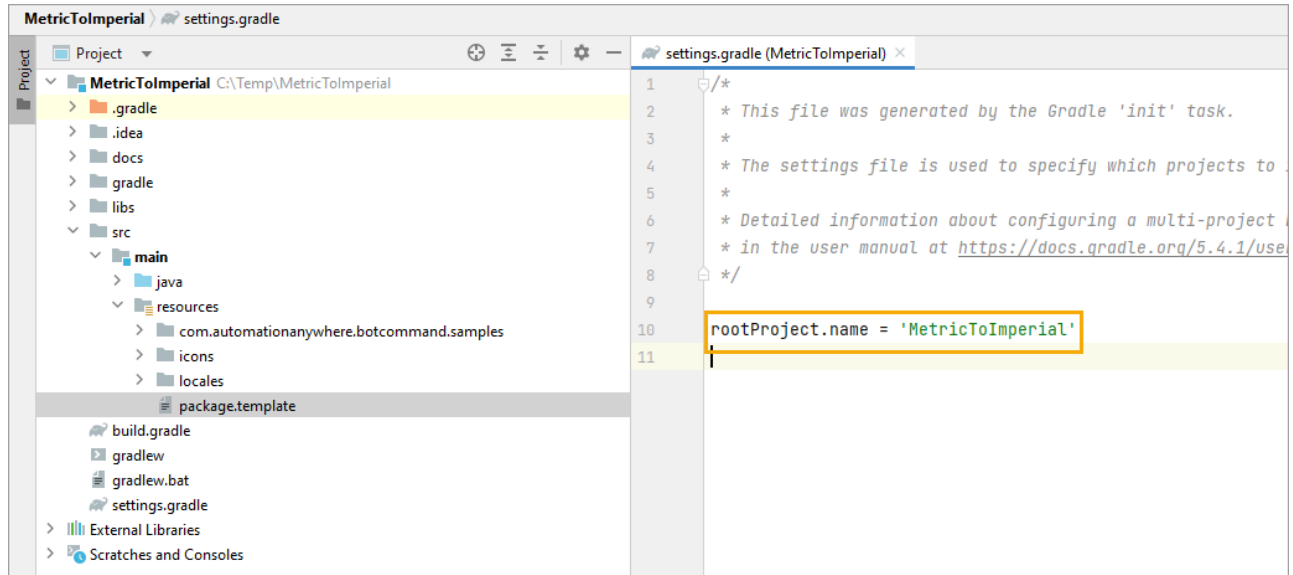

6. Open the package.template file located at **src > main > resources > package.template**.
7. Change the package name from A360DemoPackage to MetricToImperial.

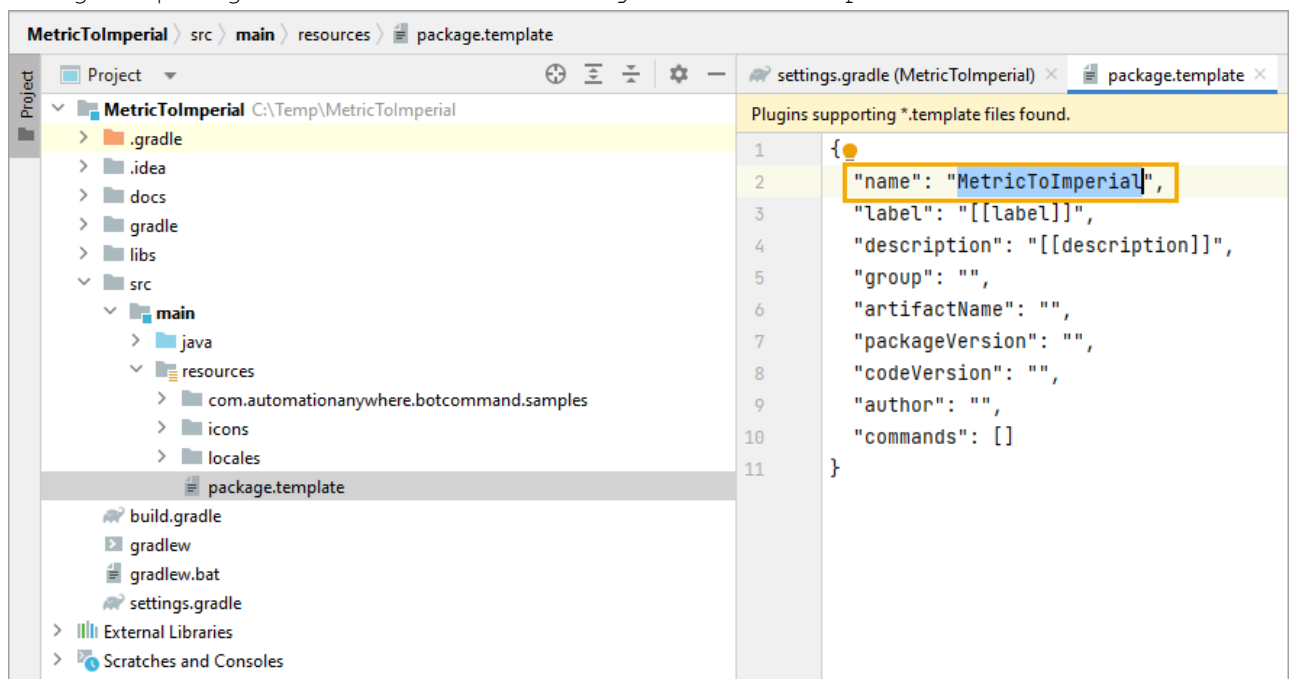

Click the **Sync** button in IntelliJ to update the project.

8. Update the package name in **locales json**: go to **src > main > resources > locales > en\_US.json**.
  - a) Open the **en\_US.json** file and update the **required** label field from A360DemoPackage to MetricToImperial. Update the optional description.
  - b) Delete all other remaining lines in the **en\_US.json** file.
9. Delete the sample packages, go to **src > main > java > com.automationanywhere.botcommand**, and delete the **samples.commands** and delete the **samples** packages.

10. Create a new package, right-click on java folder and select **New > Package**. Enter the new package name as `metrictoimperial.commands`.
11. Create a new **Java Class**, right-click on the `metrictoimperial.commands` package, and select **New > Java Class**. Enter the name for the new class `CMtoINCH`:
  - a) Open the **CMtoINCH** class. Copy and paste the following code above the class definition statement:

```
import static
    com.automationanywhere.commandsdk.model.DataType.NUMBER;
//BotCommand makes a class eligible for being considered as an
action.
@BotCommand
//CommandPks adds required information to be disalable on GUI.
@CommandPkg(
    //Unique name inside a package and label to display.
    name = "CMtoInch", label = "[[CMtoINCH.label]]",
    node_label = "[[CMtoINCH.node_label]]", description =
    "[[CMtoINCH.description]]", icon = "ruler_icon.svg",
    //Return type information. return_type ensures only the
right kind of variable is provided on the UI.
    return_label = "[[CMtoINCH.return_label]]", return_type =
NUMBER, return_required = true)
```

- b) Inside the **CMtoINCH** class, copy and paste the following code:

```
//Identify the entry point for the action. Returns a Value<String>
because the return type is String.
@Execute
public NumberValue action(
    //Idx 1 would be displayed first, with a text box for
entering the value.
    @Idx(index = "1", type = AttributeType.NUMBER)
    //UI labels.
    @Pkg(label = "[[CMtoINCH.CMInput.label]]")
    //Ensure that a validation error is thrown when the value is
null.
    @NotEmpty
    Double CMInput) {
    //Internal validation, to disallow empty inputs. No null check
needed as we have NotEmpty on CMInput.
    if (!"".equals(CMInput.toString().trim()))
        throw new BotCommandException("Input of CM is required");
    Number result;
    try {
        //Conversion logic
        result = CMInput * 0.393701;
    } catch (Exception e) {
        //Throw custom error message
        throw new BotCommandException("Unable to convert " +
CMInput.toString() + "cm to inches");
    }
    //Return NumberValue.
    return new NumberValue(result);
}
```

To import the namespaces, click the highlighted red notations and press ALT+ENTER key and select **Import** which automatically imports namespaces based on the annotations and datatypes.

```

MetricToImperial | src | main | java | metrictoimperial | commands | CMtoINCH | action
Project
  MetricToImperial C:\Temp\MetricToImperial
    .gradle
    .idea
    build
    docs
    gradle
    libs
    src
      main
        java
          metrictoimperial.commands
            CMtoINCH
              resources
              test
              build.gradle
              gradlew
              gradlew.bat
              settings.gradle
            External Libraries
            Scratches and Consoles
  Bookmarks
  Structure
  Version Control
  TODO
  Problems
  Terminal
  Services
  Dependencies
4
import com.automationanywhere.commandsdk.annotations.*;
5
import com.automationanywhere.commandsdk.annotations.rules.NotEmpty;
6
import com.automationanywhere.commandsdk.model.AttributeType;
7
8
import static com.automationanywhere.commandsdk.model.DataType.NUMBER;
9
//BotCommand makes a class eligible for being considered as an action.
10
@BotCommand
11
//CommandPks adds required information to be dispalable on GUI.
12
@CommandPkg(
13
    //Unique name inside a package and label to display.
14
    name = "CMtoInch", label = "[[CMtoINCH.label]]",
15
    node_label = "[[CMtoINCH.node_label]]", description = "[[CMtoINCH.description]]", icon = "ruler_icon.svg",
16
    //Return type information. return_type ensures only the right kind of variable is provided on the UI.
17
    return_label = "[[CMtoINCH.return_label]]", return_type = NUMBER, return_required = true)
18
public class CMtoINCH {
19
    //Identify the entry point for the action. Returns a Value<String> because the return type is String.
20
    @Execute
21
    public NumberValue action(
22
        //Idx 1 would be displayed first, with a text box for entering the value.
23
        @Idx(index = "1", type = AttributeType.NUMBER)
24
        //UI labels.
25
        @Pkg(label = "[[CMtoINCH.CMInput.label]]")
26
        //Ensure that a validation error is thrown when the value is null.
27
        @NotEmpty
28
        Double CMInput) {
29
    //Internal validation, to disallow empty inputs. No null check needed as we have NotEmpty on CMInput.
30
    if (!"".equals(CMInput.toString().trim()))
31
        throw new BotCommandException("Input of CM is required");
32
    Number result;
33
    try {
34
        //Conversion logic
35
        result = CMInput * 0.393701;
36
    } catch (Exception e) {
37
        //Throw custom error message
38
        throw new BotCommandException("Unable to convert " + CMInput.toString() + " cm to inches");
39
    }
40
    //Return NumberValue.
41
    return new NumberValue(result);
42
}
43

```

- Configure **en\_US.json** file, go to **src > main > resources > locales > en\_US.json** and add the following fields after the label and description values:

```

"CMtoINCH.label" : "cm to inches",
"CMtoINCH.node_label": "cm to inches",
"CMtoINCH.description" : "Convert centimeters to inches",
"CMtoINCH.return_label" : "Assign the Output in Inches to a Number Variable",
"CMtoINCH.CMInput.label" : "Centimeters to Convert to Inches"

```

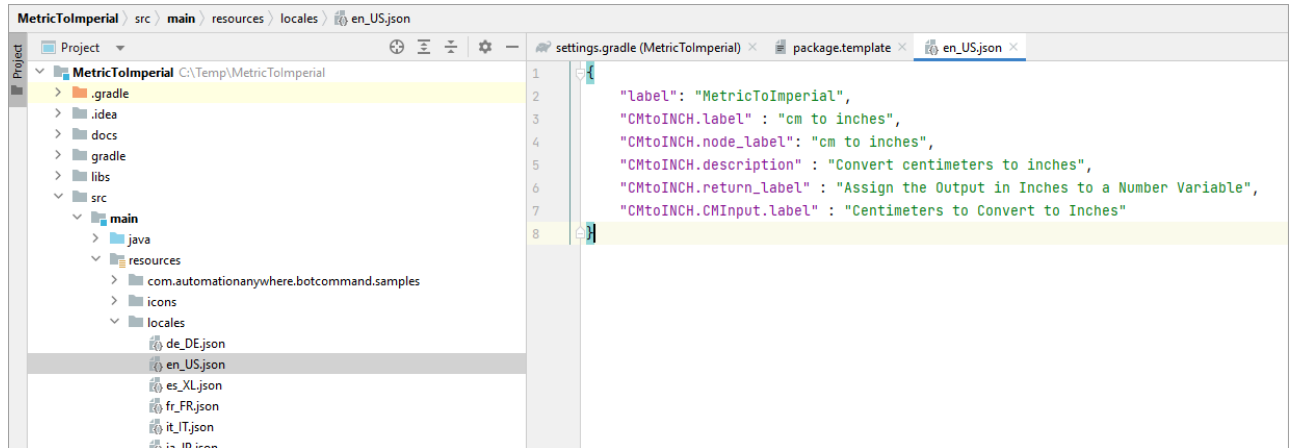

13. Update the CommandPkg annotation. Download icons from Github.
- Download ruler\_icon.svg from [github](#) and right-click the image and save the image as ruler\_icon.svg.
  - Download iconwhite.svg from [github](#), right-click the image and save the image iconwhite.svg.
  - Copy both files into the **src > main > resources > icons** folder.

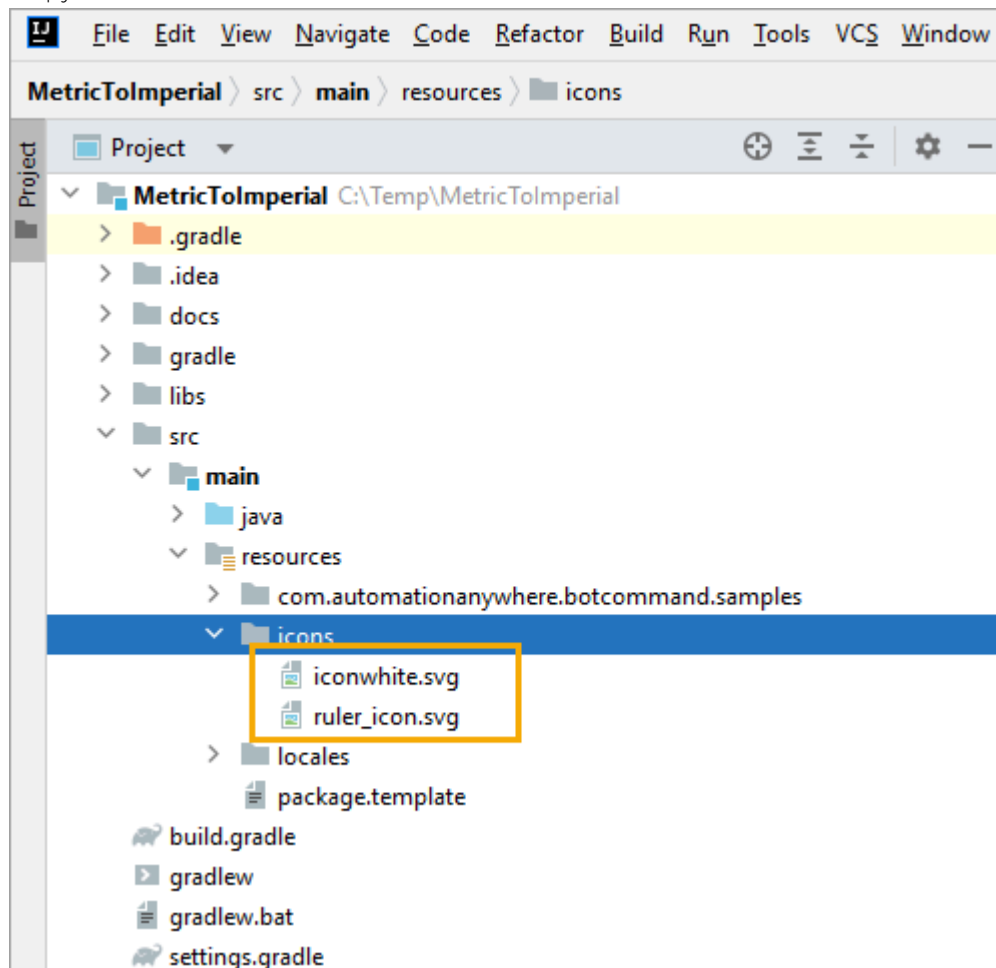

14. Open the `build.gradle` in the project root. After the dependencies section, but before the last closing tag, copy and paste the following code:

```
test {
    testLogging {
        exceptionFormat = 'full'
    }
    useTestNG() {}

    afterSuite { desc, result ->
        if (!desc.parent)
            println("${result.resultType} " +
                "${result.testCount} tests, " +
                "${result.successfulTestCount} successes, " +
                "${result.failedTestCount} failures, " +
                "${result.skippedTestCount} skipped")
    }
    maxHeapSize "3g"
}
```

15. Update the version number and remove dependencies that is not required for your project from `build.gradle`.
16. Create a new directory, right-click **src** and select **New > Directory**.
  - a) In the **Name** field, enter `test\java`, or select the **test\java** suggestion from the **Gradle Source Sets**.
  - b) Create a new package, right-click the `java` directory and select **New > Package**.
  - c) Enter the name for the newly created package: `metrictoimperial.commands`.
17. Create new Java class, right-click and select **New > Java Class**. Enter the name for the new class `CMtoINCHTest`.

Inside the `CMtoINCHTest` class, copy and paste the following code:

```
@Test
public void testCMtoINCH(){
    Double validInput = 10.00;
    Double expectedOutput = 0.393701 * validInput;
    CMtoINCH testCM = new CMtoINCH();
    Value<Double> result = testCM.action(validInput);
    Assert.assertEquals(result.get(), expectedOutput);
}
```

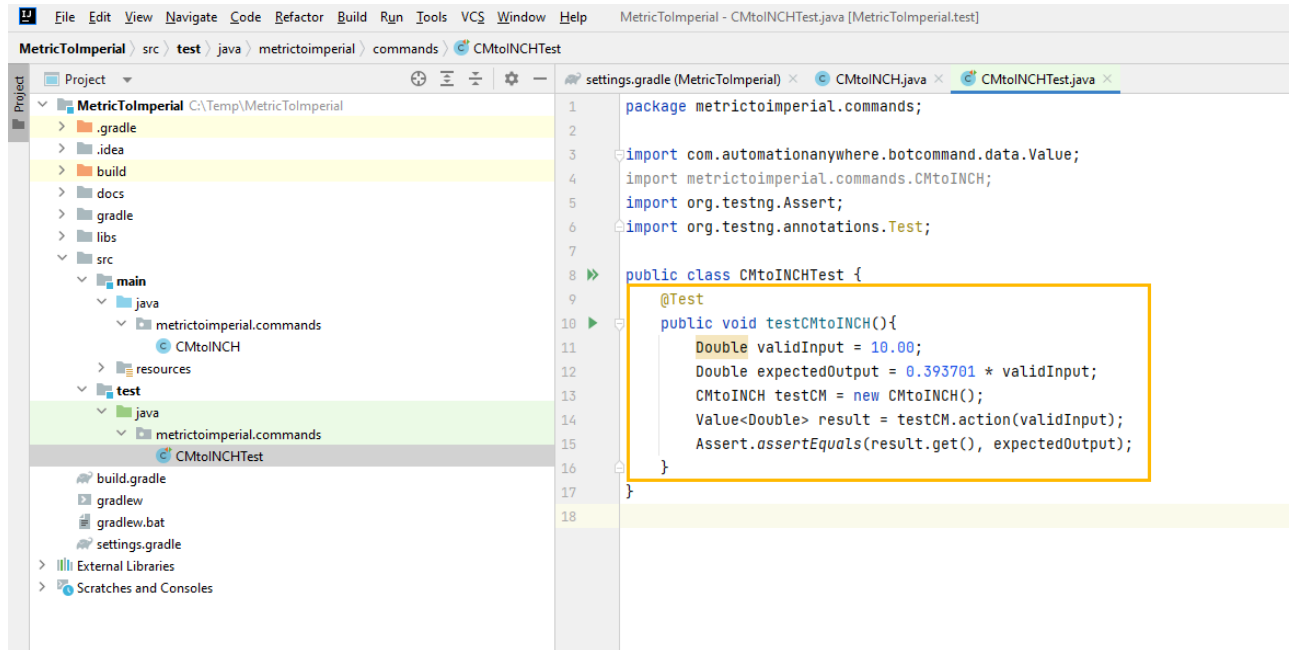

18. Save the project **File > Save All**.

19. Build the package.

You can use the IntelliJ UI or the command line. If you are using the command line:

- a) Open a terminal window and navigate to the `MetricToImperial` directory.
- b) To build the project, enter the following command: `gradlew.bat clean build shadowJar`

A `BUILD SUCCESSFUL` message appears.

Sometimes a build might fail because existing files could not be automatically deleted and a system message appears indicating the execution failed for the task: `clean`. If this occurs, close the explorer windows and run the build again.

[Add custom package to your Control Room](#) on page 3582

## Add custom package to your Control Room

Use the compiled JAR file and upload it as a package to your Control Room in Automation 360.

- Complete the steps in [Build a custom package in IntelliJ](#) on page 3576.
  - Ensure you have the following:
    - Access to the Control Room.
    - Credentials with **AAE\_Basic** permission or a custom role with permissions to add packages to the Control Room.
1. From Windows Explorer, go to `C:\Users\<<Username>\IdeaProjects\MetricToImperial\build\libs` and locate `MetricToImperial-1.0.0.jar`.
  2. Log in to your Control Room as a user with permissions to add a new package.
  3. Click **Manage > Packages**.
  4. In the **Packages** page, move your mouse over the plus sign and click **Add package**.

5. In the **Add package** page, click **Browse** and locate the `MetricToImperial-1.0.0.jar` file. By default, the file is located at: `C:\Users\<<Username>\IdeaProjects\MetricToImperial\build\libs`.
6. Select the `MetricToImperial-1.0.0.jar` file and click **Open**.
7. Click **Upload Package**.  
When you add a custom package to the Control Room, a notification is also sent to the Control Room users to notify about package updates. This notification is sent to the users who have the **View package** permission. For more information, see [#unique\\_297/unique\\_297\\_Connect\\_42\\_package-event](#) event notification.

[Create a bot to test the custom package](#) on page 3583

Related concepts

[Build and test a custom package](#) on page 3575

Use IntelliJ to build a custom package and use Automation 360 actions to test the package.

Related tasks

[Add custom package to your Control Room](#) on page 3582

Use the compiled JAR file and upload it as a package to your Control Room in Automation 360.

[Create a bot to test the custom package](#) on page 3583

Use the actions in Automation 360 to create a bot and test the custom package.

## Create a bot to test the custom package

Use the actions in Automation 360 to create a bot and test the custom package.

Ensure you have the following to build the bot:

- Access to the Control Room.
  - Credentials with **AAE\_Basic** permission or with a custom role to build a bot.
  - Your workstation is a registered device in the Control Room.
  - Your package **MetricToImperial-1.0.0.jar** is available in the Control Room.
1. Log in to the Control Room.
  2. On the left pane, click **Automation**.  
A list of available and forms is displayed.
  3. Click the **Create a bot** icon.
  4. In the **Name** field, enter `MetricToImperialTest`.
  5. Click **Create & Edit**.
  6. In the Actions pane, find **Metric to Imperial** and drag **Convert centimeters to inches** into the bot flow.
    - a) In the **CM to Convert** field, enter 1.
    - b) Click **Create variable** (next to the **Output** field) to create a new number variable.
    - c) In **Create Variable**, enter `nInchesOutput` and click **Create & Select**.
    - d) Click **Apply**.
  7. In the Actions pane, find the **Number** package and drag the **To String** command below **Convert centimeters to inches**.
    - a) In the **Enter a number** field, enter **F2** and select `nInchesOutput`.
    - b) In the **Enter number of digits after decimal** field, enter 5.

- c) In the **Assign the output to variable** field, select **prompt-assignment - String** from the drop-down list.
  - d) Click **Apply**.
8. From the Actions pane, drag **Message box**, click **F2** and insert the **prompt-assignment variable**.
  9. In the **Enter the message to display** field, click **F2** and select the **prompt-assignment variable**.
  10. Click **Apply** and **Save**.
  11. Click **Run**.  
The bot displays the 0.39370 message, which is a successful build.

Related concepts

[Build and test a custom package](#) on page 3575

Use IntelliJ to build a custom package and use Automation 360 actions to test the package.

Related tasks

[Build a custom package in IntelliJ](#) on page 3576

Use Java IntelliJ to create and compile a JAR file that you can upload as a package to your Control Room in Automation 360.

[Add custom package to your Control Room](#) on page 3582

Use the compiled JAR file and upload it as a package to your Control Room in Automation 360.

## Using Python to parse JSON response

Use the Automation 360 Python script to execute Python functions to build a bot. Use the Python functions to parse the JSON response from a REST Web Services GET request.

Ensure you have the following to build the bot:

- Basic understanding of Python programming language.
- Basic experience with creating Automation Anywhere bots.
- Download and install Python 3.

[download Python](#)

Do one of the following:

- While installing the Python, make sure to select **Add Python x.xx to PATH** during the Python installation.



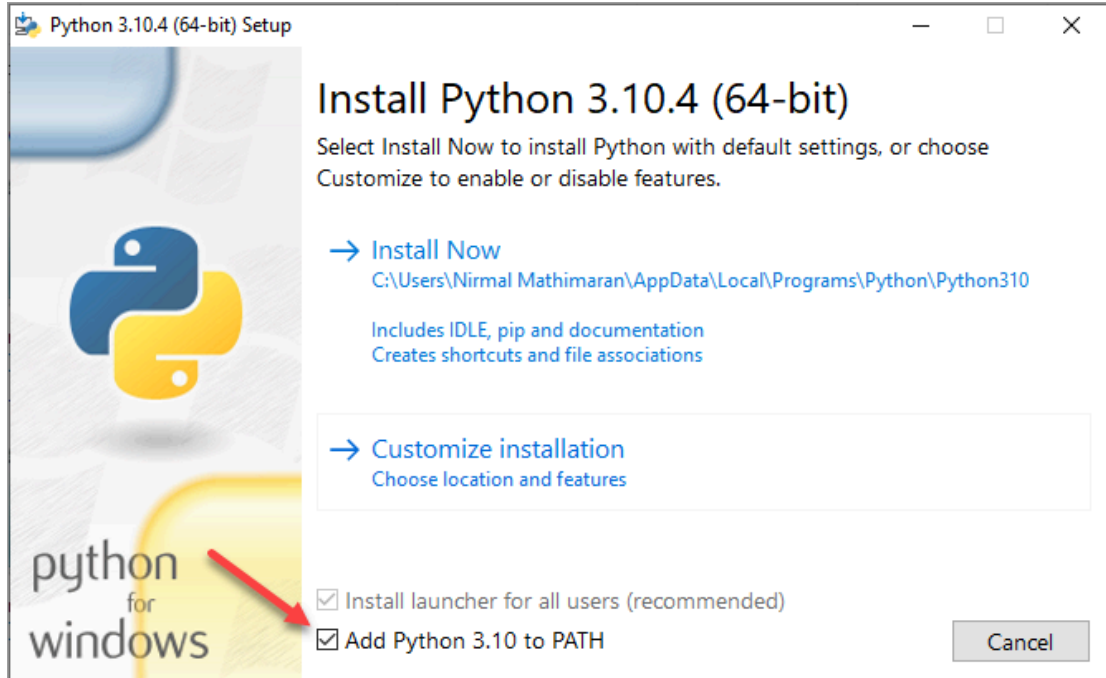

- Add a path to the Environment variable.

1. Log in to the Control Room.
2. On the left pane, click **Automation**.  
A list of available and forms is displayed.
3. Click **Create a bot** icon.

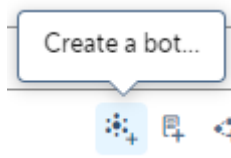

4. In the **Name** field, enter `PythonTutorial`.
5. Click **Create & Edit**.
6. In the Actions pane, click **Variables** to create the following new variables:
  - a) Name `dResponse`, **Type** > **Dictionary** and **Subtype** > **String**.
  - b) Name `dRetrieveValue`, **Type** > **Dictionary** and **Subtype** > **Any**.
  - c) Name `dResponseBody`, **Type** > **String**.
  - d) Name `sFullName`, **Type** > **String**.
  - e) Name `sLocation`, **Type** > **String**.
  - f) Name `sTotalUserCount`, **Type** > **String**.
  - g) Name `nTotalUserCount`, **Type** > **Number**.
  - h) Name `nCurrentUser`, **Type** > **Number**.
  - i) Name `sCurrentUser`, **Type** > **String**.

- j) Name prompt-assignment, **Type > String**.
7. From the Actions pane, select **REST Web Services > Get method** and place it under the **Start** of the bot flow.
- a) In the **URI** field, enter <https://randomuser.me/api/?results=5&inc=name,email,location&nat=us>.  
This is a sample API that returns random user details to the calling application.
- b) In the **Authentication Mode** drop-down list, select **No Authentication**.

The screenshot displays the Automation Anywhere interface. On the left, a bot flow is visible with six steps: 1. REST Web Services: Get meth... (highlighted with a red box), 2. String: Assign, 3. Python script: Open, 4. Python script: Execute function, 5. Dictionary: Put, and 6. String: To number. On the right, the configuration for the 'REST Web Services: Get method' action is shown. The 'URI' field is set to 'https://randomuser.me/api/?results=5&inc=na...', and the 'Authentication Mode' is set to 'No Authentication'. The 'Wait for action to complete' field is set to '60000'. The 'Assign the output to a variable' field is set to 'dResponse'. Callouts 'a', 'b', and 'c' point to the URI field, the Authentication Mode dropdown, and the output variable field, respectively.

**REST Web Services: Get method**

The GET method gets (reads) the information (in the form of an entity) that is identified by the Request URI.

Required bot agent version: 20.11 or above

URI

Enter the URI

a)

e.g. https://domainname.com/resource/search?param1=value1&param2=value2

Select credential as URI

Credential Variable

Pick...

Authentication Mode

b)

Header

Custom headers (optional)

Enabled	Name	Value
No headers		

Add header

Advanced options

Capture failure response

Allow insecure connection when using https

Warning: Transferred data may be visible to attackers

Wait for action to complete (in milliseconds)

# 60000

Increase this value if GET action times out

Assign the output to a variable

Multiple variables Dictionary

c)

Use response header name as key to fetch header value and 'Body' as key to fetch body of response

- c) In the **Assign the output to a variable** drop-down list, select **dResponse -Dictionary of Strings**.
8. From the Actions pane, click **String > Assign** action and drag it into the canvas below the **REST Web Services** action.
    - a) In the **Select the source string variable value** field, enter `$dResponse{Body}$`.

The screenshot displays the Automation Anywhere interface. On the left, the canvas shows a sequence of actions: a REST Web Services action, a 'String: Assign' action (labeled '2.') which is highlighted with a red box, and a 'Python script: Open' action (labeled '3.'). The 'String: Assign' action is configured with the source string variable value '\$dResponse{Body}\$' and the destination string variable 'dResponseBody'. On the right, the configuration pane for the 'String: Assign' action is shown. It includes a description: 'Assigns or concatenates the given strings' and 'Required bot agent version: 20.11 or above'. The 'Select the source string variable(s)/ value (optional)' field contains '\$dResponse{Body}\$' (labeled 'a'), and the 'Select the destination string variable' field contains 'dResponseBody' (labeled 'b').

- b) In the **Select the destination string variable** drop-down list, select **dResponseBody - String**.
9. From the Actions pane, click **Python script > Open** and drag it into the canvas below the **String > Assign** action.
    - a) In the **Python** field, select **Manual input**.

The screenshot displays the Automation Anywhere interface. On the left, a workflow is visible with steps: 1. request for URI "https://rando...", 2. String: Assign, 3. Python script: Open (highlighted with a red box and a callout 'a'), 4. Python script: Execute function "get\_node\_count" with param..., 5. Dictionary: Put, 6. String: To number, and 7. Loop (with a callout 'c').

On the right, the "Python script: Open" configuration panel is shown. It includes a "New Python session" dropdown set to "Default", a "Python" section with "Manual input" selected, and a "Enter script here" text area containing the following Python code (with callout 'b' pointing to the code):

```

1 import json
2
3 def get_node_count(response):
4     #parse response as json
5     response_dict=json.loads(response)
6     # Create list from JSON body
7     response_body = response_dict['results']
8     #return the count of entries in JSON body as
9     lengthasstring = str(len(response_body))
10    return lengthasstring
11
12 def get_full_name(dictRequest):
13     itemCount = int(dictRequest['count'])
14     #parse response as json
15     response_dict=json.loads(dictRequest['respons
16     # Create list from JSON body
17     response_body = response_dict['results']
18     #Extract values to return
19     return response_body[itemCount]['name']['firs
20
21 def get_location(dictRequest):
22     itemCount = int(dictRequest['count'])
23     #parse response as json
24     response_dict=json.loads(dictRequest['respons
25     # Create list from JSON body
26     response_body = response_dict['results']
27     #Extract values to return
28     return response_body[itemCount]['location']['

```

At the bottom of the panel, the "Python runtime version" is set to 3 (with callout 'c').

b) In the **Enter script here** field, copy and paste the following code.

```

import json

def get_node_count(response):
    #parse response as json
    response_dict=json.loads(response)
    # Create list from JSON body
    response_body = response_dict['results']
    #return the count of entries in JSON body as string
    lengthasstring = str(len(response_body))
    return lengthasstring

def get_full_name(dictRequest):

```

```

itemCount = int(dictRequest['count'])
#parse response as json
response_dict=json.loads(dictRequest['response'])
# Create list from JSON body
response_body = response_dict['results']
#Extract values to return
return response_body[itemCount]['name']['first'] + " " +
response_body[itemCount]['name']['last']

def get_location(dictRequest):
itemCount = int(dictRequest['count'])
#parse response as json
response_dict=json.loads(dictRequest['response'])
# Create list from JSON body
response_body = response_dict['results']
#Extract values to return
return response_body[itemCount]['location']['city'] + ", " +
response_body[itemCount]['location']['state']

```

- c) In the **Python runtime version** field, retain the default value as **3**.
10. From the Actions pane, click **Python script > Execute function** and drag it into the canvas below the **Python script > Open** action.
- a) In the **Python session** field, retain **Default**.
- b) In the **Enter the name of function to be executed** field, enter `get_node_count`.
- c) In the **Arguments to the function** drop-down list, select **dResponseBody - String**.

The screenshot shows the Automation Anywhere interface. On the left is the workflow canvas with three actions: 'Python script: Open', 'Python script: Execute function' (highlighted with a red box and labeled '4'), and 'Dictionary: Put'. On the right is the configuration pane for the 'Python script: Execute function' action. The configuration includes:

- Python session:** Default (labeled 'a')
- Enter name of function to be executed:** get\_node\_count (labeled 'b')
- Arguments to the function (optional):** dResponseBody (labeled 'c')
- Assign the output to variable (optional):** sTotalUserCount (labeled 'd')

- d) In the **Assign the output to a variable** drop-down list, select **sTotalUserCount - String**.
11. From the Actions pane, click **Dictionary > Put** and drag it into the canvas below the **Python script > Open** action.
- a) In the **Dictionary variable** field, select **dRetrieveValue -Dictionary**.
- b) In the **Associate to this key** field, enter `response`.

- c) In the **New value** drop-down list, select **dResponseBody - String**.
- d) In the **Assign previous value to a variable** drop-down list, select **prompt-assignment - String**.

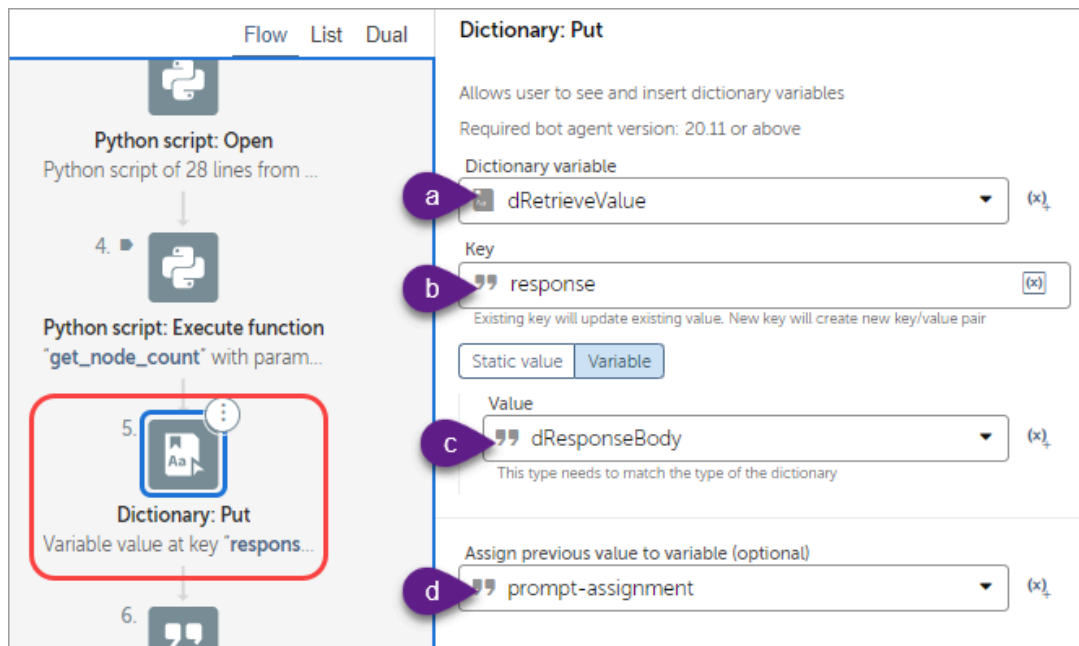

12. From the Actions pane, click **String** > **To number** and drag it into the canvas below the **Dictionary** > **Put** action.
- a) In the **Enter the string** field, enter `$$TotalUserCount$`.
  - b) In the **Assign the output to a variable** drop-down list, select **nTotalUserCount - Number**.

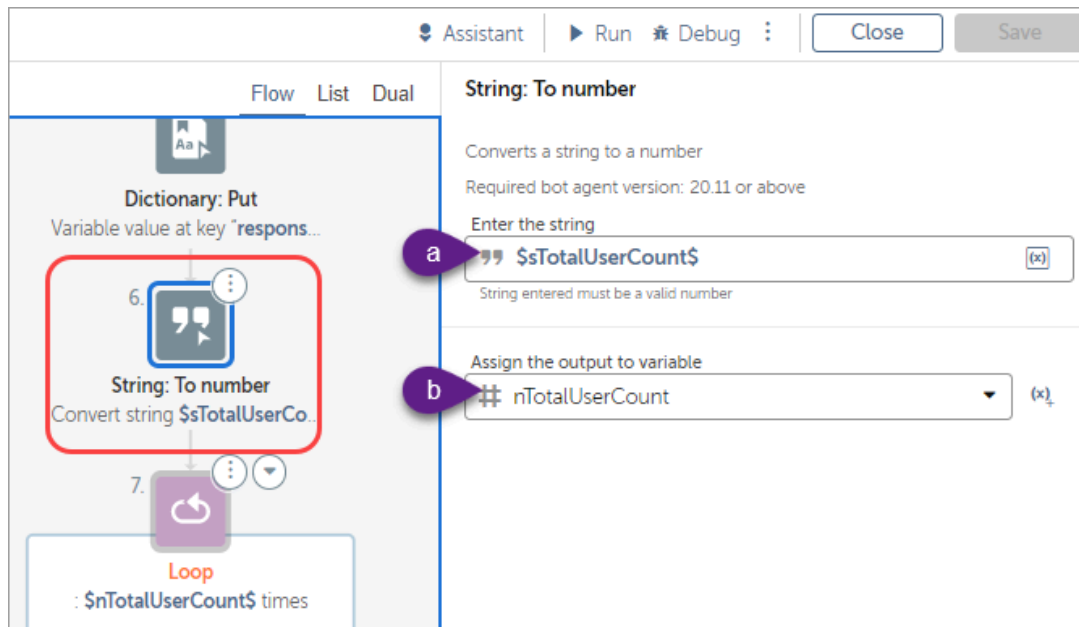

13. From the Actions pane, click **Loop** > **Loop**.

- a) In the **Loop Type > Iterator**, select **For n times** from the drop-down list.
- b) In the **times** field, enter `$nTotalUserCount$`.
- c) In the **Assign the current value to a variable** drop-down list, select **nCurrentUser - Number**.

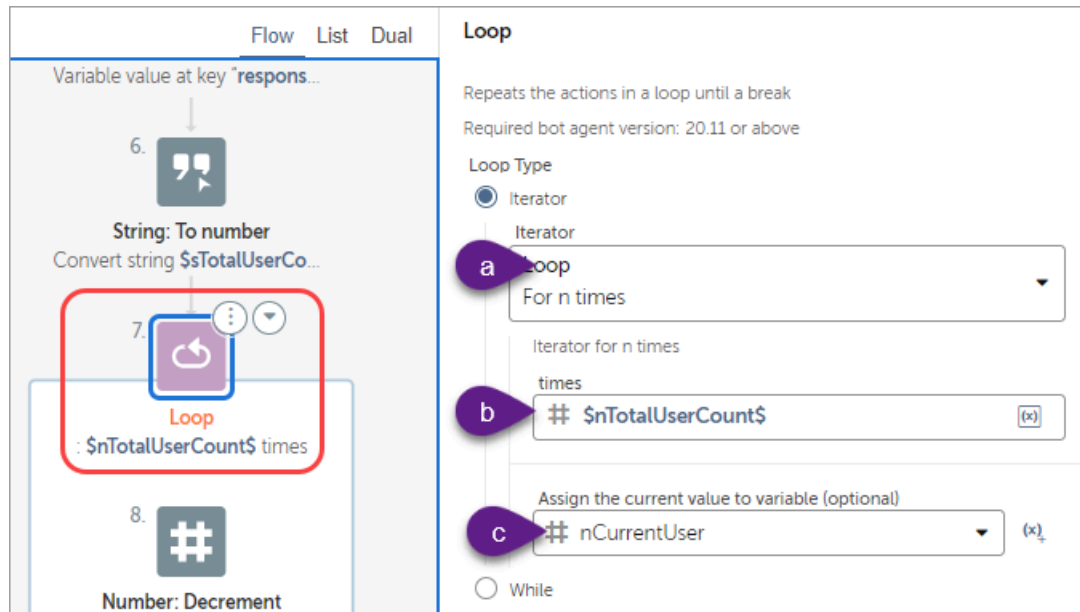

14. From the Actions pane, click **Number**, select **Decrement** and place it inside the **Loop** action.
  - a) In the **Enter number** field, enter `$nCurrentUser$`.
  - b) In the **Enter decrement value** field, enter 1.
  - c) In the **Assign output to a variable** drop-down list, select **nCurrentUser - Number**.

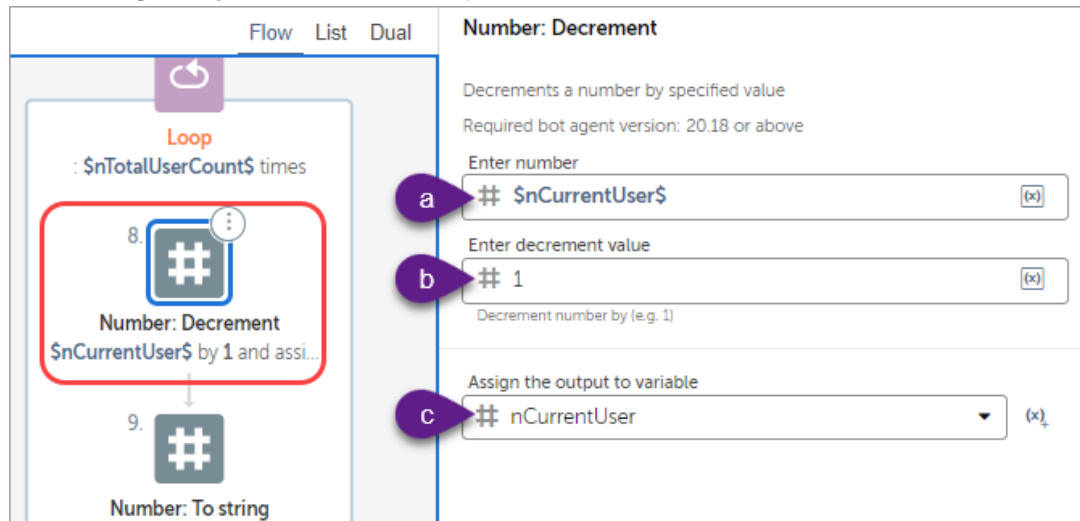

15. From the Actions pane, click **Number**, select **To string** and place it inside of the **Loop** action, below **Number > Decrement**.
  - a) In the **Enter a number** field, enter `$nCurrentUser$`.
  - b) In the **Enter number of digits after decimal** field, enter 0.

- c) In the **Assign output to a variable** drop-down list, select **sCurrentUser - String**.

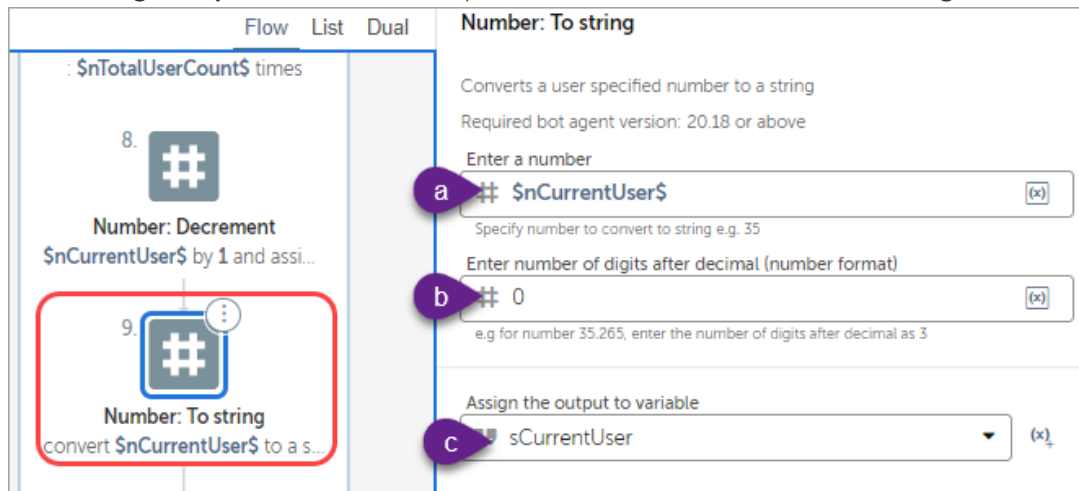

16. From the Action pane, click **Dictionary > Put** and place it inside of the **Loop** action.

- In the **Dictionary variable** field, select **dRetrieveValue -Dictionary**.
- In the **Associate to this key** field, enter count.
- In the **New value** drop-down list, select **sCurrentUser - String**.
- In the **Assign previous value to a variable** drop-down list, select **prompt-assignment - String**.

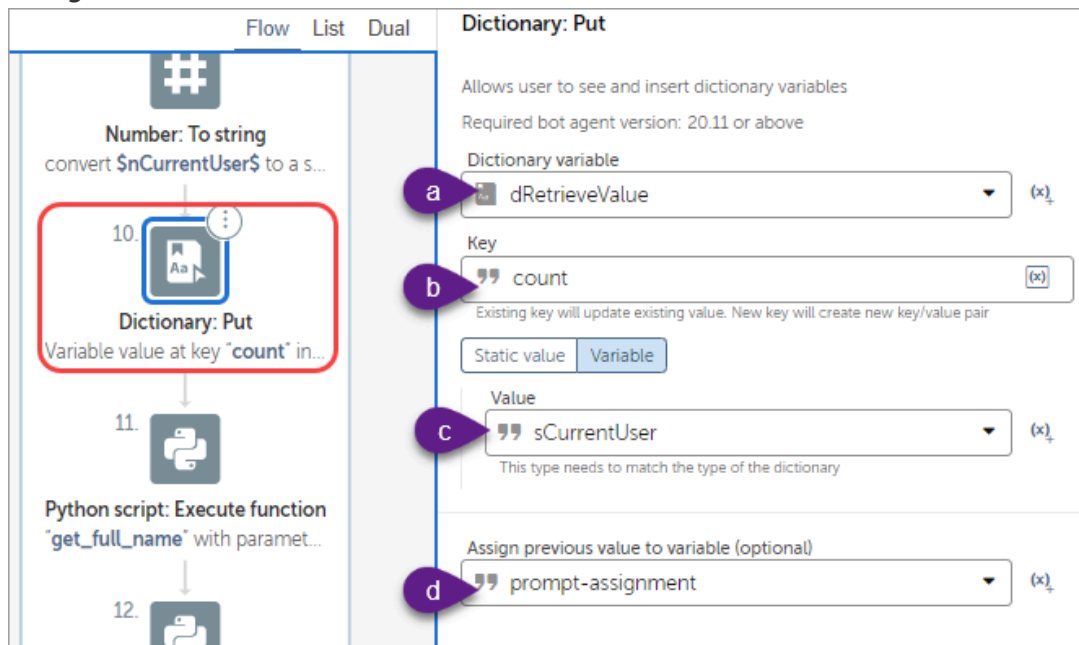

17. From the Actions pane, click **Python script > Execute function** and place it inside of the **Loop** action.

- In the **Python session** field, retain **Default**.
- In the **Enter the name of function to be executed** field, enter `get_full_name`.
- In the **Arguments to the function** drop-down list, select **dRetrieveValue - Dictionary**.



- d) In the **Assign the output to a variable** drop-down list, select **sFullName - String**.

The screenshot displays the configuration for a Python script action. The flowchart on the left shows a sequence of actions: **Dictionary: Put** (Variable value at key "count" in...), **Python script: Execute function "get\_full\_name" with paramet...** (step 11), and **Python script: Execute function "get\_location" with parameter...** (step 12). The configuration pane on the right is titled **Python script: Execute function** and includes the following fields:

- Python session:** Default (a)
- Enter name of function to be executed:** get\_full\_name (b)
- Arguments to the function (optional):** dRetrieveValue (c)
- Assign the output to variable (optional):** sFullName (d)

18. From the Actions pane, click **Python script > Execute function** and place it inside of the **Loop** action.

- In the **Python session** field, retain **Default**.
- In the **Enter the name of function to be executed** field, enter `get_location`.
- In the **Arguments to the function** drop-down list, select **dRetrieveValue - Dictionary**.
- In the **Assign the output to a variable** drop-down list, select **sLocation - String**.

The screenshot displays the configuration for a Python script action. The flowchart on the left shows a sequence of actions: **Python script: Execute function "get\_full\_name" with paramet...** (step 11), **Python script: Execute function "get\_location" with parameter...** (step 12), and **Message box "Full Name: \$sFullName\$ Loc...** (step 13). The configuration pane on the right is titled **Python script: Execute function** and includes the following fields:

- Python session:** Default (a)
- Enter name of function to be executed:** get\_location (b)
- Arguments to the function (optional):** dRetrieveValue (c)
- Assign the output to variable (optional):** sLocation (d)

19. From the Actions pane, click **Message box** and place it inside of the **Loop** action.

- a) In the **Enter the message to display** field, enter the following:

```
Full Name: $sFullName$ Location: $sLocation$
```

- b) Select **Close message box after** > **Seconds**, enter 5.

The screenshot shows the configuration for a 'Message box' action. The left pane displays a flow with a Python script action followed by a 'Message box' action (step 13). The right pane shows the configuration for the 'Message box' action, including the window title, the message to display, and the scrollbar settings. Callouts 'a', 'b', and 'c' point to the window title, message to display, and scrollbar settings respectively.

20. From the Actions pane, click **Python script** > **Close** and place it outside of the **Loop** action.

- a) In the **Python session** field, retain **Default**.

The screenshot shows the configuration for a 'Python script: Close' action. The left pane displays a flow with a 'Python script: Close' action (step 14) and an 'End' action. The right pane shows the configuration for the 'Python script: Close' action, including the Python session name. Callout 'a' points to the Python session field.

21. Click **Save** to save your bot, and then click **Run**.

The bot runs, displaying five full user names with locations for approximately 5 seconds each before completing its successful execution.

If you get a Bot **Error** message, see the following sections for a solution: [Getting Bot Error while executing Python Script/Function \(A-People login required\)](#), [Getting Bot Error or True value in message box while executing Python Script \(A-People login required\)](#), or [An unexpected error occurred while executing Python Script command; Error code: bot.execution.error \(A-People login required\)](#).

## Use JavaScript to build a bot to take user input

Use the JavaScript actions Automation 360 to execute JavaScript functions to build a bot. Use the actions to create a bot that takes user input and provides the appropriate output.

Ensure you have the following to build the bot:

- Basic understanding of JavaScript programming language.
  - Basic experience with creating Automation Anywhere bots.
1. Log in to the Control Room.
  2. On the left pane, click **Automation**.  
A list of available and forms is displayed.
  3. Click **Create a bot** icon.
  4. In the **Name** field, enter `Hello User`.
  5. Click **Create & Edit**.
  6. In the Actions pane, click **Variables** to create the following new variables:
    - a) Name `lInputList`, **Type** > **List** and **Subtype** > **String**.
    - b) Name `sInputName`, **Type** > **String**.
    - c) Name `sOutput`, **Type** > **String**.
  7. From the Actions pane, click **Prompt** > **For value**:
    - a) In the **Prompt window capture** field, enter `Enter your name here`.
    - b) In the **Prompt message** field, enter `Please enter your name here`.
    - c) In the **Assign the output to a variable** drop-down list, select **sInputName - String**.
  8. From the Actions pane, click **List** > **Add item**:
    - a) In the **List variable** drop-down list, select **lInputList - List**.
    - b) In the **Item to be added** drop-down list, select **sInputName - String**.
    - c) In the **Add item** field, select **To end of list**.
  9. Create a new JavaScript file.
    - a) Open a notepad, and copy and paste the following code:

```
function response(str) {
  return "Hello "+ str
}
```
    - b) Save the file in your desktop as `Salutation.js`, and select **Save as type:** as **All Files**.
  10. From the Actions pane, click **JavaScript** > **Open**:
    - a) In the **JavaScript session** field, leave as **Default**.
    - b) In **JavaScript** > **Import existing file**, for the **JavaScript file** field, select **Desktop file**.
    - c) Click **Browse** and select the `Salutation.js` file from your desktop or where you saved the file.

- d) In the **Assign the output to a variable** drop-down list, select **sOutput - String**.
11. From the Actions pane, click **JavaScript > Run JavaScript**:
  - a) In the **Enter name of the function to be executed** field, enter `response`.
  - b) In the **Parameters** drop-down list, select **InputList - List**.
12. From the Actions pane, click **Message box**:
  - a) In the **Enter the message to display** field, enter `$sOutput$`.
13. Click **Save** to save your bot, and then click **Run**.
14. When the bot prompts to enter a name, enter the name and click **OK**.  
A message from the bot appears: `Hello <User>`.

## Bot developer recommendations

Automation Anywhere provides a flexible platform for bot and package development. The information in this topic provide guidelines and recommendations on how to structure and develop robust and reusable bots and packages.

### Bot Store submissions checklist

Use the checklist to ensure that your Automation 360 Bot Store submission is correctly created, processed, and accepted. If you do not follow requirements listed in the checklist, your submission will be rejected and will not be published on the Bot Store page.

Use this checklist from the developer portal: [Automation 360 bot submission checklist](#).

### Building reusable bots

Review the guidelines to gain a better understanding of how to develop bots or subtasks for reusability, from designing and creating through reusing.

Define prerequisites, input, output, and variables

When you build bots for reusability, define the following:

- Document all necessary prerequisites on how to use your bot either on its own or as a subtask.
- When creating your bots, define values as input, output, or local. Input and output variables are used when your bot is designed to be used as a subtask, allowing it to receive and pass back values to or from another calling bot.
- Provide meaningful variable descriptions when defining input and output variables so that other developers know how to interact with your subtask.

- Adhere to an established standard for variable naming guidelines. Review the Automation Anywhere user-defined variables for variable naming guidelines. [Your variables \(user-defined\)](#) on page 2331

#### Follow single-responsibility principle

Bots developed for reusability should follow the single - responsibility principle which states that each subtask or component should have responsibility over a single part of the functionality of the overall bot and that responsibility should be entirely encapsulated by that subtask or component.

Other examples of single-responsibility:

- A subtask that processes a single transaction, but can be called multiple times for each transaction on a list.
- A subtask that collects screen display data on a single page of a website, but can be called multiple times as a bot goes through pagination.

#### Bot design considerations

Consider the following patterns based on which templates must be developed for use:

##### 1. Primary, Main, and Sub bots

- Primary bot: This bot is called directly to begin the process, through mechanisms including scheduling through the Control Room or API call. Include the following major process steps in the **TRY** section:
  - a) Initial setup for the process.
  - b) Validation that the setup was successful. For example, check whether all required files and folders exist or initial variable values are populated as required.
  - c) Run the desktop **PRE-PROCESS CLEANUP**.
  - d) Call the main bot to run the business logic of the process.

In the **FINALLY** section, run the desktop **POST-PROCESS CLEANUP**.

- Main bot: This bot calls the sub bots as required to run the business logic of the process. Include the following major process steps in the **TRY** section:

- a) Validation of any input. For example, input variable values from the primary bot.
- b) Execution of sub bots.
- c) Validation of any output.
- d) Ensure population of any output variable values based on the execution of main bot, to return to the primary bot.

In the **CATCH** section, log the error, and ensure population of any output variable values, for example, **oStrResult** to pass back to the primary bot.

- Sub bots
  - A sub bot is called by the primary bot or main bot to run the actual business logic required for the automation. They are also referred to as helper tasks or utility tasks because their only purpose is to assist the calling task.
  - Use output variables to return a result indicator to the calling bot either main, or another sub bot. For example, **outStrResult**. The value contains an error message if the processing was not successful due to an error or exception that had occurred.

2. Main and Sub bots: This pattern includes the primary and the main bot in a single main bot. The design pattern of the Sub bot is similar to the design pattern explained above.

## Opening and closing applications

Any applications, files, or windows that a bot or subtask opens must be closed by the same bot or subtask.

- For example, when a bot opens Microsoft Excel to perform a spreadsheet operation, verify that the spreadsheet and Excel are closed when the bot finishes processing.
- Close applications when the bot execution is successful or unsuccessful.
- Use the **Finally** block of the **Try/Catch/Finally** operation to ensure applications

are closed regardless of success of the task processing.

- In the case that applications do not respond during testing, consider using the command prompt to forcefully close (kill) the applications. For example, to forcefully close power point, the command-line operation would be:

```
Taskkill /IM powerpnt.exe /F
```

## Error handling

After completing the task, verify that the bot successfully handles any failure or exceptions.

- Each task or subtask must handle its own errors.
- An unhandled exception in a subtask can cause issues in a parent task.
- Use **Try/Catch/Finally** blocks at the root level of every bot.
- Use **Try/Catch** blocks inside of a loop if you want to try an operation multiple times before reporting a failure.

## Event or exception handling

Other than action errors that are captured by **Try/Catch**, you must perform code checks for other processes such as events or exceptions. If a certain process condition occurs, notify or log these conditions for additional analysis.

- Develop a configurable event handler Task Bot that minimizes the requirement for code changes if the actions change. For example, maintain an XML file that contains a definition of all the possible events or exceptions and any notification requirements when those events or exceptions occur.
- In the code, when such events or exceptions occur, write the information to an event log. You can also add memory usages and capture a screenshot.
- Run the event handler Task Bot to process the event or exception. For example, issue a notification using parameters such as email recipient, CC recipient, or subject from the XML file.
- If the notification requirements vary for each environment, or change over time, the configuration file can be updated without having to change the code.

### Running bots on other computers

When designing a bot, enable it so it runs on computers other than the computer on which a bot was created.

- Use variables for local file paths, network shares, or window titles so that your bot can successfully run from other machines.
- Consider using global values for environment markers or network shares that multiple bots need access to.
- Use wildcard characters for window titles where appropriate to enable bots to run regardless of specific environment or version of the target application. For example, instead of using

```
Salesforce - Professional  
Edition - Internet Explorer
```

use the following:

```
Salesforce - * - Internet  
Explorer
```

### Using prompts, message boxes, and infinite loops

Prompts and message box actions stop the bots from running when waiting for a user input. Unless a user input is required, design the bots without using prompt statements.

- When using loops, ensure all loops have a definite end by clearly defining their number of iterations or specifying where break loop actions need to exist.
- If your bot is intended to run as an unattended bot, remove or disable any prompts or message box actions.
- If you are building bots for an attended automation scenario, message boxes and prompts are often reasonable or required for bots to run as expected. Use message boxes to display different variables, such as, responses, outputs, or values.

### Storing sensitive data in the Credential Vault

The Control Room includes the Credential Vault that can be used to store sensitive information, such as user names, passwords, API keys, and tokens.

- When building a bot, create a locker in the Control Room using the Credential Vault to store credentials and retrieve them as required by referencing the credential and the attribute. This allows users to create



bots that consume APIs or perform logins without the need for bot builders to directly hard-code the required credentials within a bot.

- Do not hard-code sensitive credentials into a bot, or a subtask, because hard-coded storage in a bot introduces a security risk.
- When Credential Vault values are required to be used in a bot, verify that all locker names and credentials are clearly defined in the bot documentation. If required, include details on how to obtain credentials, for example, an API key or a token.

#### Testing independent tasks

When creating bots for reusability, design them in a way that they can be tested independently of other subtasks.

- Practice the test-driven development (TDD) approach: When adding a new bot, or a new feature in an application, write a test case for it.
- In a test case, define the specific function that validates that feature or functionality.
- For single-responsibility principle and reusability, create many smaller tasks that can be tested independently.

#### Using comments and steps

Comments enable developers to provide descriptions within their bots so that other bot developers can better understand what each section, block of code, or subtask is designed for. Include clear comments to allow developers to understand the purpose of the function of a given code block.

- When bots are submitted to the Bot Store, commenting demonstrates how to customize the bot.
- Using comments makes code maintenance easier because section descriptions help identify where changes might be required to enable developers to work towards quicker issue resolution
- Comments on bots that are a work in progress can be helpful when creating placeholders for future work. Consider using a TODO command as a reminder to add logic to the bot, but update the comments when the work is completed.
- Automation 360 includes the Step action, which provides the capability to organize

the code into logical groupings to improve readability and the flow.

- Create an outline of the major objectives of your bot by using empty, labeled step actions. When that is completed, go back to each step and complete the logic for the step.

## Creating logging files

Identifying problems without logs can be difficult when bots are running unattended on any number of Bot Runners. Software developers, support teams, and bot owners rely on logs to understand where their automations have issues and how to diagnose problems. Bots must log errors to get error details.

- Use error handling and screen captures to better understand when a bot or subtask encounters an error.
- Use the A2019 Bot Store template that contains basic error handling, logging, and snapshot capabilities with the customizable root logging location for maintaining older log files.

### [Bot Store bot template](#)

- If required, create additional logging files and include a full audit history of everything a bot or subtask has done. The additional log files can include audit, debug, and performance information about the bot, as well as the following:
  - Main bot start and end time.
  - Subtask start and end time.
  - The completion time of specific milestones defined within the bot.
  - Number of transactions received in an input file.
  - Number of successfully processed or failed transactions.

---

**See also:** [Best practices: Building reusable and secure Automation 360 bots and packages](#)

---

### Related tasks

[Using Loop action](#) on page 2794

Use the Loop action to repeatedly run a sequence of actions for a specific number of times or until a condition is met.

### Related reference

[Your variables \(user-defined\)](#) on page 2331

Users and some actions create user-defined variables to temporarily hold values. Use this kind of variable to input values into an action (window title, login credential, or file path) or to accept the output of an action (values read from a file or a Boolean return).

[Application package](#) on page 2428

Use the `Open Program/File` action in the `Application` package to launch an application or a file. This action supports `.exe`, `.bat`, script files, or shortcut paths.

[Error handler package](#) on page 2552

If a bot encounters an error due to an abnormal condition or exceptions during execution, the normal execution of the bot is hindered, and the bot fails to complete the task. The Error handler package contains actions that enable you to easily handle exceptions a bot encounters and transfers control to the other actions within that bot.

[Step package](#) on page 3085

The `Step` package groups various actions together and runs them in a specific order. You can provide a relevant name for a step to identify the operation performed by the actions included in that step.

[Prompt package](#) on page 2905

Use the `Prompt` package to accept an input value, a yes/no response, or to open a file or folder.

[Message box package](#) on page 2796

Use the **Message box** action from the **Message box** package to insert a message box that shows a message when the task runs. For example, you can insert a **Message Box** action to follow a web form so that the action displays the message: `Web Form Filled and Complete`.

## Building reusable packages

Review the guidelines to understand how to build packages for reusability.

Know your incoming data

When setting fields that your action package requires from the user, provide specifics in setting the attribute type to limit the kinds of data that your package receives.

- Limit the input to reduce the burden of checks that have to be done when the package is received.
- Javadoc includes 34 defined attribute types, so review those when you build your package to select the appropriate field types.
- Set your package so that it takes a stored value. For example, on behalf of the bot, your package is making API calls, verify that the `AttributeType` of the action input field for the API key or a token is set to `credential`. This way users are encouraged to use a value stored in the Credential Vault for sensitive input data that the package requires.

Use labels appropriately

In the `CommandPkg` annotation, use different labels, `node_labels`, and descriptions appropriately.

- Use these labels as short descriptions of your action and use only a few words to describe an action.
- Replicate the same naming style as it is presented in the default Action packages.
- Each action is a child element of a package, and the action label is displayed along with the package icon in the Actions pane. Use short names to describe each action.
- Document an expected input format for certain fields. Use the parameter description for the @Pkg annotation. This allows package developers to review the format, requirement, or data that must be used for a specific input field. For example:

```
@Pkg(label = "Start Date",  
      description="Date Format as  
      MM/DD/YYYY")
```

### Unit test your components

During the package development, create unit tests to validate that each component and the action of the package is working as expected.

- Validate the behavior of the individual test unit, a single class, or a single action, to ensure that it is functioning as expected.
- Review and document any feature or functionality defects at early stages of the development process.

### Handling errors

Include the error handling in the bot logic to ensure that all errors are handled gracefully. If an error is not handled, it could prevent a bot runner from executing other tasks.

- Create meaningful error messages that can help bot consumers with error resolutions.
- As a package developer, keep in mind these recommendations:
  - Use **Try/Catch** block to accommodate for an error.
  - Use a multi-catch block to find specific errors, and use the **BotCommandException** to return customized error messages. For example:

```
//create array of 3 items  
int[] myIntArray = new int[]  
{1, 0, 7};  
try {  
    //print 4th item in array
```

```
System.out.println(myIntArray[3]);
//Perform operation on
first and second items in
array
    int result =
myIntArray[0] /
myIntArray[1];
} catch
(ArrayIndexOutOfBoundsException) {
    //Throw custom message
for IndexOutOfBounds
    throw new
BotCommandException("The
array does have the number
of expected items.");
} catch (ArithmeticException
e) {
    //Throw custom message on
Arithmetic Exception
    throw new
BotCommandException("Math
Operation Error with " +
Integer.toString(myIntArray[0])
+ " and " +
Integer.toString(myIntArray[1]));
}
```

Follow single-responsibility principle

A package is a collection of actions. Each action within a package must have a single responsibility and that responsibility must be encapsulated by that action.

- Following the single-responsibility principle helps your package consumers to implement it easily, simplifies testing, and avoids unnecessary modifications.
- The actions that you offer allow package consumers to customize the way they use your package within their bots, and can help their bots be as efficient as possible.

Provide examples

When submitting packages to the Bot Store include a demo bot that demonstrates the use of the package.

- Use the Automation 360 actions and allow package consumers to use these actions to expend their bot capabilities.
- Always provide sample bots with descriptions to help your package consumers with the knowledge they require to understand its proper use.

**See also:** [Best practices: Building reusable and secure Automation 360 bots and packages](#)

---

Related reference

[Building reusable bots](#) on page 3596

Review the guidelines to gain a better understanding of how to develop bots or subtasks for reusability, from designing and creating through reusing.

## Troubleshooting and debugging

Troubleshooting and debugging information.

### Troubleshoot bot run issue

Issue: I'm unable to deploy a bot because I get the following – Unexpected error setting up a new user session.

Cause:

Most often, this error is caused by invalid device credentials.

Solution:

Confirm the device is registered and connected.

1. Select **Manage > Devices** from the Control Room.
2. Confirm that the Status column shows **Connected** for the relevant device.

Confirm that the device username and password are correct.

1. Select your profile on the left pane and select **My Settings > My profile**.
2. Verify the device username.

Depending on how the device is configured within the network, you might need to prepend it with the domain name. For example, domainname \firstname.lastname.

3. Verify the device password.

### Other resources

- [Could not deploy due to one of the following issues–User is already running a bot on device \(A-People login required\)](#)
- [A360| Run bot pre processing failed \(A-People login required\)](#)
- [Automation 360 Device error while running a bot \(A-People login required\)](#)

## Bot Agent log files

Various types of information about the Bot Agent are captured in different log files. You can analyze these log files when the Bot Agent or a bot encounters an error and identify the root cause for that error.

### Overview

The Bot Agent log files enable you to perform these actions:

- Determine whether a bot ran successfully
- Identify issues that resulted in a bot failure
- Determine if the device is properly connected with the Control Room

### Log file locations

The Bot Agent log files are available at `C:\ProgramData\AutomationAnywhere\BotRunner\Logs` on your device. The following files are available at this location:

Bot_Launcher	Captures information about the execution of a bot such as the operations performed, events triggered, and errors encountered by the bot. The filename now includes the name of the user running the bot on the Bot Runner. For a multi-user session machine, there will be a bot launcher log per user.
Node_Manager	Captures information about when a bot is run from the Control Room and communication details between a Bot Runner and the Control Room.

### Log file configuration

To configure the different types of log files that can be collected from the devices connected to the Control Room, see [Configure log collection](#) on page 1800.

## Bot Store

You can access Bot Store from the Control Room. From Bot Store, you can download bots or packages to your Control Room repository.

There are two ways for you to get bots and packages from Bot Store into your Control Room:

- You can load items directly from Bot Store to your Control Room, without needing to download the items locally. For details, see [Directly import bots and packages from Bot Store to Control Room](#) on page 3610.

- You can download items from Bot Store locally, then import them to your Control Room, even if your Control Room is not connected to the internet. For details, see [Download locally and import bots and packages from Bot Store to Control Room](#) on page 3611.

---

**Resources:** To learn more, see [Automation Anywhere Bot Store Learning Trail \(A-People login required\)](#).

---

Related concepts

[Bot permissions for a role](#) on page 1763

Assign bot permissions when creating a role with the View my bots feature permission.

## Access Bot Store from the Control Room

As a Bot Store registered user, you can log in to Bot Store from the Control Room.

You must have valid Bot Store credentials to access Bot Store from the Control Room. If you do not have valid Bot Store credentials, you must register with Bot Store.

1. Log in to the Control Room.
2. Click the **Bot Store** tab.  
Bot Store opens in a separate window (<https://botstore.automationanywhere.com>).
3. Log in using your Bot Store credentials.

In the Control Room, you can see **My downloads** under the **Bot Store** tab.

Watch the following video on how to find bots on Bot Store.

Related concepts

[Bot Store](#) on page 3607

You can access Bot Store from the Control Room. From Bot Store, you can download bots or packages to your Control Room repository.

Related tasks

[Submit bots or packages to Bot Store](#) on page 3608

You can submit bots or packages from the Control Room to Bot Store. If your bot includes dependencies, submit all dependencies. Submit a demo bot that demonstrates the use of the package.

[Directly import bots and packages from Bot Store to Control Room](#) on page 3610

You can load items directly from Bot Store to your Control Room without the need to download the items locally.

## Submit bots or packages to Bot Store

You can submit bots or packages from the Control Room to Bot Store. If your bot includes dependencies, submit all dependencies. Submit a demo bot that demonstrates the use of the package.

You must have a system-created **AAE\_Bot Store Publisher** role in order to submit bots or packages to Bot Store. See [System roles](#) on page 1768.

1. Download the A2019 Bot Store Bot template from GitHub: [A2019 Bot Store Bot Template](#).
2. Log in to the Control Room.



3. Log in to Bot Store using the Bot Store credentials.
4. On the left pane, click **Automation**.  
A list of available and forms is displayed.
5. Click **Public** workspace and select the **Bot Store** folder.
6. In the **Automation** page, move your mouse over the **Action** toolbar and click **Submit to Bot Store**.
  - a) In the **Submit to Bot Store** page, review the dependencies that will be bundled with your bot (including a parent bot) and make changes as required. In addition, ensure that the bot and all dependent bots and files are in the same folder to submit to Bot Store.
  - b) Click **Next** to review the **Bundled packages** to ensure all packages are included with your submission.
  - c) If the bot you want to submit and the bundled package look complete, click **Submit**.  
When choosing a name for your bot or package, ensure it is unique and descriptive so it is easily searchable on Bot Store.  
Alternatively, click **Back** to go back.  
When you submit your files, the system displays the following message: <bot/package name> submission is in progress. Go to Bot Store > My Submissions to complete your submission form. You will receive a confirmation email when the submission is completed.
  - d) Click **Take me to Bot Store** to complete your submission form in Bot Store.

When you resubmit files to Bot Store, it overwrites the previously submitted files, which are in a Draft status.

- It can takes three to five business days for review and approval of your bot or package.
- For any questions on bot and package submissions, contact [Contact Bot Store Support](#) or select the **Have questions about submitting a bot** option on Bot Store pages.

Related concepts

[Bot Store](#) on page 3607

You can access Bot Store from the Control Room. From Bot Store, you can download bots or packages to your Control Room repository.

Related tasks

[Access Bot Store from the Control Room](#) on page 3608

As a Bot Store registered user, you can log in to Bot Store from the Control Room.

[Directly import bots and packages from Bot Store to Control Room](#) on page 3610

You can load items directly from Bot Store to your Control Room without the need to download the items locally.

## Directly import bots and packages from Bot Store to Control Room

You can load items directly from Bot Store to your Control Room without the need to download the items locally.

You must have a system-created **AAE\_Bot Developer** role in order to download bots or packages to your Control Room repository. See [System roles](#) on page 1768.

1. Navigate to Bot Store site.
2. Log in with your A-People credentials to download from Bot Store.
3. Select a bot or package.  
Once you have selected your bot, you are redirected to a detailed bot page.
4. Click the **Get Bot** button.  
A confirmation window prompts you to confirm the request.
5. Click **Ok, Get Bot** to confirm the request.  
You can choose from the **Add to Control Room** or **Download as a zip file** options.
  - The **Add to Control Room** option requires you to specify your Control Room URL.
  - The **Download as a zip file** option requires you to save the bot locally on your device and confirm the location path for your download to begin.
6. Select the **Add to Control Room** option to load the bot directly to your Control Room.
7. Enter your Control Room URL.
8. Log in to the Control Room.
9. Navigate to the **Automation** page.
10. Open your **Bot Store** tab.
11. Click **Add to RPA Workspace** in the **Action** toolbar.  
The following message appears: `If you have any files already installed in private workspace, they will be overwritten.`
12. Select **Yes, continue** to overwrite an existing file and continue with the installation, or select **No, cancel** to cancel your download.  
The installation status of the selected file changes to `Installed`.
13. Verify the downloaded bots in your Bot Store folder of the private workspace.  
The custom packages downloaded from Bot Store are available in the **Packages** repository. You can navigate **Bot Editor > Action Palette**.
14. Verify that the downloaded packages have been enabled in the **Packages** repository. If the packages are not enabled, then go to individual packages and enable them.

Related concepts

[Bot Store](#) on page 3607

You can access Bot Store from the Control Room. From Bot Store, you can download bots or packages to your Control Room repository.

Related tasks

[Access Bot Store from the Control Room](#) on page 3608

As a Bot Store registered user, you can log in to Bot Store from the Control Room.

[Submit bots or packages to Bot Store](#) on page 3608

You can submit bots or packages from the Control Room to Bot Store. If your bot includes dependencies, submit all dependencies. Submit a demo bot that demonstrates the use of the package.

## Download locally and import bots and packages from Bot Store to Control Room

You can download items from Bot Store locally then import them to your Control Room, even if your Control Room is not connected to the internet.

You must have a system-created **AAE\_Bot Developer** role in order to download bots or packages to your Control Room repository. See [System roles](#) on page 1768.

1. Navigate to Bot Store site.
2. Log in with your A-People credentials to download from Bot Store.
3. Select a bot or package.  
Once you have selected your bot, you are redirected to a detailed bot page.
4. Click the **Get Bot** button.  
A confirmation window prompts you to confirm the request.
5. Click **Ok, Get Bot** to confirm the request.  
You can choose from the **Add to Control Room** or **Download as a zip file** options.
  - The **Add to Control Room** option requires you to specify your Control Room URL.
  - The **Download as a zip file** option requires you to save the bot locally on your device and confirm the location path for your download to begin.
6. Select the **Download as a zip file** option  
You can save the bot locally on your device and when you confirmed the location path, your download begins.
7. Log in to the Control Room.
8. Navigate to the **Automation** page.
9. Click **Import bots**.
10. Click **Browse**.
11. Select your downloaded zip file at the location path you saved.
12. Specify the option to have your bot in the **Public** or **Private** tab.
13. Click **Import** to import the downloaded bot.
14. Navigate to the **Public** or **Private** tab that you specified.
15. Open your **Bot Store** folder.
16. Access the bot.  
You can now use the bot from Bot Store to start your automation experience.  
To use a Bot Store package, open the bot you want to edit and access package from the Actions panel.

---

**Note:** For users who want proxy access to Bot Store, you can reference this knowledge base [article](#) for a workaround.

---

## Private Bot Store

Private Bot Store is a secure internal bot marketplace for a company to post and share details and documentation for all internally developed bots. Employees can easily discover internal bots and commands to reuse in addition to all of the bots from the Automation Anywhere Bot Store vendors.

Use Private Bot Store to perform the following tasks:

- View, access, and reuse bots to automate processes:
  - Find and reuse bots built by your team
  - Use filters to search for bots by applications, business processes, or a keyword
  - Use bots from the Automation Anywhere Bot Store vendors
  - Review detailed documentation provided with each bot to decide whether to use the bot
- Submit details and documentation about your own bots
- Use the **Suggested bot idea** page to submit a bot idea

Use bots within your company:

- If required, email a bot developer for bot installation assistance
- Review and access bots in your Control Room

Use admin tools to help you with the following tasks:

- Review, approve, and publish bots
- Review your team's bot use case ideas
- Add or remove users and assign permissions

Watch the following video on how to get started with Private Bot Store:

Related concepts

[Getting started with Private Bot Store](#) on page 3612

Use Private Bot Store to view and submit bots and bot use cases within your company. Use admin tools to review and publish bots and manage users.

## Getting started with Private Bot Store

Use Private Bot Store to view and submit bots and bot use cases within your company. Use admin tools to review and publish bots and manage users.

The following is a high-level overview of how to get started with Private Bot Store:

1. The Private Bot Store support team creates admin users for your company.
2. Optionally, the support team helps you set up SAML-based SSO or Active Directory Federation Services (ADFS) integration.
3. Admin users grant other users Private Bot Store access and permissions. (It is automated if you use SAML-based SSO or ADFS).
4. Users create bot listings and submit them for approval.
5. Admin users can approve or reject the submitted bots.

- If approved, the bot listing is published and is available on Private Bot Store for other users within the organization to view.
  - If rejected, the bot author receives feedback on what has to be updated. The bot author updates the bot and resubmits it.
6. Other employees within the company access the published bot listings and use them in their automation tasks.

Related concepts

[Private Bot Store](#) on page 3612

Private Bot Store is a secure internal bot marketplace for a company to post and share details and documentation for all internally developed bots. Employees can easily discover internal bots and commands to reuse in addition to all of the bots from the Automation Anywhere Bot Store vendors.

## Set up A-People user access to Private Bot Store

A-People user access and management is included out-of-the-box with Private Bot Store. Within Private Bot Store, your company admin can manage users. Other users with granted permissions can access Private Bot Store with the same credentials they use for public Bot Store and other Automation Anywhere sites.

- Set up A-People user access  
After your first admin users get access to Private Bot Store, they can add additional users. Any Private Bot Store user with admin access can manage users from the **Private Bot Store - User Access Settings** page.
- Add new users individually or in bulk
  - a) Navigate to **User Access Settings**.
  - b) Click **Add Users**.
  - c) Enter the email addresses for the users you want to add.  
Invited users will receive an invitation email with instructions to set up their account.
- Change user permission level  
Only admin users can modify permission levels by selecting the correct level in the **Access** panel.
- Delete users  
Select **Delete** in the **Actions** panel.

Related tasks

[Submit and approve bots using Private Bot Store](#) on page 3614

Use Private Bot Store to submit, review, and approve detailed bot listings for all of the bots your team has built.

## Set up SAML user access to Private Bot Store

Use SAML-based single sign-on (SSO) or Active Directory access to ensure that your Private Bot Store user access is updated automatically when users join or leave your company. Users can log in to Private Bot Store using the same credentials they use for other applications.

- Set up SSO or Active Directory Federation Services (ADFS) user access

The Private Bot Store support team will help you set up **SSO** or **Active Directory** user access.

- Provide details about Private Bot Store in your identity provider (IdP) settings.
- Provide the Private Bot Store support team some information about your system.

The Private Bot Store support team will verify the information and complete the integration.

After the integration is completed, your Private Bot Store user access will be managed automatically by your SSO or ADFS user access.

- Change user permission level  
Admin users can change a user's permission level by navigating to the Private Bot Store **Settings** page and updating user permissions.  
Admins can only modify a user permission level if a user is an active Private Bot Store user.

Related tasks

[Submit and approve bots using Private Bot Store](#) on page 3614

Use Private Bot Store to submit, review, and approve detailed bot listings for all of the bots your team has built.

## Submit and approve bots using Private Bot Store

Use Private Bot Store to submit, review, and approve detailed bot listings for all of the bots your team has built.

- Submit internal bots :  
To submit a new bot:
  - a) From Private Bot Store, click **My Submissions**.
  - b) Click **Add New Bot**.
  - c) Enter all the required fields, such as bot description, benefits, and requirements.
  - d) Review the documentation examples for each field and follow the suggested guidelines.
  - e) Click **Submit** or click **Save** to save the bot before submitting it.  
After you submit your bot, your Private Bot Store admin team receives an email to review the bot.  
Your bot will be published or it might be send back for an update and resubmission.
- Review internal bot submissions  
Private Bot Store admin users approve or reject bot submissions before they can be published.
  - a) As an admin user, navigate to Private Bot Store and click **All Submissions**.
  - b) Click **Review Bot** to review each submitted bot.
  - c) Approve or reject the submitted bot:
    - Approve and publish a bot: On the **Review Bot** page, click **Approve** to publish the bot.
    - Reject the bot and request updates: On the **Review Bot** page, click **Reject** to reject the bot and send feedback to the bot submitter with instructions for updates.

## Submit and manage bot ideas using Private Bot Store

Use Private Bot Store to submit, manage, and prioritize bot ideas for your development requirements.

- Submit bot ideas
  - a) From Private Bot Store, click **Suggest Bot Idea**.
  - b) Fill in all the fields about your bot idea, with as much detail as possible.
  - c) Click **Submit**.

After you submit the bot idea, your admin team will review and prioritize it. The admin team might contact you for more information about your bot idea.
- Manage bot ideas

Private Bot Store admin users can manage and prioritize bot ideas.

  - a) As an admin user, navigate to Private Bot Store and click **Manage Bot Ideas**.
  - b) Click **Review** to review each submitted bot idea.
  - c) Edit any of the fields as required.
  - d) Select a **Bot Priority** level for the bot idea.
  - e) Click **Save**.
  - f) Click the **Mail** icon to contact the bot idea submitter to request additional details.

Watch the following video on how to submit a bot idea to Bot Store.

## Custom filter management in Private Bot Store

Create your own filters and tags to organize your automations in Private Bot Store using the custom filter management page.

Custom filter management enables you to perform the following activities:

- Rename any of the default filters such as **Applications** and **Departments**, and tags (specific categories) such as **Excel** and **Finance**.
- Add up to six of your own custom filters.
- Add your own custom tags, with up to three nested layers of tags, for example, 2021 > Q1 > January.
- Select which filters you want to appear first in your Private Bot Store navigation.
- Select up to five top tags to appear first under their filter.

The custom filters are displayed throughout Private Bot Store, including:

- In the top navigation, filters on the left, and search results.
- On the listing submission form, where bot builders can select custom tags for their bots.
- On bot detail pages, where users can see how each bots is categorized.

## Edit filters

1. You must have an admin user permission to access the **Manage Filters** page in Private Bot Store.
2. Navigate to **Private Bot Store > Manage Filters > Admin Tools > Manage Filters**.
3. Edit the default filters to match your company terminology.  
Whenever possible, use default filter names, such as **Departments**, rather than creating your own filters. As a result, all the existing bots are already tagged and you do not have to tag them again.
4. Under **Actions**, click the **Rename Filter** action (pencil icon) to rename the filter.
5. Click **Add Filter** to add a new filter. Enter the name for the new filter.  
You can add up to six custom filters.
6. Select a filter and click **Reorder entry** on the left and place the filter into your desired order.  
The filter order is reflected in the Private Bot Store navigation and the filter panel.
7. Click the delete (X) action in the right column to delete any custom filter.  
You cannot delete default filters.

## Edit tags

1. Navigate **Admin Tools > Manage Filters > Actions** select a filter and click the tree icon **Add and Edit Tags** action.
2. Select a tag and click the tree icon to **Add Child Tag** within a tag. Enter a new child tag name.  
You can add up to three layers of nested tags.
3. Click the **Rename Tag** action to rename any tag.  
For the default tags, the original **Tag Name** continues to appear in the **Default Name** column for your reference.
4. Select up to five **Top Tag** in the left column to display those tags at the top of the list within each filter.  
Use this for your company most-used applications or other important bot categories. Other than the selected **Top Tag**, tags are displayed in alphabetical order.
5. Click the delete (X) action to delete any custom tag.  
You cannot delete the default tags.



## Automation scenarios

Use these scenarios to help you build and run automations using our products.

---

**Note:** The scenarios contain examples that include the names of individuals, brands, and companies for the purpose of illustrating our product usage as completely as possible. These names are fictitious and any similarity to the names and addresses used by an actual business enterprise is entirely coincidental.

---

### Scenario: Generating insurance quote with Automation Co-Pilot and Process Composer

This scenario details how Zoe (as an insurance agent) generates an insurance quote for a customer using Automation Co-Pilot for Business Users and Process Composer.

#### About this scenario

The scenario describes the actions and data flow for the following four people:

- Zoe is an insurance agent at BBB Insurance Co. where she serves as the primary contact for customers. She is responsible for supporting new and existing customers as she creates insurance quotes based on customer data she's gathered.
- Natalia is a potential customer who has contacted Zoe requesting an insurance quote for a new home purchase.
- Tomas is Zoe's Manager at BBB Insurance Co. He is responsible for drafting budgets, managing resources, and for reviewing and approving any insurance quotes Zoe or any other agent on his team generates.
- Marcus is a software engineer working at BBB Insurance Co. He is responsible for designing, developing, and implementing automations that increase process efficiencies for the insurance company. He is familiar with development tools, processes, and best practices.

## Architecture and tasks flow

The following architecture overview shows the front-end and back-end components, and their related human-initiated tasks and automated tasks for the BBB Insurance Co:

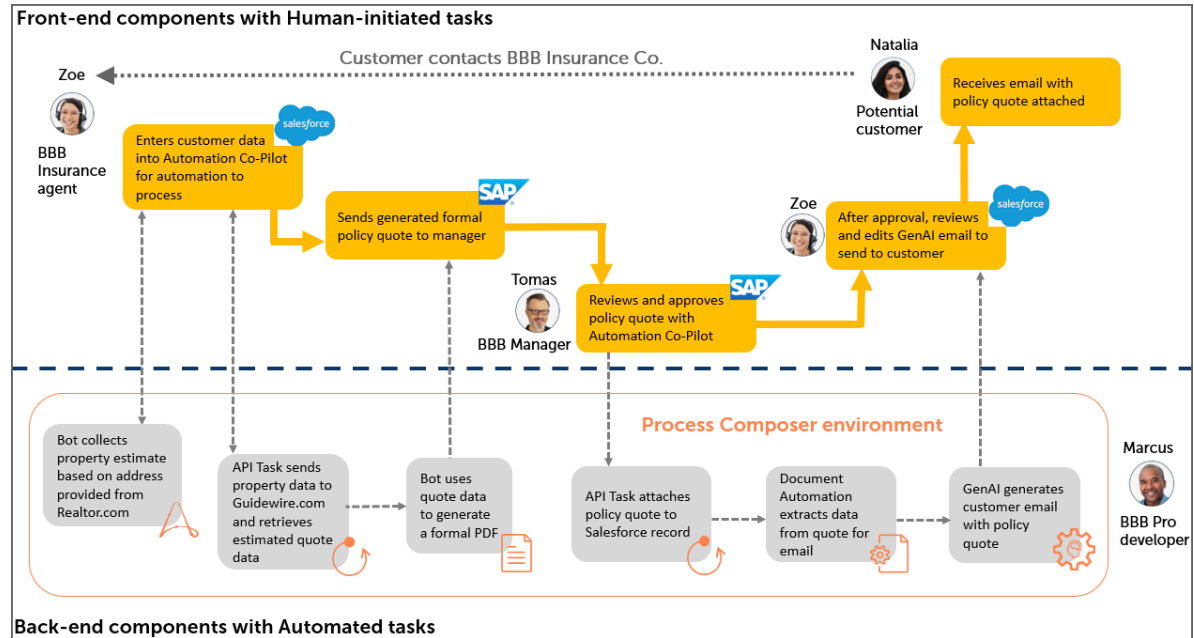

### Front-end components

- [Automation Co-Pilot for Business Users](#) on page 3296 is a user-interface that enables real-time communication between users and bots. Using Automation Co-Pilot for Business Users, you can automate repetitive and time-consuming tasks, navigate controls, and input data when interacting with a customer.
- [Salesforce](#)
- [SAP](#)

**Note:** The Salesforce mark and logo and the SAP mark and logo are trademarks or registered trademarks of Salesforce, Inc., and SAP, respectively, and are used for identification purposes only.

### Back-end components

- [Process Composer](#) is an environment that leverages multiple products across the Automation 360 platform to deliver an Intelligent Automation experience. It provides a drag-and-drop interface that Professional developers can use to create process flows and configure when to execute a bot. Additionally, it displays correct data to users and exchanges data across multiple teams.
- [Realtor.com](#)
- [#unique\\_158](#) builder and [RPA workspace](#)
- [Guidewire.com](#) (a property and casualty insurance data platform) through an [Apigee connector](#)
- Bot builder

- [Document Automation](#) on page 3625

## Scenario walkthrough

The BBB Insurance Co. needed a system that could handle complex workflows that met and delivered on high service level agreements (SLAs).

1. Marcus used Process Composer to create this business process automation and automate the task of generating customer quotes for the BBB Insurance Co.
2. Natalia is in the middle of purchasing a new home and has been shopping online to compare policy quotes provided by several home insurance companies. As a result of her research, she accessed the BBB Insurance Co's website and dialed their toll-free number to speak with an agent about getting a homeowner's policy quote. Natalia contacts Zoe.
3. As part of her job responsibilities, Zoe is first line support for customers looking for insurance policy quotes. She has just engaged with a potential new customer, Natalia. Zoe accesses Automation Co-Pilot for Business Users through an [embedded widget](#) in her Salesforce instance. The widget automates tasks that embed automations built on the Automation 360 platform and connects and authorizes the flow of data between applications and Automation Co-Pilot for Business Users.
4. Zoe explains the process to Natalia as she asks her questions and collects data to generate a new homeowner policy quote. A bot runs in the background gathering property value data based on Natalia's location from Realtor.com.
5. Working in Salesforce (with Automation Co-Pilot for Business Users embedded through the widget), Zoe enters data. API Tasks and the automated process run in the background gathering industry-wide data from Guidewire.com to add to the quote.
6. In the background, Process Composer uses an RPA bot to generate a PDF file for the quote.
7. Zoe sends the generated quote (formatted as a PDF file) electronically to her manager Tomas to review and hopefully approve.
8. Tomas is manager of a team of customer agents and is responsible for drafting budgets, managing resources, and for reviewing and approving any insurance quotes generated by his team. Working in SAP (with Automation Co-Pilot for Business Users embedded in the application), Tomas was just notified of a new policy quote that was submitted by Zoe for review.
9. Tomas carefully reviews Zoe's quote and agrees that it would be a good risk for his company to accept. He approves the policy quote. Zoe receives an immediate notification that the policy quote for Natalia has been approved. Simultaneously in the background:
  - a) An API Task is used to attach the policy quote to a record in Salesforce.
  - b) Document Automation extracts data from the quote for an email.
  - c) Generative AI generates a customer-specific email that contains the policy quote information.
10. After receiving Tomas' approval for the policy quote, Zoe reviews and edits the generative AI email in Salesforce.
11. Zoe attaches the policy quote PDF file to the email and sends it to Natalia.
12. During the phone call with Zoe (within five to six minutes), Natalia receives the completed policy quote as an attachment to an email. She considers using the BBB Insurance Co. to insure her new home.

## Scenario summary and benefits

The BBB Insurance Co. will be looking to automate future business processes.

### Summary

With access to the Automation Co-Pilot embedded widget, employees (Zoe and Tomas) can run remote or local automations on-demand from any web application. With in-app (Automation Co-Pilot for Business Users) notifications, Zoe and Tomas are alerted to tasks requiring their immediate attention. As a result, the BBB Insurance Co. can automatically generate and deliver on-demand insurance quotes to their customers (Natalia) with real-time and embedded approvals.

### Benefits

By implementing Automation Co-Pilot for Business Users and Process Composer on the Automation 360 platform, the BBB Insurance Co. realized the following benefits:



Time to generate each policy quote decreased by 90% (from 60 mins to 6 mins).



Zoe can spend her valuable time and effort processing the quote request (including approval) instead of spending a lot of time logging in and out of various applications, trying to contact her manager, writing emails, looking up various industry data points, and so on. By having prompt results and actionable deliverables, Zoe felt empowered with her interaction with Natalia and derived immediate job satisfaction.



Whether it's Salesforce, SAP, or other applications, BBB employees never need to leave their home application of choice for their daily activities or for when an immediate action is required leading to greater employee productivity and efficiencies.

---



Customer satisfaction has increased for both new and existing customers. Natalia ended her call with Zoe satisfied and confident with the service the BBB Insurance Co. can provide having experienced their competency and customer care first-hand.

---

## Scenario: Developing and using templates in an automation

Use this scenario to understand how to create a template for automations, and how to use these templates to simplify the process of creating automations.

### About this scenario

This scenario details the actions and workflow of the following users:

Marcus is a Professional Developer who works in the Acme healthcare company. He works in the Human Resources department and is responsible for designing, developing, and implementing automations to improve process efficiency and has created many such automations to automate business processes in his organization.

In this scenario, Marcus creates a template to automate the performance metric process. Performance metrics workflow consists of a series of repetitive steps that is widely used across multiple departments. Creating a template for this workflow will benefit all departments by saving the time and effort for each department to build its own automation from the start. Instead, they can use the template Marcus creates and customize it based on their specific requirements. After he creates the template, Marcus checks in his template to the public repository and makes it available for other users in different departments.

Sue is a Citizen Developer who works in the same organization as Marcus but in the Finance department. She is responsible for calculating annual employee appraisals and decides to automate this process. While working on the automation workflow, Sue uses the template created by Marcus for performance metrics to help save time.

The following workflow illustrates how Marcus (Professional Developer) develops a template for performance metrics, and then how Sue (Citizen Developer) uses that template in the appraisal calculation automation.

## Developing performance metrics template

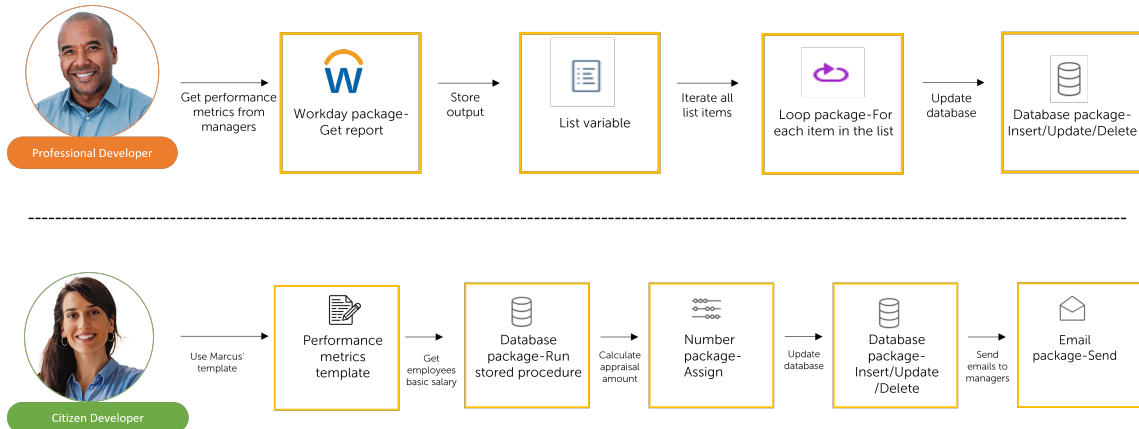

## Using performance metrics template in building automation

## Marcus creates a template

The following procedure summarizes how Marcus creates a template for the performance metric process and checks in the template to the public repository.

1. Marcus log in to the Control Room as a Bot Creator.
2. He navigates to the **Automation** tab, and creates an automation.
3. After entering the required details for the automation, he opens the automation on the Bot editor to build the performance metric automation.
4. He uses the **Workday > Get report** action to get the performance metrics report and save the outcome to a list variable.
5. He uses **Loop > For each item in the list** to read and iterate each item in the list.
6. He uses **Database > Insert/Update/Delete** to update the performance metrics component for each employee in the database.
7. He saves this automation as a template.
8. On the **Automation** page, he selects the Performance metrics template and check in the template to the public workspace from his private workspace to make it available for all users.

## Sue builds automation using the template

Sue uses Marcus's template and creates an annual appraisal automation.



1. Sue log in to the Control Room as a Citizen Developer.
2. She navigates to the **Automation** page and selects the **Create new > Task Bot from Template** option to create an automation using a template.
3. In the template picker window, Sue sees all the template available in the public repository.
4. She searches for Marcus's template and opens the template in preview mode to review if that one suits her requirements.
5. After ensuring it does, she selects the template to start creating an automation.

6. She enters the required details and navigates to the Bot editor.  
The structure from the template is added to the Bot editor.
7. She modifies the existing code flow and adds the following new actions to build the Annual appraisal automation:
  - a) **Database > Run stored procedure** action to retrieve the employees' salary details.
  - b) **Number > Assign** action to apply the formula and calculate the appraisal amount.
  - c) **Database > Insert/Update/Delete** action to insert the data and update the database.
  - d) **Send** email action to send emails to employees and managers.
8. She then saves and runs the automation.

Appraisal details are retrieved and shared with managers through email.

## Summary and benefits

Using templates benefited Sue and Marcus to achieve their automation goals in specific ways.

	Marcus creates templates for use cases that are common across different departments.
	Using a predefined template enables Sue to quickly build automation without recreating the same automation, thus saving time.
	Overall benefits include cost reduction, enhancement in productivity, and accelerated automation development.

# Document Processing

Automation Anywhere offers several web-based intelligent document processing solutions that extract semi-structured data from documents and convert it into structured data, which can be used by Robotic Process Automation (RPA) bots for automation of business processes.

## Overview

Typically, RPA bots can automate only those tasks that involve processing structured data. As a result, about 80% of a business's data remains inaccessible to RPA bots as "dark data." This dark data is made accessible to RPA bots by cognitive automation, which combines the technologies of intelligent document processing and RPA. With cognitive automation, semi-structured data is extracted from documents such as invoices, and converted into structured data, so RPA bots can subsequently use this structured data for automating business processes.

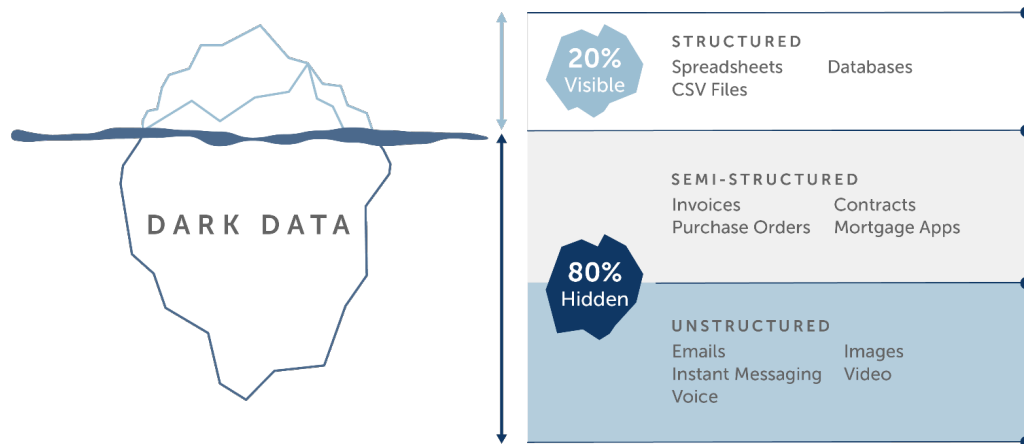

Learn more about the Automation Anywhere intelligent document processing solutions:

### Document Automation

Document Automation is the new Cloud-native intelligent document processing solution that business users can set up to automatically read and process documents quickly using pretrained models and validation feedback.

[Document Automation](#) on page 3625

### Automation 360 IQ Bot

In Automation 360 IQ Bot, users configure templates and train bots to extract data from a variety of documents. Automation 360 IQ Bot is available for on-premises and cloud installations, and offers users a wide range of tools to customize and optimize document processing, including the following:

- Packages to create models for classifying documents by category and to enhance the quality of documents or images for better extraction



- Standard form models for extracting data from documents that have minimal or no variation in their layout
- Support for Optical Character Recognition (OCR) engines to improve the accuracy of the extracted data

[Automation 360 IQ Bot](#) on page 3730

IQ Bot 11.3.x

This early version of IQ Bot supports Enterprise 11 customers. It is available for on-premise installations only.

[IQ Bot 11.3.x](#)

Community Edition

The Community Edition version offers users limited features from the document processing solutions Document Automation and Automation 360 IQ Bot. This version is available to users for free.

[Document Automation Community Edition](#) on page 3724

## Document Automation

Document Automation is the new Cloud-native intelligent document processing solution that business users can set up to automatically read and process documents quickly using pretrained models and validation feedback.

Document Automation is fully integrated into Automation 360: Document Automation is installed as part of the Control Room. RPA bots are used to extract semi-structured or unstructured data to automate document-centric business processes, and Automation Co-Pilot for Business Users manages the end-to-end extraction process and validation tasks.

With Document Automation you can:

- Process more document types: Configure and process structured and semi-structured documents within a single, intuitive interface that is integrated with the Automation Success Platform with no additional software to install.
- Leverage a seamless user experience: Enjoy a unified experience for all document validations using Automation Co-Pilot for Business Users. The default document processing flow can be changed as needed enabling users to streamline their document workflows with ease.

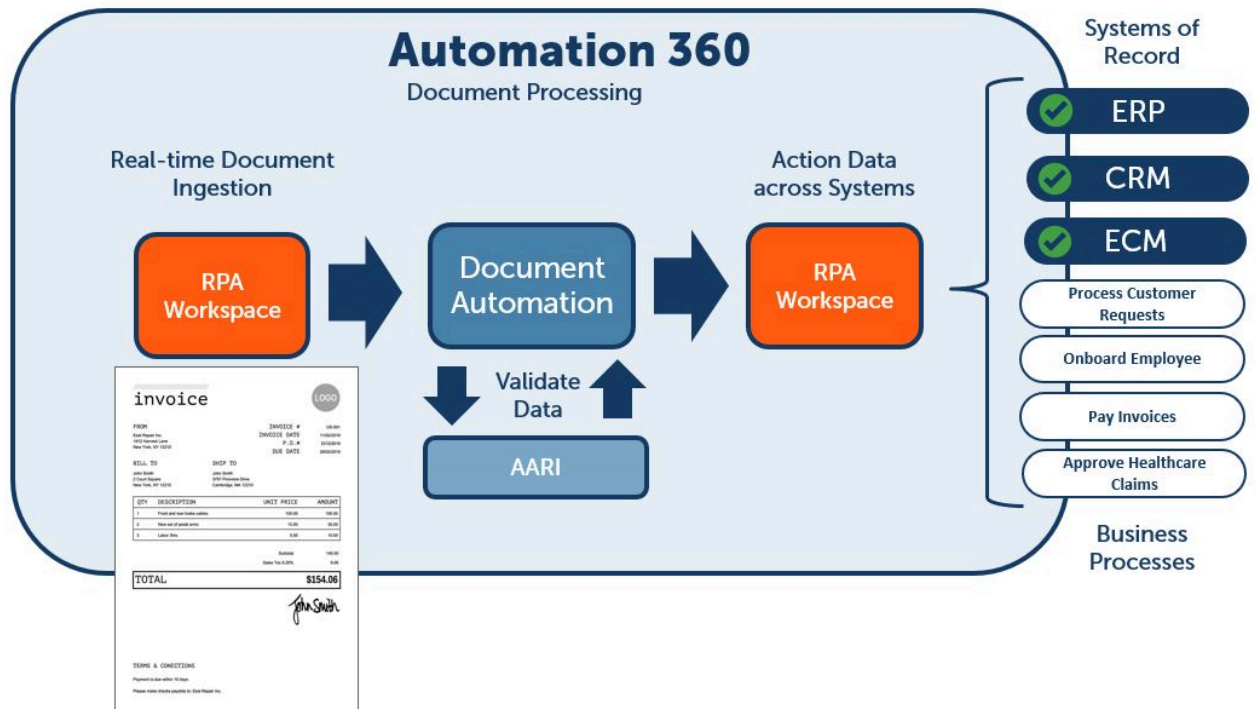

The Document Automation workflow enables users to scale their document processing operation. Users create learning instances that use Automation Anywhere or Google Document AI pre-trained models to process invoices, utility bills, and receipts. Once a learning instance is running in production, it automatically improves extraction accuracy based on feedback from manual validation.

Watch this video to understand how you can use Document Automation to extract and embed data quickly and easily with an automated work-flow.

To compare Document Automation features side by side with Automation 360 IQ Bot, see [Intelligent Document Processing solutions feature comparison matrix](#) on page 3634.

## Set up the Document Automation environment

Document Automation is installed simultaneously with the Control Room and shares the Control Room database. There are no additional installation tasks for Control Room Cloud customers.

To get started using Document Automation, you must first configure users, roles, and devices, and connect the Control Room with Automation Co-Pilot for Business Users:

[Set up your Document Automation environment](#) on page 3636

**Note:** To install Document Automation in an On-Premises server, note the following:

- The Control Room stores Document Automation output data.
- You must install the Control Room in a configuration that points to the location where Document Automation data is stored. Ensure there is sufficient storage space.

- The minimum necessary storage space depends on the processing volume, document size, and use case. As a guide: an environment that processes 100,000 pages per month, with a 30-day data lifespan, requires 500 GB of storage space.

## Using Document Automation

Workflow map: Click the following schematic image to view the workflow in an interactive visual



format:

1.

The following is an overview of the end-to-end process to create, configure, and publish a learning instance in Document Automation:

Step 1: [Create a learning instance](#)

Log in to the Control Room as the learning instance creator user, and create a learning instance to extract values from documents.

Step 2: [Process documents](#)

Upload documents to the learning instance to test the model, fix validation errors, and verify the extracted data.

Step 3: [Build a bot to upload documents to Document Automation](#) on page 3682

Build a bot that uploads documents from a source folder to Document Automation.

Step 4: [Publish the learning instance to production](#) on page 3680

Check-in the learning instance assets (process, form, and bots) to the public repository. Then, deploy the process and bots to unattended Bot Runner devices to begin processing documents in real time.

After the process is deployed, incoming documents are processed, and Document Automation either extracts data from the documents or sends the documents for validation.

Step 5: [Validate the uploaded documents](#)

Log in as the Validator user, open the validation queue, and use the Validator to fix errors.

Related concepts

[Document Automation users](#) on page 3638

With the required roles, permissions, and licenses, Document Automation users can perform various tasks. Users and roles are defined in the **Administration** tab.

Related tasks

[Set up your Document Automation environment](#) on page 3636

Document Automation is installed simultaneously with the Control Room. Configure the users, roles, and devices, and connect the Control Room with Automation Co-Pilot for Business Users.

Related reference

[Document Automation FAQ](#) on page 3631

Answers to frequently asked questions (FAQs) on the latest Automation Anywhere intelligent document processing solution, Document Automation.

Related information

[Document Automation Developer Training \(A-People login required\)](#)

## Document Automation architecture

Document Automation uses features from the Control Room and Automation Co-Pilot for Business Users, as well as some third-party products.

The following architecture graphic demonstrates the flow of data in the intelligent document processing workflow for the two possible deployment scenarios:

- The Learning instance creator uploads documents to the Document Automation interface, for example to test the extraction capabilities of the learning instance.
- An Unattended Bot Runner deploys the Scheduler Bot to upload and process the documents.

The graphic also shows the scenarios where data is sent to third-party products, such as for Google Document AI or Standard Forms extraction.

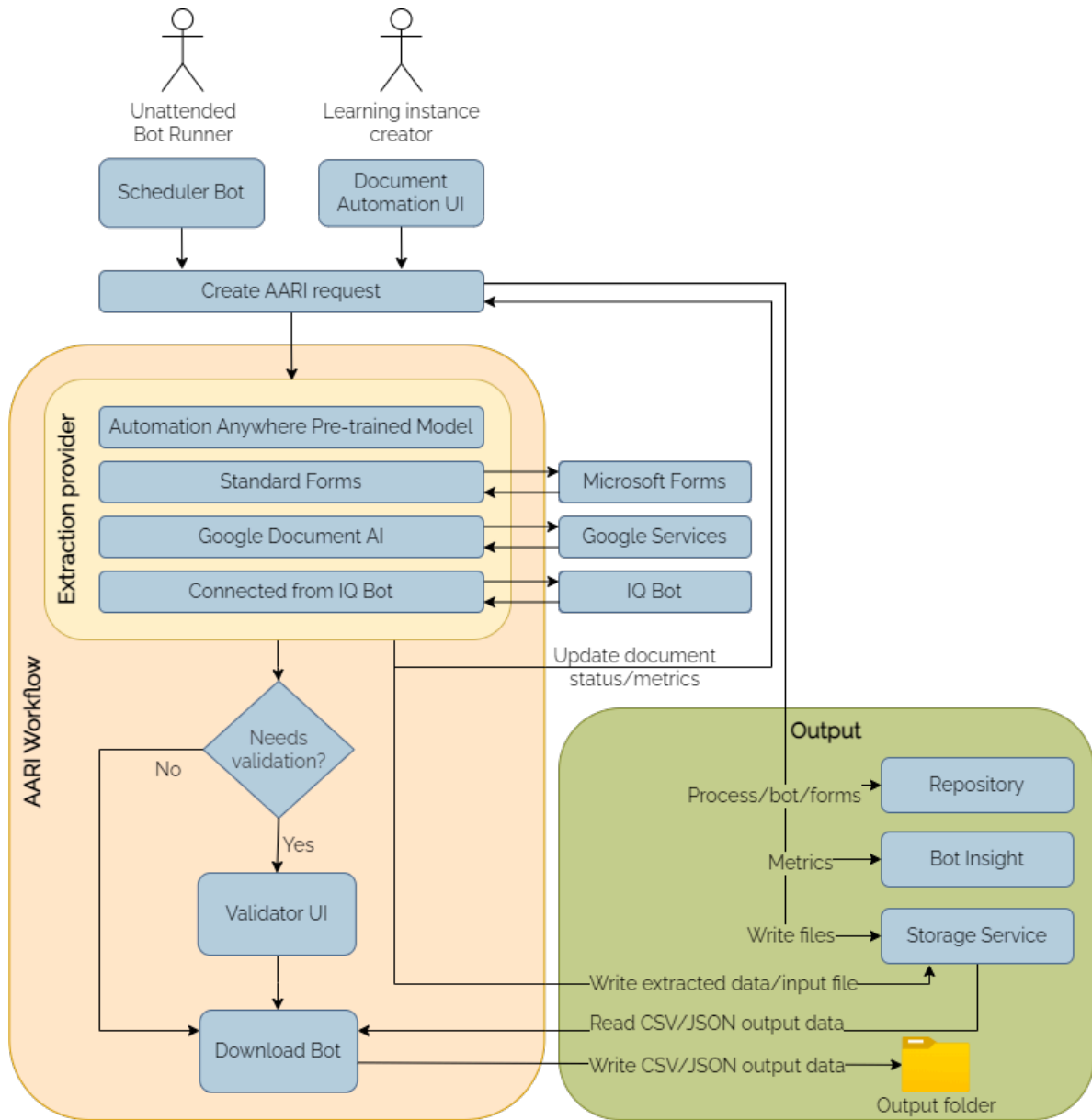

### Control Room to regions mapping

Document Automation is supported on AWS and Google Cloud Platform.

For customers who configured Document Automation with Google Document AI licenses purchased from Google: Documents uploaded to Document Automation for processing in Google Document AI are sent to the Apigee gateway that you configured when you created the processor in Google Document AI.

For customers who purchased Google Document AI product licenses from Automation Anywhere: Google Document AI uses the Apigee API gateway to manage the document processing APIs. When a document uploaded to Document Automation is sent to Google Document AI, data is sent to the Apigee gateway that corresponds with your AWS or Google Cloud Platform region.

Apigee gateway	AWS/Google Cloud Platform regions
US	<ul style="list-style-type: none"> <li>• US-East</li> <li>• US-Central</li> <li>• US-West</li> <li>• CAN</li> <li>• LATAM</li> </ul>
Europe	<ul style="list-style-type: none"> <li>• EU-West1</li> <li>• EU-West4</li> <li>• ME</li> <li>• S-Africa</li> <li>• AP-Aus</li> <li>• AP-Singapore</li> <li>• AP-JP</li> <li>• India</li> </ul>

## File storage

The document that you upload in Document Automation is first stored in the Automation Anywhere Control Room Storage Service in an encrypted form. During the extraction phase, documents are pulled from the storage service and then uploaded to external providers for extraction.

After extraction, the files are stored as follows:

- For **AA Pre-trained** models: File is deleted immediately post extraction.
- For **Connected Learning Instances**: File is deleted immediately post extraction.
- For Microsoft Azure Form Recognizer and Google Document AI: Since these are third party managed extraction services, the privacy policies vary for each providers and it needs to be checked with the service provider. For more details about privacy policy for these external services, see [Document AI Security & Compliance](#) and [Microsoft Azure AI Security Policies](#).

When you have the extraction results from the provider, the results are validated. Based on the validation results,

- If the document goes to validator, it is available for 90 days and you can perform validations within the 90 days.
- If the document goes to STP or validated by users, then by default the document gets deleted when the downloaded bot runs.

Related concepts

[Improving extraction accuracy through validation](#) on page 3662

Understand how the system improves extraction accuracy though user-provided changes in the Validator.

[Automation 360](#) on page 1013

The Automation Anywhere Digital Workforce platform is the foundation to deliver the automation of complex business work securely and at scale. Automation 360 is an industry-leading RPA and

digital workforce platform that combines an easy-to-use user interface with enterprise-class reliability and the security to enable real-time self-automation.

Related reference

[About the Automation Co-Pilot process in Document Automation](#) on page 3646

Document Automation uses Automation Co-Pilot for Business Users technology to manage the end-to-end document extraction process. When you create a learning instance in Document Automation, the system also creates an Automation Co-Pilot process. Review the following guide to understand the logic.

## Document Automation FAQ

Answers to frequently asked questions (FAQs) on the latest Automation Anywhere intelligent document processing solution, Document Automation.

### Product FAQ

What pre-trained models are included?

Automation Anywhere offers invoices and Google Document AI offers invoices, utility bills, and receipts.

Does Document Automation have feature parity with Automation 360 IQ Bot?

Document Automation supports the following features from Automation 360 IQ Bot:

- Data extraction from text, number, date time, and check box fields
- Validation rules based on patterns, formulas, lists, and statements

---

**Note:** Document Automation does not support check box fields. The check box fields are available only for Automation 360 IQ Bot.

---

Which browsers are supported?

Document Automation is supported on the same browsers as the Automation Anywhere Control Room: Google Chrome, and Microsoft Edge.

---

**Note:** If you use Document Automation in Firefox, the user interface might not behave as expected.

---

What languages are supported?

The languages supported Document Automation vary based on the providers, document types, OCR engines, and third-party parsers. For more details, see [Languages supported in Document Automation](#) on page 3719.

You can process documents in other languages by creating and training a learning instance in Automation 360 IQ Bot and connecting it with

What file formats are supported?	Document Automation to process documents using Document Automation technology and workflow. For more information, see <a href="#">Connect learning instance</a> on page 3668.
What are the hardware requirements for Document Automation?	Document Automation can process documents in the following file types: <ul style="list-style-type: none"><li>• PDF</li><li>• JPG</li><li>• JPEG</li><li>• PNG</li><li>• TIF</li><li>• TIFF</li></ul>
Which licenses are necessary?	The hardware requirements for Document Automation are the same as the Bot Agent. For detailed information such as hardware components, compatible devices, supported operating systems and browser extensions, see <a href="#">Bot Agent device requirements</a> on page 1340.
Can learning instances be migrated from Automation 360 IQ Bot to Document Automation?	For the license details, see <a href="#">Understanding licenses in Document Automation</a> on page 1410.
Are customers required to maintain their Automation 360 IQ Bot environments?	Users can connect their learning instances from Automation 360 IQ Bot to their Document Automation environment, which allows them to process documents using the Document Automation technology without having to rebuild the learning instances. For more information, see <a href="#">Connect learning instance</a> on page 3668.
What learning instance fields are supported out of the box?	If you have connected a learning instance from Automation 360 IQ Bot to Document Automation, do not delete the learning instance from Automation 360 IQ Bot since it stores the training data. We recommend you maintain Automation 360 IQ Bot in a version compatible with the associated Control Room.
What are the available deployment models for Document Automation?	Document Automation offers over 35 of the most common invoice fields, with the option to configure custom fields. To see all the possible fields when you are creating a learning instance, click <b>Show unused fields</b> .
What are the available deployment models for Document Automation?	Document Automation solutions can be deployed in On-premise edition as well as Cloud.



## Processing and extraction FAQ

Which OCRs are supported?	The Automation Anywhere pre-trained model uses the ABBYY FineReader Engine or the Google Vision OCR .
I uploaded documents for processing, but nothing is happening.	The first time you process documents, the Document Extraction package downloads to the local device. This might cause a delay in document processing.
What should I do if a folder contains documents in multiple languages?	Use the Document Classifier package to sort the documents by language, then create a learning instance for each language.
What should I do if a language is not supported for the provided document?	If a document language is not currently supported, a recommended solution is to extract documents using languages available by other Providers such as, Standard Forms and Google Custom Data Extraction (CDE).
Is it possible to define custom document types such as bank statements or commerce registrations?	You can use the user-defined document type to process documents that are visually similar to invoices. Additionally, you can also use Standard Forms and Google Custom Document Extractor.
How do I process documents using Google Document AI?	Document Extraction enables users to send their documents to Google Document AI for processing. To use this feature, users must have Document AI licenses that they either purchased from Automation Anywhere or provided their Google Document AI account credentials to the Control Room. The process of creating, testing, and publishing is the same for learning instances using a Google Document AI model as for learning instances using a pre-trained model from Automation Anywhere.
Are multi-page tables supported?	Yes, Document Extraction supports extracting tables that span across multiple pages.
Is it possible to extract multiple tables from a document?	At this time, Document Automation can extract one table per document.
Where can I see the reason why data was not extracted from an uploaded document?	The Automation Co-Pilot <b>Requests</b> tab holds the history for each uploaded document. Here, you can see the step at which extraction failed or if a Validator user marked the document as invalid.
Is currency extraction supported?	Yes, except for the rupee (#).

## Intelligent Document Processing solutions feature comparison matrix

Review the differences between Automation 360 IQ Bot and Document Automation by comparing the features in them.

	Automation 360 IQ Bot	Document Automation
Administration and setup		
Installation	Separate installer	Installed as part of the Control Room
Database administration	Separate database; requires additional effort for backups and maintenance	Uses the Control Room database; no additional backup or maintenance needed
Server configuration	Requires additional SSL configuration, RabbitMQ administration, HA and DR	Works out of the box
Learning instance configuration		
Alias management (keywords)	Yes, parity	Users can view, add, or remove field aliases for the learning instance
Confidence threshold	Does not work out of the box; server-level configuration	Helps to catch false positive outcomes; field-level configuration
Field order and field name customization	Not supported	Helps to improve validation efficiency
Field configuration	Must be done for every group	Needs to be done only one time for a learning instance
Ability to add and remove fields from the learning instance	No	Yes
Search for form or table fields	No	In create/edit learning instance search by field name, label, or data type.
Extraction capabilities		
Pre-trained models	Pre-configured domains that require additional training	Yes, out-of-the-box
Handling document variations	Classifier relies on document layout and training. Documents uploaded with a new layout are sent to a new document group, which requires training. Some docs could not be classified.	Layouts are identified using an object detection model to find key-value pairs. It is not necessary to configure all the fields in a learning instance before uploading documents.

	Automation 360 IQ Bot	Document Automation
Training process	Each group needs to be manually trained before it can process documents	Learning instance extraction improves based on changes users make in the Validator
Output format	CSV only	CSV or JSON
Process invoice-like documents with user-defined document type	Custom domains can be created exclusively through APIs for processing custom document types	Supported out-of-the-box
Regular expression-based extraction	Not supported	Use regex pattern extraction for values that follow a specific pattern, such as a VAT number or a PO number
Standardize the format of extracted numbers and dates	No	Configure your learning instances to convert extracted dates and numbers to standard formats
Unstructured document support	No	Yes, available with GenAI integration
Extraction from Fixed Forms	No	Yes, supported via Microsoft Standard Forms
Google Document AI		
Google Document AI support	No	<ul style="list-style-type: none"> <li>• Pre-trained models for invoices, Utility bills, Receipts</li> <li>• Google CDE support</li> <li>• Available through BYOL and OEM licenses</li> </ul>
Human review and Validation		
Validation queue management	No	Use filters and search to find specific learning instances or documents
Auto-fill for tables	No	Use the <b>Auto fill</b> button in the validation interface to expedite the extraction of values from tables
Document-level Validation rules	No	Document Automation lets you create complex validation rules with different fields, multiple conditions and actions
End-to-end automation		

	Automation 360 IQ Bot	Document Automation
Task bots	Must be manually created	Document Automation automatically creates task bots for a learning instance
See status and history of uploaded documents	No	Yes
Customizable document processing workflow	No	Yes
Ability to split documents	No	Supported by the Advanced Classifier package
Monitoring and reporting		
Custom dashboards	No	Available with Bot Insight integration
Licensing	No	License consumption is tracked properly
Security		
Retention policy	No	Supported for 90 days by default
Secret management	No	Can use credential vault
Audit log	No.	Yes

## Set up your Document Automation environment

Document Automation is installed simultaneously with the Control Room. Configure the users, roles, and devices, and connect the Control Room with Automation Co-Pilot for Business Users.

1. Log in to Document Automation through the Control Room.  
You will receive an email from Automation Anywhere with your URL and credentials. Open the Control Room URL in your browser, enter your credentials in the login screen, and click **Log in**.
2. Upload the Document Extraction package to the Control Room: [Upload the IQ Bot packages to the Control Room](#)
3. Create a custom role that allows users to check in and check out bots, manage packages, and validate documents.: [Create a custom role for Document Automation](#) on page 3638
4. Create the users necessary to complete the end-to-end process of creating and publishing a learning instance: [Document Automation users](#) on page 3638

---

**Note:** When creating the Unattended Bot Runner user, provide the device credentials. You will connect the Unattended Bot Runner to the device in the next step.

---

5. Configure the unattended Bot Runner user device and device pool to allow the learning instance to function in public mode:
  - a) Using Remote Desktop Protocol (RDP), open the virtual machine where the unattended Bot Runner will run.

- b) Log in to the Control Room as the `Document Automation Admin` user you created previously.
- c) Navigate to **Manage > Devices** and click **Connect local device**. Follow the steps in the wizard to connect the Control Room to your device.
- d) Click **Refresh** to verify that your device is connected.
- e) Click **Create device pool** and perform the following steps:
  - 1. Enter a name for the device pool.
  - 2. Click **Devices** and then the arrow to move the device to the **Selected** column.
  - 3. Click **Consumers** and then the arrow to move `aari-document-processor` to the **Selected** column.
  - 4. Click **Create device pool**.

You can perform the following steps in the virtual machine or you can return to your device. If you perform the following steps on your device, ensure that you log in to the Control Room as the `Document Automation Admin` user.

- 6. Open Automation Co-Pilot for Business Users to connect it with the Control Room.
  - a) Navigate to the Automation Co-Pilot interface by adding `/aari` after your assigned Control Room URL.
  - b) Navigate to **Manage > Process > Global scheduler** and click **Edit**.
  - c) Select the Scheduler user that you created previously and click **Save**.  
The following message is displayed: `Secure connection between AARI Web and Enterprise Control Room established successfully`
- 7. Create a team in Automation Co-Pilot to grant the `validator` user access to the documents awaiting validation.
  - a) Navigate to **Manage > Team > Create new team**.
  - b) Enter a team name.
  - c) Select the **Shared** request visibility.
  - d) In the **Users** field, add the `validator` user that you created previously and click **Save**.

If users will create learning instances that use the Google Document AI model and you did not purchase Google Document AI licenses through Automation Anywhere, follow the steps to [Configure key for Google Document AI](#) on page 3640.

Log in to the Control Room as the `Learning instance creator` user and begin creating learning instances: [Using Document Automation](#) on page 3627

Related tasks

[Installing additional licenses](#) on page 1786

Upload new licenses to the Automation Anywhere Control Room to be distributed to users as required.

Related reference

[Automation 360 licenses](#) on page 1407

The **All Licenses** page displays detailed information about current product and device licenses.

## Create a custom role for Document Automation

With a custom role, Document Automation users can check in and check out bots, manage packages, and validate documents.

1. Navigate to **Administration > Roles > Create role**.
2. Provide a name for the role, such as `aari-document-processor`.
3. In the Feature permissions page, select the following:
  - Set automation priority to high
  - View my bots
  - Run my bots
  - Export bots
  - Import bots
  - Create folders
  - Rename folders
  - Cancel checkout

Package Manager

- View packages
- Manage packages

Automation Co-Pilot for Business Users

- Cross Team Read
- AARI Scheduler

4. In the Bots permissions page, select all the check boxes in the **Bots** row.
5. Click **Save** to create the role.

Create users and assign this custom role to them. For more information about the required users, refer to [Document Automation users](#) on page 3638.

## Document Automation users

With the required roles, permissions, and licenses, Document Automation users can perform various tasks. Users and roles are defined in the **Administration** tab.

The following table contains information about each type of user that interacts with Document Automation. It includes a description of the tasks that each user performs, the required roles, permissions, and licenses, and links to the pages most relevant to that user. Use this page to guide you in creating the users in the table below: [Create a user](#) on page 1739

---

**Note:** Some users require a custom role in Document Automation. This role grants users permissions to check in and check out bots, manage packages, and validate documents. For instructions on how to create a custom role, see [Create a custom role for Document Automation](#) on page 3638.

---

User	Description	Roles	License	Related links
Learning instance creator	Can create, edit, and delete learning instances, upload documents for processing, and check in or check out learning instances.	<b>AAE_IQ Bot Services</b> , <b>AAE_Basic</b> , and <b>aari-document-processor</b> custom role	Bot Creator	<a href="#">Create a learning instance in Document Automation</a> on page 3642  <a href="#">Process documents in Document Automation</a> on page 3648  <a href="#">Publish the learning instance to production</a> on page 3680
Standard Forms model creator	Creates an extraction model.	<b>AAE_IQ Bot Services</b> or <b>AAE_IQ Bot Admin</b>	Document Automation Standard Forms (Number of pages)	<a href="#">Create a custom extraction model using Standard Forms</a> on page 3699
Document Automation Admin	Deploys the Automation Co-Pilot process and RPA bots to the unattended Bot Runner, manages Automation Co-Pilot teams, and assigns validation tasks to a team	<b>AAE_Admin</b> , <b>AAE_Pool Admin</b> , <b>AAE_Locker Admin</b> , <b>AAE_Robotic Interface Manager</b> , and <b>AAE_Robotic Interface Admin</b>	--	<a href="#">Set up your Document Automation environment</a> on page 3636  <a href="#">Create a team and assign roles to team members</a> on page 3387  <a href="#">Publish the learning instance to production</a> on page 3680
Scheduler	Enables the Control Room and Automation Co-Pilot to connect learning instances in public mode to Automation Co-Pilot processes.  <b>Note:</b> This user is not associated with a real person.	<b>AAE_IQ Bot Services</b> , <b>AAE_Basic</b> , and <b>aari-document-processor</b> custom role	--	--

User	Description	Roles	License	Related links
Unattended Bot Runner	Runs the RPA bots for learning instances in public mode to upload, process, and download documents.  <b>Note:</b> This user is not associated with a real person.	<b>AAE_IQ Bot Services</b> , <b>AAE_Basic</b> , and <b>aari-document-processor</b> custom role  <b>Note:</b> Provide the device credentials when you configure this user. You will connect the Unattended Bot Runner user to the device in one of the steps in <a href="#">Set up your Document Automation environment</a> on page 3636.	Unattended Bot Runner, Automation Co-Pilot for Business Users, and the product licenses necessary to upload documents to learning instances in production: IQ Bot pages, standard forms, or Document AI  <a href="#">Document processing product licenses</a>	--
Validator	Validates documents that were processed by a learning instance in public mode.	<b>AAE_IQ Bot Validator</b> and <b>AAE_Robotic Interface User</b>	Automation Co-Pilot for Business Users	<a href="#">Validate documents in Document Automation</a> on page 3690

#### Related tasks

[Create a user](#) on page 1739

Create a user and assign their specific license based role.

[Create a role](#) on page 1748

As an administrator, you can configure roles with permissions to access features and perform operations such as create, edit, or delete a bot in the Control Room, and assign the role to a user.

#### Related reference

[Automation 360 licenses](#) on page 1407

The **All Licenses** page displays detailed information about current product and device licenses.

## Configure key for Google Document AI

If the learning instance uses a Google Document AI model and you did not purchase Google Document AI licenses through Automation Anywhere , follow these configuration steps.

- If you have not done so already, complete the steps to [Set up your Document Automation environment](#) on page 3636.



- Log in as the `Admin` user type. For more information about the user types, refer to [Document Automation users](#) on page 3638.

For detailed information, see [BYOK | Google Doc AI Integration](#).

You will assign this role to a Credential Vault locker, which will allow the `Learning instance creator` user to securely provide the Google Document AI key to the **Extraction bot**, allowing the learning instance to send documents to Google Document AI for extraction.

Create a custom role to access the Credential Vault locker that holds the Google Document AI key:

1. Navigate to **Administration > Roles > Create role**.
2. Provide a name for the role, such as `doc-ai-credential-role`.  
The `Manage my credentials and lockers` permission is automatically selected.
3. Click **Create role**.

Assign the role to the `Learning instance creator` and `Unattended Bot Runner` user types.

4. Navigate to **Administration > Users** and locate the users.
5. For each user, click **Edit user** and add the `doc-ai-credential-role`.

Create a credential to store the Google Document AI key:

6. Navigate to **Manage > Credentials > Create credential**.
7. Provide a name for the credential, such as `doc-ai-credential`.
8. Provide a name for the attribute, such as `ServiceAccount`.
9. Select the **Standard** input option and enter the Google Document AI API key in the **Value** field.
10. Click **Create credential**.

Create a locker to store the key and provide access to other users.

11. Navigate to the **Lockers** tab and click **Create locker**.
12. Provide a name for the locker, such as `doc-ai-locker`.
13. Select the `doc-ai-credential` and click the right arrow to move the credential to the **Selected column**.
14. In the **Consumers** tab and select the `doc-ai-credential-role` and click the right arrow to move the credential to the **Selected column**.
15. Click **Create locker**.

Log in as the `Learning instance creator` user type to do the following:

- Create a learning instance: [Create a learning instance in Document Automation](#) on page 3642
- Provide the credential to the **Extraction bot**: [Configure Extract action to process documents in Google Document AI](#) on page 2516

Related tasks

[Installing additional licenses](#) on page 1786

Upload new licenses to the Automation Anywhere Control Room to be distributed to users as required.

Related reference

[Automation 360 licenses](#) on page 1407

The **All Licenses** page displays detailed information about current product and device licenses.

## Create a learning instance in Document Automation

Begin processing documents by creating a learning instance to extract data from invoices, utility bills, or receipts. A learning instance is a structure that holds information such as document type, language, and the fields to be extracted.

- To create a learning instance, you must be a `Learning instance creator` user. See [Document Automation users](#) on page 3638.
- To create a learning instance that uses a Google Document AI model, you must create a credential and locker to hold your security token. See [Create credential](#) on page 1864 and [Create locker](#) on page 1866.

---

**Note:** When configuring the locker, you must add the `aari-document-processor` custom role as a locker consumer.

- The default OCR is ABBYY FineReader Engine. Alternatively, Cloud Control Room users can create a learning instance to process documents in Google Vision OCR.

Watch this video for the complete end-to-end process of creating a learning instance:

1. From the Control Room home page, navigate to **Manage > Learning Instances > Create Learning Instance**.
2. Enter a name and description for the learning instance.  
Document Automation does not allow duplicate learning instance names, so the name you provide must be unique.
3. Select the document type: **Invoice**, **User-defined**, **Utility Bill**, or **Receipt**  
Use the user-defined document type to process documents that are visually similar to invoices, such as purchase orders and sales orders, which contain key-value pairs and a table structure. In this document type, you create and configure all of the form and table fields.
4. Select the language.  
Document Automation supports English, Dutch, French, German, Italian, Portuguese (Brazilian), and Spanish.

---

**Note:** Extraction for French, German, and Spanish language documents is currently in preview. Extraction results will improve in future releases.

If you select a document type that is used while configuring the parser in step 3, the language selected during parser configuration is auto-selected. In addition, the locale list displays language options based on the auto-selected language.

5. If you selected Invoice: Select the provider.  
If you selected the English language in step 4, Automation Anywhere (Pre-trained) is auto-selected.  
If you select a document type that is used while configuring the parser in step 3, the configured (third-party) parser is auto-selected as the provider.
6. Optional: You can use the **Improve accuracy using validation** option to send feedback to the system to improve extraction results. For more information, see [#unique\\_315/unique\\_315\\_Connect\\_42\\_sec-validation-feedback](#) on page 3662

7. Optional: Select the OCR provider. By default, Document Automation processes documents in ABBYY FineReader Engine.

Users with a Cloud Control Room can select to process documents in Google Vision OCR.

8. Click **Next**.

We recommend that you open a sample document side by side with the Control Room window as you configure the form and table fields.

---

**Note:**

- A form field is a type of field that occurs only one time in a document.
  - A table field is a type of field that reoccurs throughout a document, typically in the form of a table.
- 

9. Configure the form and table fields for extraction.

Document Automation offers a standard set of form and table fields, many of which are not initially visible. You can search for a field by field name, field label, or data type.

To see the full list of fields, click **Show unused fields**. See the following video for a demonstration:

Click a field to open the fields editor. You can edit most attributes of a field. You cannot edit the name and default aliases. Document Automation assigns default aliases, which are hardcoded keywords, to standard fields to help with extraction. You cannot modify or delete default aliases, but you can add aliases in the **Custom aliases** field. See the following video for a demonstration of creating a custom alias:

You can add custom form and table fields for Google Document AI learning instances. When you want to extract data from fields that Google does not support, you can create custom fields. With this enhancement, you can use pre-trained models from Google along with custom fields for document extraction.

Consider the following points when you add custom fields for Google Document AI learning instances:

- You can add custom form and table fields for document types such as invoices and utility bills.
- 

**Note:** You cannot add custom fields for the receipts document.

---

- You can edit and save the custom fields.
- A regular expressions (RegEx) is available for the custom fields.
- You can add custom fields for existing learning instances that are attached to the old package.

In this scenario, when you save the learning instance, a notification displays to update the package version.

- Based on the aliases, you can extract the custom fields by using the V8 engine.
  - When a package is not compatible with multiple features, a message displays corresponding to the highest package version.
  - You can import or export the custom fields to or from the .dw file along with defined aliases and settings.
  - When you extract the custom fields, these fields are backward compatible with the older package version.
    - When a learning instance uses the custom fields, the old package (v.29 and earlier) does not throw an error and contains empty values for custom fields.
-

- Similar to the standard fields, the old package (v.29) applies normalization and rules for custom fields, if applicable.

Mouse over the menu icon to the right of a field to access the up/down arrows. Use the arrows to rearrange the order of the fields for a more efficient manual validation. The order of the fields does not impact extraction.

To learn more about the other field attributes, review the table in the next step.

10. To add a field, click **Add a field** and complete the following fields:

Option	Description
Field name	Enter a field name that begins with an alphabetical character (A-Z or a-z). In standard fields, the field name is hardcoded and cannot be changed.
Field label	Enter a user-friendly name to help validators. For example, you can rename <code>Organization tax number</code> to a localized name, such as <code>VAT number</code> . The field label does not affect extraction.
Confidence	Set a threshold to reduce potential false positives. At the time of processing, the Document Automation engine assigns a score to each field in a document to indicate the certainty that the data was correctly extracted. If the document contains fields with a score that is lower than the confidence threshold, the document is sent to the validation queue. If you enter a high confidence threshold, more documents will be sent to the validation queue. If you enter a low confidence threshold, fewer documents will be sent to the validation queue. Supports values from zero to 100.
Data type	Choose from <b>Address*</b> , <b>Text</b> , <b>Number</b> , and <b>Date</b> . If the data in the field does not match the data type, the document is sent to the validation queue. Document Automation supports date and number format variations. * If you are configuring a learning instance with a user-defined document type, the form fields include the address data type, which extracts the entire structure of an address.
Format Date/ Number	Set a standard appearance to convert extracted dates and numbers to a specific format. This ensures consistency and accuracy in your databases and other systems of record. For example, if you select to standardize dates to <code>MM/DD/YYYY</code> and a processed document contains a date that appears as <code>12 Feb 2023</code> , the learning instance will reformat the date to <code>02/12/2023</code> . If you select to standardize numbers to the English (United States) locale and a processed document contains a number that appears as <code>100,00</code> , the learning instance will reformat the number to <code>100.00</code> .

Option	Description
Required	Select one of the following: <ul style="list-style-type: none"> <li>• <b>Required:</b> Field cannot be empty.</li> <li>• <b>Optional:</b> Field can be empty or not exist in the document.</li> </ul>
Default aliases	No action is necessary for this field. Document Automation assigns default aliases, which are hardcoded keywords, to standard fields to help with extraction.
Custom aliases	Additional keywords to help Document Automation locate the field. For example, add country or region-specific names for fields such as VAT number as an alias to an <code>Organization tax number</code> custom field. <p><b>Note:</b> Custom aliases must be unique. They cannot duplicate the default alias of another field. Exception: Form fields can have duplicate custom aliases as the table fields and vice versa.</p>
Validation rules	Depending on data type, create rules using patterns, formulas, lists, and statements such as starts or ends with. <p><a href="#">Formula validation</a> on page 3657   <a href="#">Pattern validation</a> on page 3661</p>

**11.** Click **Create**.

When a new learning instance is created, the Control Room creates a folder with the same name as the learning instance in the **Automation > Document Workspace** folder. The folder contains two bots (extraction and download), a process, and a

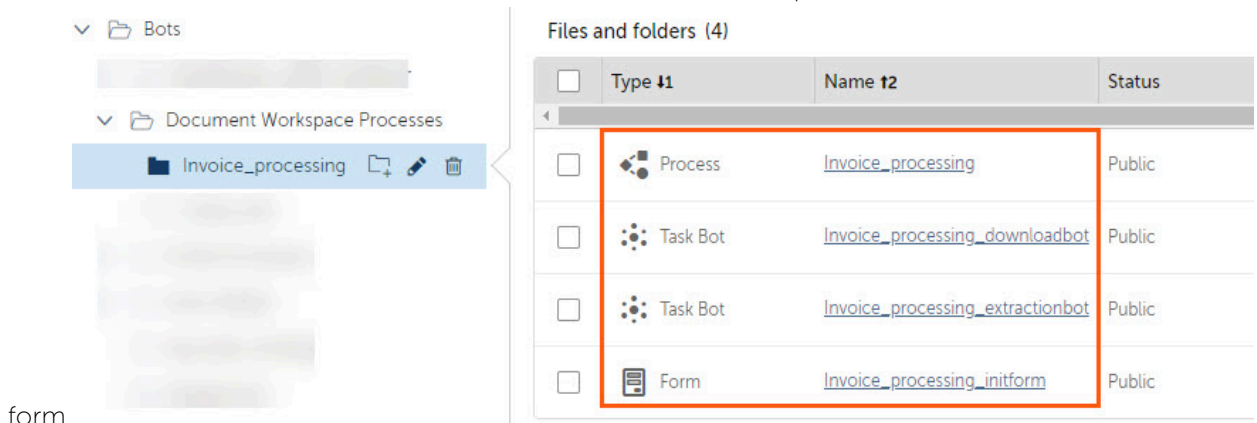

form.

- Process: Manages the process using if/else scenarios through which Document Automation extracts data from uploaded documents, assigns documents to users for validation, and downloads the extracted data. To learn more, see [About the Automation Co-Pilot process in Document Automation](#) on page 3646
- Extraction bot: Extracts data from defined fields in the uploaded documents.
- Download bot: Downloads the extracted data to a specific folder on the device or shared network.
- Form: Defines the input parameters that are sent to the process. Input parameters include the learning instance name, uploaded file, and output file path.

Copy a learning instance in Document Automation

You can copy an existing learning instance (Public and Private) to reuse the learning instance fields, parser, document type, and language. When you copy a public learning instance, the copied learning instance remains in the private mode. After copying a learning instance, you can edit the existing parameter (except parser and heuristic feedback) as required.

To copy a learning instance,

**1. Go to **Manage > Learning Instances**.**

A list of all the learning instances display.

**2. Click the three dots icon next to the learning instance that you want to copy and click the **Copy** option.**

**3. In the **Copy Learning Instance** window, enter the name for the instance.**

---

**Note:** When you copy a learning instance, the default name starts with the prefix **Copy of <<instance name>>**. You can change the name, if required.

---

**4. Select the required copy options and click **Copy**.**

You can select the existing form and table field attributes, validation rules of existing form and table fields, and heuristic feedback.

A success message indicates that the copy process is started and a Control Room notification is triggered to indicate success or failure of the copy process.

Consider the following points when you copy a learning instance:

- You cannot copy the dashboard metrics for the learning instance.
- You cannot copy the connected learning instance.
- You cannot copy the Doc AI learning instance credentials.
- If the underlying package of the learning instance is deleted before copying an instance, an error might occur during the copy process.
- Each copied learning instance is separate one.
- You can delete the original or copied learning instance when required.
- An audit entry is logged.

Upload documents to the learning instance, fix validation errors, and verify the extracted data: [Process documents in Document Automation](#) on page 3648

## About the Automation Co-Pilot process in Document Automation

Document Automation uses Automation Co-Pilot for Business Users technology to manage the end-to-end document extraction process. When you create a learning instance in Document Automation, the system also creates an Automation Co-Pilot process. Review the following guide to understand the logic.

When a learning instance is in production, each incoming document creates a new request, which triggers the extraction process. If a document requires manual validation, Automation Co-Pilot creates a validation task and assigns it to a validation team.

After the documents are processed, the Download bot downloads the extracted data to a file in the Success folder.

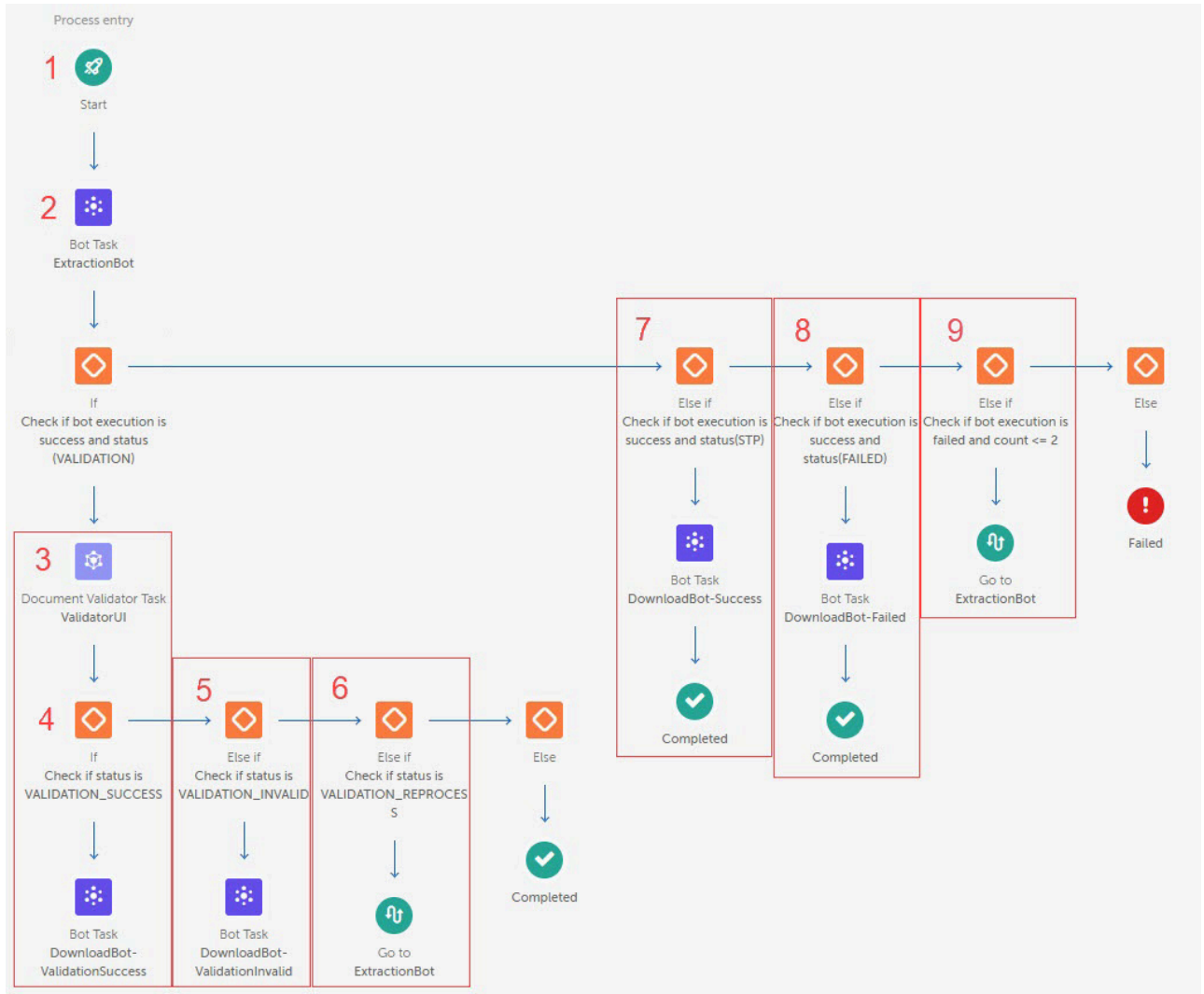

1. Start: The Automation Co-Pilot form that defines the inputs, such as the learning instance name, uploaded documents, and output folder.
2. Bot Task ExtractionBot: Executes the RPA bot that processes incoming documents to extract data from them.
3. Document Validator Task: Opens the Validation user interface where the user can manually validate the fields in the document.
4. Documents require validation: The ExtractionBot tried to process the documents then sent the documents for validation, the documents were successfully validated, and the DownloadBot downloaded the extracted data to the Success subfolder.

Request status = VALIDATION\_SUCCESS

5. Invalid documents: The previous process was interrupted at validation, where a user marked certain documents as **invalid**. These documents were downloaded to the Invalid subfolder.

Request status = VALIDATION\_INVALID

6. Reprocessed documents: The previous process was interrupted at validation because the user clicked **Reprocess**. Documents were sent back to the ExtractionBot for reprocessing.

Request status = `VALIDATION_REPROCESSING`

7. Documents are successfully processed: The ExtractionBot successfully processed the documents, no documents required validation, and the DownloadBot downloaded the exacted data.

Request status = `success` and `STP`

8. Processing failed: The ExtractionBot failed to process the documents (for example: invalid format or could not read the file) and the file is saved to the `Failed` subfolder

Request status = `FAILED`

9. Deployment failed: The Control Room failed to deploy the ExtractionBot (for example: lost server connection). The Control Room makes three attempts.

---

**Important:** We do not recommend deleting the process. If you unintentionally delete a process associated with a learning instance, do the following steps to recover the process:

1. Navigate to **Manage > Learning Instances** and mouse over the actions menu to the right of the learning instance.
2. Click **Export**.
3. Mouse over the actions menu to the right of the learning instance and click **Delete**.
4. Click **Import** at the top of the page.
5. Click **Browse** and select the `.dw` file you exported.
6. When prompted, click **Overwrite** to generate a new process for the learning instance.

---

## Process documents in Document Automation

Upload sample invoices to test the learning instance, verify the extracted data, and fix validation errors.

- If you have not done so already, [Create a learning instance in Document Automation](#) on page 3642.
- Verify that your device is connected to the Control Room: [Install Bot Agent and register device](#) on page 1347
- If the learning instance uses a Google Document AI model and you did not purchase Google Document AI licenses through Automation Anywhere , you must provide your Google Document AI credentials to the Extraction bot. See [Configure key for Google Document AI](#) on page 3640
- If the learning instance uses an Automation Anywhere model, ensure that each file is 50 MB or less.

If the learning instance uses a Google Document AI model, ensure that each file is 20 MB or less, with a maximum of 5 pages.

- Ensure that the sample documents are in one of the following supported document types:
  - PDF
  - JPG
  - JPEG
  - PNG



- TIF
  - TIFF
- The default output format for the extracted data is CSV file. To change the output to JSON, see [Change output format from CSV to JSON](#) on page 3651.

Perform the following steps to upload sample invoices to the learning instance to test the data extraction capabilities of the learning instance.

**1.** Upload documents to test the learning instance:

See these steps in a video:

**a)** Click **Process documents**.

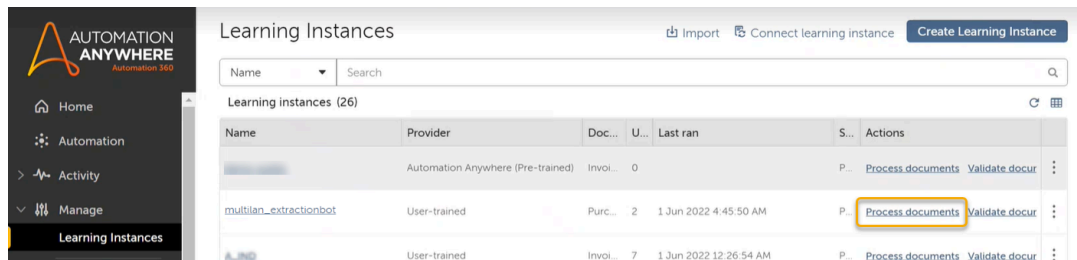

**b)** In the **Process Documents** window, click **Browse** to select the files to upload.

**c)** In the **Download data to** field, enter the file path that will hold extracted data.

When the process runs, it creates the following three folders in the provided file path:

- **Success:** Contains the extracted data in the specified format (CSV or JSON).
- **Invalid:** Holds documents marked invalid.
- **Failed:** Holds documents that could not be processed.

You can provide an output folder path based on one of the following options:

- **Option 1:** The local device path if you have set up document processing and validation on the same device.

This option is typically used when you are testing the learning instance.

- **Option 2:** The shared folder path if you have set up distributed validation on separate devices.

This option is typically used for published learning instances. For example, `\10.239.192.60\Sharepath\Output`.

**d)** Click **Process documents**.

The Bot Runner window appears. The window disappears when the documents are done processing. Refresh the **Learning instances** table to see the updated metrics.

If there is a value next to the **Validate documents** link, you must manually validate the document fields. Otherwise, proceed to step 3.

**2.** Fix the validation errors

**a)** Click **Validate documents**.

The Automation Co-Pilot Task Manager opens in a new tab, with the first failed document in queue. For an introduction to the Validator user interface, see [Using the Automation Co-Pilot Task Manager Validator for Document Automation](#) on page 3688.

- b)** Review each field to verify the data type and extracted value.  
Document Automation supports the following data types: text, number, date, address, and check box  
Alternatively, from the drop-down list on the right panel, you can select **Show fields that need validation**.

---

**Note:** When documents are awaiting validation, if you edit the learning instance, click **Reprocess** to reattempt extraction.

Reprocessing documents does not affect the uploaded documents metric.

---

- c)** Update the fields with errors.  
Click the field or draw a box around the values that you want to extract.  
For Automation Anywhere pre-trained models, you can configure the learning instance to extract specific values in a field and ignore others. For more information, see [Using validation feedback to extract specific values in a table](#) on page 3664.
- To skip a document without correcting errors, click **Skip** to proceed to the next document in the validation queue.
  - To remove a document that cannot be processed, click **Mark as Invalid**.
- d)** After you make the necessary corrections, click **Submit** so that the document can finish processing.  
The next document in queue appears. When all the documents are corrected, the system displays a message stating that no more tasks are available.
- e)** Close the tab to return to the **Learning Instances** page.

**3.** Verify the output results:

- a)** Open the file in the **Success** folder that contains the extracted data and review the results to ensure that it matches your use case.

The Microsoft forms return extracted values (OCR data) in the JSON format, such as `GUID_0-MSFormTableResult.json`. Along with the extracted document data in `<<GUID>>_FileName` CSV file, the **Success** folder also shows the extracted table data separately in another CSV files. Based on the number of tables in the document, you can find different CSV files for each table. For example, `<<GUID_PAGE_NUMBER-Table_FILENAME_PAGENUMBER_TABLENUMBER`.

With separate table data, you can compare extracted data with Microsoft engine data in the `GUID_0-MSFormTableResult.json` file.

- b)** Optional: Review the **Learning Instance** dashboard.  
The dashboard displays the total number of uploaded documents and the number of documents pending validation.

If the learning instance repeatedly cannot find a field or if characters are not correctly recognized (such as the letter "l" extracted as the number "1"), you can try changing the OCR to Google Vision OCR.

Build a bot that uploads documents from a source folder to the learning instance. Then, publish the learning instance assets (process, form, and bots) to the public repository so that the learning

instance can be used in public mode to extract data from real documents, and validators can manually validate documents: [Publish the learning instance to production](#) on page 3680

Related concepts

[Extracting data from check boxes](#) on page 3671

Document Automation supports check box extraction for connected learning instances. The output varies depending on the selected data format.

## Change output format from CSV to JSON

Data from successfully processed documents is available as a CSV file, by default. Change the output format by editing the download data action before you begin uploading documents.

If you have not done so already, [Create a learning instance in Document Automation](#) on page 3642.

To change the output format to JSON, perform the following steps:

1. Navigate to **Automation > Private tab > Document Workspace** and click the folder with the same name as the learning instance to configure the assets.
2. Open the process.

You must update the output format for `DownloadBot-ValidationSuccess` and `DownloadBot-Success`:

3. Click `DownloadBot-ValidationSuccess` and locate the **DocumentType** field.
4. Change `OUTPUT_CSV` to `OUTPUT_JSON`.
5. Repeat steps 3 and 4 to change the output format for `DownloadBot-Success`.
6. Click **Save**.

Upload documents to the learning instance: [Process documents in Document Automation](#) on page 3648

## Validation rules in Document Automation

With validation rules, you can ensure the accuracy of extracted data across multiple fields in your documents.

You can define various conditions, such as pattern matching or equality checks. When those conditions are met, you can effortlessly take action to flag errors or warnings, clean up or replace values, or set new values.

Enhanced validation rules can be applied on two levels:

- Field Rules
- Document Rules

### Field rules

Field-level rules are designed to create rules specifically for individual fields. These rules contain a condition that is followed by a set of actions to be performed if the condition is met and is implicitly associated with the highlighted field.

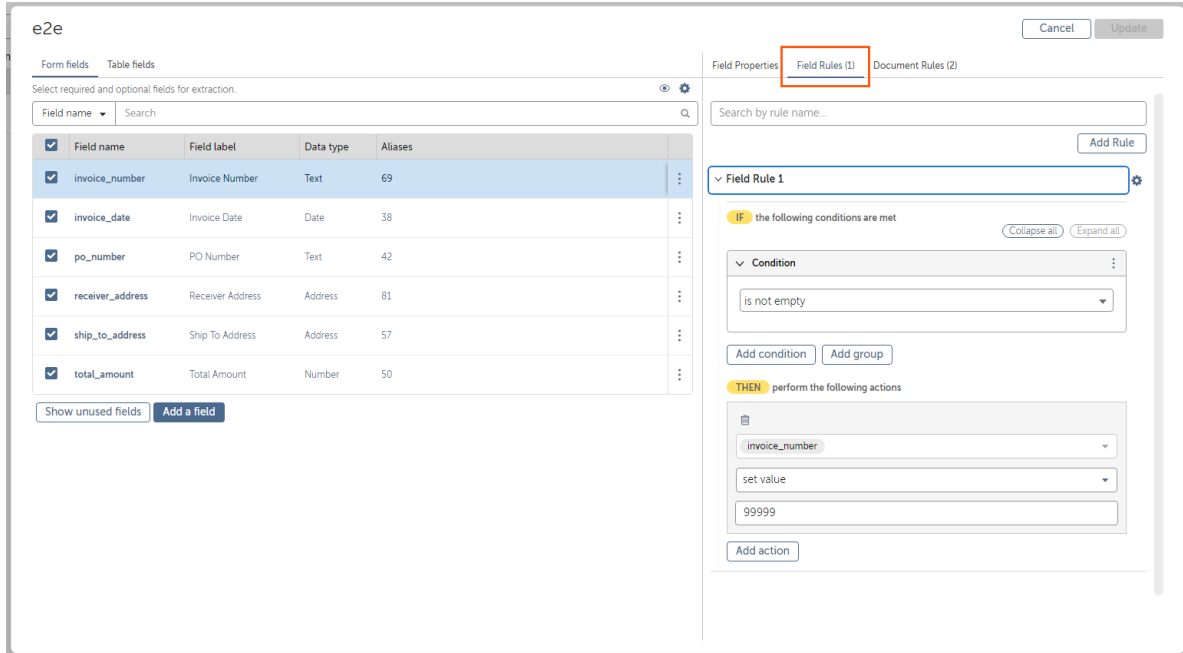

These rules are processed before document-level validation rules.

## Document Rules

A document level rule is associated with a field but can have conditions and actions that are dependent on values of other fields. With these rules, you can build complex structure of conditions that can include several fields and encompass extensive actions.

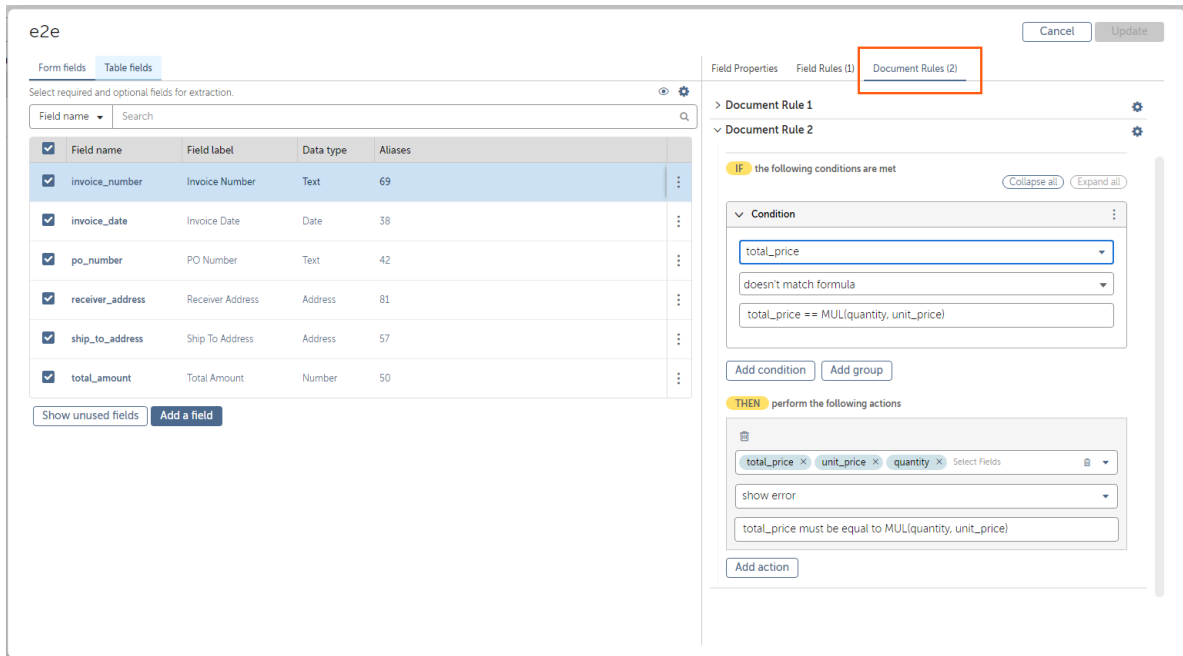

### Note:

- You can select one or more fields where these actions can be applied.

- The document rules can be structured with dependencies between fields, and their execution order is crucial. It is important to maintain the sequence.

In the following video, you can observe how validation rules are utilized within documents to enhance the process of data extraction.

## Available conditions

A condition is expressed as a logical rule that evaluates the state or values of certain fields that must be met for an action to occur. Below is the list of all the available conditions:

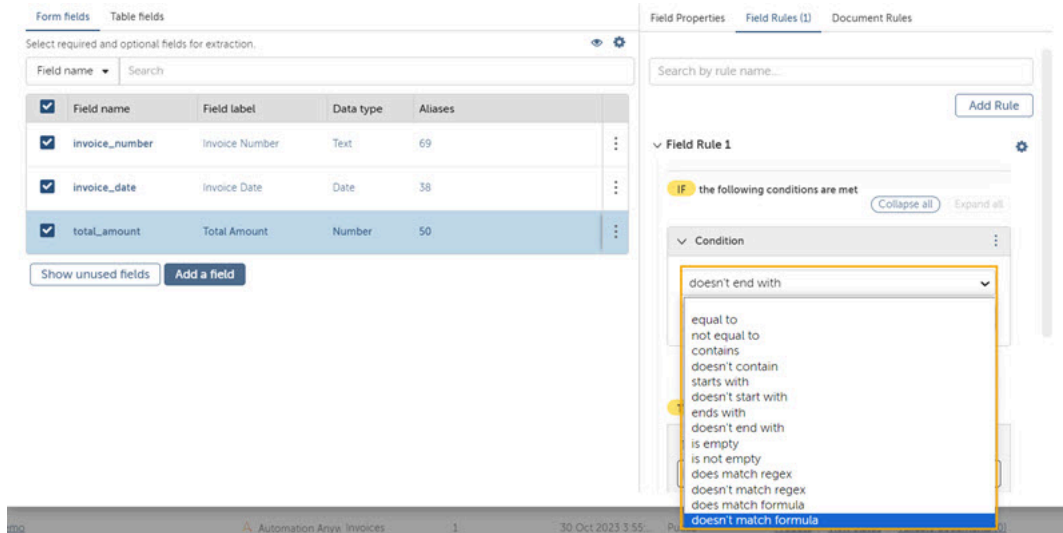

## Available actions

An action is associated with an operation that is performed when certain conditions are met. Below is the list of all the available actions:

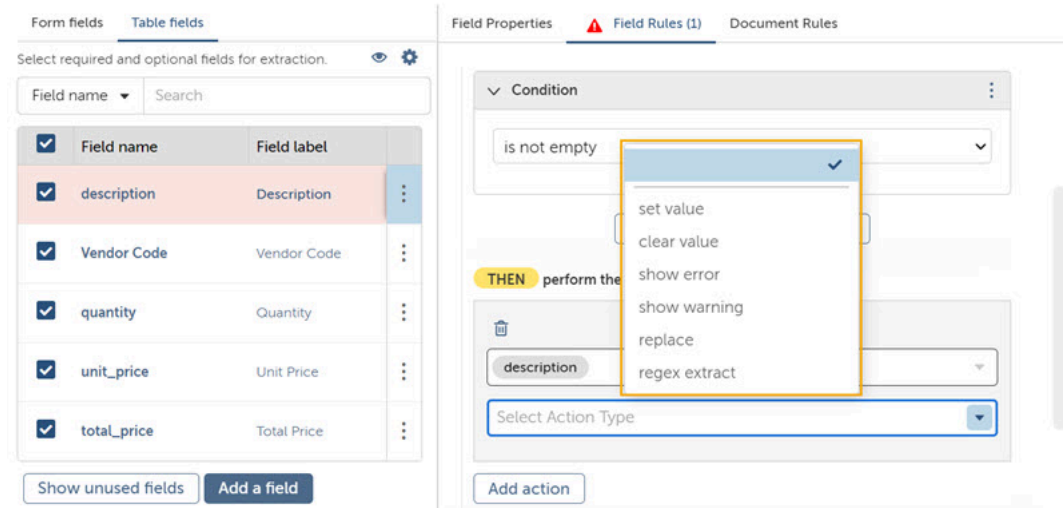

When the specified conditions are met, these actions filter the generated output and provide more accurate document data.

Action type	Description	Example
<b>set value</b>	If the specified condition meets, the <b>set value</b> action sets the specified value for the selected fields.	
<b>clear value</b>	If the specified condition meets, the <b>clear value</b> action clears the values of the selected fields.	
<b>show error</b>	If the specified condition meets, the <b>show error</b> action shows the error message for the selected fields.	
<b>show warning</b>	If the specified condition meets, the <b>show warning</b> action shows the warning message for the selected fields.	
<b>replace</b>	If the specified condition meets, the <b>replace</b> action replaces the values of the selected fields.	
<b>regex extract</b>	If the specified condition meets, the <b>regex extract</b> action applies a regular expression to the extracted value to retrieve a specific sub-string.	

**Note:** The **regex extract** action extracts only the first match found in the value based on the specified regex pattern.

Related reference

[Formula validation](#) on page 3657

Use basic arithmetic, comparative, logical, and functional operations.

[Pattern validation](#) on page 3661

A pattern defines an acceptable format for date, number, or text fields. Reference the tables below for common examples:

### Using regex extract action in validation rule

The **regex extract** action allows users to apply a custom regular expression (regex) to the values extracted from documents. With this action, users can manipulate the extracted data by extracting specific sub-strings based on the specified regex pattern.

When a document is processed and a value is extracted, you can apply the **regex extract** action to this value. You can define a regex pattern which will be used to identify and extract a specific part of the extracted value.

**Note:** It extracts only the first match found in the value based on the specified regex pattern.

- When you apply the regex extract action, the system sets a field value with the first regex match during extraction.
- If the specified regex does not have a match for the field, it returns an empty field value.
- If you do not have an updated (v.31) package connected to a learning instance, you will encounter a warning message to indicate that this rule might not work as expected.

### Example

This feature is particularly useful in scenarios where only a portion of the extracted data is needed. For example, extracting a specific set of numbers from a larger string, isolating a part of an address, or retrieving a specific fragment from a table description.

In the below example, if you want to extract the **Vendor Code** from the **Description** column of the document, it retrieves all the description text from the **Description** column.

The following image shows **Vendor Code** values with regex extraction process.

The image shows a document processing interface. On the left is a summary table of items, and on the right is a detailed view of a table from the document with a highlighted Vendor Code column.

Item No.	Description	Qty	Unit of Measure	GST	Amount	GST
102021	Cannula IV Retractable Autoguard 22G Black 1in 0.9mm x 25mm Vendor Code: 381823	2	Box of 50	85.50		171.00
102670	Set Extension 3-way Stopcock 10cm Connecta Plus3 White Vendor Code: 394995	10	Box of 50	45.50		455.00
103270	Needle Blunt 18G 1.5in Vendor Code: 300204	1	Ctn of 1000	20.00		20.00
103273	Needle Hypodermic 18G 1.5in Vendor Code: 302032	5	Ctn of 1000	20.00		100.00
103406	Syringe Luer Lock Plastipak 30ml Vendor Code: 301229	3	Ctn of 240	67.20		201.60
103409	Syringe Luer Lock Plastipak 50ml Vendor Code: 300845	2	Ctn of 240	76.80		153.60
122629	Syringe Oral Amber 10ml Clear Oral Dispensers with Amber Plunger Vendor Code: 329505	4	Box of 100	24.00	9.60	96.00
245696	Needle AutoShield Duo Safety Pen 30G 5 Retractable Vendor Code: 300142	1	Box of 100	70.00		70.00
288766	Syringe 20Ml Slip Precise Vendor Code: 302404	4	Ctn of 200	52.00		208.00
103031	Condenser Straps 7.5 Yellow Au Vendor Code: 302404	2	Ctn of 5	217.60	43.52	435.20
	Weight	1	Each	50.00	5.00	50.00
				<b>Total AU Excl. GST</b>		<b>1,990.40</b>
				<b>Total AU Incl. GST</b>		<b>2,048.52</b>

Description	Vendor Code	Quantity
Cannula IV Retractable Autoguard 22G Black 1 in 0.9mm x 25mm Vendor Code: 381823	Cannula IV Retractable Autoguard 22G Black 1 in 0.9mm x 25mm Vendor Code: 381823	2
Set Extension 3-way Stopcock 10cm Connecta Plus3 White Vendor Code: 394995	Set Extension 3-way Stopcock 10cm Connecta Plus3 White Vendor Code: 394995	10
Needle Blunt 18G 1.5in Vendor Code: 300204	Needle Blunt 18G 1.5in Vendor Code: 300204	1
Needle Hypodermic 18G 1.5in Vendor Code: 302032	Needle Hypodermic 18G 1.5in Vendor Code: 302032	5
Syringe Luer Lock Plastipak 30ml Vendor Code: 301229	Syringe Luer Lock Plastipak 30ml Vendor Code: 301229	3
Syringe Luer Lock Plastipak 50ml Vendor Code: 300845	Syringe Luer Lock Plastipak 50ml Vendor Code: 300845	2

In this example, we will see how to extract only **Vendor Code** from the **Description** column of document.

1. On the **Field Rules** tab, click **Add Rule**.
2. Specify the **is not empty** condition for the **Vendor Code** field.
3. Select the **regex extract** action type.
4. Specify the regex pattern. For example, `Vendor Code: \d{6}`
5. Test the regex pattern by providing appropriate value for the specified pattern. For example, `Vendor Code: 381823`.

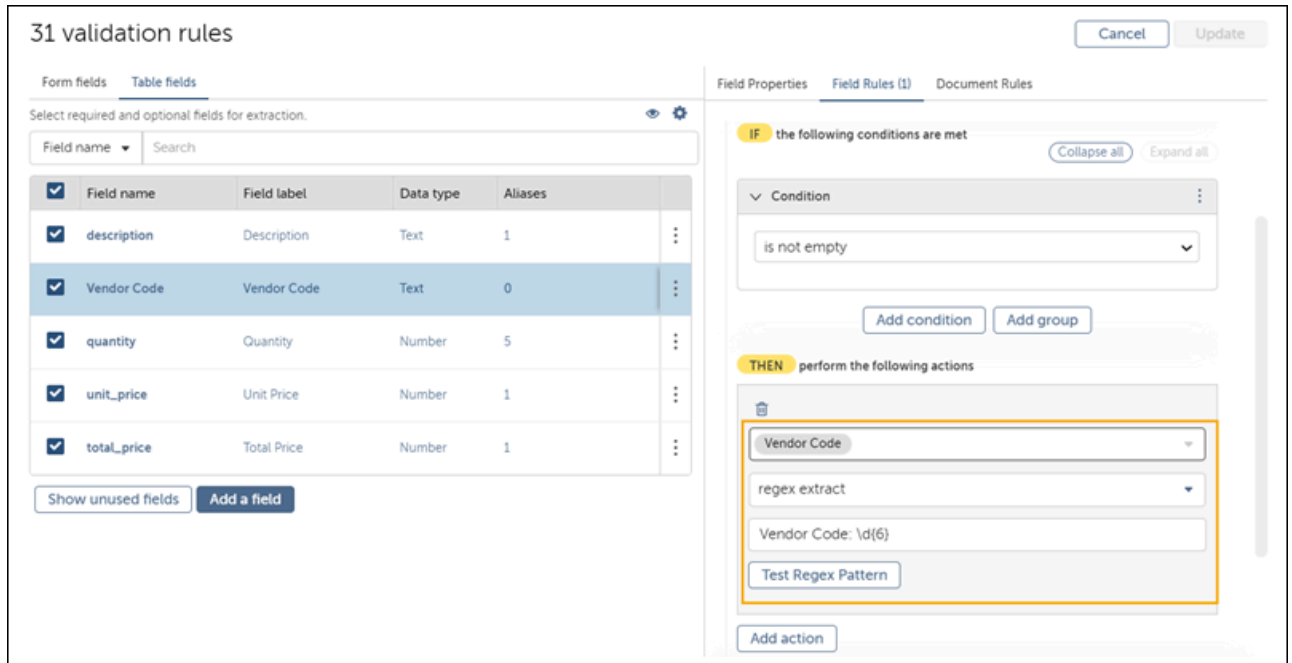

6. Click **Process** to process the document.  
Based on the specified regex pattern, only **Vendor Code** value is extracted from the **Description** column.

The following image shows **Vendor Code** values after applying the **regex extract** action.

Item No.	Description	Qty	Unit of Measure	Unit Cost Ex GST	GST Amount	Line Total Ex GST
102021	Cannula IV Retractable Autoguard 22G Black 1 in 0.9mm x 25mm Vendor Code: 381823	2	Box of 50	85.50		171.00
102670	Set Extension 3-way Stopcock 10cm Connecta Plus3 White Vendor Code: 394995	10	Box of 50	48.50		485.00
103270	Needle Blunt 18G 1.5in Vendor Code: 302032	1	Ctn of 1000	20.00		20.00
103273	Needle Hypodermic 18G 1.5in Vendor Code: 302032	5	Ctn of 1000	20.00		100.00
103406	Syringe Luer Lock Plastipak 30ml Vendor Code: 301229	3	Ctn of 240	67.20		201.60
103409	Syringe Luer Lock Plastipak 50ml Vendor Code: 300865	2	Ctn of 240	76.80		153.60
122629	Syringe Oral Amber 10ml Clear Oral Dispensers with Amber Plunger Vendor Code: 305857	4	Box of 100	24.00	9.60	96.00
245696	Needle AutoShield Duo Safety Pen 30G 5 Retractable Vendor Code: 329505	1	Box of 100	70.00		70.00
288766	Syringe 20ml 50 Precision Vendor Code: 300142	4	Ctn of 200	52.00		208.00
103031	Container Sharps 7.8L Yellow Au Vendor Code: 302404	2	Ctn of 5	217.40	43.52	435.20
	Freight	1	Each	50.00	5.00	50.00
				<b>Total AU Excl. GST</b>		<b>1,990.40</b>
						<b>58.12</b>
				<b>Total AU Incl. GST</b>		<b>2,048.52</b>

Description	Vendor Code	Quantity	Unit Price
Cannula IV Retractable Autoguard 22G Black 1 in 0.9mm x 25mm Vendor Code: 381823	Vendor Code: 381823	2	85.50
Set Extension 3-way Stopcock 10cm Connecta Plus3 White Vendor Code: 394995	Vendor Code: 394995	10	48.50
Needle Blunt 18G 1.5in Vendor Code: 302032	Vendor Code: 302032	1	20.00
Needle Hypodermic 18G 1.5in Vendor Code: 302032	Vendor Code: 302032	5	20.00
Syringe Luer Lock Plastipak 30ml Vendor Code: 301229	Vendor Code: 301229	3	67.20
Syringe Luer Lock Plastipak 50ml Vendor Code: 300865	Vendor Code: 300865	2	76.80
Syringe Oral Amber 10ml Clear Oral Dispensers with Amber Plunger Vendor Code: 305857	Vendor Code: 305857	4	24.00
Needle AutoShield Duo Safety Pen 30G 5 Retractable Vendor Code: 329505	Vendor Code: 329505	1	70.00

Following are some sample regex patterns that you can use for extraction:



Date type	Regex pattern	Examples
Text or address	<code>\b[A-Za-z0-9._%+-]+@[A-Za-z0-9.-]+\.[A-Z a-z]{2,}\b</code>	test@gmail.com
	<code>\b\d{3}[-.]?\d{3}[-.]?\d{4}\b</code>	123.456.7890 or 123-456-7890
Number	<code>^\d{2}\$</code>	12, 23, or 99
	<code>^[0-9]+\$</code>	123 or 12434
Date	<code>\b\d{1,2}[/-]\d{1,2}[/-]\d{4}\b</code>	12/31/2022 or 02/07/2012
	<code>^\d{2}/\d{2}/\d{4}\$</code>	28/02/2222

**Note:** These regex patterns are not fixed and might vary based on your use case requirement.

## Formula validation

Use basic arithmetic, comparative, logical, and functional operations.

**Tip:** We recommended using functional operators instead of mathematical operators when validating fields and tables for better accuracy.

When formulating an expression remember the following:

- All function names must be in capital letters.
- All formulas must result in either a true or false validation.
- Field and column names are case sensitive when used within formulas. If field is defined as Qty in design, using qty or QTY in formula results in an invalid formula.
- For variable declaration or manipulation, ensure not to use certain keywords that are reserved for formulating an expression, including SUM, SUB, DIV, MUL, COLSUM, IF.

## Mathematical operators

Operations	Description	Syntax
+	Addition	Field/Column_Name1 + Field/Column_Name2
-	Subtraction	Field/Column_Name1 - Field/Column_Name2
*	Multiplication	Field/Column_Name1 * Field/Column_Name2
/	Division	Field/Column_Name1 / Field/Column_Name2

## Comparative operators

Operations	Description	Syntax
==	Equal To	[Current Field/Column Name] == [expression comprised of one or more field/column name or fixed numeric values]  For example, AMOUNT == MUL(QUANTITY, UNIT_PRICE)
>=	Greater than or Equal To	[Current Field/Column Name] >= [expression comprised of one or more field/column name or fixed numeric values]  For example, TOTAL_BILL_AMOUNT >= AMOUNT_PAID
<=	Less than or Equal To	[Current Field/Column Name] <= [expression comprised of one or more field/column name or fixed numeric values]  For example, AMOUNT_PAID <= TOTAL_BILL_AMOUNT
>	Greater Than	[Current Field/Column Name] > [expression comprised of one or more field/column name or fixed numeric values]  For example, BILL_AMOUNT > 0
<	Less Than	[Current Field/Column Name] < [expression comprised of one or more field/column name or fixed numeric values]  For example, DISCOUNT_PERCENTAGE < 100

Operations	Description	Syntax
!=	Not Equal To	[Current Field/Column Name] != [expression comprised of one or more field/column name or fixed numeric values]  For example, DEBIT_AMOUNT != 0

## Logical operators

Operations	Description	Syntax
&&	And: Field/Column is valid if all conditions are true	<Current Field/Column Name> <operator 1> <expression 1> && <Current Field/Column Name> <operator 2> <expression 2>  For example, DISCOUNT_PERCENTAGE >= 0 && DISCOUNT_PERCENTAGE <=100
	Or: Field/Column is valid if any one of the given conditions is true	<Current Field/Column Name> <operator 1> <expression 1>    <Current Field/Column Name> <operator 2> <expression 2>  For example, DISCOUNT_PERCENTAGE >= 0    DISCOUNT_PERCENTAGE == 'Net'
!	Not: Converts a true expression to false and also the other way round	!<expression>  For example, !(AGE < 18) ==> valid when AGE is not less than 18

## Functional operators

Operations	Description	Syntax
SUM	Summation: gives result of addition of one or more field/column/fixed-number values	SUM(n1,n2,...,nN)  For example, SUM(SUB_TOTAL, SERVICE_TAX, EDUCATION_CESS) ==> equivalent to SUB_TOTAL plus SERVICE_TAX plus EDUCATION_CESS
SUB	Subtraction: gives result of subtraction of one or more field/column/fixed-number values from the first specified value	SUB(n1,n2,...,nN)  For example, SUB(SUB_TOTAL, TOTAL_DISCOUNT, ADJUSTMENTS) ==> equivalent to SUB_TOTAL minus TOTAL_DISCOUNT minus ADJUSTMENTS
MUL	Multiplication: gives result of multiplication of one or more field/column/fixed-number values	MUL(n1,n2,...,nN)  For example, MUL(QTY_IN_BOX, UNIT_PRICE, SHIPPED_BOXES) ==> equivalent to QTY_IN_BOX multiply-with UNIT_PRICE multiply-with SHIPPED_BOXES
DIV	Division: gives result of division of one or more field/column/fixed-number values from the first specified value	DIV(n1,n2,...,nN)  For example, DIV(AMOUNT, SHIPPED_BOXES, UNIT_PRICE) ==> equivalent to AMOUNT divide-by SHIPPED_BOXES divide-by UNIT_PRICE

Operations	Description	Syntax
COLSUM	Sum of a given Column in a table: gives result after evaluating given expression for each row of specified table and adding them all together	<p>COLSUM("&lt;table-name&gt;", "&lt;expression to evaluate for each row of specified table-name&gt;")</p> <p>For example, FINAL_TOTAL == COLSUM("LINE_ITEMS", "MUL(QTY, UNIT_PRICE)")</p> <p>Say there are 3 rows for table LINE_ITEMS, then FINAL_TOTAL should be equal to MUL(QTY1, UNIT_PRICE1) + MUL(QTY2, UNIT_PRICE2) + MUL(QTY3, UNIT_PRICE3)</p> <p>where, QTY1 is QTY value in row 1, similarly UNIT_PRICE1 is UNIT_PRICE value in row 2, and so on for other rows as well.</p>

Related reference

[Validation rules in Document Automation](#) on page 3651

With validation rules, you can ensure the accuracy of extracted data across multiple fields in your documents.

## Pattern validation

A pattern defines an acceptable format for date, number, or text fields. Reference the tables below for common examples:

### Text

Field	Pattern	Notes	Description
Email	<code>^([a-z0-9_\. -]+)@([\da-z_\. -]+)\.([a-z\.] {2,6})\$</code>	This regular expression validates emails like john@ado.com.	The Email field supports regular expressions.
Phone Number	<code>^( \(?\)+?[0-9]* \)? ?[0-9_ \- \(\)]*\$</code>	This regular expression validates phone numbers like (+64) 38 3235393.	The Phone Number field supports regular expressions.
Website	<code>^([a-zA-Z0-9]+)(\.[a-zA-Z0-9]+)+.*\$</code>	This regular expression validates websites like www.domain.com.	The Website field supports regular expressions.

Field	Pattern	Notes	Description
Number string	<code>^[0-9]{1,45}\$</code>	This regular expression validates a string with numbers 0 - 9 and limit length to 45.	The Number string field supports regular expressions.
Alpha-numeric	<code>^[A-Za-z0-9_@./#&amp;+]*\$</code>	This regular expression validates a string containing alphanumeric values like INV-001.	The Alpha-numeric field supports regular expressions.

## Number

Field	Pattern	Notes	Description
Number string	<code>^[0-9]{1,45}\$</code>	This regular expression validates a string with numbers 0 - 9 and limit length to 45.	The Number string field supports regular expressions.

Related reference

[Validation rules in Document Automation](#) on page 3651

With validation rules, you can ensure the accuracy of extracted data across multiple fields in your documents.

## Improving extraction accuracy through validation

Understand how the system improves extraction accuracy through user-provided changes in the Validator.

When a learning instance is created, the user has the option to enable this feature to send feedback to the learning instance based on user-provided changes in the Validator. In Document Automation, learning instances running in production mode can continuously "learn" whenever a user resizes or relocates the extraction region in the Validator.

The following graphic provides a visual overview of the process by which learning instances continuously receive feedback from validation:

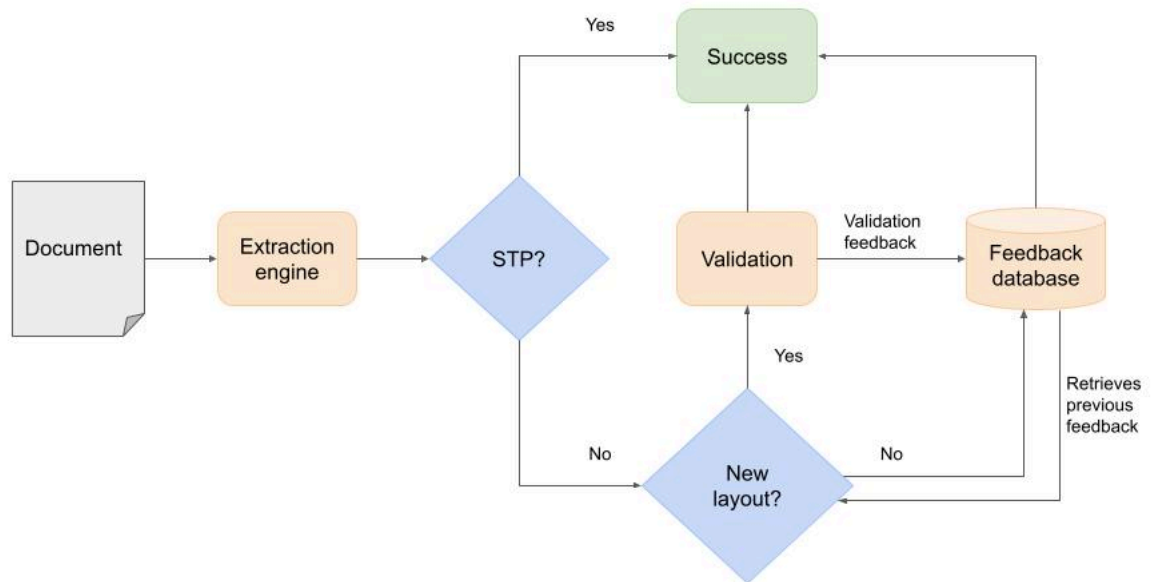

1. An uploaded document passes through the extraction engine.
2. If the learning instance successfully extracts the data, the document is added to the straight-through processing (STP) count and the extracted values are downloaded to a file in the *Success* folder.  
If the learning instance can not extract the data, the system evaluates whether the document contains an unfamiliar layout.
3. If the learning instance does not recognize the document layout (new layout), the document is sent for manual validation where the user "teaches" the learning instance how to extract the data by setting the extraction region.
4. The extracted values are downloaded to a file in the *Success* folder and the changes are collected in a feedback file, which is sent to the feedback database.

---

**Note:**

- Feedback is only collected when the user changes the extraction region. If the user manually inputs text, the system does not collect feedback.
- The feedback file only contains data on the field location to improve extraction accuracy for subsequent documents.

---

If the learning instance recognizes the cluster, it retrieves previous feedback from the feedback database and uses it to extract data.

## Using validation feedback to extract specific values in a table

As of Automation 360v.27, you can train a learning instance to extract data from a cell that contains more than one field.

For example, if a product description column also includes item number, you can outline the item number in the Validation interface. When the learning instance processes subsequent documents, it will extract the item number and ignore the product description.

Follow this process to configure a learning instance to extract specific values from a cell:

1. Create a learning instance using an Automation Anywhere pretrained model and select the option to send validation feedback: [Create a learning instance in Document Automation](#) on page 3642
2. Upload a sample document: [Process documents in Document Automation](#) on page 3648
3. In the Validator, locate the field and redraw the box to only surround the values that you want to extract.
4. After you click **Submit**, the information on the new extraction region is sent to the feedback database.
5. Upload more documents to test the accuracy of extraction. When you are satisfied with the results, proceed to preparing the learning instance to run in production: [Publish the learning instance to production](#) on page 3680

## How Document Automation identifies new layouts

Document Automation extraction is based on object detection. During document processing, the extraction engine identifies objects, or key-value pairs of the field and associated value. The engine creates a "fingerprint" of the document, which stores the sequence of the objects and each object's location in the document.

When a document is processed, if the engine recognizes the keys and their locations, the document is classified and extracted based on that existing fingerprint. Otherwise, the engine saves a new fingerprint of the keys and their locations.



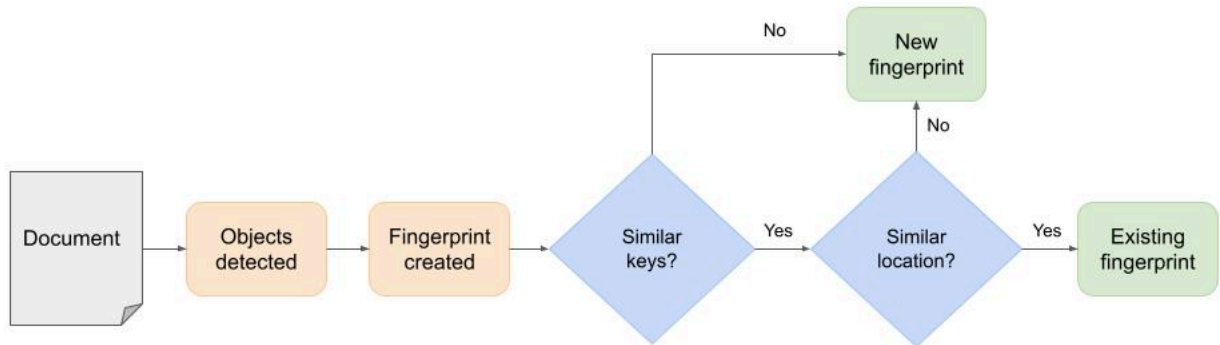

## Using advanced training settings

Use the advanced training settings to train your documents and provide additional inputs to Document Automation extraction engine to improve the table data extraction.

After extracting the document, you can use the **Advanced training setting** option on the validation page to set the following values:

- Primary column:** Set the primary column for row identification based on your requirements.  
 For example, after extracting the document, the multi-line table data from **Item number** column is extracted in a single row but you want to extract it in separate rows. In such cases, you can set the **Item number** as primary column to improve table extraction. For more details, see [Example of setting primary column using advanced training settings](#).
- End of table indicator:** Add an end of table indicator value for the system to extract data till the value reaches to the specified value, excluding the end of table indicator value.  
 For example, when you process a document, it extracts entire table data where as you want to extract row data till **Total payable**. In such cases, you can specify the **End of table indicator** value so that table data till that value (excluding the **End of table indicator** value) will be extracted and no further row data will be extracted.
- Header labels:** Adjust or re-map the table fields as required.

When there is a label mismatch in table data, for example the extracted header label is **Unit Price** but you want the header label as **Price**. In such cases, you can change the header label.

Another use case is you can re-map or change the header label along with the column data. For example, after extraction, the **Price** column from learning instance is extracted as **Extended Price** but you want the header label as **Unit Price** along with its column data. In such cases, you can change the **Extended Price** header label

to **Unit Price** and you must select and re-map at least two cells from the **Unit Price**

Qty.	Unit Price	Sales Tax	Extended Price
11	\$306.16	0.00%	\$3,367.76
12	\$306.16	0.00%	\$3,673.92

column.

Change the header label to "Unit Price"

Replace these values with at least two cells values from Unit Price column that is \$306.16

**Note:**

- This feature is available starting from Automation 360 v.31 release.
- This feature is only applicable to providers only if the **Improve accuracy using validation** option is available.

- The **Advanced training setting** option is available only if the **Improve accuracy using validation** option is enabled.
- Ensure that you have the **Train groups** permission to provide information about header labels, end of table indicator, and a primary column used for row detection.
- There can be only one primary column.
- The end of table indicator is a text system-identified region (SIR).

To train a document in validator,

1. Process a document and navigate to the validation page.
2. Click **Advanced training settings**.

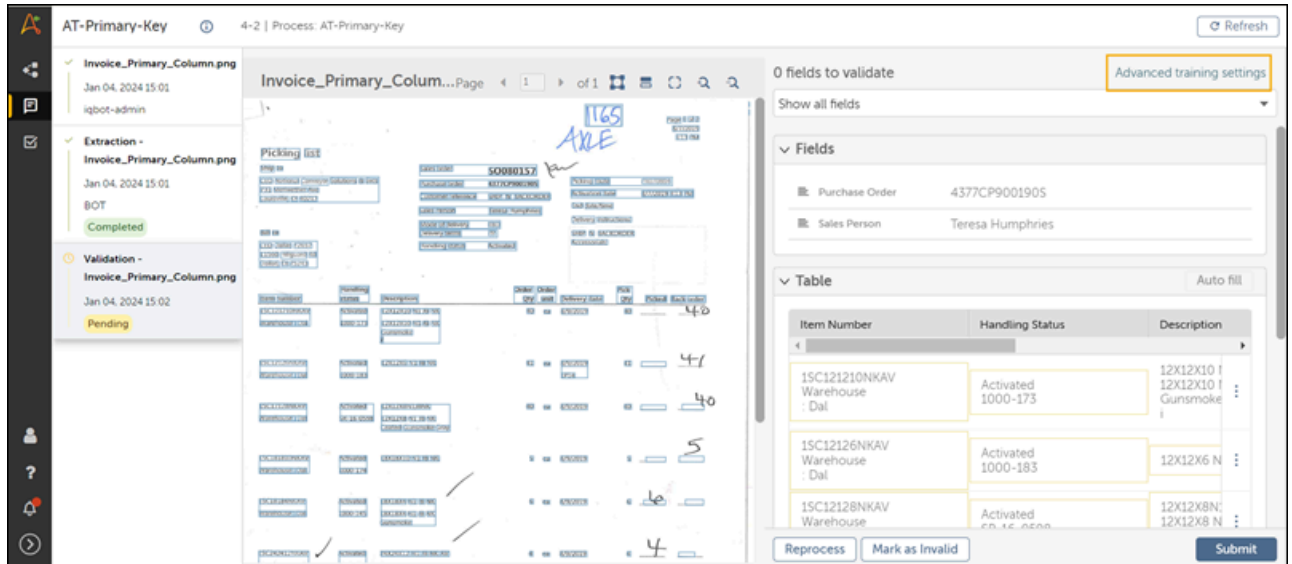

3. Train your document to set the following values:
  - a) Set the user-defined primary column for row identification.

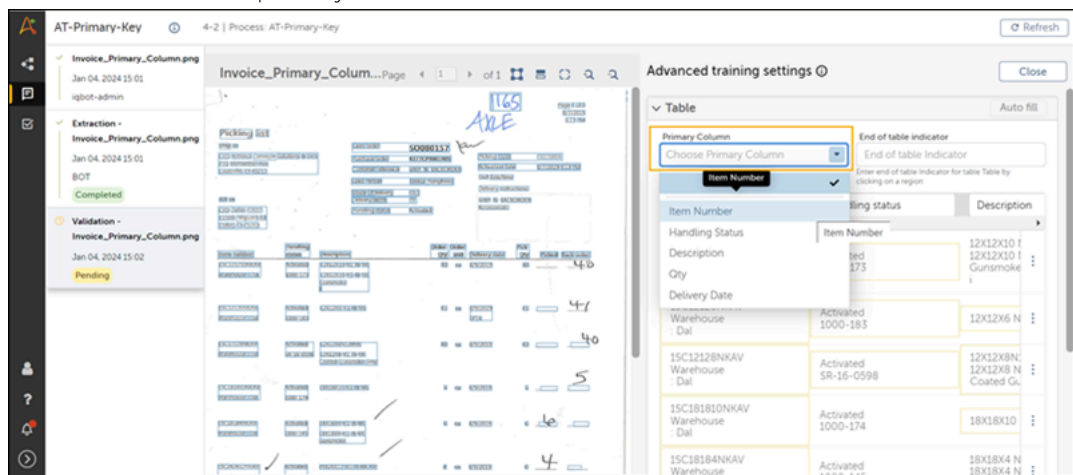

- b) Specify the end of table indicator value.

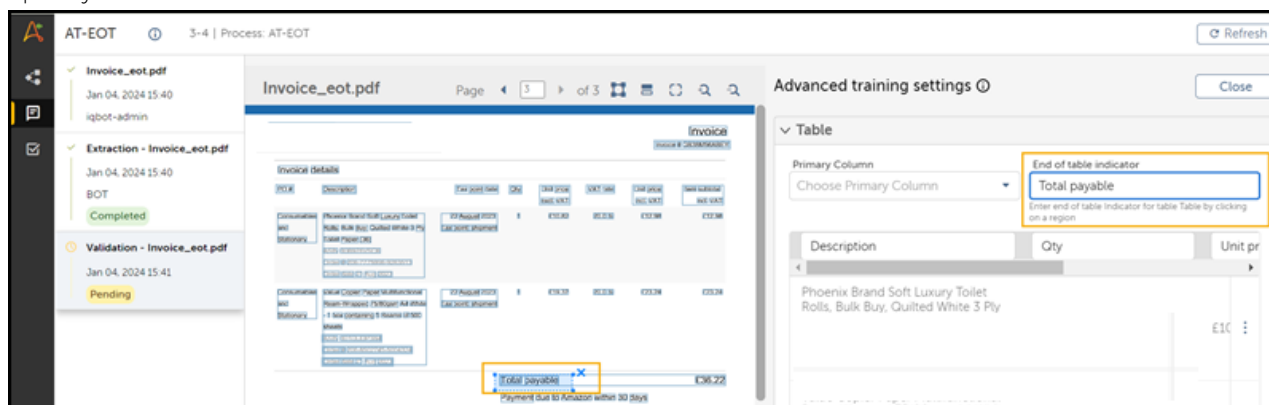

- c) Click the required column and specify the required header name.

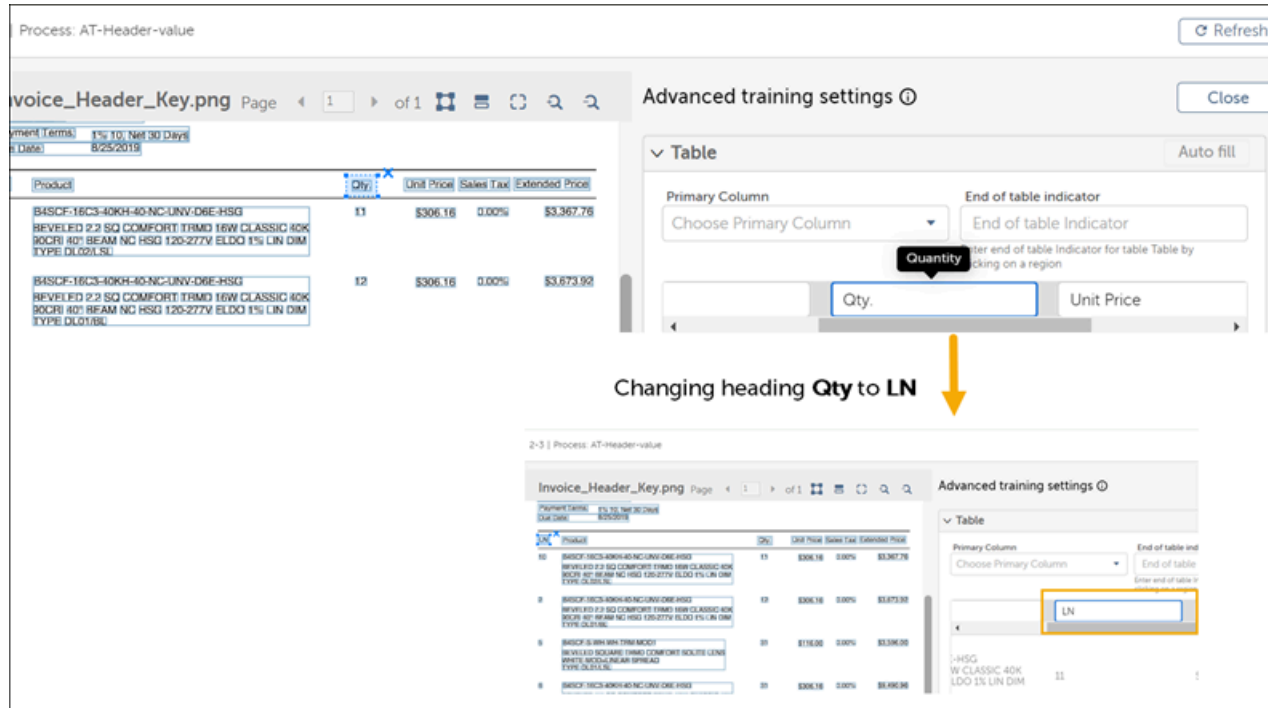

4. Click **Submit** and re-process the document.

**Note:** You must click **Submit** to save and take these settings into effect while reprocessing the document.

Based on the specified advanced training settings, the document is reprocessed and either sent to validator again to validate fields, if any or the data is extracted in the Success folder as CSV file.

The following micro-animation demonstrates an example of setting the **Item number** as primary column and extracting the data in separate row instead of single cell.

## Connect learning instance

Connect to a learning instance in Automation 360 IQ Bot to process documents in that learning instance using the Document Automation workflow.

To perform this task, you must have one of the following roles:

- **AAE\_IQ Bot Admin**
- **AAE\_IQ Bot Services**
- A custom role with the **Connect learning instance** permission

Open the Document Automation and Automation 360 IQ Bot environments on the same device.

When you connect a learning instance that was created in Automation 360 IQ Bot, the system creates learning instance assets (RPA bots, Automation Co-Pilot process, and form) to enable the learning instance to start processing documents in Document Automation.

**Note:**

- This feature is accessible only within Document Automation (not available in Community Edition). If you are an IQ Bot customer, you can use this feature within Document Automation.
- The Automation 360 IQ Bot environment must be associated with the Control Room where Document Automation is installed. In addition, Automation 360 IQ Bot must be in a version that is compatible with the Control Room.
- You can connect one learning instance at a time.

---

A connected learning instance can extract data from check boxes if your device is configured with the Microsoft Visual C++ 2019 Redistributable package: [Extracting data from check boxes](#) on page 3671

1. Login to the Control Room as the Admin user. Navigate to **Manage > Learning Instances**. Click **Connect learning instance**. This takes you to **Connect Learning Instances from IQ Bot classic page** which contains a list of Automation 360 IQ Bot learning instances.

- Select the learning instance from version Automation 360 IQ Bot to connect with. Move it from left to right. Click **Connect**.

## Connect Learning Instances from IQ Bot classic

You can edit the Learning Instance only in IQ Bot

▼

🔍

**Learning Instances (4)** (1 selected)
↻

	Name	Document type
<input checked="" type="radio"/>	multilan_extractionbot	Invoices
<input type="radio"/>	S_MS	Purchase Orders
<input type="radio"/>	Z_T1	Purchase Orders
<input type="radio"/>	INT1	Invoices

→

←

Select learning instance

Click learn left

Selected (0)

	Name
<input type="radio"/>	

The newly-connected learning instance appears in the Learning instances table in private mode.

**Note:** The value in the Provider column indicates whether a learning instance was connected from Automation 360 IQ Bot or created in Document Automation.

- For a connected learning instance, the Provider column value is User-trained.
- For a learning instance created in Document Automation, the Provider column value is Automation Anywhere (Pre-trained).

**Note:** You must maintain the Automation 360 IQ Bot server because it stores the configuration and training data for the connected learning instance.

- A connected learning instance can only be edited in Automation 360 IQ Bot. To edit the learning instance after connecting it, click the name in the Learning instances table and you will be redirected to open the learning instance in Automation 360 IQ Bot in a new window.
- To upload documents for processing, click **Process Documents**. [Process documents in Document Automation](#) on page 3648

## Extracting data from check boxes

Document Automation supports check box extraction for connected learning instances. The output varies depending on the selected data format.

A check box is a user interface object that allows you to make a binary choice - select or leave unselected. Document Automation supports extracting data from check boxes or radio buttons marked with a tick, cross, or dot. In addition to square check boxes and round radio buttons, Document Automation supports triangle and rhombus outlines.

Document Automation supports the extraction of group check boxes from connected learning instances. For more information on group check boxes, see [Extract data from check box groups in Automation 360 IQ Bot](#).

---

**Note:** To enable check box detection, you must install the Microsoft Visual C++ 2019 Redistributable package on the Bot Runner device where the documents are processed. [Download Microsoft Visual C++ Redistributable](#)

---

## How the data is output

The possible output values are Yes, No, or No Checkbox Found. The output format depends on the format you selected [Change output format from CSV to JSON](#) on page 3651.

---

**Note:** Regardless of the document language, the output values are always in English.

---

## Integrate third-party parser in learning instance

Document Automation enables you to connect to an external extraction engine using a custom Automation 360 package. You can create, customize, and connect this custom package as a parser and use it to extract documents.

The custom package leverages local engines and external services, like OpenAI, Amazon, or Google using API.

Using the third-party parser integration feature in Document Automation, you can create a custom Automation 360 package, connect it to Document Automation, and use it as a parser to process your documents. Create your own parser based on your specific use case and integrate it with the learning instance to process the documents. With the third-party parser integration in the learning instance, the associated package converts the document data into an authorized engine data format, which is sent to Document Automation for processing the documents. You can customize the fields when creating or updating the parser, viewing the added fields in the learning instance, and selecting or clearing the fields while the creating learning instance.

The following image illustrates the flow of third-party parser integration in Document

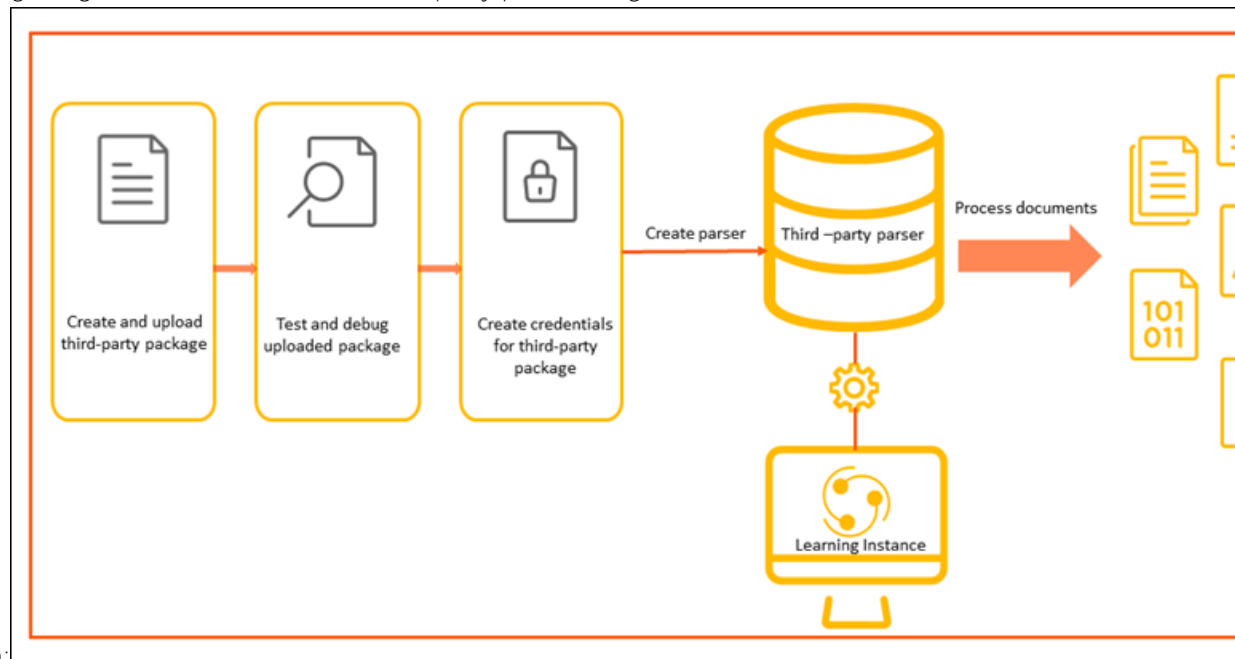

Automation:

With a third-party parser integration in Document Automation, you can:

- Leverage Automation 360 packages for enhanced document extraction
- Speed up your processing time with custom and package-driven document extraction
- Improve document parsing quality and reliability
- Improve learning instance efficiency to process more unstructured documents
- Extract documents more efficiently in less time and cost

For example, a bank employee wants to validate data in an application form for opening a new account. The existing system parser does not support a new application document type. As a result, an automation developer (Pro developer or CoE Lead) needs a third-party parser to extract document data from the new account application form. By integrating this third-party parser with the learning instance, the bank employee can use Document Automation SDK (software development kit) to extract data from the new account application form.

The following graphic illustrates the parser integration workflow for a Business User, Pro Developer, CoE Lead, and the Control Room administrators.



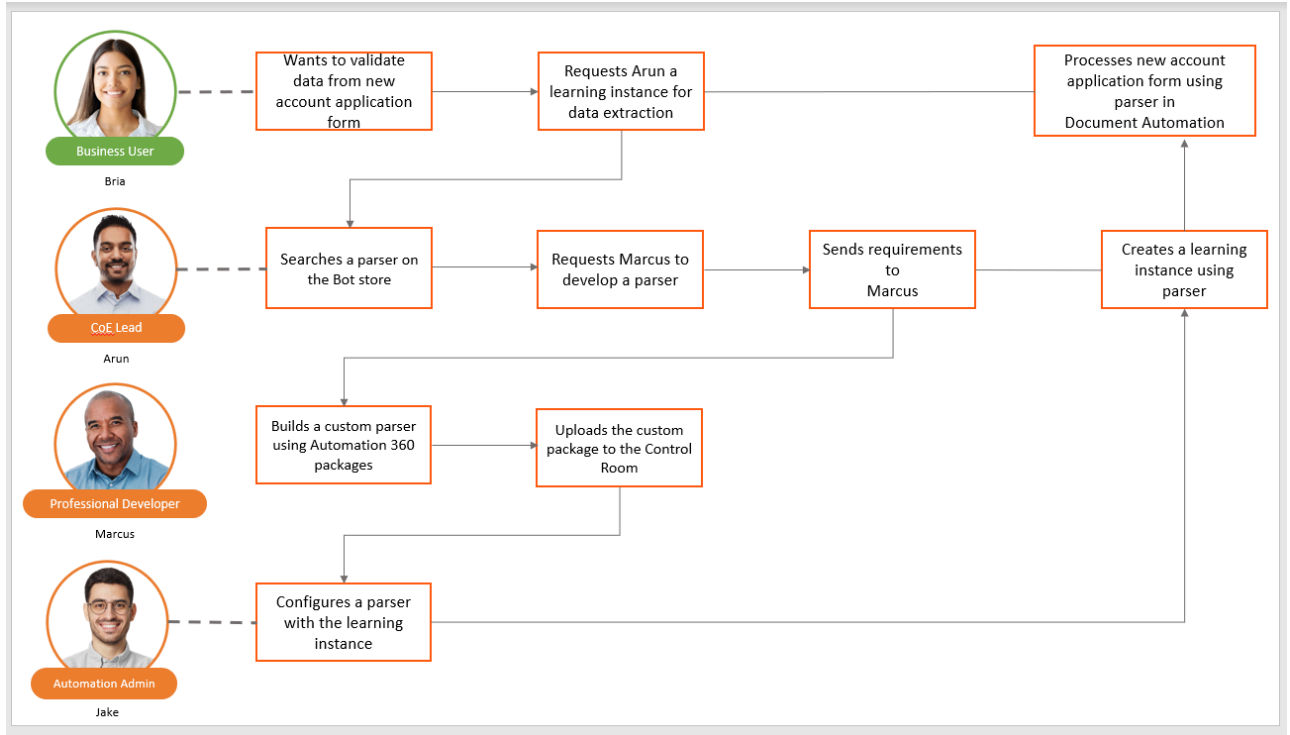

Follow these steps to integrate a third-party parser:

1. Create a custom package, upload it to the Control Room, and test the uploaded package. See [Build and test a custom package](#) on page 3575.

---

**Note:** When working with API URL trusted list for custom parsers, you must add all API end points used in the parser to the trusted list at the Bot Runner end only.

---

2. Create credential and locker in the Credential Vault. See
  - [Create credential](#) on page 1864
  - [Create locker](#) on page 1866
3. Create a parser and configure it with a learning instance in Document Automation. [Create a parser and configure with learning instance](#) on page 3673
4. Process documents with the third-party parser. [Process documents in Document Automation](#) on page 3648

## Create a parser and configure with learning instance

After creating a credential and locker for the custom package and uploading it to the Control Room, create a parser using the custom SDK and configure it with a learning instance in Document Automation.

Ensure that your custom Package you want to integrate with in Document Automation, fulfills these requirements:

- The Automation Anywhere IQ Bot Administrator role to configure the parser in Document Automation.
- A Document Workspace license to configure the parser and integrate with a learning instance.
- When you create a Package, a defined command variable with `inputFilePath` must contain the input file path.
- If the package requires credentials to connect to the external service, the variable name must be same as the attribute defined in the Credential Vault.

For example, if there is a credential in the Credential Vault with the `serviceAccount` attribute, then the variable name defined in the command must be `serviceAccount` to capture the Credential Vault key value .

Configure a third-party parser with a learning instance and use it to process documents in Document Automation.

**1.** Create a parser.

To create a parser, provide an input and output contract for the parser package that you want to integrate with Document Automation. For more details, see [Sample codes for parser contracts](#) on page 3675.

**2.** Configure a parser with a learning instance.

After creating a parser, configure it with a learning instance in Document Automation. To configure a parser,

**a)** Navigate to **Manage > Learning Instances** and click **Configure Parser**.

**b)** On the **Parser Configuration** page, click **Create Parser Configuration**.

**c)** Enter the following details for parser configuration and click **Next**.

- **Name:** Provide a parser name. The allowed limit of characters for a parser name is 50.

---

**Note:** The special characters such as " , [ \ , ? , < , > , : , \$ , | , \* , / , ] are not supported for a parser name.

---

- **Description:** This is an optional field. Enter a description.
- **Package and Version:** Select the relevant package and version from the list.
- **Provider:** Select the provider you want to use with the learning instance for document extraction.
- **Document type:** Select the document type.
- **Language:** Select language and click **Add**.
- **Credentials:** This is an optional field. For the **Credentials** field, select the **Pick a credential** option and select the locker, credential, and attribute.

**d)** Click **Browse** to upload a JSON file that contains form and table fields for the parser and click **Create**.

Following is the sample schema for a JSON file which contains fields for a parser:

```
{
  "parserFields": [
    {
      "fieldName": "invoice_number",
      "dataType": "TEXT",
      "fieldType": "KEY_VALUE"
    },
    {
```

```
"fieldName": "invoice_date",
"dataType": "DATE",
"fieldType": "KEY_VALUE"
},
{
"fieldName": "total_amount",
"dataType": "NUMBER",
"fieldType": "KEY_VALUE"
},
{
"fieldName": "total_price",
"dataType": "TEXT",
"fieldType": "TABLE_HEADER"
}
]
}
```

The required parser with the associated package SDK is created and displays in the **Parser Configuration** list.

3. Create a learning instance and integrate the configured parser with the learning instance. See [Create a learning instance in Document Automation](#) on page 3642.

The following micro-animation demonstrates how to configure a parser and integrate it with a learning instance:

Consider the following points when working with a parser (such as: create, edit, or delete a parser):

- You can edit the parser details such as parser name, parser description, and version.
- You can change the parser details such as document type, language, package name, and field names only when the parser is not used in a learning instance. However, you can add new languages and field names.
- While editing a parser, when you change the package version in the parser, it might impact the existing document extraction capability of the associated learning instance.
- If a parser is used in a learning instance, you cannot delete it until the associated learning instance is deleted.
- While integrating a parser with a learning instance, you are required to create form and table fields that map to the parser fields.
- When you migrate the learning instances, you also need to migrate the associated third-party parser configuration. If multiple learning instances with the same parser configuration are migrated, then the corresponding parser configuration is migrated only once. If a target configuration exists for the parser, the same is updated with that of the source parser configuration.

## Sample codes for parser contracts

As a CoE Lead, you must provide input and output contract for the parser package to integrate it with Document Automation.

Following are the sample codes for input and output contracts:

## Input contract

```

package aws;

import com.automationanywhere.botcommand.data.impl.StringValue;
import com.automationanywhere.commandsdk.annotations.*;
import com.automationanywhere.commandsdk.annotations.rules.LocalFile;
import com.automationanywhere.commandsdk.annotations.rules.NotEmpty;
import com.automationanywhere.commandsdk.model.AttributeType;
import com.automationanywhere.core.security.SecureString;
import static com.automationanywhere.commandsdk.model.DataType.STRING;

@BotCommand
@CommandPkg(
    name = "ExtractionCommand",
    label = "Extraction Command",
    description = "Extraction Command",
    node_label = "Extraction Command",
    return_type = STRING,
    return_label = "Extraction Command Response",
    minimum_botagent_version = "21.98",
    minimum_controlroom_version = "10520")
public class ExtractionCommand {

    @Execute
    public StringValue compute(
        @Idx(index = "1", type = AttributeType.FILE)
        @LocalFile
        @Pkg(label = "Image File Path")
        @NotEmpty
        final String inputFilePath,
        @Idx(index = "2", type = AttributeType.CREDENTIAL) @Pkg(label =
            "Service Account")
        final SecureString serviceAccount) {

        String secureString = serviceAccount.getInsecureString();

        return new StringValue("");
    }
}

```

## Output contract

The response from the command must be in JSON format with appropriate schema with which Document Automation can work. Following is the schema for JSON output generated out of the command:

```

{
  "metadata": {

```

```
"documentId": "unique Id used to Indentify document in DA",
"filepath": "Input File Path that refers to the Path used by Bot runner
during execution",
"executionStatus": {
"statusCode": "Status code which indicates the response post
extraction",
"statusMessage": "status message which indicates the response post
extraction ",
"message": "Message that details the result"
},
"timeInMs": "Time taken in ms to process the entire document",
"clusterId": "unique Id used to capture Heuristic feedback",
"numberOfPages": "Number pages in the document"
},
"imagePreprocessingResult": {
"metadata": {
"documentId": "unique Id used to Indentify document in DA",
"filepath": "Input File Path that refers to the Path used by Bot runner
during execution",
"executionStatus": {
"statusCode": "Status code which indicates the response post
extraction",
"statusMessage": "status message which indicates the response post
extraction ",
"message": "Message that details the result"
},
"timeInMs": "Time taken in ms to process the entire document"
},
"pages": [
{
"filepath": "File Path that refers to the Page in the document post
splitting the document into pages",
"deskew": true,
"orientation": true,
"renderDpi": 0,
"width": "width of the Page",
"height": "height of the Page"
}
]
},
"ocrResult": {
"metadata": {
"executionStatus": {
"statusCode": "Status code which indicates the response post
extraction",
"statusMessage": "status message which indicates the response post
extraction ",
"message": "Message that details the result"
},
"numberOfPages": "Number pages in the document",
"learningInstanceSetting": {
"provider": "Name of the provider",
"version": "Provider Version",
"langCodes": [
"Language code in DA"
]
},
"timeInMs": "time taken in ms to get the OCR result for the document",
"pages": [
{
"id": "unquie Id to indetify the page in the document",
```

```
"pageNum": "Page number in the document",
"filepath": "File Path that refers to the Page in the document post
splitting the document into pages",
"langCode": "Code that refers to the language in DA"
}
],
},
"blocks": [
{
"id": "Block Id of the word segment",
"geometry": {
"x1": "x1 axis of the bounding box rectangle",
"y1": "y1 axis of the bounding box rectangle",
"x2": "x2 axis of the bounding box rectangle",
"y2": "y3 axis of the bounding box rectangle"
},
"text": "text from the segment",
"blockType": "Type of the Block.
Possible options :
WORD/LINE/INFO_BLOCK/KEY_VAL_BLOCK/TABLE/TABLE_HEADER
/TABLE_HEADER_ELEM/COLUMN/KEY_INFO_BLOCK/NO_OBJECT",
"pageNum": "Page number in the document",
"confidence": "OCR Confidence"
}
],
},
"docDetectResult": {
"metadata": {
"executionStatus": {
"statusCode": "Status code which indicates the response post
extraction",
"statusMessage": "status message which indicates the response post
extraction ",
"message": "Message that details the result"
},
"timeInMs": "Time taken in ms to process the entire document"
},
"featureObjects": [
{
"id": "Feature object UUID",
"blockType": "INFO_BLOCK",
"geometry": {
"x1": "x1 axis of the bounding box rectangle",
"y1": "y1 axis of the bounding box rectangle",
"x2": "x2 axis of the bounding box rectangle",
"y2": "y3 axis of the bounding box rectangle"
},
"text": "Feature object Text",
"confidence": "confidence",
"ocrConfidence": "OCR Confidence ",
"pageNum": "Page number in the document"
}
],
},
"extractionResult": {
"metadata": {
"filepath": "Input File Path that refers to the Path used by Bot runner
during execution",
"executionStatus": {
"statusCode": "Status code which indicates the response post
extraction",
```

```

"statusMessage": "status message which indicates the response post
extraction ",
"message": "Message that details the result"
},
"timeInMs": "Time taken in ms to process the entire document",
"pages": [
{
"unique Id to identify the page in the document",
"pageNum": "Page number in the document",
"filepath": "File Path that refers to the Page in the document post
splitting the document into pages",
"width": "width of the Page",
"height": "height of the Page"
"langCode": "Code that refers to the language in DA"
}
]
},
"keyValueFeatures": [
{
"unique Id to identify the keyValue found in the document",
"domainFieldKey": "field that needs to be extracted",
"geometry": {
"x1": "x1 axis of the bounding box rectangle",
"y1": "y1 axis of the bounding box rectangle",
"x2": "x2 axis of the bounding box rectangle",
"y2": "y3 axis of the bounding box rectangle"
},
"text": "text from the segment",
"pageNum": "Page number in the document",
"ocrConfidence": 0.909,
"extractionScore": "OCR Confidence",
"key": {
"unique Id to identify the key found in the document",
"text": "text from the segment",
"geometry": {
"x1": "x1 axis of the bounding box rectangle",
"y1": "y1 axis of the bounding box rectangle",
"x2": "x2 axis of the bounding box rectangle",
"y2": "y3 axis of the bounding box rectangle"
},
"extractionScore": "Extraction score"
},
"value": {
"unique Id to identify the value found in the document",
"text": "text from the segment",
"geometry": {
"x1": "x1 axis of the bounding box rectangle",
"y1": "y1 axis of the bounding box rectangle",
"x2": "x2 axis of the bounding box rectangle",
"y2": "y3 axis of the bounding box rectangle"
},
"extractionScore": "Extraction score"
},
"extractedDataType": "Data type of the extracted field"
}
],
"tableFeatures": [
{
"unique Id to identify the table in the document",
"headers": [
{

```

```

"id": "unique Id to indentify the header column in the document",
"domainFieldKey": "header field that needs to be extracted",
"geometry": {
"x1": "x1 axis of the bounding box rectangle",
"y1": "y1 axis of the bounding box rectangle",
"x2": "x2 axis of the bounding box rectangle",
"y2": "y3 axis of the bounding box rectangle"
},
"text": "text from the segment",
"pageNum": "Page number in the document",
"ocrConfidence": "OCR Confidence",
"extractionScore": "Extraction score",
}
],
"rows": [
{
"id": "unique Id to indentify the row in the table",
"geometry": {
"x1": "x1 axis of the bounding box rectangle",
"y1": "y1 axis of the bounding box rectangle",
"x2": "x2 axis of the bounding box rectangle",
"y2": "y3 axis of the bounding box rectangle"
},
"cells": [
{
"id": "unique Id to indentify the cell in the row",
"geometry": {
"x1": "x1 axis of the bounding box rectangle",
"y1": "y1 axis of the bounding box rectangle",
"x2": "x2 axis of the bounding box rectangle",
"y2": "y3 axis of the bounding box rectangle"
},
"domainFieldKey": "column field that needs to be extracted",
"text": "text from the segment",
"pageNum": "Page number in the document",
"extractedDataType": "TEXT",
"ocrConfidence": "OCR Confidence",
"extractionScore": "Extraction score",
}
],
"pageNum": 1
}
]
}
]
}
}
}

```

## Publish the learning instance to production

Check-in the process associated with the learning instance. Then, build a bot that uploads documents from a source folder to the learning instance and check it in to the public repository. Finally, deploy the process and bots to unattended Bot Runner devices to begin processing documents in real time.

For Bot Runner devices with a Windows 2012 server-based operating system:

1. Download and install the Windows Essential Media Pack from Microsoft.



2. Install the Media Foundation feature from the Windows Server Manager.
1. Publish the process.
    - a) Navigate to **Automation > Private tab > Bots > Document Workspace processes** and select the folder with the same name as the learning instance.
    - b) Mouse over the vertical ellipses to the right of the process to open the actions menu and click **Check in process**.  
The **Check in Process** window opens with the bots and form auto-selected to also be checked in.
    - c) In the **Check in Process** window, add your comment and click **Check in**.  
The process appears in the same folder structure in the public workspace.

See these steps in a video:

---

**Note:** The **Private** mode is used for testing in a controlled environment and cannot be viewed by other users. The **Public** mode is used when the bot is production-ready, allowing it to be viewed and accessed by others based on permissions set by the administrator.

---

2. Build the **Extraction-Scheduler** bot to automate uploading documents to the learning instance: [Build a bot to upload documents to Document Automation](#) on page 3682
3. Publish the **Extraction-Scheduler** bot.
  - a) Locate the **Extraction-Scheduler** bot in the private tab.
  - b) Mouse over the triple ellipses to the right of the bot to open the menu and click **Check in Task**

Private bots and files cannot be viewed by other people. If a bot or file has been checked out from the Public tab, it can be viewed and run by other people, but cannot be edited.

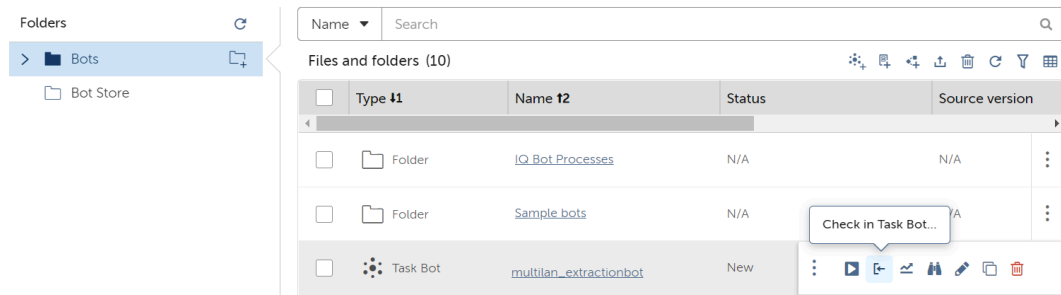

**bot.**

The **Check in Task bot** page opens with the bot auto-selected.

- c) Add a comment and click **Check in**.
4. Login as the **Document Automation Admin** user to deploy the process and bots to unattended Bot Runner devices: [Deploy the learning instance assets](#) on page 3687

Once the process and **Extraction-Scheduler** bot are deployed, documents in the specified folder are uploaded to Document Automation, and Document Automation either extracts data from the documents or sends the documents for validation.

Navigate to **Activity > In progress** to see the status of the running bots.

## Build a bot to upload documents to Document Automation

Build a bot to upload documents to a specific learning instance for processing and extraction.

- Ensure you have the name of the destination learning instance.
- If you have an adequate amount of Bot Runners connected. For instructions on connecting a Bot Runner, see step 5 of [Set up your Document Automation environment](#) on page 3636.

---

**Note:** You need a dedicated Bot Runner for this bot and additional Bot Runners for the extraction and download bots, depending on the average number of pages in the documents. Review the explanation below for more guidance on how many Bot Runners are needed.

---

- Decide on the scheduling interval for deploying this bot with a maximum interval of every thirty minutes.
- Determine the average number of pages in the documents awaiting upload.

This bot is necessary for end-to-end automation of the document extraction process. When deployed, the bot checks if there are enough Bot Runners to handle the documents, by comparing the number of files already uploaded against a calculated value. The calculation considers the number of Bot Runners, scheduling interval, and average number of pages in the documents.

---

**Note:** This step is important as it controls the number of documents being uploaded to ensure smooth processing and avoid overloading the Bot Runners, which might cause a time-out error.

---

To determine the number of Bot Runners needed, consider the following:

- One Bot Runner can process a single-page document in one minute.
- One Bot Runner can process a two-page documents in two minutes.
- One Bot Runner can process 1440 single-page documents in one day.
- Two Bot Runners can process two single-page documents in one minute.

Use this equation to determine how many Bot Runners are needed:

$$\text{Number of Documents to Process per day} * \text{Average Number of Pages per document} / 1440 = \text{Number of Bot Runners}$$

---

**Note:** If the equation result is not an integer, you must round up to the next whole number to obtain an adequate number of Bot Runners. For example, if the equation result is 4.2, you will need 5 Bot Runners.

---

To learn more, search for the Document Automation Developer course in [Automation Anywhere University: RPA Training and Certification \(A-People login required\)](#).

As an example, if you want to process 10,000 documents each day with an average of one page per document, you need seven Bot Runners:

$$10,000 \text{ documents} * 1 \text{ page per document} / 1440 = 7 \text{ Bot Runners}$$

To build the bot, follow these steps:

1. Navigate to **Automation > Private tab** and click **Create a bot**.  
Ensure you do not place the bot in the **Document Workspace** folder.

2. Provide a name for the bot, such as `Extraction-Scheduler`.
3. Create the following variables: [Create a variable](#) on page 2336

Variable name	Description	Data type	Value
<code>File_Count</code>	Increments with each loop iteration to count the number of files uploaded for processing.	Number	0
<code>Extraction_DeviceNumber</code>	Number of Bot Runner devices connected to the Control Room	Number	Enter the number of connected Bot Runner devices
<code>Scheduler_Interval</code>	Scheduling interval in minutes	Number	Enter the interval for which you will schedule this bot to run when you deploy it (minimum 2 min,maximum 30 min)
<code>Average_Pages</code>	Average number of pages per document		Enter the approximate average number of pages in the documents
<code>FilesInFolder</code>	Holds file name and extension	Dictionary	--
<code>SourcePath</code>	File path to the folder containing documents awaiting upload to Document Automation	String	Enter the file path
<code>OutputPath</code>	File path to the folder containing the extracted data and invalid or failed documents	String	Enter the file path where you want the extraction output

4. Insert a **Loop** action to iterate through all the documents in a specific file path.
  - a) Double-click or drag the **Loop** action.
  - b) Select the **For each file in folder** iterator.
  - c) Insert the `SourcePath` variable into the **Folder path** field.
  - d) Insert the `FilesInFolder` variable into the **Assign file name and extension to this variable** field.

5. Insert an **If** action to compare the number of documents uploaded for processing to the number of Bot Runner devices multiplied by a scheduling interval and divided by the average number of pages.

---

**Note:** You must include this equation to limit the number of files uploaded for processing at one time to ensure that the Bot Runners are able to process the documents.

---

- a) Drag the **If** action into the **Loop** container.
  - b) Select the **Number** condition.
  - c) Insert the `File_Count` variable into the **Source value** field.
  - d) Select the **Less than** operator.
  - e) Enter the following into the **Target value** field:  $\$Extraction\_DeviceCount\$ * \$Scheduler\_Interval\$ / \$Average\_Pages\$$
6. Insert **If: Else** and **Loop: Break** actions to end the loop if the condition is not met:
    - a) Drag the **If: Else** action beside the **If** action in the **Loop** container.
    - b) Drag the **Loop: Break** action into the **If: Else** container.
  7. Insert an error handling mechanism to log any possible errors:
    - a) Drag the **Error handler: Try** action into the **If** container.
    - b) Drag the **Error handler: Catch** action beside the **Error handler: Try** action.
    - c) Drag a **Delay** action below the **Error handler: Catch** action.
    - d) Set a delay of 10 seconds.
  8. Configure actions to upload documents to the process associated with a specific learning instance.
    - a) Drag the **Process Composer: Create a request** action below the **Error handler: Try** action.

---

**Note:** You are pointing to a public process path that Document Automation creates automatically. For example, see the following image:

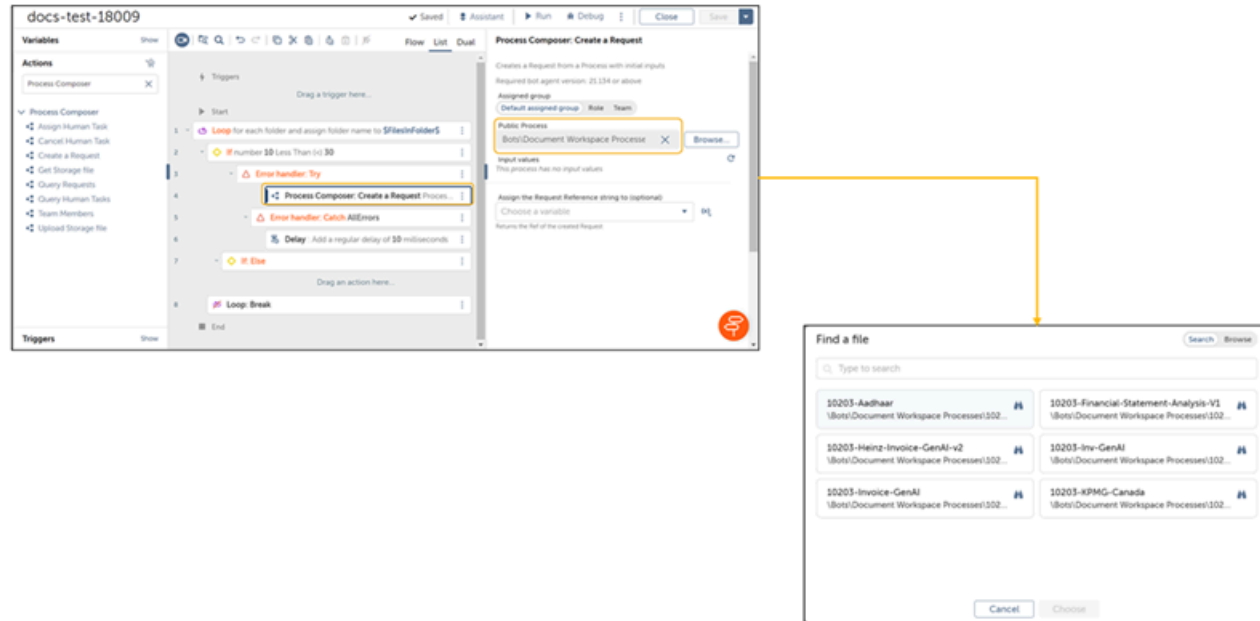

- b) Mark the **Set LearningInstanceName** option and provide the name of the learning instance where to send the documents.
  - c) Mark the **Set InputFile** option and enter `$SourcePath$/ $FilesInFolder {name}$. $FilesInFolder {extension}$.`
  - d) Mark the **Set InputFileName** option and enter `$FilesInFolder {name}$. $FilesInFolder {extension}$.`
  - e) Mark the **Set OutputFolder** option and enter `$OutputPath$.`
  - f) Drag the **Number: Increment** action below the **Process Composer: Create a request** action.
  - g) Insert the `File_Count` variable into the **Number** and **Assign output to variable** fields. The **Number** action increases the value of `File_Count` by one each time a file is uploaded to the learning instance. As long as the value in `File_Count` is less than the total in the equation you entered in step 5, the bot can run another loop iteration to upload another document to the learning instance.
9. Make a copy of the uploaded file to a different location on your desktop to keep track of which documents were successfully uploaded:
    - a) Drag the **File: Copy Desktop file** action below the **Number: Increment** action.
    - b) Enter `$SourcePath$/ $FilesInFolder {name}$. $FilesInFolder {extension}$.` in the **Source file** field.
    - c) Provide the folder path where to copy the files.
  10. Remove documents after they are uploaded to Document Automation so they do not get re-uploaded in the next iteration:
    - a) Drag the **File: Delete** action.
    - b) Enter `$SourcePath$/ $FilesInFolder {name}$. $FilesInFolder {extension}$.` in the **File** field.

11. Click **Save**.

The completed bot should resemble the one in the image below:

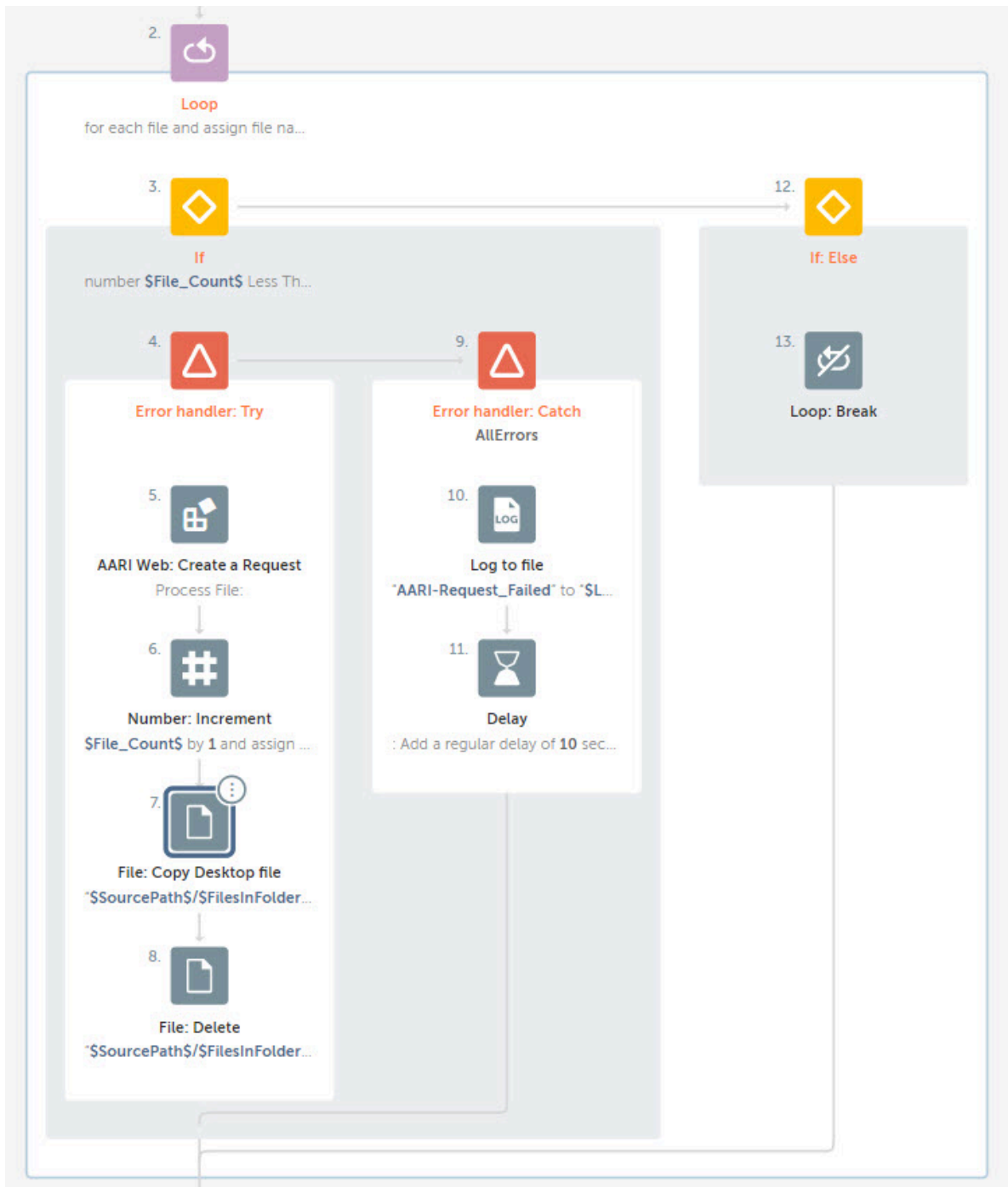

Publish the process and bot. See step 3 of [Publish the learning instance to production](#) on page 3680

## Deploy the learning instance assets

Deploy the process and RPA bots to the unattended Bot Runner devices, and assign the learning instance to a validation team. Here, you configure the learning instance assets to process documents in real time.

- The user who created the learning instance assets must check-in the process, form, and bots to the public repository. If you have not done so already, complete steps 1 and 2 of [Publish the learning instance to production](#) on page 3680.
- To deploy the learning instance assets, you must be an Admin user. See [Document Automation users](#) on page 3638.

### 1. Assign the a team of Validators to the process:.

- a) Open Automation Co-Pilot by appending `/aari` to the Control Room URL.
- b) Navigate to **Manage > Process** and locate the process with the same name as the learning instance.
- c) Click the process to assign it to a team.
- d) Navigate to the **Request Creation** section and select the **by Bot** option.
- e) Navigate to the **Teams** tab and click the **Add** icon on the left side.
- f) Select the team and click **Add and save**.

### 2. Deploy the `Extraction-Scheduler` bot

See these steps in a video:

- a) Return to the Control Room by removing `/aari` from the Control Room URL.
- b) Navigate to **Automation > Public tab** and locate the `Extraction-Scheduler` bot.
- c) Follow the steps to [Schedule a bot](#) on page 2129.
  - At the scheduling details section, select **Run repeatedly**.
  - Select the **Repeat every** option to schedule the bot on a recurring basis.

When you provide the desired interval and frequency, ensure that the interval matches the value in the `Scheduler_Interval` variable in the `Extraction-Scheduler` bot.

---

**Note:** If you are scheduling the bot to run starting today, you must repeat the steps two times to schedule the bot as follows:

- Schedule the bot with the desired start time for today, with an end time of 11:59pm on the same day.
- Schedule the bot to start tomorrow at 12:00am, with an end time of 11:59 on a future date.

---

**Important:** If you do not follow this guidance, the bot will start running each day at the time you provided in the **Start time** field, instead of being scheduled to run for 24 hours of each day.

---

- When selecting a Bot Runner, deploy the `Extraction-Scheduler` bot to a different Bot Runner than the one running the process.

**Note:** A Bot Runner can run only one bot at a time. Ensure that you use separate Bot Runners for the process and the `Extraction-Scheduler` bot, so that the `Extraction-Scheduler` bot does not interfere with the `Extraction` and `Download` bots.

---

Once the process and `Extraction-Scheduler` bot are deployed, documents in the specified folder are uploaded to Document Automation, and Document Automation either extracts data from the documents or sends the documents for validation.

Navigate to **Activity > In progress** to see the status of the running bots.

## Using the Automation Co-Pilot Task Manager Validator for Document Automation

Document Automation uses Automation Co-Pilot for Business Users technology to manage the end-to-end document extraction process. Each incoming document creates a new request, which triggers the extraction process. If a document requires manual validation, Automation Co-Pilot creates a validation task and assigns it to a validation team.

When you click the **Validate documents** link in the Learning instances page, the Automation Co-Pilot Task Manager opens in a new tab, with the first failed document in queue.

---

**Note:** An empty page with a notification message appears in the following scenarios:

- If you are not assigned to any validation teams, and thus do not have access to learning instances.
  - If there are no files that require validation in the learning instances to which you have access.
  - If another user is working on the remaining file in the validation queue.
-



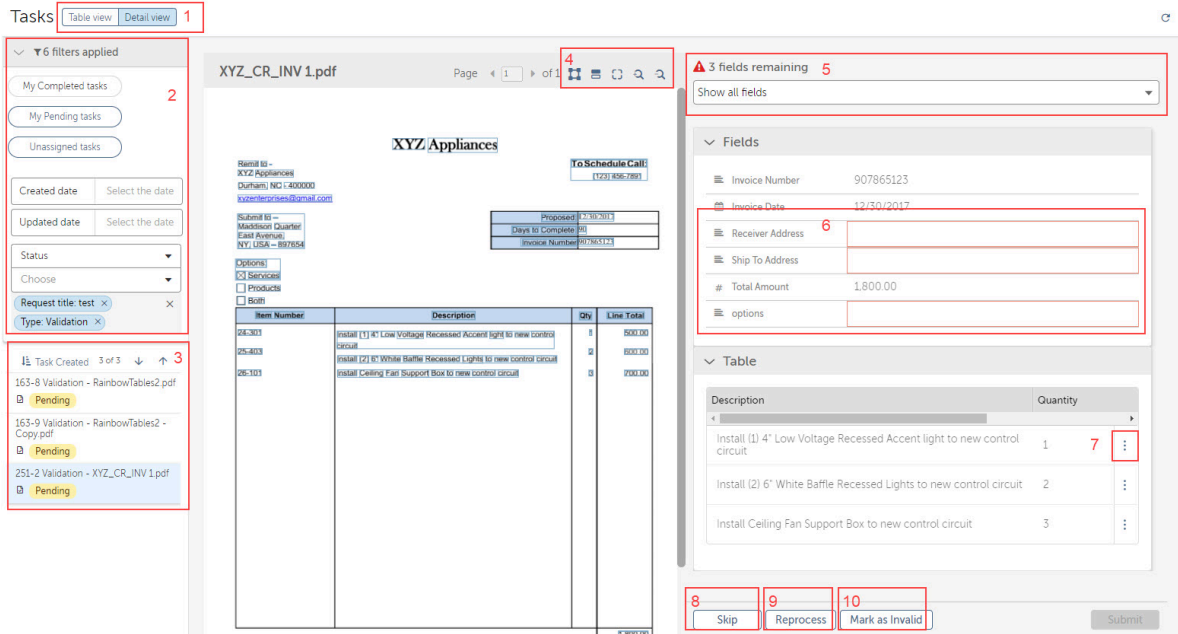

1. You can toggle between the Table and Detail views

Detail view: We recommend that you perform validation tasks in the **Detail** view because this view shows all the documents in the validation queue side by side with the document that you are currently validating. Additionally, when you finish validating a document, the next document in the queue automatically opens.

**Note:** You can search for specific documents (tasks) in **Detail** view only.

2. Filter the documents in your queue

Table view: Use the **Table** view see learning instance history. When you open a document from this view, the history for the learning instance that is processing this document appears in a pane on the left. Click the empty text field, then select the blue-bounded box in the document that contains the data to extract. After you select a box, the data is highlighted in yellow and a green outline appears, which you can resize or reposition to include all the data that you want to extract.

3. Your documents queue

The Validator opens with certain filters enabled by default to show only the documents from a specific learning instance that need validation.

The documents that match the parameters you specified in the filters pane appear here.

You can switch between documents in the queue without completing validation for the current document.

- |   |   |
|---|---|
| 4. Customize your view                            | Use the icons in the taskbar to hide the blue-bounded system identified regions, stack the document pane above the fields pane, or change the zoom levels.  |
| 5. Toggle between the fields views                | Use the drop-down list to select between <b>Show all fields</b> to see all the document fields or <b>Show fields that need validation</b> to only show the fields that need your manual validation.   |
| 6. Fields awaiting validation are outlined in red | In the example above, the table fields <b>Item total</b> and <b>Quantity</b> require manual entry.  |
| 7. Add or delete a row                            | To insert or delete a row, hover over the ellipses to show the icons for adding or deleting table rows.   |
| 8. Skip to next file                              | Skip a file without correcting the errors in the current document.  |
| 9. Reprocess                                      | If the learning instance is edited while documents are awaiting validation, you must Reprocess the documents.   |
| 10. Mark document as invalid                      | Removes the document from the validation queue and saves a copy of the document to the Invalid folder. Click here to mark a document as invalid, then select from the following reasons: <ul style="list-style-type: none"><li>• Fields missing</li><li>• Tables missing</li><li>• Wrong values</li></ul> |

For documents processed in a connected learning instance:

The Validator shows the group number for the document. If you are unsatisfied with the extraction results, you can retrain the learning instance in Automation 360 IQ Bot.

## Validate documents in Document Automation

If a learning instance cannot extract data from a document (for example, blurry text, data does not match data type, or data is missing for a required field), it sends that document to the validation queue, where the `validator` user manually provides the data.

The learning instance assets must be checked-in to the public repository.

The Validator is comprised of two panels with the document on the left side and the fields with extracted data on the right side.

In a window that is 1280 pixels or more, the panels are positioned side-by-side. Otherwise, the panel containing the fields and extracted data shifts below the panel containing the document, as demonstrated in this video:

**Note:** If a document contains tables with large number of rows or data fields (>1000), there might be a delay in the initial validation and the corresponding response time.

---

1. Log in as the `Validator` user.
2. From the Control Room home page, navigate to **Manage > Learning Instances**.  
The Learning instances table displays details for each instance. The value in the **Validate documents** link indicates the number of documents awaiting manual validation.
3. Click **Validate documents**.  
The Automation Co-Pilot Task Manager opens in a new tab, with the first failed document in queue. For an introduction to the Validator user interface, see [Using the Automation Co-Pilot Task Manager Validator for Document Automation](#) on page 3688.
4. Provide correct values to the fields that need validation.  
See these steps in a video:
  - a) Select **Show fields that need validation** from the drop-down list in the right panel.
  - b) Click the field to extract.
  - c) In the document image, click the blue-bounded box containing the correct data or draw a box around the data you want to extract.
    - To skip a document without correcting its errors, click **Skip** to proceed to the next document in the validation queue.
    - To remove a document that cannot be processed, click **Mark as Invalid**.
5. After you make the necessary corrections, click **Submit** so the document can be processed and the extracted data downloaded.  
The extracted values are saved to a file in the Success folder. The Validator shows the next document in queue. When all documents are corrected, the system displays a message stating that there are no more tasks available.

## Export/Import learning instances

A user with the `IQ Bot Admin` role or with the `View and manage migration` permission can use the **Export** and **Import** buttons to move learning instances between Document Automation environments.

### Export a learning instance

When you export a learning instance, a `.dw` file is downloaded to your desktop with the learning instance configurations, including the language, provider, and fields.

To export a learning instance,

1. Navigate to **Manage > Learning Instances**
2. Hover over the vertical ellipses to the right of the learning instance you want to export.
3. Click **Export**.

A Control Room notification (link) displays to indicate that the learning instance is exported successfully.

4. Click the Control Room notification link and download the .dw file to your local desktop.

---

**Note:** The process and bots associated with the learning instance are exported separately: [Export a process automation](#) on page 3489 | [Export bots](#) on page 2033

---

## Import a learning instance

First, import the process and bots associated with the learning instance: [Import a process automation](#) on page 3486. If you do not import the process, Document Automation will create a new process when you import the learning instance.

---

### Note:

- Verify that the destination environment has the necessary licenses. See [Automation 360 licenses](#) on page 1407
- If a previous version of the learning instance already exists in the Control Room, only the user who imported that learning instance can import a new version.

---

To import a learning instance:

1. Navigate to **Manage > Learning Instances** and click **Import** at the top of the page.
2. Click **Browse** to select the learning instance.

---

**Note:** If there is already a learning instance in this environment with the same ID number, the imported learning instance overwrites the existing one.

---

3. Select whether to pair the learning instance with an existing process or to create a new process.

## Incorporating validation feedback in export/import of learning instances

You can use Export and Import with enhanced feature that enables you to export and import learning instances while retaining the pre-training information. This enhancement empowers users to leverage pre-trained learning instances across different environments

### Validation feedback during export

To export a learning instance, navigate to **Manage > Learning Instances** and mouse over the vertical ellipses to the right of the learning instance you want to export. Then, click **Export**

1. When you **Export** the learning instance, a pop-up window appears (**Do you want to include validation feedback**).

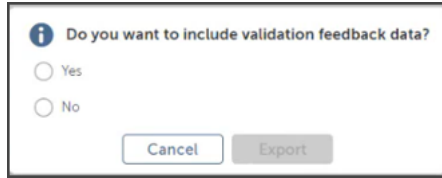

2. If you select **Yes**, the validation feedback will be saved as part of the learning instance with a notification displaying **Export process successfully started**.

---

**Note:** Once the export process is initiated, you can track the progress in the **Notifications** window. Notifications are available to keep you informed about the successful export.

---

3. If the learning instance `test` file is exported successfully, click the file to download it in `.dw` format .

The information saved in these learning instances can contain various training sessions along with their corresponding feedback files. This enables you to transfer it to another instance and perform an **Import**.

### Validation feedback during import

When you **Import** the file, a pop-up window appears **How do you want to update this learning instance?** which has three options to select from:

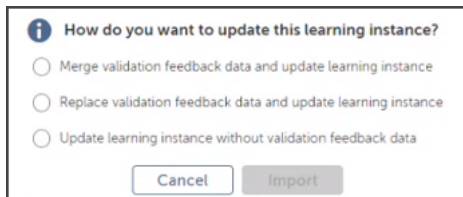

- **Merge validation feedback**
- **Replace validation feedback**
- **Update learning instance without validation feedback data**

Once the import process is initiated, you can track the progress in the **Notifications** window.

## Create custom models in Document Automation using Standard Forms

Standard Forms are fixed format document types that have a defined template, with little or no variation in the overall layout, and are typically official or legal forms, such as a W-4 (Employee Withholding Certificate) form, income tax form, or a sale deed.

See the following video on how Microsoft Standard Forms integrates with Document Automation and its enhanced processing capabilities.

With enhanced accuracy, this feature enables you to extract data from densely structured forms including those with handwritten input in the following languages: English, Dutch, French, German, Italian, Portuguese, and Spanish.

The following overview provides an end-to-end process you can use to create the Standard Forms data model, configure the learning instance, and publish the learning instance to process documents autonomously, all within the Document Automation interface.

---

**Note:** Set up your Document Automation environment, which includes configuring users, roles, and devices, and connecting the Control Room with the Automation Co-Pilot for Business Users: [Set up your Document Automation environment](#) on page 3636.

---

1. Evaluate your use case for Standard Forms.  
[Evaluate your use case](#) on page 3694
2. Review extraction service.  
[Review extraction service](#)
3. Set up and configure an extraction service.  
[Set up extraction service](#) on page 3697
4. Configure Document Automation for the selected extraction service.  
[Configure Document Automation with Microsoft Azure Form Recognizer](#) on page 3697
5. Build a data extraction model.  
[Create a custom extraction model using Standard Forms](#)
6. Create a learning instance with the Standard Forms data model.  
[Create a learning instance for standard forms](#) on page 3701
7. Upload documents to the learning instance to test the model, fix validation errors, and verify the extracted data.  
[Process documents](#)
8. Build a bot that uploads documents from a source folder to Document Automation.  
[Build a bot to upload documents to Document Automation](#) on page 3682
9. Transfer the Standard Forms learning instance across different Document Automation environments.  
[Transfer standard forms learning instance](#) on page 3703
10. Check the learning instance assets (process, form, and bots) into the public repository. Then, deploy the process and bots to unattended Bot Runner devices to begin processing documents in real time.  
[Publish the learning instance to production](#) on page 3680
11. Validate the processed documents for the Standard Forms learning instance.  
[Validate the uploaded documents](#)

## Evaluate your use case

Before processing documents in Document Automation, you must ensure that your documents are Standard Forms. After you confirm that your document meets the prescribed Standard Forms criteria, you can proceed with the type of extraction service required.

To determine if your use case meets the Standard Forms criteria, review the following parameters:

- The layout of your document remains the same across vendors.
- The positions of various data elements such as checkboxes, tables, and so on, is fixed in your documents.
- You have documents where the values are independent of other data elements.
- Your document is available in a supported language. For more information, see [Azure Form Recognizer Supported Languages](#).
- Your documents contain tables that have the same number of rows and columns.
- The document layout remains the same within the same year, across different organizations.

## Review extraction service

After you have confirmed that the documents are Standard Forms, you can then plan the type of standard forms extraction service that fits your requirement. You can use the Microsoft Form Recognizer service to process Standard Forms in Document Automation. Before processing, ensure the following:

- Input documents can contain:
  - Information with many details and have a reasonable quality resolution (>200 dpi)
  - Check-boxes and radio buttons
  - Handwritten content
  - Signatures
  - Tables

---

**Note:** Input documents can also contain tables that span over a single page. However, if the Standard Forms contain table that spans across multiple pages, the content extraction can fail.

---

- No section of the input document is repeated.
- Documents that contain transpose tables.

## Benefits of Microsoft Azure Forms Recognizer service

- Ability to process diverse standard form type documents.
- Auto detection feature can identify different types of tables, such as header-less tables, inverted tables, and so on.
- Provides good support for handwritten forms.

## Data Flow for Standard Forms in Document Automation

The following data flow diagram shows how to configure Standard Forms in Document Automation using various components that facilitate the flow of data between Document Automation and the third-party extraction service.

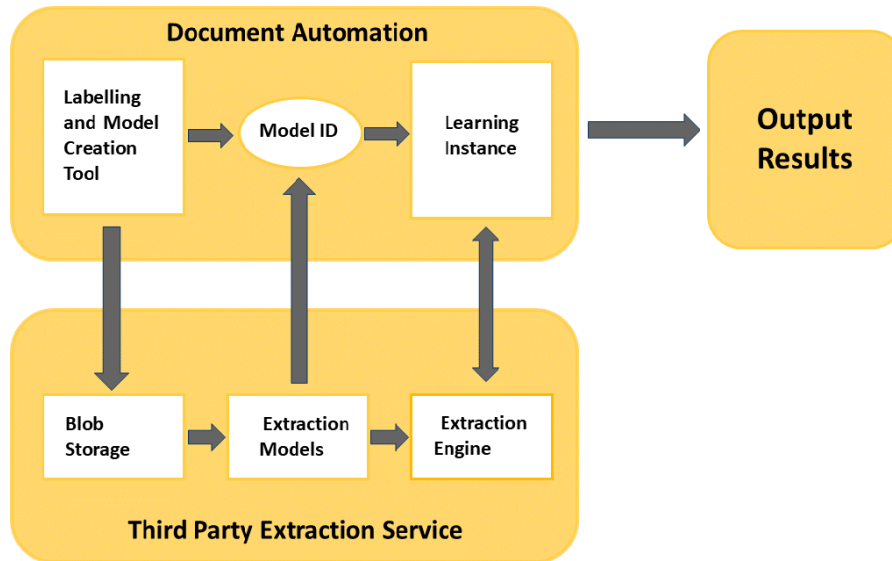

- Labeling and model creation tool

You use the model creation tool to label and create models. In this diagram, the training documents are uploaded in the tool and stored in the blob storage of the third-party service. To obtain the best results, we recommend that you upload and label a minimum of five training documents to create a model.

- Blob storage

Blob storage is a storage unit that contains training documents and its related information.

- Extraction model

The trained models stored in the blob storage of the third-party service are fetched through APIs. The Model ID, which can be a GUI ID or a standard name, is used to create the learning instance.

- Learning instance creation

You can browse and select the model to create a Learning instance. After you select the model, you can upload a document for extraction to this Learning instance. The Learning instance accesses the third-party extraction service to retrieve extraction results. The results either move to the output folder, or the document moves to the validator.

- Extraction engine

The extraction engine performs extraction based on the model ID and returns the results to the Learning instance.

- Output results

Once the extraction is completed, the output results will include three components:

- `extraction .csv`
- `auto detected table .csv`



- `response.json`

## Set up extraction service

To extract content from Standard Forms, you must setup and configure Microsoft Azure Form Recognizer service.

Document Automation provides you with the option to get your own license key or purchase license from Automation Anywhere. For more information on licenses, see [Automation 360 licenses](#) on page 1407.

### 1. Subscribe to Microsoft Azure service

Microsoft provides the Azure Form Recognizer service. This service enables you to build automated data processing software that can identify and extract specific content from documents. You must have Microsoft Azure subscription in order to access Azure resources (OCR, Form Recognizer), Automation Anywhere provides access to these resources through its subscription. Contact your Customer Success Manager (CSM) or Partner Enablement Manager (PEM) who will help you setup the services.

[Request access for Microsoft Azure resources \(OCR and Form Recognizer\) \(A-People login required\)](#)

### 2. Setup Microsoft Azure Form Recognizer service

For Cloud deployment

- If you purchase the license from Automation Anywhere, no additional configurations or changes are required.
- If you purchase the license from Microsoft Azure, review the following article to setup and configure your Microsoft Azure Form Recognizer for extracting content from standard forms.

[Setup Azure Form Recognizer and Storage \(Cloud\) \(A-People login required\)](#)

## Next steps

Connect Document Automation with the extraction service. See, [Configure Document Automation with Microsoft Azure Form Recognizer](#) on page 3697.

## Configure Document Automation with Microsoft Azure Form Recognizer

Send an API request to connect Document Automation with the extraction service.

---

**Note:** You will need the following information:

- Authorization token. See [Authentication API](#)
  - Microsoft Azure Form Recognizer endpoint
  - Microsoft Azure Form Recognizer API key
  - Microsoft Azure Blob storage URI
-

When working with API URL trusted list for Standard Forms:

- Add only form recognizer services API URL to the trusted list at Bot Runner end.
- Add SAS (blob) URL and form recognizer services API URL to the trusted list at the Control Room end.

---

**Note:** To obtain a Microsoft Azure API Key, reach out to your CSM. Raise a support case with the account name or tenant name, validity period (usually till expiry of license), and region (refer to Azure Products By Region) for standard forms in description through [Apeople](#) page. For any issue, reach out to CSM or AE.

For supported regions, see Microsoft Azure AI Document Intelligence product at [Azure Products by Region](#).

---

## For Document Automation Cloud

Request

```
PUT <Cloud Host Url>/cognitive/v3/formrecognizer/config
```

```
Headers: X-Authorization - <IQBot Admin User Auth token >
```

Request body:

```
{
  "formRecognizerApi": "https://<Cognitive Service Endpoint>",
  "formRecognizerKey": "<Cognitive Service apiKey>",
  "blobStorageSas": "https://<storage URL>"
}
```

## For Document Automation On-Premises

Request

```
PUT <On-Premises Machine ip_address or localhost:port>/cognitive/v3/
formrecognizer/config
```

```
Headers: X-Authorization - <IQBot Admin User Auth token >
```

Request body:

```
{
  "formRecognizerApi": "https://<Cognitive Service Endpoint>",
  "formRecognizerKey": "<Cognitive Service apiKey>",
  "blobStorageSas": "https://<storage URL>"
}
```

## Next steps

Log in as the Learning instance creator user to [Create a custom extraction model using Standard Forms](#) on page 3699.

## Create a custom extraction model using Standard Forms

Create a Standard Forms extraction model in the Control Room.

- Ensure your Control Room has the Document Automation Standard Forms (Number of pages) product license
- You must have the **AAE\_IQ Bot Admin** or **AAE\_IQ Bot Services** roles to complete this task
- Identify between five and fifteen training documents

1. In the Control Room, navigate to **Manage > Learning Instances** and click **Create model**. The **Projects** window opens in a new tab.
2. Click **Create project**.
3. Enter a name for the project, click **Browse** to upload documents to train the extraction model, and click **Create**.
4. Define the field tags:
  - a) Click **Add new tag**.
  - b) Enter a name for the tag. For example, `Invoice no.` or `Invoice Date`.
5. Define the table tags:
  - a) Click **Configure table tag**.
  - b) Enter a name for the table.
  - c) For each column in the table, enter the name of the column under the **Column fields** section.

### Column fields

Name	Type	Format
<input type="radio"/> Quantity	string	not-sp...
<input checked="" type="radio"/> Description	string	not-sp...

+ Add column

- d) When you are done entering the columns names, click **Save**.

6. Define the location of the data for each field:
  - a) For the form fields, highlight the location of the data to extract, then click the respective field in the right panel.
  - b) For each row in the table, highlight the location of the data to extract, then click the respective table field on the right.
  - c) Click **Done**, then open the next document and repeat the steps to define the locations of the form and table fields.
7. Click the **Train model** icon, enter a name for the model, and click **Train**.



8. Click the **Analyze** icon, click **Browse for file**, and select a document to test the extraction model.

---

**Note:** As of Automation 360 v.29, you can create and train new models in Microsoft Form Recognizer v.3.0 only. If you are in Microsoft Form Recognizer v.2.1, then you must update to Microsoft Form Recognizer v.3.0 by following the below steps:

- a) Open **Project**.
- b) Go to **Train** tab.
- c) Click **Train**. The model is created in the Microsoft Form Recognizer v.3.0.

---

Next, [Create a learning instance for standard forms](#) on page 3701

---

**Note:** You cannot edit an extraction model after associating it with a learning instance.

---

## Create a learning instance for standard forms

A learning instance is a structure that holds information such as document type, language, and the fields to be extracted. After creating Standard Forms, you must create learning instance to extract data from the documents.

- Ensure your Standard Forms configuration is complete.
- Ensure your Control Room has the Document Automation Standard Forms (Number of pages) product license

1. From the Control Room home page, navigate to **Manage > Learning Instances > Create Learning Instance**.

The **Create Learning Instance** window opens in a new tab.  Connect learning instance Create model **Create Learning Instance**

2. Add a name for the new learning instance to be created.
3. From the **Document Type** drop-down menu, select **Standard Forms**.

Document Type

Standard Forms

**Note:** The provider name is selected as **Microsoft Form Recognizer** by default.

4. For model selection, click **Browse** and search for a model using name or description filter.
5. Select your model and click **Next**.
6. To proceed further, you must select atleast one field:
  - Table
  - Forms

Select required and optional fields for extraction.

Form fields Table fields

**Note:** Standard forms support multiple tables. However, Document Automation does not allow displaying multiple tables. Hence, the tables are displayed as **tablename:field name** under **Tables** tab.

7. Some other field attributes are as follows:

Option	Description
Field name	Enter a field name that begins with an alphabetical character (A-Z or a-z).  In standard fields, the field name is hardcoded and cannot be changed.
Field label	Enter a user-friendly name to help validators.  For example, you can rename <code>Organization tax number</code> to a localized name, such as <code>VAT number</code> .  The field label does not affect extraction.

Option	Description
Confidence	<p>Set a threshold to reduce potential false positives.</p> <p>At the time of processing, the Document Automation engine assigns a score to each field in a document to indicate the certainty that the data was correctly extracted. If the document contains fields with a score that is lower than the confidence threshold, the document is sent to the validation queue.</p> <p>If you enter a high confidence threshold, more documents will be sent to the validation queue. If you enter a low confidence threshold, fewer documents will be sent to the validation queue.</p> <p>Supports values from zero to 100.</p>
Data type	<p>Choose from <b>Address*</b>, <b>Text</b>, <b>Number</b>, and <b>Date</b>.</p> <p>If the data in the field does not match the data type, the document is sent to the validation queue.</p> <p>Document Automation supports variations of the date format.</p> <hr/> <p><b>Note:</b> If you are configuring a learning instance with a user-defined document type, the form fields include the address data type, which extracts the entire structure of an address.</p> <hr/>
Required	<p>Select one of the following:</p> <ul style="list-style-type: none"> <li>• <b>Required:</b> Field cannot be empty.</li> <li>• <b>Optional:</b> Field can be empty or not exist in the document.</li> </ul>
Validation rules	<p>Depending on data type, create rules using patterns, formulas, lists, and statements such as starts or ends with.</p> <p><a href="#">Starts With and Ends With</a> on page 3772   <a href="#">Pattern</a> on page 3772   <a href="#">Lists</a> on page 3777   <a href="#">Formulas</a> on page 3777</p>

**8.** Click **Create**.

When a new learning instance is created, the Control Room creates a folder with the same name as the learning instance in the **Automation > Document Workspace**

folder. The folder contains two bots (extraction and download), a process, and a

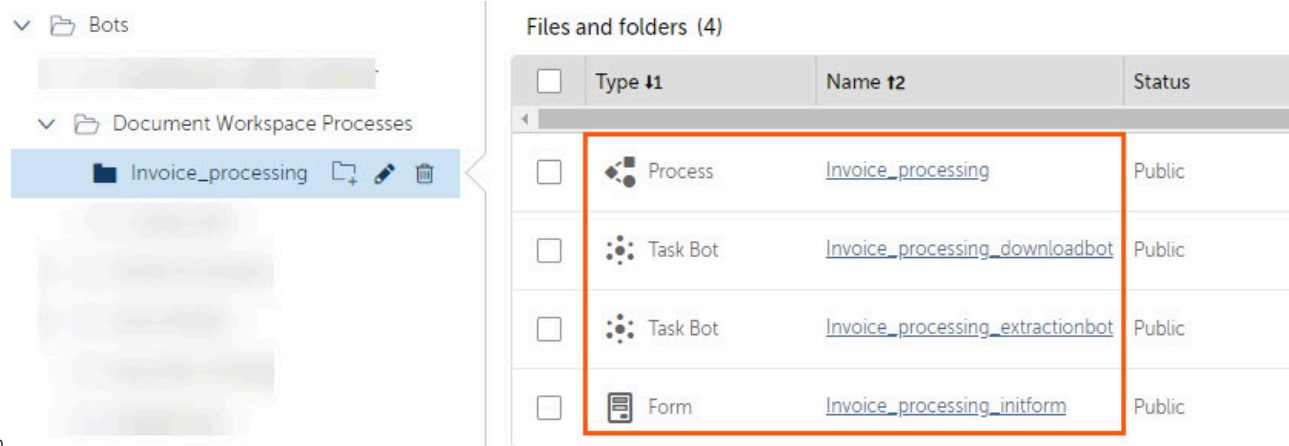

form.

- Process: Manages the process using if/else scenarios through which Document Automation extracts data from uploaded documents, assigns documents to users for validation, and downloads the extracted data. To learn more, see [About the Automation Co-Pilot process in Document Automation](#) on page 3646
- Extraction bot: Extracts data from defined fields in the uploaded documents.
- Download bot: Downloads the extracted data to a specific folder on the device or shared network.
- Form: Defines the input parameters that are sent to the process. Input parameters include the learning instance name, uploaded file, and output file path.

Upload documents to the learning instance, fix validation errors, and verify the extracted data:  
[Process documents in Document Automation](#)

## Transfer standard forms learning instance

Standard forms learning instance can be used across similar Document Automation environments. Export/Import an existing learning instance to avoid creating another one with the same configurations.

- Ensure that the source and destination systems are running the same Document Automation version. Learning instances from different Document Automation versions cannot be imported because their database schema will not match.
- Back up your database before importing learning instances.
- Export the .dw file from the source Document Automation environment.
- Import the .dw file into the destination Document Automation environment.
- 

---

**Note:** The incoming model of the source system must be available in the configuration of the target system.

---

For detailed information on exporting/importing learning instances, see [Export/Import learning instances](#) on page 3691.

## Document Automation support for Google Custom Document Extractor (CDE)

In Document Automation, you can create a user-trained learning instance and extract using a Google Custom Document Extractor (CDE) processor.

The new capability can be used to train a model using Google Custom Document Extractor (CDE) for any document type covering 50 languages. Once a model is deployed, the processor URL can be embedded within Document Automation extraction process.

To use Google CDE, you must have a:

- Google subscription to Google Document AI workbench.
- License for **Document Automation Platform** > **Document Workspace pages**.

---

**Note:** When working with API URL trusted list for Google CDE, you must add all APIs to the trusted list on the Bot Agent machine. The list of allowed APIs for Google CDE is as follows:

- Google accounts
- Google OAuth
- Google APIS
- Processor end point (only the host to be added to the trusted list)

For example,

```
https://eu-documentai.googleapis.com/v1/projects/⟨⟨Project ID⟩⟩/  
locations/eu/processors/⟨⟨Processor ID⟩⟩:process
```

---

### Usage of Google CDE

The effort involved in creating and maintaining models with Google CDE is justified by various scenarios, including:

- **Extended language support:** When working with documents that require support for additional languages, and existing pre-trained models do not offer that capability, Google CDE becomes essential.  
For supported languages, see [Language support for Google CDE](#).
- **Unsupported document formats:** Google CDE is beneficial when dealing with document types that lack compatible parsers. For example, documents like bill of lading, KYC documents, and others where existing parsers cannot be utilized.
- **Addressing accuracy and performance challenges:** In specific document formats, even with the use of pre-trained models, achieving the desired accuracy can be difficult. Google CDE with specific training on documents can provide better accuracy.
- **Custom or non-standard field extraction:** Google CDE can be used in scenarios where specific fields need to be extracted from documents that have custom or non-standard formats.
- **Extraction based on specific training when labels do not exist:** Google CDE is beneficial when there is a need to extract information from fields where pre-defined labels do not exist.



## Create a Custom Document Extractor (CDE)

The Google Custom Document Extractor (CDE) enables you to extract structured data and specific information from unstructured documents, such as invoices, receipts, and contracts.

With CDEs, you can train and evaluate processors using your own data, enabling accurate identification and extraction of entities from your documents. By applying these trained processors to additional documents, you can streamline the extraction of information from similar document types.

For detailed instructions on setting up Document AI Workbench and accessing the dataset, see [Build Custom Processor](#).

### Train multi-row tables

This quick feature allows the model to accurately extract information from tables spanning across multiple rows.

1. Train the first row of the table.

Patient Name: Mouni Roy  
 Member ID: IQ\_Bot\_987213  
 Date of Birth: 28 September 1984  
 Provider Name: Cognitive  
 Gender:  Male  Female  Other  
 Patient Account No: AABRD\_0234  
 Claim ID: Cognitive\_1555XXX  
 Claim Status: Denied  
 Type of payment:  Cash  Cheque  Bank Account

Line	Date of service	Rev Code	Units	Billed Amount	Allowed Amount	Discount /Penalty	Net Amount	
1	15/08/2018	0212	5	111.00	100.00	11.00	100.00	
2	16/08/2018	0211	6	Table 100.00	100.00	10.00	100.00	
3	17/08/2018	0213	8	15/08/2018	82.00	6.00	82.00	
4	17/08/2018	0215	6	100.00	68.00	0.00	68.00	
5	18/08/2018	0222	5	1	50.00	6.00	50.00	
6	19/08/2018	0222	5	0212 50.00	50.00	0.00	50.00	
7	19/08/2018	0211	5	5 45.00	45.00	0.00	45.00	
8	20/08/2018	0211	6	48.00	45.00	3.00	45.00	
9	22/08/2018	0213	6	54.00	52.00	2.00	52.00	
10	23/08/2018	0212	8	88.00	88.00	0.00	88.00	
Claim Totals				60	718.00	680.00	38.00	680.00

Payment Mode (If Bank Account):  
 Net Banking  
 Debit Card  
 Credit Card  
 Type of Card (Only for Debit or Credit card) Payment:  
 Master Card  
 Visa Card

2. Click **Add more rows** icon on the first row.

Table (15/08/2018 100.00 1 0212 5)  
 Line 1  
 Net\_Amount 100.00  
 Add more rows

3. Draw a bounding box on subsequent rows or columns within the table. By doing so, the subsequent nested entities will be automatically detected and identified under each parent.

Patient Name: Mouni Roy  
 Member ID: IQ Bot\_987213  
 Date of Birth: 28 September 1984  
 Provider Name: Cognitive  
 Gender:  Male  Female  Other  
 Patient Account No: AABRD\_0234  
 Claim ID: Cognitive\_1555XXX  
 Claim Status: Denied  
 Type of payment:  Cash  Cheque  Bank Account

Line	Date of service	Rev Code	Units	Billed Amount	Allowed Amount	Discount/Penalty	Net Amount
1	15/08/2018	0212	5	111.00	100.00	11.00	100.00
1	16/08/2018	0212	1	110.00	100.00	10.00	100.00
1	17/08/2018	0212	1	88.00	87.00	6.00	87.00
1	17/08/2018	0212	1	88.00	88.00	0.00	88.00
1	18/08/2018	0212	1	80.00	80.00	6.00	80.00
1	19/08/2018	0212	5	80.00	80.00	0.00	80.00
1	19/08/2018	0211	1	45.00	45.00	0.00	45.00
1	20/08/2018	0211	1	45.00	45.00	8.00	45.00
9	20/08/2018	0211	1	64.00	64.00	8.00	64.00
10	20/08/2018	0212	1	88.00	88.00	0.00	88.00
Claim Totals			60	718.00	680.00	38.00	680.00

Payment Mode (if Bank Account):  
 Net Banking  
 Debit Card  
 Credit Card

Type of Card (Only for Debit or Credit card) Payment:  
 Master Card  
 Visa Card

Remit Total:

Units	Billed Amount	Allowed Amount	Discount/Penalty	Net Amount
303	6430.00	6195.00	235.00	6195.00

- Review the identified text values to verify that they accurately represent the content of the document.

For detailed information, see the **Label a document** section in [Create a Custom Document Extractor](#).

- You can manually correct any discrepancies in the table fields after the training on multiple rows.
- [Create a learning instance using Google CDE](#) on page 3706.

## Create a learning instance using Google CDE

A learning instance is a structure that holds information such as document type, language, and the fields to be extracted. After creating a custom extraction processor, you must create learning instance to extract data from the documents.

- Ensure you have successfully created and trained a Google Custom Document Extractor (CDE) processor.
- Ensure your Control Room has the Document Workspace (Number of pages) product license.
- Ensure you configured the BYOK. For more information, see [Configure bring your own key BYOK for Google CDE](#) on page 3708.

To integrate a new processor with Google Document AI, the crucial step is the creation of a learning instance. This involves utilizing the provider as **Google Document AI (User-defined)** option. By creating a learning instance using this option, users can define form and table fields with matching names as present in the processor.

### Note:

- Currently, Google Document AI supports single table extraction.

- The check box feature (in preview mode) might result in inconsistent extraction for the check boxes fields, which could lead to inconsistent results. In such cases, if the system is unable to accurately extract the check box field value, it will be labeled as **Not Found**.

- From the Control Room home page, navigate to **Manage > Learning Instances > Create Learning Instance**.

The **Create Learning Instance** window opens in a new tab.

- Add a name for the new learning instance to be created.
- From the **Document Type** drop-down menu, select **User-defined**.
- From the **Provider** menu, select **Google Document AI (User-defined)**.
- Select **Table** or **Forms** field.
- Create new fields with identical names as those utilized in the Google CDE processor.

**Note:** When creating new fields, ensure that their names match the schema labels used in the Google processor. This applies to both form fields and table fields.

- Click **Create**.

When a new learning instance is created, the Control Room creates a folder with the same name as the learning instance in the **Automation > Document Workspace** folder.

- Update the extraction bot of learning instance with Service Account and Processor Endpoint URL.
  - Open the bot for the learning instance from **Bots > IQ Bot Processes > {LI name} > {LI name}\_extractionbot**.
  - Pick a credential vault locker and key. For more information, see [Configure bring your own key BYOK for Google CDE](#) on page 3708.
  - Copy the prediction endpoint URL from Google CDE processor.

The screenshot shows the 'Processor Details' page for a processor named 'FreeDomALL'. The page is divided into a left sidebar with navigation options (Overview, Processors, Processor gallery, Workbench, Human Review Platform) and a main content area. The main content area has tabs for 'PROCESSOR DETAILS', 'TRAIN', 'EVALUATE & TEST', 'MANAGE VERSIONS', and 'HUMAN-IN-THE-LOOP'. Under 'PROCESSOR DETAILS', the following information is displayed:

Name	FreeDomALL
ID	c6384ae2227adb95
Status	Disabled
Processor Type	Custom Document Extractor
Encryption Type	Google-managed

Below this information, there is a 'Prediction' section with a 'Prediction endpoint' field. The endpoint URL is: `https://eu-documentai.googleapis.com/v1/projects/1018049478570/locations/eu/processors/c6384ae2227adb95/process`. This URL is highlighted with a red box in the screenshot.

- Paste the copied URL in the **Document AI endpoint URL for document processor**.

**Document Extraction: Extract data**

Processes uploaded documents to extract data  
Required bot agent version: 21.98 or above

**Document to extract**  
 Variable  Control Room file  Desktop file

(x)

Regex support unavailable. Upgrade package to enable regex.

**Learning instance name**  
 Server instance  Variable

(x)

**Output results should be**  
 Uploaded to server  
 Saved to a local folder

**Output folder path**

Path to local file system

**Service account (optional)**  
 Credential  Variable  Insecure string

Service account from Google. Optional parameter for using your own Google service account to access Doc AI.

**Document AI endpoint URL for document processor (optional)**  
 (x)

URL to Document AI endpoint. Format should be "https://https://(host)/(apiVersion)/projects/(projectId)/locations/(location)/processors/(processorId):process". Optional parameter for using your own Google service

Upload documents to the learning instance, fix validation errors, and verify the extracted data. For more information, see [Process documents in Document Automation](#) on page 3648.

## Configure bring your own key BYOK for Google CDE

To leverage BYOK (bring your own key) license for Google Custom Document Extractor (CDE) processor, follow these configuration steps.

Log in as the `AAE_Locker_Admin` user type.

1. Create a custom role for Credential Vault locker.
  - a) Provide a name for the role, such as `google-cde-credential-role`. The `Manage my credentials` and `lockers` permission is automatically selected.
  - b) Click **Create** role.

Assign the role to the `Bot creator` and `Unattended Bot Runner` user types.

2. Create a credential in Credential Vault for Google service account.

- a) Navigate to **Manage > Credentials > Create credential**.
  - b) Provide a name for the credential, such as `google-cde-credential`.
  - c) Provide a name for the attribute, such as `ServiceAccount`.
  - d) Select the **Standard** input option and enter the Google Document AI API key in the **Value** field.
  - e) Click **Create credential**.
3. Create a locker to store the key.
- a) Navigate to the **Lockers** tab and click **Create locker**.
  - b) Provide a name for the locker, such as `google-cde-locker`.
  - c) Select the `google-cde-credential` and click the right arrow to move the credential to the **Selected** column.
  - d) In the **Consumers** tab, select the `google-cde-credential-role` and click the right arrow to move the credential to the **Selected** column.
  - e) Click **Create locker**.

## Document Automation data extraction using Generative AI

Document Automation for Cloud provides generative AI (GenAI) capability to extract data seamlessly from unstructured and semi-structured documents. Create learning instance with GenAI capability to process documents in English, using a large language model (LLM). Note: This capability is available only in Cloud deployments from Automation 360 v.30 release.

---

**Note:** Generative AI models can produce errors and/or misrepresent the information they generate. It is advisable to verify the accuracy, reliability, and completeness of the content generated by the AI model.

---

### Benefits

Enhance extraction accuracy in a learning instance by using the **Search query for generative AI model** feature when defining form fields. Document Automation offers a default customizable query based on your selected field. Transmitting your query to GenAI enhances and enables data extraction from different document types without prior training. Leverage this innovation to enhance your document processing capability.

### How generative AI improves extraction

When you create a learning instance for unstructured documents (such as: Contracts, Agreements, Reports, Letters, and Emails), the GenAI-driven data extraction capability is automatically selected. While defining the **Form fields** for your learning instance, you can leverage the **Search query for generative AI model** option to customize your data extraction request.

For an address field, the GenAI query provides a default query such as: 'What is the Property Address?'. You can customize this query for more focused extraction to say: 'What is the full Property Address with city, state and zip code?' See image below for reference.

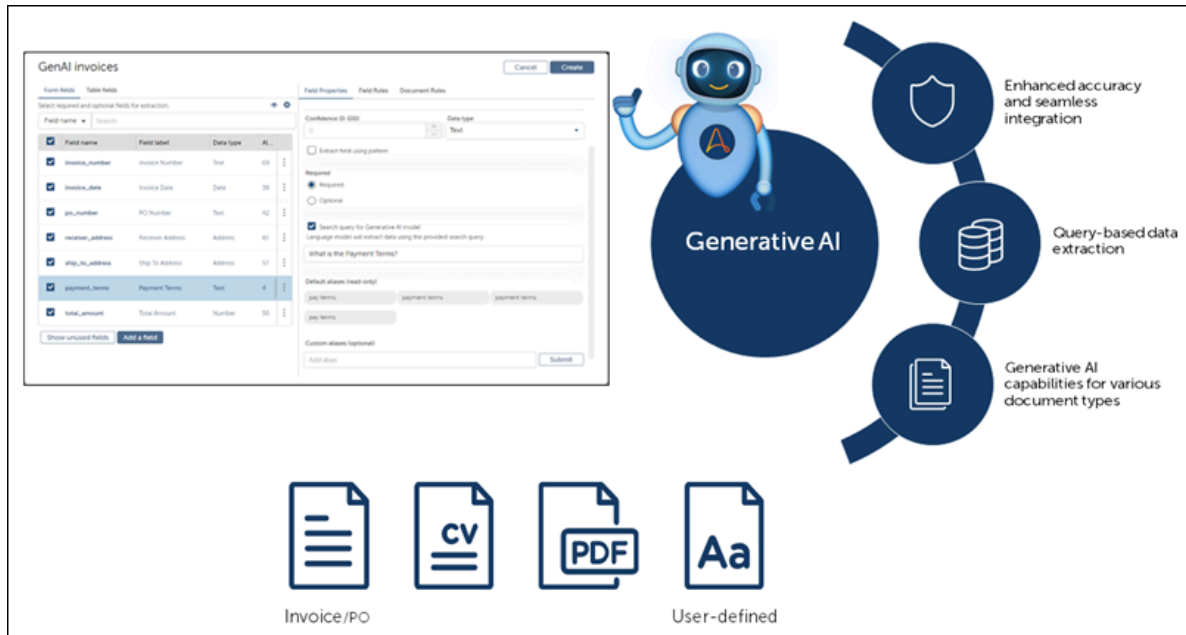

On processing a document, using this learning instance, the GenAI capability will extract the complete address, instead of just the street name and number. All you need to do is define the search query in the model just once, and then for every document processed using this model, the data gets extracted with no additional configuration.

When creating a learning instance for semi-structured documents such as Invoices, User-defined and Purchase orders or supply-chain documents such as: Waybill, Bill of Lading, Arrival Notice, and Packing Lists, you can leverage the GenAI-driven data extraction capability in addition to the native extraction capability based on user-provided updates in the Validator.

These are available use cases and some limitations for the current version of this feature:

- Create learning instance models for unstructured documents such as: Contracts, Agreements, Reports, Letters, and Emails.
  - Google Vision OCR support only
  - English language availability only
  - Table fields are not supported
  - Document Automation Cloud version support only
- Create learning instance models for semi-structured documents such as: Waybill, Bill of Lading, Arrival Notice, and Packing Lists.
  - ABBYY FineReader Engine (default), and Google Vision OCR support only
  - English language availability only
  - GenAI search query is not supported for table fields
  - Document Automation Cloud version support only

**Important:** Privacy Notice: When the Generative AI capability is selected, the query is sent to a third-party service. Currently, the data is sent to Microsoft Azure OpenAI service, which is

located in the US and EU regions. If you do not want your data sent to a third-party service, we recommend not using the unstructured and semi-structured document types that uses the Generative AI feature out-of-the-box.

---

## How can I enable the generative AI (GenAI) feature in Document Automation

From Automation 360 v31, we have introduced a new section in the Control Room settings for enabling the GenAI connection to the available third-party services.

---

**Important:** This feature will be available with the Cloud rollout for Automation 360 v.31 release.

---

The automation administrator can enable or disable the connection to external services such as Google Document AI, Google OCR , or Microsoft OpenAI.

---

**Note:** You must upload a valid Cloud license to your tenant to use the GenAI feature in Document Automation.

---

1. As the automation administrator, log-in to your Cloud Control Room tenant and navigate to **Administration > Settings > Document Automation Settings**.
2. Under **External Connections**, turn on the toggle to **Enable connections with external Google DocumentAI, Google OCR, and Microsoft OpenAI services** option. This option is disabled for On-Premises users.
3. Next, from the **Third-party service server locations** drop down, select your region of deployment. Currently, US and EU are the only options available, and US is the default selection.

What happens if the third-party connection is disabled in your tenant?

The connection could be disabled if you do not have a valid Cloud license uploaded to your Control Room tenant, or you could have missed enabling the connection. When this feature is disabled, you will not be able to do the following:

- create learning instances using any of these services: Google Document AI, Google OCR, and Microsoft OpenAI services
- create learning instances with GenAI-driven data extraction for unstructured and semi-structured documents

Related concepts

[Data security for generative AI - FAQ](#) on page 1081

We have introduced generative AI (GenAI) infused features to help our customers realize productivity gains by building better and smarter automations. Our customers can realize the

power of GenAI with features such as Automation Co-Pilot for Business Users and Document Automation.

## Create learning instance with Generative AI for unstructured documents

Use this topic as a guide to create a learning instance leveraging the Generative AI (GenAI) capability to extract data from unstructured documents such as Contracts, Agreements, Reports, Letters, and Emails.

With Generative AI, you can create a learning instance to extract data from unstructured documents without training the learning instance. This is critical for fast and accurate document processing. Let's walk you through the steps of creating a learning instance with the Generative AI capability that will enable accurate data extraction from unstructured documents.

A Professional Developer of a company would perform the following tasks:

- Create, edit, process, and delete learning instances
- Upload documents for processing and testing
- Check-in and check-out learning instances from private to public folders

License requirement: Bot Creator license to perform the above tasks.

Assigned roles and permission:

- **AAE\_IQBot Services** or **AAE\_IQBot Admin**
- **AAE\_Basic**

1. Log in to the Control Room and navigate to **Manage > > Learning Instances**, and click the **Create Learning Instance** button to start creating a new learning instance.
2. Next, enter a unique learning instance name to identify it easily in the **Learning Instances** list, and proceed to select the other options as follows:

**Fire Risk Reports** Cancel Update

Form fields

Select required and optional fields for extraction.

Field name Search

Field name	Field label	Data type	
<input checked="" type="checkbox"/>	Report Date	Report Date	Text
<input checked="" type="checkbox"/>	Property Address	Property Address	Text
<input checked="" type="checkbox"/>	Overall risk	Overall risk	Text

Show unused fields Add a field

Field Properties Field Rules Document Rules

Field name  
Property Address

Field label  
Property Address

Confidence (0-100) 0 Data type  
Text

Required  
 Required  
 Optional

Search query for Generative AI model  
Language model will extract data using the provided search query.  
What is the full Property Address with state, city and zip code?



- a) **Description (optional):** This is an optional field that can be used to add a meaningful description and summarize the use of the learning instance.
  - b) **Document Type:** Unstructured document  
On selecting this option, the Generative AI driven data extraction feature is enabled. This is enabled by default for unstructured document types.
  - c) **Language:** English  
In the current release we support English only.
  - d) **Locale:** as per locale of the documents.  
You would select the locale based on locale of the processed documents that would define the formats for number or date when using normalization.
  - e) **Provider:** Automation Anywhere (User-defined)  
This value is selected by default as we currently offer this option only.
  - f) **OCR Provider:** Google Vision  
This value is selected by default as we currently offer this option only.
3. Click **Next** to begin creating form fields for the learning instance. Currently, only the Form field configuration option is supported.
  4. Click **Add a field** to begin adding fields for each data point or entity for which you want to extract data, from your documents.
  5. Next, add a **Field name** which must be specific to the data point you want to extract, a **Field label** which is used to create a default search query, and select **Data type** to define the field value data structure.  
You can select from Text, Number, Date, or Address Data type value options from the drop-down. For details on creating form fields, see: [Create a learning instance in Document Automation](#) on page 3642, step 10.  
When leveraging the Generative AI capability, the **Confidence** field is grayed out. The form field can be set to **Required** or **Optional**.
  6. For the **Search query for generative AI model** section, you have the option to go with the system-generated query or add a custom query.  
For example, for an address field the default Generative AI query would say 'What is the Home address?'. You can customize the query to 'What is the Home address with city and state?'.  - 7. In the next step, define the **Field Rules** and **Document Rules** for the form fields and click **Create** to complete creating the learning instance. For details on defining the form and document rules see: [Validation rules in Document Automation](#) on page 3651.
1. Publish the learning instance to the public repository so that the learning instance can be used in public mode to extract data from real documents, and validators can manually validate documents. See [Publish the learning instance to production](#) on page 3680.
  2. In the **Manage > > Learning Instances** list page, identify the learning instance you just created and published and click **Process** to begin uploading documents for processing and data extraction. See [Process documents in Document Automation](#) on page 3648.
  3. Open the CSV document with the extracted data to compare with the processed document to validate and confirm that the Generative AI enabled search query fields has extracted data with high accuracy.

## Create learning instance with Generative AI for semi-structured documents

Use this topic as a guide to create a learning instance leveraging the Generative AI (GenAI) capability to extract data from semi-structured documents such as Arrival Notice, Bill of Lading, Packing Lists, and Waybill .

For data extraction from semi-structured documents users have the option to use the Generative AI capability in addition to the out-of-the-box user-validation feedback feature by checking the **Improve accuracy using validation** option while creating a learning instance. This ensures consistent and improved data extraction with out-of-the-box accuracy. Let's walk you through the steps of creating a learning instance with the Generative AI capability that will enable accurate data extraction from semi-structured documents.

A Professional Developer of a company would perform the following tasks:

- Create, edit, process, and delete learning instances
- Upload documents for processing and testing
- Check-in and check-out learning instances from private to public folders

License requirement: Bot Creator license to perform the above tasks.

Assigned roles and permission:

- **AAE\_IQBot Services** or **AAE\_IQBot Admin**
- **AAE\_Basic**

1. Log in to the Control Room and navigate to **Manage > > Learning Instances**, and click the **Create Learning Instance** button to start creating a new learning instance.
2. Next, enter a unique learning instance name to identify it easily in the **Learning Instances** list, and proceed to select the other options as follows:

The screenshot shows the 'Create Learning Instance' configuration interface in Automation Anywhere. The document type is 'Arrival Notice'. A table lists fields for extraction:

Field name	Field label	Data type
<input checked="" type="checkbox"/>	shipper_name	Shipper Name
<input checked="" type="checkbox"/>	shipper_address	Shipper Address
<input checked="" type="checkbox"/>	consignee_name	Consignee Name
<input checked="" type="checkbox"/>	consignee_address	Consignee Address
<input checked="" type="checkbox"/>	place_of_origin	Place of Origination
<input checked="" type="checkbox"/>	bol_number	Bill of Lading Number
<input checked="" type="checkbox"/>	shipment_date	Shipment Date
<input checked="" type="checkbox"/>	carrier_name	Carrier Name
<input checked="" type="checkbox"/>	place_of_delivery	Place of Delivery
<input checked="" type="checkbox"/>	delivery_eta	Delivery ETA

The 'Field Properties' panel for 'shipper\_address' shows:

- Field name: shipper\_address
- Field label: Shipper Address
- Confidence ID (1-100): 100
- Data type: Address
- Extract field using pattern
- Required:  Required,  Optional
- Search query for Generative AI model: Language model will extract data using the provided search query. Query: What is the Shipper Address?
- Default aliases (read-only): shipper\_address
- Custom aliases (optional): Add alias

- a) **Description (optional):** This is an optional field that can be used to add a meaningful description and summarize the use of the learning instance.
- b) **Document Type:** Select from a list of semi-structured documents available such as: Arrival Notice, Bill of Lading, Packing Lists, and Waybill.

On selecting this option, the **generative AI driven data extraction** feature is enabled in addition to the **Improve accuracy using validation** capability that is offered out-of-

the box and is based on feedback sent to the system from the user-provided changes made in the Validator during the validation process. This is a critical capability for semi-structured documents as it ensures better data extraction result with a combination of user-validation feedback and GenAI capability.

**c) Language:** English

In the current release we support English only.

**d) Locale:** as per locale of the documents.

You would select the locale based on locale of the processed documents that would define the formats for number or date when using normalization.

**e) Provider:** Automation Anywhere (User-defined)

This value is selected by default as we currently offer this option only.

**f) OCR Provider:** ABBYY or Google Vision

You have the option to choose from the two supported OCR options.

3. Click **Next** to begin creating form and table fields for the learning instance. Currently, Generative AI capability is available only for form fields. The table fields have default and custom alias support. See [Create a learning instance in Document Automation](#) on page 3642, step 9 for details on adding aliases for a field.

4. Click **Add a field** to begin adding fields for each data point or entity for which you want to extract data, from your documents.

5. Next, add a **Field name** which must be specific to the data point you want to extract, a **Field label** which is used to create a default search query, and select **Data type** to define the field value data structure.

You can select from Text, Number, Date, or Address Data type value options from the drop-down. For details on creating form fields, see: [Create a learning instance in Document Automation](#) on page 3642, step 10.

The form field can be set to **Required** or **Optional**. When leveraging the Generative AI capability, the **Confidence** field is grayed out.

6. You have the additional option to use the **Extract field using pattern** capability for extraction.
7. For the **Search query for generative AI model** section, you have the option to go with the system-generated query or add a custom query.

For example, for an address field the default Generative AI query would say 'What is the Home address?'. You can customize the query to 'What is the Home address with city and state?'.

8. In the next step, define the **Field Rules** and **Document Rules** for the form fields and click **Create** to complete creating the learning instance. For details on defining the form and document rules see: [Validation rules in Document Automation](#) on page 3651.

1. Publish the learning instance to the public repository so that the learning instance can be used in public mode to extract data from real documents, and validators can manually validate documents. See [Publish the learning instance to production](#) on page 3680.
2. In the **Manage > > Learning Instances** list page, identify the learning instance you just created and published and click **Process** to begin uploading documents for processing and data extraction. See [Process documents in Document Automation](#) on page 3648.
3. Open the CSV document with the extracted data to compare with the processed document to validate and confirm that the GenAI enabled search query fields has extracted data with high accuracy.

## Architecture and security guidelines for Document Automation with Generative AI capability

Here's a list of privacy, security, and typical use cases for your consideration for using Document Automation with Generative AI capability.

### Functionality

---

**Note:** Generative AI models can produce errors and/or misrepresent the information they generate. It is advisable to verify the accuracy, reliability, and completeness of the content generated by the AI model.

---

What is different about the manner in which Document Automation processes unstructured documents and shipment documents compared to invoices?	Automation Anywhere incorporates (individually modeled) large language models (LLM) in the Document Automation product to assist with processing unstructured documents and shipment documents.
What document types can be processed using Generative AI?	Any unstructured and shipment documents, such as: bill of lading, waybill, arrival notice, or packing list.
Are there any limitations on the field types supported by Document Automation?	Yes, currently, only form fields are supported.
What are the supported languages?	Officially English is supported, but other languages would also work.
What is the pricing structure for Document Automation with Generative AI capabilities?	Automation Anywhere charges per page for Document Automation, and the OpenAI cost is included in the price.
Could a customer call their own Azure endpoint for Microsoft AzureOpenAI LLM?	Currently, a customer-defined LLM endpoint, or 'bring your own license' (BYOL) use case is not supported.
Is the Generative AI with Document Automation feature available On-Premises in a customer's private cloud?	No, currently the integrated Generative AI is not available for use for the On-Premises instances. It will work only for the Cloud version of Document Automation.
What OCR engine can be used for unstructured document types?	Currently, only the Google Vision OCR is supported.
What OCR engine can be used for shipment documents?	We recommend using ABBYY FineReader Engine and Google Vision OCRs for shipment documents.

### Security

Which LLM does Document Automation send the queries to?	Document Automation currently uses Microsoft Azure OpenAI services for LLM use. We currently use GPT3.5-Turbo and ADA models.
---	---

In which countries are the Document Automation documents submitted for processing?	Automation Anywhere has selected the EU and US regions for processing the documents.
Does Automation Anywhere permit vendors to train their LLMs on data from documents submitted to Document Automation?	No, Automation Anywhere does not use or allow any third-party vendors to use documents or data submitted by customers or users for training purposes.
Does Automation Anywhere train its own instance of any LLMs on data from documents submitted to Document Automation?	No, Automation Anywhere does not use or allow any third-party vendors to use documents or data submitted by customers or users for training purposes.
Do any additional vendors have access to prompts or documents which customers submit to Document Automation?	Yes, please see Exhibit C of our DPA (link at the end of this paragraph) for a list of vendors who have access to data submitted by customers to Document Automation. The applicable vendors will say "Document Automation" in the second column labeled Applicable Services. Link to <a href="#">DPA</a> .
Does Automation Anywhere store documents submitted to Document Automation or data extracted from the documents?	Beside Automation Anywhere Cloud hosting providers, the Automation Anywhere vendors do not store any documents, as documents exist in a transitory state only. However, to enable customers validate the documents, Automation Anywhere stores the document images and the OCR output of the document text in the Cloud instance.
What kind of data is shared with the LLM services?	Documents, content from documents, and prompt or search queries.
Will Automation Anywhere enter into a Business Associate Agreement ("BAA") for the processing of Protected Health Information (as defined by C.F.R. § 160.103) ("PHI") with respect to PHI, which a customer submits to Document Automation?	Yes. Typically, our BAA is automatically incorporated into our <a href="#">Cloud Automation Agreement</a> . Please reach out to your Customer Success Manager (CSM) or Sales Executive (SE) to check whether you have a BAA in place, and if not, they will get you a copy of our BAA.
Will Automation Anywhere enter into a Data Processing Agreement ("DPA") for the processing of Personal Data which a customer submits to Document Automation?	Yes. Typically, our DPA is automatically incorporated into our <a href="#">Cloud Automation Agreement</a> . Please reach out to your Customer Success Manager (CSM) or Sales Executive (SE) to check whether you have a DPA in place, and if not, they will get you a signed copy of our DPA. If you would like to see the terms in our DPA , it can be found here: <a href="#">Automation Anywhere DPA Agreement</a>
Important data usage details from Google Vision OCR Service (Source: Google).	<a href="#">Google Vision OCR Service Data Usage</a>

## Architecture diagram

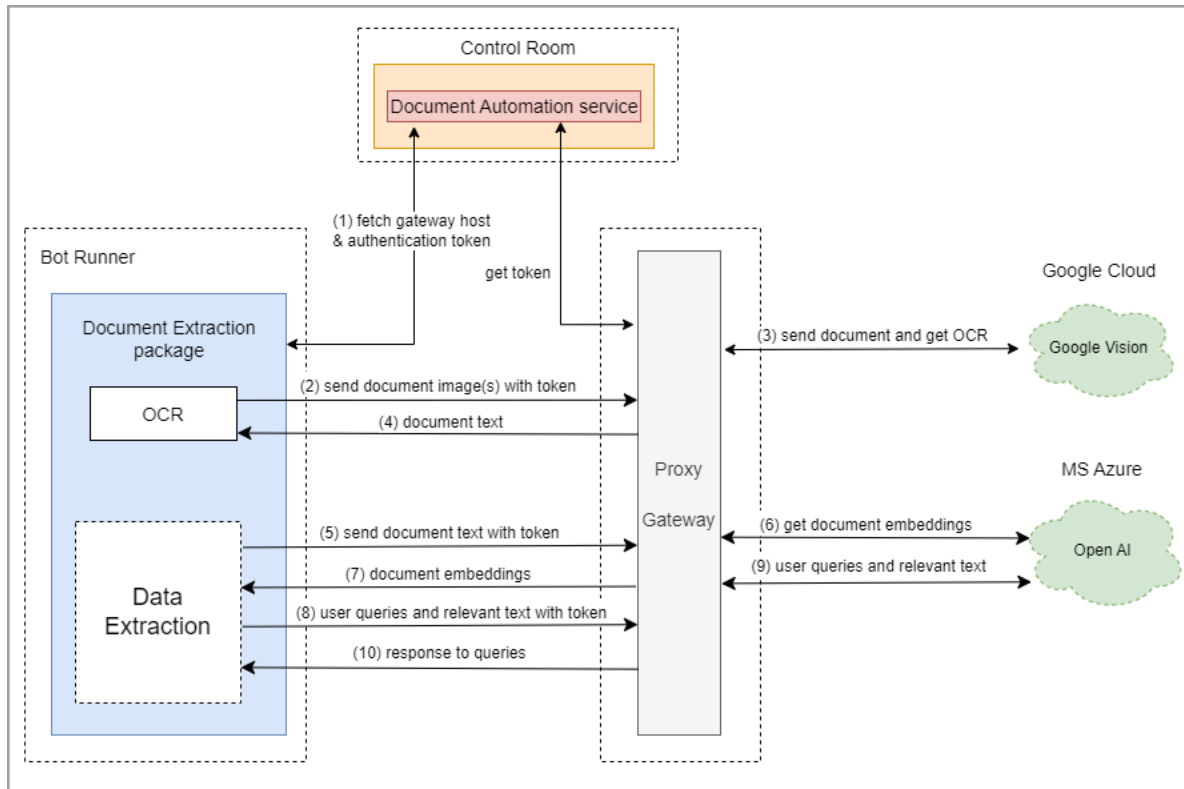

The extraction process consists of several steps:

### 1. Authentication:

- Extraction process starts by running the Document Extraction package on a bot runner device
- (1) Configuration of the extraction process is defined in a learning instance. If the learning instance uses Generative AI-driven extraction, the package connects to Control Room to fetch information about the Proxy Gateway host location and authentication token.

### 2. OCR:

- The next step is to retrieve a text layer from the document. The system uses OCR engines for the task
- (2) If Google Vision OCR is selected in the learning instance, the package sends a document to Proxy Gateway
- (3) Proxy Gateway forwards this request to the Google Vision API endpoint for OCR, and (4) sends the results back to the package

### 3. Data Extraction:

- (5), (6), (7) To process large documents, the package creates embeddings for different chunks of the document using the ADA model
- (8), (9) Next, the package identifies the most relevant chunk of the document for the provided search query(s) using embedding and sends that chunk along with a prompt to the GPT model through the Proxy Gateway

- (10) Finally, the package receives responses from GPT and converts them into document extraction results

For Automation Anywhere Cloud Generative AI data security information, see: [Data security for generative AI - FAQ](#) on page 1081

## Languages supported in Document Automation

Document Automation supports more than 50 languages for document extraction. This topic provides lists of supported languages in Document Automation based on various document types, providers, OCR engines, and third-party parsers.

### Document type

The following table provides a list of supported languages in Document Automation for various document types:

Language	Document type				
	Invoices	Receipts	Standard Forms	User-defined	Document types such as Arrival Notice, Bill of Landing, Packing List, Unstructured documents, Utility bill, Waybill
English	X	X	X	X	X
German	X	X	X	X	
French	X	X	X		
Spanish	X	X	X		
Afrikaans				X	
Albanian				X	
Arabic					
Bulgarian					
Catalan				X	
Chinese (Simplified)					
Chinese (Traditional)					
Croatian				X	

Language	Document type				
	Invoices	Receipts	Standard Forms	User-defined	Document types such as Arrival Notice, Bill of Landing, Packing List, Unstructured documents, Utility bill, Waybill
Czech				X	
Danish				X	
Dutch	X	X	X	X	
Estonian	X			X	
Finnish				X	
Flemish				X	
Greek					
Hungarian				X	
Icelandic				X	
Indonesian				X	
Italian	X		X	X	
Japanese		X	X		
Korean					
Latvian	X			X	
Lithuanian	X			X	
Malay				X	
Norwegian				X	
Polish					
Portuguese	X			X	
Romanian	X				
Russian					
Serbian (Latin)					
Slovak					
Slovenian					



Language	Document type				
	Invoices	Receipts	Standard Forms	User-defined	Document types such as Arrival Notice, Bill of Landing, Packing List, Unstructured documents, Utility bill, Waybill
Swedish	X				
Tagalog					
Turkish					
Vietnamese					

### Providers and third-party parsers

The following table provides a list of supported languages in Document Automation for various providers:

Language	Provider						Third-party parser
	Autom. Anywh. (Pre-trained)	Google Docum. AI	Conne. - IQ Bot Classic	Autom. Anywh. (User-defined)	Micros. Forms Recogn.	Google Docum. AI (User-defined)	
	Invoices, Bill of Landing, Waybill, Arrival Notice, Packing List	Invoices, Receipts, Utility Bill	Invoices, Purchase Orders, Billing statements, Contracts, Autom. Insurar. Claim, Health Insurar. Claim (1500), Health Insurar. Claim (UB 04)	User-defined, Unstru. docum.	Standar. Forms	User-defined	
English	X	X	X	X	X	X	X

Language	Provider						Third-party parser
	Autom. Anywh. (Pre-trained)	Google Docum. AI	Conne. - IQ Bot Classic	Autom. Anywh. (User-defined)	Micros. Forms Recogn.	Google Docum. AI (User-defined)	
	Invoice Bill of Landin, Waybil, Arrival Notice, Packin, List	Invoice Receipt Utility Bill	Invoice Purcha Orders Billing statem, Contra Autom. Insurar Claim, Health Insurar Claim (1500), Health Insurar Claim (UB 04)	User-defined Unstru docum	Standa Forms	User-defined	
German	X	X		X	X	X	X
French	X	X		X	X	X	X
Spanish	X	X		X	X	X	X
Italian				X	X		
Afrikaans						X	X
Albanian						X	X
Arabic							X
Bulgarian							X
Catalan						X	X
Chinese (Simplified)							X
Chinese (Traditional)							X
Croatian						X	X
Czech						X	X
Danish						X	X
Dutch		X		X	X	X	X
Estonian		X				X	X
Finnish						X	X
Flemish							X
Greek							X

Language	Provider						Third-party parser
	Autom. Anywh. (Pre-trained)	Google Docum. AI	Conne. - IQ Bot Classic	Autom. Anywh. (User-defined)	Micros. Forms Recogn.	Google Docum. AI (User-defined)	
	Invoice Bill of Landin. Waybil. Arrival. Notice. Packing List	Invoice Receipt Utility Bill	Invoice Purcha. Orders Billing statem. Contra. Autom. Insurar. Claim, Health Insurar. Claim (1500), Health Insurar. Claim (UB 04)	User-defined Unstru. docum.	Standa. Forms	User-defined	
Hungarian						X	X
Icelandic						X	X
Indonesian						X	X
Italian		X		X	X	X	X
Japanese		X					
Korean							X
Latvian		X				X	X
Lithuanian		X				X	X
Malay						X	X
Norwegian						X	X
Polish						X	X
Portuguese		X		X	X	X	
Romanian		X				X	
Russian							X
Serbian (Latin)							X
Slovak						X	X
Slovenian						X	X
Swedish		X				X	
Tagalog						X	X

Language	Provider						Third-party parser
	Autom. Anywh. (Pre-trained)	Google Docum. AI	Conne. - IQ Bot Classic	Autom. Anywh. (User-defined)	Micros. Forms Recogn.	Google Docum. AI (User-defined)	
	Invoice Bill of Landin. Waybil. Arrival. Notice. Packin. List	Invoice Receipt Utility Bill	Invoice Purcha. Orders Billing statem. Contra. Autom. Insurar. Claim, Health Insurar. Claim (1500), Health Insurar. Claim (UB 04)	User-defined Unstru. docum.	Standa. Forms	User-defined	
Turkish						X	X
Vietnamese						X	X

## OCR Engine

The following table provides the links to supported languages for all Document Automation supported OCR engines:

Document Automation supported OCR engines	List of supported languages
ABBYY FineReader Engine	<a href="#">ABBYY FineReader Engine OCR supported languages</a>
Google Vision API	<a href="#">OCR Language Support</a>

## Document Automation Community Edition

The Community Edition version offers users limited features from the document processing solutions Document Automation and Automation 360 IQ Bot. This version is available to users for free.

Users are not required to purchase a license and there are no time limitations. However, there are some functionality constraints as follows:

- You can create a maximum of five learning instances per user.
- You cannot delete a learning instance.

- In the learning instance list, you can view and access only the learning instances and data that you created.
- You cannot integrate a Community Edition version of Document Automation with an Automation 360 IQ Bot environment.
- Google Document AI and Standard forms are not supported.

## Get started with Community Edition

---

### Important:

Automation 360 IQ Bot Community Edition will no longer be available from November 28, 2023. Use the Document Automation Community Edition for enhanced intelligent document processing.

Users who have created automations using Automation 360 IQ Bot will need to rewrite them using Document Automation.

---

To begin using Community Edition:

1. Register and log in to Community Edition:  
Complete steps one and two of [Set up Community Edition](#) on page 1326.
2. Install the Bot Agent and set user device credentials.
  - a) Navigate to **Manage > Devices** and click **Connect local device**. Follow the steps in the wizard to connect the Control Room to your device.
  - b) Click **Refresh** to verify that your device is connected.
  - c) Click your username. Navigate to **My settings > Devices > Credentials**. Click **Edit** to provide your device username and password.
3. Navigate to **Manage > Learning instances** and select a version of IQ Bot to begin creating learning instances:
  - Option 1: Click the **Create learning Instance** option.  
Create learning instances to extract data from invoices in Document Automation: [Create a learning instance in Community Edition](#) on page 3726
  - Option 2: Click the **Train other documents** option.  
Create learning instances to extract data from other document types using Automation 360 IQ Bot: [IQ Bot Community Edition quick start guide](#)

---

**Note:** From Automation 360 v.31 onwards, the **Train other documents** option is not available for Community Edition users as IQ Bot is deprecated.

---

## Create a learning instance in Community Edition

Create a learning instance to begin processing documents. In Community Edition, you can extract data from invoices in English using the ABBYY OCR provider.

1. From the Control Room home page, navigate to **Manage > Learning Instances > Create Learning Instance**.
2. Enter a name and description for the learning instance.  
Document Automation does not allow duplicate learning instance names, so the name you provide must be unique.
3. Click **Next**.

We recommend that you open a sample document side by side with the Control Room window as you configure the form and table fields.

---

### Note:

- A form field is a type of field that occurs only one time in a document.
- A table field is a type of field that reoccurs throughout a document, typically in the form of a table.

- 
4. Configure the form and table fields for extraction.

Document Automation offers a standard set of form and table fields, many of which are not initially visible. You can search for a field by field name, field label, or data type.

To see the full list of fields, click **Show unused fields**. See the following video for a demonstration:

Click a field to open the fields editor. You can edit most attributes of a field. You cannot edit the name and default aliases. Document Automation assigns default aliases, which are hardcoded keywords, to standard fields to help with extraction. You cannot modify or delete default aliases, but you can add aliases in the **Custom aliases** field. See the following video for a demonstration of creating a custom alias:

You can add custom form and table fields for Google Document AI learning instances. When you want to extract data from fields that Google does not support, you can create custom fields. With this enhancement, you can use pre-trained models from Google along with custom fields for document extraction.

Consider the following points when you add custom fields for Google Document AI learning instances:

- You can add custom form and table fields for document types such as invoices and utility bills.

---

**Note:** You cannot add custom fields for the receipts document.

- 
- You can edit and save the custom fields.
  - A regular expressions (RegEx) is available for the custom fields.
  - You can add custom fields for existing learning instances that are attached to the old package.

In this scenario, when you save the learning instance, a notification displays to update the package version.

- Based on the aliases, you can extract the custom fields by using the V8 engine.

- When a package is not compatible with multiple features, a message displays corresponding to the highest package version.
- You can import or export the custom fields to or from the .dw file along with defined aliases and settings.
- When you extract the custom fields, these fields are backward compatible with the older package version.
  - When a learning instance uses the custom fields, the old package (v.29 and earlier) does not throw an error and contains empty values for custom fields.
  - Similar to the standard fields, the old package (v.29) applies normalization and rules for custom fields, if applicable.

Mouse over the menu icon to the right of a field to access the up/down arrows. Use the arrows to rearrange the order of the fields for a more efficient manual validation. The order of the fields does not impact extraction.

To learn more about the other field attributes, review the table in the next step.

5. To add a field, click **Add a field** and complete the following fields:

Option	Description
Field name	Enter a field name that begins with an alphabetical character (A-Z or a-z). In standard fields, the field name is hardcoded and cannot be changed.
Field label	Enter a user-friendly name to help validators. For example, you can rename <code>Organization tax number</code> to a localized name, such as <code>VAT number</code> . The field label does not affect extraction.
Confidence	Set a threshold to reduce potential false positives. At the time of processing, the Document Automation engine assigns a score to each field in a document to indicate the certainty that the data was correctly extracted. If the document contains fields with a score that is lower than the confidence threshold, the document is sent to the validation queue. If you enter a high confidence threshold, more documents will be sent to the validation queue. If you enter a low confidence threshold, fewer documents will be sent to the validation queue. Supports values from zero to 100.
Data type	Choose from <b>Address*</b> , <b>Text</b> , <b>Number</b> , and <b>Date</b> . If the data in the field does not match the data type, the document is sent to the validation queue. Document Automation supports date and number format variations. * If you are configuring a learning instance with a user-defined document type, the form fields include the address data type, which extracts the entire structure of an address.

Option	Description
Format Date/ Number	<p>Set a standard appearance to convert extracted dates and numbers to a specific format. This ensures consistency and accuracy in your databases and other systems of record.</p> <p>For example, if you select to standardize dates to MM/DD/YYYY and a processed document contains a date that appears as 12 Feb 2023, the learning instance will reformat the date to 02/12/2023.</p> <p>If you select to standardize numbers to the English (United States) locale and a processed document contains a number that appears as 100,00, the learning instance will reformat the number to 100.00.</p>
Required	<p>Select one of the following:</p> <ul style="list-style-type: none"> <li>• <b>Required:</b> Field cannot be empty.</li> <li>• <b>Optional:</b> Field can be empty or not exist in the document.</li> </ul>
Default aliases	No action is necessary for this field. Document Automation assigns default aliases, which are hardcoded keywords, to standard fields to help with extraction.
Custom aliases	<p>Additional keywords to help Document Automation locate the field. For example, add country or region-specific names for fields such as VAT number as an alias to an Organization tax number custom field.</p> <hr/> <p><b>Note:</b> Custom aliases must be unique. They cannot duplicate the default alias of another field. Exception: Form fields can have duplicate custom aliases as the table fields and vice versa.</p> <hr/>
Validation rules	<p>Depending on data type, create rules using patterns, formulas, lists, and statements such as starts or ends with.</p> <p><a href="#">Formula validation</a> on page 3657   <a href="#">Pattern validation</a> on page 3661</p>

6. Click **Create**.

Upload documents to the learning instance, fix validation errors, and verify the extracted data:  
[Process documents in Community Edition](#) on page 3728

## Process documents in Community Edition

Upload sample invoices to train the learning instance, verify the extracted data, and fix validation errors.

- If you have not done so already, [Create a learning instance in Community Edition](#) on page 3726
- Ensure that each file is 2 MB or less.
- Ensure that the sample invoices are in the following supported document types:
  - PDF
  - JPG
  - JPEG
  - PNG



- TIF
- TIFF

Upload sample invoices to a learning instance to test the learning instance's data extraction capabilities. If a document requires manual validation, the system sends it to the Validator, where you must manually enter the correct data.

**1.** Upload documents to the learning instance:

---

**Note:** Community Edition can process a maximum of five documents at a time. You must wait for a document to successfully complete processing (and validation if necessary) to upload another document.

---

- a) Click **Process documents**.
- b) In the **Process Documents** window, click **Browse** to select the files to upload.
- c) In the **Download data to** field, enter the file path where the extracted data is output to a CSV file.
- d) Click **Process documents**.  
The Bot Runner window appears. The window disappears when the documents are done processing. Refresh the **Learning instances** table to see the updated metrics.

If there is a value next to the **Validate documents** link, you must manually validate the fields with errors. Otherwise, proceed to step 2b to review the extracted data.

**2.** Fix the validation errors

- a) Click **Validate documents**.  
The Automation Co-Pilot Task Manager opens in a new tab, with the first failed document in queue. For an introduction to the Validator user interface, see [Using the Automation Co-Pilot Task Manager Validator for Document Automation](#) on page 3688.
- b) Review each field to verify the data type and extracted value.  
Document Automation supports the following data types: text, number, date, address, and check box  
Alternatively, from the drop-down list on the right panel, you can select **Show fields that need validation**.

---

**Note:** When documents are awaiting validation, if you edit the learning instance, click **Reprocess** to reattempt extraction.

Reprocessing documents does not affect the uploaded documents metric.

---

- c) Update the fields with errors.  
Click the field or draw a box around the values that you want to extract.  
For Automation Anywhere pre-trained models, you can configure the learning instance to extract specific values in a field and ignore others. For more information, see [Using validation feedback to extract specific values in a table](#) on page 3664.

- To skip a document without correcting errors, click **Skip** to proceed to the next document in the validation queue.
- To remove a document that cannot be processed, click **Mark as Invalid**.

- d) After you make the necessary corrections, click **Submit** so that the document can finish processing.  
The next document in queue appears. When all the documents are corrected, the system displays a message stating that no more tasks are available.
  - e) Close the tab to return to the **Learning Instances** page.
3. Verify the output results:
- a) Open the file in the **Success** folder that contains the extracted data and review the results to ensure that it matches your use case.  
The Microsoft forms return extracted values (OCR data) in the JSON format, such as `GUID_0-MSFormTableResult.json`. Along with the extracted document data in `<<GUID>>_FileName` CSV file, the **Success** folder also shows the extracted table data separately in another CSV files. Based on the number of tables in the document, you can find different CSV files for each table. For example, `<<GUID_PAGE_NUMBER-Table_FILENAME_PAGENUMBER_TABLENUMBER`.  
  
With separate table data, you can compare extracted data with Microsoft engine data in the `GUID_0-MSFormTableResult.json` file.
  - b) Optional: Review the **Learning Instance** dashboard.  
The dashboard displays the total number of uploaded documents and the number of documents pending validation.

Congrats! You have now successfully processed your first documents in the Community Edition version of Document Automation.

## Automation 360 IQ Bot

Automate document-centric business processes, end to end, by using IQ Bot, a web-based, Cloud-native intelligent document processing solution that can read and process complex documents and email. This solution combines RPA with AI techniques to extract and classify semi-structured and unstructured data.

Automation 360 IQ Bot is a hybrid solution for On-Premises and Cloud deployments.

---

**Note:** From Build 4695 (A2019.13), Automation 360 IQ Bot has feature parity with IQ Bot Version 11.3.4.2 and some features from Version 11.3.5. For feature parity information between Automation 360 IQ Bot and the corresponding IQ Bot 11.x versions, see [Automation 360 IQ Bot feature comparison matrix](#) on page 1005.

---

### Overview

The technologies of IQ Bot and RPA together constitute cognitive automation. With cognitive automation, IQ Bot extracts semi-structured and unstructured data and converts it into structured data, and RPA bots subsequently use this structured data for automating business processes.

IQ Bot works by using learning instances. A learning instance is a structure that holds information such as document type, language, and fields to be extracted from tables and forms. A learning instance also includes bots that are trained to extract data from documents.

IQ Bot is also supported by RPA bots that are built for functions such as training the Classifier, sharpening document resolution, and downloading the extracted data.

After the bots in a learning instance are trained and the necessary RPA bots are built, a learning instance is set to production mode. After that, IQ Bot can start processing documents automatically, through the following steps:

1. Retrieves documents from a source, such as attachments in incoming email
2. Improves document quality
3. Classifies documents into groups
4. Extracts data
5. Either downloads the extracted data or first sends the document for manual validation and then downloads the data

### Types of IQ Bot users

In many organizations, different types of users perform specific tasks within their product area to create, configure, and publish a learning instance and the supporting assets. To learn more about the user types, required licenses, roles, and permissions, and the assigned product areas, see [IQ Bot user personas](#) on page 3734.

The following diagram demonstrates the sequence of how a learning instance and supporting assets are built, as well as which user performs which task.

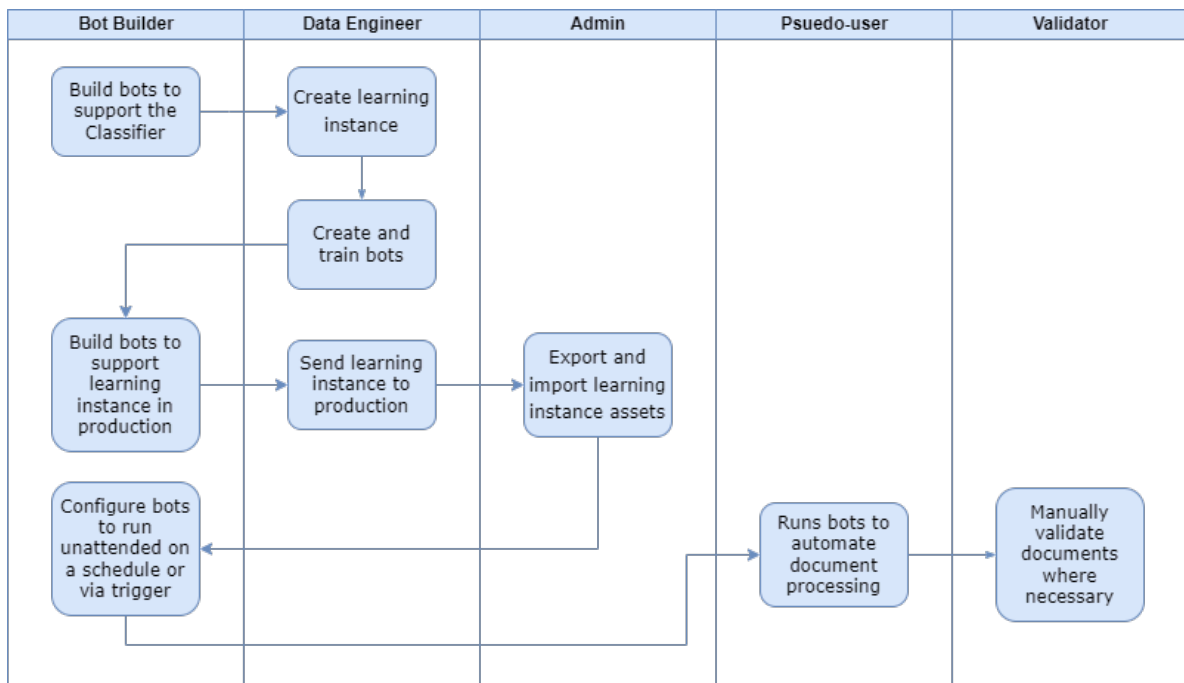

### Get started with learning instances

Perform the following these steps to create a learning instance, train bots, and set the bots to production:

- [Using Automation 360 IQ Bot On-Premises](#) on page 3733
- [Using Automation 360 IQ Bot Cloud](#) on page 3733

## Build RPA bots for IQ Bot

The following links guide you in configuring RPA bots to support IQ Bot functions.

- Use the Document Classifier package to improve classification and prevent invalid documents from being uploaded to a learning instance.

[Train the classifier](#) | [Classify documents](#)

- Use the IQ Bot Pre-processor package to prepare documents and extract data before processing.

[Using Enhance Image action](#) on page 2745 | [Using Convert Image To PDF action](#) on page 2743

- After sending a learning instance to production, configure a bot with the **Process documents** action from the IQ Bot Extraction package: [IQ Bot Extraction package](#) on page 2749
- [Download extracted data](#)

## Resources

For more information, review the courses in the IQ Bot Developer learning trail: [IQ Bot Developer Training \(A-People login required\)](#).

You can also search for the following courses in [Automation Anywhere University: RPA Training and Certification \(A-People login required\)](#):

- Intelligent Document Processing with IQ Bot
- Unleash Your Intelligent Bots: Develop Cognitive Bots Driven by AI & Machine Learning (IQ Bot)

Related concepts

[Install and update Automation 360 IQ Bot](#) on page 1426

This collection of topics guide you through the process of installing or setting up Automation 360 IQ Bot On-Premises and Cloud.

[Languages supported in Automation 360 IQ Bot](#) on page 3739

Up to 31 languages are supported in IQ Bot. You can also access up to 190 languages in IQ Bot by using an OCR engine.

## IQ Bot architecture diagram

This diagram shows the different components of IQ Bot architecture.

Use the IQ Bot, components, Designer and Validator for designing and validating bots, respectively. In a typical scenario, IQ Bot portal and IQ Bot platform communicate through a network firewall and a load balancer.

Various protocols are used to communicate between the different components. A database server, a file storage server, and servers for IQ Bot are used. An organization has the flexibility of using a separate server for the database or using the Control Room clusterdatabase. A firewall

is between the external components, web browser and Bot Runner, and the data center load balancer. Chrome is the supported browser.

## Using Automation 360 IQ Bot On-Premises

Create a learning instance, train the bots to extract data from documents, and push the learning instance to the production environment.

Complete the steps to [install IQ Bot](#).

You must be assigned either the IQ Bot Admin or IQ Bot services roles.

As you configure a learning instance, a Bot builder creates RPA bots to support the learning instance functions. For more information, see [IQ Bot process overview](#).

1. In Automation 360 IQ Bot, click the **LEARNING INSTANCES** tab to create a new learning instance, upload sample documents to train, and select the OCR engine for document processing.  
[Create a learning instance](#) on page 3746  
[Select an OCR engine](#) on page 3748
2. Train the uploaded sample documents in the IQ Bot Designer.  
[Train a learning instance](#) on page 3756
3. As you finish training each bot, set it to Production mode. When all the bots are in Production mode, set the learning instance to Production mode so it can start processing real documents.  
[Tasks performed from Bot page](#) on page 3760  
[Set learning instance to Production](#) on page 3787

## Using Automation 360 IQ Bot Cloud

Create a learning instance, train the bots to extract data from documents, and push the learning instance to the production environment.

Complete the steps to [install IQ Bot](#).

You must be assigned either the IQ Bot Admin or IQ Bot services roles.

As you configure a learning instance, a Bot builder creates RPA bots to support the learning instance functions. For more information, see [IQ Bot process overview](#).

1. In Automation 360 IQ Bot, click the **Learning Instance** tab to create a new learning instance and upload sample documents to train.  
[Create a learning instance](#) on page 3746

---

**Note:** As Tegaki API OCR requires a separate On-Premises set up that is not supported in Automation 360 IQ Bot Cloud, all other OCR engines except the Tegaki API OCR are available.

- You will always have the latest version of the OCR engines supported by Automation 360 IQ Bot Cloud, but cannot select a specific OCR version.
- You cannot configure OCR settings from the Control Room. Starting with Automation 360 IQ Bot.19 version, we have provided an internal API that can be used to configure OCR settings in the database.

2. Train the uploaded sample documents in the IQ Bot Designer.  
[Train a learning instance](#) on page 3756
3. As you finish training each bot, set it to Production mode. When all the bots are in Production mode, set the learning instance to Production mode so it can start processing real documents.  
[Tasks performed from Bot page](#) on page 3760  
[Set learning instance to Production](#) on page 3787

## IQ Bot user personas and roles

Learn about the users that contribute to IQ Bot and the associated roles and licenses. IQ Bot users and roles are defined in the Control Room.

### IQ Bot user personas

A persona refers to the type of tasks that a user performs and the product areas with which a user interacts. To learn more about how each user contributes to IQ Bot, see [IQ Bot process overview](#).

User type	Description	Roles, permissions, and licenses	Access to product areas	Related links
Bot builder	Builds RPA bots to support IQ Bot functions such as training the Classifier and pre-processing documents	Bot developer role + Bot creator license	Automation 360	<a href="#">Build RPA bots for IQ Bot</a> on page 3732
Data engineer	Creates learning instances, trains bots, and sends bots to production	IQ Bot Admin or IQ Bot services roles	Following tabs in Automation 360 IQ Bot <ul style="list-style-type: none"> <li>• <b>Dashboard</b></li> <li>• <b>Learning Instances</b></li> <li>• <b>Bots</b></li> <li>• <b>Domains</b></li> <li>• <b>Administration (IQ Bot Admin only)</b></li> </ul>	<a href="#">Using Automation 360 IQ Bot On-Premises</a> on page 3733 <a href="#">Using Automation 360 IQ Bot Cloud</a> on page 3733

User type	Description	Roles, permissions, and licenses	Access to product areas	Related links
Admin	Uploads custom domains and migrates learning instances between IQ Bot environments	IQ Bot Admin role or a custom role with the migration utility permission	Following tabs in Automation 360 IQ Bot <ul style="list-style-type: none"> <li>• <b>Dashboard</b></li> <li>• <b>Learning Instances</b></li> <li>• <b>Bots</b></li> <li>• <b>Domains</b></li> <li>• <b>Administration</b></li> </ul>	<a href="#">Custom domains in IQ Bot</a> on page 3796 <a href="#">Migrate learning instances</a> on page 1725
Pseudo-user	Runs the RPA bots to upload, pre-process, classify, and extract data from documents in IQ Bot	Unattended Bot Runner license + view learning instance permission	Automation 360 and IQ Bot	
Validator	Manually corrects fields in documents that IQ Bot could not process	Validator role	Only the learning instances to which permission is granted	<a href="#">Use the IQ Bot Validator</a> on page 3790

## IQ Bot roles

A role determines the areas in IQ Bot to which you have access. Roles are assigned in the Control Room and are of two types, predefined system roles and custom roles. If your user type is Admin, you can create custom roles.

- System roles: These roles are built in and have a predefined set of permissions that cannot be customized.
- Custom roles: These roles can be customized and modified to grant granular permissions to an IQ Bot user. An admin can configure the scope of a role with organization-wide permissions to manage all organizational resources or more narrowly to be limited to department-level resources. For more information, see [Defining a custom role for IQ Bot](#) on page 3736.

The following table describes the permissions and access areas applicable to each system role:

System role	IQ Bot permissions	Access to tabs
AAE_IQ Bot Admin	Access to all IQ Bot features and can migrate learning instances between environments	<ul style="list-style-type: none"> <li>• <b>Dashboard</b></li> <li>• <b>Learning Instances</b></li> <li>• <b>Bots</b></li> <li>• <b>Domains</b></li> <li>• <b>Administration Migration utility</b></li> </ul>
AAE_IQ Bot Services	All permissions related to learning instances	<ul style="list-style-type: none"> <li>• <b>Dashboard</b></li> <li>• <b>Learning instances</b></li> <li>• <b>Bots</b></li> </ul>
AAE_IQ Bot Validator	Can launch the Validator for granted learning instances	Learning instances

Related concepts

[Defining a custom role for IQ Bot](#) on page 3736

For various roles within IQ Bot, you can use role-based access control (RBAC) to enable or restrict user access to learning instances, related features, and functionality by defining granular permissions. You can also use RBAC to define custom roles in IQ Bot.

Related tasks

[Creating a user with an IQ Bot specific role](#) on page 3737

Create users in the Control Room to access IQ Bot.

Related reference

[Automation 360 licenses](#) on page 1407

The **All Licenses** page displays detailed information about current product and device licenses.

## Defining a custom role for IQ Bot

For various roles within IQ Bot, you can use role-based access control (RBAC) to enable or restrict user access to learning instances, related features, and functionality by defining granular permissions. You can also use RBAC to define custom roles in IQ Bot.

IQ Bot supports two types of role definitions:

- System roles in Control Room: These roles are built-in and have a pre-defined set of permissions that cannot be customized. To learn more, see [IQ Bot roles](#) on page 3735.
- Custom roles in Control Room: These roles can be customized and modified to grant granular permissions to an IQ Bot user. If you are an admin, by creating a custom role, you can grant users access to specific learning instances.

If you are a user with the **View and Manage Roles** permission, you can use the Control Room to create and assign custom roles.

Permission	Description
View my learning instances	Allows a user to access their own learning instances.



Permission	Description
View learning instances from the same role	Allows a user to view only learning instances created by the same role.  <b>Note:</b> If multiple users are assigned the same role, then all these users will have access to the same learning instances.
View all learning instances	Allows users to view all learning instances created by any user across all roles.
Edit learning instance	Allows users to edit learning instances.
Delete learning instance	Allows users to delete learning instances.
Send learning instance to production	Allows users to move learning instances from staging to production.
Import domain	Allows users to import domains into IQ Bot.

Things to remember:

- Ensure that users with **View learning instance from the same role** do not have non-IQ Bot roles. Example: When you create a learning instance, all the roles that you have under your name gets assigned to the learning instance. So, if you have AA\_Basic role in combination with View learning instance from the same role, then all the users with AA\_Basic role have access to IQ Bot. Therefore, users who create learning instances must not be assigned non-IQ Bot roles.
- It is required that creators of learning instances for a specific department must be assigned a minimum of two roles:
  - A role that allows them to create learning instances
  - A department-specific role with the **View learning instance from the same role** permission
- When new learning instances are migrated, existing roles will not be migrated. After the roles are assigned in the target system, they cannot be changed. IQ Bot Automation 360 does not support changing role assignments of learning instances.

Related tasks

[Create a role](#) on page 1748

As an administrator, you can configure roles with permissions to access features and perform operations such as create, edit, or delete a bot in the Control Room, and assign the role to a user.

[Creating a user with an IQ Bot specific role](#) on page 3737

Create users in the Control Room to access IQ Bot.

## Creating a user with an IQ Bot specific role

Create users in the Control Room to access IQ Bot.

Create administrator, services, and Validator IQ Bot users with Microsoft Windows credentials using the following roles in the Control Room:

- **AAE\_IQ Bot Admin**
- **AAE\_IQ Bot Services**

---

- **AAE\_IQ Bot Validator**

---

**Tip:** The Active Directory users are authenticated with their Active Directory credentials, and the non-Active Directory users are authenticated with the credentials stored in the Control Room database.

---

Users in Control Room are created depending on the type of user configured during installation.

---

**Note:** IQ Bot supports 50 concurrent users. However, Document Extraction if all users are active at the same time, then you cannot run Document Extraction in parallel. Additionally, if the number of concurrent users exceeds 50, system performance might degrade.

---

1. Log in to Control Room as a user with the **AAE\_Admin** role.
  2. Go to **Administrator > Users**.
  3. Click the **Create User** icon.  
The **Create User** page appears.
  4. Enter the required information on the Create User page.
- 

**Note:**

- The **First name**, **Last name**, and **Description** fields are optional. For a first name and last name, use numbers, spaces ( ), period (.), hyphen (-), and underscore (\_).
  - For a Non-Active Directory user, provide information in each field.
- 

5. To create a user with the administrator role, select **AAE\_IQBotAdmin**. To create a user with the services role, select **AAE\_IQBotServices**. To create a Validator role, select the **AAE\_IQBotValidator** role.
6. Select a license to be allocated to the user from the **Allocate a device license to user** section.  
If no license slots are available for a role, an alert message appears.
7. Click **Save** to create the user.

To switch a user type from Development to Run-time or vice versa, depending on the automation requirements of your organization, update the license type from the License Management section in Control Room.

After a Validator or a services user is created, an email is sent to the user. The user is asked to do the following:

- Verify the email ID and set the Control Room access password, if the Control Room is configured for the Non-Active Directory users.
- Verify the email ID, if the Control Room is configured for the Active Directory users.

Related concepts

[Defining a custom role for IQ Bot](#) on page 3736

For various roles within IQ Bot, you can use role-based access control (RBAC) to enable or restrict user access to learning instances, related features, and functionality by defining granular permissions. You can also use RBAC to define custom roles in IQ Bot.

## Languages supported in Automation 360 IQ Bot

Up to 31 languages are supported in IQ Bot. You can also access up to 190 languages in IQ Bot by using an OCR engine.

When you review the list of languages in IQ Bot, you will observe the following:

- Some languages are listed multiple times as variants, for example, Norwegian, Norwegian (Bokmal), Norwegian (Nynorsk).
- Among languages that are written from right to left, only Arabic is currently supported on IQ Bot.
- For languages not in the IQ Bot UI by default:
  - These rely on ABBYY FineReader Engine 12.2 for text segmentation and OCR, then IQ Bot for classification, extraction, and auto-correction.
  - Contact your Cognitive Services or Sales Engineering representative to create IQ Bot custom domains to access these languages.
  - In the SQL database and .json file, IQ Bot requires language codes for 160 of the additional languages to appear in the UI, and culture codes to allow numeric and date validation.

---

### Note:

- For ABBYY FineReader Engine and Microsoft Azure Computer Vision OCR engine, IQ Bot uses its text segmentation + OCR.
  - For Microsoft Azure Computer Vision OCR engine, user can select any language from IQ Bot's drop-down, but the API aims to auto-detect the language during processing, and override user selection.
- 

The following table provides a list of supported languages in IQ Bot for various document types:

Language	Document types such as invoice, contracts, health insurance, purchase order, and so on	Document type
English	X	X
German	X	X
French	X	X
Spanish	X	X
Italian	X	X
Afrikaans		X
Arabic		X
Bulgarian		X
Catalan		X

Language	Document types such as invoice, contracts, health insurance, purchase order, and so on	Document type
Chinese (Simplified)		X
Chinese (Traditional)		X
Czech		X
Danish		X
Dutch		X
Flemish		X
Greek		X
Hungarian		X
Indonesian		X
Japanese		X
Korean		X
Latin		X
Malay		X
Norwegian		X
Polish		X
Portuguese		X
Romanian		X
Russian		X
Serbian (Latin)		X
Slovak		X
Swedish		X
Turkish		X

The following table lists the languages that are supported in IQ Bot through a custom domain:

Abkhaz	Galician	Mari	Sioux (Dakota)
Adyghe	Ganda	Maya	Slovenian
Agul	German	Miao	Somali
Albanian	German (new spelling)	Minangkabau	Sorbian
Armenian (Eastern)	German (Luxembourg)	Russian and English	Sotho
Armenian (Grabar)	Guarani	Mohawk	Sunda
Armenian (Western)	Hani	Mongol	Swahili

Avar	Hausa	Mordvin	Swazi
Aymara	Hawaiian	Nahuatl	Tabassaran
Bashkir	Icelandic	Nenets	Tagalog
Basque	Ido	Nivkh	Tahitian
Belarussian	Interlingua	Nogay	Tajik
Bemba	Irish	NorwegianNynorsk and NorwegianBokmal	Tatar
Blackfoot	Kabardian	Norwegian (Bokmal)	Thai
Breton	Kalmyk	Norwegian (Nynorsk)	Jingpo
Bugotu	Karachay-Balkar	Nyanja	Tongan
Burmese	Karakalpak	Occidental	Tswana
Buryat	Kasub	Ojibway	Tun
Chamorro	Kawa	Old English	Turkmen
Chechen	Kazakh	Old French	Turkmen (Latin)
Chukcha	Khakas	Old German	Tuvan
Chuvash	Khanty	Old Italian	Udmurt
Corsican	Kikuyu	Old Slavonic	Uighur (Cyrillic)
Crimean Tatar	Kirghiz	Old Spanish	Uighur (Latin)
Croatian	Kongo	Ossetian	Ukrainian
Crow	Korean (Hangul)	Papiamento	Uzbek (Cyrillic)
Dargwa	Koryak	Tok Pisin	Uzbek (Latin)
Dungan	Kpelle	Portuguese (Brazil)	Vietnamese
Dutch (Netherlands)	Kumyk	Portuguese (Portugal)	Cebuano
Eskimo (Cyrillic)	Lak	Provençal	Welsh
Eskimo (Latin)	Sami (Lappish)	Quechua	Wolof
Esperanto	Latvian	Rhaeto-Romanic	Xhosa
Estonian	Latvian (language written in Gothic script)	Romanian (Moldavia)	Yakut
Even	Lezgin	Romany	Yiddish
Evenki	Lithuanian	Ruanda	Zapotec
Faeroese	Luba	Rundi	Zulu
Fijian	Macedonian	Russian (old spelling)	

Finnish	Malagasy	Russian (with accents marking stress position)
Frisian	Malinke	Samoan
Friulian	Maltese	Selkup
Scottish Gaelic	Mansi	Serbian (Cyrillic)
Gagauz	Maori	Shona

The following table provides you with links to supported languages for all IQ Bot supported OCR engines:

IQ Bot supported OCR engines	List of supported languages
ABBYY FineReader Engine	<a href="#">ABBYY FineReader Engine OCR supported languages</a>
Microsoft Azure Computer Vision OCR engine	<a href="https://docs.microsoft.com/en-us/azure/cognitive-services/computer-vision/language-support">https://docs.microsoft.com/en-us/azure/cognitive-services/computer-vision/language-support</a>
Google Vision API	<a href="https://cloud.google.com/vision/docs/languages">https://cloud.google.com/vision/docs/languages</a>
Tesseract4 OCR 4.0.0	<a href="https://tesseract-ocr.github.io/tessdoc/Data-Files-in-different-versions.html">https://tesseract-ocr.github.io/tessdoc/Data-Files-in-different-versions.html</a>
Tegaki API	<ul style="list-style-type: none"> <li>• Japanese</li> <li>• Korean</li> <li>• Japanese - English</li> <li>• Korean - English</li> </ul>

**Note:** The supported languages in IQ Bot must be considered in concurrence with the OCR supported languages.

**Tip:** If you are unable to see all languages in the IQ Bot UI or if IQ Bot is unable to extract data from multiple languages in a document, troubleshoot the issue:

[Unable to extract data from Multiple languages in a document \(A-People login required\)](#)

**Note:** If you are adding custom language to a custom domain, then you must retain the language ID across all installations from where IQ Bot learning instances will be exported and imported.

## About the Classifier

Learn about how documents are classified and the factors that affect classification.

When documents are uploaded to a learning instance, the Classifier sorts the documents into document groups based on the layout, which is the order in which the fields appear on the page. If a document is uploaded to a learning instance in production and the document does not match the layout of any of the document groups, the Classifier creates a new group for that document.

The following graphic illustrates how uploaded invoices that contain specific fields are sorted into one of three groups, depending on the order in which the fields appear in the invoice.

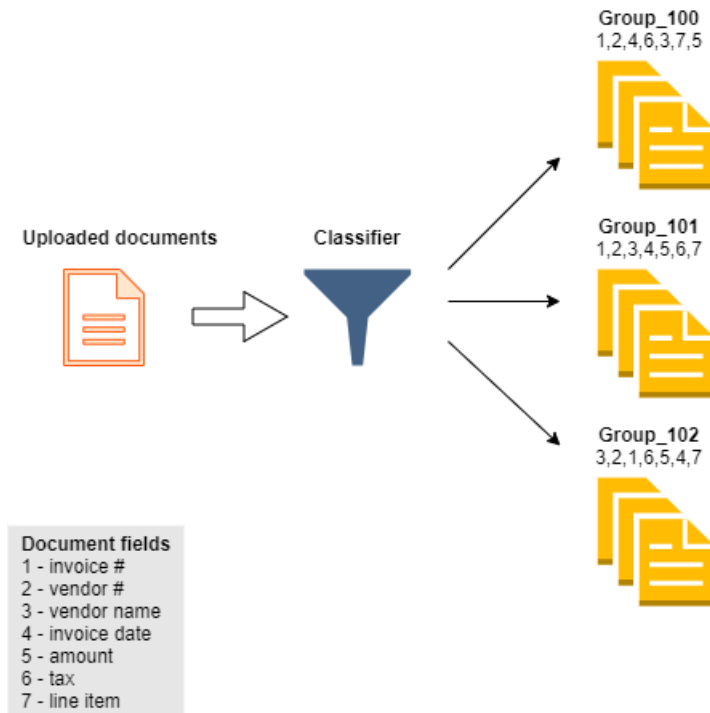

Alternatively, you can manually define a document group to process all the documents with an identical layout. In this case, IQ Bot bypasses the Classifier and sends the document to the group you created that has the same layout as the uploaded document. This option is useful when the OCR fails to detect one or more fields in a document, causing the Classifier to unnecessarily create a new document group or send the document to the wrong group. See [Create a new document group](#) on page 3745.

---

**Note:** User-created document groups cannot be deleted.

---

The Classifier is supported by RPA bots and the Document Classifier package. It contains actions that automate identifying and sorting the different document types. See [Document Classifier package](#) on page 2506.

## Resources

Watch the following videos to learn more about how the Classifier works and how to use it:

## Learning instances created with out-of-box or custom domains

IQ Bot checks for a minimum number of fields that you selected to successfully classify the document. In all other cases, the document will be marked as unclassified.

For example:

- If you create a new learning instance with one to four fields selected, IQ Bot checks for at least four fields from the total number of fields presented for that specific learning instance. Similarly, if you create a learning instance with five fields selected, IQ Bot checks for at least five fields.
- If you create a learning instance with six or more fields selected in the learning instance, IQ Bot checks for at least six fields. For example, if you selected eight fields in an invoice domain, IQ Bot checks for at least six fields out of the total fields available.

## Learning instances created with other domains

If you create a learning instance with multiple fields, IQ Bot checks for at least one field and classifies the document. If IQ Bot does not find any field, the document will be marked as unclassified.

## Factors that impact classification

Factor	Notes
Page layout	If the page layout is different from the original document with respect to document content position, IQ Bot sends the document to a different group.
Label orientation	All the labels in a document must be oriented in the same direction. If some of the labels are vertical and some horizontal, the document is sent to a different group.
Label position	Labels can be positioned anywhere on the page. However, the label sequence from left to right and top to bottom must be the same as in the training documents.
Match percentage	IQ Bot uses a 70% match for labels.
Fields added after the learning instance is created	Fields added after a learning instance is created are excluded from the classification process.

Related tasks

[Limit the creation of document groups](#) on page 3753



Limit the number of new document groups that the Classifier can create when a learning instance is in production.

## Create a new document group

Manually define a user-created document group to process documents with an identical layout. For example, invoices from a specific supplier.

- If you have not done so already, [Create a learning instance](#) on page 3746. After you create a learning instance, you are redirected to the document groups page, where you create a new document group.
- Identify the group label. This is the name of the folder in the `documents\classify\train` directory where documents with an identical layout are sent. You will provide the group label in the steps below.
- Identify sample documents (maximum 150) that have an identical layout. You can upload more documents to train the group after the group is created.

1. Navigate to the learning instance details page and click **Create group**.
  2. In the **Group label** field, provide the folder name that contains the sorted documents in the `documents\classify\train` directory.
  3. Click **Browse** to upload sample documents to define the layout.
  4. Click **Save**.
1. Configure the mechanism to sort incoming documents to the correct group:
    - To use the Classifier, run the bot with the **Train Classifier** action to create the classification model and sub-folders to hold the sorted documents in the `documents\classify\train` directory. See [Using Train Classifier action](#) on page 2510.
    - Alternatively, create RPA bots identify and sort incoming documents using conditional statements, such as string-matching the file name or sender. See the String condition in the [Loop package](#) on page 2784 or [If package](#) on page 2724.
  2. Update the following actions:
    - Optional: Update the **Classify Document** action to use **Express mode**. See step 6 in [Using the Classify document action](#) on page 2509.
    - Update the **Upload document** action to provide the group label. See step 4 in [Upload document action](#) on page 2759.
  3. Upload more documents to train the group. When you are done with training, set the group to production.
  4. After you set the group to production: If you have a bot with the **Process Documents** action, you must update the action with the group label. See step 7 in [Using IQ Bot Process documents action](#) on page 2757.

---

**Note:** During the production process, you must not move the learning instances or bots from Staging to Production or vice-versa.

---

## Create a learning instance

Create a learning instance and upload sample documents for training. In this step, you define the data elements for a single document type, such as an invoice or a purchase order, and the fields which you want to extract.

Ensure the sample documents meet the following requirements:

- Each document is a separate file. For example, if you have downloaded an email and its attachments into a single PDF, you must separate the email body from the attachments. See [Using the Split document action](#) on page 2887.
- The documents are in one of the following supported file types:
  - PDF
  - JPG
  - JPEG
  - PNG
  - TIFF
- Use documents with a resolution value of at least 300 dots per inch (dpi).
- In staging, you can upload a maximum of 150 documents of 10 MB file size per learning instance.
- In production, you can upload a maximum of 50 MB file size per document. However, the maximum number of documents allowed per learning instance depends on the license.
- There are no limitations on the number of pages per document in a pdfbox OCR.
- You can upload 60 pages per document in an image-based OCR.
- You can upload up to a file size of 12 MB. You can upload additional documents after creating the learning instance.
- The file names of the documents that you upload should not start with special characters, such as the hyphen (-).

---

### Note:

- With the Tesseract4 OCR, currently there is a known limitation which restricts the number of pages per document to less than 60 pages.
- Azure confidential computing enables organizations to upload encrypted data to secured storage, such as private folders on a virtual machine. If you upload documents from such secured folders to IQ Bot, these are moved to **Unclassified** status as data extraction is not supported for such documents.

---

When you start with a collection of documents to insert into a digital process, you will probably have a mix of documents types, formats, and orientations. An invoice, for example, has a consistent set of data elements, whereas a purchase order contains a different set of data elements. You must create a different learning instance for each of these document types, using the following steps:

1. Navigate to **LEARNING INSTANCES** and click the **New instance** option.
2. In the **Create new learning instance** screen, enter the following information:
  - a) **Instance name:** Enter a unique name.  
IQ Bot version A360.21 and below does not allow duplicate learning instance names. Even if you delete a learning instance, the name cannot be reused. From IQ Bot version

A360.22, it is possible to create duplicate learning instance names, as well as reuse the name of a deleted learning instance.

**b) Optional: Description:** Enter a description.

**c) Document type:** Select the document type from the drop-down list.

Do not choose standard forms as **Document type** while creating learning instance. Based on the option you select, a predefined set of form and table fields for the domain type appears. For example, when you select **Invoices**, the common forms and tables of an invoice appear.

---

**Note:** If you want to create a domain to use specifically for this learning instance, select **Document type > Other** and enter a domain name. In the upcoming steps, you will customize the domain.

For more information on creating a custom domain, watch the following video:

If you want to create a domain to use in more than one learning instance and you have the required access permissions, you can work with Automation Anywhere support to create a custom domain. See [Custom domains in IQ Bot](#) on page 3796 for more information.

---

**d) Primary language of documents:** Use the drop-down menu to select a language for the learning instance.

[Languages supported in Automation 360 IQ Bot](#) on page 3739

To create custom domains in other languages and access up to 190 languages that IQ Bot supports, contact Automation Anywhere support.

---

**Important:** If you are unable to see all languages in the IQ Bot interface, troubleshoot the issue: [Unable to extract data from Multiple languages in a document \(A-People login required\)](#)

---

**e) Upload your documents:** Click the **Browse** option to upload sample documents.

**3. Select or de-select fields in the Common form fields and Common table/repeated sections fields sections.**

Form fields appear one time in a document, such as the invoice date or number. Table fields are fields that reoccur throughout the document, such as the item total or quantity.

To see all the possible fields, click **Additional form fields** or **Additional table/repeated section fields**.

**4. Optional: Add additional fields by entering the field name in the Additional form fields or Additional table/repeated section fields section.**

Follow the naming conventions when you enter a name in the **Add fields (Optional)** field:

- Field names can only begin with alphabetical characters (A-Z and a-z).
- Field names can only include alphanumeric characters and spaces.
- Field name cannot end with a space.

**5. Optical Character Recognition:** Select the required OCR engine.

[Select an OCR engine](#) on page 3748

**6. Optional: De-select the My PDF documents do not have images check box.** To learn more, see [Disable PDFBox option](#) on page 3755

When this check box is selected, IQ Bot uses PDFBox OCR to process PDF documents; non-PDF documents are processed by the OCR you selected in the previous step.

- 7. Checkbox auto-detection:** Select the **Detect checkboxes** check box to enable this feature. Selecting this option allows IQ Bot to automatically detect check boxes in a document. However, it might increase the processing time of documents.
- 8.** Click the **Create instance and analyze** option to create the learning instance. The system analyzes and sorts the training documents into logical groups based on field identification and shows the details in the **Learning Instance > Summary** tab.

When a new learning instance is created, the sample documents you uploaded are analyzed and sorted into groups based on the document characteristics. To learn more, see [About the Classifier](#) on page 3743.

After the Classifier finishes sorting the documents, you are redirected to the Designer, where you will train bots to extract data from each sample document. [Train a learning instance](#) on page 3756.

Related tasks

[Select an OCR engine](#) on page 3748

You can select an OCR engine that suits your requirement for data extraction based on your document types. Restarting IQ Bot services is not necessary for implementing an engine change.

Related reference

[Create a learning instance for standard forms](#) on page 3809

Learning instance is used in IQ Bot to extract, train, validate content from standard forms. Use the following instructions to create a learning instance for processing standard forms in IQ Bot

## Select an OCR engine

You can select an OCR engines that suits your requirement for data extraction based on your document types. Restarting IQ Bot services is not necessary for implementing an engine change.

During IQ Bot installation, the system sets the latest version of Tesseract Optical Character Reader as the default OCR engine. This is also the default setting for the product. However, you can manually set the OCR engine in the `Settings.txt` file, which becomes the default engine. Similar to the prior releases of IQ Bot, you can continue to manually update the `Settings.txt` file with the OCR engine name you want to set as default.

When creating a learning instance, you can select an OCR engine from the **Optical Character Recognition** drop-down menu. See [Create a learning instance](#) on page 3746

---

**Note:** Selecting an OCR engine in the interface overrides the settings in the `Settings.txt` file.

---

The following table lists the various OCR engines supported in IQ Bot and the corresponding options:

Table 12: List of OCR engines and their specifications

Qualifiers	OCR Version	Supported installation	Handwritten	Languages Supported	Document Quality	Document Type
Tesseract OCR	4	Cloud and On-Premises	N/A	English German Spanish Italian French	No noise No dark background No stamps/watermarks 200+ dpi	Invoices, POs, etc. Semi-structured formats
ABBYY FineReader Engine	12.3, or 12.4	Cloud and On-Premises	N/A	English All Latin+ Chinese Japanese Korean	Less noise Dark background with white fonts Has stamps/watermarks 96+ dpi	Invoices, POs, etc. Semi-structured formats Mortgage Forms, Tax Forms Unstructured Formats
Microsoft Azure Computer Vision OCR engine	2.0 or 3.2	Cloud and On-Premises	English only	English All Latin+ Chinese Japanese Korean	Less noise Dark background Has stamps/watermarks 96+ dpi	Invoices, POs, etc. Semi-structured formats Passports, Driving license, etc. KYC documents

Qualifiers	OCR Version	Supported installation	Handwritten	Languages Supported	Document Quality	Document Type
Google Vision API	Version is updated automatically to match current release	Cloud and On-Premises	N/A	English All Latin+ Asian	Less noise Dark background Has stamps/ watermarks 96+ dpi	Invoices, POs, etc. Semi-structured formats Mortgage Forms, Tax Forms Unstructured Formats

1. On the **Create a new learning instance** page, select the domain and language of the documents.

In the **My learning instance** list page, a new **OCR Engine** column is available that shows the OCR engine used for creating each learning instance. This information is useful to the user when deciding on document processing.

2. The **Fields to extract** and **Advanced Settings** sections are displayed when you select the domain.

Each domain is available with a predefined list of primary supported languages. Language selection is enabled and available from the **Primary language of documents** drop-down list based on supported languages for a specific domain.

**Note:** If you select a language from the **Primary language of documents** drop-down list and then select an engine that does not support that language, the system displays an error message in the **Optical character recognition** drop-down list.

3. Click **Advanced Settings > Optical character recognition** to display the OCR engine options drop-down list.

If the OCR engine selection is invalid, the **Create instance and analyze** option is not enabled.

**Note:** IQ Bot automatically installs all OCR engines during the installation process, except for ABBYY FineReader Engine.

**Important:** You can only configure the selected OCR engine in Automation 360 IQ Bot On-Premises. OCR settings in Automation 360 IQ Bot Cloud cannot be edited as they are not accessible except for ABBYY FineReader Engine. You can edit the configuration settings for ABBYY FineReader Engine using the `appConfigurations` REST API.

You can select from the following:

Option	Description
Tesseract OCR 4	This is the default engine, unless changed in the <code>Settings.txt</code> file.

Option	Description
ABBYY FineReader Engine	<p>To verify if ABBYY FineReader Engine is installed and available for use on your machine, check the <code>Settings.txt</code> file, the OCR Plug-ins folder for the SDK files, and the <b>Optical character recognition</b> drop-down list.</p> <hr/> <p><b>Note:</b> Also supported in IQ Bot [Local Device] package and IQ Bot Extraction package.</p> <hr/> <p><a href="#">Use ABBYY FineReader Engine OCR engine in IQ Bot</a> on page 1462</p>
Microsoft Azure Computer Vision OCR engine	<p>IQ Bot supports all languages supported by this OCR engine.</p> <p><a href="#">Use Microsoft Azure Computer Vision OCR engine</a> on page 1459</p>
Google Vision API	<p>IQ Bot supports Google Vision API as an OCR engine and supports all languages supported by this engine.</p> <p><a href="#">Use Google Vision API OCR engine</a> on page 1465</p>
My PDF documents do not have images	<p>All the PDF documents that you upload are processed using the PDFBox OCR by default, regardless of the OCR engine you have specified or selected.</p> <p>If you are uploading non-PDF documents or PDF documents that contain images, clear the <b>My PDF documents do not have images</b> check box to ensure that the OCR engine that you have specified or selected is used to process the documents.</p> <p>The <b>My PDF documents do not have images</b> check box is enabled by default. To disable this feature, see <a href="#">Disable PDFBox option</a> on page 3755.</p>

**Tip:** If IQ Bot is unable to extract data from low quality or handwritten documents, troubleshoot the issue:

[IQ Bot unable to extract data from low quality and Handwritten documents \(A-People login required\)](#)

**Note:** Use the following files to change the OCR settings:

- `AbbyyImagePreProcessingSettings.json`
- `LanguageCodeToAbbyyLanguageCode.json`
- `Azure3OCREngineSettings.json`
- `GoogleOCREngineSettings.json`
- `AzureOCREngineSettings.json`

[How to change OCR Settings in IQ Bot \(A-People login required\)](#)

## Edit a learning instance

Edit a learning instance to change its name, description, add additional training documents, or include additional fields for extraction.

You can only edit a learning instance on Staging. So ensure you move any learning instance in Production environment to Staging to edit it.

1. On the **Learning Instances** page, click a learning instance.
2. Click the **Edit** icon to edit the learning instance.
3. Optional: Update the description field.
4. Optional: Change or update the learning instance name.

When you change the name of a learning instance, the following changes occur:

- A separate folder with the new learning instance name is created in the configured output directory to store the .csv files of processed documents.

The previous folder containing the .csv files before the learning instance name was changed remains as is in the output folder.

- When you migrate a learning instance with an updated name using overwrite or remove options, it is updated in the source environment after the .iqba file is imported.
  - An entry in the audit logs is created for this activity.
5. Optional: Click **Browse** to select additional training documents.

The file names of the documents that you upload should not start with special characters, such as the hyphen (-).
  6. Optional: Select additional fields and table columns to add to the learning instance for data extraction.
  7. Use the **New groups creation setting** field to restrict creation of new groups or set the threshold for the number of groups.

---

**Note:** The **New groups creation setting** field only applies to the documents in Production. However, this field option is not applicable for IQ Bot [Local Device] and IQ Bot Extraction packages.

---

For more information, see [Limit the creation of document groups](#) on page 3753.

8. Optional: Use the **Default validations group** option to select a default group for document validations.

All new documents use the custom logic and validations defined in the default group. Validation rules from this default group are applied when a document does not belong to any of the existing group. If you delete the selected default group, the validation rules are not applied to any of the new documents that were supposed to use this group.

---

**Note:** If you select a default group, you can only change it to another group. However, you cannot select **Select default validation**, which is the default setting.

---

9. Click **Save** to view a confirmation message.
10. Click **Yes, proceed with field addition** to upload, analyze, and classify the selected training documents (if any) that were added to the learning instance.

The classification of documents remain unaffected by the newly added fields.



All additional fields become available in all the bots and appear as optional fields in the selected learning instance. The bots must be retrained for these fields.

See [Errors generated while editing learning instances](#) on page 3754.

## Limit the creation of document groups

Limit the number of new document groups that the Classifier can create when a learning instance is in production.

You can only edit a learning instance that is in staging. If the learning instance is in production, you must revert it to staging.

When documents are uploaded to a learning instance, the Classifier sorts the documents into document groups based on the layout, which is the order in which the fields appear on the page. If a document is uploaded to a learning instance in production and the document does not match the layout of any of the document groups, the Classifier creates a new group for that document.

Use the following steps to either configure a limit for the number of total document groups in the learning instance, or opt to disallow the Classifier from creating new document groups.

1. Navigate to **LEARNING INSTANCES**, select a learning instance, and click **Edit**.
2. Select from the following options:

Option	Description
Select the <b>Never create new groups</b> check box	<p>No new groups are created, irrespective of the number of document uploads. The uploaded documents are sent directly to the Validator.</p> <ul style="list-style-type: none"> <li>• This check box is deselected by default.</li> <li>• When this option is selected, the <b>Threshold to create new groups</b> field is disabled.</li> <li>• You can create new groups manually by uploading them to the learning instance in staging.</li> </ul>
Set a value for the <b>Threshold to create new groups</b> field	<p>When you set a threshold value, IQ Bot does not create a group for the uploaded documents till it reaches the defined value. Till the set threshold value is reached, all documents are sent to the Validator.</p> <ul style="list-style-type: none"> <li>• By default, the value is set to 10 for all new learning instances.</li> <li>• You can set a value of up to 10 digits.</li> <li>• IQ Bot does not allow you to enter non-numerical characters, zero, or floating points.</li> </ul>

3. Save your updates, which are then reflected in the **Summary** tab.

The **Summary** tab displays all the staging and production details. The information is updated based on any applied setting in the **New groups creation setting** section.

For new learning instances, unless you set the minimum threshold in the **New groups creation setting** section, IQ Bot applies the default set value of 10 and does not create groups for the first 9 uploaded documents.

4. For existing learning instances, you can set the minimum threshold in the **Learning Instance > Edit** page. The new threshold is applied to all documents from then onward.



All existing learning instances, even after upgrade, will continue with a threshold as 1.

All changes take effect only on the documents uploaded in production after the setting is edited. If you change the setting to a new threshold or never create new groups with an existing learning instance, this check will be performed only on the next document uploaded in production.

In the production environment, all classified documents that do not belong to any group and do not meet the minimum threshold requirement are sent to the Validator. You can update the values and make necessary corrections. However, all fields are optional and are text data type. The user can **Save current document** without making any corrections, or choose the **Mark as Invalid** option.

### Errors generated while editing learning instances

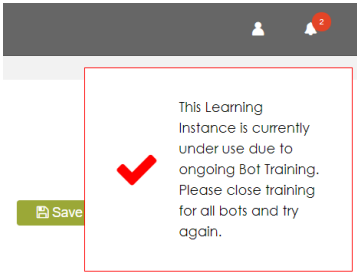
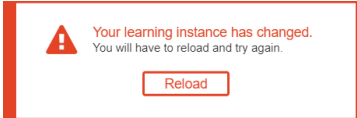
Use case scenarios and error messages generated while editing a learning instance are explained in this topic.

Case	Details	Message
Bot in training	<p>Learning instance is in use because of ongoing bot training and you edit the same instance</p> <p>A) User 2 is editing the same learning instance</p>	
Case 1: Simultaneous editing of same learning instance	<p>Example for case 1:</p> <p>User 1 uploads a document to the same learning instance.</p> <p>User 2 adds a field when editing the same learning instance.</p>	
Run and edit the same bot	<p>Run the bot and then edit the same bot using the same user login or two different user logins.</p>	

## Delete a learning Instance

Use the Learning Instances page to delete a learning instance from the **View Details** page.

You cannot delete a learning instance that is in the production environment. To edit a learning instance, do the following:

1. On the **Learning Instances** page, click the learning instance or **View Instance Details** icon to show the **Summary** tab.
2. On the details page, : click the **Edit** icon. The learning instance becomes available for editing.
3. To delete the learning instance, click the **Delete Instance** button. A confirmation message appears.
4. Enter the learning instance name in the field and delete the learning instance.

---

### Important:

Unless you have already exported the learning instance as a backup, the following occurs after you delete a learning instance:

- It is permanently deleted and cannot be restored.
  - All the associated bots are deleted and cannot be reused.
  - You cannot reuse a deleted name for a learning instance to create a new one.
- 

## Disable PDFBox option

The PDFBox option is enabled by default. Disable the option when you are training hybrid PDF documents containing images and text.

The PDFBox option works best with completely digital documents only. When using hybrid documents containing images and text, our recommendation is to disable the PDFBox option for better document classification.

---

**Note:** The PDFBox option is enabled in the system by default. Ensure that the PDFBox is kept enabled only if you plan to process digital documents, otherwise processing will fail.

---

If PDFBox is enabled, you can process the following PDF types:

- Vector and Hybrid PDF can be processed using PDFBox
- Raster PDF can be first processed using PDFBox, and if no segment is found then the PDF is processed again using Document Image OCR

There are two ways in which you can disable/enable the PDFBox option in IQ Bot:

- Directly in the UI during the creation of a learning instance. In the **Create new learning instance** page go to **Advanced Settings > Optical character recognition** and disable/enable the **My PDF documents do not have images** check-box.
- In the `Setting.txt` file described as follows:

1. Navigate to `C:\Program Files (x86)\Automation Anywhere IQ Bot\Configurations`.

2. Open the `Setting.txt` file, and change `PDFBoxOCREnabled=true` to `PDFBoxOCREnabled=false`  
This turns off the processing of uploaded documents by PDFBox for new learning instances (after applying this change), and does not apply to the existing learning instances. IQ Bot will use your selected OCR engine for PDF documents as well.

---

**Note:** When PDFBox is disabled, ensure that your PDF document is less than 60 pages.

---

3. After updating the `Setting.txt` file, execution of `stoppedanduninstalled` and `installedandstartedstart` of IQ Bot services is not required.

## Train a learning instance

Use the staging environment to train a learning instance and extract data from sample documents. Review each field to verify whether the correct value is extracted and where necessary, map the correct field.

When you upload sample documents while creating a learning instance, the Classifier analyzes and categorizes these documents into logical groups. The system creates a bot for each document group, which you must train to extract data from specific fields in the sample documents.

The following steps provide an overview of the training process:

Step 1: Open the Designer

From the **My Learning Instances** page, open a learning instance and click **Edit bot** or **Create bot** to start training the learning instance.

For an introduction to the components, see [Introduction to the Designer](#) on page 3759.

Step 2: Map the document fields

In the **Fields** section, click each form field to verify whether the correct value is extracted. If the value is incorrect or if the field was not found (indicated by a grayed-out check icon next to the field), you must remap the field.

- [Map a field](#) on page 3763
- [Delete mapping in the Designer](#) on page 3770

Step 3: Map the check boxes (if applicable)

If you configured the learning instance and uploaded sample documents containing check boxes or option buttons, see [Extract data from check boxes or check box groups](#) on page 3768

---

**Note:**

- Check boxes and check box groups can be extracted as either a form or table field depending on whether the check box appears one time or on a recurring basis in the document.

- We do not support classification of encrypted or password-protected documents.

Step 4: Map the table fields

---

Review each table field to ensure that the correct column name is identified in the **Column Value** field. If IQ Bot did not find the correct Column Name, remap the column name by using the same approach as you did for the form fields. Then, configure the table settings. [Map a table](#) on page 3764

If the document contains more than one table, define the additional tables:

1. Add all the table fields to the **Additional table/repeated fields** section of a learning instance. [Edit a learning instance](#) on page 3752.
2. Map the additional table fields. [Add multiple tables in Designer](#) on page 3767.

To establish a relationship between the fields of the different tables, see [Define one or more linked fields in a child table](#) on page 3767.

Step 5: Review the training results

Click **See extraction results** to check the extracted data from the document group. [Preview extracted data](#) on page 3769

If not all of the fields are extracted, try resizing the mapping areas for those fields.

Alternatively, train the bot by using a different document. [Change the training document for a group](#) on page 3760

Step 6: Save the bot

Click **Save and go to next group** to train the bot for the next document group.

A menu appears, with the option to **Cancel**, **Save**, or **Save and send to Production**.

---

**Note:** We recommend that you test the bot (see next step) before sending it to production.

---

You can view the status of all the bots in all your learning instances from the **BOTS** tab. [Manage IQ bots](#)

Step 7: Test bot extraction capabilities

Navigate to the **BOTS** tab and click **Test bot**.

The bot processes the remaining documents in the document group based on the trained document. To see the bot performance, review the values in the **Learning instance**

Step 8: Send the bot to production

**summary** page, particularly the straight-through processing (STP) metric. [Review the learning instance details](#) on page 3770

If the STP number is low, you can either retrain the bot, such as by resizing the mapping areas or train the bot on a different document.

[Change the training document for a group](#) on page 3760

When you are satisfied with the extraction accuracy of the bot, switch it to production mode. Then, switch the learning instance to production mode. Once a learning instance is in production mode, IQ Bot is ready to begin processing documents in real time: classifying the uploaded documents to the document groups with bots in production and either extracting data or sending the document for manual validation.

From the **Learning Instance Details** page, click the switch at the top right to move the learning instance into production mode. [Set learning instance to Production](#) on page 3787

---

**Note:** If you want to retrain a bot, both the learning instance and the bot must be in staging mode.

---

Related concepts

[About the Classifier](#) on page 3743

Learn about how documents are classified and the factors that affect classification.

## Introduction to the Designer

The Designer is the user interface where you train bots to extract data from uploaded sample documents. The Designer contains auto-mapped fields and table columns, where you can you edit the existing mapping or add new fields and tables.

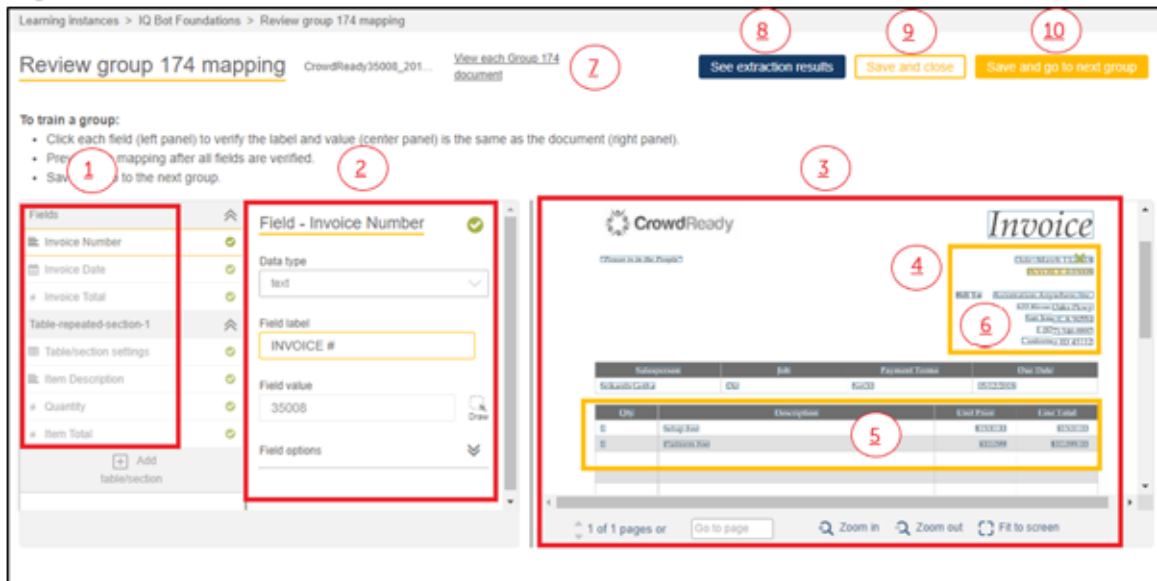

Highlighted areas are:

1. Fields panel: List of fields selected for extraction during Learning Instance creation. Fields successfully found are indicated with a green check mark.
2. Field Details panel: Details for the highlighted field in the Fields Panel, including data type and extracted value.
3. Document Image panel: Rendered image of the document with image view controls
4. Form fields: A field that has a single value in the document, such as the invoice number or invoice date.
5. Table fields: A field with values that appear more than one time in a document, such as the item description or quantity.
6. The blue boxes indicate System Identified Regions (SIRs) where IQ Bot found out extractable data.
7. The training document can be changed by clicking **View each Group (#) document**.
8. The extraction can be tested using **See extraction** results.
9. Save and close: Saves the changes and returns to the Learning Instance details page.
10. Save and go to the next group: Saves changes, allows the Group to be set to Production mode, and moves to the next available Group.

**Note:** If you have multiple files in a group and one of the document is deleted, then you will see an error message **Unable to load document** and you will not be able to change the document for training in the Designer. When the entire multi-page document is deleted or corrupted, you will

not be able to navigate between the pages. If you click the next page button, then the **Loading document** screen is displayed.

---

## Change the training document for a group

During document training, look at unique document layouts available in a group, and choose a different document than the default one chosen by IQ Bot Designer, that is more representative of documents across that group. That helps maximize straight-through processing (STP).

Follow the steps to choose a different document from a document group.

1. User can see the **View each Group 'x' document** button in the Designer training page next to the document name.  
The **View each Group 'x' document** button is disabled if there is a single document in the group.
2. Click the **View each Group 'x' document** button to display the previous and next arrows that will let you move to another document. You can also cancel out of the task.  
Choosing a different document as the group's training document will clear all mapping from the previous document. IQ Bot displays a warning message stating the same.
3. Select a new document and click the **Change the training document** button to see a message confirmation stating: `If you change the training document for this group, any mapping from the previously trained document will be lost. Do you want to change the training document for <group name> to <document name>?`
4. Choosing **No, cancel** takes you back to the Designer, whereas confirming the message **Yes, change** loads and launches the new document with auto-mapped fields.
5. Click **See extraction results** to view extracted data from the new document.

## Tasks performed from Bot page

This page lists all the available bots for a learning instance, and enables you to perform tasks such as run, change the status, or launch the IQ Bot Designer.

Create a bot to extract text from a document. Define the field labels and values in a document so that the system can learn from it and automatically process other documents in the document group..

Monitor the progress and status of all bots created for a learning instance and set the status from Staging to the Production environment.

Testing a bot verifies that the bot can reach the required accuracy based on the training. It also runs it against all the sample documents associated with that category or group and benchmarks document and field accuracy. Test a bot only in the Staging environment.

---

### Note:

- To view the updated document and field accuracy, refresh the **Bots** page and click the bot name. The updated document and field accuracy appear in the details area.
  - You cannot edit a bot that another user is already editing.
-



## Various bot states

The status of a bot is dependent on the state of the learning instance as well as the bot. The table below shows the relationship between learning instance state, bot state, and bot status.

Learning Instance State	Bot State	Bot Status
Staging	Staging	Training
Staging	Production	Ready
Production	Staging	Training
Production	Production	Active
Created	Not created	No listing

## Delete a bot

The following are some key points:

- Clicking the **Delete bot** button displays a message asking if you want to delete the Bot. Selecting yes displays a success message in the Learning Instance details page. The **Summary** tab shows the updated information in the **Staging** and **Production** results sections for the **Groups found** and **Bots created** fields.
- You can delete a Bot in Staging only. Once deleted, the Bot does not display in the Learning Instance details page or the Bot listing page.
  - All associated staging documents are removed from the system.
  - All associated unprocessed production documents get moved to the Validator for processing.

---

**Note:** A new Bot is created when the same documents are uploaded again to Staging or Production.

- On re-uploading the deleted documents from the learning instance, the system classifies the documents and displays the groups again with the **Create Bot** option for each group. Clicking the **Create Bot** option creates the Bot and you can see it in the **Create Bot** details page.
- In case of backend exceptions, such as disruption of Services, the system does not let you delete the Bot. Instead, it displays an error message saying that an unexpected error has occurred.

Related tasks

[Create your first bot](#) on page 1489

Perform the following steps to create your first bot that prints the message, `Go be great!`, the Automation Anywhere version of `Hello World!`

## Improve output quality using OCR confidence

Improve the output quality of the IQ Bot platform using the system-identified region (SIR) and optical character recognition (OCR) confidence by comparing it to a predefined threshold.

Confidence-based validation is useful for a text type field and for Date or Number fields because it helps route a document, with contentious values, for a human to view despite the fields satisfying the set validation criteria.

### Enable OCR confidence-based validation

---

**Note:** This option is applicable only if you selected Tesseract OCR when creating the learning instance.

---

This feature is disabled by default. To enable this feature, open the `Settings.txt` configuration file available in `<IQ Bot Installation Folder>\Configurations\`, and set the desired threshold value in the `ConfidenceThreshold` property. For this example, set the character-level confidence threshold value to 99, that is `ConfidenceThreshold=99`. When this feature is disabled, the default value is set to 0, signifying that the feature is disabled.

---

**Note:** The confidence threshold value is uniformly applicable across all the learning instances.

---

### How OCR confidence-based validation works

In a document if a field's SIR character level confidence is lower than that of the set confidence threshold, the validation for that field fails, resulting in the failure of that document.

---

**Note:** If a field value fails due to a validation rule (for example, `Invalid Number Format`) other than an OCR confidence validation failure, you see that tooltip, and not the tooltip for Low confidence.

---

While training a document, a confidence-based validation failure against a field appears in an orange box during preview if no other validation errors exist for that field. Other validation errors take precedence over OCR character-level confidence validation.

---

**Troubleshoot:** If the OCR engine is not able to identify SIRs for Chinese language PDF documents, troubleshoot the issue:

- [Data objects \(SIRs\) are not identified by OCR for Chinese PDF documents \(A-People login required\)](#)
  - [How to convert PDF files to TIFF files \(A-People login required\)](#)
-

## Map a field

When you are training a learning instance, if a field value was extracted incorrectly or if the field was not found, you must remap the field.

If you have not done so already, first create a learning instance with sample documents. [Create a learning instance](#) on page 3746

For an introduction to the components, see [Introduction to the Designer](#) on page 3759.

The Designer image display panel contains blue boxes that surround text, date, or number type data. Each of these blue boxes is a system identified region (SIR) that indicates that IQ Bot has identified that region as containing extractable data. Perform the following steps to map a field to teach IQ Bot to extract data from that field (for example, the invoice number) from a specific region (for example, the top-right side of SIR).

---

**Note:** These steps apply only to text, number, and date data types. IQ Bot also supports check boxes. For more information, see [Extract data from check boxes or check box groups](#) on page 3768.

---

1. Select a field and specify the data type from the **Data type** list.

---

**Note:** If a field value contains a mix of letters and numbers, such as invoice number, select the **Text** option.

---

2. In the image display panel, click the field from where you want to extract data.  
IQ Bot tries to identify and autopopulate the corresponding field value in the field details panel.

---

**Tip:** Use the pipe symbol (|) to add field aliases, which represents alternative text that might be present in an SIR. For example, if the recipient's information is in a field labeled `Sold to` in some of the documents and in `Ship to` in other documents, enter `Sold to | Ship to` as the field label.

---

3. Optional: Drag the corners of the green-bounded box to resize the mapping area.  
Alternatively, draw a new mapping area by holding and dragging the cursor.  
When you resize any value region or create your own value region using select, its position is fixed relative to the field label. The value for that field is always searched in that relative region.  
Reset a fixed field region defined by the user in the autodetected mode by clicking the close button at the top-right corner of the field.  
For additional information, see [What are the different ways to map form fields in IQ Bot \(A- People login required\)](#).
4. Optional: If the column value is not consistently available in the training documents, expand the **Field options** section and select **Optional**.
5. Optional: Add validation patterns or custom logic.  
[Designer validation patterns](#) on page 3771|[Adding custom logic to improve automatic extraction in production](#) on page 3782

Review each field to verify whether the correct value is extracted. Then, proceed to mapping table fields. See [Map a table](#) on page 3764.

## Use list validation to improve accuracy of a text field

Setting validations while defining any field or table column while mapping the document class helps validate a field or table column against predefined parameters so that you can be warned if any mismatch is found during the data digitization process.

Enter each text value in a separate line.

- The bot validates extracted value of field/table column against this predefined list and checks for any mismatch found during the **See Extraction Results** phase.
- Besides validating, the process also helps auto correct the extracted values.
- Errors in validation are marked with a red border and can be seen in the **See Extraction Results** phase. Move your cursor over the error to know the error type.

If list validation value is Adam, and the extracted value is Adem; the extracted value will be auto corrected to Adam. In this example, there is a 75% match of characters; and threshold for match is at least 66%.

## Use validation patterns/lists to flag discrepancy in extracted data

Use validation patterns/lists to flag discrepancies in extracted data and prevent incorrect data from going through.

When a date/number format pattern is explicitly specified, the date/number is auto corrected.

See the following examples:

Table 13: Example of date format pattern

Incorrect OCR Data	Pattern	Auto-Correction
15 10-2015	dd-mm-yyyy	15-10-2015

Table 14: Example of number format pattern

Incorrect OCR Data	Pattern	Auto-Correction
123 4567	9999999	1234567

## Map a table

IQ Bot uses column names as reference points when extracting values from tables. As part of training a learning instance in the Designer, you must map the column names and configure the table settings.

Create a learning instance and map all the form fields in the Designer. [Map a field](#) on page 3763

1. Skipping the **Table settings** section, click the first table column in the **Table fields** section.
2. Click the name of the column from where you want to extract data in the image display panel.

There are two ways to map the column values:

- Option 1: For a basic table that is contained within one page, map the column name to the **Column value** field.
- Option 2: If the table spans multiple pages, we recommend mapping the **Column value** field to an entry in that column that has the greatest height and width among the entries in that column.

Depending on which mapping option you choose, IQ Bot autopopulates the **Column value** field in the field details panel with either the name of the selected column or the value of the selected table entry. In addition, the selected SIR in the document is highlighted with yellow color for easy identification.

3. Optional: Drag the corners of the green-bounded box to resize the mapping area.

Alternatively, draw a new mapping area by holding and dragging the cursor.

When you resize any value region or create your own value region using select, its position is fixed relative to the field label. The value for that field is always searched in that relative region.

Reset a fixed-field region defined by the user in the autodetected mode by clicking the close button at the top-right corner of the field.

---

**Tip:** For additional information, see [How to map tables in IQ Bot \(A-People login required\)](#)

4. Expand the **Field options** section and select **Required** or **Optional**. Use the optional value if the column value is not consistently available in the training documents.

5. Optional: Provide validation patterns.

[Designer validation patterns](#) on page 3771

Configure the **Table settings** section. Ensure that you map all the other fields in the document before populating this section.

6. Review the selected option in the **Best field for table/repeated section** field. IQ Bot autodetects the table field that best defines the height of the rows in the table. You can select a different column from the list.

Other columns are extracted in reference to this column. For example, if the **Best field for table/repeated section** has five rows, then a maximum of five rows will be extracted from the other columns.

---

**Note:** Ensure that this field does not contain multiple lines or is empty.

7. Optional: Map a field label for the **End of table indicator** field to specify where to stop extracting data from that table.

For example, an invoice might contain the subtotal, sales tax, and total in the table, but because each of these fields has only one value per document, they should not be extracted as part of the table.

Provide the name of the first field that appears where the table ends, for example, `Total` or `Grand Total`.

Provide the value for the **End of table/section indicator** field in any of the following ways:

- In the Image display panel, select an SIR to populate that text value as the **End of table/section indicator**.
- Alternatively, type a value directly into the **End of table indicator/section** field, in the middle panel.

---

**Tip:** Use the pipe symbol (|) to add field aliases, which represent alternative text that might be in an SIR. For example, `Subtotal | Subtotal Amounts` refers to Subtotal OR Subtotal Amounts.

---

For an example of how to map one table for extraction in a document that contains multiple tables, see [Mapping a table in a page with many tables](#) on page 3766.

8. If you mapped a table value for the Column value field (option 2 in step 2): Expand the **Advanced table options** section and select **Stop extraction at "end of table indicator"**.
9. Optional: Enter custom logic.  
[Adding custom logic to improve automatic extraction in production](#) on page 3782

Click **See extraction results** to check the training results for table data and remap the fields if required. [Preview extracted data](#) on page 3769

## Mapping a table in a page with many tables

This example guides you in using the **Extract Table Summary Rows** and **End of table indicator** fields to extract one table in a page that contains many tables.

If you have not already done so, create a learning instance and map all the form fields in the Designer. [Map a field](#) on page 3763

In this example, a page in a document contains more than one table, but the objective is to extract only one of the tables. User is in the Designer training a bot, with at least one table having duplicate or similar regions matching those of another table. **Extract Table Summary Rows** functionality does not impact data extraction irrespective of whether user specifies the **End of table indicator** value.

1. Create two tables with similar or duplicate areas. For example, one table with claims total and other with record details related to line number.
2. Map all table columns related to line number.
3. Map all value columns without table label, but related to claims total.  
Claim totals table has duplicate or similar areas like another table related to line number. So the billed amount column is a duplicate area for both tables.
4. Map one column of claims total table with the claims total label, as at least one column label is required for data extraction for a table.
5. Click on **See extraction results** to see duplicate rows that have duplicate or similar areas on claims total table. For example, When single page has multiple claim totals records.
6. Click **Back to training** to return to the training page.
7. Navigate to **Claim totals table > table settings**, and check the box for **Extract Table Summary Rows** label under **Advance Table Options**.
8. Enter value for **End of table indicator** and click on **See extraction results**.
9. User can see rows in claims total table related to claims total only.
10. Click on **Export to CSV** to open the file.
11. User can see table related to claims total extraction, as seen in preview.
12. Next, set the learning instance, and bot to production and upload some files related to the bot.
  - If the bot does not have any validation errors, the user can see claims total table as per mapping in production CSV file.

- If the bot has some validation errors, the user can see claims total table as per mapping in the Validator.

## Add multiple tables in Designer

If the sample documents contain more than one table, you must map the columns and configure the table settings for each table.

Create a learning instance and map all the fields in the Designer. [Map a field](#) on page 3763

Map the columns for the first table. [Map a table](#) on page 3764

Add multiple tables in the Designer to extract their value and validate them. Move one or more table fields from one table to another to train extraction. To add tables do the following:

1. In the **Table fields** panel, click Add Table.
2. Select the columns to add from the **Available columns** list and click the arrow to add to the new table column list.
3. Map the column names and values as you did for the first table, then configure the **Table settings** section.

### Resources

Click **See extraction results** to check the training results for table data and re-map the fields if needed. [Preview extracted data](#) on page 3769

## Define one or more linked fields in a child table

In the Designer, define one or more linked fields/sections in a child table, to link parent and child tables in a flexible way.

Use the linked fields in a child table feature in Designer to create table links, and a hierarchy of table links among parent and child tables. This helps efficient data extraction of the linked fields besides easy linking among tables. Foreign key data extraction allows the following relationships only:

- Link single parent row to a single child row (one-to-one linking).
- Link single parent row to multiple child rows (one-to-many linking).

---

**Note:** IQ Bot does not support linking of check boxes.

---

Use the feature for documents with a list of names or IDs with specific information on each. For example, documents from an electric company with a list of customers and their billing/usage information. Or a document with a list of student names displaying their test scores. Create multiple tables and link the common fields thus allowing efficient and accurate data extraction. IQ Bot supports linking of up to 50 columns and unlimited rows. However, data extraction from rows spanning across multiple pages is not supported.

- Single parent-child table field/section linking:

In the **Table/Repeated Section** of the Designer, choose one or more fields/sections from a parent table to link to a child table.

1. Click **Table Settings** in the child table and click on **Link Table Fields** and select the parent table from the drop-down list of table names. This displays the available column options in the parent table you can choose to link to.
  2. Select the columns you want linked and click the downward arrow to link the columns to the child table.
  3. The linked columns display under **child table > Table Settings > Linked to (table name)**.
  4. When previewing the extracted data (click **See extraction results**), the linked fields from the parent table show up in the extreme left columns of the child table.
- Multiple hierarchical table field/section linking:

When linking table 1, 2, and 3 in a hierarchy, link in a way so that table 1 is the parent of table 2, and table 2 is parent of table 3. All three tables would be linked. Child table 3 would display linked fields from table 2 and 1. IQ Bot supports hierarchy linking up to six tables at a time.

---

**Note:** For table 3, you can only choose fields from table 2 that are not from table 1.

---

When previewing the extracted data for child table 3 (click **See extraction results**), the extreme left columns show linked fields from table 1. The next columns show linked fields from table 2.

---

**Important:** For successful linking, the child table must be at the same or lower level than the parent.

---

## Extract data from check boxes or check box groups

Train a bot to extract data from a single check box or a group of check boxes.

A check box is a user interface object that allows you to make a binary choice - select or leave unselected. IQ Bot supports extracting data from check boxes or radio buttons marked with a tick, cross, or dot. In addition to square check boxes and round radio buttons, IQ Bot supports triangle and rhombus outlines.

When IQ Bot processes documents with a check box, it extracts either a **Yes** (check box selected) or **No** (check box not selected) value.

You can also combine multiple check boxes into a single group, for example a payment methods group that contains check boxes for cash, credit card, and check. When IQ Bot processes documents with a check box group, it includes the group name in the extraction results.

Recurring check boxes or groups

By default, IQ Bot extracts check box values as a form field. However, if a check box or group appears on a recurring basis in the uploaded documents, you manually select the **Column** option so that IQ Bot extracts the values as table fields. This enables IQ Bot to extract values from the subsequent occurrences. Otherwise, IQ Bot will only extract the check box value the first time it appears.

1. Click the field you want to map from the left panel.
2. In the center panel, in the **Data type** drop-down field, select value as **check box** or **checkbox group**.



- To extract data from single check box or check box groups, click the **Field label** field and then click the corresponding value in the document in the right pane.
  - Extract data from recurring check box or check box groups, click the **Column name** field and then click the corresponding value in the document in the right pane.
3. To extract the check box value, draw an outline around the check box excluding the value.
    - For a single check box, use the **Draw** tool to draw over the check box or select the auto-mapped check box segment.
    - For a check box group, use the **Draw** tool to draw over the region covering all the check boxes in that group.
  4. For single check boxes or check box groups: Verify the extracted data either in the **Field value** field in the Designer or click **See Extraction Results** to see the extracted data.  
For recurring check boxes or check box groups: You can only view the extracted data by clicking **See Extraction Results**; the extracted data is not shown in the Designer.
  5. Optional: To add an individual check box to a check box group, select the desired value from the **Checkbox group** drop-down menu.
  6. When you are done configuring the check boxes, click **Save and close** or **Save and go to next group**.

## Preview extracted data

Click **See Extraction Results** to review the extraction accuracy of the bot. This is the only way to see extraction results for table data, since the Designer does not show extracted table data during training. Alternatively, click **Export to CSV** to review the data in a CSV file.

The extraction result window displays the following information:

- Successfully mapped fields and the extracted values.
- Table headers and the values for each row.
- Extraction errors, which are highlighted within a red box. Hover on the error to learn more, such as if there was a validation error or lack of OCR confidence.

---

### Note:

- The time required to display the extraction results can vary based on the complexity of the Python logic that you have created.
- To ensure successful previewing of a training document, its entire end-to-end processing, including value extraction, execution of any Python logic (if applicable), and validation of all fields, must be completed within a 2-minute time frame.

Training documents must be limited to a maximum of 20 to 30 pages. This ensures efficient processing and successful previewing within a 2-minute time frame.

---

**Important:** A training document can pass in spite of an error flagged by the validation pattern. Sometimes we want a validation pattern to flag an error, so it would not pass specific documents at a later stage in production; instead enter them in the manual validation queue.

---

Close the window to return to the Designer.

**Important:** If you upload 30 documents and all documents are classified into one group, you can see only one document for each unique layout.

---

## Export data to a CSV file

You can export the extracted data to a CSV file for ease of review. When you click **Export to CSV**, the current document is downloaded to your device. To download other documents you must navigate to them using the < and > buttons.

The data in the downloaded CSV file is displayed exactly how it will appear when IQ Bot downloads data from a successfully processed document from a learning instance in production mode.

## Review the learning instance details

Review various details of a learning instance such as associated groups, environment status, staging and productions results, total number of tested documents, modified date and so on.

On the **My learning instances** page, select a learning instance and use the following tabs to review the details:

- **Document Groups**- Contains a list of the document classification groups for the learning instance.  
  
When you create a learning instance and upload documents to train, documents are automatically categorized in the same document group based on their content and classified accordingly. These are termed as classification groups. A bot is more likely to succeed extracting text across documents in a group with similar content.
- **Summary**- Contains various details about the learning instance such as Staging and Production results, current environment that the selected learning instance is in, total number of associated groups and bots, and so on.

---

**Note:** The system does not automatically refresh (auto-refresh) the **My learning instances** unless the user loads a screen or clicks the **Refresh** button, thereby manually refreshing data on a page. This feature helps reduce the response time for loading new data or performing any action in IQ Bot.

---

Related concepts

[Review the dashboard](#) on page 3793

The dashboard summarizes the performance report and provides document processing information in a graphic format.

## Delete mapping in the Designer

Delete mapping of field labels and field values, selecting the **X** delete symbol next to the mapped label or value.

The following use cases explain the delete field labels and value mapping options in the Designer.

- |  |   |
|--|---|
| Delete a field label and its mapped value: | Select a field label in the middle panel and click the <b>X</b> delete symbol of the bound box in the document view to delete both, label and value |
|--|---|

	mapping . The label and the value from the middle panel gets deleted as well. The mapping check mark in the left and middle panels turns from green to gray indicating incomplete mapping.
Delete field value:	Select the field value and click the <b>X</b> delete symbol of the mapped box in the document view, to delete the mapped value. The value from the middle panel gets deleted as well. The check mark in the left and middle panels turns from green to gray indicating incomplete mapping.
Delete auto mapped value fields:	<p>The <b>X</b> delete symbol of the mapped box in document view is not visible till user resizes or manually maps it.</p> <p>For a form field, when a user deletes a resized or manually mapped box around a the field value, IQ Bot repopulates the original auto mapped value.</p> <p>For a table/section field, that same behavior does not apply, as a user has the option to map a table/section field name but not a field value, and vice versa.</p>
Delete a field label/value with or without auto mapped value:	Select a field label/value with or without auto mapped value. The field label bound box displays in the document with an <b>X</b> delete symbol allowing users to delete the label.
Delete field label mapping with validation pattern:	In spite of deleting a field label, the validation pattern that was assigned to the field remains in place.
Delete option ('X') when bounded box reaches space limit:	If the label/field value bounded box in the document view covers a bigger area, extending to the edge of or beyond the document view, the 'X' delete symbol appears in the nearest corner of the box.

---

**Note:** The field value box in the middle panel is disabled and users cannot enter text manually.

---

## Designer validation patterns

IQ Bot Designer allows you to validate a field and table column against a set of predefined parameters so that you can be warned if any mismatch is found during data digitization process.

### Validate a field or table

Validate a field or table column against the following predefined parameters of validation options:

- Start With / End With
- Pattern

- Lists
- Formulas

IQ Bot classifies documents into groups based on similar content, structure, and layout, which is easily identifiable. The sample documents for training are chosen based on these criteria as well. When you launch the Designer to train your learning instance, IQ Bot loads and displays a sample document from each classified group in the document pane.

**Tip:** In the Designer set the validation parameters by defining any field and or table column during document training.

## Starts With and Ends With

While all validations can be set at the time of Design definition, you can set **Starts with/Ends with** and **Pattern** validations during training.

To validate whether data in a field starts or ends with a certain value, use the **Starts With** and **Ends With** validation option fields. While defining the design of a field or table column, you can specify whether the data is part of the selected field.

- Start with a certain value using a Starts With field
- End with a certain value using an Ends with field

If the Start With value is "IN" and extracted value is "1N7646464", then validation fails. While if End With value is 2017 and the extracted date value is 10-Aug-2017, the validation passes.

## Pattern

A pattern helps define an acceptable format for data.

Validate data in the field or table column against a specific pattern. While defining the field or column in the Design view, specify a pattern of the data in the selected field.

Specify a pattern for date, number, or text fields based on the different available patterns. Reference the tables below for common examples:

## Text

Field	Pattern	Notes	Description
Email	<code>^([a-z0-9_\. -]+)@([\da-z_\. -]+)\.([a-z\.] {2,6})\$</code>	This regular expression validates emails like john@ado.com.	The Email field supports regular expressions.
Phone Number	<code>^(\\(\\+? [0-9]* \\)?)? [0-9_\\- \\(\\)]*\$</code>	This regular expression validates phone numbers like (+64) 38 3235393.	The Phone Number field supports regular expressions.
Website	<code>^([a-zA-Z0-9]+(\\.[a-zA-Z0-9]+)+.*)\$</code>	This regular expression validates websites like www.domain.com.	The Website field supports regular expressions.

Field	Pattern	Notes	Description
Number string	<code>^[0-9]{1,45}\$</code>	This regular expression validates a string with numbers 0 - 9 and limit length to 45.	The Number string field supports regular expressions.
Alpha-numeric	<code>^[A-Za-z0-9_@.#&amp;+]*\$</code>	This regular expression validates a string containing alphanumeric values like INV-001.	The Alpha-numeric field supports regular expressions.

## Number

Field	Pattern	Notes	Description
Number string	<code>^[0-9]{1,45}\$</code>	This regular expression validates a string with numbers 0 - 9 and limit length to 45.	The Number string field supports regular expressions.

## Auto Correction for date and number fields

This is one of the built-in features of IQ Bot for date and number format types. It performs automatic validation and correction based on the defined pattern, even when the date/number in the scanned document is incorrect.

**Note:** Auto correction is only supported for special patterns.

The following table illustrates the auto-correction of an incorrect date and numbers by IQ Bot.

	Incorrect OCR value	Pattern	Auto-Correction	Description
DATE	12 F3B 2 0 1 5	dd mmm yyyy	12 FEB 2015	In the first example, IQ Bot auto corrects incorrect OCR "F3B" to "FEB".
	15 10-2015	dd-mm-yyyy	15-10-2015	In the second example, IQ Bot auto corrects "15 10-2015" to "15-10-2015".

NUMBER	123 4567	9999999	1234567	In the first example, the extra space between "3" and "4" is deleted after validation against the pattern.
	12.34,S67.12	99,99,999.00	1234567.12	
				In the second example, the alphabet "S" is corrected as "5".

**Note:** English language numeric value with at least one digit to the left and two consecutive digits to the right (for example, 1.23) gets auto corrected if there is a space found between the decimal and the digits. For example, values 1 . 23 or 1. 23 or 1 .23 get auto corrected to 1.23.

To use this feature, add Pattern (in validation options) to the selected date and number format fields.

## Special number patterns

A special pattern consists of a Prefix, a Number Pattern, and a Suffix. Use for each is explained as follows:

- Prefix: Any symbol or a text string that is appended before the Number Pattern.
- Suffix: Any symbol or a text string that is appended after the Number Pattern.
- Number Pattern: Number pattern has two parts:

- Integer-part:

They are represented by nines (9s).

The 9s in the integer part represents integer pattern and separators such as commas, spaces, and so on.

- Fractional part

They are represented by zeros.

If you need two fractional number, then it will be represented by two zeros.

Specifying fractional part is optional.

Format of numbers defined for validating numeric data.

IQ Bot supports prefixes and suffixes to make processing and validation of data easier. Specifying a suffix and prefix in the pattern and in the numeric fields is optional. Even if you do not specify the suffix or prefix, IQ Bot auto corrects and includes the required currency symbols and units of measure for the numeric fields as prefix or suffix. If you specify the currency symbols and units of measurements in the pattern and in the numeric data, IQ Bot deletes the currency symbol and unit of measure from the data.

**Note:** IQ Bot automatically recognizes these currency symbols: \$, ¥, £, #, €, Rs, USD, EUR, CAD, AUD, GBP, and INR. We recommend specifying valid currency symbols in the data.

IQ Bot supports prefixes and suffixes to make processing and validation of data easier. Specifying a suffix and prefix in the pattern and in the numeric fields is optional. Even if you do not specify the suffix or prefix, IQ Bot auto corrects and includes the required currency symbols and units of measure for the numeric fields as prefix or suffix. If you specify the currency symbols and units of measurements in the pattern and in the numeric data, IQ Bot deletes the currency symbol and unit of measure from the data.

**Note:** IQ Bot automatically recognizes these currency symbols: \$, ¥, £, #, €, Rs, USD, EUR, CAD, AUD, GBP, and INR. We recommend specifying valid currency symbols in the data.

### Examples of special number patterns

Pattern	Example
Supported patterns	Supported format for numeric patterns: <ul style="list-style-type: none"> <li>• Decimal (India)</li> <li>• Decimal (US, UK, Australia and others)</li> <li>• Number (India)</li> <li>• Number (US, UK, Australia and others)</li> <li>• Normal Decimal</li> <li>• Normal Number</li> </ul>
9,999,999.00	2,597.23
9.999.999,00	7.562.597,23
9 999 999.00	2 597.23
9 999 999,00	7 562 597,23
9999999,00	2597,23
9999999.00	7562597.23
99,99,999.00	75,26,569.56
\$ 9.999.999,00	\$ 7.562.597,23
\$9 999 999.00	\$7 562 597.23
9 999 999,00 \$	2 597,23 \$
€ 9999999,00	€ 7562597,23
€9999999.00	€7562597.23
99,99,999.00 €	75,62,597.23€

Pattern	Example
EUR 9,999,999.00	EUR 7,562,597.23
EUR9 999 999.00	EUR7 562 597.23
9999999,00 EUR	62597,23 EUR
9.999.999.00	62.986.51
9, 999, 999. 00	232, 510. 68

## Special date patterns

Supported date separators include /(forward slash), -(dash), space, .(dot), and ,(comma).

- d - Numeric day of the month, from 1 through 31 (eg. 5, 15 etc.)
- dd - Numeric day of the month, from 01 through 31 (eg. 05, 15 etc.)
- m - Numeric month (eg. 1 for January)
- mm - Numeric month (eg. 01 for January)
- mmm - First 3 letters of the month (eg. NOV for November)
- mmmm - Full name of the month (eg. June)

## Examples of special date patterns

Pattern	Example
mm-dd-yy	01-31-18
mmm-dd-yyyy	Jan-31-2018
mmmm dd, yyyy	January 31, 2018
Mmmm d, yyyy	January 9, 2018
D M YY	9 5 15
D MM YY	9 11 15
D MMM YY	7 MAR 15
D MMMM YY	7 MARCH 15
M DD YYYY	5 05 2018
D/MM/YY	5/05/18
M/D/YY	9/5/15
DD / M / YYYY	05 / 9 / 2018
MMM / DD / YY	MAR / 05 / 18
D-MMMM-YY	09-APRIL-18
M-D-YY	5-5-18



Pattern	Example
MM-D-YY	11-5-18
MMM-DD-YYYY	NOV-13-2018
DD - M - YYYY	13 - 5 - 2019
MMMM - DD - YY	OCTOBER - 05 - 18
D.MMMM.YYYY	05.APRIL.2018
MMMM.DD.YYYY	APRIL.05.2018
D . M . YY	5 . 5 . 18
D . MM . YY	5 . 05 . 18
DD . MMM . YY	05 . JUL . 18
M . DD . YYYY	5 . 11 . 2018
MMMM . DD . YY	MAY . 13 . 13
YYYY-MM-DD	2018-01-27
YYYY/MM/DD	2017/07/27

## Lists

While defining a field or table column in the Design view, you can specify a list as part of validation option for a selected field or table column. The extracted value of the field is validated against this predefined list during Preview and Test Run.

You can only specify list validation when format of field or table column is "Text". If the lookup returns multiple values for a word, the value is not auto corrected and the validation fails.

To specify list validation, do the following:

1. Select the validation type as **List** from the **Validate** drop-down menu.
2. Type a predefined list and click **Define** to save.

Each value in the list should be in a separate line.

If the extracted value does not match any value in the predefined list, the field is considered to have failed validation.

## Formulas

Specify a formula as part of validation options for a selected field or table column. Use basic arithmetic, comparative, logical, and functional operations.

---

**Tip:** We recommended using functional operators instead of mathematical operators when validating fields and tables for better accuracy.

---

When formulating an expression remember the following:

- All function names must be in capital letters.
- All formulas must result in either a true or false validation.
- Field and column names are case sensitive when used within formulas. If field is defined as Qty in design, using qty or QTY in formula results in an invalid formula.

- For variable declaration or manipulation, ensure not to use certain keywords that are reserved for formulating an expression, including SUM, SUB, DIV, MUL, COLSUM, IF.

## Mathematical Operators

Operations	Description	Syntax
+	Addition	Field/Column_Name1 + Field/Column_Name2
-	Subtraction	Field/Column_Name1 - Field/Column_Name2
*	Multiplication	Field/Column_Name1 * Field/Column_Name2
/	Division	Field/Column_Name1 / Field/Column_Name2

## Comparative Operators

Operations	Description	Syntax
==	Equal To	[Current Field/Column Name] == [expression comprised of one or more field/column name or fixed numeric values]  For example, AMOUNT == MUL(QUANTITY, UNIT_PRICE)
>=	Greater than or Equal To	[Current Field/Column Name] >= [expression comprised of one or more field/column name or fixed numeric values]  For example, TOTAL_BILL_AMOUNT >= AMOUNT_PAID
<=	Less than or Equal To	[Current Field/Column Name] <= [expression comprised of one or more field/column name or fixed numeric values]  For example, AMOUNT_PAID <= TOTAL_BILL_AMOUNT

Operations	Description	Syntax
>	Greater Than	[Current Field/Column Name] > [expression comprised of one or more field/column name or fixed numeric values]  For example, BILL_AMOUNT > 0
<	Less Than	[Current Field/Column Name] > [expression comprised of one or more field/column name or fixed numeric values]  For example, DISCOUNT_PERCENTAGE < 100
!=	Not Equal To	[Current Field/Column Name] != [expression comprised of one or more field/column name or fixed numeric values]  For example, DEBIT_AMOUNT != 0

## Logical Operators

Operations	Description	Syntax
&&	And: Field/Column is valid if all conditions are true	<Current Field/Column Name> <operator 1> <expression 1> && <Current Field/Column Name> <operator 2> <expression 2>  For example, DISCOUNT_PERCENTAGE >= 0 && DISCOUNT_PERCENTAGE <=100

Operations	Description	Syntax
	Or: Field/Column is valid if any one of the given conditions is true	<p>&lt;Current Field/Column Name&gt; &lt;operator 1&gt; &lt;expression 1&gt;    &lt;Current Field/Column Name&gt; &lt;operator 2&gt; &lt;expression 2&gt;</p> <p>For example, DISCOUNT_PERCENTAGE &gt;= 0    DISCOUNT_PERCENTAGE == 'Net'</p>
!	Not: Converts a true expression to false and also the other way round	<p>!&lt;expression&gt;</p> <p>For example, !(AGE &lt; 18) ==&gt; valid when AGE is not less than 18</p>

## Functional Operators

Operations	Description	Syntax
SUM	Summation: gives result of addition of one or more field/column/fixed-number values	<p>SUM(n1,n2,...,nN)</p> <p>For example, SUM(SUB_TOTAL, SERVICE_TAX, EDUCATION_CESS) ==&gt; equivalent to SUB_TOTAL plus SERVICE_TAX plus EDUCATION_CESS</p>
SUB	Subtraction: gives result of subtraction of one or more field/column/fixed-number values from the first specified value	<p>SUB(n1,n2,...,nN)</p> <p>For example, SUB(SUB_TOTAL, TOTAL_DISCOUNT, ADJUSTMENTS) ==&gt; equivalent to SUB_TOTAL minus TOTAL_DISCOUNT minus ADJUSTMENTS</p>

Operations	Description	Syntax
MUL	Multiplication: gives result of multiplication of one or more field/column/fixe-number values	<p>MUL(n1,n2,...,nN)</p> <p>For example, MUL(QTY_IN_BOX, UNIT_PRICE, SHIPPED_BOXES) ==&gt; equivalent to QTY_IN_BOX multiply-with UNIT_PRICE multiply-with SHIPPED_BOXES</p>
DIV	Division: gives result of division of one or more field/column/fixe-number values from the first specified value	<p>DIV(n1,n2,...,nN)</p> <p>For example, DIV(AMOUNT, SHIPPED_BOXES, UNIT_PRICE) ==&gt; equivalent to AMOUNT divide-by SHIPPED_BOXES divide-by UNIT_PRICE</p>
COLSUM	Sum of a given Column in a table: gives result after evaluating given expression for each row of specified table and adding them all together	<p>COLSUM("&lt;table-name&gt;", "&lt;expression to evaluate for each row of specified table- name&gt;")</p> <p>For example, FINAL_TOTAL == COLSUM("LINE_ITEMS", "MUL(QTY, UNIT_PRICE)")</p> <p>Say there are 3 rows for table LINE_ITEMS, then FINAL_TOTAL should be equal to MUL(QTY1, UNIT_PRICE1) + MUL(QTY2, UNIT_PRICE2) + MUL(QTY3, UNIT_PRICE3)</p> <p>where, QTY1 is QTY value in row 1, similarly UNIT_PRICE1 is UNIT_PRICE value in row 2, and so on for other rows as well.</p>

## Adding custom logic to improve automatic extraction in production

Enter the logic in the IQ Bot Designer to improve text extraction and validation, and to reduce the number of documents entering the Validator that requires RPA post processing.

### Overview

For Automation 360 IQ Bot Cloud, there is an identified list of Python libraries and packages that are safe to use for the Custom Logic feature. Use only these packages to ensure security for your cloud infrastructure, file systems, databases, and network resources: [List of supported Pandas Libraries in Automation 360 IQ Bot \(A-People login required\)](#)

Keep in mind the following:

- Custom logic executes in a sequential order across all tables and fields.
- Applying custom logic might increase the extraction time per document.
- Automation 360 IQ Bot validation rules apply over the extracted values processed by the custom script.
- Custom script only works on the extracted data and does not influence the OCR extraction quality.
- Always test your Python script before processing documents in a learning instance in production

The custom logic feature helps clean up extracted values ahead of the validation step but does not replace all the post-processing currently done using the Task Bot. In addition to adding inline scripts, users can use the Python scripts in a central location, import those as modules, and call functions to reduce the amount of Python code at the field or table level.

---

**Restriction:** If the number of characters in the Python code along with other information exceeds 32000, and when this code is sent to the back-end as a Windows runtime argument for the process, the execution fails, and does not display any error message.

---

### Resources

To learn more, search for Using Custom Logic in IQ Bot course in [Automation Anywhere University: RPA Training and Certification \(A-People login required\)](#).

### Next step

Using scripts, in the IQ Bot Designer add the **Form fields** and **Table fields**.

### Form fields

Add scripts in Designer for form fields.

The List validation via external file can be implemented as a part of the field custom logic using python scripts directly in the Designer.

1. In the IQ Bot Designer, left-hand panel, highlight a form field whose extraction/validation you aim to improve further.

2. In the middle panel, scroll down to **Field options** > **Logic**.
3. In that **Logic** section, toggle between **fullscreen** and **smallscreen** for ease of use.
4. Add code to modify IQ Bot's extracted text value. See example below:

```
# variable that stores the value: field_value

# import the Python regular expression library, re
import re

# call the regular expression library's method, findall, to extract
the date value only
field_value = re.findall(r'\d{2}-\d{2}-\d{4}', field_value)[0]
```

5. Select **Test Run** to test your script and see the results before vs. after.

```
value_before: 2018/11/09 B210
value_after: 2018/11/09
```

## Table fields

Add scripts in Designer for table fields.

1. In IQ Bot Designer, left-hand panel, highlight **Table/section settings** for the table whose extraction/validation you aim to improve further.
2. In the middle panel, scroll down to **Logic**.
3. In the **Logic** section, toggle between **fullscreen** and **smallscreen** for ease of use.
4. Add code to modify the extracted table values, which are stored as a Python dictionary in a user variable called table\_values. See example below.

Each row has a Guid (Global unique identifier), which allows IQ Bot to auto track rows that are added and deleted. If you add a row, you need not enter a Guid. IQ Bot will handle this automatically.

```
# variable that stores the value: table_values

# convert from dictionary to dataframe
df = pd.DataFrame.from_dict(table_values)

# print dataframe before update
print(df)

# Item Description: drop rows with a missing value
df = df[(df["Item_Description"] != "")]

# Quantity: extract first part of the string, the numeric part only
df['Quantity'] = df['Quantity'].str.split(' ', 1).str[0].str.strip()

# print dataframe after update
print(df)

# convert back from dataframe to dict to override what IQ Bot stores
table_values = df.to_dict()
```

5. Select **Test Run** to test your script and see the results before vs. after.

```

Item_Description                               Guid
product_id  Quantity Item_Total
0 wafer, NO172 43ea78f4-7b9b-413a-83ce-89d671478d6c 2
COMS5A-18090220 4.00 PCS 5,840.00
1 Visual Iaspection + cc774f5f-2507-4a15-8e45-7b2abf84fabe
1.00 EA 65.00
2 6bddfed1-2359-4305-a0ac-a1769c113bfb 5%
VAT : Total - 4.00PCS GR: 5,905.00
3 2dc642a7-8e6e-4bc6-9672-85afff8c21db
Total - KGD: 0.00

Item_Description                               Guid
product_id  Quantity Item_Total
0 wafer, NO172 43ea78f4-7b9b-413a-83ce-89d671478d6c 2
COMS5A-18090220 4.00 5,840.00
1 Visual Iaspection + cc774f5f-2507-4a15-8e45-7b2abf84fabe
1.00 65.00

```

6. If you select **See extraction results** or save the bot, your script is saved.

## Use cases and examples

These are some use cases the Designer script feature supports.

For examples of user scripts and use cases, see: [IQ Bot custom logic use cases and examples](#)

Following are some use cases:

- Query an extracted value vs. a database in an ERP system to validate values.
- Extract "0123456" from "PO 0123456".
- Remove table rows that contain "Page x of y".
- Extract the currency from one table field (for example: Item Total) and save in an empty table field.
- Extract the product number from a table field (for example: Item Description).
- Extract the zip code from an address.
- Query a REST service (for example: add NLP, retrieve data from an outside system, and so on).
- Return a Boolean yes/no value on whether handwriting exists for a field.

## Pre-installed Python packages

To facilitate ease of use and consistent behavior across servers, IQ Bot auto installs Python v3.11.0 and some popular Python packages mentioned as follows.

Table 15: Pre-installed Python packages

Main package	Version	URL
difflib	In-built Python with installer	<a href="https://docs.python.org/3/library/text.html">https://docs.python.org/3/library/text.html</a>



Main package	Version	URL
io	In-built Python with installer	<a href="https://docs.python.org/3/library/io.html">https://docs.python.org/3/library/io.html</a>
re	In-built Python with installer	<a href="https://docs.python.org/3/library/text.html">https://docs.python.org/3/library/text.html</a>
sqlite3	In-built Python with installer	<a href="https://docs.python.org/2/library/sqlite3.html">https://docs.python.org/2/library/sqlite3.html</a>
string	In-built Python with installer	<a href="https://docs.python.org/3/library/text.html">https://docs.python.org/3/library/text.html</a>
stringprep	In-built Python with installer	<a href="https://docs.python.org/3/library/text.html">https://docs.python.org/3/library/text.html</a>
sys	In-built Python with installer	<a href="https://docs.python.org/3/library/sys.html">https://docs.python.org/3/library/sys.html</a>
textwrap	In-built Python with installer	<a href="https://docs.python.org/3/library/text.html">https://docs.python.org/3/library/text.html</a>
unicodedata	In-built Python with installer	<a href="https://docs.python.org/3/library/text.html">https://docs.python.org/3/library/text.html</a>
DateTime	4.3	<a href="https://pypi.org/project/DateTime/">https://pypi.org/project/DateTime/</a>
pandas	0.24.2	<a href="https://pypi.org/project/pandas/">https://pypi.org/project/pandas/</a>
inflection	0.3.1	<a href="https://github.com/jpvanhal/inflection">https://github.com/jpvanhal/inflection</a>
dateutils	0.6.6	<a href="https://pypi.org/project/dateutils/">https://pypi.org/project/dateutils/</a>
tabulate	0.8.3	<a href="https://pypi.org/project/tabulate/">https://pypi.org/project/tabulate/</a>
numby	1.16.4	<a href="https://pypi.org/project/numpy/">https://pypi.org/project/numpy/</a>
json	2.0.9	<a href="https://docs.python.org/3/library/json.html">https://docs.python.org/3/library/json.html</a>
requests	2.22.0	<a href="https://github.com/kennethreitz/requests">https://github.com/kennethreitz/requests</a>
psycopg2	2.8.3	<a href="https://pypi.org/project/psycopg2/">https://pypi.org/project/psycopg2/</a>
pymongo	3.8.0	<a href="https://pypi.org/project/pymongo/">https://pypi.org/project/pymongo/</a>
pyodbc	4.0.26	<a href="https://github.com/mkleehammer/pyodbc">https://github.com/mkleehammer/pyodbc</a>
opencv-python	4.1.0.25	<a href="https://pypi.org/project/opencv-python/">https://pypi.org/project/opencv-python/</a>

Main package	Version	URL
Pillow	6.0.0	<a href="https://github.com/python-pillow/Pillow">https://github.com/python-pillow/Pillow</a>
cx_Oracle  <b>Note:</b> As of Build 16685, this module is replaced by oracledb. See <a href="#">Upgrading from cx_Oracle 8.3 to python-oracledb</a>	7.1.3	<a href="https://github.com/oracle/python-cx_Oracle">https://github.com/oracle/python-cx_Oracle</a>
oracledb	1.2.1	<a href="https://github.com/oracle/python-oracledb">https://github.com/oracle/python-oracledb</a>
Python Arabic Reshaper	2.0.15	<a href="https://github.com/mpcabd/python-arabic-reshaper">https://github.com/mpcabd/python-arabic-reshaper</a>

### Additional Python packages

To allow further empowerment, you can add more Python libraries for use in IQ Bot.

1. Open the `Command Prompt`.
2. In the `Command Prompt`, change directory to IQ Bot's Python dictionary. For example: `c:\Python354-x86-IQBot`.
3. Install your Python package there. For example: `pip install PyArabic`.
4. In **IQ Bot Designer** > **Logic**, you can import and use that Python package.
5. If step 4 does not work, then stop/uninstall and then install/start services.

**Note:** Additional Python packages is allowed only for the On-Premises deployments and not applicable for Cloud deployments.

### Extract data using magnetic ink character recognition

Use the magnetic ink character recognition (MICR) OCR feature with ABBYY FineReader Engine version 12.2 support to extract MICR data from financial checks.

**Note:** Documents in Non-Latin based languages cannot be processed if MICR is enabled on ABBYY FineReader Engine OCR version 12.3 and 12.4.

- Ensure that ABBYY FineReader Engine is installed in the plug-ins folder: `\OCR Plugins\ABBYY SDK\12\ . . .`
- From the `C:\Program Files (x86)\Automation Anywhere IQ Bot (version)\Configurations` folder, open the `Settings.txt` file, change `OCREngine=Tesseract4` to `OCREngine=Abbyy`, and save the file.

**Note:** A system restart is not required.

The MICR feature is supported with ABBYY FineReader Engine versions 12.2 .

1. Set ABBYY FineReader Engine in your `settings.txt` file as the primary OCR engine.
2. Navigate to the `IQ Bot\Configurations\AbbyyImagePreProcessingSettings.json` file.
3. Update these parameters:
  - `TextTypes = 129`
  - `DetectTextTypesIndependently =true`

The MICR feature is activated in the system.

- Create a learning instance and add form fields to extract MICR data from financial checks such as **MICR** and **Pay to** fields.
- Scan and upload a check to IQ Bot for training. In production, upload the financial checks for accurate MICR data extraction.
- In the Designer, map the MICR data in the financial check for extraction.
- In production, upload the financial checks for accurate MICR data extraction.

## Set learning instance to Production

After you have trained a learning instance on Staging to extract data from documents with high accuracy, you can move the learning instance to Production. This enables you to deploy the learning instance on production documents for real time data extraction.

Use the **Set instance to production** button to move a learning instance to Production. When you move a learning instance to the Production environment, a confirmation message appears. To confirm, click **Yes, send to production**. Learning instances in the Production environment are identified by the **Production** label next to their name.

---

**Tip:** You can also use the **My Learning Instances** page to move a learning instance to Production.

---

**Note:** During the production process, you must not move the learning instances or bots from Staging to Production or vice-versa.

---

---

## Manage learning instances

A learning instance is an IQ Bot structure that describes the data in a single document type, for example an invoice. It contains information such as the language used in the document and the fields to extract.

A learning instance can be either in staging or production mode. These modes determine whether the learning instance is a draft or live version.

### Staging

In the staging mode, you can create and edit learning instances, upload sample documents, and train bots to extract data from the sample documents you uploaded. You can test and improve the accuracy of a learning instance

and its bots before deploying it to production mode.

**Note:** Because the data generated by learning instances in the staging mode is based on sample documents, it is kept separate from data pertaining to learning instances in production mode. For example, sample documents are not counted against your organization's purchased pages. For more information, see [Review the dashboard](#) on page 3793.

## Production

In the production mode, a learning instance can automatically process real business documents, extract data, and send documents requiring manual validation to the validation queue.

To find out which mode a learning instance is in, navigate to the **LEARNING INSTANCES** tab, where the **My learning instances** page displays the learning instances in the environment. Each learning instance has a toggle in the **Actions** column, which indicates whether it is in staging (toggle to the left and is colored gray) or production (toggle to the right and colored orange).

Instance name	Provider	# of IQ Bots	# of Files	Training %	Actions
IQBotDemo	Tesseract4 OCR	1	1	0%	
IQBotDemoDLCA	MicrosoftAzureAPI OCR	1	2	100%	

Based on the mode that a learning instance is in, different user types contribute to IQ Bot. For example, in the staging mode, the Data engineer creates learning instances and the Bot builder builds supporting RPA bots, and in the production mode, the Validator manually corrects the fields in the documents that IQ Bot could not process. To learn more about how each user contributes to IQ Bot, see [IQ Bot process overview](#).

**Note:** The following are the file size restrictions in each stage:

- In staging, you can upload a maximum of 150 documents of 10 MB file size per learning instance.
- In production, you can upload a maximum of 50 MB file size per document. However, the maximum number of documents allowed per learning instance depends on the license.
- There are no limitations on the number of pages per document in a pdfbox OCR.
- You can upload 60 pages per document in an image-based OCR.
- With the Tesseract4 OCR, there is a known limitation that restricts the number of pages per document to fewer than 60 pages.

## The learning instance lifecycle

The staging and production modes are independent from the IQ Bot environment when it comes to the traditional DevOps workflow of separate development, testing, and production

environments. A learning instance can be in either mode in any of the environments in the development life cycle.

**Note:** When you transfer a learning instance, it remains in the mode in which it was exported. For example, if you export a learning instance in staging mode from the development environment and import it to the testing environment, the learning instance will still be in staging mode and it will not perform document processing automatically.

The following image shows the typical lifecycle of a learning instance:

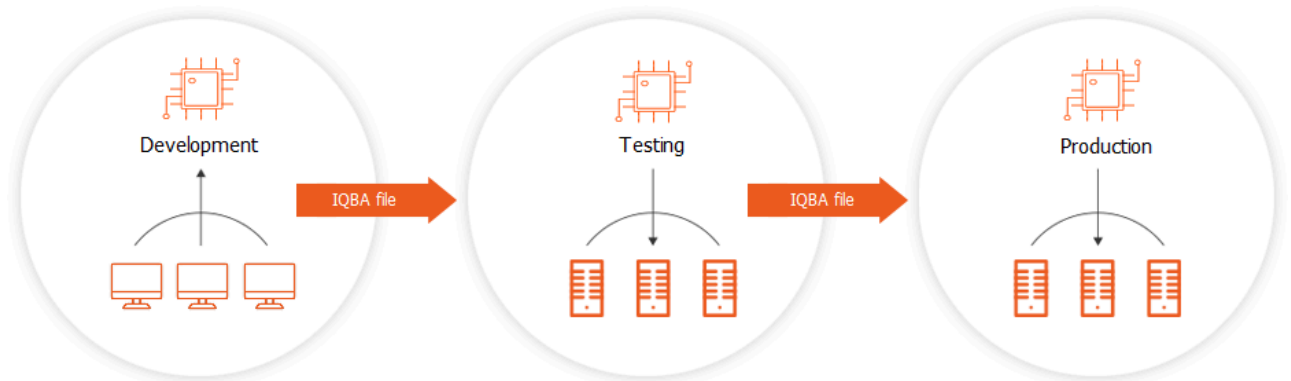

You can transfer learning instances across environments by using the Migration Utility. This helps you to avoid having to recreate similar learning instances and better manage the lifecycle of the associated bots. To learn more, see [Migrate learning instances](#) on page 1725.

## Rotate the external key

The Control Room supports using CyberArk to store keys for encrypting and decrypting IQ Bot data. A user with the **AAE\_IQ Bot Admin** role can change the object name in IQ Bot to start the key rotation process.

- The IQ Bot must have been connected with CyberArk during installation. See [Installing IQ Bot in Custom mode](#) on page 1440.
- Update the password in the CyberArk vault to generate the new key. Note the new key name because you will provide it in IQ Bot.

### 1. Navigate to **Administration > Key rotation**.

Most of the fields in the **Key rotation** page are auto-filled with the connection details you provided during installation.

### 2. In the **Object name** field, provide the new key name from CyberArk.

### 3. Click **Rotate key**.

The IQ Bot retrieves the new key from the CyberArk vault and encrypts data with this new key. When the encryption process completes, a success message appears.

If the encryption process is not successful, use the key rotation synchronizer to recover from the error.

## Use the IQ Bot Validator

Use the Validator to manually validate documents from which IQ Bot could not extract data.

When IQ Bot processes documents in a learning instance that is in production mode and encounters one of the following scenarios, IQ Bot sends that document to the Validation queue.

- Data is not readable, such as blurry text or dark background.
- Data is missing from a required field.
- Document failed an automated processing rule.
- Fields did not meet the set optical character recognition (OCR) confidence threshold.

---

**Note:** To learn more about how field-level OCR confidence can be used to improve the quality of STP output, see [Improve output quality using OCR confidence](#) on page 3762.

---

A user with the **AAE\_IQ Bot Validator** role opens the Validator window, where they correct the flagged fields.

Once all the fields in the document are corrected, IQ Bot finishes processing the document and exports the data to a .CSV file in the Learning Instance success folder.

---

**Note:** If a document required manual validation, it is excluded from the straight-through processing (STP) metric. For more information on the dashboard metrics, see [Review the dashboard](#) on page 3793.

---

As you work on a document in the Validator queue, if you leave the Validator queue or log out of IQ Bot, the lock on the document is released, allowing other users to access or validate the document.

### Validator interface overview

The Validator interface opens with the first document from the validation queue. The data requiring validation distinguished with red text or outlined in red boxes.

---

**Note:** An empty page with a notification message appears in the following scenarios:

- If no files are available in the validation queue.
  - If a file does not exist in the validation queue.
  - If another user is working on the remaining file in the validation queue.
-

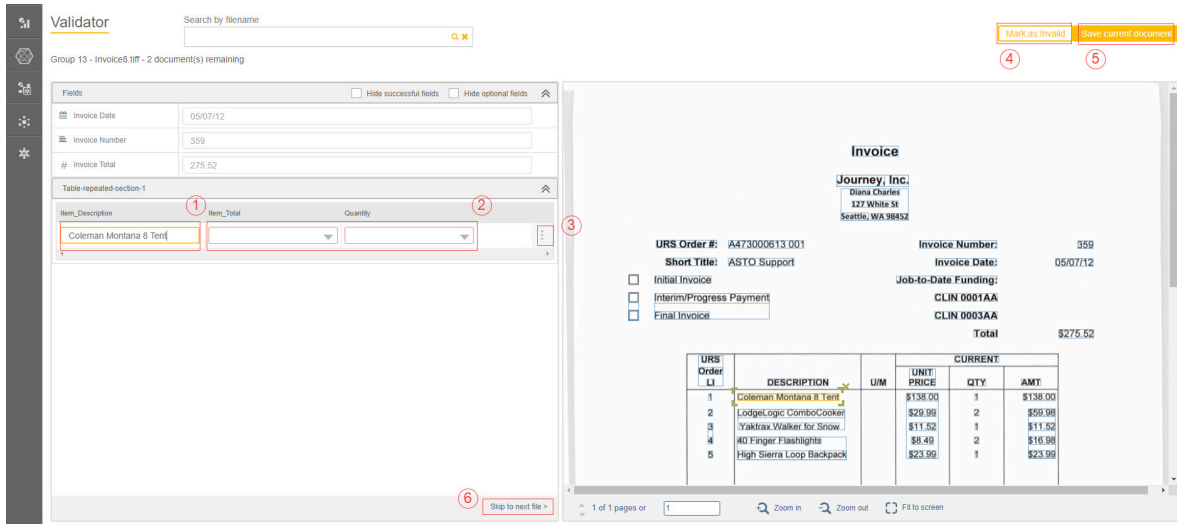

1. Provide the values for fields IQ Bot could not extract

Click the empty text field, then select the blue-bordered box in the document that contains the data to extract. After you select a box, the data is highlighted in yellow and a green outline appears, which you can resize or reposition to include all the data that you want to extract.

2. Fields awaiting validation are outlined in red

In the example above, the table fields **Item total** and **Quantity** require manual entry.

3. Add or delete a row

To insert or delete a row, hover over the ellipses to show the icons for adding or deleting table rows.

4. Mark document as invalid

Removes the document from the validation queue and saves a copy of the document to the Invalid folder. Click here to mark a document as invalid, then select from the following reasons:

- Fields missing
- Tables missing
- Wrong values

5. Save current document

After you have validated all the fields, click here so IQ Bot can finish processing this document.

6. Skip to next file

Skip a file without correcting the errors in the current document.

## Linked tables in the Validator

Some pages in a document might contain more than one table. When there is a relationship between the tables, such as in the example page below, where a parent table contains patient information and child tables contain additional information related to that patient, these are called linked tables.

In the example page below, the red box outlines the parent table and each of the blue boxes outline a child table.

Patient Name: Irrfan Khan Member ID: IQ_Bot0001 Date of Birth: 07 Jan 1967 Provider Name: Cognitive		Patient Account No: AASPL_3100 Claim ID: Cognitive_123XXX Claim Status: PAID					
Gender: <input checked="" type="radio"/> Male <input type="radio"/> Female <input type="radio"/> Other		Type of payment: <input type="checkbox"/> Cash <input type="checkbox"/> Cheque <input checked="" type="checkbox"/> Bank Account					
Line	Date of service	Rev Code	Units	Billed Amount	Allowed Amount	Discount /Penalty	N
1	02/02/18	0211	1	100.00	100.00	0.00	10
2	03/02/18	0221	5	500.00	500.00	0.00	50
3	03/02/18	0200	3	300.00	300.00	0.00	30
Claim Totals			9	900.00	900.00	0.00	90

Payment Mode (If Bank Account):

Net Banking

Debit Card

Credit Card

Type of Card (Only for Debit or Credit card) Payment:

Master Card

Visa Card

◆ Paid

To successfully validate a page with linked tables, add the fields from the child tables to same **table-repeated** section as the parent table.

If shared fields between the linked tables do not match values, the Validator does not let you complete validation and save your changes. This functionality helps avoid manual validation errors that can occur when there is a mismatch of field values between the parent and child tables. The Validator shows an error message and prevents the save.

**Note:** In Validator, if you mark an already corrupted document as invalid then that document is lost in the IQ Bot system. Instead, you will see a placeholder image and you must refresh the page to go to the next document. This applies to single page as well as multi-page documents. When the entire multi-page document is deleted or corrupted, you will not be able to navigate between the pages. If you click the next page button, then the Loading document screen is displayed.



## Using the Validator

Open the Validator user interface from the **LEARNING INSTANCES** tab. If a learning instance contains documents that require validation, there will be a document icon with a red exclamation mark in the Actions column. Click the document icon to launch the Validator.

---

**Note:** Only users with an assigned Validator role can view the Validation page. For more information, see [IQ Bot user personas and roles](#) on page 3734.

---

## Review the dashboard

The dashboard summarizes the performance report and provides document processing information in a graphic format.

The report appears when you log in to the IQ Bot. The information shown consists of: document classification, straight-through processing (STP), accuracy, and human validation for information on actions for a specific learning instance so you can focus on areas that require attention.

The IQ Bot dashboard is divided into two primary areas:

- **My Totals**
- **My Learning Instances**

### My Totals area

**My totals** is a display area of the Dashboard that provides a quick overall view of the status of all learning instances in the Production environment.

View the following information in the **My Totals** area:

- Documents Processed: The total number of files processed in the production environment.

---

**Note:** If a file is corrupt and cannot be opened, it is not included in this count.

---

- Pages purchased: The number of pages purchased in the current license period.

For example, if 4000 pages were purchased before Dec 31, 2020 and another 20,000 pages were purchased between January 1, 2021 and February 28, 2021, the pages purchased metric shows a count of 20,000 pages, not 24,000. This is because 4000 of the pages were purchased before the license validity period.

---

**Note:** This metric is visible only to users with the **AAE\_IQ Bot Admin** role or a custom role with the **View administration** permission.

---

- Pages uploaded: The number of pages uploaded to a learning instance in the production environment in the current license period. When the license is renewed, the value reverts to zero.

This metric is different from the documents processed metric because one document can contain multiple pages. Additionally, the metric count includes pages that were uploaded but have not completed processing.

The number of pages uploaded is refreshed every time the Control Room license is renewed. So, the Pages uploaded shows the pages uploaded or processed in the current license period. The Documents Processed count remains unaffected.

---

**Note:** In releases prior to Automation 360 v.23, this metric reflected the number of pages uploaded to learning instances in the production environment from the time of IQ Bot installation.

---

- Straight-through processing (STP): The percentage of total number of uploaded files that were successfully processed without manual intervention.
- Accuracy: The field accuracy, which is a percentage value of fields that have been accurately identified. This includes fields whose Optical Character Recognition (OCR) confidence levels exceed the confidence threshold that were set.

## My Learning Instances area

View details of learning instances you have created that are in the Staging and Production environments.

View information for learning instances in the staging environment:

- Name of the learning instance
- The domain or type of documents. For example, invoices and receipts.
- Number of documents in the learning instance
- A graphical representation of trained documents showing the details in percentages

View information for learning instances in the production environment:

- Number of files processed
- Straight-Through Processing (STP) percentage of files that were successfully processed without manual intervention
- Field accuracy in percentages

---

**Important:** Sometimes, the number of documents in the Dashboard and in the Learning Instance summary page do not match the number of documents submitted for processing. This can occur when documents are classified into groups that are not in production. Documents in this category are not processed (by design), leading to a mismatch between the number of processed documents and the number of total documents. In such a case, if these groups are moved to production, the total numbers of documents will match.

---

## Performance report page

The performance report page displays the details of a learning instance in the production environment.

Navigate to **My learning instances > Production** button to view the **Performance report** page showing details of all learning instances in the production environment.

---

**Note:** The **Performance report** page is not available for learning instances that are in the staging environment.

---

The top right corner of the performance report page displays the percentage of bots trained for the learning instance. The following is an example of how to interpret the percentage information.

Cathy has uploaded 10 documents and has created three bots for the learning instance:

- Bot1
- Bot2
- Bot3

Of these, three documents are a part of Bot1, four documents of Bot2, and three documents of Bot 3. When Cathy sets Bot1 into the production environment, the label displays 33% as the percentage of bots trained for the learning instance, which means that 3 out the 10 (33%) uploaded documents (for Bot1) have been trained.

## Performance report details

In the **My learning instances** area, click any displayed information to bring up the **Performance report** page. The following sections describe the information for each displayed section of the performance report.

### Instance totals and Processing results

The instance totals and processing results area shows the following information for a learning instance:

- Number of files uploaded for the learning instance – total number of files uploaded that need to be processed.
- Number of files processed for the learning instance - number of files that was processed by a bot.
- Number of files successfully processed for the learning instance – includes files that were successfully processed by a bot without human intervention.
- Number of files sent to validation for the learning instance – files flagged with one or more errors that need human intervention for review.
- Number of files validated for the learning instance – number of files that were reviewed by an individual and the results were saved.
- Number of files marked as invalid for the learning instance – number of files that were reviewed by an individual and marked as invalid.

### Classification results

The Classification area provides a statistical display of the field representation graphically.

### Accuracy results

The Accuracy area provides a graphical representation of the field types.

## Validation

The Validation area provides the following information:

- A statistical representation of the corrections made to individual fields during the process of validating a document.
- A statistical representation of the average time spent to validate a group.

## Custom domains in IQ Bot

A domain contains information about the language of the documents and the data fields that the system extracts from the documents. The IQ Bot environment includes seven domains; users with the **AAE\_IQ Bot Admin** role can also create and import custom domains to the **Domains** tab.

If your documents contain specialized fields, you can create a custom domain with these fields to make learning instance creation quicker. Otherwise, the learning instance creator must manually define each specialized field, every time they create a new learning instance.

For example, for documents from the pharmaceutical industry, you might add fields like prescription name, dose, or delivery format to the custom domain. Likewise for financial industry documents, you might add fields for margin, call price, or limit order.

The **Domains** tab displays all available domains for use in the system and their associated languages. Besides out-of-box domains offered by IQ Bot, you can also create a custom domain and import it into IQ Bot.

[Create a custom domain \(A-people login required\)](#)

For information on creating a custom domain, see: [How to create a Custom Domain](#)

When creating a learning instance using a custom domain:

- The languages assigned to the domain when creating the domain is displayed and is available for selection from the **Primary language of documents** drop-down list.
- The fields that were selected when creating the custom domain are displayed in the **Fields to extract** section of the create **New instance** page.

You can import or export a domain using the **Import** or **Export** option in the **Domains** tab.

---

**Note:** Domains are created and saved with the `.dom` extension in the system.

---

**Tip:** Troubleshoot classification issue with Chinese language documents:

[Classification issue with Chinese Invoices \(A-People login required\)](#)

---

## Import a domain

You import a domain for the following scenarios:

- Import a new domain.
- Import an existing domain from another system to your current system.

When you are ready to import a domain into your system:

1. Go to the system where you want the domain to be imported.
2. Click **Import new domain** in the **Domains** tab and select the `.dom` domain file in your local machine that you want to import.

The domain import success message is displayed in the **Domains** tab.

The imported domain appears for the selection in the **Document type** drop-down list of the create **New instance** page and is displayed in the domains list in the **Domains** page.

## Export a domain

When you click the **Export** option next to a domain, it is exported to an output folder on your local drive. The exported domain is encrypted and is created with a `.dom` filename extension.

You export an existing domain from one IQ Bot system to import to another.

To export a domain from your IQ Bot system, do this: In the **Domains** list page, click the **Export** option next to the domain you want to export.

The system displays a success message for the exported domain.

The file is exported to a local output folder on your machine with a `.dom` filename extension.

---

**Note:** The domain files are encrypted for security.

---

## Current limitations to the domain import and export actions

---

**Important:** Import or export of domains is independent of the migration action in the Migration Utility feature.

---

When you migrate learning instances that were created using a custom domain from one system to another, the field names and IDs must be the same in the target machine as well. Otherwise, even though the learning instances are imported, the custom domain will not be imported and the associated field names and IDs for the custom domain will not work in the imported learning instance. If you run the imported learning instance on documents, the documents will not be classified.

Even if you import the custom domain to your new system, the field names and IDs will still not match as these are automatically generated by the system. Hence classification will fail. This is the current limitation of the Migration Utility feature using a custom domain.

Workaround: First import the `.dom` file to the target machine, then migrate the learning instances. Move all learning instances to the staging environment, and test them before moving the learning instance to the production environment.

## Custom domain enhancements

Import custom domains in any order

When you migrate learning instances (created using a custom domain) from the staging server to the production server, migration fails unless you import the different versions of the custom domain in the same order as they were created.

As the capability to edit a custom domain to add additional fields and aliases was not available, the user had to create a new domain and add the additional fields and aliases to it. Then the user had to assign that new domain to the learning instance. So when the user wanted to use the new domain, they had to re-import the original and the new domain to the production server in the order they were created in.

#### [Importing custom domain to IQ Bot production \(A-People login required\)](#)

From release Automation 360 Build 5322, this restriction does not exist.

- You can edit and update an existing custom domain multiple times, and import them to the production server multiple times as well.
- You can import the custom domains in any order. The system successfully migrates the updated fields (form or table), and field aliases (variations of field values found in the training documents, associated with a field) to the production server.

---

**Important:** Perform all edits or updates to a custom domain in the staging server before importing it to the production server to avoid errors.

---

IQ Bot performs document classification based on the defined fields and aliases of the version of custom domain used when the learning instance was created.

Editing the same custom domain (with additional fields) changes the version of the custom domain. For new learning instances created using the new version of the custom domain, classification occurs on the updated fields as well. The edited fields (whether form or table fields) are displayed in the learning instance with a double asterisk next to them to help identify them.

## Using IQ Bot for standard forms

Standard forms are fixed format type documents that usually contain a large number of fields with very little or no variation in the overall layout, which can include both hand-written and digital content. IQ Bot enables you to extract data from standard forms.

Some examples of standard forms are W-4 (Employee Withholding Certificate), income tax form, sale deed and partnership agreement. You can extract data from standard forms by customizing and building a model before setting it up in IQ Bot. A machine learning model is a file that can be trained to recognize certain types of patterns from documents. You can use a sample document with a set of data to train a model to recognize patterns.

Based on the associated role or permission defined by the Control Room administrator, you can then create a learning instance using a model for extracting data from standard forms.

---

**Note:** Users must have the Standard forms pages product license to upload documents for processing. For more information, see [Automation 360 licenses](#) on page 1407.

---

The following workflow describes the various stages and procedures for setting up data extraction from standard forms:

1. Evaluate your use case for standard forms.

[Evaluate your use case](#) on page 3800

- 2.** Review the type of standard forms extraction service that fits your requirement.  
[Review extraction service](#) on page 3802
- 3.** Review the service implementation prerequisites.  
[Review implementation prerequisites](#) on page 3803
- 4.** Set up and configure an extraction service.  
[Set up extraction service](#) on page 3807
- 5.** Configure IQ Bot for the selected extraction service.  
[Configure IQ Bot for extraction service](#) on page 3808
- 6.** Build a data extraction model.  
[Build extraction model](#) on page 3808
- 7.** Log in to IQ Bot and create a learning instance.  
[Create a learning instance for standard forms](#) on page 3809
- 8.** Add validation rules for standard forms learning instance.  
[Define validation rules for standard forms learning instance](#) on page 3811
- 9.** Transfer the third-party extraction models  
[Transfer third-party extraction service models](#) on page 3809
- 10.** Move standard forms learning instance across different IQ Bot environments.  
[Transfer standard forms learning instance](#) on page 3813
- 11.** Upload documents in IQ Bot.  
[Upload documents for standard forms learning instance](#) on page 3812
- 12.** Validate the processed documents for standard forms learning instance.  
[Use the IQ Bot Validator](#) on page 3790
- 13.** Download the content extracted from standard forms.  
[Download extracted content](#) on page 3812
- 14.** Review the performance report and document processing information.  
[Review the dashboard](#) on page 3793

Workflow map: Click the following schematic image to view the Standard forms workflow in an



interactive visual format:

1.

Related concepts

[IQ Bot user personas and roles](#) on page 3734

Learn about the users that contribute to IQ Bot and the associated roles and licenses. IQ Bot users and roles are defined in the Control Room.

## Evaluate your use case

Content extraction models can be integrated into IQ Bot for extracting data from specific type of documents.

Before you proceed further with standard forms, evaluate your use case to determine if the content extraction from standard forms suits your requirement. Use the following questions as a guide to determine whether your use case needs Standard forms processing

What are standard forms?

Fixed format type documents that have a defined template, with very little or no variation in the overall layout. Standard forms are also known as structured documents, are generally characterised by high density of information, and are typically official or legal forms. The following table illustrates some examples of standard forms:



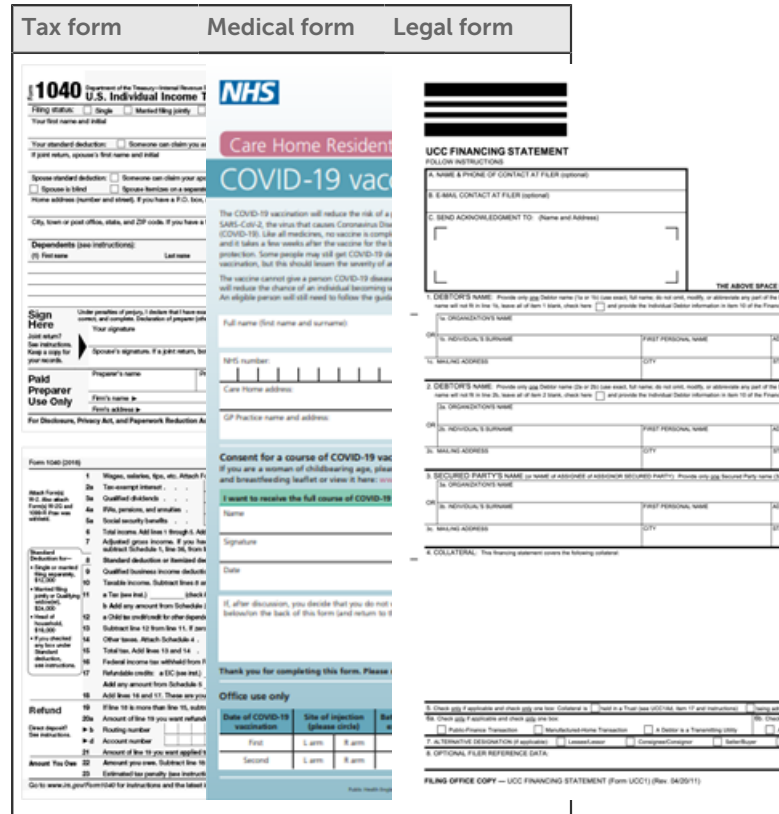

Does the layout of your documents vary across vendor?

If yes, then this use case for content extraction using standard forms is not the best option.

Are the positions of the various data elements (checkboxes, tables, and so on) fixed in your documents?

If no, then these are not standard forms and this type of content extraction is not suitable.

Is the document a dynamic form? For example, you have documents where the values depend on other data elements.

If yes, then content from such documents cannot be processed using standard forms content extraction.

Is the document in a supported language?

See [Azure Form Recognizer Supported Languages](#). If no, then the document cannot be processed as a standard form.

Does the documents have repetitive sections?

If yes, then this is not a standard forms use case. However, if there are a fixed number of such repetitive sections that do not vary between documents, then it can be processed as a standard forms.

Does your documents contain tables that have a different number rows and columns?

If yes, then these documents cannot be considered as standard form. The number of rows and columns have to be fixed for standard forms.

Can document layouts that vary per year be considered as standard forms? For example, a

If the document layout does not vary within the same year or vary across organizations, then it can be considered as standard forms. If there

W-4 document in 2020 and W-4 document in 2021? are layout variations across years, then different standard form models must be used to process these documents.

## Review extraction service

After you have confirmed that the documents you want to extract content from are standard forms, you can then plan the type of standard forms extraction service that fits your requirement.

The following technologies are available for processing standard forms:

### IQ Bot extraction service

This is a template based extraction service that uses OCR and heuristics to extract content from standard forms. You have to train one template per standard form.

Guidelines for using IQ Bot extraction service

- Documents are of good quality (300 dpi)
- Document content is not very dense
- Input documents do not have any handwritten copies (limited support)
- Signatures are currently not supported
- Contains simple table layout (span within a page) with clear header, table boundaries, and so on
- Does not contain any tables or content that have checkboxes (limited support)
- Does not have any repeated sections (limited support)

Benefits of IQ Bot extraction service

- An integrated and simple out-of-the-box setup
- Various OCR engines to increase accuracy of extraction
- Complex layouts (repeated sections, continuous tables etc) can be extracted for specific cases (needs testing)
- Only requires IQ Bot license

### Microsoft Azure Form Recognizer service

Third party technology, that provides custom built Artificial Intelligence (AI) models to extract content from standard forms. You can create custom models where documents can be labelled and trained.

Guidelines for using Microsoft Azure Forms Recognizer service

- Input documents:
  - can be dense (contain lot of details and information) and have a reasonable quality (>200 dpi)
  - can contain checkboxes and radio buttons
  - can have handwritten content
  - can contain signatures
  - can contain tables

The input documents can also contain tables that span over a single page. However, if the standard forms contain table that span across multiple pages, the content extraction can fail.

- None of the sections in the input documents are not repeated
- Documents that contain transpose tables

Benefits of Microsoft Azure Forms Recognizer service

- Diverse standard form type documents can be processed
- Auto detection feature can identify different types of tables such as header-less table, inverted tables, and so on
- Good support for handwritten forms

## Review implementation prerequisites

After you have finalized the type of extraction service that suits your requirement, ensure that you review the prerequisites before proceeding with the implementation of the service.

### IQ Bot extraction service

Review the operating system and database compatibility, database information, and various hardware and software requirements as part of prerequisites for using IQ Bot extraction service.

See [IQ Bot system requirements](#) on page 1431.

### Microsoft Azure Form Recognizer service

Review the prerequisites of Microsoft Azure Form Recognizer service installation for standard forms.

- Cloud setup and installation  
No additional configurations are required. However, based on the page processing volumes, the Transactions Per Second (TPS) must be increased for the Microsoft region where your service is running. Contact your Customer Success Manager (CSM) or Partner Enablement Manager (PEM) with the expected page volume and Microsoft region where the service is running to update the TPS.
- On-Premises setup and installation

[Pre-requisite for Azure Container on-prem installation for Standard Forms \(A-People login required\)](#)

## Considerations for optimum performance

Review the considerations to capture the performance metrics of IQ Bot standard forms with a new Model containing more number of forms or table fields.

### Test summary

- Performance test was run for 10000 COVID Form documents (two pages per document = 20000 pages) on a single node IQ Bot server using a single Bot Agent (using IQ Bot Extraction package). This test was conducted to benchmark the performance metrics such as processing time, Straight Through Processing (STP), validation, and documents processed (#successful processed pages/documents and #failed pages/documents).
- New Model (WalgreenComplete 3260b299-68b5-4118-87df-b313bd5c30f6) with 26 Form Fields & 8 Tables fields are trained and used for extraction.
- With new Model (WalgreenComplete 3260b299-68b5-4118-87df-b313bd5c30f6), all the documents were moving to validation during extraction. To get STP we marked below 5 fields as optional for this test: A2PatientSign, B2Date, B2Sign, Phone, InsuranceCard(Table)->Card Details.
- Total time take to process 20000 pages using single Bot Agent was 25 hours, 21 minutes, & 42 seconds. This was based on IQ Bot On-Premises Build 12350.
- Average time take to process single page using IQ Bot Extraction package on single Bot Agent is approximate 4.56 seconds.
- Achieved STP: 100% and Accuracy: 100%.
- During our test execution, the requests were served by Microsoft standard forms services hosted in us-west2 region.
- As confirmed, Microsoft team TPS (Transactions Per Second) supported by us-west2 region was 100 TPS

**Note:** KPI (Key Performance Indicators) like processing time, STP, accuracy might vary based on the regions where Microsoft standard forms service is hosted and its transactions per second (TPS) rate.

### Infrastructure configurations

The following table lists the infrastructure configurations:

Server	Parameters	Values
Server 1 [Web Server]	Control Room	Windows Server 2019 → 8vCPU, 16 GB RAM, 512 GB Disk [Rackspace Platform]-uee
Server 2 [Database]	Database	Windows Server 2019 → 8vCPU, 16 GB RAM, 512 GB Disk [Rackspace Platform]
Server 3 [Application Server]	IQ Bot	Windows Server 2019 → 8vCPU, 16 GB RAM, 512 GB Disk [Rackspace Platform]

Server	Parameters	Values
Server 4 [Client]	Bot Agent	Windows Server 2019 → 4vCPU, 8 GB RAM, 256 GB Disk [Rackspace Platform]

## Product configurations

The following table lists the product configurations:

Parameters	Values
Automation Anywhere Enterprise	Automation 360 Build 12313
Bot Agent	21.80.10273
IQ Bot	A360.24.28441-20220311
IQ Bot Extraction package	1.0.0-20220307-024320
Database	Microsoft SQL Server Developer (64-bit)
Protocol	HTTPS
Network services	Non-Active Directory

## Data configurations

The following table lists the data configurations:

Parameters	Values
Domain	Standard forms
Provider	Forms Extractor Type 1
Model	WalgreenComplete 3260b299-68b5-4118-87df-b313bd5c30f6
Document Type	Multi page PDF document
Pages	Two pages per document
Form Fields	26 [A2Date, A2PatientSign, Address, Age, B2Date, B2Sign, City, DOB, Email, FirstName, LTCFName, LastName, Phone, PrintName, Race-American, Race-Asian, Race-Black, Race-Native, Race-Other, Race-UnableToReport, Race-Unknown, Race-White, RefusedInformation, State, VaccinationType, Zipcode]

Parameters	Values
Table Fields	8 tables, 23 table fields Table1: DriversLicense[Issuance, LicenseNo]Table2: Ethnicity[Hispanic, NotHispanic, UnableToReport, Unknown]Table3: Gender[Female, Male]Table4: InsuranceCard[Card Details, Medical Card, Pharmacy Card]Table5: MedicareDetails[Medicare, Medicare PartB]Table6: PatientCardHolder[DontKnow, No, Question, Yes]Table7: PatientType[Resident, StaffMember]Table8: ScreeningQuestions[DontKnow, No, Question, Yes]
Configuration	COVID forms
# of Documents	10000
# of Pages	20000
Language	English

## Test results

The following table lists the test results:

Parameters	Values
Total Documents Uploaded	10000
Total Pages Uploaded	20000
Total Processed documents	10000
Total Processed pages	20000
Success	10000 documents
Pending Review (Validation)	0
STP	100%
Accuracy	100%
Processing Time	25 hours, 21 minutes, and 42 seconds

## Resource consumption data

The following table provides the resource consumption data:

Parameters	CPU Utilization in %	Memory Utilization in %
IQ Bot	Average: 3.4 Maximum: 26.8	Average: 70.9 Maximum: 78.9

Parameters	CPU Utilization in %	Memory Utilization in %
Control Room	Average: 1.4 Maximum: 14.5	Average: 83.3 Maximum: 84.8
Database	Average: 3.3 Maximum: 20.6	Average: 91.5 Maximum: 94.1
Bot Agent (Extraction)	Average: 4.8 Maximum: 48.9	Average: 52.4 Maximum: 58.7

## Set up extraction service

To extract content from standard forms, you must setup and configure an extraction service. Review this topic to understand how to setup each of the extraction service.

### IQ Bot extraction service

No specific setup is required for content extraction through IQ Bot service. Ensure that you have access to an active IQ Bot environment so that you can create a learning instance.

See [Create a learning instance](#) on page 3746.

### Microsoft Azure Form Recognizer service

#### 1. Subscribe to Microsoft Azure service

Microsoft provides the Azure Form Recognizer service. This service enables you to build automated data processing software that can identify and extract specific content from documents. You must have Microsoft Azure subscription in order to access Azure resources (OCR, Form Recognizer), Automation Anywhere provides access to these resources through its subscription. Contact your Customer Success Manager (CSM) or Partner Enablement Manager (PEM) who will help you setup the services.

[Request access for Microsoft Azure resources \(OCR and Form Recognizer\) \(A-People login required\)](#)

#### 2. Setup Microsoft Azure Form Recognizer service

##### a) For Cloud deployment

- If you have Automation Anywhere subscription, no additional configurations or changes are required.
- If you have Microsoft Azure subscription, review the following article to setup and configure your Microsoft Azure Form Recognizer for extracting content from standard forms.

[Setup Azure Form Recognizer and Storage \(Cloud\) \(A-People login required\)](#)

##### b) For On-Premises deployment

[Setup Azure Form Recognizer and Storage \(On-Premises\) \(A-People login required\)](#)

## Configure IQ Bot for extraction service

IQ Bot must be connected to the extraction service for processing standard forms. The following section provides details on how to configure IQ Bot for the selected extraction service. However, your IT Service team can help you setup and configure the extraction service in IQ Bot.

### IQ Bot extraction service

If you choose IQ Bot extraction service, no additional configurations are required.

### Microsoft Azure Form Recognizer service

If you choose the Microsoft Azure Form Recognizer service, you must add Microsoft Form API and the corresponding configurations in IQ Bot.

[How to Setup and configure standard forms in IQ Bot \(A-People login required\)](#)

## Create the model in Document Automation

In Automation 360 v.26, you can configure the extraction model in the Control Room:

[Create a custom extraction model using Standard Forms](#) on page 3699

## Build extraction model

Data extraction model typically leverages Artificial Intelligence (AI) and Machine Learning (ML) technologies to accurately extract text, key-value pairs, and tables from documents.

### IQ Bot extraction service

Requires no separate AI model as this will be done as part of creating and training a learning instance in IQ Bot.

See [Create a learning instance](#) on page 3746.

### Microsoft Azure Form Recognizer service

During your use case evaluation, Microsoft Azure Form Recognizer models can be created by Sales Engineering. But for any production deployment, contact Professional Services, or Partner Enablement Manager (PEM) at Automation Anywhere.

[How to Create and train Azure Form Recognizer model \(A-People login required\)](#)

The benchmarks for the time taken for labeling fields in the Microsoft Azure Form Recognizer service are as follows:



- Up to 30 fields: 1 hour
- 30 to 100 fields: 2 hours
- 100 to 400 fields: 4 hours

---

**Note:** While creating a model, ensure there are no duplicate model names. And while creating a table, ensure that the table name does not contain a space. For example, `Sales chart.xls`.

---

## Transfer third-party extraction service models

Third party extraction models can be transferred from one subscription to another. Contact your Automation Anywhere Customer Success Manager (CSM) for assistance.

### IQ Bot extraction service

If you are using IQ Bot extraction service, no changes required.

### Microsoft Azure Form Recognizer service

- Transfer models from one On-Premises to another On-Premises environment.  
[Transfer models from one environment to another \(On-Prem\) \(A-People login required\)](#)
- Transfer models from one Cloud to another Cloud environment.  
[Transfer models from one environment to another \(Cloud\) \(A-People login required\)](#)

---

**Note:** You can transfer standard forms learning instance along with an associated model between your IQ Bot instances using API configurations. For more information, see [Transfer standard forms learning instance and associated model \(A-People login required\)](#)

---

## Create a learning instance for standard forms

Learning instance is used in IQ Bot to extract, train, validate content from standard forms. Use the following instructions to create a learning instance for processing standard forms in IQ Bot

### Using IQ Bot extraction service

Ensure that you have access to an active IQ Bot environment so that you can create a learning instance.

See [Create a learning instance](#) on page 3746.

### Using Microsoft Azure Form Recognizer service

1. From the **Document type** drop-down menu select **Standard Forms**.
2. In the **Standard form settings** tab, from the **Provider name** drop-down menu, select a provider for processing the form.

3. From the **Configuration type** drop-down menu, select the supported configuration.  
This enables you to connect to one of the provider services configured during installation.
4. From the **Select Model** drop-down menu, select a pre-trained model for the selected configuration.
5. Click **Browse** to upload a reference document.  
For example, if you have selected the configuration type and model as invoice, you can upload an invoice file that must be analyzed.

---

**Note:** The reference document is only a representation of the document type you want to extract data from.

---

6. From the **Fields to extract** tab, select the fields from where the values must be extracted.  
The fields are displayed based on the selected Form set in the pre-trained model, and no additional fields can be added.
7. Click **Create instance and analyze**.  
The system analyzes and sorts the document into logical group.

---

**Note:** Only one default group is created. The system-identified region (SIR) are not visible and all the training related fields are greyed out. As the standard forms learning instance contains pre-trained model, no additional training of the group is available. You can only add validation patterns and custom logic.

---

After you have created a learning instance, you must add a group specific to standard forms.

8. On the **Learning Instance details** page, click **Add group**.
9. Create group label as <Standard Forms layout name>.  
For example, if you have W-4 documents for the year 2021, enter W4\_2021.
10. Click **Save**.
11. Open the system generated group
12. Click **Delete Bot**.  
System generated group is removed from the **Learning instance details** page

## Edit a standard forms learning instance

As the learning instances created by using standard forms have pre-set configurations, you can edit only the name and the description. Also, you cannot edit instances in the production environment without moving them to staging.

---

**Note:** If you want to change the model associated with a learning instance, you must create a new model and follow these instructions:

1. Create another learning instance similar to the previous one.
2. Associate the new model with this learning instance.
3. Select all the fields you had selected in the previous learning instance.
4. Update the validation rules.

5. Move the learning instance to production and associate a bot with this learning instance.

- 
1. On the **My learning instances** page, select the learning instance you want to edit.

You can also use the **Search** bar to locate the learning instance.

2. Click **Edit**.

3. Edit the name of the learning instance in the **Instance name** field.

The document classification options are not available as the standard forms use a pre-trained model and configurations.

4. Optional: Use the **Document Groups** tab to review the groups associated with the learning instance.

---

**Note:** The **Add group** button is not available as adding groups is not supported for a standard forms learning instance.

---

5. Optional: Click the **Summary** tab to review the learning instance.

Standard Forms details such as **Provider**, **Configuration**, and **Model** are available under this tab.

6. Click **Save**.

Changes made to the learning instance are updated on staging.

## Define validation rules for standard forms learning instance

To prevent wrong or invalid data extraction, you can edit the bot associated with any standard forms learning instance and customize the validation rules.

You can only edit a bot on staging. So ensure that you move any bot that you want to edit to staging if it is in production.

## Using IQ Bot extraction service

Use IQ Bot Designer to train a learning instance and extract content from sample documents. Review each field to ensure the correct value is extracted and where necessary, map the correct field.

For more information, see [Train a learning instance](#) on page 3756.

## Using Microsoft Azure Form Recognizer service

1. On the **Bot** page, select the bot you want to edit.

You can also use the **Search** bar to locate the bot.

2. Click the **Edit Bot** icon.

3. In the **Field** column, click **Field options**.

4. Enter any custom validation rules in the fields under the **Validate Pattern** tab.

Documents that are not processed are moved to the **Validator**, and fields with errors are flagged. You can review the flagged fields in the Validator.

[Use the IQ Bot Validator](#) on page 3790

5. Enter post processing logic under the **Logic** tab, and click **Save**.
6. Click **Save**.  
The updated bot is saved on staging and you can move it to production.

## Upload documents for standard forms learning instance

Upload your documents to IQ Bot for an existing standard forms learning instance for content extraction.

For extracting content from a single document, use the **Upload Document** action from IQ Bot package in Automation Workspace.

See [Upload document action](#) on page 2759

For content extraction from multiple or large number of documents, you can use the **Process documents** action from IQ Bot Extraction package in Control Room. Use the following instructions to upload multiple or large number of documents:

1. Drag the **Process documents** action into the workflow.
2. Click the **Learning instance name** drop-down menu and select a standard forms learning instance.
3. In the **Desktop folder** tab, enter the file path for the input folder or click **Browse** to select it.
4. Select the output folder from the **Output folder path** field.
5. Select the **Send documents to IQ Bot Validator for validation** check box.

Although the documents are processed using Bot Runners on your local machine, you must use this option if you want to validate the documents in the Validator

6. Click **Save**.

## Download extracted content

After you have trained learning instance, use the **Download all documents** action from the IQ Bot package to download extracted content from standard forms.

1. Drag the **Download all documents** action from the **IQ Bot** package.
2. Click the **Learning instance name** drop-down menu and select a standard forms learning instance.
3. In the **Local output folder** field, provide a path to your local folder where you want to extract the content.
4. In the **IQ Bot Document status**, select the appropriate status for the documents:
5. Select **Delete files from the server after downloading** check box if you want to remove the files from IQ Bot server.
6. In the **Save the response to a variable** field, add a variable.

A variable value in this field provides information if the download was successful or the reason for a failure.

7. Click **Save**, and run the bot.
8. Navigate to the local output folder to review the downloaded files.  
The output folder can have up to three subfolders:

- **Retrain:** Contains documents that were sent for validation.  
These documents are stored in their original input format and you can train them by uploading them to your existing learning instance.
- **Success:** Standard form documents that have been processed successfully.  
The output is a `.json` file. Tables in the input documents are auto extracted and saved as separate `.xls` file with the table name.
- **Validate:** Contains documents that require validation.  
These documents will be available in the IQ Bot Validator and you can download the output separately.

---

**Note:** Depending on the content in the uploaded documents, you can also get the following additional subfolders:

- **Failed:** Documents that failed the validation process.
  - **Unprocessed:** Documents that could not be classified.
- 

## Transfer standard forms learning instance

A standard forms learning instance is similar to the regular IQ Bot learning instance that describes the data in a single document type, for example an invoice. It contains information such as the language used in the documents and the fields to extract.

- Ensure that the source and destination systems are running the same IQ Bot version. Learning instances from different IQ Bot versions cannot be imported because their database schema will not match.
- Back up your database before importing learning instances.
- Export the `.iqba` file from the source IQ Bot environment.
- Import the `.iqba` file into the destination IQ Bot environment

Related concepts

[Manage learning instances](#) on page 3787

A learning instance is an IQ Bot structure that describes the data in a single document type, for example an invoice. It contains information such as the language used in the document and the fields to extract.

## Export a standard forms learning instance

Standard forms learning instance can be used across similar IQ Bot environments. Export an existing learning instance to avoid creating another one with the same configurations.

IQ Bot administrator can use the following instructions to edit a standard forms learning instance:

1. Click **Administration > Migration**.
2. Click **Create Backup**.

Backing up your existing learning instance enables you to save and restore the configuration if required.

3. Select the learning instances that you want to back up and then click **Backup**.
4. Enter a name for the IQ Bot archive (IQBA) file.

The name of the archive file is appended with a time stamp to make it unique. You can download this file and export it to the target environment.

5. Click **Backup** to begin the export process.

The exported data file with the `.iqba` extension is available in the BackupData folder in your IQ Bot output directory.

## Import a standard forms learning instance

Import an existing learning instance from a similar environment to avoid creating learning instances and associated bots multiple times. Use the Automation 360 IQ Bot Migration Utility feature to import any standard forms learning instances.

Ensure that you have migrated the associated configuration to the target server before importing a learning instance.

When you export an `.iqba` file, only a single document associated with every available bot (Group) training is exported.

1. Log in to IQ Bot as an administrator.

2. Click **Administration > Migration**.

A list of backed-up learning instances is displayed.

3. Click the **Import** icon under the **Actions** tab for the selected learning instance.

4. Select the import method, and click **Accept**.

The selected standard forms learning instance is imported and is displayed under in **My learning instances** page.

# Process Discovery

Process Discovery is a data-driven approach to analyze, monitor, and improve business processes by extracting insights and knowledge from the user interactions with various systems. It uncovers the actual flow of activities, decisions, and interactions that occur within an organization's processes.

Process Discovery drives organizational efficiency, cost reduction, and enhanced quality control. This approach fosters insights into process operations, pinpointing areas for enhancement like automation, workflow streamlining, and step elimination. Leveraged in process improvement, compliance, and risk management endeavors, Process Discovery proves invaluable.

## Components

The Process Discovery platform is used in combination with the Process Discovery Sensor and Privacy Enhanced Gateway (PEG) applications to streamline data capture, analysis, and process modeling.

### Process Discovery Platform

The Process Discovery platform is used in combination with the Process Discovery Sensor and Privacy Enhanced Gateway (PEG) applications to streamline data capture, analysis, and process modeling. The Process Discovery interface enables users to perform the following tasks:

- Capture, parse, and analyze user interactions with various systems.
- Identify and map all relevant pathways (including variations) and automatically documents the most common workflow.
- Compare the potential ROI from automating these processes and enables Business Analysts to accelerate automation and maximize RPA ROI.
- Convert automation opportunities into bot prototypes using the Process Definition Document (PDD) for further development and deployment by the Automation Developer.

Process Discovery is part of the Automation 360 platform. To learn more, see [Automation 360](#)

### Process Discovery Sensor application

The Process Discovery Sensor is installed on end-users' machines to capture data on user activities. This data is sent to Process Discovery for analysis to determine what business processes are candidates for automation.

Privacy Enhanced Gateway

The Privacy Enhanced Gateway (PEG) redacts sensitive data collected by the Process Discovery Sensor application, which prevents Personally Identifiable Information (PII) from being included in the data sent to Process Discovery for analysis.

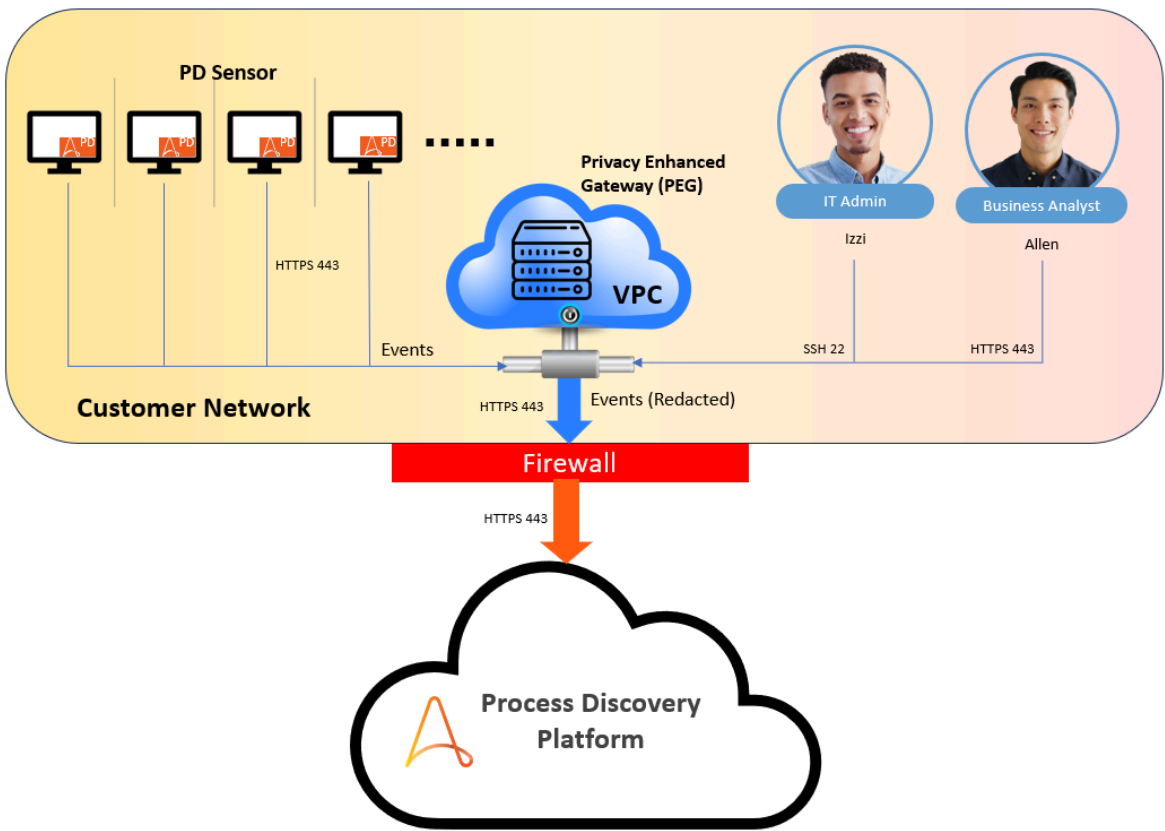

Companies often start automation projects by manually observing and documenting processes. This involves interviewing users, mapping workflows, and can be time-consuming and prone to inaccuracies. Process Discovery uses visualization tools to identify automation opportunities and compare processes across regions or teams.

**Workflow**

The following diagram shows the Process Discovery workflow for Process Discovery Admin, IT Infrastructure Admin, and Business Analyst users:



## Process Discovery workflow

(Click the links to navigate to the sections.)

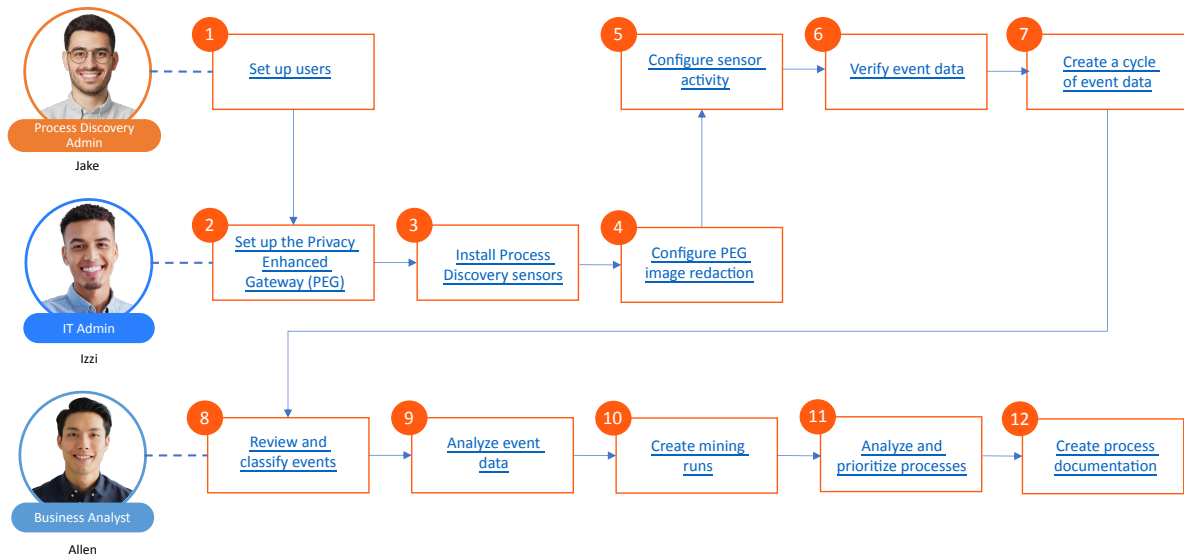

The Process Discovery helps Power/Discovery users find automation candidates by:

- Capturing and analyzing user interactions with systems.
- Documents common Workflows and provides visualizations (Flow and Path graphs)
- Comparing the ROI for potential automation.

## Overview of Process Discovery

Process Discovery enables organizations to accelerate the automation of business processes and discover the fastest path to process optimization and business ROI (return on investment). You can use Process Discovery in various industries such as: healthcare, life sciences, and finance.

### Why use Process Discovery

Many companies begin their automation projects with manual observation and documentation. Manual production and review of process documentation requires interviewing business users and mapping work flows while they are performing daily operations. This involves additional resources which can be time-consuming for all involved. This additional effort is also subject to inaccuracies due to users behaving differently while being monitored. As a result, many of the automation opportunities remain undiscovered. Process Discovery uses visualization tools to view process details and metadata, and review identical processes that differ across regions, teams, or apps.

### Process Discovery Platform capabilities

The Process Discovery application enables Power or Discovery users to identify the business processes that are candidates for automation. Use Process Discovery to do the following:

- Capture, parse, and analyze user interactions with various systems.

- Identify and map all relevant pathways (including variations) and automatically documents the most common workflow.
- Compare the potential ROI from automating these processes and enables Business Analysts to accelerate automation and maximize RPA ROI.
- Convert automation opportunities into bot prototypes using the Process Definition Document (PDD) for further development and deployment by the Automation Developer.

## Process Discovery user roles

Learn about the various users in the Process Discovery platform and their privileges from creating mining runs and exploring processes, to creating web applications and creating a Process Definition Document (PDD).

The Process Discovery platform includes the following user types:

Limited user

A Limited user has access to only the Client Dashboard by default, and view-only access to select assets attached to that tenant's Client Dashboard by a higher-privileged user.

Data Review user

Selects and reviews data for all observers in the Process Discovery platform. The data reviewer user has access only to the **Review** tab and **Data Review** page.

The Data Review role grants a user access to only the Virtual Interviewer flow.

---

**Note:** Discovery and Power Users can access Virtual Interviewer via the URL, but there is no direct link from the main navigation. While a Virtual Interviewer user has access to only the Virtual Interviewer interface, they can currently select and see the data for any and all observer names on the tenant.

---

Discovery user

The Discovery user is designed for anyone who wants to create Mining Runs and Processes or explore the work of others. Restricts access to features around signature creation that could have impacts on other users data and processes if misused. They do not have access to the Cycle page but can be given access to specific cycles by a higher-privileged user. They can look through the events, mining runs, or processes generated for those specific cycles. For instance, a Discovery user from a IT team has access to only IT team cycles and cannot view Accounts team cycles.

Power user

The Power user is an expansion of the Discovery user, granting access to those non-

admin interfaces that the discovery user lacks. They can do everything in the application, from creating Mining Runs and exploring processes to managing application signatures and creating Web Applications. The power user does not have administrator privileges.

Administrator

The Administrator role is the same as previous - it can do everything a power user can, plus all the additional administration screens related to management of the tenant, cycles, users, observers, and integration/plugins.

## Create Process Discovery users and assign roles

As an Administrator user, you can create users and assign roles in the Process Discovery platform.

1. Log in to your Process Discovery platform as an administrator.
2. Click your account initials in the upper-right corner and select **Manage Users**.
3. Click **Create User**.  
The **Create New User** window appears.
4. Enter the first name of the user in the **FIRST NAME** field.
5. Enter the last name of the user in the **LAST NAME** field.
6. Enter the email address of the user in the **EMAIL** field.  
This is also the unique user ID for the user.
7. In the **ROLE** field, click the drop-down to select a Process Discovery role for the user. For more information on Process Discovery role, see [Process Discovery user roles](#) on page 3818.
8. To select an avatar for the user, click **Choose Image file**.
9. Navigate to an image on your computer and click **Open** to select the image.
10. Click **Create User**.  
Process Discovery automatically generates and sends an email inviting the user to log in and use the platform.

---

**Note:** If the user does not activate the account within 24 hours of receiving the email invitation, click the **Didn't receive confirmation instructions** link on the login page to resend the confirmation email. Enter the email address in the field provided and click **resend confirmation instructions**.

---

11. To reset a user password for a fully registered user, click **Actions** > **Force Password Reset**.
12. Click **Yes** to reset the user password.  
A message appears notifying you that the user will have to change their password on the next login attempt.

Related concepts

[Integrate SAML with SSO for Process Discovery](#) on page 3820

With SSO enabled, users can securely sign in to Process Discovery with the same credentials used in other applications such as Microsoft 365 Outlook or Microsoft 365. Users are no longer

required to create separate credentials to access Process Discovery and customer administrators can manage employee access control to Process Discovery as needed.

## Integrate SAML with SSO for Process Discovery

With SSO enabled, users can securely sign in to Process Discovery with the same credentials used in other applications such as Microsoft 365 Outlook or Microsoft 365. Users are no longer required to create separate credentials to access Process Discovery and customer administrators can manage employee access control to Process Discovery as needed.

Single sign-on (SSO) with the Security Assertion Markup Language (SAML) v2.0 protocol requires the identity provider and the application or service provider (Process Discovery) to exchange authentication credentials with each other.

### SAML integration overview

Use SAML v2.0 protocol to enable single sign-on in your Process Discovery tenant with your corporate identity provider.

These are prerequisites to enable SAML configuration in Process Discovery:

- Set up SAML in Process Discovery and the identity the provider at the same time.
- Refer to the identity provider's documentation for instructions on adding a SAML application, such as Process Discovery.
- Ensure you add users in your directory in the source identity provider. Typically, a user directory should exist for your organization.

### Required user details

Users must provide the following details to facilitate the SSO integration with your Process Discovery tenant:

- Process Discovery tenant URL: URL used by customers to log into and access Process Discovery.
- Process Discovery Admin account: email address of a Process Discovery admin that would be used for the SAML admin as well.
- IDP Issuer: issuer URI from the IdP.
- IDP Certificate (X.509 certificate): file representing the IDP certificate.
- IDP Single Sign-On URL: sign-on URL from the IdP.
- IDP Metadata URL: location of the IdP's metadata for automatic renewal of the signing certificate.
- Required Process Discovery issuer as per request: the following will be added `https://saml.fiq-process-intelligence.com/`

After customer IdP SSO integration is created within Process Discovery, the following Service Provider (SP) details can be provided on request:

- Single sign-on URL
- Recipient URL
- Destination URL

- Audience restriction
- Default relay state

## Integration details

Once a customer tenant is successfully configured with SAML integration here are some important details to note:

- This configuration will provide SSO integration via SAML for the Process Discovery web app. However, this does not include integration into Privacy Enhanced Gateway (PEG).
- Any users created prior to the transition to SAML will need to be transitioned to SAML-enabled users. Customers are required to provide a list of these users when requesting for SAML integration.
- All new user accounts will be automatically created with SAML integration.
- Process Discovery does not support multiple IdPs per tenant.
- Individual accounts can be reverted to traditional login accounts, which are non SAML enabled. The customer would need to create a support ticket with this request to start this process. The ticket must include these details:
  - Process Discovery tenant URL
  - List of user emails that should be reverted back to non-SAML logins.

## FAQs

Following are FAQs for some common queries related to this topic:

What is SAML?	Security Assertion Markup Language (SAML) is an open standard for exchanging identity authentication data between an identity provider and an application or service provider such as Process Discovery.
What is SSO?	Single sign-on (SSO) is an identity authentication system that allows users to access multiple applications by using one set of credentials.
What are the three main entities involved in single sign-on?	Application or service provider: The application or service provider we want to enable with single sign-on. In this use case, our application or service provider is Process Discovery. Identity Provider (IdP): An identity provider authenticates and manages the identities of users. Process Discovery supports all IdPs that support standard implementations of the SAML v2.0 specification. A user: A person whose credentials are authenticated in the identity provider. The account credentials include an email address with a domain used in both the

	application and identity provider. For example, <a href="mailto:user.name@automationanywhere.com">user.name@automationanywhere.com</a> .
Which identity claims does Process Discovery require from the IdP?	First name Last name Email
Does Process Discovery support Single Log Out (SLO)?	SLO is not supported. We only support SP-initiated SSO.

## Create your event reporting password

As an Administrator user, you can create your own password for the Event Reporting interface.

The Event Reporting interface uses Kibana which provides you reports about how people interact with applications and screens. Using the reports, you can determine where to focus your process discovery.

1. To create your Event reporting password, log in to your Process Discovery platform tenant.
2. Click your account initials in the upper-right corner and select **Manage Users**
3. Locate your account details in the users list.

---

**Tip:** To quickly locate your account, click **Filter**. Enter your email address, select a role, and click **Apply**.

---

4. In the Actions column, click the drop-down arrow and select **Set Event Reporting Password**. The Set Event Reporting Password window displays.
5. Enter your password and click **Set Password**.  
The password is ready to use the next time you log in.

## Create a URL and application list

Learn how to create a domain list (containing the URL) and application list for data that you want to capture or exclude on an Observers machine.

This task is performed by an Administrator. Before you configure Observer activity for data collection, you create domain list and application list.

To create a domain list, perform the following steps:

1. Log in to your Process Discovery platform as an administrator.
2. Click your account initials in the upper-right corner and select **Domain List**.
3. Click **Create List**.
4. In the **Name** field, enter a name for the list.  
For example, enter Business applications.
5. In the **Type** field, select **Allow** to capture URLs or **Block** to exclude the URLs.

---

**Note:** The blocked URLs will not be displayed in the screen shots from the Events page.

---

6. In the **Domain** field, enter the full URL address.

For example, enter [www.servicenow.com](http://www.servicenow.com), [www.sap.com](http://www.sap.com), or [www.oraclefinancials.com](http://www.oraclefinancials.com).

---

**Note:** When specifying domains, you must explicitly indicate what domains to include or exclude. For example, if [chase.com](http://chase.com) is blocked, the [secure05c.chase.com](http://secure05c.chase.com) would not be blocked. You must include [secure05c.chase.com](http://secure05c.chase.com) on the list.

---

7. Click **Add** to add the specified domain to the list.
8. Click **Create List**.

You can now select this Block or Allow URL list from the **Observers** page for data you want to capture or exclude, for an individual observer or group observers, based on your requirements.

To create an application list, perform the following steps:

1. Click your account initials in the upper-right corner and select **Application List**.
2. Log in to your Process Discovery platform as an administrator.
3. Click **Create List**.
4. In the **Name** field, enter a name for the list.  
For example, enter Business applications.
5. In the **Type** field, select **Allow** or **Block** from the drop-down.
6. In the **Application** field, select an application from the drop-down or enter an application in the text field.
7. Click **Add** to add the application to the list.
8. Click **Create List**.

You can now select this Block or Allow Application list from the **Observers** page for data you want to capture or exclude, for an individual observer or group observers, based on your requirements.

---

**Note:** To create a default Block and Allow URL or Application list for all new observers in a tenant, click your account initials in the upper-right corner and select **Manage Account**. In the Observer Settings section, update the URL or Application Block and Allow List.

---

## Configure Observer activity

As an administrator, you can configure an individual Observer or a group of Observers to capture or exclude specific sets of data from collection on an Observers machine. This topic describes how to enable or disable the capture settings (screenshots, keystrokes, title, and keyboard) and apply this to specific applications.

After the Process Discovery Sensor is installed on the Observers' machines, ensure that you:

- Enable the sensor recording. For more information on enabling or disabling the recording, refer to [Enable and disable the users recording](#) on page 3884.
- Create your domain and application list. For more information, see [Create a URL and application list](#) on page 3822.

**Note:** To enable or disable the recordings for new observers in a tenant, click your account initials in the upper-right corner and select **Manage Account**. In the New Observer Recording section, select **Enable** or **Disable** to set the recording configuration for all new observers. Click **Save** to save your changes.

To configure an individual observer or group configure observers for data collection with capture settings, perform the following steps:

1. Log in to your Process Discovery platform as an administrator.
2. Navigate to **Data > Observers**.
3. To configure all observers, select **Configure <number> Observers**.  
This configuration is for all observers using the current filter. You can create filters for specific departments in your organization (for example, HR or Finance) to filter data collection for a subset of Observers. Click **Filters** to create filters.
4. To configure an individual observer, navigate to the **Actions** column for the Observer and select **Configure** from the drop-down arrow.
5. In the Capture section, use the individual toggles to capture or exclude screenshots, keystrokes, title, or clipboard globally for all applications.
6. In the URL Block and Allow List section, select one of the these options:

Option	Action
None	No action to select. All URLs are captured by the Process Discovery Sensor.
Allow	Select the <b>Allow</b> URL list you created from the Domain List page from the drop-down field.
Block	Select the <b>Block</b> URL list you created from the Domain List page from the drop-down field.

7. In the Application Block and Allow List section, select one of the these options:

Option	Action
None	No action to select. All URLs are captured by the Process Discovery Sensor.
Allow	Select the <b>Allow</b> Application list you created from the Application List page from the drop-down field.
Block	Select the <b>Block</b> URL list you created from the Application List page from the drop-down field.

8. In the **Configure Applications** window, enter specific applications in the text field you want to capture and click **Add**.

Based on your business needs and the applications you set to capture or exclude, you might need to capture Screenshots and Titles for data processing of screen signatures.

The application is listed in the Application Name column.

9. To disable capture settings for the application, select the icon for Screenshots, Keystrokes, or Titles.  
An X mark appears on the icon.



10. To configure observers by a single user, or group of observers with the same user name, select **Use configuration for observers owned by this user (<user name>)**.

This option is available for an individual observer only.

---

**Note:** When you use this option, the allow and block list that is created for new observers is used for users with the same user name.

---

11. Click **Configure**.  
The capture settings are now set for Observers.
12. To enable the capture settings for all observers by default, click your account initials in the upper-right corner and select **Manage Account**.
13. In the Observer Settings section, perform steps 5 through 7.
14. Click **Save** to save your changes.

## Use Process Discovery with Kibana dashboard

The Process Discovery Kibana dashboard (elastic) is used in the pre-mining determinations to understand the process data with Kibana's intuitive and customizable visualizations. You can analyze your Process Discovery tenant data with Kibana.

---

**Important:** Kibana and Elastic mark and logo are trademarks or registered trademarks of Elastic NV and are used for identification purposes only.

---

Use Process Discovery with the Kibana dashboard to analyze, manage, and visualize your process data in the form of charts, gauges, maps, graphs and more. The dashboard helps you analyze the process data and identify relevant processes for tracking in Process Discovery. You can then define your mining runs based on your findings.

This dashboard can be used by administrators, data analysts, and business users to discover insights into their data, visualize the data on dashboards, and share findings to influence automation decisions. Your data can be text, numerical data, time series data, geospatial data, logs, metrics, security events, and more. You can uncover patterns and relationships and visualize the results.

The Process Discovery Kibana dashboard provides three dashboards, such as Activity, Events, and User for all Process Discovery tenants to help you define process mining before passing the data for mining to the Process Discovery platform. The data is synchronized between your tenant and the Kibana dashboard. Watch the following video to use elastic to gain insights into your mining runs and processes.

---

**Note:** The examples and graphics provided on this page are for representation purposes only and may not accurately reflect your specific instance. We do not assume responsibility for their maintenance or accuracy.

---

The following image shows a Process Discovery Kibana **Events**

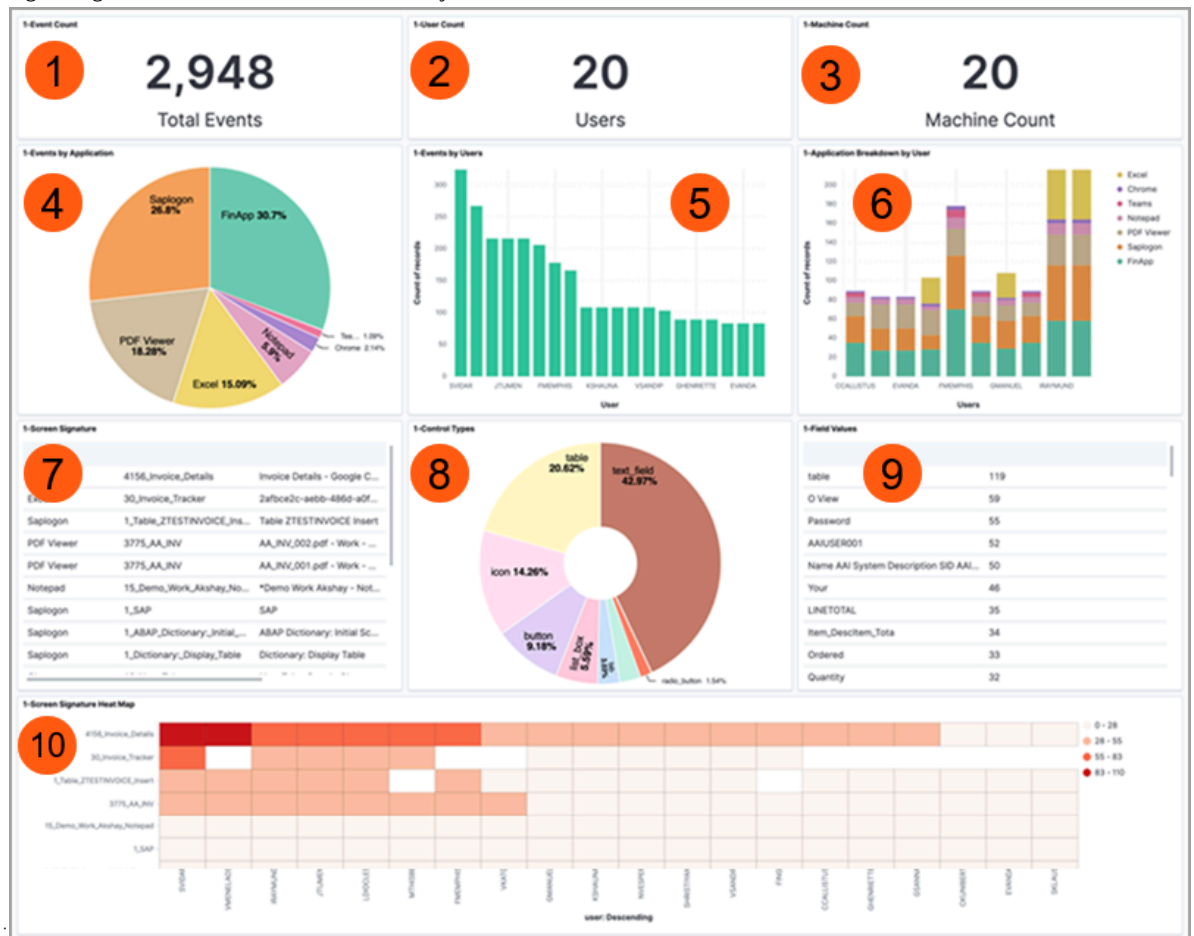

dashboard:

	Description
1	The <b>Events Count</b> widget displays the total count of events collected by the observers.
2	The <b>User Count</b> widget displays the number of users.
3	The <b>Machine Count</b> widget displays the total number of machines used by the observers.
4	The <b>Events by Application</b> pie chart displays the distribution of applications accessed by the observers, revealing the most commonly used application, such as BillrMD.
5	The <b>Application Breakdown by User</b> bar graph displays the applications accessed by each user, allowing you to identify the common application among all observers.
6	The <b>Events by Users</b> exhibit the number of events captured by each user account.
7	The <b>Screen Signature</b> table displays the most common screen signatures.

	Description
8	The <b>Control Types</b> displays the percentage of interactions by types that the observers are performing. From the Pie chart, you notice that 23.34% of the observer's time is spent working in a table, and 19.02% is spent clicking buttons.
9	The <b>Field Values</b> table displays the percentage of interactions by field value as performed by the observers. From the table you can understand that the observers spent most of the time in a table, adding charges, and clicking the save button.
10	The <b>Screen Signature Heat Map</b> lets you determine the most common screen signature. From the chart, you can understand that 2433_Charge_ChargePosting_Posting is the common screen signature among all observers/users.

Kibana is a powerful tool that can be used to prepare data for creating mining runs in Process Discovery. By using Kibana to clean, analyze, and visualize the data, businesses can improve the accuracy and efficiency of their process mining efforts.

## Access the Kibana dashboard

You can access the Kibana dashboard to identify the screens or applications that observers most frequently access and also determine the observer's actions such as clicking buttons, savings forms and areas where they are spending the most time.

---

**Important:** Kibana and Elastic mark and logo are trademarks or registered trademarks of Elastic NV and are used for identification purposes only.

---

**Note:** The examples and graphics provided on this page are for representation purposes only and may not accurately reflect your specific instance. We do not assume responsibility for their maintenance or accuracy.

---

1. Launch the browser and go to your Kibana dashboard. If you do not have a URL to access the dashboard, contact you Automation Anywhere Customer Success Manager (CSM) to get an URL to access the Kibana dashboard.

2. Click **Log in with**

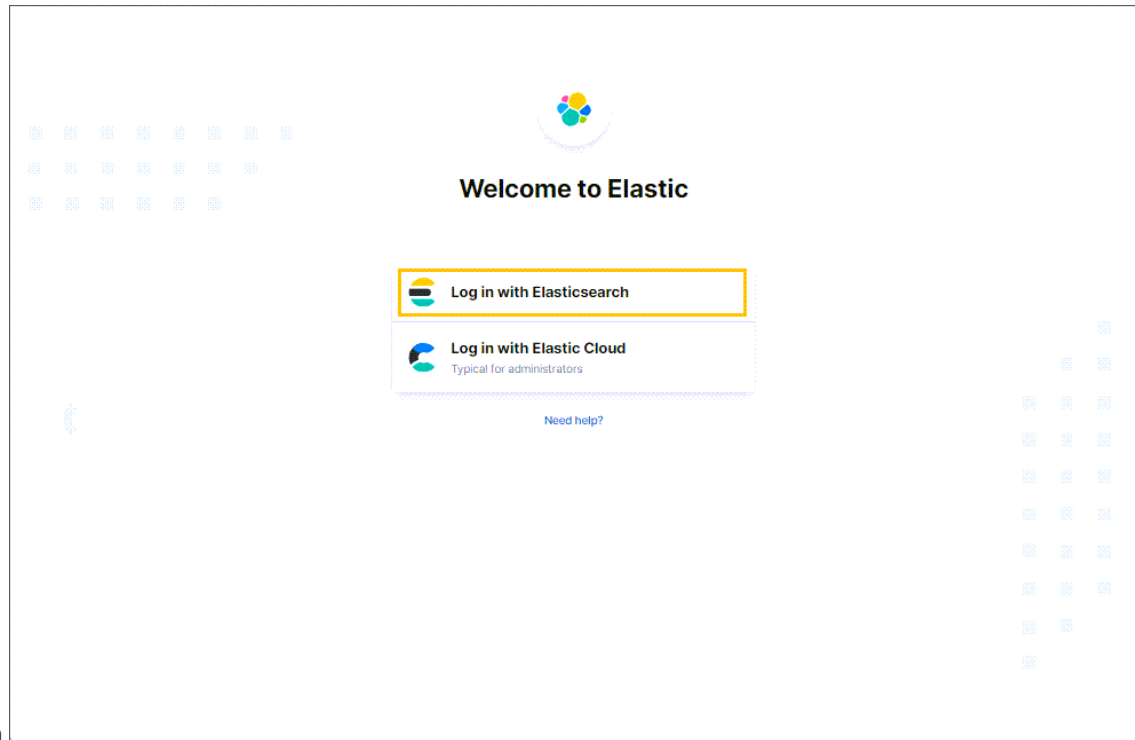

Elasticsearch.

3. Enter the Username and password.
4. Click **Log in** to load the Elastic homepage.  
Elastic displays the three Kibana dashboards Activity, Events, and User assigned to your ID. You can click to select any of these dashboards to explore the observer events which provides a comprehensive and interactive view of your

data.

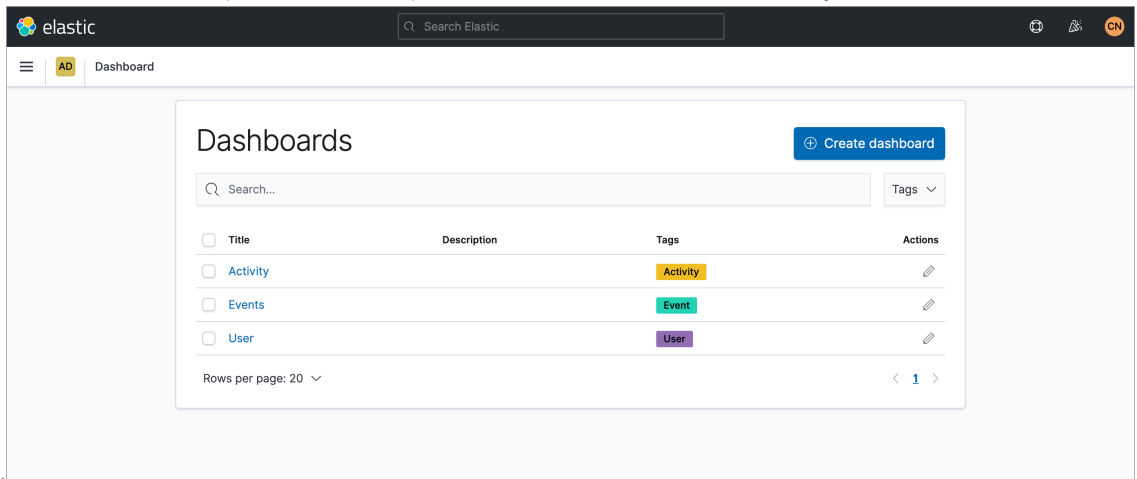

## Create a cycle

Learn how to create a cycle for each data collection and add permitted users to the cycle so they can access the associated events for data analysis. Cycles are defined as a collection of events based on a set of Observers during a given time range.

Administrators have access to all event data, and can define which Permitted Users (Data Review, Discovery, or Power user roles) can access the cycle data in the Process Discovery platform. The Administrator informs users when the cycle is ready for them to review. Power users and all other non-admin users do not have access to create their own cycles and cannot review data until the Administrator creates the cycle for them. Creating a cycle for Power and all other non-admin users allows the users to access the data to review events and mine for processes.

To create a cycle, perform the following steps:

1. Log in to your Process Discovery platform as an administrator.
2. Navigate to **Data > Cycle**.
3. Click **New Cycle**.
4. In the **CYCLE NAME** field, enter a name for the cycle.  
For example: Cycle 1: Order Entry and Processing.
5. In the **PERMITTED USERS** field, select the users that you want to give access to.  
Permitted users include only the Data Review, Discovery, or Power user roles. You do not need to add Admins as permitted users because Admins can access all event data.
6. In the **OBSERVED AT** field, select the time data range from the Start date to the End date for the set of Observers.
7. In the **OBSERVERS** section, you can multi-select Observers or Observer Users from the drop-down lists. Alternatively, you can select a tag from the Observer tag drop-down list to populate the Observers.  
You can create Observer tags from the Observers page and can use them to identify a team for a cycle. For example, the team is payroll or recruiting in HR where you can select as many Observers as required. In a VDI environment, we recommend that you select Observers from the OBSERVER USER section. This option enables you to easily select from hundreds of Observers and customize based on the cycle you want to create.
8. (Optional) APPLICATION NAMES, click the drop-down list to select applications.
9. (Optional) In the START SIGNATURES, click the drop-down list to select a start signature.
10. (Optional) In the END SIGNATURES, click the drop-down list to select an end signature.
11. (Optional) In NOTES, enter any notes you want to share with the permitted users.
12. Click **Create Cycle**.

## Classify application screens and create web applications

You can review unclaimed browser events such as Google Chrome, Internet Explorer, and so on, to assign them to a specific web application.

When using web applications from the Process Discovery platform, the browser name is captured but the web application or software as a service (SaaS) is not. Web application events (where the application name is not captured) are stored in the Unclaimed Browser Events section of the Web

Applications page. To classify web application events that are related to the task or process, you must create specific web applications for the events to be claimed in the application. From the Web Applications page, you can:

- Review events in the Unclaimed Browser Events section to locate and filter related process events from their native browser applications. Typically, Google Search, personal searches, or web mail events are not relevant to a task or process.
- Create specific web applications that are used in the task or overall process flow, for example: Amazon Web Services, Slack, Zendesk, and so on.

To review events in the Unclaimed Browser Events section and create web applications, perform the following steps:

1. Log in to your Process Discovery platform as a power user.
2. Navigate to **Data > Web Applications**.  
In the Existing Rules section, you will see previously created web applications. In the Unclaimed Browser Events column, you will see various browser application events.
3. In the Unclaimed Browser Events column, click:
  - **Grouped by: Title** to organize the browser events listed in the column by window title.
  - **Grouped by: URL** to organize the events by URL.
4. To filter events in the column, use the data range option under the Unclaimed Browser Events header. Select the start date (Month/Date/Year) and end date (Month/Date/Year). The events column will update and display your results.  
To filter events by specific event tiles, use the search icon. Enter the title in the search field. The events column will update to display your results.
5. To view a browser event, click the link to view the set of events from the Events page.  
The browser events with the highest frequency titles or URLs are displayed at the top of the column. These are the most important events for processes that users are recording.

WINDOW TITLE	EVENTS
New Tab - Google Chrome	82
Prostate cancer lcd10 - Google Search - Google Chrome	9
university radiology npi number - Google Search - Google Chrome	6

Showing 1 - 3 of 3 results

6. From the Events page, verify what web application the events belongs to.

**Tip:** We recommend that you note the web titles or URLs as you review the events because you will create a web rule pattern (regular expression or regex) for each of the targeted web applications. Additionally, you can use the Filter option to locate specific web applications by Observer Name (for example) and click through the events in their workflow. Based on your situation, you might filter on URLs because URLs are unique, whereas titles are not necessarily unique. For example, if you have two applications with HOME as the title, you should use a URL web based rule instead of the title.

7. From the Unclaimed Browser Events column, continue to review the set of browser events from the Events page and determine if the events need to be claimed as web application events.
8. After you have located the titles or URL that you need to create web applications, navigate back to the Web Applications page.

9. Click **Create Web Application**.
10. In the **APPLICATION NAME** field, enter the name of the application.  
For example, enter Google Search ICD 10 Lookup.
11. In the APPLIED RULE TYPE section, select the rule type (Title or URL) to use.  
For example, select Title.
12. In the RULE PATTERN (REGEX) section, enter a pattern that matches the title or URL of your target application in the text box.  
For example, enter icd10 lookup in the text box. We recommend that you remove "Google Search" from the application name because there may be similar events (icd10 lookup) in other browsers that you can also include in the rule pattern.  
You can also click the copy icon to copy the title of the web application and paste into the text box.

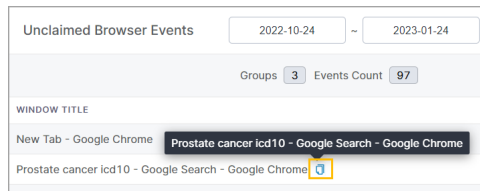

For example, you only need the title, KTBSonline and there are two KTBSonline titles listed in the browser events column. The two titles are:

- Verify Login Information | KTBSonline - Google Chrome
- Enroll in Open Enrollment Benefits | KTBSonline - Google Chrome

To capture the events from both titles, you can enter the rule pattern as: Verify Login Information \| KTBSonline - Google Chrome|Enroll in Open Enrollment Benefits \| KTBSonline - Google Chrome, or you can just enter KTBSonline and keep the rule pattern simple.

Continuing with the example for KTBSonline, the backslash (\) character precedes the vertical (|) character to indicate that this is not an OR function in the rule.

To include more than one title in the rule pattern, use the vertical bar (|) character to indicate the OR function. For example, to include results for PDFfiller OR pdfFiller, enter the rule pattern as: PDFfiller|pdfFiller.

The caret (^) character is another commonly used character for creating web rules. Use the caret character at the beginning of the rule pattern when you want to match the exact event title at beginning of the text. For example, you want events only where KTBSonline is at the beginning of the text in the application. In the text box, enter the rule pattern as: ^KTBSonline.

13. Click **Create**.  
The system takes a few minutes to create the web application. To verify that the rule is updated, click the magnifying glass icon in the Actions column. After the web application has completed, a pop-up notification appears in the bottom left corner.

## Applications with auto-assigned screen signatures

Process Discovery automatically assigns a screen signature to the following productivity tools. A screen signature is a descriptive name that identifies a page within an application, such as a spreadsheet in a workbook.

- Adobe Acrobat Reader
- Calculator

- Foxit PDF Reader
- Google Chrome
- Microsoft Access
- Microsoft Excel
- Microsoft InfoPath
- Microsoft Internet Explorer
- Microsoft OneNote
- Microsoft Outlook
- Microsoft Power BI
- Microsoft PowerPoint
- Microsoft SharePoint
- Microsoft Teams
- Microsoft Terminal Services Client
- Notepad
- SAP Logon
- Snipping Tool
- 1cv8

## Review Events and filter data

You can review and filter Events collected from the Observers machine to develop mining insights.

We recommend that you collect Observer events for at least two to five weeks to ensure that all processes assigned to Observers are completed before data analysis begins. After a few weeks of collecting Events, you can review the Events. From the Events pages, Power users can:

- Review events to ensure that data is collected from Observers.
- Use the **Filter** option to sort and display events by single or multiple Observers, application, Observed at (date range), and so on.
- Enlarge individual screens to view Observer events (mouse clicks and keystrokes) in detail.

To review and filter Events, perform the following steps:

1. Log in to your Process Discovery platform as a power user.
2. Navigate to **Data > Events**.
3. In the upper left side, click the drop-down to select an Observer.  
By default, all Observers events are displayed on the Events page.  
The events collected by the Observer are displayed in the Events table. The total number of Events collected by the Observer is displayed in the Events text box above the table.
4. Click through the event IDs to view the date range (Observed At), Application, Title, and Field columns.  
Click the gear icon to select additional data to view. The selected data displays a green checkmark. For example, you can select Screen signatures, Application, Field, and so on. The data displays in another column within the Events table.

---

**Note:** In the Events table, the Observed At date and time range is the time that a user is looking at the events in the application. The Observed At date range is not related to the Observers location. For example, if the Observer is in India and the user is looking at the events in the application in California, the Observed At date and time is in California time.

---



For each Event ID, the associated Event screen appears to the right. The following image and table describe the metadata (1-4) details associated with the screen and the icons (5 and 6) used to enlarge the image.

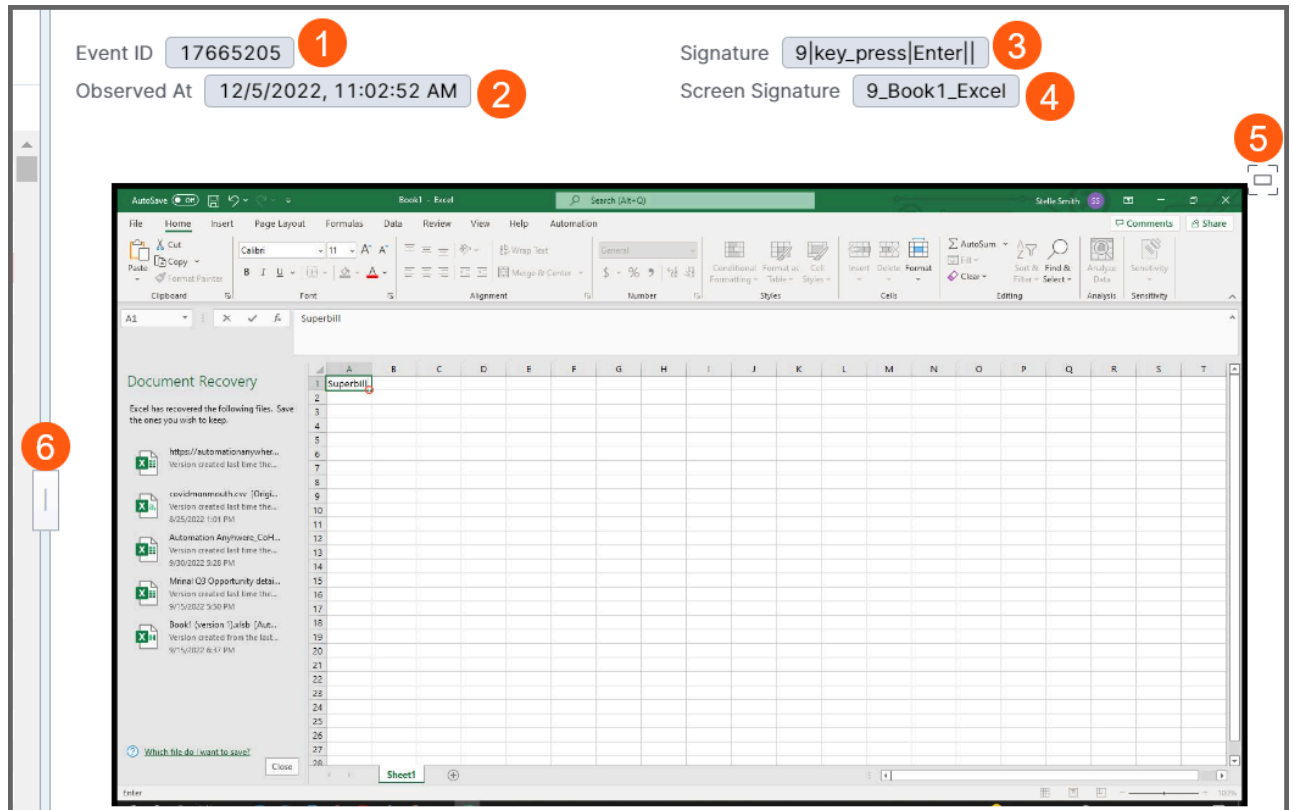

	Metadata	Description
1	Event ID	The ID number associated with the event.
2	Observed At	The exact date (Month/Day/Year) and recording time of the event captured by the Observer.
3	Signature	The application screen associated with that event. Each application has a unique ID.
4	Screen Signature	<p>A unique label pattern applied to an application screen to enable process mining.</p> <hr/> <p><b>Note:</b> Although, Screen signatures are partially automatic, modifications are required for data mining. As long as the Screen Signature is logical, multiple Events may share the same Screen Signature. It is important that Screen Signatures describe the screen appropriately because they enable further process mining.</p> <hr/> <p>When you are ready to modify your Screen Signatures work, we recommend that you work with your Customer Success Manager (CSM).</p>

	Metadata	Description
5	Image Viewer icon	Enlarges the image to full screen mode.
6	Slider	Expands the width of the image.

- Click **Filter** to customize the events you want to view.  
Filtering events allows you to better understand the individual steps as part of the overall process you might optimize. For example, you might refer to the Field column for potential start and end tasks of process.
- To filter events for a cycle, select a cycle from the **Cycles** drop-down and click **Apply**. The Events table is updated and updates events for that cycle.
- To filter events using a set of rules with conditions (AND, OR) or create a group (combination of rules), select from the following options or a combination of options:

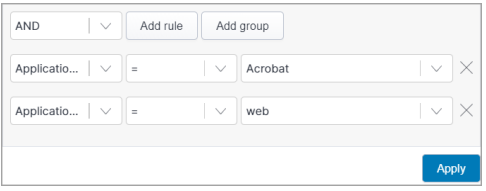
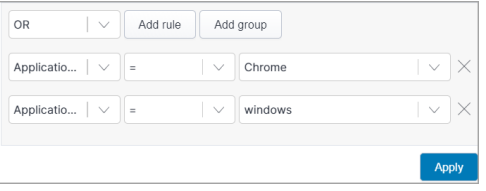
Option	Action
Add Rule	A Rule is single condition. Use this to add additional conditions, such as AND, OR. Refer to the AND,OR examples for more information.
AND	<p>Filter events only which satisfy BOTH conditions will be included.</p> <hr/> <p>For example, the AND operator is selected and you select Application Name = Acrobat and Application Type = web. The filter rules include events from both Acrobat and web.</p> 
OR	<p>Filter events only which satisfy EITHER condition will be included.</p> <p>For example, the OR operator is selected and you select Application Name = Chrome and Application Type = windows. The filter rules will include only events EITHER in Chrome or in windows.</p> 

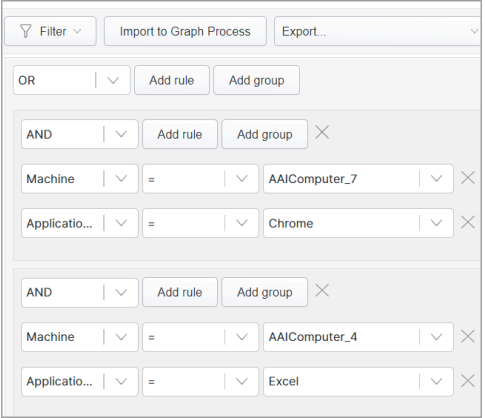
Option	Action
Add group	<p>Use this to filter for a combination of rules. A Group can also be a collection of Groups, or a mix of both.</p> <div data-bbox="472 327 1414 772" style="border: 1px solid black; padding: 10px;"> <p>For example, there is a combination of Groups, each with their own group of Rules, collected by an OR operator. The filter rules will include events that are either (on machine AAIComputer_7 AND in Chrome) OR (on machine AAIComputer_4 AND in Excel).</p>  </div>

Option	Action								
Operators	<p>Select from one of the following operators:</p> <table border="1"> <thead> <tr> <th>Option</th> <th>Result</th> </tr> </thead> <tbody> <tr> <td>=</td> <td>The condition is equal to the input. For example: Application Name=Google. This filter rule will include events where the application is Google only.</td> </tr> <tr> <td>&gt;, &lt;</td> <td>The condition is greater than, or less than those in the input. For example: ID &gt; 1000. This filter rule will include events where the ID is greater than 1000.  <b>Note:</b> This applies only for Observed At and ID conditions. The Observed At filter is the quantity of any event that is recorded in that exact time.</td> </tr> <tr> <td>&gt;=, &lt;=</td> <td>The condition is greater than or equal to, or less than or equal to those in the input.  <b>Note:</b> This applies only for Observed At and ID conditions.</td> </tr> </tbody> </table> <p><b>Note:</b> The examples provided include some of the more commonly used operators. The full list of operators include:</p> <ul style="list-style-type: none"> <li>• In</li> <li>• !=</li> <li>• Not In</li> <li>• Is Null</li> <li>• Is Not Null</li> <li>• Matches</li> </ul>	Option	Result	=	The condition is equal to the input. For example: Application Name=Google. This filter rule will include events where the application is Google only.	>, <	The condition is greater than, or less than those in the input. For example: ID > 1000. This filter rule will include events where the ID is greater than 1000.  <b>Note:</b> This applies only for Observed At and ID conditions. The Observed At filter is the quantity of any event that is recorded in that exact time.	>=, <=	The condition is greater than or equal to, or less than or equal to those in the input.  <b>Note:</b> This applies only for Observed At and ID conditions.
Option	Result								
=	The condition is equal to the input. For example: Application Name=Google. This filter rule will include events where the application is Google only.								
>, <	The condition is greater than, or less than those in the input. For example: ID > 1000. This filter rule will include events where the ID is greater than 1000.  <b>Note:</b> This applies only for Observed At and ID conditions. The Observed At filter is the quantity of any event that is recorded in that exact time.								
>=, <=	The condition is greater than or equal to, or less than or equal to those in the input.  <b>Note:</b> This applies only for Observed At and ID conditions.								

8. Click **Apply** to apply your filter settings and view events.

## Mining for processes

A mining run identifies and analyzes variations in how a business process is performed.

### Determine your mining strategy

Before you create your first mining run, decide on a mining strategy. We suggest the following strategies, however, you should use the strategy that is appropriate for your use case.

- Find the most popular screen in your event reporting interface. You can use the most popular screen as the Center screen. Create a Butterfly Mining Run first using the Center screen Screen

Signature to identify the Start and End Screen Signatures. Next, create a Path-Based Mining Run using the start and end Screen Signatures to identify processes.

For more information, see [Create a Butterfly mining run](#) on page 3845 and [Create a Path-based mining run](#) on page 3843

- Select a single Observer first and delve into their data. Also known as a "day in the life" view, with this strategy, you review the Events for the Observer and identify their processes through mining. Then, mine all Observers together to see which processes they have in common.

For more information, see [Create a Mining Run](#) on page 3837

- Select all Observers and mine all data for processes without using Screen Signatures or parameters. The number of processes generated by the Mining Run might be too many to analyze. This strategy is more appropriate with smaller data sets and a small number of Observers.

For more information, see [Create a Mining Run](#) on page 3837

## Create a Mining Run

Perform exploratory mining to discover processes across an open dataset. You can narrow the results by observer, application, or screen signature. This approach might yield multiple processes, each with different start and end points.

Create a mining run where you can specify time frame, observer, application, and screen signatures.

**Note:** When you run a basic mining run the **Mining Type** (visual output) is a [Flow Graph](#) on page 3839. For Advanced mining runs, the **Mining Type** by default is Flow Graph, but you can select **Path** or **Butterfly**.

1. Navigate to **Data > Mining Runs**.
2. Click **New** and provide the following information:

Field	Description
Observed at	The start and end dates and times for the recorded steps to include in this mining run.
Observers	<p>Select <b>All</b>, <b>Include</b>, or <b>Exclude</b>.</p> <p>If you select <b>Include</b> or <b>Exclude</b>, use the <b>Observers from tag</b> menu to select observers by tag or the <b>Select observers</b> to select observers by device name.</p> <hr/> <p><b>Note:</b> Observer tags are created by an admin and are used to identify a team, such as payroll or recruiting.</p>

Field	Description
Applications	<p>Select <b>All</b>, <b>Include</b>, or <b>Exclude</b>.</p> <p>If you select <b>Include</b> or <b>Exclude</b>, use the <b>Applications from tag</b> menu to select applications by tag or the <b>Select applications</b> to select applications by name.</p> <hr/> <p><b>Note:</b> Application tags are created by an admin and are used to identify a grouping, such as payroll or recruiting.</p> <hr/>
Start screen signature	<p>The screen signature is a descriptive name assigned to each recorded screen. You can view and search for screen signatures from the <b>Data &gt; Events</b> tab.</p>
Stop screen signature	

**3. Click **Create & Run**.**

Process Discovery performs the mining run. The length of time necessary to complete the mining run depends on the size of the data set. When the mining run is complete, it appears in the **Data > Mining Runs** page.

Review the processes identified by the mining run. See [Analyze and prioritize processes](#) on page 3848.

## Flow Graph

The Flow-based mining run produces the visual output for the Flow Graph, which shows each screen signature only once, resulting in a simplified visual. Additionally, the Flow Graph shows loops and common steps in the process.

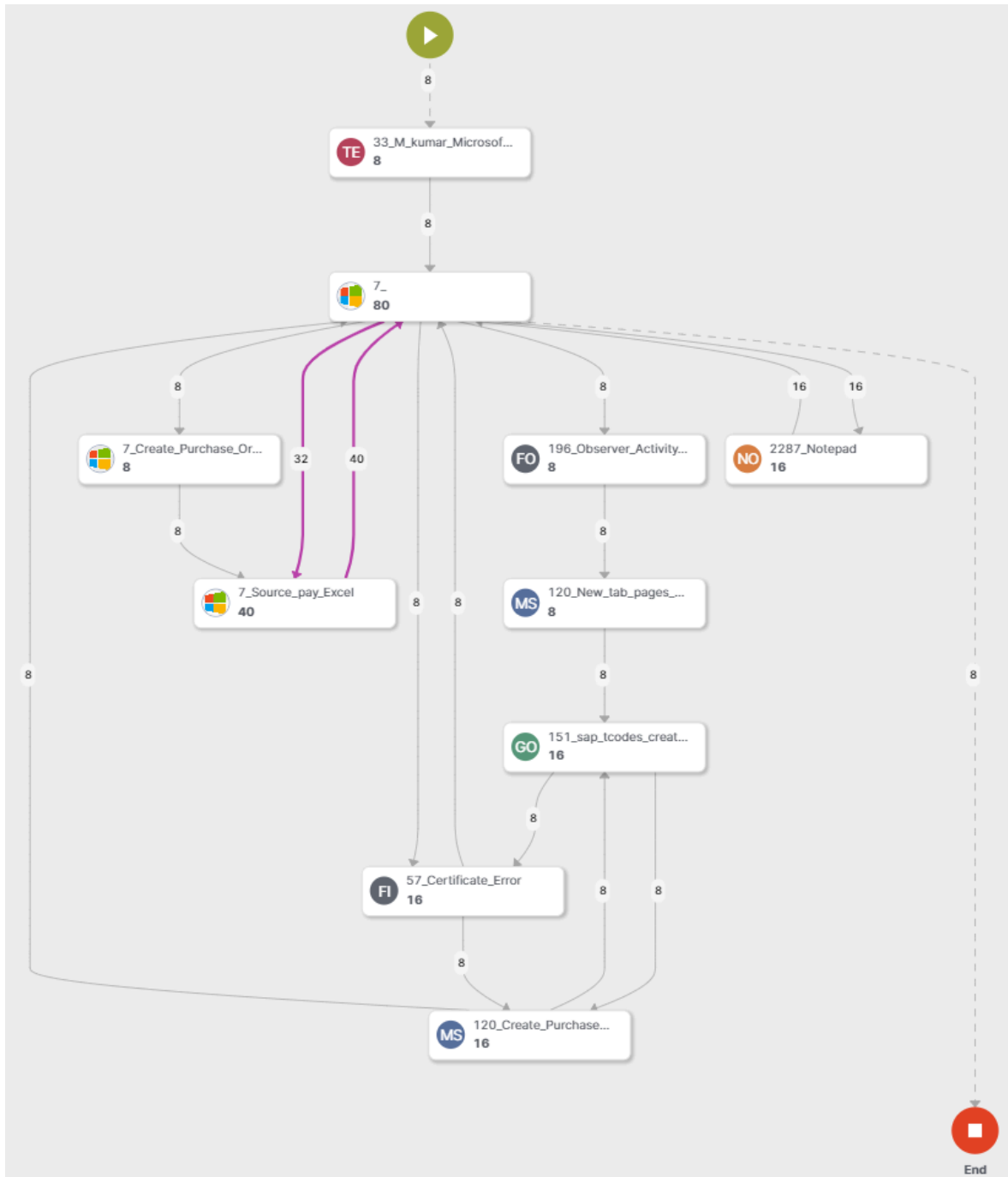

## Create a Flow-based mining run

Create a flow graph to visualize the flow-based mining run resulting in a simplified visual.

[Create a cycle](#) on page 3829

1. Navigate to **Data > Mining Runs**.
2. Click **New**, navigate to the **Advanced** tab, and select the cycle from the drop-down list.
3. Select the **Flow** mining type.
4. Optional: Provide the following information:

Field	Description
Min path length	Set the minimum length for a path to be included in the output.
Max path length	Set the maximum length for a path to be included in the output.
Number of processes	Sets a maximum number of unique starting screens
Number of paths	Sets a maximum number of total paths
Start strategy	<p>If you do not provide a start screen, Process Discovery uses one of the following algorithms to determine potential start screens:</p> <ul style="list-style-type: none"> <li>• <b>Dependency:</b> Uses a statistical model based on the frequency that certain events lead to one-another or to many others</li> <li>• <b>Frequency:</b> Returns the screen signatures appearing most frequently in the event logs for the given filter rules</li> <li>• <b>Interactivity:</b> Uses a ratio of unique appearances of screens to the amount those screens are interacted with to determine good start candidates</li> <li>• <b>Copy Paste:</b> Looks at controls to determine which screens are copied from most frequently</li> </ul>



Field	Description
Path filter	<ul style="list-style-type: none"> <li>• Frequency: Ranks paths by total frequency of occurrence</li> <li>• Levenshtein: Ranks paths based on frequency and similarity to other frequently appearing paths</li> <li>• Dedup: Includes only the first occurrence of a screen in a unique path, then runs the default filtering on the results. For example, if a process flows through these screens [A -&gt; B -&gt; A -&gt; C], it is converted to [A -&gt; B-&gt; C]</li> </ul>
Merge starts (optional)	If there are multiple start screens, Process Discovery combines all those start screens into a single process, instead of creating a process for each start screen
Shortest path (optional)	If the mining run has a defined start and end screen, Process Discovery finds the longest path between a start and an end screen, which might generate a path with repetitions of the start screen. If you select <b>Shortest path</b> , Process Discovery looks for the shortest path between the start and end screens

**5.** Click **Create & Run**.

Process Discovery performs the mining run. The length of time necessary to complete the mining run depends on the size of the data set. When the mining run is complete, it appears in the **Data > Mining Runs** page with the discovered processes below it.

[Using the Flow Graph to find common steps and loops](#) on page 3842

## Export Process as CSV

You can export a process to a CSV file for offline data analysis

To export the process as a CSV:

- 1.** Click **Mining Runs**.
- 2.** Expand the process that contains the Flow Graph you want to export.
- 3.** Do one of the following:
  - a)** Click **Export Process as .csv**.

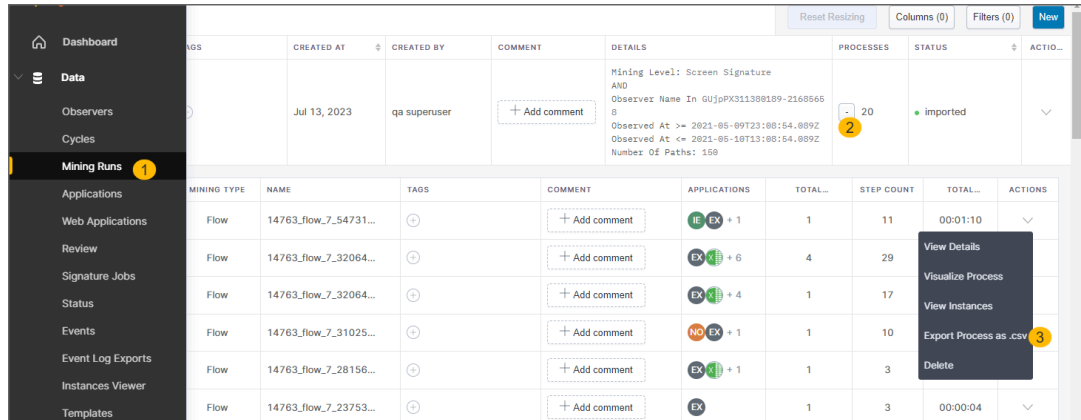

b) Click **Visualize Process > Export process.**

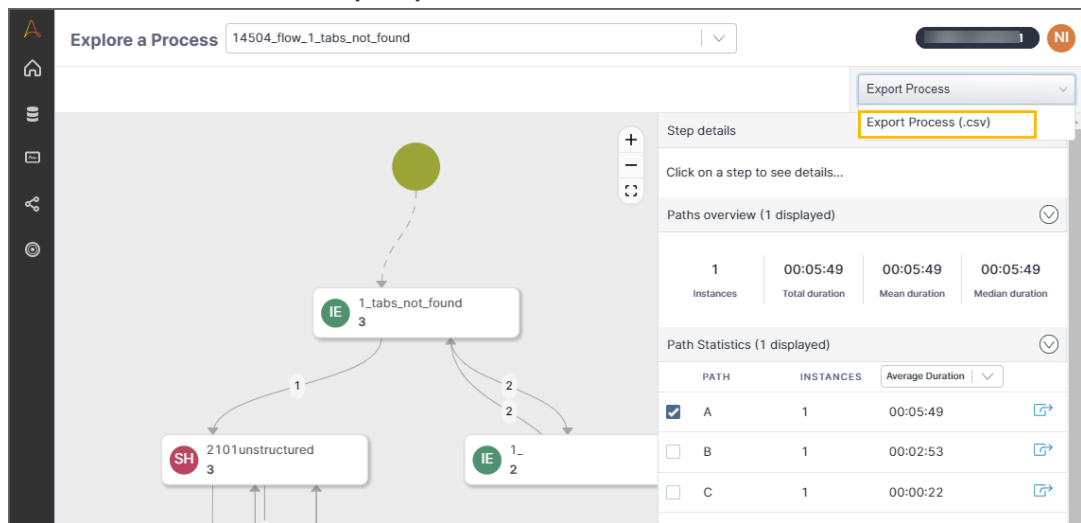

4. Open the CSV file to see the exported data.

## Using the Flow Graph to find common steps and loops

Identify the most common steps in a path or the paths which contain that step, as well as any process loops, where a user returns to a previous screen or application.

Create a flow-based mining run. See [Create a Flow-based mining run](#) on page 3840

After the mining run is completed, the Mining Runs page displays the flow-based mining run with the identified processes.

1. Expand the list of processes for the completed mining run.
2. Under the Actions column, click the downward-pointing arrow then **Visualize Process**.
3. Use the following flow graph visualization features to identify automation or optimization opportunities:
  - Most popular path: The first path in the right-side panel is the path that contains the most commonly-occurring steps. The subsequent paths are organized in descending order of how often the steps occur in the variations of that path.

- Most common steps: A pink line highlights the most common connection between steps. Click on a step that is intersected by a pink line to see all the paths that contain the connection.

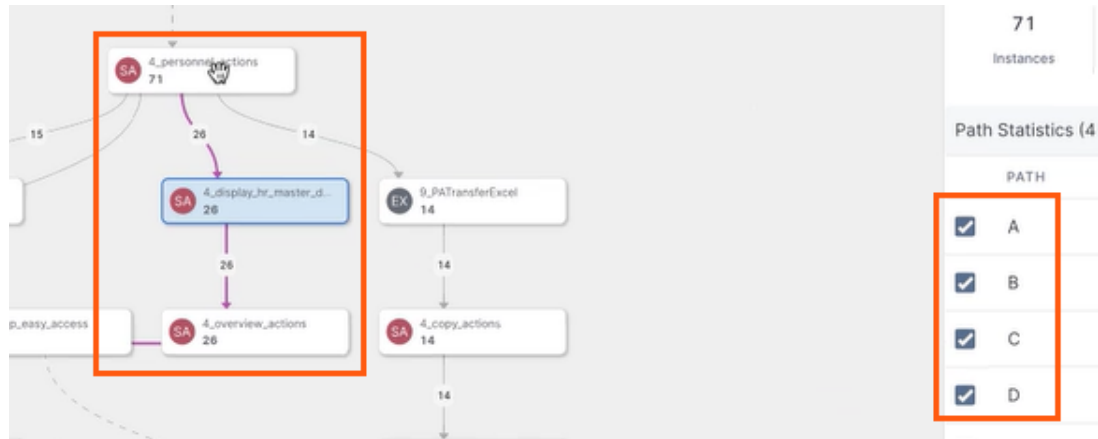

- Process loops: In a process loop, a user returns to a previous application or screen. Look for arrows that point to a previous step, such as in the graphic below.

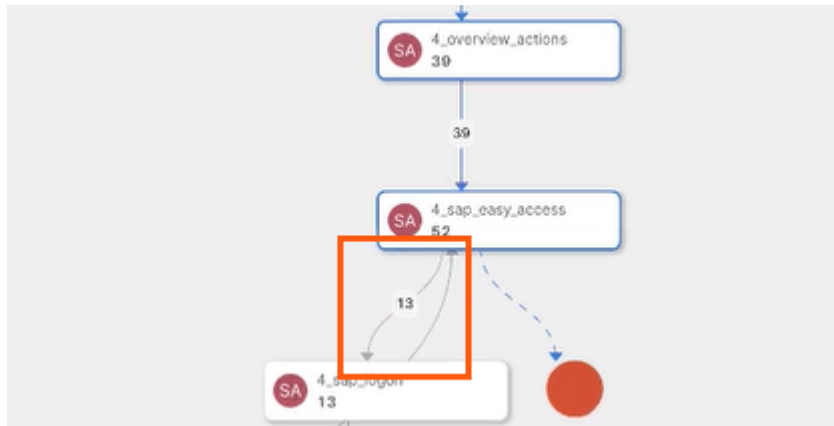

[Analyze and prioritize processes](#) on page 3848

## Create a Path-based mining run

The Path-based mining run type finds patterns in the data and generates processes based on the set parameters.

[Create a cycle](#) on page 3829

1. Navigate to **Data > Mining Runs**.
2. Click **New**, navigate to the **Advanced** tab, and select the cycle from the drop-down list.
3. Select the **Path** mining type.
4. Optional: Provide the following information:

Field	Description
Min path length	Set the minimum length for a path to be included in the output.
Max path length	Set the maximum length for a path to be included in the output.
Number of processes	Sets a maximum number of unique starting screens
Number of paths	Sets a maximum number of total paths
Start strategy	<p>If you do not provide a start screen, Process Discovery uses one of the following algorithms to determine potential start screens:</p> <ul style="list-style-type: none"> <li>• Dependency: Uses a statistical model based on the frequency that certain events lead to one-another or to many others</li> <li>• Frequency: Returns the screen signatures appearing most frequently in the event logs for the given filter rules</li> <li>• Interactivity: Uses a ratio of unique appearances of screens to the amount those screens are interacted with to determine good start candidates</li> <li>• Copy Paste: Looks at controls to determine which screens are copied from most frequently</li> </ul>
Path filter	<ul style="list-style-type: none"> <li>• Frequency: Ranks paths by total frequency of occurrence</li> <li>• Levenshtein: Ranks paths based on frequency and similarity to other frequently appearing paths</li> <li>• Dedup: Includes only the first occurrence of a screen in a unique path, then runs the default filtering on the results. For example, if a process flows through these screens [A -&gt; B -&gt; A -&gt; C], it is converted to [A -&gt; B-&gt; C]</li> </ul>
Merge starts (optional)	If there are multiple start screens, Process Discovery combines all those start screens into a single process, instead of creating a process for each start screen

Field	Description
Shortest path (optional)	If the mining run has a defined start and end screen, Process Discovery finds the longest path between a start and an end screen, which might generate a path with repetitions of the start screen. If you select <b>Shortest path</b> , Process Discovery looks for the shortest path between the start and end screens

5. Click **Create & Run**.

Process Discovery performs the mining run. The length of time necessary to complete the mining run depends on the size of the data set. When the mining run is complete, it appears in the **Data > Mining Runs** page with the discovered processes below it.



Review the processes identified by the mining run. See [Analyze and prioritize processes](#) on page 3848.

## Create a Butterfly mining run

The Butterfly Mining run type shows the flow in and out of a screen. Use this type to identify all the paths that include this screen, as well as the steps before and after that screen.

1. Navigate to **Data > Mining Runs**.
2. Click **New**, navigate to the **Advanced** tab, and provide the following information:

Field	Description
Mining level	Ensure <b>Screen Signature</b> is selected
Mining type	Ensure <b>Butterfly</b> is selected
Filters	Create rules to filter which of the recorded screens to include in this mining run.

Field	Description
Center Screen Signature: Screen signature	Specify a screen that all the paths must include.  The screen signature is a descriptive name assigned to each recorded screen. You can view and search for screen signatures from the <b>Data &gt; Events</b> tab.
Center Screen Signature: Signature label	<b>Field:</b> The name of the field the user interacted with  <b>Control key:</b> The keyboard or mouse control key the user pressed, such as a left click or "Enter"  You can find field and control key data in the <b>Data &gt; Events</b> page.
Must Include Screen Signature (optional)	Include additional screen signatures that the paths must contain
Number of events before center	The number of steps before the center screen to include in the paths
Number of events after center	The number of steps after the center screen to include in the paths
Number of processes	Sets a maximum number of unique starting screens
Number of paths	Sets a maximum number of total paths
Start strategy	If you do not provide a start screen, Process Discovery uses one of the following algorithms to determine potential start screens: <ul style="list-style-type: none"> <li>• <b>Dependency:</b> Uses a statistical model based on the frequency that certain events lead to one-another or to many others</li> <li>• <b>Frequency:</b> Returns the screen signatures appearing most frequently in the event logs for the given filter rules</li> <li>• <b>Interactivity:</b> Uses a ratio of unique appearances of screens to the amount those screens are interacted with to determine good start candidates</li> <li>• <b>Copy Paste:</b> Looks at controls to determine which screens are copied from most frequently</li> </ul>

Field	Description
Path filter	<ul style="list-style-type: none"> <li>• Frequency: Ranks paths by total frequency of occurrence</li> <li>• Levenshtein: Ranks paths based on frequency and similarity to other frequently appearing paths</li> <li>• Dedup: Includes only the first occurrence of a screen in a unique path, then runs the default filtering on the results. For example, if a process flows through these screens [A -&gt; B -&gt; A -&gt; C], it is converted to [A -&gt; B-&gt; C]</li> </ul>

3. Click **Create & Run**.

Process Discovery performs the mining run. The length of time necessary to complete the mining run depends on the size of the data set. The output is a sankey chart, which provides a visual representation of the paths through the selected signature

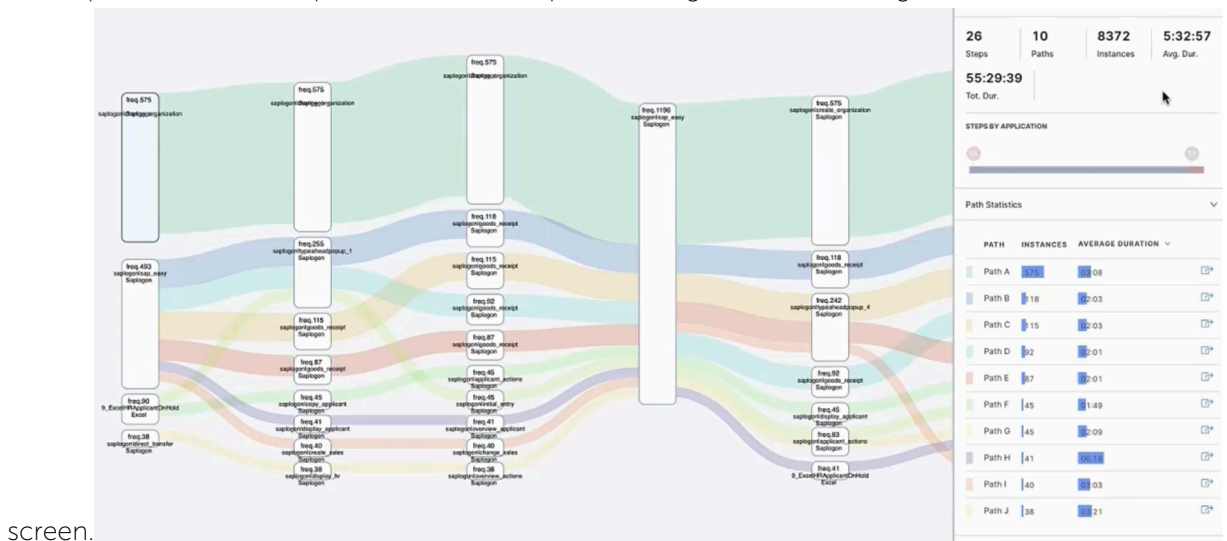

screen.

Review the processes identified by the mining run. See [Analyze and prioritize processes](#) on page 3848.

## Export Mining Runs

You can export a mining run to a CSV file for offline data analysis.

To export a mining run as a CSV:

1. Click **Mining**

The screenshot shows a table of mining runs. The table has the following columns: CREATED AT, CREATED BY, COMMENT, DETAILS, PROCESSES, STATUS, and ACTIONS. The first row shows a mining run created on Jul 16, 2023, with a comment '+ Add comment'. The DETAILS column contains the following text: Mining Level: Screen Signature, End Screen Signatures: 2347\_Invoice\_Details:Submit(Field), AND, Application Name In Excel,FinApp,Saplogon, PDF Viewer, Observer Name In aaicomputer\_3-user\_3,aaicomputer\_6-user\_6,aaicomputer\_12-user\_12,aaicomputer\_10-user\_10,aaicomputer\_13-user\_13,aaicomputer\_15-user\_15,aaicomputer\_4-user\_4,aaicomputer\_9-user\_9,aaicomputer\_17-user\_17,aaicomputer\_5-user\_5,aaicomputer\_16-user\_16,aaicomputer\_7-user\_7,aaicomputer\_20-user\_20,aaicomputer\_1-user\_1,aaicomputer\_14-user\_14,aaicomputer\_11-user\_11,aaicomputer\_18-user\_18,aaicomputer\_2-user\_2,aaicomputer\_19-user\_19,aaicomputer\_8-user\_8. The PROCESSES column shows 3 processes. The STATUS column shows 'import..'. The ACTIONS column has a dropdown menu open with options: Clone, Delete, Export Mining Run as .csv (highlighted), and Explore Events.

2. Click the drop-down in the **ACTIONS** column corresponding to the mining run you want to download.
3. Click **Export Mining Run as .csv**.
4. Open the CSV file to see the exported data.

## Analyze and prioritize processes

Map and compare workflows using data visualization tools. Prioritize processes based on ROI and select a process for automation opportunities.

- Create a mining run from the Mining Runs page: [Mining for processes](#) on page 3836
- From the Process Explorer page, review the various paths taken by the observers, where the thickest path is the most frequent path taken.
- Identify the path you want to view from an event-level.
- Click the **View in Instances Viewer** icon to navigate to the Instances Viewer page where you can select and annotate events to include in a PDD. You can also select a process to annotate directly from the Instances Viewer page.

1. Log in to your Process Discovery platform as a power or discovery user.
2. Navigate to **Data > Instances Viewer**.
3. In the upper-left side next to **View Instances**, click the drop-down to select a process to visualize.



**View Instances** 2812\_flow\_9\_Invoice\_Tracker

Observers: 11 aaicomputer\_20-... Paths: 3 Instance 1 of 60

Order	Title	App	Action	Value	Observer Name
1	2af8ce2c...	Excel	MOUSE_CL...		aaicomputer_20-user_20
2	2af8ce2c...	Excel	MOUSE_CL...		aaicomputer_20-user_20
3	2af8ce2c...	Excel	MOUSE_CL...		aaicomputer_20-user_20
4	SAP logn...	Saplogon	MOUSE_CL...		aaicomputer_20-user_20
5	SAP logn...	Saplogon	MOUSE_CL...		aaicomputer_20-user_20
6	SAP	Saplogon	KEY_PRESS		aaicomputer_20-user_20

INSTANCE	EVENTS
Instance 4 of 60	78
Instance 5 of 60	78
Instance 6 of 60	78
Instance 2 of 60	76
Instance 1 of 60	62

**Note:** Instances are different methods used to navigate through the same path to complete a process. Each instance can share the same screen signatures, but can also contain different signatures depending on the path taken.

- After the process displays on the page, click the drop-down to select the instance to include in the PDD.
- Click the gear icon to add the **Include in Process** column.  
The **Include in Process** column provides you a check box for each line order (refer to the Order column) used to specify which steps to include in the PDD.
- Click **Annotate** to update field labels for the selected steps. For all steps that you want to include in the PDD, leave the box checked and update the action and label from the screen on the right.  
Two fields will appear above the screen image.
- From the drop-down, select a **Control Type**.  
The **Control Type** refers to the selection performed in the application.
- In the text field, enter a control label description for the **Control Type** and click **Update**.  
We recommend that you enter a label description that corresponds with the label in the screenshot so that when users review the PDD, the output makes sense to them.  
For example, select Button from the **Control Type** drop-down and enter Click New Ticket in the description field.  
The **Ann** column will display user and the **Field** column will display the description entered in the text field.
- Repeat steps 6 through 8 for all steps that you want to annotate.  
The **Save Instance to Process** button is enabled for all checked items that include both a label and description. You must annotate all instances you want included in the process for the **Save Instance to Process** button to appear.
- Click **Save Instance to Process**.  
The **View Process Details** button appears.
- Click **View Process Details** to name the process.
- In the **Name** field, enter a name for the process using this suggested format: 5577-21245E Instance 1 for <Mining Run><Process><Path><Instance>.
- Click **Save Process** to save the process with a name.

A message appears at the bottom left side notifying you that the process is saved successfully. Click the hyperlink to return to the **Process Explorer** page. You can now create groups for the events and generate a PDD.

[Creating groups for the process and generate a PDD on page 3850](#)

## Creating groups for the process and generate a PDD

Learn how to create different groups with start and stop events, and use the groups to design a Process Definition Document (PDD).

After you selected your instances, you can create groups for the events and build your PDD.

1. Click **Create Group** to place the steps in different groups for the PDD.

You can create groups for tasks that are part of the process.

2. In the **Create Group** window, drag a step from the process workflow and move it into the **Start Node**.

The Start Node is the beginning of the task. For help building the group of steps as tasks in the overall process, refer to the **View Instances** page for the selected screens. For example, to create tasks related to completing fields on a checkout page, you can

- Group all steps in one group and name the group Checkout; or
- Create multiple groups for individual tasks like Add Payment in one group or add Shipping address in another group.

3. Select the last step in the group and place the screen in the **End Node(s)**.

The End Node(s) is the end of the task.

4. Enter a name in the **Group Name** text box.

5. Select a color for the group from the drop-down next to the **Group Name** text box.

6. Click **Save** to save the group.

7. Repeat steps 2 through 6 for all steps you want to group.

8. Open a new browser tab and navigate to the Process Discovery platform.

9. From the left pane, navigate to **Models > Diagram Composer**.

In the **Browser Processes and Groups** section, the instances and groups are displayed.

10. Click the + sign to add a flow box for each group.

Each flow box appears on top of the previous box. Move these boxes into a row or column. The groups are listed in reverse order from when they were created.

11. To connect one flow box to another flow box, click the > on the side of the flow box and drag the arrow to connect the boxes.

12. To document a process with branches, click the **Decision Point**.

A diamond shape flow box appears in the composer.

13. In the **Details** window, click the pencil symbol to enter a name for the decision point.

14. Repeat steps 10 through 13 until you have completed adding flow boxes for all groups in the PDD.

15. Click **Auto Layout** to display any missed connections.

16. Update the flow boxes as needed.

17. To save your PDD, specify a name in the text field and click **Save**.

The **Generate PDD** button appears.

18. Click **Generate PDD** to start generating a PDD.
19. Select **Yes** or **No** to include an image appendix.  
The image appendix includes full-sized screen shots of the steps.

---

**Note:** The default images for each step is a zoomed-in snippet of the events interaction point.

The events interaction point is the area on the screen where the user is focused which is typically denoted by a red circle on the screen shot.

---

The Process Specifications page appears and the message Generating PDD displays in the bottom left corner.

20. Click **Download PDD** to open the PDD document.  
The generated Word document is available from your Downloads folder on your machine. The zip file contains all the images.
21. Review and modify the document, (if needed) and then save your PDD.

## Getting started with Privacy Enhanced Gateway

Control the data that the Process Discovery cloud platform receives by using the Process Discovery Privacy Enhanced Gateway (PEG). PEG redacts sensitive data that is included in video frames collected by the Process Discovery desktop sensor. This redaction occurs within your own Virtual Private Cloud (VPC) before the data is forwarded to the Process Discovery cloud for analysis.

Install Privacy Enhanced Gateway (PEG) to limit Personally Identifiable Information (PII) and sensitive data capture: [Install PEG on page 3852](#)

---

**Important:** We recommend using Process Discovery version 3.3.16 and above to ensure higher data reliability of events synched across Privacy Enhanced Gateway (PEG) and the Process Discovery Platform.

---

After performing the installation steps, configure PEG to mask words and send the redacted images to the Process Discovery platform: [Configure PEG image redaction on page 3867](#)

---

**Note:** Learn how to use Process Discovery Privacy Enhanced Gateway (PEG) with Automation Anywhere University for hands-on learning that is designed for beginners to advanced developers. Instructor-led training options are also available.

For more information, see [Process Discovery for Administrators \(A-People login required\)](#): Access the Process Discovery for Administrators learning trail.

---

## Install PEG

Review the prerequisites and installation process.

### Before you start installation

- PEG runs as a virtual machine (VM) in your Virtual Private Cloud (VPC). PEG deployments are supported on AWS, Microsoft Azure, and Google Cloud Platform. Automation Anywhere will provide cloud images for you to deploy. To obtain the PEG image, see [Obtain the PEG image \(A-People login required\)](#).
- Review the information on [Deployment and networking requirements](#) on page 3852

### Installation steps

1. [Create certificates](#) on page 3855
2. [Create DNS entries and deploy PEG VM](#) on page 3857
3. If you require a proxy: [Configure PEG to work with a proxy](#) on page 3857
4. [Set up and configure PEG](#) on page 3859
5. [Validate PEG is running](#) on page 3861

---

**Note:** Through the installation process, replace the values within angle brackets with your actual values and remove the angle brackets. For example:

- <apex domain> might be replaced by example.com.
  - <UID> might be replaced by 123456ab-789c-12de.
- 

### After installation

[Create image viewer user in analytics portal](#) on page 3864

## Deployment and networking requirements

Learn about the deployment architecture based on certificates for HTTPS connections and the associated port, storage, VM and DNS requirements.

### Deployment

With this deployment model, all connections to PEG remain within networks that you control.

Architecture

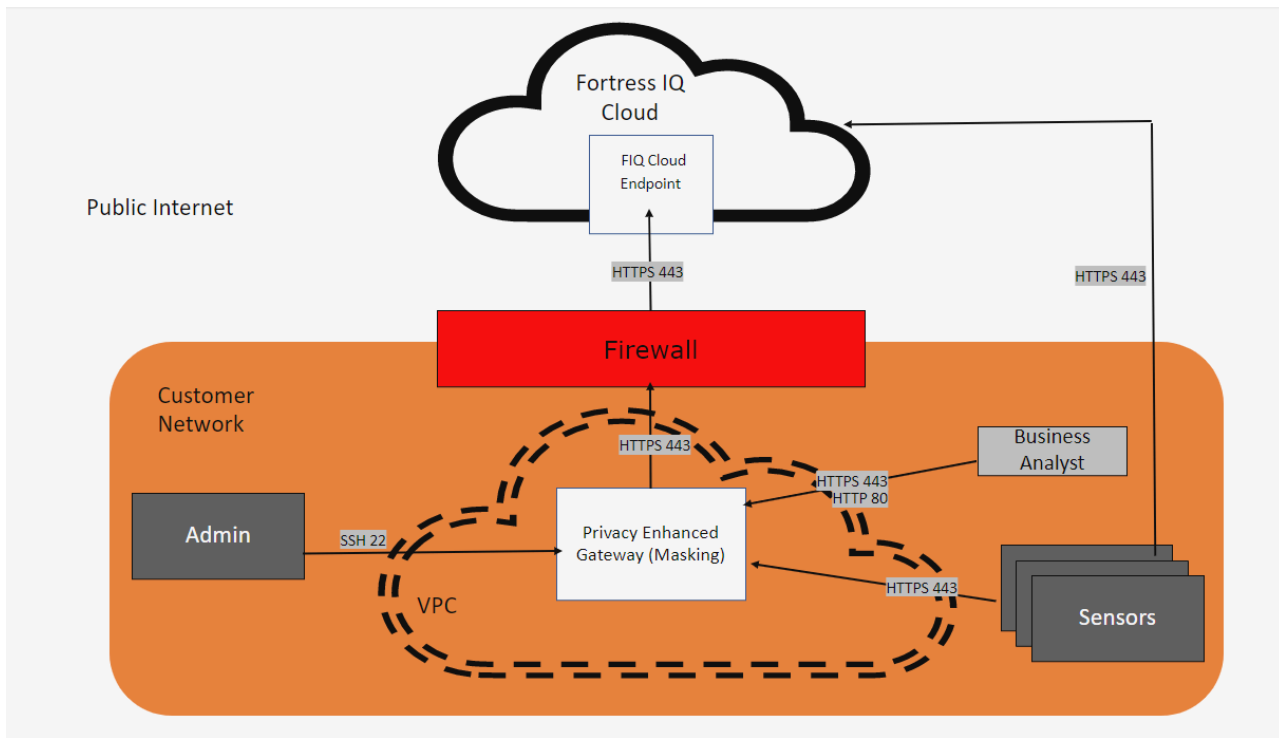

## Port requirements

The following table lists the port requirements for ingress and egress IP addresses.

Port	Protocol	Purpose	Ingress private IP	Ingress public IP	Egress to public internet
22	TCP	ssh connectivity for Admin	#		
443	TCP	Ingress Desktop sensor and business analyst connectivity over HTTPS (TLS 1.2) Egress PEG sends redacted data to Process Discovery. Also used to pull down PEG installer, updates, and so on from our repositories Sensor connects directly to Process Discovery cloud to get configuration information only. No collected data is sent directly from the sensor to the Process Discovery cloud.	#		#

Port	Protocol	Purpose	Ingress private IP	Ingress public IP	Egress to public internet
80	TCP	Used for redirection from http to HTTPS (443)	#		

## Data encryption

Data is encrypted when transmitted from PEG to the Cloud environment. The following are data encryption policy and practices in place to ensure data privacy and security:

- Secure Transmission Protocol (STP): The PEG system employs HTTPS for all data transmissions to the cloud platform, ensuring the use of encryption in transit and safeguarding against data breaches.
- Transport Layer Security (TLS) Encryption: Data transferred from PEG to the Cloud is encrypted using the TLS protocol, which is an industry standard for secure web communications.
- Confidentiality and Integrity: The encryption provided by HTTPS preserves the confidentiality and integrity of the data sent from PEG, preventing unauthorized disclosure and alterations.
- Authentication via Certificates: The Cloud platform's identity is authenticated using digital certificates as part of the HTTPS protocol, which helps prevent hacks and attacks, and unauthorized data access.
- Robust Encryption Algorithms: HTTPS incorporates strong encryption algorithms, including Advanced Encryption Standard (AES) and Rivest–Shamir–Adleman (RSA), to create a secure channel for data exchange.

## VM size requirements

The following VM sizes are supported for PEG installation:

- Microsoft Azure: NC8as T4 v3
- AWS: g4dn.4xlarge
- Google Cloud Platform: N1-highmem-8 with 1 nvidia-tesla-t4 GPU

Note: Each PEG VM can handle 10 sensors per calendar week, with each sensor sending data for approximately eight hours each day for five days a week.

## Storage requirements

Ensure that your OS or root disk has 2 TB of nearline SSD storage or more. Encrypt the disk using your platform's storage encryption mechanisms.

---

**Note:** The MiNIO and K-Lite marks and logo are trademarks or registered trademarks of MiNIO and K-Lite Codec Pack and are used for identification purposes only.

---

MiNIO serves as our in-house unstructured data storage that stores all images that are generated by the Process Discovery sensor:

- Data Protection: MinIO supports erasure coding and bitrot protection to safeguard data against hardware failures and data corruption.
- Security: MinIO provides robust security features such as encryption in transit (TLS) and at rest, identity and access management (IAM), support for bucket policies, and access control lists (ACLs).

In addition to storing unstructured data some text files such as the past list and block list are also stored in MinIO. However, the images are accessed from the K-Lite url and never directly from MinIO. The storage has a browser-based access which can be used in case of a debugging procedure or if an additional check is required for any original image that has been forwarded.

The following scenarios are supported:

- A read only user which is used by K-Lite to read images and display them in the UI
- A storage admin user that can be used for tasks requiring additional permissions

## DNS requirements

You will provide PEG with an apex domain name that you want to use (for example, example.com). Based on that, PEG will inform you about the DNS sub domain records that you must create.

## Create certificates

Create certificates as part of installing PEG.

You can create certificates by using one of two options.

- Option 1: [PEG generates keys and CSRs.](#)
- Option 2: Create your own keys and certificates.

In both cases, you will need the following:

- Unique ID (UID): Each PEG VM you run must have a unique id. You can define the UID to be anything you want as long as it meets the following criteria:
  - Less than or equal to 18 characters in length
  - Contains only letters from a to z, numbers from 0 to 9 and/or hyphens
  - Must not begin or end with a hyphen
  - Must not contain consecutive hyphens
- **Tip:** To easily create a UID, take the last 18 characters of a GUID generated from an online GUID generator.
- The apex domain that you want to use for the PEG DNS names (for example, example.com)

---

## Option 2 - Create your own keys and certificates

Learn how to create keys and certificates before you deploy PEG.

Keys and certificates must be in Base64 PEM format (called openssl or PKCS #8 for the key format in some systems). Create certificates according to [Common Tasks - Creating the certificates](#) on page 3856. Keys must not be password protected. Also, ensure that your keys match the file names in the Key File Name column of, [Common Tasks - Creating the certificates](#) on page 3856.

## Common Tasks - Creating the certificates

Learn how to create Base64 PEM certificates.

When you create the certificates, create six server Base64 PEM certificates (called openssl format in some systems), with domain names and file names mapped as follows, where the UID is provided to you by Process Discovery and the apex domain is your apex domain that you will use for PEG. Each certificate you create must just contain the leaf certificate and not the full chain.

Table 16: Mapping of domain names to certificate file names

Domain	Cert file name	Key file name (Required only if you created your own keys)
analytics-fiq-<UID>.<apex domain>	analytics-cert.pem	analytics-key.pem
proxy-fiq-<UID>.<apex domain>	proxy-cert.pem	proxy-key.pem
storage-fiq-<UID>.<apex domain>	storage-cert.pem	storage-key.pem
st-fiq-<UID>.<apex domain>	st-cert.pem	st-key.pem
dlp-fiq-<UID>.<apex domain>	dlp-cert.pem	dlp-key.pem
es-fiq-<UID>.<apex domain>	es-cert.pem	es-key.pem
klite-fiq-<UID>.<apex domain>	klite-cert.pem	klite-key.pem

**Note:** You can create one certificate with all of the SANs. You can also create just one key if you create keys if you want. However, you will still need to make sure there are seven copies of that certificate and seven copies of that key (if you created keys) named as indicated previously. Do not create a wildcard certificate.

### Create certificates option 1: PEG generates keys and CSRs

Learn how to use PEG to generate the keys and CSRs for you.

1. Log in to PEG through ssh.  
If you do not log in as user named `peguser`, then ensure that you switch to the `peguser` per this command before performing these steps.  

```
sudo su - peguser
```
2. If you already have a unique ID (UID) by Process Discovery, run the following command:  
`echo "<UID>" > ~/.kudzu/appliance.txt`, where UID is the unique ID that you were provided. If you do not have a UID, the next few steps will generate one for you.
3. Run `cd peg && ./peg_start.sh`.
4. Select **Cluster management**.



```
No Products Found
[~] Initializing Installer ... Initialized!
Which function would you like (Use ↑/↓ and ←)
> Cluster Management
  Redaction Management
  Vault Management
```

5. Select **Generate Certificate Requests**.

```
Which function would you like
  Install Cluster - Cloud Managed
  Install Cluster - On Premise
> Generate Certificate Requests
```

6. Fill out the options that follow.
7. Exit the menu.
8. Please record the UID value that you see in the output of this command: `cat ~/.kudzu/appliance.txt`  
The CSRs are located in `~/peg/csr`.
9. Create certificates from those CSRs per [Create certificates](#) on page 3855.

## Create DNS entries and deploy PEG VM

Create DNS entries and deploy PEG VM as part of installing PEG.

Create DNS entries where each domain mentioned in [Table 1](#), points to the PEG VM (PEG must have a static IP or a static domain name).

## Configure PEG to work with a proxy

Configure PEG to use a proxy for outbound traffic if required.

Deploy PEG VM

---

**Note:** When you deploy the PEG VM, ensure that it has a static IP or at least a static domain name. To configure the VM static IP address, use the mechanism provided by your VPC provider.

---

1. Log in to the PEG VM through ssh.
2. Copy your proxy certificate, if one is required, to the following locations:

---

**Note:** The proxy file name must have a `.crt` extension and must be in the Base64 PEM format (called openssl format in some systems).

---

- ```
sudo cp <your proxy certificate.crt> /usr/local/share/ca-certificates/
```
- ```
sudo cp <your proxy certificate.crt> /peg_v/certs/
```

3. For the OS to load the certificate, run the following command: `sudo update-ca-certificates`

4. Add the following to the `/etc/environment` file (including the username and password if required) using the `http_proxy` and `https_proxy` values for your environment.

**Note:** Although this is not a requirement, the `https_proxy` value is often the same as the `http_proxy`, with the protocol being HTTP for both.

Enter the URL in the following format: `<your http/https proxy url>`

Enter the username and password if required: `http://username:password@host:port/`

```
---
```

```
http_proxy=<your http proxy url> https_proxy=<your https proxy url>
```

```
no_proxy="localhost,::1,127.0.0.0/8,0.0.0.0,10.0.0.0/8,192.168.0.0/16,172.16.0.0/16"
```

5. Log out of your ssh session and then log back in.  
This allows the proxy settings to be picked up by the operating system.
6. Edit the following values as follows in `~/peg/text_pipeline/values-gpu.yaml`. (These values are at the bottom of the file).  
Enter the URL in the following format: `<your https proxy url>`. Enter the username and password if required. `http://username:password@host:port/`

If you do not use a certificate for the proxy, `fluentd_cert_path` should be left as follows: ""

```
---
```

```
has_fluentd_proxy: "true"
```

```
fluentd_cert_path: "/peg_v/certs/<your proxy.crt>"
```

```
https_proxy: "<your https proxy url>"
```

```
---
```

7. If you performed the steps in before performing the proxy steps outlined in the previous steps, perform the following steps:
  - a) Run `cd peg && ./peg_start.sh .`
  - b) Select Cluster Management and press Enter, and then select Load Certificates and press Enter again.

```
No Products Found
[~] Initializing Installer ... Initialized!
Which function would you like (Use ↑/↓ and Enter)
> Cluster Management
```

```
Which function would you like
Install Cluster - Cloud Managed
Install Cluster - On Premise
Generate Certificate Requests
> Load Certificates
```

## Set up and configure PEG

Configure PEG for your environment.

If you require a proxy configuration, first perform the steps outlined in [Configure PEG to work with a proxy](#) on page 3857.

Ensure the following:

- Unique ID (UID) provided by Process Discovery
- Platform endpoint provided by Process Discovery
- PEG-managed certificates: the apex domain that you want to use for the PEG DNS names (for example, example.com)

1. Log in to PEG through ssh.

---

**Note:** If you do not log in as user named peguser, then ensure that you switch to the peguser before performing these steps: `sudo su peguser`.

---

2. Run the following commands:

```
echo "<apex domain>" > ~/.kudzu/apex_domain.txt
```

```
echo "<UID>" > ~/.kudzu/appliance.txt
```

```
echo "127.0.0.1" > ~/.kudzu/external_ip.txt
```

```
echo "CSRs Generated" > ~/.kudzu/csr_log.txt
```

3. Modify the existing values in `~/peg/text_pipeline/values-gpu.yaml` as seen here. Do not include a slash at the end of the URL.

```
external_fluentd_url: "https://<FortressIQ provided platform endpoint>"
```

```
external_fluentd_port: "443"
```

4. Confirm that the PEG VM can reach the Process Discovery platform by running the following: `curl https://<FortressIQ provided platform endpoint>`

Use the platform endpoint based on where your cloud tenant is located:

Region	Process Discovery provided platform endpoint
United States	https://tr-na-000-fluentd-web.fortressiq.com
United Kingdom	https://tr-uk-00-fluentd-web.fortressiq.com
Australia	https://tr-au-00-fluentd-web.fortressiq.com
Canada	https://prod-ca-001-fluentd-web.fiq-process-intelligence.com

The following message is displayed:

400 Bad Request

'json' or 'msgpack' parameter is required.

Although that result is an error response, it is expected as the curl is not sending a well-formed message. The response confirms that the server received the request and responded.

5. Copy the PEG certificates that you created to /peg\_v/certs/ directory.  
Ensure that they are named according to the certificate file names in [Create certificates](#) on page 3855.
6. If you also created your own keys, copy the PEG keys that you created to the /peg\_v/keys/ directory. Ensure that the keys are not password protected. Also, ensure that they are named according to the certificate file names in Table 1.  
If you did not create your own keys, the PEG-generated keys are automatically included by PEG.
7. Run ~/peg/scripts/validatecerts.sh.  
To confirm that the certificates are valid, continue only if the script passes with "All checks passed!"
8. Reboot to ensure that any updated drivers are applied correctly: `sudo reboot now`
9. Run `cd ~/peg && ./peg_start.sh`.
10. Select Redaction Management and press Enter, and then select Install module and press Enter again.

```
No Products Found
[^] Initializing Installer ... Initialized!
Which function would you like
  Cluster Management
  > Redaction Management
```

```
Which function would you like
  > Install Module
  System Monitoring
```

---

**Note:** Do NOT install cluster.

---

11. Select Vault Management and press Enter, and then select Install Module and press Enter again.

```
No Products Found
[^] Initializing Installer ... Initialized!
Which function would you like
  Cluster Management
  Redaction Management
  > Vault Management
```

```
Which function would you like
  > Install Module
  System Monitoring
```

12. Select Storage Management and press Enter, and then select Initialize Storage and press Enter again.

```
No Products Found
[^] Initializing Installer ... Initialized!
Which function would you like
  Cluster Management
  Redaction Management
  Vault Management
  > Storage Management
```

```
Which function would you like?
> Initialize Storage
System Monitoring
```

13. Select Cluster Management and press Enter, and then select Load Certificates and press Enter again.

```
No Products Found
[^] Initializing Installer ... Initialized!
Which function would you like (Use ↑/↓ and
> Cluster Management
```

```
Which function would you like
Install Cluster - Cloud Managed
Install Cluster - On Premise
Generate Certificate Requests
> Load Certificates
```

14. Change the analytics page password. Run the following and enter your password. `cd ~/peg/scripts/ && ./change_elastic_password.rb`

---

**Note:** The username for logging in to `https://analytics-fiq-<UID>.<apex domain>` is admin.

---

15. Add storage users as needed . You will need at least one user with at least read access to confirm that PEG works. These are the users that can review the redaction of the images. `~/peg/scripts/add-storage-user.rb` .

This script also gives you the option to create users that can edit the pass-and-block (allow/deny) list.

---

**Note:** The username that you create corresponds to the **Access Key** in the login page for `https://storage-fiq-<UID>.<apex domain>`. The password corresponds to the **Secret Key**.

---

Configuration is now complete.

## Validate PEG is running

Verify whether your PEG configuration is operating correctly in review mode.

Review the following table for the format and purpose of various URLs in PEG:

URL format	Purpose
<code>analytics-fiq-&lt;UID&gt;.&lt;apex domain&gt;</code>	Provides access to Kibana dashboards where we can monitor the number of logs, number of users, what is being forwarded, and so on.
<code>dlp-fiq-&lt;UID&gt;.&lt;apex domain&gt;</code>	Is a critical URL as this is where the sensor sends all its logs to. This URL must be used as an input while setting up the sensor.
<code>es-fiq-&lt;UID&gt;.&lt;apex domain&gt;</code>	Used for accessing database directly.  This is very important as the key light application accesses database to align meta data with the images.

URL format	Purpose
<code>klite-fiq-&lt;UID&gt;.&lt;apex domain&gt;</code>	Provides access to the Klite application where the raw data and the corresponding screen shots can be visualized.
<code>proxy-fiq-&lt;UID&gt;.&lt;apex domain&gt;</code>	Monitors the health of Kubernetes services. <b>Note:</b> This is only required for debugging.
<code>st-fiq-&lt;UID&gt;.&lt;apex domain&gt;</code>	Provides a direct link to the OCR service. <b>Note:</b> This is only required for debugging.
<code>storage-fiq-&lt;UID&gt;.&lt;apex domain&gt;</code>	Provides Direct Access to the image storing application. <b>Note:</b> Images are in raw S3 bucket format that can be accessed through Klite.

To confirm that PEG is running as expected, perform the following steps:

1. In a browser, go to `https://storage-fiq-<UID>.<apex domain>`. You will see a screen like this: ("Access Key" = "your username" and secret key = "your password")

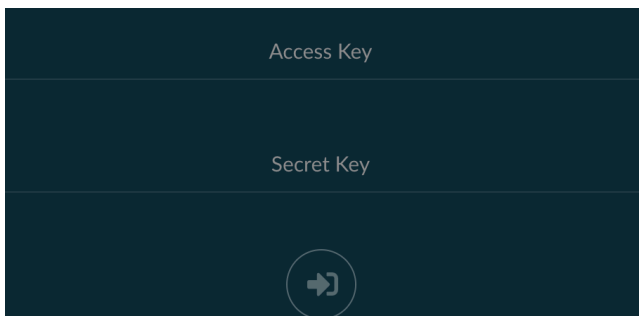

2. Log in to `https://storage-fiq-<UID>.<apex domain>` using a user you created in the configuration steps previously (by running `~/peg/scripts/add-storage-user.rb` on the VM).
3. After you log in, you will see these folders on the left. If you do not, run the "Storage Management" "initialize storage" steps in the configuration steps. If you still do not see them after that, contact Process Discovery.

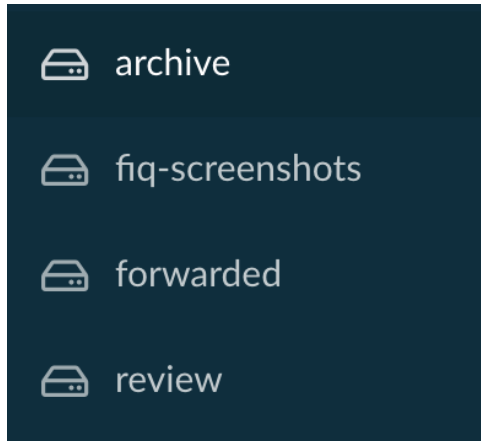

- In a browser, go to the analytics URL: `https://analytics-fiq-<UID>.<apex domain>`  
You will see a screen similar to the following:

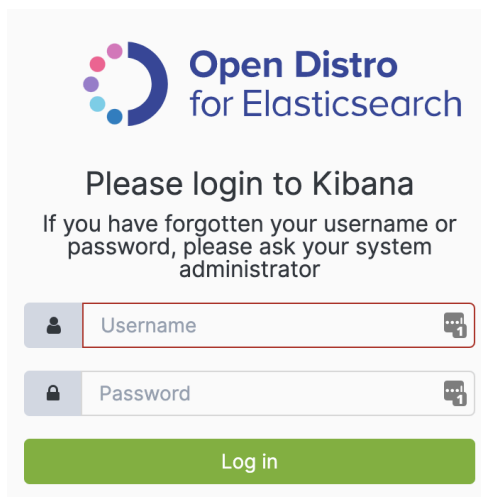

If you do, go to the next step.

- In a browser, go to `https://dlp-fiq-<UID>.<apex domain>`.  
You will just see a blank page. If you encounter an error or it times out, then there is something wrong.
- Install the Process Discovery Sensor on a Windows machine. Open a web page, such as <https://www.fortressiq.com>, and then click the page several times.
- After 10 minutes (which is the approximate duration for review images to be generated), log in to `https://storage-fiq-<UID>.<apex domain>`. Log in with one of the storage users that you created previously in the configuration steps.

Note on the folders on the left side:

- fiq-screenshots: Shows the screenshot that PEG received
- forwarded: Shows what the screenshot looks like if it is forwarded. This is populated regardless of whether it was actually forwarded or not.
- review: PEG adds annotation to the images here to show more clearly what will be redacted. PEG includes a blue rectangle around where the redacted word previously existed and includes the text it found above the rectangle.

- Click the **fiq-screenshots** folder on the left.

9. Download some of the images from this folder and confirm that they look like the results of your test.
10. Click on the **review** folder.
11. Download some of the images from this folder and confirm that they appear to be from your test. If PEG finds words that must be redacted, PEG includes a blue rectangle around where the redacted word existed and it includes the text it found above the rectangle, as follows.



If this looks as expected, you have validated that PEG is working in review mode.

## Create image viewer user in analytics portal

Learn how to create an image viewer user and add the user to the analytics portal. Use the image viewer to find, view, and compare images in PEG.

To create a user in image viewer user and add a user to the **klite\_read\_only** role in the analytics portal, perform the following steps:

---

**Note:** The image viewer uses the same logins as those used in the PEG analytics portal.

---

1. In a browser, go to the analytics portal: `https://analytics-fiq-<UID>.<apex domain>`
2. Enter your admin username and password.  
Your admin password is the same password as the elastic password you set when you configured PEG.
3. Go to **Security > Internal users**.
4. Click **Create internal users**.
5. In the **Create internal user** form, enter your username and password.
6. Click **Create**.
7. Go to **Security > Roles**.
8. In the search field, enter **klite\_read\_only**.
9. Click **klite\_read\_only**.
10. Select the **Mapped Users** tab, and click **Map Users**.
11. Select the users you want to map.
12. Click **Map**.

Users can now log in to the image viewer.

## Update PEG

Use the following instructions to update PEG to the latest version.

Review the following considerations before updating the PEG version:

- The current version of the PEG installation.



- The Operating System (OS) version that the PEG is currently using.

Run `ssh` in the PEG to retrieve the OS version.

---

**Note:** If you see 18.04 as the Ubuntu OS version, then it is recommended that you get the latest PEG image and start a new configuration rather than updating the PEG version. The most recent PEG image is based on Ubuntu 20.04.

---

- The Keys and Certificates that must be deployed for updating the PEG version.
1. Use the following instructions to test if PEG can access the required update files from the cloud storage:
    - a) SSH into your PEG Virtual Machine (VM).
    - b) Create a directory that will contain the update files.  
For example, `mkdir update`.
    - c) Use the following command to navigate into the `update` directory:  
`cd update`
    - d) Download the `update_peg.rb` script using the following command:

```
curl "https://figpeg.blob.core.windows.net/updates/update_peg.rb?si=get_updates&sv=2020-08-04&sr=c&sig=vVI3fmLfJyu2zsCC9nxhxUKBhsgkp5K5DnrFCDQJ%3D" -o update_peg.rb
```

- If the above command was successful, PEG VM must be able to download all of the required files for the update. Review step 2 for instructions.
- If the command times out or fails in any way, the PEG VM cannot download the update files directly. Review step 3 for instructions.

2. If the above command was successful, use the following instructions to download the PEG update file directly to the PEG VM:
  - a) Ensure that you are in the directory of PEG that you had previously created.  
Use the `cd update` command to get to the directory.
  - b) Use the following command in order to make the update script executable:  
`chmod ugo+x update_peg.rb`
  - c) Run the following update script:  
`./update_peg.rb`

This script will not update the PEG but will only download all the dependent files for the update.

---

**Note:**

By default, `update_peg.rb` downloads the update files from United States server. However, If the download times out or you encounter an error, you can download it from the Australia server by using the following command to switch the country:

```
./update_peg.rb --country au
```

---

If the download was successful, **You have all files needed for the upgrade** message is displayed.

- d) Run the following update script:  
`./update_peg.rb --upgrade-peg`  
This can take a while (about an hour or less).

---

**Note:** If the script fails before the update completes, do not run it again. Contact Automation Anywhere support for assistance.

---

If the update was successful, an **Update done** message appears.

3. If the PEG is unable to access the required update files from the cloud storage, use the following instructions to download the file outside the PEG VM:
- a) Run the following command on a Windows machine with curl (for example, Windows 10) or a Linux machine that has access to a public internet:

```
curl "https://fiqpeg.blob.core.windows.net/updates/update_peg.rb?si=get_updates&sv=2020-08-04&sr=c&sig=vVI3fmLfJyu2zsCC9nxhxUKBhsgkp5K5DnrFCDQJ%3D" -o update_peg.rb
```

---

**Note:** If the above command fails or times out, you need not access the PEG update files. Try another machine that has outbound `https` port `443` access to `fiqpeg.blob.core.windows.net`.

---

- b) If the above command was successful, copy the downloaded `update_peg.rb` to the update folder in your PEG VM.
- c) Sign in to PEG.
- d) Use the following command to navigate to the update folder:  
`cd update`
- e) Use the following command in order to make the update script executable:  
`chmod ugo+x update_peg.rb`
- f) Use the following command to run the update script:  
`./update_peg.rb`  
The update script will create a `./download_peg_updates.sh` file. Run this script on a machine that can access the public internet you used earlier. If it is a windows machine, you can copy the contents of the `./download_peg_updates.sh` file and run those curl commands.
- g) Copy all the files that were downloaded into the update folder in your PEG VM.
- h) Repeat the step c and g until `./update_peg.rb` completes with a message **You have all files needed for the upgrade**.

---

**Note:** You might have to repeat these steps multiple times as with each file you add to the update directory, the `update_script.rb` learns new info about what other update files are required. Typically, you have to run through this cycle of steps three times before the update script has the necessary files for the update.

---

- i) When the above step is successful, run the following update script:  
`./update_peg.rb --upgrade-peg`  
This can take a while (about an hour or less).

If the update was successful, an **Update done** message appears.

## Configure PEG image redaction

After performing the installation steps, configure PEG to mask words and send the redacted images to the Process Discovery platform.

### Configuration steps

Step 1: [Manage redaction list configurations](#) on page 3868

PEG redacts words based on the pass and block lists for forwarding.

The pass list: PEG will not redact the built-in pass list of words. Only words in the pass list will be included in images and other data sent to the Process Discovery platform. Words that are not on the pass list are redacted.

The block list: The block list is a list of words that PEG will redact. PEG redacts words based on this list before processing the pass list.

The block list is useful in situations where you know words exist on the pass list that you want redacted, but you do not want to have to modify the pass list. One common use case is that some people's names are also everyday words that appear on the default pass list. You can create a block list of all of the names of your employees or common names in various countries, which can be obtained from the Internet.

---

**Note:** The redaction of all information is subject to the OCR accuracy. Please note that 100% redaction accuracy of all information can be difficult to achieve and might require a high degree of manual review.

---

Step 2: [Review redaction results](#) on page 3870

The image viewer enables users to review incoming images and redaction results.

Step 3: [Manage forwarding configurations](#) on page 3873

Redacted images are processed in one of two modes, the review mode and the forwarding mode.

The review mode: This is the default mode for PEG when it runs for the first time. In this mode, you can review the redacted images, make changes to the pass-and-block lists, without PEG forwarding data to the Process Discovery platform.

The forwarding mode: When you are comfortable with the results of your review of the images, you can enable the forwarding mode. In this mode, PEG will redact sensitive data from newly incoming images and send the redacted data to the Process Discovery platform. (Existing images from review mode will not be forwarded.)

## Manage redaction list configurations

Learn how to manage your redaction configurations from the Privacy Enhanced Gateway (PEG) UI and export logs, instead of running commands on the Command Line Interface (CLI).

To update your redaction settings from the UI, perform the following steps:

1. Log in to your PEG klite URL platform as an administrator: `https://klite-fig-  
<UID>.<apex domain>`.
2. In the upper right-corner, navigate to **Admin > PEG configuration**.
3. In General Settings, select **Redaction List**.
4. In the **Pass List** section, select from the following options:

Option	Action
Upload new list document	<p>Click to upload a new list of words. The words on this list are not redacted and are sent to the platform. Words are on this list typically do not contain sensitive, private information (such as credit cards numbers, phone numbers, names, and so on).</p> <hr/> <p><b>Note:</b> Any word that is not on the pass list is redacted.</p> <hr/>
<pass-list>.txt	<ol style="list-style-type: none"> <li>a) Click to edit the existing pass list. The list is saved in the Downloads folder.</li> <li>b) Open the file, add your changes, and save the file.</li> <li>c) Click <b>Upload new list document</b> to upload the document.</li> </ol> <p>A pop-up message appears notifying you that the pass list is updated successfully.</p> <p>Each line can only contain one word. A word can contain letters, numbers, and symbols, but no spaces. For words with numbers and symbols, those words will only be used for comparison if the <b>Cleaning</b> field is set to <b>false</b>. The words are case-insensitive. For more details about cleaning, see step 11.</p>

Option	Action
Text field	Enter the words in the text field to update the existing pass list followed by the <b>Enter</b> key. For example, to update the pass list to include a category (such as Support), enter Support in the text box followed by the <b>Enter</b> key.

5. Click **UPDATE** to save your changes for the pass list in the text field.
6. Click **CLEAR ALL** to clear your changes in the text field and start over.
7. In the **Block List** section, select from the following options:

Option	Action
Upload new list document	Click to upload a new list of words. The words on this list are redacted and not sent to the platform.
<block-list>.txt	<p><b>a)</b> Click to edit the existing block list. The list is saved in the Downloads folder.</p> <p><b>b)</b> Open the file, add your changes, and save the file.</p> <p><b>c)</b> Click <b>Upload new list document</b> to upload the document.</p> <p>A pop-up message appears notifying you that the block list is updated successfully.</p> <p>Each line can only contain one word. A word can contain letters, numbers, and symbols, but no spaces. For words with numbers and symbols, those words will only be used for comparison if the <b>Cleaning</b> field is set to <b>false</b>. The words are case-insensitive. For more details about cleaning, see step 11.</p>
Text field	Enter the words in the text field to update the existing block list followed by the <b>Enter</b> key.

8. Click **UPDATE** to save your changes for the block list in the text field.
9. Click **CLEAR ALL** to clear your changes in the text field and start over.
10. In the **Redaction Word Filter Setting** section for **Fuzzy Matching**, select **true** to allow Optical Character Recognition (OCR) some level of variation (fuzzy matching) to consider a word a match. By default, **Fuzzy Matching** is set to true and PEG does not require an exact match when comparing a word with a word on the pass for the block list. Select **false** to disable fuzzy matching.

---

**Note:** When reviewing the redaction levels, you might find some sensitive text (that is not on the allow list) displaying unexpectedly in the applications screenshots. In that case, select **false** to disable fuzzy matching to provide a preferable result.

---

For example, if OCR reads a word as kello. There is a chance that OCR might be right or wrong in how it reads the word kello. Kello is not in the pass or block list. Kello might be

considered a close enough match to hello (with the idea that kello was just OCR misreading hello). So, if the word hello is in the pass list, then the word kello would also be allowed and not redacted.

11. In the **Cleaning** field, click the drop-down to select **true** to remove all non-alphabetic (anything not a letter in the alphabet) from a detected word before comparing it to the words in the dictionaries. Select **false** to allow numbers for cleaning. By default, cleaning is set to true.

---

**Note:** Cleaning defines whether non-alphabetic characters should be ignored when comparing a word with the dictionaries.

For example, there are category types (PURCH2A, PURCH2B, and PURCH2C) that are a mix of numbers and letters that appear in your application screens that should not be redacted. To ensure that PURCH2A, PURCH2B, and PURCH2C are not redacted, add the words to the allow list and disable cleaning. PEG will not remove the numbers from these words when comparing with the words on the allow list. Another example is if you have an account ID, such as SA31LE. If cleaning is set to true, then PEG removes the number 31 from SA31LE and compares the word, SALE with the words in the allow list. If SALE is in the allow list, then it is not redacted. However, if you set cleaning to false, cleaning compares SA31LE with the words on the allow list. Since SA31LE is not in the allow list, SA31LE is redacted.

- 
12. Click **UPDATE** to save your changes.  
A pop-up message appears notifying you that your changes are successfully deployed.

13. Click one of the following buttons to export the logs from the UI:

- **Export Logs**

The logs begin generating. After the logs have generated, click **Download Logs** to download the `logs.zip`. The log files contain information about the system (including logs for the last 24 hours).

- **Export PEG metrics**

After the metrics are generated, click **Download PEG Metrics** to download the `pegMetrics.zip`. The file contains operational and performance metrics about the system.

## Review redaction results

Use the image viewer to see the incoming images and review the redaction results to determine what changes to make to the redaction configurations.

You can use the image viewer to see images in the following buckets:

- `fiq-screenshots`: This contains the screenshots that PEG received.
- `forwarded`: This is what the screenshot looks like when it is forwarded to the Process Discovery platform. This is populated regardless of whether it is forwarded or not.
- `review`: This includes annotated images. PEG adds annotation to the images to clearly show what will be redacted. PEG puts a rectangle around where the redacted word previously existed and includes the text it found above the rectangle.

To review the images, perform the following steps:

**Note:** These instructions show you the filters that are used frequently, but you can change the selection as needed.

1. Log in to the image viewer.  
To open the image viewer application, enter the following address in a web browser:

```
https://klite-fiq-<UID>.<apex domain>
```

2. Click the **Bucket 1 (Mandatory)** field and select **fiq-screenshots**.
3. Click the **Bucket 2 (Optional)** field and select **forwarded**.
4. Use the calendar to select a date range for reviewing the data.

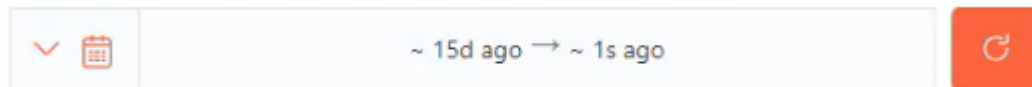

5. Click the **Configure Field** drop-down menu and select fields that you want to apply the filter on.  
For example, select the **Application**, **Keystrokes**, and **Machine** fields.

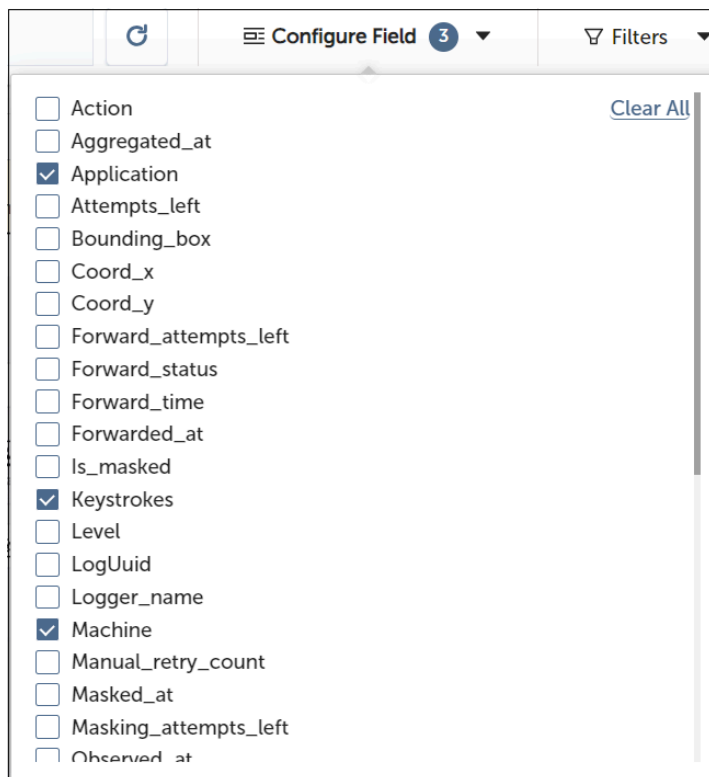

The image viewer displays the selected fields above the screenshot.

6. Click **Filters** to specify a value for the fields that you have selected in the **Configure Field**.  
For example, select the **Field** as **application**, **Operand** as **Is**, and the **Value** as **explorer** to see the images that contain explorer.

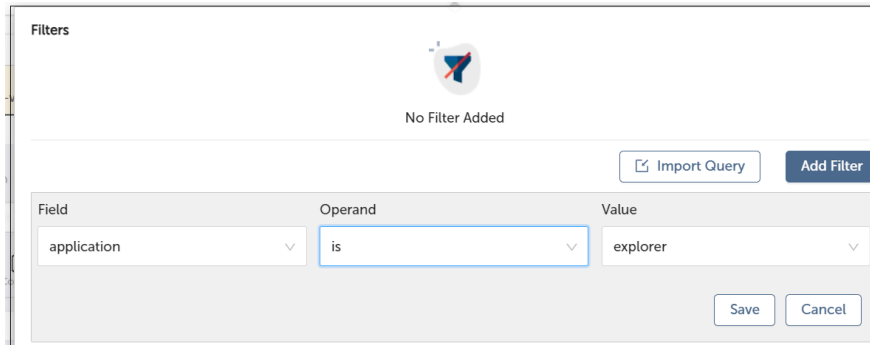

7. Optional: The **Carousel View** is default display option. Click the drop-down menu and select **Real Time Redaction**.

You can use real-time redaction as a *sandbox environment*, where you can edit the pass and block lists and immediately see the impact of those edits. When you are ready, you can commit your edits to the system redaction configurations.

- a) From the toolbar at the top, click **Carousel View > Real Time Redaction**.

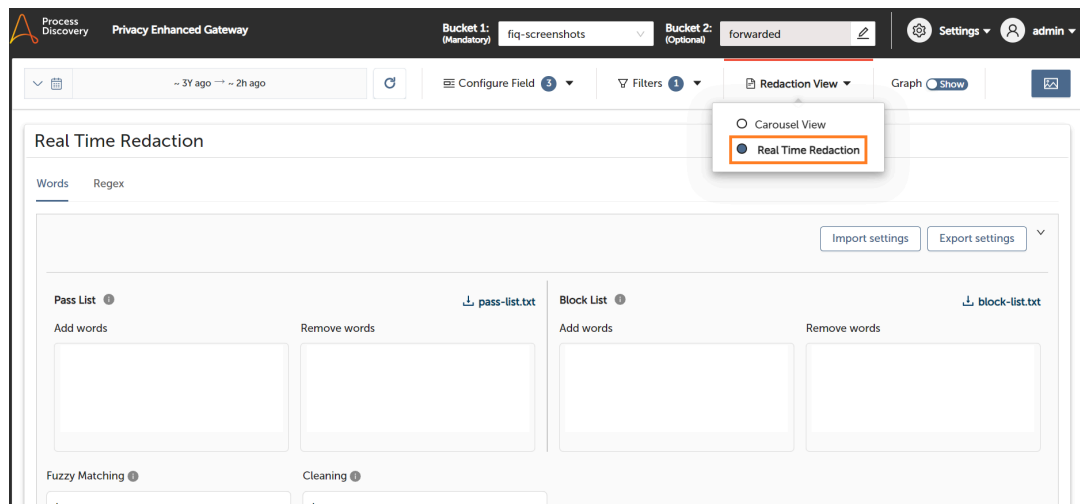

- b) Use the slider to review the image before and after redaction.

- c) Use one of the following filters for the images:

- **Words**

Use the following two fields to add or remove the words:

- **Pass List:** The words on this list are not redacted and are sent to the platform. Words on this list typically do not contain sensitive, private information (such as credit cards numbers, phone numbers, names, and so on).
- **Block List:** The words on this list are redacted and not sent to the platform.

- **Regex**

Use regular expressions (regex) to create string patterns that help match, locate, or manage text:

1. Click the **Create regex** icon for new regex expression.
2. Enter a regex pattern in the **Regex expression** field.
3. In the **Description** field, add a description for the new regex expression.



4. Use the **Action** field to select one of the following redaction conditions:
  - **Allow**
  - **Block**
5. Click **Commit** to save the regex filter.
- d) Click **Preview** to see the redaction results of your edited Pass and Block lists.  
Continue making changes to the lists and reviewing the image until you are satisfied with the redaction results.
- e) Click **Commit** to apply your changes to the system redaction configurations.
8. Optional: Export images for further review. To export images, do the following steps:
  - a) Click the **Export image** icon located in the top-right corner of the page.
  - b) Select the range of images to export using the modal bar.
  - c) Select the slot from which to export the images.  
A slot is a container for up to 100 images.
  - d) Alternatively, select the **Random** export option.
  - e) Click **Download**.
9. Review the images to ensure the correct content is being redacted.
10. To change the redaction configurations, do the following steps:
  - a) Return to the Redaction list page to update the pass and block lists.  
For more information on editing the pass and block lists, see [Manage redaction list configurations](#) on page 3868.
  - b) From the upper right corner, navigate to **Admin > PEG configuration > Forwarding**.
  - c) Click **Run re-redaction sync job** to apply the new redaction configurations on images that were not forwarded to the Process Discovery platform.
  - d) Return to the Image viewer to review the newly-redacted images.

When you are satisfied with the redaction results, turn on image forwarding. See [Manage forwarding configurations](#) on page 3873

## Manage forwarding configurations

Learn how to manage your forwarding configurations from the Privacy Enhanced Gateway (PEG) UI instead of running commands on the Command Line Interface (CLI).

To update your forwarding settings from the UI, perform the following steps:

1. Log in to your PEG klite URL platform as an administrator: `https://klite-fiq-<UID>.<apex domain>`.
2. In the upper right-corner, navigate to **Admin > PEG configuration**.
3. In General Settings, select **Forwarding**.

4. In the **Forward to platform** field, select **true** to forward redacted data platform, or select **false** to prevent sending forward redacted data to the platform.  
By default, the **Forward to platform** field is set to false.
5. In the **Port for forwarding** field, the default port number is 443.  
We recommend that you leave the default port number as 443 unless you need to change it.
6. In the **Forward live records** field, select **true** to forward the live events to the platform, or select **false** to prevent sending any events to the platform.  
You can use this setting to forward new incoming events. It will not forward existing events that are masked. If you select **false**, the incoming events are redacted, but not sent to the platform.
7. In the **Forward existing masked records** field, select **true** to forward existing events that were already recorded but have not been sent to the platform. Select **false** to prevent sending any existing events collected on your machine to the platform.  
You use this field only to forward data that was previously collected. For example, you might have collected events for two weeks and forgot to send the events to the platform.
8. In the **UTC start date for forwarding** field, enter the start date for the observed at date range. The observed at date range is when the Process Discovery Sensor recorded the event on the machine. You must specify the range in the UTC time zone.  
Based on the date range you enter, PEG forwards previously redacted events that were not already forwarded to the platform.
9. In the **UTC end date for forwarding** field, enter the end date for the observed at date range.
10. To use a proxy, click the **Use Proxy** checkbox.
11. In the **https proxy** field, enter the proxy URL address to use.  
If required, include the username and password in the URL: http://username:password@host:port/
12. Click **Deploy**.

## Switch between modes

Change PEG to the forwarding mode and then back to the review mode.

By default, PEG initially starts in the review mode.

1. To switch to the forwarding mode:
  - a) Edit the `~/peg/text_pipeline/values-gpu.yaml` file. At the end of the file, change the `forward_to_fluentd` value to true and save the changes.  
`forward_to_fluentd: "true"`
  - b) Push the change to PEG by running the following from any folder:

```
source ~/peg/scripts/vars.sh
```

```
kubectl delete cronjob.batch/text-pipeline-masking-masking-cron -n text-pipeline
```

```
kubectl get pods --output=jsonpath={.items..metadata.name} -n text-pipeline -o=name | grep cron | xargs -n1 kubectl delete --grace-period=0 --force -n text-pipeline
```

```
helm upgrade text-pipeline ${text_pipeline_dir} -f ${values_file_t} --namespace text-pipeline --set ocr.name=st-
```

```
fiq-$new_gen_uuid.$apex_domain --set masking.name=dlp-fiq-$new_gen_uuid.$apex_domain
```

2. To switch back to the review mode:
  - a) Edit the `~/peg/text_pipeline/values-gpu.yaml` file. At the end of the file, change the `forward_to_fluentd` value to `false` and save the changes.  
`forward_to_fluentd: "false"`
  - b) Push the change to PEG by running the following from any folder:

```
source ~/peg/scripts/vars.sh
```

```
kubectl delete cronjob.batch/text-pipeline-masking-masking-cron -n text-pipeline
```

```
kubectl get pods --output=jsonpath={.items..metadata.name} -n text-pipeline -o=name | grep cron | xargs -n1 kubectl delete --grace-period=0 --force -n text-pipeline
```

```
helm upgrade text-pipeline ${text_pipeline_dir} -f ${values_file_t} --namespace text-pipeline --set ocr.name=st-fiq-$new_gen_uuid.$apex_domain --set masking.name=dlp-fiq-$new_gen_uuid.$apex_domain
```

## Manage disk space

Manage disk space by managing the duration for which images are kept in the review folder.

When the disk usage is over 80 percent, PEG stops processing new messages. To manage the setting in the review folder, perform the following steps:

1. Add the following block of code to the end of the `~/peg/text_pipeline/values-gpu.yaml` file. (Alternatively, if an entry already exists, modify it.)

```
#Archive Info  
review_retention_days: 365
```

The value that you include here will be the number of days for which PEG will keep an image in the review folder. Replace the number 365 with the number of days for which you want to retain review images. This will affect only the review images. The original images and the images in the forwarded folder will not be affected.

2. Push the change to PEG by running the following from any folder:

```
source ~/peg/scripts/vars.sh
```

```
kubectl delete cronjob.batch/text-pipeline-masking-masking-cron -n  
text-pipeline
```

```
kubectl get pods --output=jsonpath={.items..metadata.name} -n text-  
pipeline -o=name | grep cron | xargs -n1 kubectl delete --grace-  
period=0 --force -n text-pipeline
```

```
helm upgrade text-pipeline ${text_pipeline_dir} -f ${values_file_t}  
--namespace text-pipeline --set ocr.name=st-fiq-$new_gen_uuid.  
$apex_domain --set masking.name=dlp-fiq-$new_gen_uuid.$apex_domain
```

## Manage PEG events

An event consists of a screenshot and logs (meta data of actions performed while the screenshot was captured). Events can be used to review any data reliability shortcomings that might occur between PEG and Process Discovery platform when data is not in sync.

The **Events Console** screen enables you to review the status of the events, search any failed or pending events, or use a start and end date to filter all the events. However, the **Date Filter** can be used only for the events with **Completed** and **Failed** status. The status can be used to reduce errors caused while forwarding events from PEG to Process Discovery.

Consider a scenario where you want to review the list of events that must be forwarded to the Process Discovery platform. After filtering these event, you want to forward them together (bulk).

1. Log in to your PEG klite URL platform as an administrator: `https://klite-fiq-<UID>.<apex domain>`.
2. In the upper right-corner, navigate to **Settings > Events Console**.  
Events Console screen is displayed that contains the status for all the events, a search and filter fields.
3. Click the **Status** drop-down menu and select **Forward Pending**.  
The **Total events** field is refreshed and the number of events that are pending to be forwarded is displayed.

---

**Note:** You can click any of the events to review the event details such as the transmission timestamps, the reason why the forwarding of the event failed, number of times the forwarding was attempted and so on. PEG attempts to forward an event to Process Discovery for a maximum of five times before moving it to the **Failed** status.

---

4. Select all the events and click the **Bulk retry** icon at the top of the table.  
An alert is displayed that an attempt to forward the events in bulk is initiated and would take sometime. You can click **Status > Forward Pending** and review the total number of events.

## Using Bulk delete

Free up storage space by generating a list of images that meet a specific criteria, then selecting the images for deletion.

You must be an admin user to perform bulk deletion.

1. To access Bulk delete for the first time, navigate to **Settings > Enable bulk delete**.  
The Bulk Delete modal opens.  
In the future, access the Bulk Delete modal from the right side of the window.
2. Specify the time range for when the images were collected.
3. Optional: Select from the following filters and provide the acceptable values: **application**, **user**, or **machine**.  
PEG displays the number of images that match your search criteria.

**Bulk Delete**

All images related to the filters below will be deleted from the database and this cannot be undone.

**Note:** Only **application**, **user**, **machine** and **date range** filters are used while deleting. All the rest are ignored. If any of these filters is not applied, all data in the selected date range will be deleted.

~ 3Y ago → ~ 1m ago Refresh

**Add Filters**

application is EXCEL +

**Query Filter**

You've selected **154027** records

If you're sure, please type "DELETE" in the box

No, cancel Yes, delete

4. Enter **DELETE** in the text box.
5. Click **Yes, delete**.

## Renew and replace certificates and keys using PEG

In the customer-managed certificates deployment model, certificates and keys that are set to expire are not renewed and replaced automatically.

When your certificates are set to expire, you must perform the following tasks to renew them:

1. Create a new certificate. You can create a new certificate with two options:
  - You can choose to have PEG create the new certificate signing request and the keys, or
  - You can create your own certificates and keys. To create your own certificates and keys, see [Create certificates](#) on page 3855.
2. Upload the new certificate. To upload the new certificate, see [Upload the new certificates](#) on page 3878.

If you choose to have PEG generate new keys and the certificate signing requests, perform the following steps:

1. Run `cd peg && ./peg_start.sh`.
2. Select **Cluster Management**.

```
No Products Found
[~] Initializing Installer ... Initialized!
Which function would you like (Use ↑/↓ and ←)
> Cluster Management
  Redaction Management
  Vault Management
```

3. Select **Generate Certificate Requests**.

```
Which function would you like
  Install Cluster - Cloud Managed
  Install Cluster - On Premise
> Generate Certificate Requests
```

4. Enter information for the options that follow.
5. Exit the menu.  
The certificate signing requests are located in `~/peg/csr`.
6. Create certificates from the CSRs that PEG generated. For more information, see [Create certificates](#) on page 3855.

## Upload the new certificates

Learn how to upload the new certificates and keys after they are created.

1. Copy the PEG certificates that you created to the `/peg_v/certs/` directory.  
Ensure that you name them according to the certificate file names in [Table 1](#).
2. If you also created your own keys, then copy the PEG keys that you created to the `/peg_v/keys/` directory.  
Ensure that the keys are:
  - Not password protected
  - Named according to the certificate file names in [Table 1](#)

**Note:** If you choose to have PEG generate the keys, then you do not need to perform this step. The PEG-generated keys are placed into a folder for you.

3. To confirm that the certificates are valid run `~/peg/scripts/validatecerts.sh`. Continue to Step 4 only if the script displays: All checks passed!
4. To load the latest certificates, run the following command on PEG:

```
kubectl rollout restart deployment.apps/traefik -n kube-system
```

## Process Discovery Sensor application

Use the Process Discovery Sensor to record activity on a user's machine to determine what business processes are candidates for automation.

The Automation Anywhere Process Discovery Sensor is a lightweight application that integrates to the machines' video card to record user activities. The sensor operates in both thick and thin client applications, and across multiple monitors. You can configure which applications and domains can be used to capture activity.

### System requirements

The following system requirements are supported for installing the Process Discovery Sensor:

- Operating Systems
  - Desktop: Windows 10, Windows 11
  - Citrix VDI: Windows Server 2016
- Memory: 4 GB RAM
- Required software packages: .NET 4.7 or later

## Installing Process Discovery Sensor

Learn how to install Process Discovery Sensor on your machine.

Ensure that you install Process Discovery Sensor as a user on your machine, and not on a system level. Any user with privileges to run an MSI installer, and write permissions to their own user folder, can perform the installation. If you are using Microsoft SCCM or other software deployment solutions to deploy the MSI, make sure it is deployed as the user you are deploying it to.

1. Contact your Automation Anywhere Customer Success Manager (CSM) to obtain the msi package.
2. Unzip the msi file if you have received it as a zip file.
3. Double-click the msi file to launch the Installation Wizard.
4. Click **Next**.
5. Click **Next** to continue with your organization, endpoint, and port information. Your customer information is already populated in the fields provided.

6. Click **Install** on the Ready to Install Process Discovery window to begin the installation.
7. Click **Finish** to exit the Setup Wizard.  
The installation is complete and the Process Discovery Sensor is now running. A shortcut displays on your desktop and a pop-up message displays informing you that Process Discovery Sensor has started recording. The Process Discovery icon is displays in your system tray.
8. To quit the recording, right-click the Process Discovery icon in the system tray and click **Quit**.  
A message displays that the recording has stopped. To restart the recording, double-click the Process Discovery icon shortcut on your desktop.

---

**Note:** Depending on how the Sensor is configured, the quit option might not be available.

---

**Note:** After you enable the Observer and install the Process Discovery Sensor, the recording will automatically start even after a system reboot. To prevent the Process Discovery Sensor from automatically recording, click the caret symbol on the taskbar to access the system tray. Right-click the Process Discovery icon in the system tray and select **Quit**.

---

## Uninstalling Process Discovery Sensor

Learn how to uninstall Process Discovery Sensor on your machine.

In a centralized deployment, IT will uninstall Process Discovery Sensor. If you choose to manually uninstall Process Discovery Sensor from your system, perform the following steps:

---

**Note:** Before you begin uninstalling Process Discovery Sensor, ensure that you close the Process Discovery Sensor application on your system.

---

**Note:** Uninstalling Process Discovery Sensor from the Observers machine will not delete the previous recordings from the Process Discovery Cloud.

---

1. Navigate to **Windows > Control Panel > Programs and Features**.
2. Right-click the Process Discovery (IQ) icon and click **Uninstall**.
3. Click **Yes** to uninstall.

---

**Note:** If you receive a pop-up message informing you that the following applications should be closed before continuing the install, select, **Automatically close applications and attempt to restart them after setup is complete** and click **OK**.

---

## Installing Process Discovery Sensor in a VDI environment

Learn how to install the Process Discovery Sensor in a Virtual Desktop Infrastructure (VDI) environment and create a portable package.

Many VDI environments do not allow msi installs that install as the user, especially if they are non-persistent desktops. If the msi installer does not work in your environment, you must create



a portable installer on a machine with access to the Automation Anywhere Process Discovery platform.

1. Install the Process Discovery Sensor using the MSI installer. For more details, see [Installing Process Discovery Sensor](#) on page 3879.

Ensure that Process Discovery Sensor is running. The Process Discovery Sensor icon displays in the bottom right corner of the system tray.

2. Navigate to `C:\Users\\AppData\Local\Programs\Neo2` and copy the files that the Process Discovery Sensor installer created in that folder to a different folder. For example, you can name the folder Process Discovery Sensor files.

3. In Windows Explorer, search in **Add or remove programs**.

4. Locate the Process Discovery Sensor app and remove the program.

This removes the existing install folder and the registry settings.

5. Copy the Process Discovery Sensor files that you put in a folder to any folder on the VDI server.

6. Create a startup script to start the Neo2.exe on login for users that will run the Process Discovery Sensor.

By default, the Process Discovery Sensor needs write access to the folder it is running from because that is where the Process Discovery Sensor writes the logs and downloads the configuration from the platform. Since the Process Discovery Sensor runs in the user space, users need write access to that folder. If you do not want users to have write access to that folder, you can specify a different writable folder to store the logs and the Process Discovery Sensor configuration. For more details on storing the logs and sensor configuration to a writable folder, see [Modifying the log and configuration storage location](#) on page 3881.

## Modifying the log and configuration storage location

Learn how to change the location of the logs and the Process Discovery Sensor configuration storage folder to a folder that is writable to all users who have the Process Discovery Sensor running on their machine.

1. Copy the `NeoRemoteConfig.json` file to the folder where you want to store it. The `NeoRemoteConfig.json` file is one of the Process Discovery Sensor files you should see in your portable installer folder. The folder you copy it to must be the same writable folder where you want to store the logs.
2. Set the log and config file location by specifying the absolute path to the new folder in the `Path.config` file. In the folder with the `Neo2.exe`, there should be a `Path.config` file. For example, your `Path.config` file might contain: `z:\user_shared_storage\neo2_logs_and_config`.

You can assign it to an absolute path or can use one special reserved variable `{MyDocuments}`.

If you use the `{MyDocuments}` variable in the `Path.config` file, the logs will be stored in a folder named Neo2 in the user's Documents folder.

---

**Note:** The Process Discovery Sensor expects to see the `NeoRemoteConfig.json` in that folder.

---

## Verify Process Discovery Sensor Installation

Use the log files to verify that the Process Discovery Sensor is installed correctly on your machine.

1. While the Process Discovery Sensor is running and in recording mode, click a few times anywhere on your machine.

Clicking a few times on your machine triggers the Process Discovery Sensor to collect and send a screenshot to the Platform which results in entries in the Process Discovery Sensor logs that you can use for validation.

For more details on enabling the Process Discovery Sensor in recording mode, see [Enable and disable the users recording](#) on page 3884.

2. From Windows Explorer, open the C:\Users\\AppData\Local\Programs\Neo2 folder. If you changed the default location for the logs, then open the folder you have changed it to.
3. Locate this log file: Neo\_<machine name>\_<userid>.log
4. Double-click to open the log file.

If the Process Discovery Sensor is working as expected, the following lines display as an example towards the bottom of the log file. If everything is correct, a job number displays, followed by OK.

```
2022-11-08 22:03:39.3775 TEST\testuser
com.FIQ.Neo2.Utility.Network.RawLogForwardingPostConsumer [INFO]
Worker id: 5b1bd418-2e19-4097-8ba7-31af6f22bd0a, queue size: 0,
current job 152 OK, time elapsed: 0ms, type: fiq.win.keylog
```

```
2022-11-08 22:03:39.3775 TEST\testuser
com.FIQ.Neo2.Utility.Network.RawLogForwardingPostConsumer [INFO]
Worker id: 61849714-b916-43b7-8878-eced56dd1d65, queue size: 0,
current job 151 OK, time elapsed: 5ms, type: fiq.win.screenshot
```

If the Process Discovery Sensor is not working, you will see words such as error and failed in the log files output.

---

**Note:** If you experience issues, please contact Automation Anywhere for assistance.

---

```
2022-11-08 14:13:32.5720 TEST\testuser
com.FIQ.Neo2.Utility.Network.RawLogForwardingPostConsumer [ERROR]
Worker id: bbe8547d-3c67-473d-a328-e949a7c25a03, queue
size: 13, current job 2 failed, type: fiq.win.screenshot,
time elapsed: 10ms, System.AggregateException: One or
more errors occurred. ---> Flurl.Http.FlurlHttpException:
Call failed. An error occurred while sending the request.
POST https://test.example.com:443/fiq.win.screenshot --->
System.Net.Http.HttpRequestException: An error occurred while
sending the request. ---> System.Net.WebException: The remote name
could not be resolved: 'test.example.com'
```

## Event Recording

This topic describes the event recording using the Process Discovery (PD) Sensor application. This application seamlessly integrates with the users' desktop environments and captures on-screen activities.

The mouse movement and keystrokes, are observed and captured as screenshots by the PD Sensor. These screenshots are sent to the Process Discovery Cloud platform. The essence of this process lies in the aggregation of these recorded events within the Process Discovery Cloud platform. Here, the events combine, enabling the platform to find patterns. These patterns, representative of sequences of events, subsequently serve as the foundation for the development of recommended processes.

**Note:** Check the **Data > Events** page to ensure the Process Discovery platform is receiving data from sensors.

The following lists the scenarios when an event is recorded:

1. Keystrokes: The Process Discovery sensor take screenshots when any key outside alphanumeric keys are pressed.

**Note:** Alphanumeric keys are all letters and numbers and some different symbols. These keys include all letters starting from A leading to Z and numbers from 0 to 9.

When Screenshot is taken	When Screenshot is not taken
Pressing a combinations of keys such as Control-C, Control-V or set of keystrokes followed by enter key.	Pressing all number keys (both on the top row of a keyboard but also specific number pads as well)
Pressing Enter and editing keys	Pressing all character keys such as QWERTY.
Pressing Function keys	Pressing modifier keys that change case – either Shift or Caps Lock  Pressing single key strokes: <ol style="list-style-type: none"> <li>a) Control key</li> <li>b) Shift key</li> <li>c) Alt key</li> </ol>

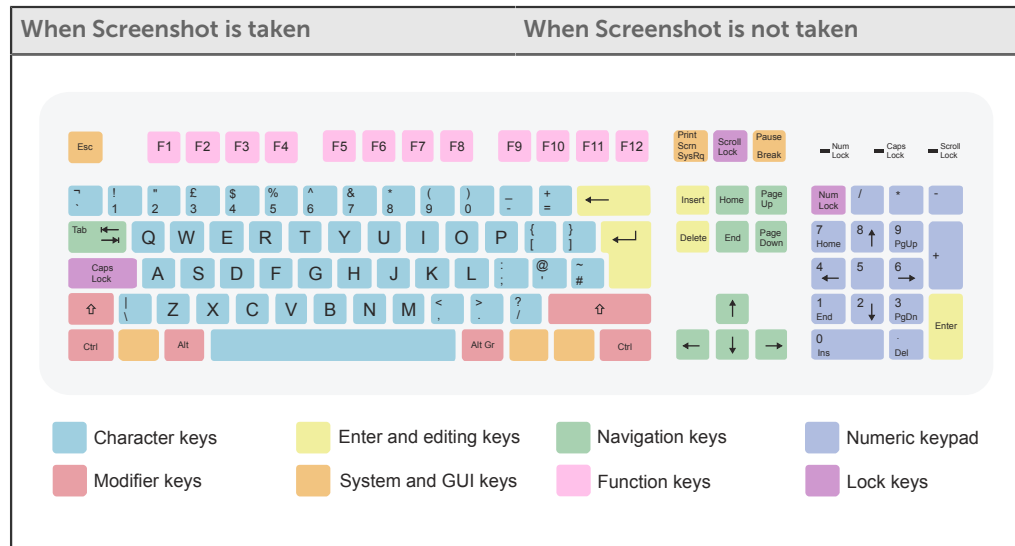

2. Mouse Clicks: When a mouse click is made the PD Sensor captures a screenshot as an event.

The captured events are sent to the Process Discovery Cloud platform through two pathways: direct transmission or through Privacy Enhanced Gateway (PEG). This gateway serves as an enabler of security and privacy, effectively redacting sensitive visual information before dispatching screenshots to the PD cloud.

Capturing these events is similar to creating a digital tapestry of user interaction. Each time an end-user performs a predefined keystroke, clicks the mouse, or even presses the enter key, an event is generated, and in conjunction, a screenshot is taken. This combination of mouse actions, keystrokes, and screenshots forms a complete event.

For instance, if you type "Wikipedia login" into a search box and then press the enter key constitutes an event. This single interaction, a combination of keystrokes and mouse clicks or enter key presses, creates an event. At this instant a screenshot is taken.

In short, a Process Discovery Event consists of metadata from keystrokes and mouse actions combined with the screenshots.

## Enable and disable the users recording

Learn how to enable or disable the Observers recording in the Process Discovery platform.

1. Log in to into the Process Discovery platform.
2. Navigate to **Data > Observers**.
3. Identify the Observer you want to enable or disable the recording.
4. From the **Actions** column, click the drop-down arrow to enable **Start Recording** for that Observer. To disable, select **Stop Recording** for that Observer.

## Process Discovery FAQ

Answers to frequently asked questions (FAQs) on the Process Discovery, Process Discovery Sensor, and Privacy Enhanced Gateway (PEG) applications.

This document describes Process Discovery and Privacy Enhanced Gateway security features: [Process Discovery Security Brief](#)

What versions of TLS is supported by Process Discovery?	Process Discovery supports TLS protocol versions 1.2 and 1.3 only.
Do the Automation Anywhere security risk assessment reports apply to the Process Discovery platform? What Audits are performed?	<p>Automation Anywhere has the following reports with Process Discovery as a component: ISO 27001</p> <p>Process Discovery is audited to the following frameworks and has the following reports:</p> <ul style="list-style-type: none"><li>• SOC 2 Type 2</li><li>• HIPAA</li><li>• PCI</li></ul> <p>In addition, the product is GDPR and CCPA compliant.</p>
Can users export their Security Information and Event Management (SIEM)?	<p>Users can export process data and event data into a .csv file. Process Discovery cannot be connected directly to a SIEM. The audit logs track all changes, who made the change, and when the changes are made to the following elements:</p> <ul style="list-style-type: none"><li>• Allow/block list</li><li>• Event logs</li><li>• Process Discovery configuration policy</li><li>• Observers</li><li>• Tenants</li><li>• Processes</li><li>• Windows</li><li>• Username</li></ul>
Is Multi-Factor Authentication (MFA) supported?	Yes, Single sign-on and SAML 2.0 are supported.
Does the Process Discovery platform use vulnerability management?	We have internal and external security testing programs. Internal testing spans planning, development, and testing phases, with each test building on previous work. We have an established approach to static and dynamic code analysis at both the development and testing phases. External testing is done on

	production and is built around the concept of ongoing assurance.
What is the Process Discovery Security Incident Management process?	<p>Incident Response: Automation Anywhere maintains an incident response program designed to analyze, contain, eradicate, and recover from security and safety incidents impacting Automation Anywhere managed networks and/or systems or customer data.</p> <p>Incident Notification: If Automation Anywhere determines that customer data within its control has been subject to a security incident, the customer will be notified under and according to applicable law.</p> <p>Incident Post-Mortem: Automation Anywhere runs a post-mortem after an incident has occurred to analyze and improve tools and processes to mitigate future occurrences.</p>
How does Process Discovery handle security configurations and changes?	<p>Automation Anywhere takes care of the following items:</p> <ul style="list-style-type: none"><li>• Secure multi-tenant environment on Google Cloud Platform</li><li>• Boundary security (FW, IDS)</li><li>• Source code scanning</li><li>• Pen testing Threat &amp; vulnerability scanning</li><li>• Container security management</li></ul>
Does Process Discovery have a disaster and recovery plan?	<p>We perform daily backups.</p> <p>As per our current disaster recovery policy of 2021, our recovery point objective (RPO) is 6 hours and recovery time objective (RTO) is 24 hours.</p>
Does the PEG redaction process allow users to set anonymized values instead of clearing out redacted values?	No.
Where are Support Teams located?	Our support teams are based around the world to provide follow-the-sun support with personnel located in the US, Europe, Japan, India, and Poland. Our support plans are designed to help you get the answers you need, when you need them, maximizing your investment in Automation Anywhere.
Can Automation Anywhere customer support see masked customer data?	No, the support teams do not have specialized access.
Is there any consent management platform to register client/consumer consent regarding data collection?	Since the customer organization owns their data, it is the responsibility of that customer to collect and maintain consent.

Is there a mechanism to delete stored data?	Yes, we can delete all of the data collected for various different criteria, including all of the data for specific times for a specific observer. If you want to delete data from storage, please notify Automation Anywhere customer support. The data will be permanently removed during the next backup process.
Is there a backup data retention policy in place?	Yes.
How do I increase the storage capacity of my Process Discovery cloud instance?	This is done automatically through the cloud service provider.
What is the total time required to get the PEG VM Image working on the Cloud Provider Environment (AWS, GCP, Azure)?	The time required to perform this task is highly dependent on skill set of the person completing the steps. For more information on the process, see <a href="#">Install PEG</a> on page 3852.
Does using PEG delay the transfer of data from the customer's instance to the Process Discovery cloud instance?	Yes. Data collected within an 8 hour period should transfer to the platform within 24 hours. The platform then can take up to 24 hours to process.
What will happen with PEG VM if the cloud service is down temporarily?	If forwarding mode is enabled, PEG will not forward events. After multiple attempts per event (about 5 attempts), PEG will mark the event as not forwarded and will not try it again.
How is Advanced Redaction implemented?	The latest PEG versions have all redaction settings now available in the user interface.
What is the PEG Analytics Portal?	It is the web interface to the Elastic database. It uses Open Distro (a Kibana-like tool) to enable customers to see the data, including a dashboard that shows which data is masked or in forwarding mode.
What encryption methods or key pairs are recommended for storage options specific to Azure, AWS and GCP?	We recommend you use the standard hard drive encryption methods available in those respective clouds using whatever mechanisms they provide.
How often does the Process Discovery Sensor upload data?	Every 5 minutes.
What is the CPU (VDI) Performance impact?	Typically 2 - 5 %
Are there any bandwidth metrics for typical usage?	Process Discovery Sensor typically sends about 10kpbs outbound.  For PEG, it is typically 10kpbs outbound multiplied by the number of concurrent sensors.
Will there be an admin who has access by default to the platform? What other users will have access to the instance and data?	See <a href="#">Process Discovery user roles</a> on page 3818.
Which versions of Microsoft Edge does Process Discovery support?	Any of the Chromium-based versions released after January 15, 2020.

Does the customer organization determine the apex domain for PEG DNS names, such as example.com?	Yes
Are events and PEG events stored off-site in case of a disaster recovery incident?	PEG events are not stored off-site. Process Discovery data is backed-up on a regular basis.
What are the storage requirements?	We require 2TB of storage and recommend SSD standard. Customers might need to delete data to free up space for each cycle.

## Process discovery by using Discovery Bot

You can use Discovery Bot to identify the processes in your business that can be automated. Discovery Bot identifies such processes by recording and analyzing user interactions with various systems for processes, comparing the potential ROI from automating these processes, and creating bots to automate the processes.

### What is process discovery

Process discovery is the first step in automation, in which the processes that can be automated in a business are identified. Process discovery is a method used to uncover business processes by recording user interactions with various systems and analyzing the recorded interactions to identify patterns. User interactions with any of the following types of systems can be recorded and analyzed:

- Enterprise solutions, such as ERP, CRM, business process management (BPM), and ECM
- Personal productivity applications, such as Microsoft Excel and Outlook
- Terminal and virtual environments, such as Citrix XenApp and Remote Desktop

### Why use Discovery Bot

Many companies begin their automation projects with manual process discovery and documentation. Manual review of process documentation requires interviewing business users and mapping work flows while performing daily operations involving additional resources, which can be time-consuming for businesses. This additional effort prevents or delays businesses from reaching the decision to automate their processes and reaping the benefits of automation. As a result, many of the automation opportunities are left undiscovered. Discovery Bot allows businesses to assess ROI from potential opportunities that can help with deciding and implementing automation for their processes.

### Capabilities

Discovery Bot helps in the following ways:

- Enables automatic process documentation and analysis, thereby saving time and resources
- Identifies the correct processes for automation for business users and citizen developers
- Enables business analysts and RPA developers to accelerate automation and maximize RPA ROI



- Converts automation opportunities into bot prototypes for further development and deployment by the automation developer

## How Discovery Bot is used

The Discovery Bot administrator creates processes and invites business users through an email invitation to participate in the recording of these processes. Business users record the steps they perform for various business processes. Discovery Bot aggregates the recordings and generates a proposed work flow. The business analyst can adjust the work flow to select and merge steps into branches from different recordings. From the work flow, the analyst identifies and prioritizes potential automation opportunities based on ROI. Opportunities are approved by the analyst, and Discovery Bot converts the opportunities to Task Bots for deployment.

The following image illustrates how Discovery Bot supports your automation journey from process discovery to bot creation.

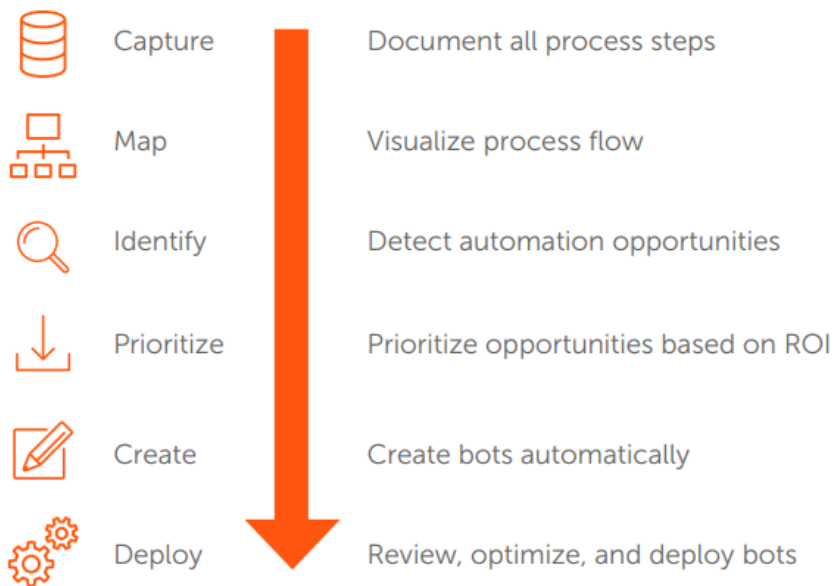

To view Discovery Bot tasks in an interactive visual format, see [Get started with Discovery Bot](#).

For an overview of how to get started with Discovery Bot, watch the following video:

See [Get started with Discovery Bot](#).

## Get started with Discovery Bot

Discovery Bot enables organizations to accelerate the automation of business processes from process discovery to bot creation.

- Ensure the system requirements are met.  
[Prerequisites for Discovery Bot](#) on page 3896
- Install and configure Discovery Bot for users in your organization.

---

[Installing Control Room On-Premises](#) on page 1177

1. Set up users and assign Discovery Bot roles.  
Assign Automation 360 users with the relevant Discovery Bot permissions and associated licenses.
  - [Discovery Bot users](#) on page 3890
  - [Supported licenses for Discovery Bot](#) on page 3892
  - [Create users for Discovery Bot](#) on page 3898
    - [Create multi-role users for Discovery Bot](#) on page 3900
    - [Create a custom role for Discovery Bot](#) on page 3902
    - [Assign the Discovery Bot custom role to a user](#) on page 3903
2. Set up the business process within your organization.  
Create a placeholder for collecting all of the recordings associated for a given process. Invite one or more users through email notification to a Discovery Bot process recording session.  
[Create a Discovery Bot process](#) on page 3905
3. Record the process.  
Business users record their work for the associated processes, annotate their steps, and submit for review a proposed automation work flow.
  - [Supported applications and browsers for Discovery Bot](#) on page 3908
  - [Record a Discovery Bot business process](#) on page 3910
  - [Record a Discovery Bot process using Automation Co-Pilot Desktop Assistant](#) on page 3914
4. Analyze the process.  
The relevant business users (subject matter experts (SMEs), RPM or business analysts (BA)) review the recording data and opportunities associated with the process for specific usage patterns.  
[Analyzing opportunities for automation](#) on page 3915
5. Create opportunities. Merge specific recordings or steps as required. Prioritize opportunities and generate bots automatically.
  - [Review opportunities, convert to bot, and generate PDD](#) on page 3916
  - [Using the Filter and Toggle frequency counter options](#) on page 3923

## Discovery Bot users

Various users are involved in the discovery process, and each user's role and responsibility helps in identifying potential automation opportunities for a business process. The streamlined workflow in Discovery Bot enables various users to collaborate without changing their operations in a major way.

Discovering processes for automation involves the following users:

Control Room administrator

Creates other users, assigns roles to users, and assigns Discovery Bot licenses for users

Discovery Bot administrator

Creates, edits, and deletes processes; also, associates Discovery Bot roles to and disassociates Discovery Bot roles from processes

Users with the Discovery Bot administrator privilege cannot view the recorded data of any process, participate in the recording analysis, or create new opportunities for automation.

Discovery Bot business user

Represents the task force in an organization that will benefit from process automations. The business user performs the following associated tasks for business processes:

- Performs the steps in the assigned process and records the steps

The business user is responsible for recording the steps in the process that are being reviewed and evaluated for potential automation candidates. The business user is invited to participate in recording session by the Discovery Bot administrator.

- Edits the **Step description** (annotated user text) field for recordings.

For each recording, the business user can review the recorded screen captures and provide annotations to capture the business context for the analyst to review. The business user can update the **Data** (keyboard entered) text field if the information should not be shared with the analyst, for example, user ID and password. If the captured steps are not relevant to the process, the business user can delete the steps before submitting the recording for review.

---

**Note:** After a recording has been submitted, it cannot be edited.

---

- Controls the recording of processes using the media control symbols on the Discovery Bot recorder.

Users can start, pause, resume, and stop the recording on demand by using the Discovery Bot recorder to capture the relevant steps for each process.

---

**Note:** After the recorder has been stopped, additional steps cannot be inserted into that recording.

---

## Discovery Bot analyst

This user can also be known by other names in an organization, such as process owner, process analyst, business analyst, or subject matter expert. The Discovery Bot analyst is responsible for reviewing the associated recordings and identifying potential candidates for automation. The analyst can perform the following steps:

- View all approved recordings from assigned users for a given process.

The analyst cannot edit the recordings; however, they can merge the necessary variations from multiple recordings and create an aggregate view of the process.

- Create opportunities from individual recordings and the aggregated view created from multiple recordings, and convert the opportunities into bots.
- Export a potential opportunity to a Word document for reference.

While it is not a prerequisite for the analyst to be knowledgeable about the processes they are reviewing, it is beneficial because this knowledge helps in easily selecting and analyzing the recordings.

## Supported licenses for Discovery Bot

Learn about the supported Discovery Bot licenses to ensure business workers are ready to begin using Discovery Bot.

Process Discovery licenses must be purchased for use for business analysts and business users using Discovery Bot. Discovery Bot supports two licenses:

- Process analyzer license for the Discovery Bot analyst

This license allows a user to view and manage the metadata from all recordings within the process and create, view, and manage opportunities created from the recordings.

- Process recorder license for the Discovery Bot user

The process recorder license allows a user to view, record, and submit a process using the Discovery Bot recorder.

The following table displays detailed information for supported licenses and permissions for Discovery Bot business workers:

Discovery Bot user	System-provided Discovery Bot role	Discovery Bot features	Discovery Bot license required
Discovery Bot admin	<b>AAE_Discovery Bot Admin</b>	<ul style="list-style-type: none"> <li>• Create, view, update, and delete processes.</li> <li>• Assign Discovery Bot analyst and business user to processes.</li> </ul>	None
Discovery Bot analyst	<b>AAE_Discovery Bot Analyst</b>	View assigned processes.  <b>Note:</b> Assigned processes are only displayed after the processes are created by the Discovery Bot admin.	Process analyzer
		View only recordings (including annotated steps and metadata) that they have created or been assigned to.  If a user is no longer assigned to a process, the user will lose access to the recordings.	Process analyzer
		View recordings, including metadata and annotated steps, for a given process.	Process analyzer
		<ul style="list-style-type: none"> <li>• Create, view, update, and delete manual generated aggregation</li> <li>• View all manually generated aggregations</li> </ul>	Process analyzer
		Create and view own opportunities for a given process.	Process analyzer

Discovery Bot user	System-provided Discovery Bot role	Discovery Bot features	Discovery Bot license required
		Convert an opportunity to a bot.	Process analyzer for opportunity creation. Bot Creator license is required to convert an opportunity to a bot.
		Export opportunity to Word.	Process analyzer

Discovery Bot user	System-provided Discovery Bot role	Discovery Bot features	Discovery Bot license required
Discovery Bot user	<b>AAE_Discovery Bot User</b>	<ul style="list-style-type: none"> <li>• Using the Discovery Bot recorder, create or more recordings for an assigned business process.</li> <li>• Update own recording to include annotations for the steps.</li> <li>• Delete one or more steps from own recording before submission.</li> <li>• View only recordings (including annotated steps, keyboard entered text, and application type) that they have created or been assigned to. The user can update the keyboard entered text field if the information should not be shared with the analyst (e.g. user ID and password).</li> </ul> <hr/> <p><b>Note:</b> Assigned processes are only displayed after the processes are created by the Discovery Bot admin.</p> <hr/> <p>If a user is no longer assigned to a process recording, the user will lose access to the recording data.</p>	Process recorder

## Prerequisites for Discovery Bot

To use Discovery Bot for your enterprise business processes, you must have an Automation 360 working environment and the associated dependencies installed: Bot Agent, browser extension, and so on.

### Supported versions and server requirements

Verify that you have the correct Control Room version installed. The Control Room deployment can be cloud or on-premises.

Ensure your Control Room server requirements are set up before installation. See [Control Room server requirements](#) on page 1187.

### System requirements

For Discovery Bot users' recording processes or assigned bot creation privileges, verify that your device meets the following system requirements:

- Windows machine is only supported for recording sessions.
- Oracle database is not supported on Discovery Bot.
- Set your local device credentials for any device that is connected to the Control Room. This is a one-time setup for each device. Ensure each device that you use accepts the credentials in your profile.
- [Set user device credentials](#) on page 1353
- Register your device and install the latest Bot Agent version on your machine. If you have not already installed the Bot Agent, when you log in initially, you will be prompted to install the Bot Agent from the **Processes** tab. Follow the prompts to install the Bot Agent. This will automatically add your user credentials.  
[Install Bot Agent and register device](#) on page 1347
- To record processes using Google Chrome, the Chrome plug-in must be installed.  
[Browser requirements for Automation Workspace](#) on page 1210
- Ensure your environment is ready to begin recording and analyzing processes using the Discovery Bot recorder. The prerequisites are similar to the Universal Recorder.  
[Record a task with the Universal Recorder](#) on page 2240
- Verify the Discovery Bot recorder requirements are completed.  
[Supported applications and browsers for Discovery Bot](#) on page 3908

### Update proxy settings

You must update your proxy settings to add the Automation Anywhere URL domain to the trusted list. The added URL domain is specific to your region of Automation Anywhere cloud. If you are using your proxy to access our cloud, you must avoid a redirect to your proxy. Remove any authentication type settings and policy acceptance.



## Installation requirements

The Discovery Bot installer is integrated with the Automation 360 installer. No separate installation is required for Discovery Bot On-Premises users. The IT administrator in your organization performs this task. See [Installing Control Room On-Premises](#) on page 1177.

---

**Note:** Ensure your database server requirements are met before using SQL authentication mode to connect to the Control Room: [Installing Control Room using Custom mode](#) on page 1245.

---

For custom installation, you can now change the default repository path location to a new location on your server after installation. The default path is: `C:\ProgramData\AutomationAnywhere\ServerFiles`. The Process Discovery files now reside in the ServerFiles folder.

---

**Note:** For Control Room admin. You must manually copy and paste the existing data into the new location if you change the default path to the new location.

---

The generated PDD file for an opportunity is now stored locally on your server by Automation 360 On-Premises. The path to the file storage is: `C:\ProgramData\AutomationAnywhere\ServerFiles\ProcessDiscovery\opportunity`. The existing PDD files will automatically be moved to the new location and will not be deleted when a reinstall or upgrade occurs in the Control Room.

## Verify installation

After the installation is complete, log in to your Control Room as an administrator. The Discovery Bot tab is available for use from the left panel.

## Process Discovery package

The Process Discovery package contains actions that record various object operations such as click (right or left), recording, and window resizing that are used during process recording sessions. View information about the Process Discovery package from the **View package** page (**Manage > Packages > Process Discovery**).

The package is included in the default packages. You can preload the default package when you connect to your device. Preloading the package helps to speed the start time of the recorder the first time you begin recording a process.

The actions in the package are not available for use from the Bot editor.

Related concepts

[Preload packages](#) on page 2310

You can preload packages on your local device to shorten the bot runtime.

## Upgrade Discovery Bot from Enterprise A2019.15 to later versions

Upgrade Discovery Bot from Enterprise A2019.15 (On-Premises) to a later version for the latest features and enhancements.

Enterprise A2019.15 provides a separate installer (executable file) for Discovery Bot On-Premises users to install and use Discovery Bot from the Control Room. Starting from A2019.16, the Discovery Bot installer is integrated with the Enterprise A2019 installer. To upgrade from Enterprise A2019.15 to a later version, you must first uninstall Discovery Bot from your machine and install the Control Room.

1. In your Windows device, go to **Apps & features**.
2. Search for Discovery Bot.
3. Click **Uninstall**.
4. Install the latest version of the Control Room.  
[Installing Control Room On-Premises](#) on page 1177
5. From your local machine, log in to your Control Room as an administrator.  
The **Discovery Bot** tab is available for use from the left panel.

## Create users for Discovery Bot

Create the Discovery Bot admin, analyst, and users to begin using the Discovery Bot functionality for front-office and back-office business processes. The Control Room admin creates these users and assigns the required system roles.

Ensure that you have purchased the necessary Discovery Bot licenses for your business users before you begin creating users: [Prerequisites for Discovery Bot](#) on page 3896.

To use the Discovery Bot features, the user must be assigned the appropriate role and licenses. See [Supported licenses for Discovery Bot](#) on page 3892.

---

**Note:** The Discovery Bot Admin role and permissions are distinct from the Control Room Admin role. See [Discovery Bot users](#) on page 3890.

---

1. From your local machine, log in to your Control Room as administrator.
2. Go to **Administration > Users**.
3. Click **Create user**.

The icon is located at the top-right of the **Users** table.

The **Create user** page is displayed.

4. In the **General Details** section, enter the following user details:

Enable User	Select the check box so that the user can log in immediately.
Username	Enter a unique user name.
Description	Optional: Enter a description for the user.

First name	Optional: Enter the first name of the user.
Last name	Optional: Enter the last name of the user.
Email	Enter and confirm the email address for the user. If SMTP is enabled, the user is sent an email to this address to confirm the account. Click the URL in the email to log in to the Control Room and set up your credentials. All important Control Room notifications will be sent to this email address.

5. In the **Select Roles** section, select one of the following roles from the **Available roles** column:

Discovery Bot user	Select this role
Admin	<b>AAE_Discovery Bot Admin</b>
Analyst	<b>AAE_Basic</b> and <b>AAE_Discovery Bot Analyst</b>  <b>Note:</b> The <b>AAE_Basic</b> role is required to view or add actions to the bots.
Business user	<b>AAE_Basic</b> and <b>AAE_Discovery Bot User</b>  <b>Note:</b> The <b>AAE_Basic</b> role is required to view or add actions to the bots created by the analyst.

6. Click the right arrow to move the role to the **Selected** column.  
 7. In the **Allocate a device license to this user** section, select the following:

Discovery Bot user	Action
Admin	Retain the default <b>None</b> for the user.  This user only has access to the Control Room.
Analyst	Assign the <b>Bot Creator - Development license</b> to this user.  <b>Note:</b> This license is required to convert an opportunity to a bot.
Business user	Retain the default <b>None</b> for the user.  This user only has access to the Control Room.

8. Under **Allocate other types of licenses for this user? > Discovery Bot licenses**, select the following:

Discovery Bot user	Action
Admin	No license is required.
Analyst	Select the <b>Process analyzer</b> license.

Discovery Bot user	Action
Business user	Select the <b>Process recorder</b> license.

9. Click **Create user**.

The new user is displayed in the User table. If SMTP is enabled, an email will be sent to the new user inviting them to log in.

[Create a Discovery Bot process](#) on page 3905

You can begin capturing business processes using Discovery Bot. Create a process and assign users to record and capture the process using the Discovery Bot recorder.

## Create multi-role users for Discovery Bot

Create multi-role users when you want to combine system-generated Discovery Bot roles and licenses to provide additional functionality for your users. Depending on your business requirements, you can combine up to three Discovery Bot system-generated roles and two process discovery licenses.

Ensure that you have purchased the necessary Discovery Bot licenses for your business users: [Prerequisites for Discovery Bot](#) on page 3896.

To use the Discovery Bot features, the user must be assigned the appropriate role and licenses.

**Note:** The Discovery Bot Admin role and permissions are distinct from the Control Room Admin role. See [Discovery Bot users](#) on page 3890.

Multi-role users will see a different set of menu actions (vertical ellipsis icon) available on a tile for a process. These actions are different from the standard Discovery Bot user actions that are available on a tile for a process.

The following actions are available for multi-role users (Admin + Business user + Analyst) on a tile for a process:

Admin actions

- View process details
- Edit process details
- Delete process
- View/edit process details

Business user actions

- Start recording
- The **Start Recording** icon is displayed on a tile for a process, or you can select start recording from the vertical ellipsis icon.
- Edit my recording

Analyst action

Analyze processes  
View process opportunities

1. From your local machine, log in to your Control Room as administrator.

2. Go to **Administration > Users**.

3. Click **Create user**.

The icon is located at the top-right of the **Users** table.

The **Create user** page is displayed.

- In the **General Details** section, enter the following user details:

Enable User	Select the check box so that the user can log in immediately.
Username	Enter a unique user name.
Description	Optional: Enter a description for the user.
First name	Optional: Enter the first name of the user.
Last name	Optional: Enter the last name of the user.
Password	Optional: Enter your password and confirm the password.
Email	Enter and confirm the email address for the user. If SMTP is enabled, the user is sent an email to this address to confirm the account. Click the URL in the email to log in to the Control Room and set up your credentials. All important Control Room notifications will be sent to this email address.

- In the **Select Roles** section, select the following roles from the **Available roles** column to create multi-role users:

Discovery Bot user	Select this role
Admin + Business user	<b>AAE_Discovery Bot Admin</b> and <b>AAE_Discovery Bot User</b>
Admin + Analyst	<b>AAE_Basic</b> , <b>AAE_Discovery Bot Admin</b> , and <b>AAE_Discovery Bot Analyst</b>
Business user + Analyst	<b>AAE_Basic</b> , <b>AAE_Discovery Bot User</b> , and <b>AAE_Discovery Bot Analyst</b>
Admin + Business user + Analyst	<b>AAE_Basic</b> , <b>AAE_Discovery Bot Admin</b> , <b>AAE_Discovery Bot User</b> , and <b>AAE_Discovery Bot Analyst</b>

- Click the right arrow to move the roles to the **Selected** column.

- In the **Allocate a device license to this user** section, select the following:

Discovery Bot user	Action
Admin + Business user	Retain the default <b>None</b> for the user. This user only has access to the Control Room.
Admin + Analyst	Assign the <b>Bot Creator - Development license</b> to this user.  <b>Note:</b> This license is required to convert an opportunity to a bot.

Discovery Bot user	Action
Business user + Analyst	Assign the <b>Bot Creator - Development license</b> to this user.  <b>Note:</b> This license is required to convert an opportunity to a bot.
Admin + Business user + Analyst	Assign the <b>Bot Creator - Development license</b> to this user.  <b>Note:</b> This license is required to convert an opportunity to a bot.

8. In the **Allocate other types of licenses for this user** section, select the following:

Discovery Bot user	Action
Admin + Business user	Select the <b>Process recorder</b> license.
Admin + Analyst	Select the <b>Process analyzer</b> license.
Business user + Analyst	Select the <b>Process analyzer</b> and <b>Process recorder</b> licenses.
Admin + Business user + Analyst	Select the <b>Process analyzer</b> and <b>Process recorder</b> licenses.

9. Click **Create user**.

The new user is displayed in the User table. If SMTP is enabled, an email will be sent to the new user inviting them to log in.

[Create a Discovery Bot process](#) on page 3905

Log in with your multi-role credentials and create a process. Assign users to record and capture the process using the Discovery Bot recorder. Review and analyze business processes.

## Create a custom role for Discovery Bot

Learn how to create a Discovery Bot custom role that allows users to select Discovery Bot feature permissions from standard business user roles (Admin, Business user, or Analyst roles), and a single Control Room admin feature permission for viewing users.

Ensure that you have purchased the necessary Discovery Bot licenses for your business users: [Prerequisites for Discovery Bot](#) on page 3896.

To use the Discovery Bot features, the user must be assigned the appropriate role and licenses.

**Note:** The Discovery Bot Admin role and permissions are distinct from the Control Room Admin role. See [Discovery Bot users](#) on page 3890.

Use case

The Discovery Bot custom role user is enabled with Control Room Admin feature permissions for viewing users, but does not have edit permissions. The role allows the user to view and manage all Discovery Bot feature permissions for processes, recordings,

aggregations, and opportunities. However, the role does not allow the user to view opportunities or the associated metadata created by other analysts in the **Opportunities** tab. The permission to view all opportunities is not enabled for the user.

1. From your local machine, log in to your Control Room as administrator.
2. Go to **Administration > Roles**.
3. Click **Create role**.  
The icon is located at the top-right of the **All roles** table.  
The **Create role** page is displayed.
4. Enter a **Role** name, and optionally enter a **Role** description.
5. Scroll to the **Administration** section.
6. Select **View users**.
7. Select **View roles**.
8. Scroll to the **Discovery Bot** section.
9. Select **View assigned process** at the parent level.  
The child-level permissions are enabled.
10. Select all the following feature permissions: .
  - a) **Discovery Bot** process feature permissions at the child level
  - b) **Discovery Bot** recording feature permissions at the parent and child levels
  - c) **Discovery Bot** aggregation feature permissions at parent and child levels
  - d) **Discovery Bot** opportunity feature permissions at the parent and child levels

---

**Note:** Do not select **View all opportunities**.

---

11. Click **Create role**.  
The **Discovery Bot** custom role is created.

[Assign the Discovery Bot custom role to a user](#) on page 3903

## Assign the Discovery Bot custom role to a user

Create a new user and assign the **Discovery Bot** custom role you created to the user.

Ensure that you have purchased the necessary Discovery Bot licenses for your business users: [Prerequisites for Discovery Bot](#) on page 3896.

To use the Discovery Bot features, the user must be assigned the appropriate role and licenses.

---

**Note:** The Discovery Bot Admin role and permissions are distinct from the Control Room Admin role. See [Discovery Bot users](#) on page 3890.

---

Custom role users will see a different set of menu actions (vertical ellipsis icon) available on a tile for a process, depending on the permissions given to users. These actions are different from the standard Discovery Bot user actions that are available on a tile for a process.

For this custom role use case, the following actions are available on a tile for a process:

Admin actions

- View process details
- Edit process details
- Delete process

Business user actions

- Start recording  
The **Start Recording** icon is displayed on a tile for a process, or you can select start recording from the vertical ellipsis icon.
- Edit my recording

Analyst action

Analyze processes

1. From your local machine, log in to your Control Room as administrator.
2. Go to **Administration > Users**.
3. Click **Create user**.

The icon is located at the top-right of the **Users** table.

The **Create user** page is displayed.

4. In the **General Details** section, enter the following user details:

Enable User	Select the check box so that the user can log in immediately.
Username	Enter a unique user name.
Description	Optional: Enter a description for the user.
First name	Optional: Enter the first name of the user.
Last name	Optional: Enter the last name of the user.
Password	Optional: Enter your password and confirm the password.
Email	Enter and confirm the email address for the user. If SMTP is enabled, the user is sent an email to this address to confirm the account. Click the URL in the email to log in to the Control Room and set up your credentials. All important Control Room notifications will be sent to this email address.

5. In the **Select Roles** section, select the **AAE\_Basic** role and the Discovery Bot custom role you created from the **Available roles** column.
6. Click the right arrow to move the roles to the **Selected** column.
7. In the **Allocate a device license to this user** section, select the **Bot Creator - Development license**.
8. In the **Allocate other types of licenses for this user** section, select the **Process analyzer** and **Process recorder** licenses.
9. Click **Create user**.  
The new user is displayed in the User table. If SMTP is enabled, an email will be sent to the new user inviting them to log in.



[Create a Discovery Bot process](#) on page 3905

Log in with your custom role credentials and create a process. Assign users to record and capture the process using the Discovery Bot recorder. Review and analyze business processes.

## Create a Discovery Bot process

Create a Discovery Bot process and assign users to record and analyze a process for your automation requirements.

- This task is performed by the Discovery Bot admin who manages the creation, deletion, and editing of Discovery Bot processes.

---

**Note:** Multi-role and custom role user can also perform this task depending on the roles or the permissions given to users. You will see a different set of menu actions (vertical ellipsis icon) available on a tile for a process.

---

- Ensure the **Process recorder** license is allocated to Discovery Bot users assigned to recording a process.
- Ensure the **Process analyzer** license is allocated to the Discovery Bot analyst assigned to analyzing a process.
- Create a process and assign users:
  - a) From your local machine, log in to your Control Room as a Discovery Bot administrator.
  - b) Go to **Discovery Bot > Processes**.
  - c) Click **Create Process**.  
The **Create process** page is displayed.
  - d) In the **General Details** tab, enter a **Process Name**.  
Special characters are not supported. Creating a process with a duplicate name is not supported.
  - e) Optional: Enter a **Process Description**.
  - f) Click **Next** to assign users to a process.
  - g) Optional: In the **Users** tab, select the Discovery Bot business user or analyst from the list of **Available** users.
  - h) Click the right arrow to move the roles to the list in the **Selected** column.
  - i) Click **Next** to view the invitation that is sent to users to begin recording processes.
  - j) Click **Create Process**.
  - k) Click **Close** to exit the page and return to the **Processes** page.

---

**Note:** An email invitation is sent to assigned users (new users or users added at a later time) to begin a Discovery Bot process recording session.

---

The newly created process is displayed in the **Processes** page on a tile.

For users, all of their assigned processes are available for viewing from the **Processes** page. Use the search field to help you locate a specific process by name. The field is not case-sensitive. For users, use the field to search on a process you are assigned to. For admin users, use the field to search on all processes. Use the sort field to help you locate a process tile quickly. Click the drop-down to sort for a process tile based on the process

name in alphabetical order or you can sort in the order of newest process created to oldest process and vice versa. The tile for a process displays the following information for an admin user:

Process tile	Description
Recordings	The number of the recordings captured and stored for a process by users.
Process Cycle	The average time, in minutes and seconds, across all recordings captured for a process.

Process tile	Description
<p data-bbox="509 247 889 275">Vertical ellipsis icon (three dots)</p> <hr/> <p data-bbox="509 310 927 464"><b>Note:</b> You might see a different set of menu actions available from the tile if you are a Discovery Bot standard user, multi-role user, or custom role user.</p> <hr/>	<p data-bbox="976 247 1417 306">View, edit, or delete information for a process.</p> <ul style="list-style-type: none"> <li data-bbox="976 327 1386 449">• Click <b>View process details</b> to view more information about a process, edit and update information, and save changes.</li> <li data-bbox="976 459 1406 613">• Click <b>Edit process details</b> to edit a process. Enter your changes and click <b>Save changes</b>. Click <b>Close</b> to return to the <b>Processes</b> page.</li> </ul> <hr/> <p data-bbox="1013 648 1398 707"><b>Note:</b> The name of the process cannot be changed.</p> <hr/> <ul style="list-style-type: none"> <li data-bbox="976 732 1377 825">• Click <b>Delete process</b> to delete a process. A message window appears.</li> <li data-bbox="976 835 1349 894">• Click <b>Yes, delete</b> to delete a process.</li> </ul> <p data-bbox="1013 911 1422 1003">All recordings and associated data are permanently deleted. This cannot be undone.</p> <p data-bbox="1013 1022 1403 1081">Click <b>No, cancel</b> to return to the <b>Processes</b> page.</p> <ul style="list-style-type: none"> <li data-bbox="976 1092 1422 1341">• Click <b>View/edit process details</b> to view more information about a process, edit and update information, and save changes. To edit a process, click <b>Edit</b>. Enter your changes and click <b>Save changes</b>. Click <b>Close</b> to return to the <b>Processes</b> page.</li> </ul> <hr/> <p data-bbox="1013 1377 1398 1436"><b>Note:</b> The name of the process cannot be changed.</p> <hr/> <ul style="list-style-type: none"> <li data-bbox="976 1461 1386 1520">• Click <b>Edit my recording</b> to edit and review recordings.</li> <li data-bbox="976 1530 1422 1652">• Click <b>View process opportunities</b> to view auto-generated or custom opportunities created from the <b>Opportunities</b> tab.</li> </ul>

- Create a process and add users at a later time:
  - a) From your local machine, log in to your Control Room as a Discovery Bot administrator.
  - b) Go to **Discovery Bot > Processes**.

- c) Click **Create Process**.  
The **Create process** page is displayed.
  - d) In the **General Details** tab, enter a **Process Name**.  
Special characters are not supported. Creating a process with a name previously used for another process is not supported.
  - e) Optional: Enter a **Process Description**.
  - f) Click **Create Process** to create a process without assigning users.
  - g) Click **Close** to exit the page and return to the **Processes** page.
- Update an existing process and add users.
    - a) From your local machine, log in to your Control Room as a Discovery Bot administrator.
    - b) Go to **Discovery Bot > Processes**.
    - c) Go to the process you want to edit.
    - d) Click **Edit** from the **Options** icon.
    - e) In the **Edit process** page, click **Next** to assign users to a process.
    - f) In the **Users** tab, select the Discovery Bot business user or analyst from the list of **Available** users.
    - g) Click the right arrow to move the roles to the list in the **Selected** column.
    - h) Click **Save changes**.
    - i) Click **Next** to view the invitation that is sent to users to begin recording processes.
    - j) Click **Close** to exit the page and return to the **Processes** page.

---

**Note:** An email invitation is sent to assigned users (new users or users added at a later time) to begin a Discovery Bot process recording session.

---

The newly created process is displayed in the **Processes** page on a tile.

[Record a Discovery Bot business process](#) on page 3910

Log in to your Control Room as a Discovery Bot user and record a business process assigned to you.

## Supported applications and browsers for Discovery Bot

Learn about supported applications and browsers to ensure your environment is ready before you begin using the Discovery Bot recorder.

### About the Discovery Bot recorder

The Discovery Bot recorder is similar in function to the Automation 360 Universal Recorder with one significant difference: pre-selection of the application to be used for recording is not required.

The Discovery Bot recorder captures data across many user interface (UI) objects such as Windows applications, native applications, executable file, or browser window on PC devices and

machines or virtual machines running Windows OS. Use the Discovery Bot recorder to capture, read (data extraction), write (data entry), and click (left or right) operations when working across various operations. A single recording per user can capture up to 8 hours of user actions.

The Discovery Bot recorder displays the performed action by using highlighter. Click the object control, for example, a button, form field, or a table. A red outline highlights the control when you move the mouse over it to capture the action.

You can perform actions like double-click, drag-drop, click and hold, and text select while recording. Actions performed using keyboard strokes are displayed in the **Data** field.

## Supported applications and browsers

The recorder supports system, web, and virtual applications including the following:

### Applications

- Microsoft applications: Edge, PowerPoint, Excel, Word, Outlook, Calculator, Notepad, Notepad++, Teams
- Zoom
- Snagit
- Java applet, web start, and desktop applications that run using Java Runtime Environment (JRE) 6, 7, 8, 9, 10, and 11 (32-bit and 64-bit versions)
- Microsoft Active Accessibility and UI automation based applications
- Oracle EBS and Forms
- SAP 730, 740, 750 and 760 versions.
- Citrix Virtual Apps

### Browsers

- Internet Explorer version 11
- Google Chrome

---

**Note:** Chrome plug-in must be installed to record processes. If the Chrome plug-in is removed, you must manually add and re-enable the plug-in. [Google Chrome browser extension requirements](#) on page 2250

---

### Desktop

The desktop refers to the device screen when all application and browser windows are minimized.

### Taskbar

The taskbar is the horizontal or vertical bar containing icons of open applications and browsers, as well as the notification area. You can capture application, browser, system, and other icons, for example such as the clock and calendar, volume, and Wi-Fi.

## Record a Discovery Bot business process

Record, capture, and annotate steps for a business process using the Discovery Bot recorder. The process recording allows the Discovery Bot analyst to view all recorded steps for a quantitative and comparative analysis. The steps along with the captured metadata and user actions help the analyst make the decision to create opportunities and bots.

- This task is performed by the Discovery Bot user who records assigned business processes and submits the same for review and analysis.

---

**Note:** Multi-role and custom role user can also perform this task depending on the roles or the permissions given to users. You will see a different set of menu actions (vertical ellipsis icon) available on a tile for a process.

---

- Ensure that you have set your device credentials and installed the latest Bot Agent version on your machine before using the Discovery Bot recorder.
- Ensure that the machine on which you will be performing the recordings is also duly registered.

[Prerequisites for Discovery Bot](#) on page 3896

1. Record a business process:
  - a) From your local machine, log in to your Control Room as Discovery Bot business user.
  - b) Go to **Discovery Bot > Processes**.  
The **Processes** page appears, displaying all processes assigned to the user for recording.
  - c) Click the **Start Recording** icon from the tile associated with the process you want to begin recording a process.

---

**Note:** You can also select, **Start Recording** from the from the vertical ellipse icon to begin recording a process.

---

A message window appears notifying you that you are now recording and sharing your screen. The **Discovery Bot Recorder** window is displayed with **Pause** and **Stop** options. Pause and resume the recording as required. Allow for a few minutes for the recorder to start the very first time you begin recording a process.

- d) Perform the actions to record.  
For example, open an application and fill in a form or open a browser and search a website. Click the object control, for example, a button, form field, or a table. A red outline highlights the control when you move the mouse over it to capture the action. The red outline indicates that the recorder is ready for you to take the next action in recording the process.  
You can perform actions like double-click, drag-drop, click and hold, and text select while recording. Actions performed using keyboard strokes are displayed in the **Data** field.
- e) Click **Stop** to end the recording.  
You can click **Cancel recording** to cancel a recording at any time.  
Wait for a few seconds for the recorder to end. The details in the tile for the process is incremented to include the new recording in the **Recordings** section.

---

**Note:** Once the recording has been stopped, additional steps cannot be added to the recording.

---

**Note:** A maximum of 8 hours worth of user actions can be captured in a single recording.

- f) Enter a name for the recording in the field provided.  
The character limit is 50. Special characters are supported.
- g) Click **Save** to save your changes.
- h) Click **Cancel** to discard the recording.

**Note:** If you discard the recording, you cannot recover it.

2. Review the captured steps, annotate them, and submit a process recording for review to the Discovery Bot analyst:

- a) From **Processes**, select a process by clicking the process name or anywhere within the process tile body. From **Processes**, click the vertical ellipsis icon and select **Edit my recording** to edit and review recordings.

If you click the process tile body or the process name, the **Opportunities** page appears. Only approved recordings from the **Opportunities** tab are displayed for the analyst.

For Discovery Bot multi-role and custom role users, click the vertical ellipsis icon and select **Edit my recording** to edit and review recordings. If you click the process tile body or the process name, the **View process** page appears. Only approved recordings are displayed for the analyst on the **View process** page.

The **Recordings** page appears with the **Recordings** table on the left and single recording details on the right. The table displays the following information:

Recordings	Description
Recordings (#) (# selected)	The number of recordings logged in by users.
Customize columns	Click the table icon to display or hide columns (ID, Status, Process Cycle, and Recorder), or edit the layout of the header rows to display right or left as required.
ID	The ID number of the recording in the database. The system collects and sequentially increments the index for each recording captured by the users.  <b>Note:</b> To search for a specific recording, select <b>ID</b> and enter the ID number in the search bar.
Name	The recording name.

Recordings	Description
Status	<p>The status of the recording:</p> <ul style="list-style-type: none"> <li>• Pending: Initial state.</li> <li>• Approved: All user-required edits have been completed and recording is ready for review by an analyst.</li> <li>• Error: There is an error when storing the recording in the system.</li> <li>• Declined: Currently not being used.</li> </ul> <hr/> <p><b>Note:</b> To search on a process status, select <b>Status</b> and choose a status from the drop-down list.</p>
Process Cycle	<p>The recording duration, in minutes and seconds, excluding the time that the recorder was paused.</p>
Recorder	<p>The name of the user that created the recording.</p> <hr/> <p><b>Note:</b> To search on users assigned to a recording, select <b>Recorder</b> from the drop-down list and enter the user name in the search bar. The search is case-sensitive.</p>

- From the **Recordings** table, select a recording to view all captured steps. In the right pane, the header displays the recording ID details, including the total steps captured during the recording session, recording name, process time, and current recording status.  
Each recorded step includes: screenshot image with the **Screen** option (icon), application type, data (keyboard entered text), and step description (annotated user text) fields.
- Optional: To provide a description for the recording, click in the **Description** area. Using the **Description** field that appears, share the context and the purpose of the recording with the analyst.  
The character limit is 255. The description entered is displayed in the PDD.
- Click **Save** to save the description you entered in the **Description** field.
- Optional: Click the **Screen** icon to display or hide the screenshot image.  
Use the **Screen** option icon when you do not want to share personal image details with the Discovery Bot analyst, multi-role, or custom role users. To remove personal information, for example username and password credentials from the image, edit the **Data** field prior to submission for analyst review.

---

**Note:** If you hide an image and Click **Submit**, you cannot display the image again.

---



7. Click the screenshot to display the image in full size.

The **Screenshot** shows the state of the application at the time of performing the associated action. The red outline highlights where you have performed actions like click and hold and text select. You cannot edit the screenshot. Click the image when you want to display a larger view of the screenshot. Review the step action in more detail from the modal window. Click the pagination located below the image to select a step number or use the right or left arrows to quickly display all captured images. For actions not captured by the recorder such as double-click, drag-drop, and click and hold, you can document the individual steps in the **Step description** field for the analyst.

The duration of the recorded step is displayed in minutes and seconds below the screenshot. Use this information to help prioritize what step or sequence of steps are a better candidate for automation. For example, if a sequence of steps takes longer to perform, you can automate this first for a process to save manual effort.

- Click the **Hide image** icon to hide the image.

The image will not be submitted to the analyst for review. Click **X** to close the frame. Click **Save** to save your selection.

- Click **Show image** to display the image.

The image will be submitted to the analyst for review. Click **X** to close the frame. Click **Save** to save your selection.

8. Optional: Update the application name used in the process recording in the **Application** text field.

The **Application** field represents the name of the application on which the action was performed. If required, the user that made the recording can change this.

9. Optional: Update the keyboard entered text used in the process recording in the **Data** text field.

The **Data** field represents any data entered by the user at that step during the recording.

---

**Note:** You must follow the keyboard data entry with a left or right mouse click. For any step in which the data was entered, you can make changes to the data in the **Data** field. You cannot enter any data for steps which do not have any data entered during the actual recording of the process.

---

10. Optional: Update the context associated with the step in the **Step description** text field.

The **Step description** text field represents any additional description that you would like to provide regarding the operation being performed. The maximum character limit is 2000.

11. Optional: Delete any step that is not required to be included in the process recording.

12. Repeat the above steps for each step as required.

13. Optional: Click **Save** to save your changes.

Use the **Save** option when you want to edit and compare the recording data (including application, keyboard entered text, and annotation text fields) across multiple recordings captured in the **Recordings** table.

14. Optional: Click **Delete** to delete the recording for that process.

Use the **Delete** option when you do not want to submit the recording data to the analyst for review.

The recording and associated data is deleted from the **Recordings** page for that process.

15. Click **Submit**.

The recording is submitted to the analyst for review and approval.

**Note:** After a recording is submitted, it cannot be edited to make additional changes.

---

16. Click the **Download** option to export the opportunity data into a Process Definition Document (PDD) with the same name as the opportunity. Select the type of PDD (Word or PDF) that you want to export. The PDD includes the process recording flow chart and the time on each individual step in hours, minutes, and seconds.

When an opportunity is created, the PDD begins processing in the background automatically. When the PDD is generated, the field changes from Processing PDD to **Download**. You can now download the document. An email notification to the business user is also sent to the email address on file. If an error occurs when you download the PDD, click **Download** again to generate the PDD again.

---

**Note:** If you are a multi-role user, you will receive two email notifications for the exported data, one for the recording data and one for the opportunity data.

---

**Note:** You must be the owner of the opportunity to be able to download it; otherwise, the download option is not available.

---

On your machine, the document is saved in the folder that is configured for downloads in your browser.

[Analyzing opportunities for automation](#) on page 3915

Log in to your Control Room as a Discovery Bot analyst to review and analyze the recordings to create opportunities or bots as required.

## Record a Discovery Bot process using Automation Co-Pilot Desktop Assistant

Use Automation Co-Pilot Desktop Assistant to record Discovery Bot business processes without signing in to the Control Room.

- Before using the Discovery Bot recorder, ensure that you have set your device credentials and installed the latest version of the Bot Agent on your machine.
- 

**Note:** The Bot Agent installation will load the Automation Co-Pilot icon on your desktop.

---

- Ensure that the machine on which you will be performing the recordings is also duly registered.

[Prerequisites for Discovery Bot](#) on page 3896

- Ensure that your browser settings allow redirects and pop-ups from your browser to access the Control Room.

1. Double-click the Automation Co-Pilot icon to open the Automation Co-Pilot Desktop Assistant.
2. Use Automation 360 credentials to sign in to the application.
3. Click **Processes**.  
The **Recording Processes** page appears, displaying all the processes assigned and available to the user.
4. When you want to start recording a process, click **Start recording**.

A message window appears, notifying you that you are now recording and sharing your screen. The **Discovery Bot Recorder** window is displayed with **Pause** and **Stop** options. Pause and resume the recording as required. The first time you begin recording a process, the recorder might take a few minutes to start recording.

5. Perform the actions to record.
6. To end the recording, click **Stop**.  
You will be redirected to the Control Room to review and edit your recording before you submit it. [Record a Discovery Bot business process](#) on page 3910
7. To review the steps of previous recordings and submit them, click **Previous recordings**.  
You will be redirected to the Control Room to review the recordings.

## Analyzing opportunities for automation

Review opportunities and process recording data by using graphs and charts that help you to analyze and understand the benefits and savings from a potential opportunity with or without automation.

### Opportunities

The Opportunities header provides a snapshot of the recording and opportunity data captured by all users for assigned processes. The following data is displayed in the **Opportunities** header:

Field	Description
Savings	The potential savings (yearly savings or savings per run) associated with the opportunity
Number of opportunities	The number of opportunities that include the selected recordings
Number of process variants	The number of branches included in the opportunity
Average process cycle	The average duration of the recordings provided for the process
Participants	Number of users who submitted recordings for the process

### Opportunities evolution

Use the opportunities evolution map as a guide to decide which opportunities to automate first. Each quadrant displays the following:

- **Proceed now:** These opportunities yield the maximum benefit and ease of implementation.
- **Long term:** These opportunities yield good ROI but will take time to implement. They also require a higher implementation effort to automate.
- **Hold:** The automation benefit is low and the implementation time is high. The recommendation is not to automate.

- **Quick wins:** Always do this first to build momentum.

## Application usage

The donut chart displays the number of applications used across selected recordings. The application usage details are displayed in the table to the right of the chart in the following format: Application | minutes seconds | percentage. The percentage represents the percent of the application used over a total of all applications used.

## Use case

Use this information to quickly understand user participation and process complexity and variability; the higher the application count, the higher the complexity and variability of the process that is being analyzed. The average process cycle time will provide a quick insight into the duration of the process within the expected processing time. If the actual process cycle is higher across application count, this might be an indicator that the process is a more suitable candidate for automation and assists with improving efficiency.

## Process cycle time by process

This graph displays the time associated with the average process cycle (in minutes) for each process and by user.

## Use case

Use this information to help you understand which processes take the most time and therefore, will potentially give you more savings if automated. For example, an analyst can learn why a process recording took longer or was completed in a shorter period for one particular participant and compare this information with other participants. This information is instrumental in narrowing down on a smaller subset of the process recordings to study them for inefficiencies that might result in better or more opportunities for automation.

## Number of steps by a process

This graph displays the average number of manual steps in each process and by user. Use this information to compare the number of steps across processes. Processes with greater number of manual steps are more likely candidates for automation.

## Review opportunities, convert to bot, and generate PDD

Review potential, system-generated opportunities, create custom opportunities from a system-generated opportunity, and convert them to bots. You can also export the opportunity data to a Microsoft Word or PDF document for your reference.

Automation opportunities are of two types, system-generated and manual. System-generated opportunities, also known as auto-generated opportunities, are created when at least one

recording is approved by the user for a process. The auto-generated opportunities are available immediately for you to begin analyzing from the **Opportunities** page for the recording. The **Download** option to generate a Microsoft Word or PDF document is not available for auto-generated opportunities. Creating a branch and merging steps into the branch for auto-generated opportunities is not available from the process diagram.

Manual opportunities, also known as custom opportunities, are created from auto-generated opportunities. A custom opportunity allows you the flexibility to review current and newly added recordings from users and decide to accept or reject the new recording changes to the existing process diagram. You can also create a branch as you add steps from another recording to the process diagram. The **Download** option is available for you to use if you want to download a Microsoft Word or PDF document of the custom opportunity data for your reference.

- This task is performed by the Discovery Bot analyst who is in charge of reviewing and analyzing the associated recordings of business processes.
- Ensure the analyst is assigned a Process analyzer license and the **AAE\_Discovery Bot Analyst** role before processes are analyzed.

[Supported licenses for Discovery Bot on page 3892](#)

- Ensure the analyst is assigned a Bot Creator license to convert opportunities to bots.

[Supported licenses for Discovery Bot on page 3892](#)

1. Review the data in the **Opportunities** tab:
  - a) From your local machine, log in to your Control Room as Discovery Bot analyst.
  - b) Go to **Discovery Bot > Opportunities**.

The **Opportunities** page displays all the opportunities you have created. You can configure the menu option to display as you want using the **Customize columns** icon. The table lists the following information:

Field	Description
Opportunity name	The name created for the opportunity. To identify an auto-generated opportunity from a custom opportunity, the auto-generated opportunity begins with the name of the process hyphen OPPORTUNITY.
Process name	The name created for the process.
Type	The type of opportunity created for a process. The type can be Auto or Custom.
Path	The type of path specified based on the <b>Filter</b> option applied to the opportunity. Auto-generated opportunities use filter default value of Most common path.
Date created	When the opportunity was created.

Field	Description
Date modified	The date the opportunity is modified by the analyst. The modified date can occur when a opportunity is updated or when a custom opportunity is created.
Owner	The name of the process owner. The process owner can be system or analyst.
# of recordings	The number of recordings for a process associated with the opportunity.
# of applications	The number of applications used in a recording session associated with the opportunity.
Process cycle	The duration of the recording session associated with the opportunity.
# of users	The number of users who participated in the recording session for that process.
Cost without automation	The formula used to calculate the cost of the opportunity without automation. Use the formula to help you decide which opportunities to prioritize for your business development based on ROI, applications used, number of users, and so on. The formula is calculated by taking the number of users multiplied by the total hourly pay of number of users multiplied by the average process cycle.
Savings	The potential savings associated with the opportunity (this could have been specified as a yearly savings or savings per run).
Priority	The priority level assigned to the opportunity. The priority can be one of the following: <ul style="list-style-type: none"> <li>• Low</li> <li>• Medium</li> <li>• High</li> </ul>

Field	Description
Bot created	The bot created for an opportunity. This can be Yes or No. The <b>Convert to bot</b> option is not available for auto-generated opportunities. The <b>Convert to bot</b> option is available for custom opportunities only.

- c) Select the required opportunity by sorting, searching, or both from the table using the **Search** field.
  - d) Click the vertical ellipsis icon (three dots) from the table to view an opportunity or download a Word or PDF PDD document.  
The PDD download option for Word or PDF is only available for custom opportunities.
  - e) Select an opportunity from the table for display.
2. Optional: Create a custom opportunity from the autogenerated opportunity.
- a) Expand the **Recordings** section from the left side of the main canvas.  
By default, all selected recordings are displayed in the process diagram.
  - b) Select a single recording from the **Recordings** section for review, as needed.  
The selected recording is colored in blue from the **Recordings** section and displayed in the new feeder canvas to the left of the main canvas. All recordings are displayed in the process diagram to the right of the main canvas. Toggle off the selected recording to select another recording for display.
  - c) Select either the screenshot icon or the application icon to decide how you want to display the steps.  
Use the **Zoom in** or **Zoom out** options as required. Use the **Reset** zoom to bring the view back to the default level and recenter the process in the canvas.  
Contiguous steps performed in the same application are combined together. This is displayed as a single group to allow better readability of the process. The number of steps collated together is indicated in the bottom-right corner of the group.
- 
- Note:** If the screenshot view is the last active view, then the image of the last step in the group is the one that is displayed for the collapsed group. You can drag the process within the canvas by holding down the mouse left button and moving the process to the desired location.
- 
- d) Click a step to expand a group of steps to preview the step in more detail. Alternatively, click the arrow near the top-right corner of the group icon.  
Use the group icon to display groups of steps that belong to the primary and secondary level actions (and subgroup level actions) used during the recording session. As required, expand a group of steps to drill down from the primary to subgroup-level actions to help you decide what group of steps to use when creating a potential opportunity for a task that you want to automate. For example, a primary-level action displays Microsoft Outlook, a secondary-level action displays Outlook mail notification, and subgroup-level actions can display compose email, body email, and send email.
  - e) Select the **Select all steps** check box from the **Overview** pane to select all the steps in the process diagram.

Based on your requirements, use the Shift key to customize the number of steps within a path from the main canvas. If you select a nested branch or loop, the parent branch or loop displays a partial selection.

- f) Optional: Use the **Filter** option to customize a specific opportunity. [Using the Filter and Toggle frequency counter options](#) on page 3923.
- g) Optional: Use the **Toggle frequency counter** option to display the frequency of path as compared to other recordings. For more information, see [Using the Filter and Toggle frequency counter options](#) on page 3923.
- h) Click **Save as** to save the opportunity as a custom opportunity.
- i) Enter a name and description for the opportunity in the fields provided.
- j) Click **Save as** to save your changes.  
A message window appears notifying you that the opportunity is created. Click the hyperlink to view the custom opportunity. The PDD is generated and available for download from the **Opportunities** table. Click the vertical ellipsis to download the PDD in Word format or PDF.

---

**Note:** The filter option you selected for a custom opportunity will not be reflected in the new custom opportunity process diagram.

---

3. Optional: Create another custom opportunity from a custom opportunity. Add steps from another recording to the process diagram, create a branch, and merge steps from one or more recordings into the branch.
  - a) Select a single recording from the **Recordings** section.
  - b) Click the branch icon from the right main canvas to add a condition step.  
Moving the subsequent step into a branch on the left and adding a new branch to the right in the empty branch are to receive steps from another recording. In the top-right corner of the yellow box, click the three dots to create a new branch or delete a branch. The branch endpoint is displayed with a small circle.  
By default, you can move the branch endpoint lower in the path flow to include more than one step. To move the branch endpoint, press down with the cursor on the endpoint until you see the dotted lines appear around the branches. Drag the endpoint downward in the path flow. Place the endpoint when you see the dotted lines appear between the arrow. The endpoint is shifted downward in the path flow and includes more steps. To select a custom selection of steps, use the Shift key to select a certain number of steps within a path from the main canvas. Cross-path selection is not available.  
The loop icon is displayed as an orange circle with an arrow. A loop is a sequence of steps that occurs for a specific number of times for a single recording. The loop icon has a **for** condition displayed under this along with **Count**, which describes the number of times the sequence of steps in this loop is repeated in the process. You can change the loop condition (**for** and **while**) by saving the process diagram.
  - c) Click the **Condition** field at the node level.
  - d) In the **Condition** field, enter a name for the condition. Example, `credit score`.
  - e) Click the check mark to save the name for the condition.
  - f) Open the corresponding branches on the right and left and set a value for the condition. For example, enter less than 200 on the right and greater than 700 on the left.



- 
- g)** Drag and drop steps from the recording in the feeder canvas into the receiver step that reads **Drag items here** of the branch in the main canvas.  
Use the Shift key to select one or more steps to drag into the receiver step. To clear a condition in the branch, click the three dots. Select **Clear branch**.
  - h)** Click **Save** to save your changes to the process diagram.  
The PDD begins processing in the background automatically. When the PDD is generated, the field changes from Processing PDD to **Download**.
  - i)** Repeat steps a through h to review additional recordings and create branches and merge steps into the branch.
  - j)** From the **Overview** pane, click the **Edit** icon to update the potential savings associated with the custom opportunity.  
The potential savings and potential cost can be updated at any time as you review the steps from various recordings and make changes within the process diagram.
  - k)** Enter the estimated cost of the process without automation.
  - l)** Enter the potential savings associated with the process when automation is used.  
This is your best assessment of the expected savings on an annual basis if a bot is used to perform all the steps in the opportunity.
  - m)** Select the priority from the drop-down list.
  - n)** Click **Update**.
  - o)** Click **Save** to save your changes to the process diagram.
  - p)** Repeat steps j through o to update the potential cost for the custom opportunity from the **Overview** pane.
  - q)** Click **Save as** to save the opportunity as a custom opportunity.
  - r)** Enter a name and description for the opportunity in the fields provided.
  - s)** Click **Save as** to save your changes.  
A message window appears notifying you that the opportunity is created. Click the hyperlink to view the custom opportunity.
  - t)** Optional: Repeat steps 4a through s to create another custom opportunity from this custom opportunity, as needed.  
All opportunities (autogenerated and custom) can be viewed from the **Opportunities** page.
- 4.** Optional: For custom opportunities, review new recordings submitted by the Discovery Bot user. Accept or dismiss the new changes for the process diagram.
- a)** Click **Review** to accept the updates and review the new recordings.
  - b)** Select the new recording from the **Recordings** section.  
The selected recording is highlighted in blue. The recording opens for display to the left of the canvas. Refer to the dotted lines around the steps. The placement of the steps is displayed in the process diagram to the right of the canvas with a bold border around the steps. The shaded green refers to the placement of the groups of steps from the new recording as they will appear in the process diagram if you update with these changes.
  - c)** Click **Update with changes** to accept the updates to the process diagram.  
A pop-up message is displayed, indicating that your changes are successfully updated.
-

- d) Click **Back to edit** to return to the current process diagram without the changes.
- e) Click **Dismiss** to dismiss the changes.  
Continue reviewing the current process diagram for the custom opportunity. Add steps from another recording to the process diagram, create a branch, and merge steps from one or more recordings into the branch, as needed.

5. Convert to bot:

- a) Click the **Convert to bot** option.
- b) Enter a bot name.
- c) Optional: Enter a description.
- d) Click **Browse** and accept the default folder location `\Bots\`.  
To change the location where your bot is stored, drill down to the folder in which you want to save the bot.
- e) Click **Confirm**.
- f) Click **Convert**.  
A message window appears notifying you that the bot has started to convert. You will receive an email when the bot is converted successfully. Click the hyperlink in the email to take you to your folder in which the bot was generated.

---

**Note:** In the **My bots** tab, the converted bot displays an error, with 0 byte size while the bot creation is in process. Avoid opening the bot until the bot conversion is complete.

---

The **Convert to bot** option is only available if you have the Bot Creator license. To review the created bot you must have the **AAE\_Basic** role assigned.

6. Click the **Download** option to export the opportunity data into a Process Definition Document (PDD) with the same name as the opportunity. Select the type of PDD (Word or PDF) that you want to export. The PDD includes the process recording flow chart with a URL link to the process diagram inside Discovery Bot , and the time on each individual step in hours, minutes, and seconds. The PDD does not display the process diagram if there are more than 100 steps selected.

When an opportunity is created, the PDD begins processing in the background automatically. When the PDD is generated, the field changes from Processing PDD to **Download**. You can now download the document. An email notification to the business user is also sent to the email address on file. If an error occurs when you download the PDD, click **Download** again to generate the PDD again.

---

**Note:** If you are a multi-role user, you will receive two email notifications for the exported data, one for the recording data and one for the opportunity data.

---

**Note:** You must be the owner of the opportunity to be able to download it; otherwise, the download option is not available.

---

On your machine, the document is saved in the folder that is configured for downloads in your browser.

## Using the Filter and Toggle frequency counter options

Use the Filter and Toggle frequency counter options from the toolbar to help you review, analyze, and compare the various recordings in the process work flow as you look to create a potential opportunity.

### Filter option

Use the **Filter** option when you want to use a set of values to compare the different sections of a process across various recordings by selecting a specific path and step filter. The **Filter** window displays the following:

Option	Action
Path: With the most common flow	Select this option when you want to see what paths have the most common variance of a process that is being used. If you choose to automate this type of path, you will have a higher return on your investment.
Path: With the most deviations	Select this option when you want to see certain sections of the process that have a different deviation in the path. The automation priority for such paths are usually low.
Path: With the most repetitive flow	Select this option when you want to display sections of the process that are more repetitive and cost more. The automation priority for such paths are usually high.
Step: Application	Select the <b>Application</b> option when you want to see the application type used during the recording. Use this option to see which applications are more frequently used, and to decide on which applications should be a priority.
Step: Action Type	Select the <b>Action type</b> option to filter the process steps to display only particular actions that will help you get an idea how the steps are used.
Clear	Select <b>Clear</b> to clear all selected options.
Reset	Select <b>Reset</b> to reset to the previous saved state of the filters in a view.
Apply	Select <b>Apply</b> to apply the selected options for display for the system generated or manual opportunity.

## Toggle frequency counter

Use the toggle frequency counter option to display the number of recordings that a particular path takes in the flow for a system generated or manual opportunity. Use this option to help you understand the frequency of the path as compared to other recordings. From the **Recordings** table, select two or more recordings and the **Toggle frequency counter** displays two at the start of the process flow to indicate the number of recordings selected. If each recording takes a different path, the process flow is divided between the total number of recordings selected and displays accordingly. For example, if there are ten recordings in a view and three paths displayed. Two recordings follow one path, two recordings follow the second path, and six recordings follow the third path. Along the path flow, you will see two, two, and six. If a step is merged, the number gets added between the two paths. Use the thick or thinness of the path to help you prioritize processes for automation. The most commonly used path is the thickest path and this can be useful for prioritizing a process when reviewing many recordings. For example, if there are 5 paths for 20 recordings, you will quickly see which is the thickest and consider automating this path. If you have additional bandwidth to automate another path, you can drill down in the flow and look at the numbers to see what path is next as a possible candidate for automation.

# Bot Insight

Bot Insight is an analytics platform that provides real-time, interactive, and smart insights about business processes and operational intelligence. Bot Insight is available with out-of-the-box dashboards that you can start using instantly. These dashboards provide analyzes to measure the performance of your digital workforce and predict and solve preventable business problems.

## Business analytics through Bot Insight

Automation Anywhere Bot Insight processes real-time and interactive insights about business processes, and provides operational intelligence. Access the bots, and manage and instrument them to gather business analytics and insights, and publish dashboards.

### 1. [Create and edit bots](#)

The cloud-based bot editor provides tools, packages, and actions to create bots to automate processes.

### 2. [Instrument the bot for analytics](#)

Business analytics provides information about the transactional analytics for the data that is logged by the variables that are tagged in a task. The information provided can be about the total sales in a month, invoicing and payment trends, insight about new customers, and quote-to-order ratio.

### 3. [Access Bot Insight](#)

Access Bot Insight to perform the business analytics.

### 4. [Customize dashboards and widgets](#)

Dashboards represent the RPA infrastructure in the form of meaningful visuals and charts, so that you can analyze, interpret, and take action on the updates that are important to you. The dashboards display dynamically updated information of active users, registered clients, failed tasks, apps, bots, bot schedules, workflows, queues, and the overall status of devices.

### 5. [Publish a business analytics dashboard](#)

Publish a dashboard to display the production data generated by the task. The analytics consumers who primarily analyze and interpret data can access the published dashboard.

To learn more, search for the [Managing RPA Reports Using Automation 360](#) course in [Automation Anywhere University: RPA Training and Certification \(A-People login required\)](#).

Related concepts

[Bot Insight dashboards](#) on page 3929

The Bot Insight dashboards provide dedicated graphical insight to help you view your bot information.

Related tasks

[Run your first bot](#) on page 1493

Run a bot from the same device that you used to create the bot.

Related reference

[Analyze package](#) on page 2412

Use the actions in the **Analyze** package to specify the actions and variables to use in the Bot Insight dashboard and widgets. The **Analyze** package enables you to perform transactional analytics for the data that is logged by the variables when the bot runs.

## Accessing Bot Insight

This section provides information about how to access Bot Insight.

To use Bot Insight business dashboard, the Control Room must have the Bot Insight license applied, and you must be logged in as a user with one of the following roles:

1. AAE\_Bot Insight Expert
2. AAE\_Bot Insight Consumer
3. AAE\_Bot Insight Admin

---

**Note:** To view the published business dashboards, you must have a custom role defined with the **View my bots** and **Check in** permissions to the folder that contains the corresponding tasks.

---

To use Bot Insight external APIs, you must be logged in as a user with **AAE\_Bot Insight Admin** role.

## Access Bot Insight from the Control Room

Access Bot Insight to interactively analyze bot data and enhance bot widgets.

Access Bot Insight from the Control Room in one of the following ways:

- From the Control Room, select **Dashboard**.
  - a) Locate the **Insights** tab.
  - b) In the **Insights** tab, click **Explore Bot Insight**.  
The Bot Insight window appears.
- On the left panel, click **Automation**. A list of available bots and forms is displayed.
  - a) In the **Automation** page, click **PUBLIC** to view the public bots that can be viewed, run, and checked out by other people, based on the permissions set by the administrator.
  - b) Click **PRIVATE** to view your bots and files.

---

**Note:** Private bots and files cannot be viewed by other users. If a bot or file is checked out from the **PUBLIC** tab, it can be viewed and run by other users. However, the bots and files cannot be edited by other users.

---

- c) Select your bot from the **Files and Folders** menu.  
Alternatively, enter the search parameters in the **Search Name** field and search for your bot.
- d) Open the bot and click **Analyze**.  
The Bot Insight window appears.

## Roles to access Bot Insight

The Control Room restricts Bot Insight access to users with certain roles.

Access to the dashboard depends on the user roles assigned to a user and the access permission granted to those user roles. See [Role-Based Access Control](#).

System-generated access is provided to all user types for Bot Insight. Administrators can customize the Bot Insight experience by assigning a user-generated role to users. Each role includes a permission set, designed to specialize Bot Insight features to make analytics more simple or comprehensive. Admins should evaluate user tasks and functions to assign the role most appropriate to fulfill user responsibilities, based on the following details.

---

**Note:** Various types of dashboards can be accessed for quick insights. Common types are listed below. For more details on dashboards, see [Bot Insight dashboards](#) on page 3929

- The system-generated dashboard is also known as a Default type.
- The user-generated dashboard is also known as a Custom type.
- The Published dashboard is also known as the Production type.
- When a published dashboard is saved by a user, the dashboard copy is known as a custom production type.

---

Apart from Bot Creators, users with the following roles have access to business analytics dashboards:

Bot Insight Admin

Use this role to perform the following operations in Bot Insight:

- Access Bot Insight API
- Analyze the Data Profile of the task data for which the dashboard report is generated.
- Analyze and save the system-generated dashboards.
- Analyze, save, publish, and delete the user-generated dashboards and publish dashboards.
- Bookmark, compare, and share the dashboards.

Bot Insight Expert

Use this role to perform the following operations in Bot Insight:

- Analyze the data in the dashboards that are deployed in the production environment.
- Save the system-generated dashboards.
- Analyze, save, publish, and delete the user-generated dashboards and publish dashboards.
- Bookmark, compare, and share the dashboards.

Bot Insight Consumer

Use this role to perform the following operations in Bot Insight:

- Analyze the data in the dashboards that are deployed in the production environment.
- Bookmark, compare, and share the published dashboards.

---

**Note:** To view the published business dashboards, you must have a custom role defined with the **View my bots** and **Check in** permissions to the folder that contains the corresponding tasks.

---

## Role-based access control in Bot Insight

Role-based access control (RBAC) enables a Control Room administrator to restrict access to the various components of Bot Insight.

The Control Room administrator can grant access to various user roles based on your requirements. When adding a user, you assign appropriate roles to that user. A user will have access to the components and folders based on the roles assigned to them.

### Requirements

Before you publish the dashboard, ensure that the following requirements are met:

- The bot resides in the Public workspace for which you want to publish the dashboard.
- You must have a custom role defined with the **View my bots** and **Check in** permissions to the folder that contains the corresponding tasks to:
  - View the published business dashboards.
  - Move your bots from **Private** to **Public** workspace.

the folder that contains the corresponding tasks to

### RBAC for business analytics

Dashboards for business analytics are available for the tasks that are enabled for analytics. The Control Room administrator and users who have access to a task can view the dashboards for those tasks. You can access the dashboard for a task from the **Insight** tab in the **DASHBOARD** section of the Control Room and from the **ANALYZE** tab in the Workbench.

To view the Bot Insight dashboards, you must be granted access to the folder containing the corresponding tasks.

For example, you have created various tasks related to sales and accounting and stored them in the Sales and Accounts folder. If you want to grant access to the sales-related tasks to members of your sales department, you need to provide them access to the Sales folder. The same applies to grant access to the accounts-related tasks in the Accounts folder.

The following table illustrates the access the various members of the Sales and Accounts team will have:



	Sales_Dep			Accounts_Team	
	John	Mark	Dave	Smith	Micheal
Access to the <b>Sales</b> folder	Yes	Yes	Yes	No	No
<b>Sales1</b>	Yes	Yes	Yes	No	No
<b>Sales2</b>	Yes	Yes	Yes	No	No
Access to the <b>Accounts</b> folder	No	No	No	Yes	Yes
<b>Accounts1</b>	No	No	No	Yes	Yes
<b>Accounts2</b>	No	No	No	Yes	Yes
<b>Accounts3</b>	No	No	No	Yes	Yes

## Bot Insight dashboards

The Bot Insight dashboards provide dedicated graphical insight to help you view your bot information.

Dashboards display meaningful visuals and charts so that you can analyze, interpret, and take action on the updates that are important to you. You can use dynamically updated information about active users, failed tasks, apps, bots, bot schedules, workflows, queues, and the overall status of devices to create custom dashboards and widgets.

**Note:** You must use the Analyze package version 2.3.0-20210922-121532 or later to generate the dashboard when running analysis. This package version is available from Automation 360 v.23.

Perform the following steps to apply the package.

1. From the Control Room, select **Manage > Packages > Analyze**.

**Analyze**

This page shows the package details of the selected version. You can also select a different package version and update the installed version.

Versions

2.4.2-20220414-053004

Search

Enabled

2.4.2-20220414-053004 Default

2.4.0-20220118-153149

Actions

Actions (2)

> Close

> Open

General Details

Last modified 22 hours ago

Modified by System

2. Change the Analyze package version to 2.3.0-20210922-121532 or later.
3. Save your changes.
4. Run the bot and ensure the change to dashboard generation.

**Note:** For changes to be applied to the public workspace, **checkIn** your bot before running analysis.

When you create and run a bot, Bot Insight automatically creates a default dashboard in the collection: My dashboards. If you have a parent bot and a child bot, Bot Insight creates a separate dashboard for each of the bots.

**Note:** The system does not automatically refresh (auto-refresh) the Bot Insight dashboards unless the user loads a screen or clicks the **Refresh** button, thereby manually refreshing data on a page.

When you deploy and run a bot on the Bot Runner machine, Bot Insight aggregates all the information related to that bot. The published dashboard for that bot displays the aggregated bot information.

**Note:** Some data might not populate in a widget if bots were created in Automation 360 v.12 or earlier versions. See the following article for troubleshooting: [Bot Insight dashboard not populating data in specific widgets \(A-People login required\)](#).

My dashboards displays the following dashboards:

- [Operations dashboard](#) on page 3932
- [Business dashboard](#) on page 3935

**Note:**

- You must have either the `AAE_Bot Insight Admin` or the `AAE_Bot Insight Consumer` role assigned to you to view the published dashboard.
  - The data visible on the dashboards is in the **UTC** time zone.
- 

## Viewing Bot Insight dashboards

The Bot Insight dashboards provide customizable widgets for you to gain insights in specific scenarios. You can view information about your bots on the Bot Insight dashboards from the Control Room.

To view the published business dashboards, you must have a custom role defined with the **View my bots** and **Check in** permissions to the folder that contains the corresponding tasks.

When you tag variables for analytics in a task and then run the task, Bot Insight generates the analytics dashboard. By default, the system-generated dashboard has the same name as that of the task. You can customize this dashboard to your requirements.

Business analytics provide information on the transactional analytics for data that is logged by the variable tagged in a task. The information provided can be about total sales in a month, invoice, payment trends, new customer insights, or quote-to-order ratio. You can select your dashboard from the **Select a Dashboard** drop-down menu to view the analytics.

Bot Insight provides the following dashboards:

- **Configure**

The system-generated dashboards are available in the **Configure** tab in the Bot Insight window.

- **Analyze**

The customized dashboards can be published and are available in the **Analyze** tab in the Bot Insight window.

- **Operation**

The **Operation** dashboard provides information about bots that are created, deployed, or scheduled to run across different Bot Runner machines. You can use the information to enhance productivity and take measures based on real-time information for RPA deployments.

1. Log in to the Control Room with one of the following roles:

- `AAE_Bot Insight Admin`
- `AAE_Bot Insight Expert`
- `AAE_Bot Insight Consumer`

2. Click **Explore Bot Insight** from the **Insights** tab.

The Bot Insight dashboard appears in a new window.

## Viewing Insights

You can view information about business data in Bot Insight.

Click **Insights** from the **Analyze** tab to view information about interesting facts on business data.

The Insight dashboard provides information about business data that is logged through Bot Insight without the need to analyze the dashboards. It provides a snapshot of data that you can use to

enhance your bot productivity. This feature highlights important facts that are inferred from within the business process data logged by the bots.

A bot created to process orders displays the following information:

- Total processing cost
- Process time
- Monthly payment
- Total payment

The dashboard provides information about the difference between the calculated metric values for a specific time interval:

- Yesterday
- Last 7 days
- Last 30 days

The Insight dashboard enables you to configure the variance thresholds for indicating metric-level health.

Perform the following steps to configure the variance thresholds:

1. Click **Settings**.
2. In the **Variance Threshold** window, move the slider to the left or the right to adjust the variance threshold.
  - Move the slider to the left for a **Poor** metric health level.  
The poor metric level health is represented in red.
  - Move the slider to the right for a **Good** metric health level.  
The good metric level health is represented in green.
3. Enter the values in the **Fair** field to set the **Fair** metric health level.
4. Select the **Switch poor and good** check box to switch between the **Poor** and **Good** metric health levels.
5. Click **Save**.

## Operations dashboard

The Bot Insight Operations dashboard provides information about bots that are deployed on different Bot Runner machines and bot statistics based on performance. You can use this information to enhance productivity and take measures based on real-time information for RPA deployments.

The Operations dashboard provides visual insight into various operational aspects of bots and displays hyperlinks to the following dashboards:

- Bots Dashboard
- Audit Dashboard
- Device dashboard

---

**Note:** Ensure that you have the **AAE\_Admin** role to view all bots information in the operations dashboards.

---

These dashboards appear as the Default dashboards and are automatically created by Bot Insight based on the variables that are used in the bot. You can use the **Save As** function to save the Default dashboard as a Custom dashboard. You can also add widgets from the Visualizations menu to your custom dashboards.

[Using widgets](#) on page 3950

## Bots Dashboard

You can view information about the bots that are created, deployed, scheduled, and running across various Bot Runner machines.

The dashboard displays the following bot information:

- **Total Bot Runs:** Displays the total number of times the checked-in bots executed from the Bot Runner machines. (The number displays the total number of bots that have run successfully and failed to run).
- **Total Completed (Success):** Displays the number of bots that have ran successfully.
- **Total In Progress:** Displays the number of in-progress bots.
- **Total Failed:** Displays the number of bots that had failed to deploy or run.
- **Weekly Bot Status:** Displays the weekly status of bots that are scheduled to run.

---

**Tip:** You can hover over the widget to view the number of bots that have run successfully, failed to deploy, and failed to run. It also displays the weekly bots statistics percentage.

---

- **Failure Reasons:** Displays reasoning information on bots that had failed.
- 

**Note:** The **Error Message** field displays a snapshot of the original error message and extensive details on why the bot failed. You can export the error messages and logs to a CSV file, which you can later use to troubleshoot.

---

Additionally, the Bots dashboard displays the Bot duration (such as minimum, maximum, average, and summation) of each bot. You can create your own dashboard, add any widget, and calculate the minimum, maximum, average, and summation of bot run time.

## Audit Dashboard

This dashboard displays various widgets that provide information about Control Room events. Users with the `View everyone's audit log actions` permission have access to view the audit information captured in the Control Room.

[System roles](#) on page 1768.

The dashboard displays the following information:

- **Event Distribution by Activity Type**
- **Event Distribution by User Name**
- **Event Distribution by Source**
- **Event Distribution by Control Room Source**
- **Event Distribution by Workbench Source**

You can perform the following actions in the Operations dashboard:

- Enter the name of the dashboard in the **Search** text box to access a dashboard.
- Click the **Favorite** tab to bookmark your dashboard.
- Double-click the **Favorite** menu to remove bookmarks.

You can view information in the following tabs:

- **Total Views:** Displays the number of users who viewed a particular dashboard.
- **Last Refreshed:** Displays the time and date of when a particular dashboard was last refreshed.

You can click the arrow next to the Operations dashboard tabs to organize the dashboards to your requirements.

You can customize the widgets in the Operations dashboard. You can perform the following functions:

- [Working with Bot Insight dashboards](#) on page 3944
- [Comparing dashboards](#) on page 3944
- [Sharing a dashboard](#) on page 3947
- [Taking a screenshot of a dashboard](#) on page 3948
- [Downloading a PDF file from a dashboard](#) on page 3948

## Device Dashboard

The Device dashboard displays various widgets that provide information about resource utilization of the machines on which bots are executed.

The dashboard provides key metrics to analyze the status and utilization of devices. It also displays the activity history of the bots that are deployed on the machines.

The dashboard displays the following information:

- **Online Devices:** Displays the number of Bot Runner machines that are active or online at a point in time.
- **Offline Devices:** Displays the number of Bot Runner machines that are inactive or offline at a point in time. Devices can be online even though no bots are deployed on them.
- **Bot Schedules on Devices:** Displays the number of bots that are scheduled to run on all the Bot Runner machines.
- **Device Utilization%:** Provides the overall time used by bots that are executed across all the Bot Runner machines. You can view and analyze the utilization information by date using the following criteria:
  - Bot duration
  - Unit: %
  - Group 1: Start date time of a bot (interval: day)
  - Group 2: device name

There is no limit on the number of devices that can be displayed on the dashboard.

- **Device Activity History:** Provides information about the execution history of bots deployed on each Bot Runner machine. The Device Activity History table provides the following information:
  - Device name
  - Bot name
  - Bot duration (milliseconds)

- Start date time of a bot
- End date time of a bot
- Status

When the Group1 and Group 2 fields have date type variables and you select **Bot Duration** as a metric, the **Percentage (%)** option appears as an additional option for **Bot Duration Unit**. Based on the selected group interval, the percentage is calculated for the bot duration.

Example: When you select the parameters in the following fields as:

- Group By or Sub By: Date
- Interval: Year
- Metric: Bot Duration
- Bot Duration Unit: Percentage (%)
- The percentage calculated for bot duration is:  
 $(10000/1000ms * 60s * 60m * 24h * 365days) * 100 = \%$

---

**Note:** The percentage calculation of the bot duration is available in all the widgets, except datatable and maps.

---

- **Top Error Messages:** Provides information about the error messages for any bot failure and the frequency of occurrence.

## Business dashboard

The Bot Insight Business dashboard provides information about the Bot Insight data and statistics based on bot performance. You can use this information to enhance your productivity and take measures based on real-time information for RPA deployments.

The Business dashboard provides visual insight into the various business aspects of the bots. From this dashboard, you can access both the Default and Custom dashboards.

Bot Insight automatically creates the Default dashboard based on the variables that are used in the bot. You can use the **Save As** function to save the Default dashboard as a Custom dashboard. You can also add widgets from the **Visualizations** menu to your custom dashboards.

[Using widgets](#) on page 3950

In the Custom dashboard, Bot Insight enables you to export data from a dashboard widget to CSV files.

[Exporting data from a dashboard widget](#) on page 3956

You can perform the following actions in the Business dashboard:

- Enter the name of the dashboard in the **Search** text box to access a dashboard.
- Click the **Favorite** tab to bookmark your dashboard.
- Double-click the **Favorite** menu to remove bookmarks.

The dashboard displays the following bot information:

- **Bot Name:** Displays the name of bots that are associated with the business dashboards.
- **Total Views:** Displays the number of users who viewed a dashboard.
- **Last Refreshed:** Displays the time and date on which a particular dashboard was last refreshed.

- **Modified By:** Displays the name of the user who had last modified the dashboard.

You can click the arrow next to the Business dashboard tabs to organize the dashboards to your requirements.

In the **Dashboard Name** tab, select the dashboard that you want to access to view the dashboard. You can also enter the name of the dashboard in the **Search** text box to access the dashboard directly.

Click **Rank** in the **Distinct Count** row to view the rank of each variable. You can view the string data type values that are logged by a variable for the maximum or minimum number of times. This further enhances your ability to verify that the data is logged correctly in the bot.

[Viewing ranks of string datatype values](#) on page 3945

The Business dashboard widgets displays the following information:

- The total number of variables
- The comparison between number variables and transaction status
- The comparison between number variable distribution and transaction status
- A bar chart representing the distribution between the number variables and string variables
- A pie chart representing the relationship between variables in numbers and strings

The Profile dashboard displays bot variables and the transaction data. The Task Name table displays the variable name, display name, data type, inclusion details, maximum, minimum, average, sum, distinct count for the date, string, and number variables.

The Transaction Data table displays the variable name, display name, data type, inclusion details, minimum, maximum, average, sum, and distinct count metrics for the following parameters:

- **Machine Name**
- **Transaction Name**
- **Transaction Start Time**
- **Transaction End Time**
- **Total Transaction Duration** (Start Time - End Time)
- **Transaction Status** (In Progress or Completed)
- **User Name** (User who runs the bot)

You can use the **Preview Data** option to view the total number of records maintained for each variable. When you create and run a bot with multiple **Transaction Blocks** with **Analyze**, **Open**, or **Close** commands, all the tagged business variables are displayed in the **Transaction Names** menu.

You can customize the widgets in the Business dashboard. You can perform the following functions:

- [Working with Bot Insight dashboards](#) on page 3944
- [Comparing dashboards](#) on page 3944
- [Sharing a dashboard](#) on page 3947
- [Taking a screenshot of a dashboard](#) on page 3948
- [Downloading a PDF file from a dashboard](#) on page 3948



## Document Workspace dashboard

The Document Workspace dashboards provide visualizations of learning instance performance and quality metrics as well as validation operations metrics.

Users with access to Document Automation can view and customize the Document Workspace dashboard without additional permissions.

The Document Workspace dashboard contains eight widgets, which contain visualizations of learning instance data. The widgets are customizable:

- You can reposition a widget by dragging and dropping it into a new location.
- You can apply filters, such as by specific learning instance or time frame. [Adding a dashboard filter](#) on page 3943
- You can click a data point in a widget to "drill down" or filter the metrics in that widget. See the following video:

## Document Workspace widgets

Widget	Description
Accuracy % by field	A horizontal stacked bar chart that shows the straight-through processing percentage for each field in the learning instances
Extraction time per documents	A horizontal stacked bar chart that shows the average extraction time per learning instance in milliseconds
Number of uploaded documents	A line chart that tracks the total number of files uploaded each day
Number of uploaded pages	A line chart that tracks the total number of pages uploaded each day
STP% by learning instance	A horizontal bar chart that shows the straight-through processing percentage for each learning instance
STP% over time	A line chart that tracks the straight-through processing percentage for all the leaning instances by day
Validator performance by weighted average validation time	A horizontal bar chart that shows the weighted average time each Validator user spent performing manual validation per document.
Validator performance by # of documents validated	A horizontal stacked bar chart that shows the number of documents each Validator user validated per day

## Dashboard filters

You can use the following dashboard filters to customize the metrics included in the dashboard:

- Learning Instance Name

**Note:** By default, both public and private learning instances are included in the dashboard.

- Document Type
- Page Count
- Created On

**Note:** When you set a filter, it is applied to the entire dashboard. To apply a filter to a specific widget, open the **Widgets** menu and select which widgets to apply the filter:

The screenshot displays the 'Dashboard Filter' interface. On the left, a sidebar lists filter categories: 'Attributes' (with 'Learning Instance Name' and 'Document Type' selected), 'Numeric' (with 'Page Count'), and 'Time' (with 'Created On'). A 'Clear All' button is located at the top right of the filter sidebar. The main area, titled 'Dashboard', shows a widget 'Extraction time per documents'. A 'Document Type' filter is applied, with options 'Include' (selected) and 'Exclude'. Below this is a search bar 'Search Document Type' and a list of document types: 'Document Type', 'Invoices', 'Receipts', 'User-defined', and 'Utility Bill'. The 'Document Type' item is highlighted. At the bottom, a 'Widgets' menu is visible with a 'Show' button, and a large blue 'APPLY' button is at the very bottom.

## Custom dashboard filters

You can use the following custom filters to build the custom widgets in a **Document Workspace** dashboard:

- **User Name**
- **Status**
- **OCR Engine**
- **Processing Phase**
- **Processing Time**
- **Start time**
- **End time**

Related tasks

[Sharing a dashboard](#) on page 3947

You can share the link to view a dashboard through email using the **Share via email** option.

[Downloading a PDF file from a dashboard](#) on page 3948

You can download the data available in the dashboard as a PDF file.

[Taking a screenshot of a dashboard](#) on page 3948

You can take a screenshot of the data available in the dashboard.

## Edit widget settings

You can edit widget settings to customize the general and advanced settings (such as chart title, chart type, metric, limit, and so on). You can build custom widgets with a custom filter, thereby increasing the data visualization effectiveness in the **Document Workspace** dashboard.

Users with access to Document Automation can view and customize the **Document Workspace** dashboard without additional permissions.

1. Open the Document Workspace dashboard.
2. Click the three dots icon in the required widget and click **Settings**.

---

**Note:** You can edit these widgets only: **Number of uploaded pages**, **Number of uploaded documents**, **Extraction time per documents**, **Validator performance by # of documents validated**, and **Validator performance by weighted average validation time**.

---

3. In the **Edit Chart** window, define the settings.
  - **General Settings**
    - **Chart Title:** Title of the chart (for example, *Number of uploaded documents*).
    - **Chart Type:** Type of the chart. See [Bot Insight visualizations](#) on page 3952.
    - **Group By:** Groups the data by **Learning Instance Name**, **Document Type**, **Created On**, **OCR Engine**, **User Name**, **Processing Phase**, **Status**, **Start Time**, and **End Time**.
    - **Date Interval:** The unit of interval (such as Hour, Day, Week, Month, and Year) in which data is presented.
    - **Metric:** Compares or assesses data by **Page Count**, **Processing Time Ms**, and **Volume**.
  - **Advanced Settings**
    - **Limit:** Limit for the X-axis and Y-axis values.

- **Sort By:** Sorts the data by **Volume** and **Start Time**.
- **Sort Order:** Order in which data is sorted (for example, **Descending** or **Ascending**).

4. Click **Next**.
5. Confirm the settings and click **Finish**.

## Automation Co-Pilot dashboard

Use the Automation Co-Pilot dashboard in Bot Insight to view various widgets that provide information about requests created from published processes in Automation Co-Pilot for Business Users (Automation Co-Pilot).

### Overview

The dashboard provides statistics and shows information about created requests for each process, which can vary from a simple summary to a complex cross-departmental view. You can use this real-time information to make process-related operational decisions. For example, consider a scenario where a manager can get a high-level activity overview of completed and pending tasks in the payroll process, which can then help the manager take necessary actions about the process.

From the Automation Co-Pilot dashboard, you can access both the Default and Custom dashboards. Bot Insight automatically creates the Default dashboard from the variables used in the process. You can use save the Default dashboard as a Custom dashboard if required. You can also add widgets from the visualizations menu to your custom dashboards.

Based on RBAC, the following users have access to view the data on the dashboard:

- **AAE\_Robotic\_Interface\_Admin** can view all data inside Automation Co-Pilot on the web interface across all teams.
- **AAE\_Robotic\_Interface\_Manager** can view all data inside Automation Co-Pilot on the web interface for their own teams.

### What you can view in Automation Co-Pilot dashboard

The dashboard helps you to visualize and track the number of requests that are open, completed, canceled, or failed.

The dashboard also provides the following capabilities:

- Heat map chart: Visualize data about the percentage of request created for each process for a day. You can specify the dates by function (day) to get specific information using the following criteria:
  - Group1: created date (interval: day)
  - Group 2: process name
  - Metric: request created in percentage (%) for each process
- Request activity history: This table provides the execution history of the processes deployed on each Bot Runner machine. It includes information such as the following:
  - Process name

- Username
  - Request details such as the status, ID, end time and start time, duration
  - Total human and bot duration
  - Total human and bot tasks
- Stacked bar chart: Analyze the average duration taken by each process for human and bot tasks. For example, consider that there are two processes named API Test-Form 1 and API Test-Form 2 in the bot task type. For each process, the chart shows the average time (in seconds) taken for its execution. You can view and analyze this information using the following criteria:
    - Group 1: task type (human and bot)
    - Group 2: process name
    - Metric: duration (average)

## Editing a data profile

You can modify the data profile of Default dashboards without modifying the bots.

You must have the **AAE\_Bot Insight Admin** role.

You can edit the data profile and regenerate the dashboard based on the new data profile. You can edit the display name of a variable, change its data type, and exclude it from the dashboard.

Bot Insight provides smart data profiling for information about countries, states, and zip or postal codes. Bot Insight analyzes the information provided in the variables and automatically identifies the information as:

- Country (country code or country name)
- State (state code or state name)
- Zip code (five-digit zip code)

You can edit the data profile to convert the above parameters from numeric format to string format (country and state) based on your requirements. You can convert the zip code to either string or numeric format, and use the information to create widgets (world and US map widgets) in the Bot Insight dashboard.

1. Open the Bot Insight dashboard.
2. Click **Profile**.

The **Profile** window appears, displaying all the variables that you have tagged during the bot creation.

3. Click **EDIT**.
4. Specify a new name for a variable in the **Display Name** field.
5. Select an option from the **Datatype** drop-down list to specify a new data type for a variable. You can change the datatype of a numeric variable to string, string to country, state, and zip code.

---

**Note:** Changes to the **Data Type** parameter cannot be reverted.

---

6. Clear the **Inclusion** check box to exclude the variable from the dashboard. Select **Inclusion** to include a variable from the dashboard and configure how the initial SMART dashboard is generated.

You can view the minimum, maximum, average, sum, and last value for the numeric values, but not for the string and timestamp variable types.

7. Click **Save and Generate Dashboard** to save the changes and generate the dashboard with the updated value.

## Bot Insight dashboard filter

The Bot Insight dashboard filter enables you to apply filters across your dashboards to display the filtered data. You can save and publish the custom dashboards with preset filters.

Filters in the Bot Insight dashboard enables you to choose different views of the data. You can apply and save filters in a dashboard to preserve the filtered view. The filtered view displays the same view the next time you view the dashboard.

Dashboard filters enables different combinations of data in a single dashboard. The filter eliminates the need for separate dashboards for different users. A single-filtered dashboard allows you to serve data requirements for a wide range of users.

You can access the dashboard filter from both the Operations and Business dashboards. You can click each item in the filter list to view the parameters. You can search for a specific parameter in the **Search Automation Name** field in the **All** tab. You can select parameters based on whether to include or exclude them in the filter. The selected parameters appear in the **Selected** tab.

When you apply a specific filter, the visual indicator in the dashboard displays the name of the applied active filter. You can delete a dashboard filter by clicking the delete icon. When you publish a custom dashboard with the applied the dashboard-level filters, the published dashboard contains the same filters. You can click **Widgets** in the widget window to apply dashboard widgets.

The Bot Insight dashboard provides the following filters:

- **Attributes:** This filter enables you to include or exclude specific parameters of a given attribute. This can be the bot name, device name, or user name.

For example, you can use the parameters:

- **Model Version** to differentiate the payload and to determine if an upgrade is required in the dashboard. You can also use it as a filter so that the dashboard works correctly even with different job execution pay loads.
- **Job type** to identify the type of task such as TASK(Bot Run), WORKFLOW, WORKORDER, WLM\_TASK
- **Automation Name** to provide a name when running or scheduling the bot
- **Object Name** to identify the name of the entity for which the audit action is recorded. For example, to identify the username when the user is edited or created or the bot name when the bot is edited or created.
- **Numeric:** This filter enables you to select a specific duration for which you can get the numerical statistics of the bot. For example, this can be the **totalLines** that is processed by the bot, or the duration during which the bot was active.
- **Time:** This filter enables you to select a single date, or a range of dates to analyze the variables that are categorized under time and date. This can be the bot start time or end time.

Related concepts

[Operations dashboard](#) on page 3932

The Bot Insight Operations dashboard provides information about bots that are deployed on different Bot Runner machines and bot statistics based on performance. You can use this information to enhance productivity and take measures based on real-time information for RPA deployments.

### Adding a dashboard filter

To create a dashboard filter, select a field containing the information type you want to filter and define the return of the data. The filtered view is preserved so that the same view is displayed the next time you view the dashboard.

1. Open the dashboard to which you want to add a filter.
2. Select the parameter based on your requirements in the **Attributes** tab, .  
The parameter window appears.
  - a) Enter the name of the variable in the **Search** field.  
The variable appears in the **All** tab. Select the variable that you want to add in the filter.  
The selected variable appears in the **Selected** tab.
  - b) Choose one of the following options:
    - Click **Include** to include the variable in the dashboard filter.
    - Click **Exclude** to exclude the variable in the dashboard filter.
  - c) Click **Apply**.

The **Attributes** filter is added to the dashboard.

3. Select the parameter in the **Numeric** tab.
4. Perform these steps in the selected parameter window:
  - a) Select the condition that you want to specify in the filter.
  - b) Enter the minimum and the maximum values.
  - c) Click **Apply**.

The **Numeric** filter is added to the dashboard.

5. Select the parameter based on your requirement in the **Time** tab.
6. Perform these steps in the selected parameter window:
  - a) Select a specific date, or a range of dates.
  - b) Click **Apply**.  
The **Time** filter is added to the dashboard.

Related reference

[Customizing a dashboard](#) on page 3945

Log in to Bot Insight with the `AAE_Bot_Insight_Expert` role to customize the information displayed in the system-generated dashboard to make it more relevant for an analytics consumer.

## Working with Bot Insight dashboards

You can save or delete a Bot Insight dashboard when required. You can also delete a user-created dashboard.

When you delete a dashboard, it does not impact the data associated with that dashboard. You can delete dashboards that are available in the **Analyze** and **Configure** tabs of the Bot Insight window. The dashboards available in the **Analyze** tab are the published dashboards. Therefore, if you delete a dashboard from the **Analyze** tab, it will no longer be available for other users.

- Save a dashboard:
  - a) Open the dashboard that you want to save.
  - b) From the **Actions** menu, select **Save as**.  
The **Save Dashboard** window appears.
  - c) In the **Dashboard Name** field, enter the name for the dashboard.
  - d) In the **Dashboard Description** field, enter the description of the dashboard.
  - e) Click **Save**.  
Click **Save As** to save a default dashboard as a customized dashboard.
  
- Open the dashboard you want to delete.
  - a) Click **Delete** on the toolbar.
  - b) Click **Okay**.

## Comparing dashboards

You can compare dashboards that belong to two separate processes, or the same process with different filters. The dashboards selected for comparison appears as a side-by-side view to enable you to obtain better insights.

- Compare dashboards:
  - a) Open the dashboard that you want to compare.
  - b) Navigate to **Actions > Compare** in the **Bots Dashboard**.  
Your dashboard is now in compare mode. The dashboard you have opened appears in both the **Left View** and **Right View**. You can apply widget filters to your dashboard at any time.
  
- Apply widgets to your dashboards:
  - a) Click the **Filter** option from your dashboards, represented by the three dots in the corner.  
The **Filter** window now appears and shows the available widgets.

---

**Note:** The **Filter** option next to the **Close** option accesses the same **Filter** window. You can also expand or minimize the **Filter** window.

---

  - b) Select the **Left View** or **Right View**.



- c) Select the **Attributes**, **Numeric**, or **Time** widgets that you want to apply.
- d) Optional: Click **Clear All** to reset all your widget selections.
- e) Click **Apply** to confirm.  
You can now compare your dashboard with widgets.

## Customizing a dashboard

Log in to Bot Insight with the `AAE_Bot_Insight_Expert` role to customize the information displayed in the system-generated dashboard to make it more relevant for an analytics consumer.

To make changes in a Bot Insight dashboard, create a copy of the dashboard, and then update the copy.

After you create customized dashboards for a bot, you can make changes to the tagged variables. You can delete and add variables based on your requirements. By default, the standard dashboard always displays the latest data profile. We recommend you use the system-generated standard dashboard, and then create customized dashboards from it. Data profile updates are highlighted with a red dot in the following scenarios:

- When there are data profile updates.
  - The variables that are newly added display the message `NEW`.
  - The variables that are deleted display the message `DELETED`.
- When the customized dashboard data profile does not match that of the standard dashboard.

Related tasks

[Editing a data profile](#) on page 3941

You can modify the data profile of Default dashboards without modifying the bots.

## Viewing ranks of string datatype values

Among string datatype values, you can view the ranking based on the maximum and minimum number of times each string datatype value has been used, as logged by a variable. With this information, you can better verify whether the data logged in the bot is correct.

1. Open the dashboard for which you want to edit the data profile.
2. Click the **Profile** tab.
3. Click **Rank** within the **Distinct Count** column.

The **Distinct Count** column displays the number of unique values logged by a variable.

---

**Note:** The **Rank** option is only available for the variables that log values of string datatype. A message appears displaying the top five values that are logged for the maximum number of times in the variable.

---

4. Select **Bottom** from the list to display the five values that are logged the least number of times in the variable.
5. Select an option from the list to display five or ten values in the message box.

## Previewing data

You can view all the variable data associated with a task using the **Preview Data** option.

1. Open the dashboard for which you want to preview the data.
2. Click the **Data Profile** tab.
3. Click the **Preview data** option.  
A new window appears displaying all the variable data associated with that task.

## Verifying data populated in a custom dashboard

After you create a custom dashboard that contains new widgets or customized widgets from the system-generated dashboards, you can verify the data that is populated in the dashboard.

1. Open the task for which you want to verify the data in Bot Insight.
2. Click **Run** on the toolbar.
3. Click the **ANALYZE** tab.  
The system-generated dashboard for the task appears.
4. Click the **Analyze** tab in the Bot Insight window and search for the customized dashboard for which you want to verify the data.
5. Select the dashboard from the search results.  
The dashboard appears.
6. Click the **Data Profile** tab and verify the data for the dashboard.

## Publishing a business analytics dashboard

Bot Insight enables you to publish a business analytics dashboard that is generated for a task. You can publish both the Custom and Default Business dashboards.

Before you publish a dashboard, ensure that the particular bot resides in the Public folder in the Control Room.

1. Open the dashboard that you want to publish.
2. Customize the dashboard based on your requirements and verify the content and presentation formats.
3. Click **Publish** on the toolbar.
4. Specify a name for the dashboard, and then click **Okay**.  
The dashboard is now published and available to display the production data generated by the task. The dashboard updates the data each time a task runs in the production environment from the Control Room on a regular basis.  
In the Control Room, ensure that you deploy the bot in the Bot Runner device so that the published dashboards are populated with data.

Related tasks

[Import bots](#) on page 2035

You can import bots with their dependencies from one Control Room to another. The source environment can be Automation 360 Control Room, Enterprise 11 , or Enterprise 10 Control Room instance.

#### Save a published dashboard

You can publish a Bot Insight business analytics dashboard that is generated for a task. You can also save a copy of the published dashboard when required.

Ensure you have the **AAE\_Bot Insight Admin** or **AAE\_Bot Insight Expert** roles assigned to you.

1. Open the Bot Insight Window.
2. Click the **Business** tab and search for the dashboard for which you want to save a copy of custom production dashboard.
3. Select the dashboard from the search results.  
The selected dashboard appears
4. Select the **SaveAs** from the **Action** menu to save the default **Production** dashboard as a **Custom Production** dashboard.
5. In the **Save Dashboard** window, specify a name for the dashboard and click **Okay**.  
You can add widgets from the **Visualizations** menu to your custom production dashboard.  
You can add, delete, change visualization, apply filters, and so on to customize the dashboard.

#### Delete a published dashboard

You can publish a Bot Insight business analytics dashboard that is generated for a task. You can also delete a published dashboard when it is not longer required.

Ensure you have the **AAE\_Bot Insight Admin** or **AAE\_Bot Insight Expert** roles assigned to you.

You cannot delete a default **Production** dashboard if child (custom production dashboards) are associated with it. You must first delete the custom production dashboard and then delete the default **Production** dashboard. However, you can delete a **Custom Production** dashboard.

1. Open the Bot Insight Window
2. Click the **Business** tab and search for the dashboard you want to delete.
3. Click **Delete** from the **Action** menu.
4. Click **Okay** to confirm the deletion.

### Reviewing data in a published dashboard

You can review the data available in a published dashboard.

1. Open the Bot Insight window.
2. Search for the dashboard for which you want to view the data.
3. Select the dashboard from the search results.  
The selected dashboard appears.
4. Review the data available in the dashboard.  
The dashboard reflects the data processed by the task in the production environment.
5. Export the entire dashboard in PDF or PNG format for offline consumption and review.

### Sharing a dashboard

You can share the link to view a dashboard through email using the **Share via email** option.

1. Open the dashboard that you want to share.

2. Click **Share via email** on the toolbar.  
The email client configured on your system appears. The email client contains a link to access the dashboard.
3. Specify the email address of the recipients and send the email.

### Downloading a PDF file from a dashboard

You can download the data available in the dashboard as a PDF file.

1. Open the Bot Insight window.
2. Search for the specific dashboard.
3. Select the dashboard from the search results.  
The selected dashboard appears.
4. Review the data available in the dashboard.
5. In the **Actions** menu, click **Download PDF**.

---

**Note:** For all dashboards, the **Download PDF** function does not work in Safari browser. You can use other browsers such as Chrome, Firefox, or Edge to download the PDF reports.

---

6. In the **Download PDF** window, navigate to the location on your local disk drive.
7. Click **Save**.

---

**Note:** Due to a limitation within the third-party recharts library, you might observe labels overlapping issue with data in downloaded PDF.

---

### Taking a screenshot of a dashboard

You can take a screenshot of the data available in the dashboard.

1. Open the Bot Insight window.
2. Search for the dashboard for which you want to view the data.
3. Select the dashboard from the search results.  
The selected dashboard appears.
4. Review the data available in the dashboard.
5. In the **Actions** menu, click **Screenshot**.
6. In the **Download PDF** window, navigate to your local disk drive location.
7. Click **Save**.

## Using Bot Insight

Use Automation Anywhere Bot Insight to track bot data for analytics.

Automation Anywhere bots are built, run, and monitored in the Control Room. Bot Insight accesses real-time business insights and digital workforce performance data to leverage content-level productivity data from the bots that are deployed. Data is logged for business analytics who has Attended and Unattended Bot Runner license .

Log in to Automation Anywhere Control Room as an `AAE_Bot_Insight_Expert` or `AAE_Bot_Insight_Consumer` to interactively analyze bot data and enhance bot widgets.

In the Control Room, select the Bot Insight tab, to do the following tasks:

- Interactively analyze the bot data in the dashboards.
- Refine and enhance widgets in the Bot Insight dashboards before they are published for wider consumption and deployed to production.

---

**Note:** To view the published business dashboards, you must have a custom role defined with the **View my bots** and **Check in** permissions to the folder that contains the corresponding tasks.

---

## Business analytics

Business analytics provide information about the transactional analytics for the data that is logged by the variable tagged in a task. The information provided can be about the total sales in a month, invoicing and payment trends, insight about new customers, or quote to order ratio.

When you tag variables for analytics in a task, and run the task, Bot Insight generates the analytics dashboard. By default, the generated dashboard has the same name as that of the task. You can customize the system generated dashboards based on your requirement.

## Configuring a task for business analytics

To configure a business analytics automation task, enable analytics (using the **Analyze: Open** and **Analyze: Close** actions) and tag the variables that are of interest for data analysis.

To configure a task for business analytics in an existing bot:

1. Log in to the Control Room.

---

**Note:** Ensure that you have the Bot Creator license assigned to you.

---

2. In the **Automation** pane, select the folder that contains the task for which you want to enable analytics.

The **Actions** palette appears in the left-hand side. See [Actions to build bots](#) on page 2363.

3. Build a bot.

For more information about building and editing a bot, see [Get started building bots](#) on page 3197.

4. Insert the **Analyze: Open** action at the beginning of the transaction.
5. Insert the **Analyze: Close** action at the end of the transaction.

The **Analyze: Close** menu lists all the variables in the transaction. Select the variables that are tagged in the transaction to process business analytics.

---

**Note:** This feature enables you to deselect variables that might raise potential privacy concerns, such as social security numbers or bank account details.

---

6. Click **Apply**.

Click **Reset** to reset the variable selection.

7. Click **Save**.

8. Click **Run**.

The **Bot Run Successfully** message appears.

The screenshot shows the Automation Anywhere Control Room interface. The main window displays a bot named "Order to Cash" in the "Analyze" mode. The interface is divided into several sections:

- Left Sidebar:** Contains navigation options like "Dashboard", "Activity", "Bots", "Credentials", "Packages", and "Devices".
- Top Bar:** Shows "Control Room" and "Bots > My bots > Edit Task Bot".
- Main Canvas:** Displays a flowchart with steps:
  - Analyze: Open** (Start)
  - Loop for each row in csv/txt** (Loop)
  - Step "Transaction Amount Verification"** (Step)
  - Number: Assign Salldata2\$ to \$Total\_Amount\$** (Assign)
  - If \$Total\_Amount\$ Greater Than (\$)** (Condition)
  - If Else If \$Total\_Amount\$ Greater Than (\$)** (Condition)
  - Message box "Routing this transaction to A..."** (Message)
  - Message box "Routing this transaction to h..."** (Message)
  - Analyze: Close** (End)
- Right Panel:** Shows the "Analyze: Close" configuration with a list of variables and their values, such as "Transaction name", "Supplier\_Name", "Transaction\_Number", etc.

9. Click **Analyze**.  
The Bot Insight window appears.
10. Select a bot from the **Select a Dashboard** drop-down list.  
Click the arrow to view the list of bots.

## Using widgets

The Bot Insight dashboard provides a host of highly customizable widgets that you can use to gain insights for specific scenarios.

When you select a particular bot, the default widgets automatically appear in the **Dashboard** window. You can select the widgets and reposition them in the dashboard. To search for specific information, use the **Smart Filter** function. You can enter the search parameters in the **Smart Filter** field.

You can also use multiple filters to search for data the widgets should display. Enter the filters, search parameters, separated by a comma in the **Smart Filter** field. You can create, move, rename, and edit the widget properties in a dashboard, based on your requirements.

The available options are:

- Chart filters
- Chart style
- Metric-based filters
- Comparison metrics

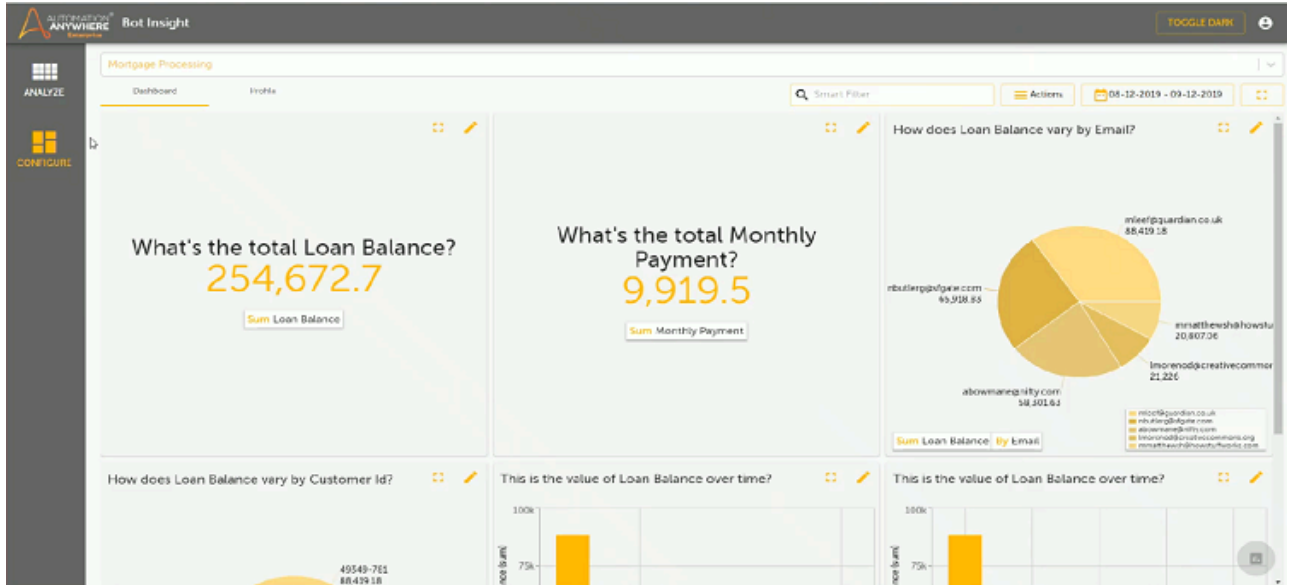

You can group information by dates and use the **Date Interval** to view when a particular bot was active.

The following **Date** type options are available:

- Hour
- Day
- Week
- Month

## Adding a dashboard widget

You can add custom widgets to the Bot Insight dashboard based on your requirements.

You can add a widget to the custom dashboards and not to the default dashboard.

1. Open the dashboard.
- 2.



Click the  icon.

The **Add Visualization** window appears.

3. Select a widget that you want to add in the dashboard. See [Bot Insight visualizations](#) on page 3952.

The **Selected Chart** window appears.

4. Optional: Click the **Switch Widget** button to change widgets.
5. Click **Next**.

The **Construct Your Query** window appears.

6. Enter the query information to construct your dashboard. For reference to create a widget query, see [Configuring a Line Bar Chart query](#) on page 3953.

7. Click **Next**.

The **Ready to build** window appears.

**8. Click Confirm.**

The widget appears in the dashboard.

## Bot Insight visualizations

The Bot Insight dashboards provide customizable widgets that you can use to gain insights for specific scenarios.

Bot Insight offers the following visualization widgets:

- **Gauge Chart**
- **KPI**
- **Vertical Bar Chart**
- **Line Bar Chart**
- **Clustered Line Bar Chart**
- **Horizontal Bar Chart**
- **Vertical Stacked Bar Chart**
- **Horizontal Stacked Bar Chart**
- **Vertical Clustered Bar Chart**
- **Horizontal Clustered Bar Chart**
- **Heat Map**
- **Pie Chart**
- **Donut Chart**
- **Line Chart**
- **Scatter Chart**
- **Bubble Chart**
- **Datatable Chart**
- **World Map**
- **US Map**

The **Pie Chart** widget enables you to visualize data in a circular statistical graphics that is divided into slices.

---

**Note:** Due to a limitation within the third-party recharts library, the data labels in a pie chart are overlapping if it contains many slices. As a result, the labels in a pie chart are not clear and are shown only when you hover over the slices.

---

The **Heat Map** widget enables you to visualize data as a heat map chart. You can specify the dates by function (day, week, month, or year) to drill down to specific information. This map displays all the possible available combinations of variable values in the X and Y axes. Blank heat map blocks appear if there the value attached to the variable is 0. The color of the heat map block depends on the value of the information displayed. A new window with all the relevant information appears when you hover your mouse over a particular heat map block.

The **Datatable Chart** widget enables you to view and analyze information about all the logged data in a tabular chart. You can select the attributes and metrics based on your requirement. All the available attributes and metrics are selected by default.

The **World Map** widget provides information about the data variables and enables you to drill down to specific information:

1. Country



2. State
3. Zip Code
4. Latitude
5. Longitude

The **US Map** widget provides the following information about the data variables and enables you to drill down to specific information:

1. Country
2. State
3. City
4. Zip Code

The **Line Bar Chart** and the **Clustered Line Bar Chart** widgets enable you to view and analyze information about your metrics and attributes. You can input two metrics and one attribute in **Line Bar Chart** widget, while in the **Clustered Line Bar Chart** widget, a **Sub group** option enables you to add one more attributes if necessary.

The widget displays a line bar graph aggregated by group values when only one attribute is selected or a clustered line bar graph aggregated by subgroup values when two attributes are selected. It displays group sectioning which forms multi-axes labels . You can use **Date** types as interval options, grouped by **Day, Week, Month, Quarter, and Year**, with the **Day** set as default.

[Configuring a Line Bar Chart query](#) on page 3953

Related tasks

[Adding a dashboard widget](#) on page 3951

You can add custom widgets to the Bot Insight dashboard based on your requirements.

## Configuring a Line Bar Chart query

You can construct a custom query based on specific parameters to apply to your widget for line bar and clustered line bar charts.

After you are in the **Construct Your Query** window, follow these steps to select parameters to apply to your widget:

- Construct your query settings.

The query settings vary from widget to widget, but the selection process remains the same.

- a) Enter the title of your widget in the **Chart Title** field.
- b) Select a metric option in the **Metric** or **Select Metrics** field.  
For **Line Bar Chart** and **Clustered Line Bar Chart**, the **Metric** field is renamed to **Y1 Axis** and **Y2 Axis**.
- c) Select an aggregated value in the **Aggregated By** field.  
For **Line Bar Chart** and **Clustered Line Bar Chart**, the **Aggregated By** field is renamed to **Y1 Aggregated By** and **Y2 Aggregated By** with the same options.
- d) Select a value from the **Group By** or **Group 1** field.
- e) Select a secondary value from the **Sub Group By** or **Group 2** field.

---

**Note:** The **Sub Group By** or **Group 2** field is not available in the **Line Bar Chart**. For the **Metric**, **Group By** and **Sub Group By** fields, the first value is shown as the default value.

---

- f) Select a date value in the **Date Interval** field.
- 

**Note:** This field appears when you select the Date Type variable in the **Group By** and **Sub Group By** fields.

---

- Construct your advanced query settings.

You can enable more options to any widgets that support advanced settings.

- a) Click **Advanced Settings**.

The settings display the default values. You can change the value of the fields if required.

- b) Select a limit value in the **Limit** or **Group Limit** field.
- c) Select a sort value in the **Sort By** or **Group Sort By** field.
- d) Select a sort order value in the **Sort Order** or **Group Sort Order** field.
- e) Select a secondary limit value in the **Sub Group Limit** or **Group 2 Limit** field.
- f) Select a secondary sort value in the **Sub Group Sort By** or **Group 2 Sort By** field.
- g) Select a secondary sort order value in the **Sub Group Sort Order** or **Group 2 Sort Order** field.
- 

**Note:** The **Sub Group Limit**, **Sub Group Sort By** and **Sub Group Sort Order** fields are not available in the Line Bar Chart.

---

## Editing a dashboard widget

You can edit the dashboard widget properties based on your requirements.

You can resize and save the widgets in the Bot Insight dashboard based on your requirements. When you resize a dashboard widget, other widgets in the dashboard are automatically adjusted to fill in the available layout.

---

**Note:** Bot Insight allows you to resize widgets in the standard and the customized dashboards. However, it does not allow you to save the widgets after resizing in the standard dashboard.

---

1. Open the dashboard widget.
2. Click the **Edit** button.

The **Edit** window appears.

The **Edit** menu offers the following options:

Chart Title	Renames the chart
Metric	Changes the units
Aggregate By	Displays the run time (such as minimum, maximum, average, and summation) of each bot

Group By

Changes the parameters based on which the widgets are grouped together

3. Click the bottom of a widget to change the attribute of the chart displayed within the widget.
4. Click **Save As** to save the widget.

## Drilling down information in dashboard widget

You can drill down information from a dashboard widget based on your requirement. Select the options available in the drop-down list to view specific information in the dashboard widgets.

To use the drill down function feature in the Bot Insight dashboard widget, do the following:

1. Open the dashboard and select the widget.
2. Right-click to view the **Drill Down** menu.

**Drill Down** menu sample for a mortgage analytics processing bot :

- **Gender**
- **Mortgage Type**
- **Customer ID**
- **Company Name**
- **Email**
- **Loan Due Date**
- **Loan Origin Date**

---

**Note:** Bot Insight dynamically generates the **Drill Down** menu options based on the variables you tag when creating the bot.

---

## Renaming a dashboard widget

You can rename a dashboard widget based on your requirement. The default name of a dashboard widget is based on the type of information that the widget displays.

To rename a widget in the Bot Insight dashboard, do the following:

1. Open the dashboard for the widget to edit.
2. Rollover and click the **Edit** button.  
The **Edit Chart** window appears.
3. In the **Chart Title** field, enter the name of the widget.
4. Click **Next**.  
The **Ready to build! Click Finish** window appears.
5. Click **Finish**.  
The **Widget Updated** message appears.

## Exporting data from a dashboard widget

You can export data from the Bot Insight **Custom Business** dashboard widgets to CSV files based on the requirement.

1. Open the dashboard.
2. Identify the widget.
3. Click the **Actions** icon.
4. Click **Export**.

The CSV file is automatically saved in your local drive as `Chart name_summary_dd_mm_yyyy`.

## Data connector for Power BI

The data connector for Power BI enables you to establish a secure connection to Power BI, and generate and visualize data analytics. You can connect to the Bot Insight APIs in Power BI and apply specific parameters for each of the APIs.

The connector transforms the Bot Insight API responses to data visualizations in Power BI. The data connector for Power BI enables you to perform the following functions in Power BI:

- Authenticate and connect to the Control Room.
- Connect to APIs.
- Generate API responses.
- Transform the API responses to create a data model.
- Create visuals, charts or graphs, to represent the data.
- Create reports.
- Share reports with other users on Power BI.

You can access the following APIs from Power BI:

- `getaudittrialdata`
- `getbotrundata`
- `gettaskvariableprofile`
- `gettasklogdata`

---

**Note:** Automation Anywhere Power BI connector is certified and available as part of the Microsoft Power BI Desktop August release. The connector is available in the **Other** section of the **Get Data** dialog box in Power BI.

---

To update your Power BI to the latest certified release version and use the connector plug-in, manually deploy the data connector in Power BI. This enables you to retrieve information from the Bot Insight API for data analytics.



**Trouble:** When you attempt to refresh the data in a Microsoft Excel worksheet, an authentication error can occur from multiple simultaneous attempts through open windows and tabs. To avoid this error, perform the following steps:

1. In the Power BI desktop application, navigate to **File > Options and settings > Options**.

2. From the Current File section, select **Data Load**.

---

**Note:** Do not select **Data Load** from the Global section.

---

3. Disable the check box for **Enable parallel loading of tables**.
- 

Related information

[Microsoft Power BI](#)

## Deploy Power BI connector

Deploy the data connector in Power BI to retrieve information from the Bot Insight API to enable data analytics.

The connector can now be accessed directly from the Power BI desktop application. Ensure you meet the following prerequisites.

- You should be using Power BI desktop version 2.92.943.0 or above.
- You know your Automation Anywhere Control Room version.
- You have your Control Room credentials.
- You have your Control Room URL.

The following steps describe how to deploy the connector.

1. From your Power BI desktop application, select **Get data**.
2. In the search field, type and select `Automation Anywhere`.
3. Click **Connect**.
4. From the Login dialog box, enter your Control Room version and URL.
5. Enter your Control Room credentials.
6. Click **Connect**.

[Configure Power BI connector](#) on page 3957

## Configure Power BI connector

Configure the data connector in Power BI to retrieve information from the Bot Insight API to enable data analytics.

Ensure that you have the `Bot Insight Admin`, or `AAE_Admin` role assigned to you in the Control Room.

---

**Note:** A `Bot Creator` license is required to generate a default dashboard with `tasklogdata` for Power BI.

---

**Note:** The Power BI Connector is supported with Database Authenticated Control Room and Active Directory authentication.

---

1. Log in to the Power BI.
2. Click **Get Data**.

The list of all the Power BI certified connectors appears.

- For information about how to access non-certified custom connectors, see [Connector extensibility in Power BI](#).
  - When you update the dataset of two or more datasets, you might observe the **Authentication 500 Internal server error**. For resolving this error, see [Automation 360 | Authentication 500 Internal server error while refreshing in power BI \(A-People login required\)](#).
3. Select Automation Anywhere and click **Connect**.
  4. In the **Automation Anywhere - Login** window, enter the following information:
    - a) In the **Control Room Version** drop-down menu, select the version of the Control Room.
    - b) In the **Control Room Host** field, enter the IP address or the host name of the Control Room server.
    - c) In the **Bot Insight Host** field, enter the IP address or host name of the Bot Insight server.
  5. Click **OK**.
  6. In the **Automation Anywhere Login** window, enter your Bot Insight user name and password.

To provide the credentials for Active Directory authentication, you must enter the domain name delimited by a double backslash (\\) along with the user name in the **User name** field. For example: domain name\\user name.
  7. Click **Connect**.

The Bot Insight APIs are authenticated and the authorization tokens are generated. The Bot Insight APIs are loaded dynamically from Swagger, along with the applicable request parameters.
  8. Select the required Bot Insight API from the **Navigator** menu and enter the information in the respective fields.
  9. Click **Load**.

The API retrieves specific information from the server.

To learn how to retrieve information from Bot Insight APIs in Power BI, see [Bot Insight API](#).
  10. Click **Transform Data** to convert the structured JSON response to a visual data model.

Related information

[Transform, shape, and model data in Power BI](#)

[Create reports and dashboards in Power BI](#)

[Collaborate, share, and integrate across products with Power BI](#)

## Example: Retrieve information in Power BI using business information API

The Power BI connector enables you to access the Bot Insight API from Power BI. This example task shows you how to retrieve information from the Bot Insight API and build data visualizations in Power BI.

1. Open Power BI.
2. Open the **Navigator** window, and log in to the Control Room by entering the credentials.
3. In the **Display Options** menu, select **fx Business Information** check box.

The **API** window appears.

4. In the **botName** field, enter the name of the bot, or the task for which you want to visualize the analytical data.

To enter multiple bot names, separate each name with a comma.

For example, `SalesAPAC,SalesEMEA,SalesUS`.

5. In the **pageNo** field, enter the offset value for the rows or records that you want to retrieve.
  - If page = 0, and limit =1000, then rows 0 -1000 will be retrieved.
  - If page = 1, and limit =1000, then rows 1001 -2000 will be retrieved.

6. Optional: In the **fromDate** field, enter the date from when you want to retrieve the information.

Format: `yyyy-mm-dd`, or `yyyy-mm-ddTh:m:s.msZ` (2020-02-20T12:45:23.000z)

---

**Note:** If you do not enter a date, the API will return all available data.

7. Optional: In the **toDate** field, enter the date till when you want to retrieve the information.

Format: `yyyy-mm-dd`, or `yyyy-mm-ddTh:m:s.msZ` (2020-03-21T15:45:32.000z)

---

**Note:** If you do not enter a date, the API defaults to the current date.

8. In the **limit** field, enter the number of rows or records you want to retrieve.
9. Click **Apply** and then click **Transform Data** to convert the structured JSON response to a visual data model.
10. Click **Record** and then click each list item until you drill down to the last element in business information.  
Power BI displays the data visualization.

## Configure Tableau web data connector in Bot Insight

The web data connector in Tableau enables you to establish a secure connection with Automation 360 and to extract, visualize, and analyze data from Bot Insight.

- Ensure that your user name is registered in the Control Room and that you have **Bot Insight Admin** or the **AAE\_Admin** role assigned to you.
- Ensure you have access to the desktop or public version of Tableau software.

---

**Note:** Single sign-on is not currently supported for Bot Insight. Connectors only work with the following authentication mechanisms.

- Control Room database based authentication
- Active directory based authentication

---

The Web data connector in Tableau enables you to perform the following functions in Tableau:

- Authenticate and connect to the Control Room.
- Connect to Bot Insight APIs for business and operational information.
- Use business and operational information to create a data model.
- Create charts or graphs to represent the data.

- Create reports and share them with other users on Tableau.
1. Open Tableau.
  2. Select **Web Data connector** from the **Connect** option in **Data** tab.
  3. In the **Web Data Connector** window, enter your Automation Anywhere URL in web data connector field: <control room url>/tableau/Login.html
  4. In the **Automation Anywhere - Login** window, enter the following information:
    - a) In the **Control Room Version** drop-down menu, select the version of the Control Room.
    - b) In the **Control Room URL** field, enter the URL or the host name of the Control Room.
    - c) In **User Name** and **Password** field, enter your Bot Insight user name and password.
  5. Click **Submit** to connect to Bot Insight APIs.
  6. Select either **Business Information** or **Operational Information** in the Bot Insight window.  
If you are an **AAE\_Admin**, you can choose between Audit APIs and Operations APIs.
  7. Click **Get Data**.  
Bot Insight API retrieves information from the server.
  8. Click **Update Now** to gather all the data from Bot Insight in Tableau.  
You can use the retrieved data from Bot Insight for data visualizations and analysis in Tableau.



## API References

The Automation 360 platform provides a comprehensive suite of API capabilities that enable customers, partners, and community developers to automate end-to-end processes using API.

Automation Anywhere APIs are Representational State Transfer (RESTful) APIs. REST APIs allow you to manage, administer, and run automations programmatically from your own application. By incorporating Automation Anywhere APIs into various software programs, you can simplify application integration across different platforms and reduce development effort. Automation Anywhere APIs provide a secure communication gateway to interact and exchange data.

Automation Anywhere APIs offer the following capabilities:

- Automation Anywhere APIs are based on industry standards and best practices.
- Several authentication methods and protocols are supported.
- Enable high performance and scalability of automation projects.
- Leverage AI and machine learning capabilities in automation work flows.

You can use the Automation Anywhere APIs to:

- Register your device using the Bot Agent API.
- Perform various functionalities in the Control Room using the Control Room APIs.

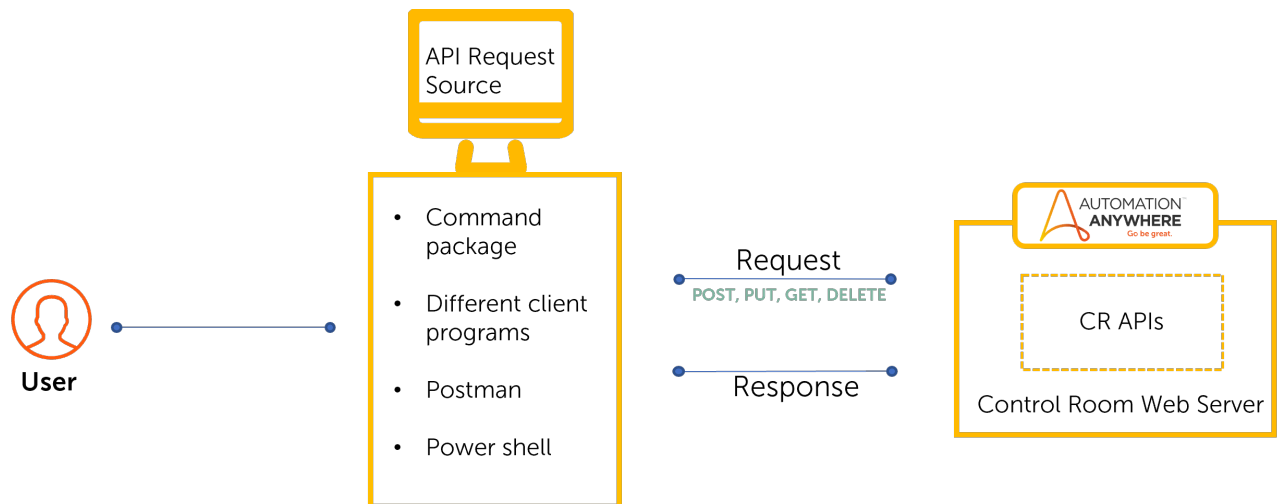

## Control Room APIs

The Automation Anywhere Control Room provides APIs that enable you to customize how you (and your automations) interact with Automation Anywhere.

You use Control Room APIs to:

- Manage bot deployments
- Create and manage credentials in the Credential Vault
- Create and manage user accounts and roles
- Create and manage queues

## API endpoints

You can view all the Control Room API modules and the associated endpoints in the following table:

Versions	Endpoints
v1	<ul style="list-style-type: none"> <li>• <a href="#">Authentication API</a></li> <li>• <a href="#">User Management API</a></li> <li>• <a href="#">Audit API</a></li> <li>• <a href="#">Device API</a></li> <li>• <a href="#">Automations API</a></li> <li>• <a href="#">Trigger API</a></li> </ul>
v2	<ul style="list-style-type: none"> <li>• <a href="#">Credential Vault API</a></li> <li>• <a href="#">Bot Execution Orchestrator API</a></li> <li>• <a href="#">Repository Management API</a></li> <li>• <a href="#">BotInsight API</a></li> <li>• <a href="#">BLM API</a></li> <li>• <a href="#">Device Pool API</a></li> <li>• <a href="#">Migration API (Data migration from 10x)</a></li> <li>• <a href="#">License API</a></li> <li>• <a href="#">Process Composer API</a></li> </ul>
v3	<ul style="list-style-type: none"> <li>• <a href="#">Bot deploy API</a></li> <li>• <a href="#">Workload Management API</a></li> <li>• <a href="#">Migration API (Bot migration)</a></li> <li>• <a href="#">Bot Execution Orchestrator API</a></li> </ul>
v4	<ul style="list-style-type: none"> <li>• <a href="#">Bot deploy API (V4)</a></li> </ul>

## Getting started with Control Room APIs

All requests must include an X-Authorization header with the JSON authentication token, or an Authorization header with a Bearer token for requests to the Control Room. The following sections provide details about the Control Room APIs available endpoints, methods, resources, authentication protocols, parameters, and headers, as well as examples of common requests and responses.

**Note:** The Bearer token is supported as of the Automation 360 v.27 release and later. It is unsupported and ignored in any previous releases. You must obtain the Bearer token from our OAuth services. To authorize your access, use either X-Authorization (using Authentication API) or Authorization (using OAuth). You cannot use both in the same API.

The Control Room supports several REST API clients. You can use Control Room swagger to view and run the APIs. Access the Control Room swagger by using the link <https://control->

room}/swagger/ and replace {control-room} with your Control Room instance. The following sections provide useful information about how to write a Control RoomAPI request:

- Some APIs require you to filter, paginate, and sort the results to get the desired output. For more information on filtering, pagination, and sorting, see [Filtering, pagination, and sorting](#) on page 3963.
- API response codes in the responses are described in the [API response codes](#) on page 3969.
- The [Comparing Automation 360 and Enterprise 11 APIs](#) on page 3970 compares the Enterprise 11 and Automation 360 APIs.

To learn how to test Control Room APIs in Swagger and Postman, watch the following video:

## Redoc view for API modules

You can now view the API modules in a redoc view. This view provides an intuitive interface where you can easily find information on using the Control Room APIs with comprehensive description and relevant code samples that you can reuse.

The layout is updated to a three-panel view which categorizes the API information into the following panes:

- Table of contents in the left pane.
- Introduction and descriptions in the center pane.
- Reusable code samples in the right pane.

This view includes details of each endpoint and examples on how to use them.

Related information

[API Reference \(Archived\)](#)

**v1**

**v2**

**v3**

**v4**

## Filtering, pagination, and sorting

The Control Room API supports filtering, pagination, and sorting for endpoints that return arrays of resources.

The filtering mechanism filters the required resources, the sorting mechanism places the resources in order; and the pagination mechanism then returns a specific range of those ordered

resources. This topic provides you the details to filter and sort the results of an API requests and also guides to handle the pagination of large result sets returned from an API request.

---

**Note:**

- Sorting and filtering are supported for substrings. For example, if you want to search for bots or files that have `fin` in their names, enter `fin` as the search criterion. All the bots and files that contain `fin` in the names will be displayed, for example, Finance, Finder, DeltaFinance, and Dolfin.
  - Wildcards are not supported for searching and filtering bots or files.
- 

## Filtering

Filtering allows you to apply Boolean condition against a collection of returned resources in order to subset the collection to only those resources for which the condition is `true`. The most basic operation in an Control Room API filters is to compare a field to a given value. It is possible to use equality comparison, range comparison, or logical . Use the following operators to compare a field to a constant value.

Operation	Description	Example
Equality comparison		
<code>eq</code>	Equals	UserEmailAddress, eq first.last@aa.com
<code>ne</code>	Not Equals	UserEmailAddress, ne first.last@aa.com
Range comparison		
<code>lt</code>	Less than	Quantity lt 1500
<code>le</code>	Less Than or Equal	Quantity le 1500
<code>ge</code>	Greater Than or Equal	CreatedDateUtc ge 2021-03-15
<code>gt</code>	Greater Than	CreatedDateUtc gt 2021-03-15
Logical		
<code>and</code>	And	Field1 eq 'abc' and Field2 eq 'def'
<code>or</code>	Or	Field1 eq 'abc' or Field2 eq 'def'

The `filter` query parameter allows you to apply basic, multiple, and convention oriented filters to a request. The filters in the Control Room APIs are applied with single parameter or with multiple parameters.

Single parameter filter

Single parameter filter allows the API request to select the responses by matching one or more members of the response to the value passed in the query. The single parameter filter is represented in the following image:

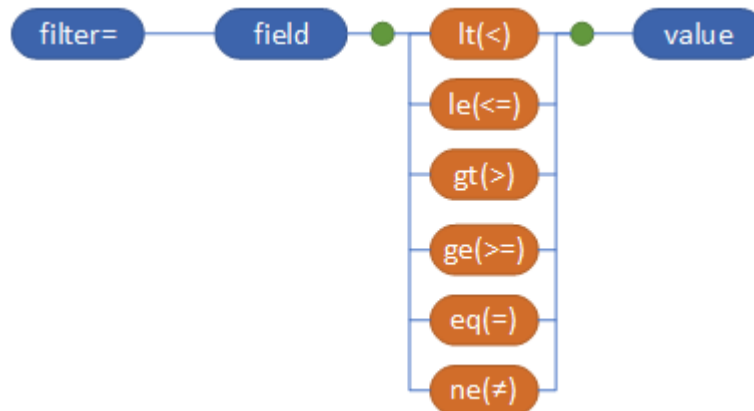

The JSON equivalent of the above image (single parameter filter) looks like:

```
{
  "filter": {
    "operator": "<NONE, lt, le, eq, ne, ge, gt, substring, and, or,
not>",
    "field": "string",
    "value": "string"
  }
}
```

For example, to list all the device pools that has a substring `finance`, use the following single parameter filter:

```
POST http://{{ControlRoomURL}}/v2/devices/pools/list
```

```
{
  "filter":{
    "operator":"substring",
    "field":"name",
    "value":"finance"
  }
}
```

For more detailed sample on a single parameter filter, see [Device Pools API](#) .

#### Multiple parameter filter

Multiple parameter filter allows you to filter the results based on combining multiple conditions wrapped in logical operands `and` and `or`.

- `and`: A binary operator that evaluates to `true` if all the conditions in the operands evaluate to `true`.

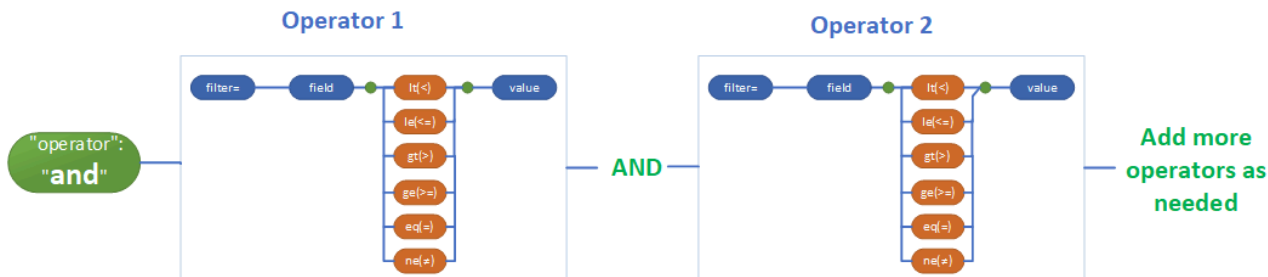

- `or`: A binary operator that evaluates to `true` if atleast one of the conditions in the operands evaluate to `true`.

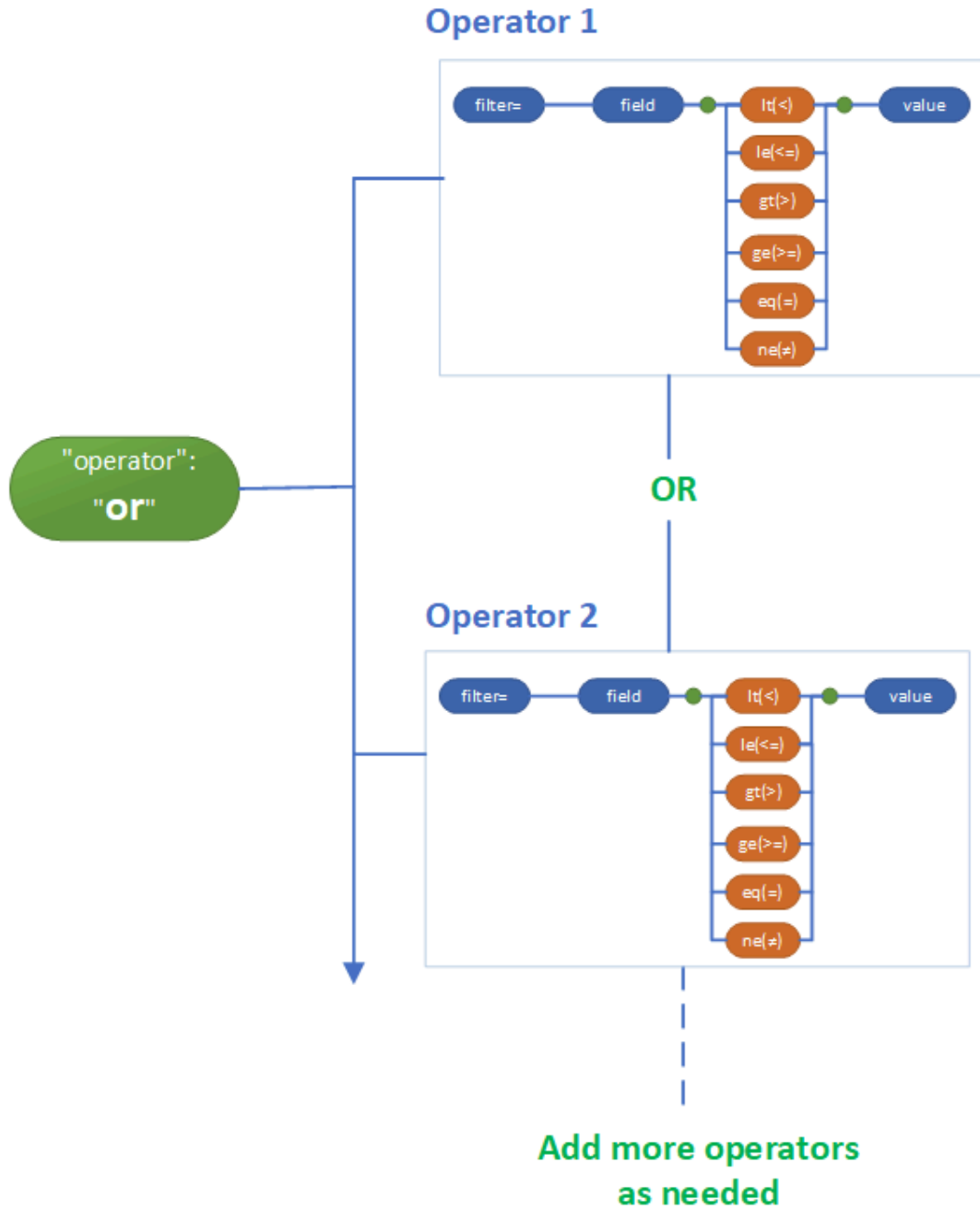

The JSON equivalent of the above image (multiple parameter filter) looks like:

```

{
  "filter": {
    "operator": "<and, or>",
    "operands": [
      {
        "operator": "<NONE, lt, le, eq, ne, ge, gt, substring, and, or, not>",
        "field": "string",
        "value": "string"
      }
    ]
  }
}

```

```

    },
    {
      "operator": "<NONE, lt, le, eq, ne, ge, gt, substring, and, or,
not>",
      "field": "string",
      "value": "string"
    }
  ]
}
}
}

```

For example, to list all the roles that has a substring Device, createdOn is after 2022-04-01, and createdOn is before 2022-05-31, use the multiple parameter filtering with logical add operator as follows:

```
POST http://{{ControlRoomURL}}/v1/usermanagement/roles/list
```

```

{
  "filter":{
    "operator":"and",
    "operands":[
      {
        "operator":"substring",
        "field":"name",
        "value":"Device"
      },
      {
        "operator":"gt",
        "field":"createdOn",
        "value":"2022-04-01T00:00:00.989Z"
      },
      {
        "operator":"lt",
        "field":"createdOn",
        "value":"2022-05-31T23:00:00.123Z"
      }
    ]
  }
}
}

```

For more detailed sample on a single parameter filter, see [User Management API](#) .

## Pagination

Pagination allows you to:

- Retrieve a limited collection of results.
- Offset a collection of results.

All Control Room APIs that returns a collection of records are paginated. API methods that support pagination takes two (optional) parameters:

Operation	Description
offset	The offset parameter controls the starting point within the collection of response results. Default value is 0.



Operation	Description
length	The length parameter is the maximum number of records to retrieve starting from the offset. Default value is 200.

The JSON snippet for pagination looks like:

```
"page":{
  "offset":5,
  "length":10
}
```

For more detailed sample on a single parameter filter, see [User Management API](#) .

## Sorting

Sorting allows you to order the results by any field, in ascending or descending order. For example, if you are returning the roles, you can sort the roles by last modified date.

```
"sort": [
  {
    "field": "string",
    "direction": "<asc, desc>"
  }
]
```

Direction

Type: Enum [ desc, asc ]

- asc = ascending (smallest to largest, 0 to 9, A to Z)
- desc = descending (largest to smallest, 9 to 0, Z to A)

For more detailed sample on a single parameter filter, see [User Management API](#) .

## API response codes

Review the HTTP status codes of responses for Automation 360 APIs.

Status code	HTTP name	Description
200	OK	Success
201	Created	Success, for POST, PATCH or PUT requests.
202	Accepted	Indicates that the request has been accepted for processing, but the processing has not been completed.
204	No content	Success, for DELETE requests and some PATCH requests.
400	Bad request	Request URL or request parameters are incorrect.

Status code	HTTP name	Description
401	Authentication required	Provide authentication details.
403	Unauthorized access	The operation is not authorized.
404	Not found	Control Room server did not find the requested URL.
409	Conflict	The request could not be completed because the code conflicts with the current state of the resource, for example, a duplicate entry.
500	Internal server error	Indicates that the server encountered a problem. Clear the cookies and cache, and then reload the page.

## Comparing Automation 360 and Enterprise 11 APIs

Compare Automation 360 and Enterprise 11 APIs to understand the contract changes when you migrate from Enterprise 11 to Automation 360.

API details	Enterprise 11	Automation 360
Authentication API: Use this API to obtain the authentication token. The token is then used for all subsequent API calls.		
Method	POST	POST
Endpoint	v1/authentication	v1/authentication
Request body changes	Not applicable	No change
Response body changes	Not applicable	<ul style="list-style-type: none"> <li>Multi-factor authentication is not supported</li> <li>Automation 360 response returns the tenantUUID</li> </ul>
Auto login credentials API: Use this API to set the Windows credentials for a Bot Runner. These credentials are used for automatically login (auto-login).		
Method	POST	PUT
Endpoint	v1/credentialvault/external/credentials/loginsetting	v2/credentialvault/loginsetting
Request body changes	Not applicable	Endpoint version change

API details	Enterprise 11	Automation 360
Response body changes	Not applicable	Message displayed after successfully updating the credentials: Credentials updated for <username>. Enterprise 11 displays this message: Credentials were successfully updated.
Automation management API: Use this API to create automations (schedule bots), and edit and delete automations.		
Method	POST, PUT, and DELETE	POST, PUT, GET, and DELETE
Endpoint	v1/schedule	v1/schedule
Request body changes	Not applicable	Minor change in request body to pass bot input variables
Response body changes	Not applicable	Detailed response with bot input variable details
User Management API: Use this API to create, edit, and delete users and roles.		
Method	POST, PUT, GET, and DELETE	POST, PUT, GET, and DELETE
Endpoint	v1/usermanagement	v1/usermanagement
Request body changes	Not applicable	No change
Response body changes	Not applicable	No change
Migration API: Use this API to migrate bots from Enterprise 11 or Enterprise 10 to Automation 360		
Method	GET and POST	GET and POST
Endpoint	<ul style="list-style-type: none"> <li>v1/migration</li> <li>v2/migration</li> </ul>	v2/migration
Response body changes	Not applicable	<ul style="list-style-type: none"> <li>Endpoint version change</li> <li>APIs used to connect to the Enterprise 10 database to migrate users, roles, schedules, and bots</li> </ul>
Request body changes	Not applicable	Because the endpoints and request body are different, the response body is also different.

API details	Enterprise 11	Automation 360
Manual Dependency API: Use this API to add or remove a dependency (data files and such) to or from a bot.		
Method	POST and DELETE	Not available
Endpoint	v1/files/ manualdependencies/	Not available
Request body changes	Not applicable	Not available
Response body changes	Not applicable	Not available
Repository Management API: Use this API to get bots and files from the Control Room repository.		
Method	POST, DELETE, and GET	POST, DELETE, and GET
Endpoint	v1/repository	v1/repository
Request body changes	Not applicable	Additional APIs added to get folder permissions
Response body changes	Not applicable	No change
File Dependency API: Use this API to get the file dependency metadata to run and schedule bots.		
Method	GET	Not available
Endpoint	v1/files/ manualdependencies/	Not available
Request body changes	Not applicable	Not available
Response body changes	Not applicable	Not available
Bot Lifecycle Management (BLM) API: Use this API to move (export or import) bots and dependent files across different Control Room environments.		
Method	POST	POST
Endpoint	v1/blm	v2/blm
Request body changes	Not applicable	<ul style="list-style-type: none"> <li>Endpoint version change</li> <li>You cannot choose dependencies when exporting and importing</li> </ul>
Response body changes	Not applicable	No change
Audit API: Use this API to get audit information about the product.		
Method	POST	POST
Endpoint	v1/audit	v1/audit
Request body changes	Not applicable	No change
Response body changes	Not applicable	No change
Two-factor Authentication (2FA) API: Use this API to generate a 2FA token		

API details	Enterprise 11	Automation 360
Method	GET and POST	Not available
Endpoint	v1/mfa	Not available
Request body changes	Not applicable	Not available
Response body changes	Not applicable	Not available
Credential Vault API: Use this API to create, edit, and delete credentials and lockers.		
Method	POST, PUT, GET, and DELETE	POST, PUT, GET, and DELETE
Endpoint	v2/credentialvault	v2/credentialvault
Request body changes	Not applicable	No change
Response body changes	Not applicable	No change
Bot Execution Orchestration API: Use this API to get the repository, automations, and devices list.		
Method	POST	POST, PUT, GET, and DELETE
Endpoint	v2/automations/deploy	v3/automations/deploy
Request body changes	Not applicable	Bot deployment includes run-as users
Response body changes	Not applicable	Returns deploymentID. Enterprise 11 API response returns automationID.
License API: Use this API to get product license information.		
Method	GET	GET
Endpoint	v2/license	v2/license
Request body changes	Not applicable	No change
Response body changes	Not applicable	Additional APIs added to update with license server and additional details
Workload Management (WLM) API: Use this API to create, edit, and delete workload queues, templates, and work items.		
Method	POST, PUT, GET, and DELETE	POST, PUT, GET, and DELETE
Endpoint	v2/wlm	v3/wlm
Request body changes	Not applicable	No change
Response body changes	Not applicable	More APIs to manage WLM entities
Bot Insight API: Use this API to get Bot Insight data for an automation.		

API details	Enterprise 11	Automation 360
Method	POST, GET, and DELETE	POST, GET, and DELETE
Endpoint	v2/botinsight/data/api	v2/botinsight/data/api
Request body changes	Not applicable	No change
Response body changes	Not applicable	No change
Bot Insight JSON API: Use to get business insights for an automation.		
Method	GET	Not applicable
Endpoint	v2/botinsight/data/api	Not applicable
Request body changes	Not applicable	Not applicable
Response body changes	Not applicable	Merged with Bot Insight API

Related concepts

[Control Room APIs](#) on page 3961

The Automation Anywhere Control Room provides APIs that enable you to customize how you (and your automations) interact with Automation Anywhere.

## Configure the Control Room

Before you start creating workflows for bot deployment and workload management using Control Room APIs, ensure you complete specific prerequisites and steps in the Control Room.

Ensure you have following licenses and permissions:

- One or more Bot Creator and unattended Bot Runner licenses.
- Control Room admin credentials to view, create, and configure users, roles, and device pools.
- The **Create device pools** feature permission or the **AAE\_Pool Admin** role must be assigned to you.

Follow these steps to configure your Control Room with users, roles, and bots.

1. Log in to the Control Room as an admin.
2. Create a Control Room user.  
Ensure that the user is assigned the **AAE\_BASIC** role.  
[Create a user](#) on page 1739
3. Create a custom role to map the users you created to Bot Runners and Bot folders.
  - a) In the **Features** tab, ensure you select these permissions: **View my Scheduled Bots**, **Schedule my bots to run**, **Run my Bots**, **View my Bots**, and **Generate my API Key**.
  - b) In the **Automation** tab, expand the **Bots** folder and select the root folder or subfolders you want to provide access for use. Ensure you select these permissions: **Run and schedule** and **View content**.
  - c) In the **Run as** tab, select one or more Bot Runners from the list of **Available bot runners**.
  - d) In the **Users** tab, select the new user created in Step 1 to assign the custom role to this new user.

4. Create a new device pool.  
In the **Consumers** tab, ensure you select the custom role you created in Step 3.  
[Create device pools](#) on page 1883
5. Log in to the Control Room as a Bot Creator and create bots to automate routine business tasks.  
[Build a Go be Great bot](#) on page 3198  
Ensure you check in the bots in the `Bot` folder or folders selected when creating the custom role (Step 3). [Check in a bot](#) on page 2301

## Roles and permissions

Assign roles from the Automation 360 Administration user interface or through the User Management API to enable users to access features. You can assign a system-created role or create a custom role with specific permissions.

Roles are a logical container for permissions and have interdependencies with bots, users, and licenses. Users with the `AAE_Admin` role can create custom roles and assign roles to users.

Related concepts

[Code analysis](#) on page 2178

Code analysis (code review) enables you to evaluate a program without running the code. When you review the code, a list of violations based on a set rules are displayed. You can review and fix any coding or stylistic errors for your automation.

Related reference

[Feature permissions for a role](#) on page 1749

A user with the **Manage roles** permission can create and assign roles to users to provide them with access to features and operations.

## System-created roles

Automation 360 includes predefined roles that cannot be edited or deleted. Each role has the standard permissions, plus the permissions necessary to perform the tasks within the scope of that role.

### Standard permissions

All system-created roles include the following permissions:

- View dashboards
- View my in progress activity
- Manage my credentials and lockers
- Create standard attributes for a credential (except for Discovery Bot roles)
- View and manage my Bot runners, Bot creators, and devices
- View and manage my queues
- View users and roles basic information

## Administration permissions

Enable users to create and manage users and roles, to manage and update migrations, and to install Control Room licenses.

You will be able to use the Retrieve role by ID. See [User Management API](#) endpoint with the role ID to retrieve the permissions assigned to any system or user defined roles.

### Users and roles permissions

Action	Resource Type	Description
usermanagement	usermanagement	Allows you to only view all other users in the system. You cannot create, edit, or delete users.  <b>Note:</b> You must assign this permission before assigning the <code>createuser</code> , <code>updateuser</code> , or <code>deleteuser</code> permission.
deleteuser	usermanagement	Allows you to delete other users the Control Room.
createuser	usermanagement	Allows you to create new users in the Control Room.
updateuser	usermanagement	Allows you to edit all users in the system.
rolesview	rolesmanagement	Users with this permission are able to view the roles in the Control Room.  <b>Note:</b> You must assign this permission before assigning the <code>rolesmanagement</code> permission.
rolesmanagement	rolesmanagement	Allows you to view and manage all roles in the Control Room.
viewuserrolebasicinfo	usermanagement	Allows you to view basic information on users and roles.

### Migration permissions

Action	Resource Type	Description
view	migration	Allows you to view new migrations, but not run them  <b>Note:</b> You must assign this permission before assigning the <code>manage migration</code> permission
manage	migration	Allows you to view and run new migrations



Action	Resource Type	Description
updatestatus	migration	Allows Bot Runner <b>Run-as</b> user to update the bot conversion status in the Control Room

## Licenses permissions

Action	Resource Type	Description
licensemanagement	licensemanagement	Allows you to view the license details for the Control Room.
licenseinstall	licensemanagement	Allows you to install Automation 360 licenses for the Control Room.
licenseuserallocation	licensemanagement	Allows you to assign device licenses to other users.

**Note:** Only a user with the `AAE_Admin` role has the ability to view and manage settings in the Control Room. See [System-created roles](#) on page 3975.

## Runtime Client Management permissions

Action	Resource Type	Description
runtimeclientsmanagement	runtimeclientsmanagement	Allows you to use the device mentioned in the resourceId for deployment. This permission is assigned when you are assigned a default device.
accessresourceany	runtimeclientsmanagement	Allows you to use any device for deployment. This permission is currently granted for all users with <code>AAE_ADMIN</code> role.

## Global Values Permissions

Action	Resource Type	Description
manageuserscopevalues	globalvalues	Manage tenant level global values, given to <code>AAE_Admin</code> only. This cannot be given to any custom role at the moment.
managetenantscopevalues	globalvalues	Not used, created for future purpose.

<sup>1</sup> Not available in the UI and is seen only in the API response.

## other permissions

Action	Resource Type	Description
systemadmin	system	This permission is given to AAE_Admin only.  It is a system call and cannot be called manually. This permission is used to count the number of pages consumed against the entitled pages for the IQ bot application.  It fetches a list of all the users with basic details and license information.
view	settings	View settings.  <b>Note:</b> You will be allowed to view settings only with the system-created Admin role to view Settings.
all	botrunners	Allows you to use any runAsUser for deployment. This permission is currently granted for all users with <u>AAE_ADMIN</u> role.
operationroom	operationroom	Legacy, not used and will be removed from the future releases.
manage	mfa	Legacy, not used and will be removed from the future releases.

## API permissions

Enables access to Bot Insight APIs and the ability to generate an API key.

Action	Resource Type	Description
botinsightapi	api	Allows access to Bot Insight RESTful APIs to the data logged by the Control Room and by a task during production runs.
generateapikey	api	Generate an <b>apiKey</b> that can be used in the Authentication API.  <b>Note:</b> Without the <code>generateapikey</code> permission, use APIs by authenticating using their username and password.
coadmin	botinsightapi	Reserved. Not used for now and will be used when COE dashboard is available in Automation 360. Allows you to access the COE dashboard when it is made available in Automation 360.
accessreportingapi	iqbotapi	Allows you to access reporting details via an API.

Action	Resource Type	Description
accessuploadanddownloadapi	uploadapi	Allows you to upload a document and download the digitized result via an API.
accessnlpapi	iqbotapi	Allows you to access natural language processing capabilities of the IQ Bot portal via an API.

## Audit log permissions

View audit logs and details to record user activities. Enable users to view logs from the Control Room.

Action	Resource Type	Description
recentactivities	recentactivities	Allows you to view all audit log activity for the Control Room
archiveaudit	recentactivities	Allows you to archive all audit log activity for the Control Room

## Automation Co-Pilot (Previously named AARI) permissions

Assign Automation Co-Pilot permissions to a custom role.

Action	Resource Type	Description
aaricrosssteamread	aari	View all teams and see the team members
aaricrossprocessread	aari	View all processes and see team members and managers
aariteammanagement	aari	Create and view teams, edit team names, descriptions, and process tags. Add new teams, team members, and assigned processes
aaritaskmanagement	aari	Submit and view tasks from processes that are assigned to the team
aaricasemanagement	aari	Create and view requests from processes that are assigned to the team
aariglobalcasemanagement	aari	View process requests and tasks.  <b>Note:</b> This permission does not grant the ability to create a request or submit a task
aariglobalprocessmanagement	aari	View checked-in public processes and assigned managers and teams, edit process tags, and assign managers and teams  <b>Note:</b> This permission does not grant the ability to create a process.

Action	Resource Type	Description
aariglobalteammanagement	aari	View teams and assigned users, edit team names and descriptions. Add new processes, managers and users to a team  <b>Note:</b> This permission does not grant the ability to create a team.
aarischeduler	aari	Allows users to be used as Automation Co-Pilot scheduler

## Bot and bot credential permissions

Enables users to access features for managing bots and the credentials used by bots.

### Bots permissions

Action	Resource Type	Description
view	repositorymanager	Allows you to view the bots they created and bots that were assigned to them.  <b>Note:</b> You must assign this permission before assigning any other bots permissions.
run	repositorymanager	Allows you to run the bots they created and bots that were assigned to them.
export	repositorymanager	Allows you to export bots and related bot dependencies for which they have download permission.
import	repositorymanager	Allows you to import bots and bot dependencies for which they have upload permission.
createfolders	repositorymanager	Allows users to create folders within the folders that they have access to.
renamefolders	repositorymanager	Allows you to rename the folders they have access to.  <b>Note:</b> Only empty folders can be renamed.
cancelcheckout	repositorymanager	Allows you to cancel bot checkout and unlock the file from the public repository.
forceunlock	repositorymanager	Allows you to unlock locked bots.

Action	Resource Type	Description
accessresourceany	repositorymanager	Allows you to get permissions to the resources. For example, runtimeclientsmanagement, pool, queue and so on.
setproductionversion	repositorymanager	Allows you to set the production version of bots.
all	repositorymanager	Allows you to get all the repository permissions.
gitrestore	repositorymanager	Allows you to get git restore permissions.

## Credentials and lockers permissions

Action	Resource Type	Description
managecredentials	credentials	Allows you to create, edit, and delete their own credentials. In addition, the user can interact with credentials from their assigned lockers.  <b>Note:</b> All roles have this permission by default.
create	locker	Allows you to create and manage their own lockers.
consume	locker	Allows you to consume a locker locker
createstandard	credentialattribute	Allows you to create a standard attribute for a credential that is shared across all users of that credential .
updateany	credentialattribute	Allows you to view and edit their own masked attributes.
botautologinapi	credentialattribute	Allows you to automate the login process to run bots remotely.
addcredential	credentialmanager	Legacy, not used and will be removed from the future releases.
updatecredential	credentialmanager	
deletecredential	credentialmanager	

**Note:** A user with the `AAE_Locker_Admin` role can view all credentials and lockers in the Control Room. See [System-created roles](#) on page 3975.

## Bot Store permissions

Enables users to view and manage Bot Store packages.

Action	Resource Type	Description
view	botstore	Allows you to view Bot Store.
addfrom	botstore	Allows you to add bot packages from Bot Store to their Control Room private workspace.
submit	botstore	Allows you to submit bot packages to Bot Store.

## Dashboard and activity permissions

Enables all users to view dashboards. Activity permissions enable users to view, manage, and schedule bot activities.

### Dashboard and Activity Permissions

Action	Resource Type	Description
view	dashboard	View dashboard.  <b>Note:</b> All roles have this permission by default.
myschedule	taskscheduling	All users can view their own activity.  <b>Note:</b> All roles have this permission by default.
managemyschedule	taskscheduling	All users can pause, resume, or cancel their own activity and move their finished activities to history.
manageeveryone	taskscheduling	A user can monitor ongoing automations where a user has either run or schedule access on the respective bot. The user can monitor and manage ongoing automations.
view	taskscheduling	Users can see their scheduled bots regardless of which user scheduled the bot.
addschedule	taskscheduling	It requires permission to view and manage Bot Runners.
updateschedule	taskscheduling	Users can edit their scheduled bots, even if the bots are scheduled by a different user.
deleteschedule	taskscheduling	Users can delete schedules for any of their bots regardless of which users scheduled the bot.
manageallmyfolders	taskscheduling	Users can view, edit, and delete all the schedules on the bot folders that the user has access to. This includes the schedules that the user created or schedules created by other users.

Action	Resource Type	Description
manageallschedules	taskscheduling	Users can view, edit, and delete all the schedules in the system. This includes the schedules that the user created or schedules created by other users.
setautomationpriority	taskscheduling	Users can set the automation priority to high from the default medium. Automations with high priority are deployed ahead of automations with medium and low priority.
everyoneschedules	taskscheduling	Users can monitor those ongoing automations where they have either run or schedule access on the respective Task Bot.

## Devices permissions

Enable you to register, view, and manage devices used to run bots.

Action	Resource Type	Description
register	devices	Allows you to register a localhost device.
all	devices	Allows you to view and manage all devices in the Control Room.
delete	devices	Allows you to delete devices that they registered.
edit	devices	<p>Allows you to edit the devices that they have permission to see.</p> <p>Allows you to view and manage all (registered and non-registered) devices from a specific accessible group.</p> <hr/> <p><b>Note:</b> To view and manage registered and non-registered devices,</p> <ul style="list-style-type: none"> <li>The Control Room administrator must grant access to manage a specific set of devices.</li> <li>You must select <b>Devices from my device pool(s)</b> to edit devices from device pools and <b>Run as user(s) default device</b> to edit Run as user(s) default device options in the <b>Edit devices</b> permission.</li> </ul> <hr/>
view	devices	<p>Allows you to view and manage Bot Creators, Bot Runners, and device pools.</p> <hr/> <p><b>Note:</b> All roles have this permission by default.</p> <hr/>
attestcredentials	devices	Allows you to deploy the bot during a session on the user's device without system password.

Action	Resource Type	Description
create	pool	Allows you to create and manage their own device pools.

**Note:** A user with the `AAE_Pool Admin` role is able to manage all device pools in the Control Room. See [System-created roles](#) on page 3975.

## Discovery Bot permissions

Enable users to view or manage Discovery Bot processes, recordings, aggregations, and opportunities.

### Process permissions

Action	Resource Type	Description
viewprocess	processdiscovery	Allows users to view assigned processes.  <b>Note:</b> This is the standard permission. You must assign this permission before assigning any process discovery permissions.
viewallprocess	processdiscovery	Allows users to view all the defined processes.
editprocess	processdiscovery	Allows users to create and edit processes.

### Recording permissions

Action	Resource Type	Description
viewrecording	processdiscovery	Allows users to view their own recording.  <b>Note:</b> You must assign this permission before assigning any of the permissions below.
createrecording	processdiscovery	Allows users to run recorder and create recording.
editrecording	processdiscovery	Allows users to edit their own recording.
deleterecording	processdiscovery	Allows users to delete their own recording.
viewallrecording	processdiscovery	Allows users to view all recordings.
editallrecording	processdiscovery	Allows users to edit all recordings.



## Aggregation permissions

Action	Resource Type	Description
viewmanualaggregation	processdiscovery	Allows users to view their own aggregations.
viewallaggregations	processdiscovery	Allows users to view all aggregations.
createdeletemanualaggregation	processdiscovery	Allows users to create and delete aggregations.
updatemanualaggregation	processdiscovery	Allows users to update aggregations.
viewssystemaggregation	processdiscovery	Allows users to view system aggregations.

## Opportunity permissions

Action	Resource Type	Description
viewopportunity	processdiscovery	Allows users to view opportunities within an assigned process.  <b>Note:</b> You must assign this permission before assigning any of the opportunity permissions.
editopportunity	processdiscovery	Allows users to edit opportunities within an assigned process.
viewalloppportunity	processdiscovery	Allows users to view all the opportunities.
createdeleteopportunity	processdiscovery	Allows users to create and delete opportunities within the assigned process.
converttobot	processdiscovery	Allows users to convert an opportunity to a bot.
exportopportunity	processdiscovery	Allows users to export an opportunity.

## Event triggers permissions

Enable users to run bots automatically depending on a specific event, such as a new window opening. You can limit users ability to only view or to view and manage triggers.

Action	Resource type	Description
view	eventtriggers	Allows users to view event triggers.
manage	eventtriggers	Allows users to view and manage event triggers.
managemytriggers	eventtriggers	Allows users to view and manage event triggers from their private repository, on their local devices.

Additionally, you must enable the view packages permission as well:

Action	Resource type	Description
view	packagemanager	Allows users to view packages

## IQ Bot permissions

Enable users to view IQ Bot permissions, create and manage learning instances, import and export domains, and manage IQ Bot configuration settings and migration.

### IQ Bot permissions

Action	Resource Type	Description
viewiqbot	iqbot	Allows you to view the default dashboards in the IQ Bot portal.  <b>Note:</b> You must assign this permission before assigning any of the permissions below.
view	iqbotpages	Allows to view the iqbot pages licensed
utilize	iqbotpages	Allows to utilize the iqbot pages licensed

### Learning instance permissions

Action	Resource Type	Description
viewlearninginstance	viewiqbot	Allows you to view their learning instances in the IQ Bot portal.  <b>Note:</b> You must assign this permission before assigning any other learning instance permission.
viewlearninginstancefromlearninginstance	viewlearninginstance	Allows you to view learning instances created by other you with the same role in the IQ Bot portal.
assignroletolearninginstance	viewlearninginstance	Allows you to assign some custom roles to a learning instance.
viewalllearninginstances	viewlearninginstance	Allows you to view all learning instances in the IQ Bot portal.
launchvalidator	viewlearninginstance	Allows you to access the IQ Bot Validator to review and update documents with exceptions.
createlearninginstance	viewlearninginstance	Allows you to create learning instances in the IQ Bot portal.
editlearninginstances	viewlearninginstance	Allows you to edit learning instances in the IQ Bot portal.

Action	Resource Type	Description
delelearninginstances	viewlearninginstance	Allows you to delete their learning instances in the IQ Bot portal.
sendlearninginstances	viewlearninginstance	Allows you to send their learning instances to production in the IQ Bot portal.
trainlearninginstances	viewlearninginstance	Allows you to train their learning instance groups in the IQ Bot portal.

## Domains permissions

Action	Resource Type	Description
viewdomain	viewiqbot	Allows you to view all domains in the IQ Bot portal.  <b>Note:</b> You must assign this permission before assigning any other domain permissions.
createdomains	viewdomain	Allows you to create domains in the IQ Bot portal.
editdomains	viewdomain	Allows you to edit domains in the IQ Bot portal.
importdomains	viewdomain	Allows you to import domains in the IQ Bot portal.
exportdomains	viewdomain	Allows you to export domains in the IQ Bot portal.
deletedomains	viewdomain	Allows you to delete domains in the IQ Bot portal.

## Administration permissions

Action	Resource Type	Description
viewadministration	viewiqbot	Allows you to access the <b>Administration</b> tab in the IQ Bot portal.  <b>Note:</b> You must assign this permission before assigning any other administration permissions.
viewandmanagesettings	viewadministration	Allows you to manage the IQ Bot portal advanced configuration settings.
viewandmanagemigration	viewadministration	Allows you to access the migration utility to import and export learning instances in the IQ Bot portal.

## MetaBot permission

MetaBots are obsolete in Automation 360. However, this permission is valid to ensure that all functionality previously available is supported in Automation 360.

Access to MetaBot Designer

Permission/feature ID is not available.

Bot Creator users can access MetaBot Designer to view, create, and update MetaBots.

---

**Note:** This feature is available for internal use only.

---

## Package manager permissions

Enable users to view and manage packages.

Action	Resource Type	Description
view	packagemanager	Allows you to view packages.
manage	packagemanager	Allows you to view and manage packages.

## Workload permissions

Enable you to create and manage workitems, workitem models, queues, and automations in the Control Room.

Action	Resource Type	Description
myschedule	taskscheduling	Allows you to view and manage their own schedules.
create	queue	Allows you to create and manage their own queues.

---

**Note:** A user with the `AAE_Queue Admin` role has all the above permissions. In addition, the `AAE_Queue Admin` is able to manage all the queues in the Control Room. See [System-created roles](#) on page 3975.

---

## How to find a migration journalid

Migrations can have more than one journalid. You can find the journalid in the response of a results list for a specific migration id.

In this request, we searched for results for the migration with the id 16.

```
<your_control_room_url>/v3/migration/16/results/list
```

The request returned the id in each object list as the journalid. In this example, there are two journal identifiers, 30 and 31, for the migration id 16.

```
{
  "page": {
    "offset": 0,
    "total": 2,
    "totalFilter": 2
  },
  "list": [
    {
      "sourceId": 12,
      "sourceName": "Dependency of IGN-23437.mbot",
      "sourcePath": "Automation Anywhere\\Bots\\My MetaBots\\
      \Dependency of IGN-23437.mbot",
      "sourceType": "application/vnd.aa.mbot",
      "targetId": 0,
      "status": "FAILED",
      "reason": "The logic IGN-23437 has some commands or actions
      which are not yet supported for migration.",
      "selectedByUser": true,
      "userId": 9,
      "id": 30,
      "targetName": "",
      "targetPath": "",
      "targetType": ""
    },
    {
      "sourceId": 12,
      "sourceName": "Dependency of IGN-23437.mbot",
      "sourcePath": "Automation Anywhere\\Bots\\My MetaBots\\
      \Dependency of IGN-23437.mbot",
      "sourceType": "application/vnd.aa.mbot",
      "targetId": 0,
      "status": "FAILED",
      "reason": "Migration of MetaBot failed.",
      "selectedByUser": false,
      "userId": 9,
      "id": 31,
      "targetName": "",
      "targetPath": "",
      "targetType": ""
    }
  ]
}
```

You can use the migration id and journal id in an action mapping request.

```
<your_control_room_url>/v3/migration/16/journal/31/actionmappings/list
```

## Bot Agent API: Auto registration

Automatically register and connect your device to a Control Room by using the Auto registration API.

This API uses the generic registration token from the `autoregistration.properties` file to register the device in the specified Control Room URL. You cannot autoregister the device

if the Control Room URL is not available in the `autoregistration.properties` file. The `autoregistration.properties` file must be available on your local system, and you must not delete the file after the registration is complete.

**Note:** To register the device from the command line or API, you must set the `AA_DELAY_REGISTRATION_UNTIL_LOGIN` MSI parameter. You can enable this parameter in the Bot Agent MSI file or in the `autoregistration.properties` file. For more information, see [Bulk install Bot Agent on devices](#) on page 1354. You can also view a sample `autoregistration.properties` file in the bulk install topic.

## Request

```
POST http://127.0.0.1:22113/v1/registration/auto
```

Request body:

```
{
  "url": "https://{controlroom url}",
  "userName": "dpcreator"
}
```

## Request parameters

Parameter	Type	Required	Description
url	String	Yes	Specify the Control Room URL to autoregister the device.
userName	String	No	Specify the Control Room user to associate the device as the default device.

## Response

```
{
  "result": "REGISTERED",
  "deviceId": "11",
  "crUrl": "control_room_url",
  "userName": "dpcreator",
  "installationType": "SYSTEM_WIDE",
  "crSwitchAllowed": "false",
}
```

## Response parameters

Parameter	Type	Description
result	String	Status of the device registration.

---

Parameter	Type	Description
deviceId	Number	Unique ID of the device the Bot Agent is installed on.
crUrl	String	The Control Room URL where the device is autoregistered.
userName	String	The username for which the device is associated as default device.
installationType	String	The type of installation that is performed.
crSwitchAllowed	String	Indicates whether the device can be registered on a different Control Room.

The REST API responds to each request with an HTTP response code. For response codes, see [API response codes](#) on page 3969.

# Index

## Numerics

2fa [1809](#)

## A

a-people access [3613](#), [3614](#)  
 a2019 [1474](#)  
 A2019 [3925](#)  
 A2019 IQ Bot [1429](#), [1440](#)  
 A2019 IQ Bot installation [1429](#), [1440](#), [1474](#)  
 A2019 IQBot [1429](#), [1440](#)  
 a360 advantages [990](#)  
 a360 benefits [990](#)  
 a360 feature benefits [990](#)  
 aa settings [1609](#)  
 AA Settings [1609](#)  
 AARI [3294](#), [3296](#), [3408](#)  
 AARI team [3377](#), [3387](#)  
 AARI team, aari team [3377](#), [3387](#)  
 AARI Web [3294](#), [3296](#), [3408](#)  
 AARI, service, extensions, embedded [3330](#)  
 aasettings [1609](#)  
 AAtaskname variable [2326](#)  
 access authconfig app [1848](#)  
 action [2279](#)  
 action package sdk [3509](#)  
 active [2121](#)  
 Active Directory [1375](#), [1378](#), [1384](#)  
   create  
     user [1740](#)  
 active directory integration [1043](#)  
 activity  
   historical [2138](#)  
   in-progress [2138](#)  
 Activity table [2127](#)  
 activity type [2121](#)  
 ad integration [1043](#)  
 add dll [2473](#)  
 Add Elasticsearch credentials [1259](#)  
 add ip [1808](#)  
 add packages [1908](#)  
 add-bots [2009](#)  
 add-device-pools [1888](#)  
 add-queue-owners [2001](#)  
 add-queues [1888](#)  
 Administration  
   overview [1737](#)  
 administrator mode [1387](#)  
 advanced [3509](#)  
   bots [3509](#)  
 ai actions [2626](#)  
 AI21 Labs chat AI  
   gen ai [2390](#), [2390](#), [2391](#), [2391](#), [2391](#), [2391](#), [2391](#), [2394](#),  
   [2394](#), [2626](#), [2627](#), [2627](#), [2627](#), [2628](#), [2628](#), [2630](#),

[2630](#), [2632](#), [2632](#), [2633](#), [2633](#), [2635](#), [2635](#), [2637](#),  
[2639](#), [2639](#), [2640](#), [2640](#), [2642](#), [2642](#), [2644](#), [2644](#),  
[2646](#), [2646](#), [2646](#), [2650](#), [2651](#), [2652](#), [2654](#), [2654](#),  
[2655](#), [2657](#), [3418](#)

generative ai [2390](#), [2390](#), [2391](#), [2391](#), [2391](#), [2391](#),  
[2394](#), [2394](#), [2626](#), [2627](#), [2627](#), [2627](#), [2628](#), [2628](#),  
[2630](#), [2630](#), [2632](#), [2632](#), [2633](#), [2633](#), [2635](#), [2635](#),  
[2637](#), [2639](#), [2639](#), [2640](#), [2640](#), [2642](#), [2642](#), [2644](#),  
[2644](#), [2646](#), [2646](#), [2646](#), [2650](#), [2651](#), [2652](#), [2654](#),  
[2654](#), [2655](#), [2657](#), [3418](#)

### AI21 Labs prompt AI

gen ai [2390](#), [2390](#), [2391](#), [2391](#), [2391](#), [2391](#), [2394](#),  
[2394](#), [2626](#), [2627](#), [2627](#), [2627](#), [2628](#), [2628](#), [2630](#),  
[2630](#), [2632](#), [2632](#), [2633](#), [2633](#), [2635](#), [2635](#), [2637](#),  
[2639](#), [2639](#), [2640](#), [2640](#), [2642](#), [2642](#), [2644](#), [2644](#),  
[2646](#), [2646](#), [2646](#), [2650](#), [2651](#), [2652](#), [2654](#), [2654](#),  
[2655](#), [2657](#), [3418](#)

generative ai [2390](#), [2390](#), [2391](#), [2391](#), [2391](#), [2391](#),  
[2394](#), [2394](#), [2626](#), [2627](#), [2627](#), [2627](#), [2628](#), [2628](#),  
[2630](#), [2630](#), [2632](#), [2632](#), [2633](#), [2633](#), [2635](#), [2635](#),  
[2637](#), [2639](#), [2639](#), [2640](#), [2640](#), [2642](#), [2642](#), [2644](#),  
[2644](#), [2646](#), [2646](#), [2646](#), [2650](#), [2651](#), [2652](#), [2654](#),  
[2654](#), [2655](#), [2657](#), [3418](#)

### aisense recorder [2257](#)

### amazon bedrock [2627](#)

gen ai [2390](#), [2390](#), [2391](#), [2391](#), [2391](#), [2391](#), [2394](#),  
[2394](#), [2626](#), [2627](#), [2627](#), [2627](#), [2628](#), [2628](#), [2630](#),  
[2630](#), [2632](#), [2632](#), [2633](#), [2633](#), [2635](#), [2635](#), [2637](#),  
[2639](#), [2639](#), [2640](#), [2640](#), [2642](#), [2642](#), [2644](#), [2644](#),  
[2646](#), [2646](#), [2646](#), [2650](#), [2651](#), [2652](#), [2654](#), [2654](#),  
[2655](#), [2657](#), [3418](#)

generative ai [2390](#), [2390](#), [2391](#), [2391](#), [2391](#), [2391](#),  
[2394](#), [2394](#), [2626](#), [2627](#), [2627](#), [2627](#), [2628](#), [2628](#),  
[2630](#), [2630](#), [2632](#), [2632](#), [2633](#), [2633](#), [2635](#), [2635](#),  
[2637](#), [2639](#), [2639](#), [2640](#), [2640](#), [2642](#), [2642](#), [2644](#),  
[2644](#), [2646](#), [2646](#), [2646](#), [2650](#), [2651](#), [2652](#), [2654](#),  
[2654](#), [2655](#), [2657](#), [3418](#)

### Amazon Bedrock ai [2628](#), [2630](#), [2632](#), [2633](#), [2635](#), [2637](#)

### Amazon Titan prompt AI

gen ai [2637](#)

generative ai [2637](#)

analytics [2484](#), [2880](#), [2882](#), [2885](#), [2887](#)

introduction to Bot Insight [3948](#)

analytics connector [3956](#)

analytics variable [3949](#)

analyze [1860](#)

Analyze [3925](#)

### annotation

creation [3563](#), [3564](#)

function [3563](#), [3564](#)

validation [3563](#), [3567](#)

annotations [3563](#), [3564](#), [3567](#)



- Anthropic chat AI
    - gen ai [2390](#), [2390](#), [2391](#), [2391](#), [2391](#), [2391](#), [2394](#), [2394](#), [2626](#), [2627](#), [2627](#), [2627](#), [2628](#), [2628](#), [2630](#), [2630](#), [2632](#), [2632](#), [2633](#), [2633](#), [2635](#), [2635](#), [2637](#), [2639](#), [2639](#), [2640](#), [2640](#), [2642](#), [2642](#), [2644](#), [2644](#), [2646](#), [2646](#), [2646](#), [2650](#), [2651](#), [2652](#), [2654](#), [2654](#), [2655](#), [2657](#), [3418](#)
    - generative ai [2390](#), [2390](#), [2391](#), [2391](#), [2391](#), [2391](#), [2394](#), [2394](#), [2626](#), [2627](#), [2627](#), [2627](#), [2628](#), [2628](#), [2630](#), [2630](#), [2632](#), [2632](#), [2633](#), [2633](#), [2635](#), [2635](#), [2637](#), [2639](#), [2639](#), [2640](#), [2640](#), [2642](#), [2642](#), [2644](#), [2644](#), [2646](#), [2646](#), [2646](#), [2650](#), [2651](#), [2652](#), [2654](#), [2654](#), [2655](#), [2657](#), [3418](#)
  - Anthropic prompt AI
    - gen ai [2390](#), [2390](#), [2391](#), [2391](#), [2391](#), [2391](#), [2394](#), [2394](#), [2626](#), [2627](#), [2627](#), [2627](#), [2628](#), [2628](#), [2630](#), [2630](#), [2632](#), [2632](#), [2633](#), [2633](#), [2635](#), [2635](#), [2637](#), [2639](#), [2639](#), [2640](#), [2640](#), [2642](#), [2642](#), [2644](#), [2644](#), [2646](#), [2646](#), [2646](#), [2650](#), [2651](#), [2652](#), [2654](#), [2654](#), [2655](#), [2657](#), [3418](#)
    - generative ai [2390](#), [2390](#), [2391](#), [2391](#), [2391](#), [2391](#), [2394](#), [2394](#), [2626](#), [2627](#), [2627](#), [2627](#), [2628](#), [2628](#), [2630](#), [2630](#), [2632](#), [2632](#), [2633](#), [2633](#), [2635](#), [2635](#), [2637](#), [2639](#), [2639](#), [2640](#), [2640](#), [2642](#), [2642](#), [2644](#), [2644](#), [2646](#), [2646](#), [2646](#), [2650](#), [2651](#), [2652](#), [2654](#), [2654](#), [2655](#), [2657](#), [3418](#)
  - anti-virus settings [1315](#)
  - API Bots [3499](#)
  - api filters [3963](#)
  - API key generation [1765](#)
  - API Migration [1716](#)
  - API Tasks [3494](#), [3504](#), [3506](#)
  - API-Key [1765](#)
  - Apigee [2413](#), [2414](#), [2416](#), [2417](#), [2421](#)
  - Apigee actions [2413](#)
  - Apigee Connect [2414](#)
  - Apigee Disconnect [2416](#)
  - Apigee package [2413](#)
  - app integration actions [844](#)
  - asynchronous [1317](#)
  - asynchronous replication [1239](#), [1486](#)
  - attended bot runner
    - license [1407](#)
  - attributes [3942](#), [3943](#)
  - audit [2143](#)
  - audit log [2143](#)
  - audit log controls [2143](#)
  - audit logs [2143](#), [2176](#)
  - authconfig app [1846](#)
  - authconfig app control rooms [1849](#)
  - authconfig app refresh tokens [1855](#)
  - authconfig app saml [1854](#)
  - Authenticate two-factor authentication [1809](#)
  - authentication [2391](#), [2627](#)
  - auto log in [1337](#)
  - auto login [1337](#)
  - auto mode [1378](#)
  - auto-login [1337](#)
  - auto-update bot agent [1361](#)
  - auto-update package [1906](#)
  - autologin [1337](#)
  - automatically login [1337](#)
  - automation [3949](#)
    - priority [1885](#), [1886](#)
  - automation 360 cloud [1058](#)
  - Automation Anywhere Enterprise
    - operating system compatibility [1194](#)
  - automation co pilot [3294](#), [3296](#), [3408](#)
  - automation co-pilot [3294](#), [3296](#), [3408](#)
  - Automation Co-Pilot [3294](#), [3296](#), [3408](#)
  - Automation Co-Pilot for Business Users [3296](#), [3408](#)
  - automation copilot for automators [3418](#)
  - automation packages [1898](#)
  - automation scale [1182](#)
  - automation success platform [1013](#)
  - automation timeout [2324](#)
  - aws [2390](#), [2391](#)
    - aws cloud integration [1964](#)
    - aws configuration postinstallation [1968](#)
    - aws credential retrieval [1971](#)
    - aws installation [1965](#)
    - aws integration [1963](#), [1965](#)
    - aws onprem authentication type [1968](#)
    - aws onprem installation [1965](#)
    - aws onprem installation requirements [1966](#)
    - aws onprem integration [1966](#)
  - aws sagemaker
    - gen ai [2390](#), [2390](#), [2391](#), [2391](#), [2391](#), [2391](#), [2394](#), [2394](#), [2626](#), [2627](#), [2627](#), [2627](#), [2628](#), [2628](#), [2630](#), [2630](#), [2632](#), [2632](#), [2633](#), [2633](#), [2635](#), [2635](#), [2637](#), [2639](#), [2639](#), [2640](#), [2640](#), [2642](#), [2642](#), [2644](#), [2644](#), [2646](#), [2646](#), [2646](#), [2650](#), [2651](#), [2652](#), [2654](#), [2654](#), [2655](#), [2657](#), [3418](#)
    - generative ai [2390](#), [2390](#), [2391](#), [2391](#), [2391](#), [2391](#), [2394](#), [2394](#), [2626](#), [2627](#), [2627](#), [2627](#), [2628](#), [2628](#), [2630](#), [2630](#), [2632](#), [2632](#), [2633](#), [2633](#), [2635](#), [2635](#), [2637](#), [2639](#), [2639](#), [2640](#), [2640](#), [2642](#), [2642](#), [2644](#), [2644](#), [2646](#), [2646](#), [2646](#), [2650](#), [2651](#), [2652](#), [2654](#), [2654](#), [2655](#), [2657](#), [3418](#)
- AWS Secrets Manager [1916](#)
- Azure [1282](#)
  - cluster configuration [1286](#)
  - customized cluster [1283](#)
- azure ai [2646](#)
- azure chat [2651](#)
- azure chat ai [2651](#)
- azure cloud integration [1954](#)
- Azure cluster environment [1281](#)
- azure configuration postinstallation [1948](#)
- azure credential retrieval [1955](#)
- azure installation [1948](#)
- azure integration [1947](#), [1948](#)
- Azure Key Vault [1916](#)
- azure onprem authentication type [1953](#)
- azure onprem installation [1950](#)
- azure onprem installation requirements [1951](#)
- azure onprem integration [1952](#)
- azure openai [2646](#)
- Azure prompt ai [2652](#)
- azureai [2650](#)

## B

background process [2242](#), [2940](#)  
backup  
    databases [1188](#)  
    DR [1244](#)  
basic auth eol [1123](#), [1128](#)  
basic mining [3837](#)  
bedrock [2627](#), [2627](#)  
best practices building bots [3596](#)  
bot action for Sales force [2973](#)  
bot action for Salesforce [2973](#)  
bot action Sales force [2978](#), [2980](#), [2981](#), [2983](#), [2984](#),  
[2985](#), [2987](#), [2988](#)  
bot action Salesforce [2978](#), [2980](#), [2981](#), [2983](#), [2984](#),  
[2985](#), [2987](#), [2988](#)  
bot actions sales force [2973](#)  
bot actions Salesforce [2973](#)  
bot agent resiliency [1021](#)  
bot best practices [3596](#)  
bot building best practices [3596](#)  
bot creator [1860](#)  
    license [1407](#)  
Bot Creator  
    ports required [1203](#)  
bot creator credentials [1860](#)  
bot export [1327](#)  
bot insight [3925](#)  
    license [1407](#)  
Bot Insight [3925](#)  
    using [3948](#)  
bot insight migration [1563](#)  
Bot Insight overview [3925](#)  
bot migration wizard [1590](#)  
Bot Permissions [3980](#)  
bot run timeout [2324](#)  
bot runner [1877](#), [1879](#), [2143](#)  
Bot Runner  
    ports required [1203](#)  
bot runner device requirements [1167](#)  
bot runner OS requirements [1167](#)  
bot runner requirements [1167](#)  
bot runner session [1877](#), [1879](#), [2143](#)  
Bot Runners  
    disaster recovery [1240](#), [1487](#)  
bot timeout [2324](#)  
botrunner requirements [1167](#)  
bots  
    advanced [3509](#)  
    first [1489](#)  
    hello world [1489](#)  
bots roll back [1822](#)  
bots unattended [3291](#)  
browsers [1210](#)  
bulk update package [1910](#)  
business analytics automation task [3949](#)  
business data [1033](#)

## C

cache storage [1317](#)  
caching [1317](#)  
Call a SAP BAPI function [3202](#)  
calm [1404](#)  
CALM [1404](#)  
calm portal [1404](#)  
CALM portal [1404](#)  
capacity [1182](#)  
capacity planning [1182](#)  
capture image [2804](#), [2806](#), [2807](#), [2807](#), [2809](#)  
ce [1326](#)  
Certificate [1249](#)  
certificates  
    required [1315](#)  
change [1747](#)  
change control room [1386](#)  
change key vault [1993](#)  
change password [1858](#)  
changed features [705](#), [716](#), [723](#), [730](#), [736](#), [744](#), [745](#)  
chat-bot [2026](#)  
check box [3671](#)  
check in [1767](#)  
check out [1767](#)  
citrix remote agent [1227](#)  
citrix servers [1227](#)  
citrix virtual apps [1227](#)  
client service  
    disaster recovery [1240](#), [1487](#)  
clip board [2447](#)  
clipboard [2447](#)  
Close [2412](#)  
cloud [1033](#)  
    install [1163](#)  
cloud control room ip address key vault [1829](#)  
Cloud communication ports [1172](#)  
cloud enabled [1033](#), [1369](#)  
cloud faq [1058](#)  
cloud integration aws secrets manager [1964](#)  
cloud integration azure key vault [1954](#)  
cloud integration cyberark password vault [1933](#)  
cloud license [1419](#)  
cloud security [1033](#)  
cloud services faq [1058](#)  
cloud updates [1072](#)  
cloud-enabled [1369](#)  
cluster  
    Control Room on Azure [1283](#)  
    processes [1482](#)  
Cluster [1261](#)  
cluster mode [1444](#)  
cluster setup [1245](#)  
co pilot [3294](#), [3296](#), [3408](#)  
Co-Pilot [3294](#), [3296](#), [3408](#)  
code analysis [2191](#)  
code review [2178](#), [2191](#)  
code view [990](#), [2191](#)  
codes [3969](#)  
comment actions [2452](#)

- comment package [854](#)
  - communication ports [1172](#)
  - community edition [1326](#), [1327](#)
  - Community Edition [1326](#)
  - compare a360 vs 11x [990](#)
  - compare a360 vs v11 [990](#)
  - compatibility version [2322](#)
  - compatible devices [1340](#)
  - configuration
    - AD mode [1378](#)
    - control room [1373](#)
    - DR [1239](#), [1486](#)
  - configure [3556](#)
    - Azure cluster [1286](#)
  - configure azure [2646](#)
  - configure azure openai [2646](#)
  - configure build files [3516](#)
  - Configure disaster recovery site for Elasticsearch [1319](#)
  - configure saml [1854](#)
  - configuring Control Room with HTTPS [1455](#), [1457](#), [1458](#), [1458](#)
  - configuring IQ Bot with HTTP [1455](#), [1457](#), [1458](#), [1458](#)
  - confirm installation [1449](#)
  - connected [1873](#)
  - Connection
    - Credential Vault [1813](#)
  - Control Room [1165](#)
    - Azure cluster configuration [1286](#)
    - Azure install [1282](#)
    - customize cluster [1283](#)
    - data center components [1026](#)
    - database [1188](#)
    - disaster recovery [1240](#), [1487](#)
    - HA and DR [1480](#)
    - ports required [1203](#)
  - control room configuration
    - workflow [1373](#)
  - control room cpu [1187](#)
  - Control Room log file [2209](#)
  - control room login [1488](#)
  - Control Room logs [2209](#)
  - control room ram [1187](#)
  - control room resiliency [1021](#)
  - control room service [1317](#)
  - control room storage requirements [1187](#)
  - copilot [3294](#), [3296](#), [3408](#), [3418](#)
  - copy bot [2308](#)
  - copy commands in bot [1052](#)
  - copy variables [2326](#)
  - counter variable [3193](#)
  - cpu for control room [1187](#)
  - CPUUsage variable [2326](#)
  - CR log files [2209](#)
  - cr server requirements [1187](#)
  - create [2291](#)
  - Create
    - role [1748](#)
  - create a learning instance [3642](#)
  - create folder [1859](#)
  - Create Iterator [3537](#)
  - create learning instance [3642](#), [3726](#)
  - create repository [1859](#)
  - create role [1860](#)
  - create user [1787](#), [1860](#)
  - Create user
    - Active Directory [1740](#)
  - create worksheet [2574](#)
  - create-queue [2000](#)
  - creation annotation [3563](#), [3564](#)
  - credential [1864](#)
  - Credential
    - edit [1865](#)
  - credential allow password [3568](#)
  - credential locker [1866](#)
  - credential name [1862](#)
  - credential vault [1862](#)
  - Credential Vault
    - connection [1813](#)
    - email notification [1869](#)
  - credentials [1861](#), [1864](#)
    - required [1315](#)
    - requirements [1197](#)
  - Credentials
    - overview [1861](#)
  - cryptographic ciphers [1051](#)
  - cryptographic provider [1051](#)
  - csv [1873](#), [2176](#), [2449](#)
  - current bot [2121](#)
  - current command [2121](#)
  - custom install [1245](#)
  - custom installation [1375](#), [1378](#), [1384](#)
  - custom launch cycle [1375](#), [1378](#), [1384](#)
  - custom mode [1270](#), [1375](#), [1378](#), [1384](#)
  - custom role [3638](#)
  - Custom trigger [3545](#)
  - custom triggers [3549](#)
  - custom variables [3528](#)
  - cyberark cloud integration [1933](#)
  - cyberark configuration postinstallation [1938](#)
  - cyberark credential retrieval [1941](#)
  - cyberark installation [1936](#)
  - cyberark integration [1926](#), [1936](#)
  - cyberark onprem installation [1936](#)
  - CyberArk Password Vault [1916](#)
- ## D
- dashboards [3926](#), [3929](#), [3932](#), [3935](#), [3942](#), [3943](#), [3950](#), [3952](#)
  - data center
    - Control Room [1026](#)
  - data extraction [3662](#), [3671](#)
  - data privacy [1033](#)
  - data security [1033](#)
  - database
    - control room [1188](#)
    - disaster recovery [1240](#), [1487](#)
    - server requirements [1188](#)
    - SQL [1188](#)

- database management system [1180](#)
  - database replication [1237](#), [1484](#)
  - databases
    - backup [1188](#)
    - recovery [1188](#)
  - debug [2277](#)
  - delete [2291](#)
    - scheduled [2138](#)
  - delete task [2279](#)
  - delete-work-item [2025](#)
  - delta migration [1584](#)
  - dependencies [2009](#), [2360](#)
    - uploading [2360](#)
  - deploy
    - HA [1235](#), [1237](#), [1484](#), [1484](#)
    - load balancer [1201](#)
    - model options [1230](#)
  - deprecated [705](#), [716](#), [723](#), [730](#), [736](#), [744](#), [745](#)
  - developer [3509](#)
  - developer sdk [3509](#)
  - device licenses [1782](#)
  - device pool [1883](#), [1887](#)
    - create [1883](#), [1887](#)
    - edit [1885](#), [1886](#)
    - update [1885](#), [1886](#)
    - view [1884](#), [1884](#)
  - device pool details
    - view [1884](#), [1884](#)
  - device requirements bot runners [1167](#)
  - devices [1873](#)
  - dictionary type variables [3289](#)
  - disaster recovery [1237](#), [1239](#), [1484](#), [1486](#)
    - failover steps [1240](#), [1487](#)
    - HA [1237](#), [1484](#)
    - sites [1244](#)
  - Disaster Recovery (DR) [1480](#)
  - disconnect action [2646](#)
  - disconnected [1873](#)
  - Discovery [3889](#)
  - Discovery Bot [3889](#)
  - disk space [1180](#)
  - DLL [2473](#)
  - do not repeat [3114](#)
  - doc widget [1159](#)
  - Document Validator Task [3646](#)
  - domain user account [1192](#)
  - DR
    - pre-configuration requirements [1239](#), [1486](#)
    - prepare [1244](#)
    - restore primary site [1487](#)
  - draw down [1419](#)
  - draw downs [1419](#)
- E
- Edit
    - credential [1865](#)
    - locker [1868](#)
  - edit profile [1858](#)
  - edit sql [1814](#)
  - edit task [2279](#)
  - edit-work-item [2025](#)
  - elasticsearch [1317](#)
  - Elasticsearch [1259](#), [1266](#), [1308](#), [1319](#), [1321](#)
  - Elasticsearch credentials [1259](#)
  - Elasticsearch IP addresses [1319](#)
  - Email
    - notifications
      - Credential Vault [1869](#)
  - embedded, AARI, extensions, deploy, blueprint, mod [3335](#)
  - enable debug [2277](#)
  - enable debug logging [2277](#)
  - enable oauth services [1846](#)
  - enabling two-factor authentication [1809](#)
  - entry list rest web services [3530](#)
  - eol [1086](#)
  - equal to [2430](#)
  - Error codes [3969](#)
  - error handler [2552](#)
  - event-based triggers [3549](#)
  - example [1767](#), [1787](#), [1860](#), [1861](#), [1862](#), [3229](#)
  - example bulk update [3259](#)
  - example repository [1859](#)
  - example, Genesys [3339](#)
  - example, ServiceNow, SAP, embedded, widget [3350](#)
  - example, Workday [3343](#)
  - excel [2558](#)
  - excel action [2587](#)
  - excel advanced [2565](#)
  - excel advanced package [2565](#)
  - excel basic [2558](#)
  - excel basic package [2558](#)
  - Execute Integration [2417](#), [2421](#)
  - expiry [1400](#), [1421](#)
  - export [2033](#), [2176](#)
  - export bot [2033](#)
  - export learning instance [3691](#)
  - exportbot [2033](#)
  - express launch cycle [1374](#)
  - express mode [1270](#), [1374](#)
  - extension [1678](#), [1678](#)
  - extension variable [1678](#)
  - external key vault integrations [1914](#)
  - external key vaults [1914](#)
  - extract text from image [2804](#), [2806](#), [2807](#), [2807](#), [2809](#)
- F
- failover mode [1237](#), [1484](#)
  - failover steps [1240](#), [1487](#)
  - failsafe [1400](#)
  - faq [1058](#)
  - feature matrix [3634](#)
  - feedback [3662](#)
  - feedback based validation [3662](#)
  - file [2291](#)
  - file name [2484](#), [2880](#), [2882](#), [2885](#), [2887](#)

file2 attribute [3532](#)  
filter apis [3963](#)  
filters [3942](#), [3943](#), [3963](#)  
find [2587](#)  
find text [2369](#)  
first bot [1489](#)  
first time configuration  
    control room [1373](#)  
fixed features [705](#), [716](#), [723](#), [730](#), [736](#), [744](#), [745](#)  
folder [2291](#)  
function annotation [3563](#), [3564](#)

## G

gcp migration [280](#)  
gen ai [2390](#), [2390](#), [2391](#), [2391](#), [2391](#), [2391](#), [2391](#), [2394](#), [2394](#),  
[2626](#), [2627](#), [2627](#), [2627](#), [2628](#), [2628](#), [2630](#), [2630](#), [2632](#),  
[2632](#), [2633](#), [2633](#), [2635](#), [2635](#), [2637](#), [2639](#), [2639](#), [2640](#),  
[2640](#), [2642](#), [2642](#), [2644](#), [2644](#), [2646](#), [2646](#), [2646](#),  
[2650](#), [2651](#), [2652](#), [2654](#), [2654](#), [2655](#), [2657](#), [3418](#)  
genai [2390](#), [2391](#), [2391](#), [2394](#), [2626](#), [2627](#), [2627](#), [2628](#),  
[2630](#), [2632](#), [2633](#), [2635](#), [2637](#), [2639](#), [2640](#), [2640](#),  
[2642](#), [2644](#), [2646](#), [2646](#), [2646](#), [2650](#), [2654](#), [2654](#),  
[2655](#), [2657](#), [3418](#)  
GenAI [3635](#), [3635](#), [3709](#), [3712](#)  
generate API key [1765](#)  
generative ai [2390](#), [2390](#), [2391](#), [2391](#), [2391](#), [2391](#), [2391](#), [2394](#),  
[2394](#), [2626](#), [2627](#), [2627](#), [2627](#), [2628](#), [2628](#), [2630](#), [2630](#),  
[2632](#), [2632](#), [2633](#), [2633](#), [2635](#), [2635](#), [2637](#), [2639](#), [2639](#),  
[2640](#), [2640](#), [2642](#), [2642](#), [2644](#), [2644](#), [2646](#), [2646](#),  
[2646](#), [2650](#), [2651](#), [2652](#), [2654](#), [2654](#), [2655](#), [2657](#), [3418](#)  
generative ai action [2626](#), [2627](#), [2628](#), [2630](#), [2632](#),  
[2633](#), [2635](#), [2637](#), [2639](#), [2640](#), [2640](#), [2642](#), [2644](#),  
[2646](#), [2646](#), [2646](#), [2650](#), [2651](#), [2652](#), [2654](#), [2654](#), [2655](#),  
[2657](#)  
generative ai package [2626](#)  
generativeai [2390](#), [2391](#), [2391](#), [2394](#), [2626](#), [2627](#), [2627](#),  
[2628](#), [2630](#), [2632](#), [2633](#), [2635](#), [2637](#), [2639](#), [2640](#),  
[2640](#), [2642](#), [2644](#), [2646](#), [2646](#), [2650](#), [2654](#), [2654](#)  
Genesys, action, contact [2665](#)  
Genesys, action, division [2662](#)  
Genesys, action, group [2667](#)  
Genesys, action, organization, company [2673](#)  
Genesys, action, package [2659](#)  
Genesys, action, queue, route [2679](#)  
Genesys, action, role, permission [2681](#)  
Genesys, action, skill [2685](#)  
Genesys, action, user, agent [2689](#)  
Genesys, language, action [2670](#)  
Genesys, phone, routing, action [2675](#)  
getting started [1374](#), [1375](#), [1378](#), [1384](#)  
Getting started  
    Control Room [1165](#)  
git ip address whitelist [1829](#)  
Git repository [1824](#)  
google connect [2640](#)  
google disconnect action [2646](#)  
google generative ai [2640](#), [2642](#)  
graph api [917](#)

graph-api [917](#)

## H

HA  
    processes [1482](#)  
HA high availability [1235](#), [1237](#), [1484](#), [1484](#)  
handle session [3553](#)  
hardware components [1340](#)  
hardware requirements [1429](#)  
hardware requirements bot runners [1167](#)  
healthcheck api response [1473](#)  
help center [1159](#)  
heuristic feedback [3662](#), [3688](#)  
High Availability [1261](#)  
High Availability (HA) [1480](#)  
historical  
    Activity [2127](#)  
historical activity [2127](#)  
how to filter [3963](#)  
http to https [1386](#)  
HTTPS [1201](#)  
https [1387](#)  
https from http [1386](#)

## I

idp integration [1372](#)  
idp integration steps [1372](#)  
ie eol [347](#)  
IE EOL [1100](#)  
image [2731](#)  
image recognition [2731](#)  
image recognition actions [2731](#)  
import [2035](#)  
import bots [2035](#)  
import certificate [1387](#)  
import learning instance [3691](#)  
in-product guide [1159](#)  
in-product help [1159](#)  
input types [3526](#)  
insight [3925](#)  
install  
    cloud [1163](#)  
    on Azure cluster [1281](#)  
Install A2019 iqbot [1429](#), [1440](#)  
Install IQ Bot [1429](#), [1440](#)  
Install IQBot [1429](#), [1440](#)  
install token [1369](#)  
installation [1245](#)  
    configuration requirements [1315](#)  
installation path [1387](#)  
installing IQ Bot Platform [1444](#)  
instance [2035](#)  
integrate aws secrets manager [1963](#)  
integrate azure key vault [1947](#)  
Integrate custom programs [3202](#)  
integrate cyberark password vault [1926](#)  
integrate idp [1372](#)

integration [844](#)  
integration actions [844](#)  
invoke sagemaker [2394](#)  
ip address [1322](#)  
ip address external apps integration [1829](#)  
ip address for external integration [1829](#)  
ip address key vaults [1829](#)  
ip address whitelisting key vault [1829](#)  
ip addresses  
    required [1315](#)  
ipall [1192](#)  
iq bot custom logic [3782](#)  
IQ Bot Custom Logic [3782](#)  
IQ Bot Custom Logic examples [3784](#)  
IQ Bot custom logic user guide [3784](#)  
IQ Bot Custom Logic User Guide [3784](#)  
IQ Bot Validator task [3646](#)  
IQBot Custom Logic [3782](#)  
Iterator [3537](#)

J

jdbc drivers [2482](#)

K

key vault integration [1914](#)  
key vault names [1921](#)  
key vault naming convention [1921](#)  
key vault utility [1993](#)  
key vault utility aws [1968](#)  
key vault utility azure [1948](#)  
key vault utility cyberark [1938](#)  
keyvault integration [1914](#)  
keyvault integrations [1914](#)  
keyvaults [1914](#)  
Kiwi Syslog Server [1815](#)  
known limitations [705](#), [716](#), [723](#), [730](#), [736](#), [744](#), [745](#)

L

language settings [1315](#)  
learning instance [3642](#), [3668](#), [3680](#)  
License  
    overview [1407](#)  
license expiry [1400](#)  
License expiry [1421](#)  
license portal [1419](#)  
license server [1407](#), [1786](#)  
list of key vault integrations [1914](#)  
list of keyvault integrations [1914](#)  
llm [2650](#), [2654](#), [2654](#)  
load balancer [1201](#)  
locker [1862](#), [1866](#)  
Locker  
    edit [1868](#)  
log in authconfig app [1848](#)  
log on [1488](#)  
logging [2143](#), [2277](#)

login [1488](#)  
login steps [1488](#)  
logs [2143](#)  
loop [3136](#)

M

maintenance  
    databases [1188](#)  
maintenance updates [1072](#)  
manage bot ideas [3615](#)  
manage-work-item [2025](#)  
manual mode [1375](#), [1384](#)  
master key [1374](#), [1375](#), [1378](#), [1384](#)  
MatchesRegex [3531](#)  
messaging [1317](#)  
Microsoft azure ai [2650](#)  
Microsoft SQL server [1235](#), [1484](#), [1484](#)  
Microsoft SQL Server [1180](#)  
Microsoft Windows Server [1180](#)  
migrate a360 [1496](#)  
migrate automation 360 [1496](#)  
migrate to a360 [1496](#)  
migration [1496](#)  
migration api filters [3963](#)  
migration system requirements [1546](#)  
migration to gcp [280](#)  
migration, migrate [2433](#)  
mining run [3837](#)  
monthly package updates [836](#)  
monthly packages [835](#)  
mouse [2798](#)  
mouse package [2798](#)  
Multi login [1746](#)  
Multi login user [1746](#)  
Multi-login [1746](#)  
multiple dll [2473](#)  
my devices [1873](#)  
my profile [1858](#)

N

.NET Framework [1180](#)  
netmask [1808](#)  
new features [705](#), [716](#), [723](#), [730](#), [736](#), [744](#), [745](#)  
non-active directory [1488](#)  
notification [2484](#), [2880](#), [2882](#), [2885](#), [2887](#)  
NTP settings [1315](#)  
numeric [3942](#), [3943](#)

O

oauth 2 [1889](#)  
oauth 2.0 [1889](#)  
oauth2 [1889](#)  
ocr [2804](#), [2806](#), [2807](#), [2807](#), [2809](#)  
ocr engine [3748](#)  
ocr list [3748](#)  
OCR list [3748](#)

odbc drivers [2482](#)  
offline [1873](#)  
on-premises keyvault integrations [1249](#)  
onprem keyvault integrations [1249](#)  
onpremises keyvault integrations [1249](#)  
Open [2412](#)  
openai [2654](#), [2654](#), [2654](#), [2654](#)  
openAI [2655](#), [2657](#)  
openAI chat action [2655](#)  
openAI prompt action [2657](#)  
OpenSearch [1259](#), [1266](#), [1308](#), [1321](#)  
operating systems [1429](#)  
    compatibility [1194](#)  
operational data [1033](#)  
organize actions [3525](#)  
Overview  
    Administration [1737](#)  
    credentials [1861](#)  
    users [1737](#)

P

package only update [835](#)  
package only updates [836](#)  
package release [835](#)  
package releases [835](#)  
package sdk [3509](#), [3549](#)  
Package SDK [975](#)  
Package SDK input types [3526](#)  
package sdk regex [3532](#)  
Package SDK Release notes [975](#)  
package sdk triggers [3549](#)  
package update [835](#)  
package updates [215](#), [835](#), [836](#)  
package versions [215](#)  
packages  
    manage [1898](#)  
packages rbac [1899](#)  
parse JSON [3584](#)  
password [1374](#), [1375](#), [1378](#), [1384](#), [1747](#)  
password limitation [1245](#)  
paused [2121](#)  
paused for input [2121](#)  
performance planning [1182](#), [1182](#)  
permissions  
    required [1315](#)  
personal data [1033](#)  
play sound [928](#)  
play sound package [928](#)  
ports required [1203](#)  
post [2967](#)  
postgresql [1245](#)  
postgresql server [1235](#), [1484](#), [1484](#)  
Power BI [3956](#)  
primary site  
    disaster recovery [1237](#), [1240](#), [1484](#), [1487](#)  
    HA [1235](#), [1484](#)  
privacy [1033](#)  
process documents [3634](#)

process trigger [2296](#)  
product licenses [1782](#)  
production [3680](#), [3687](#)  
production version [1822](#)  
profile [1858](#)  
prompt [2905](#)  
prompt ai [2652](#)  
prompt ai action [2644](#)  
prompt assignment [2331](#)  
prompt assignment variable [2331](#)  
prompt package [2905](#)  
prompt to automate [3418](#)  
properties [2484](#), [2880](#), [2882](#), [2885](#), [2887](#)  
proxy support [2916](#), [2961](#), [3084](#)  
public ip [1808](#)  
publish [3687](#)  
publish learning instance [3668](#)  
Python [3584](#)

## Q

queue [2121](#)  
queue-consumers [2002](#)  
queue-participants [2001](#)  
quick map [3111](#)

## R

Rabbit MQ startup failure [1473](#)  
RAM [1180](#)  
rbac [1036](#), [1748](#)  
rbac packages [1904](#)  
RDP [1877](#), [1879](#)  
read action [2475](#)  
Read data from CSV [3216](#)  
Read data from Excel [3204](#)  
Read data from spreadsheet [3202](#)  
Read data from spreadsheets [3204](#), [3231](#)  
read from csv [2449](#)  
read from database [2475](#)  
read from excel [2558](#), [2565](#)  
read from excel advanced [2565](#)  
read from excel basic [2558](#)  
read from text [2449](#)  
read from txt [2449](#)  
recognition [2731](#)  
record task [2279](#)  
recorder [2916](#)  
recorder for oracle [2257](#)  
recorder web [2916](#)  
recorder windows [2916](#)  
recovery [1244](#)  
    databases [1188](#), [1188](#)  
recovery site [1237](#), [1240](#), [1484](#), [1487](#)  
refresh tokens [1855](#)  
regex [3531](#)  
region settings [1315](#)  
regular expression [3531](#)  
release notes [17](#), [705](#), [716](#), [723](#), [730](#), [736](#), [744](#), [745](#)

[remote git 1824](#)  
[rename 2291](#)  
[rename task 2279](#)  
[repeat 2484, 2880, 2882, 2885, 2887, 3114](#)  
[repeat a task 3114](#)  
[repository 1860](#)  
[repository management api filters 3963](#)  
[repository requirements 1208](#)  
[requirements](#)  
     [credentials 1197](#)  
[reset 1747](#)  
[resource center 1159](#)  
[rest 2961, 2967](#)  
[Rest API GET 2965](#)  
[rest web service 2961, 2967](#)  
[Rest Web Service Put method 2970](#)  
[retirement 1086](#)  
[Return codes 3969](#)  
[return values 3522, 3562](#)  
[reverse proxy 1317](#)  
[review code 2178](#)  
[review control rooms 1849](#)  
[role 1748](#)  
[Role](#)  
     [create 1748](#)  
     [new 1748](#)  
[role based access 1036, 1748](#)  
[role based access control 1036](#)  
[roles 1748, 1767, 1787](#)  
[roll back 1822](#)  
[roll back bots 1822](#)  
[rpa workspace 1013](#)  
[RPA Workspace 1013](#)  
[run 2282](#)  
[run a bot 2129, 2282](#)  
[run action 3111](#)  
[run as user 2283](#)  
[run as users 2283](#)  
[run bot 1873, 2282](#)  
[run bot now 2282](#)  
[run bot stealth mode 990](#)  
[run task 2279, 2283](#)  
[run-as user 2283](#)  
[run-as-user 1888](#)  
[running a task 2283](#)

## S

[sagemaker 2390, 2391, 2391, 2394](#)  
[Sales force 2973, 2973, 2978, 2980, 2981, 2983, 2984, 2985, 2987, 2988](#)  
[Sales force, action, package, bot action 2973, 2978, 2980, 2981, 2983, 2984, 2985, 2987, 2988](#)  
[Salesforce, action, attachment 2987](#)  
[Salesforce, action, authentication, authorization, auth 2973](#)  
[Salesforce, action, delete, record 2983](#)  
[Salesforce, action, download file, attachment 2984, 2988](#)

[Salesforce, action, Get, Read, record 2980](#)  
[Salesforce, action, Insert, record 2978](#)  
[Salesforce, action, package, bot action 2973](#)  
[Salesforce, action, query, soql 2985](#)  
[Salesforce, action, Update, record 2981](#)  
[saml 1390](#)  
[saml 2.0 1390](#)  
[saml access 3613, 3614](#)  
[saml authentication 1390](#)  
[saml idp 1372](#)  
[SAP 2990](#)  
[SAP automation 2990](#)  
[SAP integration 2990](#)  
[save bot text 990](#)  
[save bot XML 990](#)  
[scale 1182](#)  
[scaling 1182](#)  
[scaling automation 1182](#)  
[schedule](#)  
     [activity 2138](#)  
     [change 2135](#)  
[schedule a bot 2129](#)  
[scheduled activity](#)  
     [delete 2138](#)  
     [edit 2135](#)  
[Scheduled activity 2129](#)  
[scheduled bot 2129](#)  
[scheduled bots 2129](#)  
[screen package 3011](#)  
[SDK 3509](#)  
[SDK expose property 3524](#)  
[search text 2369](#)  
[second authentication 1809](#)  
[secondary site](#)  
     [disaster recovery 1237, 1240, 1484, 1487](#)  
     [HA 1235, 1484](#)  
[security 2484, 2880, 2882, 2885, 2887](#)  
[security question 1374, 1375, 1378, 1384](#)  
[self-signed 1249](#)  
[send to task 2279](#)  
[separator string variable 2328](#)  
[separator variable 2328](#)  
[server message block \(SMB\) file share 1235, 1484, 1484](#)  
[server reqs 1187](#)  
[server requirements](#)  
     [hardware prerequisites 1187](#)  
[servers](#)  
     [databases 1188](#)  
[service 3016](#)  
[service now 2299, 2300, 3018, 3019, 3019, 3021, 3021, 3021, 3024, 3025, 3027, 3028, 3028, 3030, 3031, 3032](#)  
[service package 3016](#)  
[service status site 1066, 1076](#)  
[Service\\_Credentials 1251](#)  
[servicenow 3021](#)  
[Servicenow, action, package 3018](#)  
[ServiceNow, trigger, new record 2299](#)  
[ServiceNow, update record, trigger 2300](#)  
[set production version 1822](#)  
[set up aari team 3377, 3387](#)



Setting Sumo Logic [1839](#), [1842](#), [1845](#)  
setup [1180](#)  
setup, connect, extensions, AARI, embedded [3328](#)  
share point [3034](#)  
shared session [3556](#)  
sharepoint [3034](#)  
sharepoint package [3034](#)  
show errors [2552](#)  
show errors bot run [2552](#)  
SIEM [1839](#), [1842](#), [1845](#)  
SIEM integration [1838](#)  
silent install [1298](#)  
silent install linux [1298](#)  
silent installation [1298](#)  
single-sign on [1245](#)  
single sign-on [1375](#), [1378](#), [1384](#)  
smart card [1381](#)  
smart card administrator [1384](#)  
SMB file share [1235](#), [1484](#), [1484](#)  
SMB share  
    disaster recovery [1487](#)  
snmp [3072](#)  
snmp package [3072](#)  
soap [3084](#)  
soap web service [3084](#)  
software development kit [3509](#)  
software requirements [1429](#)  
speed [2484](#), [2880](#), [2882](#), [2885](#), [2887](#)  
Splunk [1815](#)  
sql [1192](#)  
SQL  
    database [1188](#)  
    sql authentication [1814](#)  
    sql server [1192](#)  
    SQL server [1235](#), [1484](#), [1484](#)  
    sql server configuration manager [1192](#)  
    sql settings [1814](#)  
    sso, Okta [1392](#), [1393](#), [1396](#), [1397](#), [1397](#)  
    Stability Text to Image ai [2639](#)  
    stealth mode [990](#)  
    storage  
        databases [1244](#)  
    string variable [2328](#)  
    subnet [1808](#)  
    subversion [1180](#)  
    subversion (SVN) server [1235](#), [1484](#), [1484](#)  
    suggested next actions [3418](#)  
    Sumo Logic [1838](#)  
    supported databases jdbc drivers [2482](#)  
    supported databases odbc drivers [2482](#)  
    supported jdbc drivers [2482](#)  
    supported ocr list [3748](#)  
    supported odbc drivers [2482](#)  
    SVN repository [1180](#)  
    SVN server [1235](#), [1484](#), [1484](#)  
    switch control room [1350](#)  
    synchronization  
        time [1315](#)  
    Syslog [1815](#)  
    system requirements for migration [1546](#)

system variable [2328](#)

## T

tab string variable [2328](#)  
task list [2279](#)  
TCP [1201](#)  
Teams, embedded, Co-Pilot, setup [3357](#)  
technical architecture [1027](#), [1028](#)  
terminal emulator package [3117](#)  
text search [2369](#)  
time [3942](#), [3943](#)  
time out [2324](#)  
time out mouse actions [920](#)  
time-out [2324](#)  
time-out mouse actions [920](#)  
timeout mouse actions [920](#)  
Titan chat AI  
    gen ai [2390](#), [2390](#), [2391](#), [2391](#), [2391](#), [2391](#), [2391](#), [2391](#), [2391](#), [2394](#), [2394](#), [2626](#), [2627](#), [2627](#), [2627](#), [2627](#), [2628](#), [2628](#), [2630](#), [2630](#), [2632](#), [2632](#), [2633](#), [2633](#), [2635](#), [2635](#), [2637](#), [2639](#), [2639](#), [2640](#), [2640](#), [2642](#), [2642](#), [2644](#), [2644](#), [2646](#), [2646](#), [2646](#), [2650](#), [2651](#), [2652](#), [2654](#), [2654](#), [2655](#), [2657](#), [3418](#)  
    generative ai [2390](#), [2390](#), [2391](#), [2391](#), [2391](#), [2391](#), [2391](#), [2394](#), [2394](#), [2626](#), [2627](#), [2627](#), [2627](#), [2628](#), [2628](#), [2630](#), [2630](#), [2632](#), [2632](#), [2633](#), [2633](#), [2635](#), [2635](#), [2637](#), [2639](#), [2639](#), [2640](#), [2640](#), [2642](#), [2642](#), [2644](#), [2644](#), [2646](#), [2646](#), [2646](#), [2646](#), [2650](#), [2651](#), [2652](#), [2654](#), [2654](#), [2655](#), [2657](#), [3418](#)  
TLS [1249](#)  
token [1836](#)  
transfer [3703](#)  
transfer learning instance [3703](#)  
transfer standard forms learning instance [3703](#)  
trigger event [3136](#)  
trigger loop [3136](#)  
troubleshoot key vaults [1994](#)  
two factor authentication [1809](#)  
two-factor authentication [1809](#)  
txt [2449](#)

## U

unattended automation [3291](#)  
unattended bot runner  
    license [1407](#)  
unattended bots [3291](#)  
uninstall Bot Agent, reinstall bot agent [1368](#)  
uninstalling IQ Bot [1479](#)  
uninstalling platform [1479](#)  
update a360 [1423](#)  
update a360 build [1423](#)  
update a360 version [1423](#)  
update automation 360 [1423](#)  
update to a360 [1423](#)  
update to automation 360 [1423](#)  
update window [1072](#)  
updated packages [835](#)

[upgrade a360 1496](#)  
[upgrade automation 360 1496](#)  
[upgrade automation anywhere 1496](#)  
[upgrade to a360 1496](#)  
[upgrade to automation 360 1496](#)  
[upload custom package 3519](#)  
[upload packages 1908](#)  
[upload task 2279](#)  
[user 3638](#)  
[user assistance center 1159](#)  
[user management api filters 3963](#)  
[users 1787, 3638](#)  
 Users  
     [overview 1737](#)  
[using excel action 2587](#)  
[using ocr action 2804, 2806, 2807, 2807, 2809](#)  
[using variables 2326](#)

## V

[v11 vs a360 990](#)  
[v30 top 5 features 43](#)  
[v31 top 5 features 17](#)  
[validate 3690](#)  
[validate document 3688](#)  
[validation 3688, 3690](#)  
[validation annotation 3563](#)  
[validation annotations 3567](#)  
[validator 3688, 3690](#)  
[variable 1678](#)  
[variables 2326](#)  
[verify key vault 1994](#)  
[version 2279](#)  
     [release notes 17](#)  
[version control 1822](#)  
 versions  
     [browsers supported 1210](#)  
[vertex 2644](#)  
[vertex ai 2640](#)  
[vertex ai action 2640](#)  
[vertex chat AI](#)  
     [gen ai 2390, 2390, 2391, 2391, 2391, 2391, 2391, 2394, 2394, 2626, 2627, 2627, 2627, 2628, 2628, 2630, 2630, 2632, 2632, 2633, 2633, 2635, 2635, 2637, 2637, 2639, 2640, 2640, 2642, 2642, 2644, 2644, 2646, 2646, 2646, 2650, 2651, 2652, 2654, 2654, 2655, 2657, 3418](#)  
     [generative ai 2390, 2390, 2391, 2391, 2391, 2391, 2391, 2394, 2394, 2626, 2627, 2627, 2627, 2628, 2628, 2630, 2630, 2632, 2632, 2633, 2633, 2635, 2635, 2637, 2637, 2639, 2639, 2640, 2640, 2642, 2642, 2644, 2644, 2646, 2646, 2646, 2650, 2651, 2652, 2654, 2654, 2655, 2657, 3418](#)  
[vertex prompt ai](#)  
     [gen ai 2390, 2390, 2391, 2391, 2391, 2391, 2394, 2394, 2626, 2627, 2627, 2627, 2628, 2628, 2630, 2630, 2632, 2632, 2633, 2633, 2635, 2635, 2637, 2637, 2639, 2639, 2640, 2640, 2642, 2642, 2644, 2644,](#)

[2646, 2646, 2646, 2650, 2651, 2652, 2654, 2654, 2655, 2657, 3418](#)  
[generative ai 2390, 2390, 2391, 2391, 2391, 2391, 2394, 2394, 2626, 2627, 2627, 2627, 2628, 2628, 2630, 2630, 2632, 2632, 2633, 2633, 2635, 2635, 2637, 2639, 2639, 2640, 2640, 2642, 2642, 2644, 2644, 2646, 2646, 2646, 2650, 2651, 2652, 2654, 2654, 2655, 2657, 3418](#)  
[view device pool](#)  
     [details 1884](#)  
[view licenses 1782](#)  
[view log 2484, 2782, 2880, 2882, 2885, 2887](#)  
[view scheduled bot 2129](#)  
[view-work-item 2025](#)  
[view-work-item-result 2026](#)  
[view-work-items 2026](#)  
[virtualized applications 1227](#)  
[visual basic 3250](#)  
[visualize view 990](#)

## W

[wait package 3155](#)  
[web service 2961, 2967](#)  
[white list 1170, 1322](#)  
[white\\_list 1170, 1322](#)  
[white-list 1170, 1322](#)  
[whitelist 1170, 1322, 1808](#)  
[whitelist ip address 1170, 1322](#)  
[whitelisted 1170, 1322](#)  
[whitelisted ip address key vault 1829](#)  
[whitelisting 1170, 1322](#)  
[window package 3174](#)  
[windows services 1317](#)  
[windows authentication 1192](#)  
[Windows clipboard 2447](#)  
[windows package 3174](#)  
[Windows services](#)  
     [required 1315](#)  
[Windows\\_Services 1251](#)  
[wizard 1374, 1375, 1378, 1384](#)  
[wlm 1996](#)  
[work load package 3184](#)  
[work-item-structure 2002](#)  
[workday Get integration Event EIB 3168](#)  
[workday get report 3171](#)  
[workday Launch EIB 3165](#)  
[Workday, action, authentication, package 3163](#)  
[Workday, action, package 3162, 3165, 3168, 3171](#)  
[workload management 1996](#)  
[workload package 3184](#)  
[workload-maintenance 2010](#)  
[workload-queues 1997](#)  
[Write data to a database 3231](#)  
[Write to Excel spreadsheet 3202, 3216](#)

## X

[xml package 3186](#)

xpath [3193](#)